

# LG

**MULTI V 5**

Heat Recovery & Heat Pump  
R410A(50Hz/60Hz)  
0CVV0-01Q(Replaces 0CVV0-01P)

# TOTAL HVAC SOLUTION PROVIDER

ENGINEERING PRODUCT DATA BOOK



LG participates in the ECP programme for EUROVENT VRF program.  
Check ongoing validity of certification : [www.eurovent-certification.com](http://www.eurovent-certification.com)

# ***MULTI V***<sup>TM</sup> **5**

**General Information**

**Outdoor Units**

**HR Unit**

**Installation of Outdoor Units**

**Special Guide**









**Control System**

# ***MULTI V***™ **5**

## **General Information**

- 1. Model Line-up & External Appearance**
- 2. Combination of Outdoor Units**
- 3. Nomenclature**
- 4. Indoor Unit and Outdoor Unit Capacity Index**

# 1. Model Line-up & External Appearance

CHASSIS	Model Name	Model
UXA	ARUM080LTE5 ARUM100LTE5 ARUM120LTE5	
UXB	ARUM140LTE5 ARUM160LTE5 ARUM180LTE5 ARUM200LTE5 ARUM220LTE5 ARUM240LTE5 ARUM260LTE5	
UXA UXA	ARUM221LTE5 ARUM241LTE5	
UXB UXA	ARUM261LTE5 ARUM280LTE5 ARUM300LTE5 ARUM320LTE5 ARUM340LTE5 ARUM360LTE5	
UXB UXB	ARUM380LTE5 ARUM400LTE5 ARUM420LTE5 ARUM440LTE5 ARUM460LTE5 ARUM480LTE5	
UXB UXB UXA	ARUM500LTE5 ARUM520LTE5 ARUM540LTE5 ARUM560LTE5 ARUM580LTE5 ARUM600LTE5	
UXB UXB UXB	ARUM620LTE5 ARUM640LTE5 ARUM660LTE5 ARUM680LTE5 ARUM700LTE5 ARUM720LTE5	
UXB UXB UXB UXA	ARUM740LTE5 ARUM760LTE5 ARUM780LTE5 ARUM800LTE5 ARUM820LTE5 ARUM840LTE5	
UXB UXB UXB UXB	ARUM860LTE5 ARUM880LTE5 ARUM900LTE5 ARUM920LTE5 ARUM940LTE5 ARUM960LTE5	

## 2. Combination of Outdoor Units

Model Name	Number of Units	Module(HP)									
		8	10	12	14	16	18	20	22	24	26
ARUM080LTE5	1	1									
ARUM100LTE5	1		1								
ARUM120LTE5	1			1							
ARUM140LTE5	1				1						
ARUM160LTE5	1					1					
ARUM180LTE5	1						1				
ARUM200LTE5	1							1			
ARUM220LTE5	1								1		
ARUM240LTE5	1									1	
ARUM260LTE5	1										1
ARUM221LTE5	2		1	1							
ARUM241LTE5	2			2							
ARUM261LTE5	2			1	1						
ARUM280LTE5	2			1		1					
ARUM300LTE5	2			1			1				
ARUM320LTE5	2			1				1			
ARUM340LTE5	2			1					1		
ARUM360LTE5	2			1						1	
ARUM380LTE5	2				1					1	
ARUM400LTE5	2					1				1	
ARUM420LTE5	2						1			1	
ARUM440LTE5	2							1		1	
ARUM460LTE5	2								1	1	
ARUM480LTE5	2									2	
ARUM500LTE5	3			1	1					1	
ARUM520LTE5	3			1		1				1	
ARUM540LTE5	3			1			1			1	
ARUM560LTE5	3			1				1		1	
ARUM580LTE5	3			1					1	1	
ARUM600LTE5	3			1						2	
ARUM620LTE5	3				1					2	
ARUM640LTE5	3					1				2	
ARUM660LTE5	3						1			2	
ARUM680LTE5	3							1		2	
ARUM700LTE5	3								1	2	
ARUM720LTE5	3									3	
ARUM740LTE5	4			1	1					2	
ARUM760LTE5	4			1		1				2	
ARUM780LTE5	4			1			1			2	
ARUM800LTE5	4			1				1		2	
ARUM820LTE5	4			1					1	2	
ARUM840LTE5	4			1						3	
ARUM860LTE5	4				1					3	
ARUM880LTE5	4					1				3	
ARUM900LTE5	4						1			3	
ARUM920LTE5	4							1		3	
ARUM940LTE5	4								1	3	
ARUM960LTE5	4									4	

### 3. Nomenclature

<b>Model Name</b>	<b>ARU</b>	<b>M</b>	<b>100</b>	<b>L</b>	<b>T</b>	<b>E</b>	<b>5</b>
No.	1	2	3	4	5	6	7

No.	Signification
1	<b>Multi V System with Indoor Unit using R410A</b> ARU : Global line-up
2	<b>Combination of Inverter Type and Cooling Only, Heat Pump or Heat Recovery</b> M : Inverter, Heat Pump and Heat Recovery
3	<b>Total Cooling capacity in Horse Power(HP) unit</b> EX) 8HP → '080' 10HP → '100'
4	<b>Electrical Ratings</b> L : 3Ø, 380-415 V, 50 Hz / 3Ø, 380V, 60 Hz
5	<b>Air Discharge Type</b> T : Top Discharge
6	<b>E: High Efficiency</b>
7	<b>Serial Number</b>

## 4. Indoor Unit and Outdoor Unit Capacity Index

### 4.1 Indoor Unit Selection

See the indoor unit capacity tables for given Indoor and Outdoor temperature

Select the unit whose capacity is the nearest to or greater than given load.

#### Note

Individual Indoor Unit capacity is subject to change by combination. Actual capacity has to be calculated according to the combination by using Outdoor unit capacity table.

### 4.2 Outdoor Unit Selection

Allowable combinations are indicated below. In general, outdoor unit can be selected depending on the location of the unit, zoning and usage of the rooms.

The indoor and outdoor unit combination is determined by comparing the sum of indoor unit capacity index with each Outdoor Unit. It is recommended to be the nearest to 100% combination ratio or to be smaller than that. Refer the table below. To manage cooling/heating load properly, it's better to be selected the bigger capacity outdoor unit rather than the nearest, if the installation space is large enough.

#### ■ Allowable Total Capacity Index Table of Combined Indoor Units

Outdoor Unit Capacity(HP)	Indoor Unit Combination Ratio										
	50%	60%	70%	80%	90%	100%	110%	120%	130%	160%	200%
8	11.2	13.4	15.7	17.9	20.2	22.4	24.6	26.9	29.1	35.8	44.8
10	14.0	16.8	19.6	22.4	25.2	28.0	30.8	33.6	36.4	44.8	56.0
12	16.8	20.2	23.5	26.9	30.2	33.6	37.0	40.3	43.7	53.8	67.2
14	19.6	23.5	27.4	31.4	35.3	39.2	43.1	47.0	51.0	62.7	78.4
16	22.4	26.9	31.4	35.8	40.3	44.8	49.3	53.8	58.2	71.7	89.6
18	25.2	30.2	35.3	40.3	45.4	50.4	55.4	60.5	65.5	80.6	100.8
20	28.0	33.6	39.2	44.8	50.4	56.0	61.6	67.2	72.8	89.6	112.0
22	30.8	37.0	43.1	49.3	55.4	61.6	67.8	73.9	80.1	98.6	123.2
24	33.6	40.3	47.0	53.8	60.5	67.2	73.9	80.6	87.4	107.5	134.4
26	36.4	43.7	51.0	58.2	65.5	72.8	80.1	87.4	94.6	116.5	145.6
28	39.2	47.0	54.9	62.7	70.6	78.4	86.2	94.1	101.9	125.4	-
30	42.0	50.4	58.8	67.2	75.6	84.0	92.4	100.8	109.2	134.4	-
32	44.8	53.8	62.7	71.7	80.6	89.6	98.6	107.5	116.5	143.4	-
34	47.6	57.1	66.6	76.2	85.7	95.2	104.7	114.2	123.8	152.3	-
36	50.4	60.5	70.6	80.6	90.7	100.8	110.9	121.0	131.0	161.3	-
38	53.2	63.8	74.5	85.1	95.8	106.4	117.0	127.7	138.3	170.2	-
40	56.0	67.2	78.4	89.6	100.8	112.0	123.2	134.4	145.6	179.2	-
42	58.8	70.6	82.3	94.1	105.8	117.6	129.4	141.1	152.9	188.2	-
44	61.6	73.9	86.2	98.6	110.9	123.2	135.5	147.8	160.2	197.1	-
46	64.4	77.3	90.2	103.0	115.9	128.8	141.7	154.6	167.4	206.1	-
48	67.2	80.6	94.1	107.5	121.0	134.4	147.8	161.3	174.7	215.0	-
50	70.0	84.0	98.0	112.0	126.0	140.0	154.0	168.0	182.0	-	-
52	72.8	87.4	101.9	116.5	131.0	145.6	160.2	174.7	189.3	-	-
54	75.6	90.7	105.8	121.0	136.1	151.2	166.3	181.4	196.6	-	-
56	78.4	94.1	109.8	125.4	141.1	156.8	172.5	188.2	203.8	-	-
58	81.2	97.4	113.7	129.9	146.2	162.4	178.6	194.9	211.1	-	-
60	84.0	100.8	117.6	134.4	151.2	168.0	184.8	201.6	218.4	-	-
62	86.8	104.2	121.5	138.9	156.2	173.6	191.0	208.3	225.7	-	-
64	89.6	107.5	125.4	143.4	161.3	179.2	197.1	215.0	233.0	-	-
66	92.4	110.9	129.4	147.8	166.3	184.8	203.3	221.8	240.2	-	-
68	95.2	114.2	133.3	152.3	171.4	190.4	209.4	228.5	247.5	-	-

## 4. Indoor Unit and Outdoor Unit Capacity Index

Outdoor Unit Capacity(HP)	Indoor Unit Combination Ratio										
	50%	60%	70%	80%	90%	100%	110%	120%	130%	160%	200%
70	98.0	117.6	137.2	156.8	176.4	196.0	215.6	235.2	254.8	-	-
72	100.8	121.0	141.1	161.3	181.4	201.6	221.8	241.9	262.1	-	-
74	103.6	124.3	145.0	165.8	186.5	207.2	227.9	248.6	269.4	-	-
76	106.4	127.7	149.0	170.2	191.5	212.8	234.1	255.4	276.6	-	-
78	109.2	131.0	152.9	174.7	196.6	218.4	240.2	262.1	283.9	-	-
80	112.0	134.4	156.8	179.2	201.6	224.0	246.4	268.8	291.2	-	-
82	114.8	137.8	160.7	183.7	206.6	229.6	252.6	275.5	298.5	-	-
84	117.6	141.1	164.6	188.2	211.7	235.2	258.7	282.2	305.8	-	-
86	120.4	144.5	168.6	192.6	216.7	240.8	264.9	289.0	313.0	-	-
88	123.2	147.8	172.5	197.1	221.8	246.4	271.0	295.7	320.3	-	-
90	126.0	151.2	176.4	201.6	226.8	252.0	277.2	302.4	327.6	-	-
92	128.8	154.6	180.3	206.1	231.8	257.6	283.4	309.1	334.9	-	-
94	131.6	157.9	184.2	210.6	236.9	263.2	289.5	315.8	342.2	-	-
96	134.4	161.3	188.2	215.0	241.9	268.8	295.7	322.6	349.4	-	-

\* Capacity Index is same as the capacity(kW).

### ■ INDOOR UNIT CAPACITY INDEX

Unit Capacity (Btu/h)	5k	7k	9k	12k	15k	18k	21k	24k	28k	30k	36k	42k	48k	54k	60k	76k	96k
Capacity Index	1.6	2.2	2.8	3.6	4.5	5.6	6.2	7.1	8.2	9.0	10.6	12.3	14.1	15.8	17.5	22.4	28.0

\* Capacity Index is same as the capacity(kW).

### ⚠ CAUTION

#### ◆ Combination Ratio(50~200%)

Number of Outdoor units	Combination Ratio
Single Unit	200%
Two Units combination	160%
Three or more Units combination	130%

#### Notes:

- We can guarantee the operation only within 130% Combination Ratio.**  
If you want to connect more than 130% combination Ratio, please contact us and discuss the requirement.
- In case that operating indoor units ratio to rated capacity of outdoor unit is more than 130%, the airflow should be operated as low step in the all indoor units.**



# **MULTI V™ 5**

## **Outdoor Units**

- 1. Specifications**
- 2. Dimensions**
- 3. Piping Diagrams**
- 4. Wiring Diagrams**
- 5. Field Wiring**
- 6. Electric Characteristics**
- 7. Capacity Tables**
- 8. Capacity Correction Factor**
- 9. Operation Limits**
- 10. Sound Levels**
- 11. Accessories**

# 1. Specifications

HP			8	10
Model Name	Combination Unit		ARUM080LTE5	ARUM100LTE5
	Independent Unit		ARUM080LTE5	ARUM100LTE5
Capacity	Cooling (Rated)	kW	22.4	28.0
		Btu/h	76,400	95,500
	Heating (Rated.)	kW	22.4	28.0
		Btu/h	76,400	95,500
	Heating (Max.)	kW	25.2	31.5
		Btu/h	86,000	107,500
Input	Cooling (Rated)	kW	5.28	6.83
	Heating (Rated)	kW	3.97	4.92
	Heating (Max.)	kW	4.78	5.92
EER (Rated)			4.24	4.10
COP	Rated capacity		5.64	5.69
	Max. capacity		5.27	5.32
SEER			9.93	9.49
SCOP			4.69	4.51
Exterior	Color		Warm Gray / Dawn Gray	Warm Gray / Dawn Gray
	RAL (Classic)		RAL 7044 / RAL 7037	RAL 7044 / RAL 7037
Heat Exchanger			Wide Louver Plus	Wide Louver Plus
Compressor	Type		Hermetically Sealed Scroll	Hermetically Sealed Scroll
	Piston Displacement	cm <sup>3</sup> /rev	43.8	62.1
	Number of Revolution	rev/min	3,600	3,600
	Motor Output x Number	W x No.	4,200 × 1	5,300 × 1
	Starting Method		Direct On Line	Direct On Line
	Oil Type		FVC68D(PVE)	FVC68D(PVE)
Fan	Type		Propeller fan	Propeller fan
	Motor Output x Number	W	1,200 × 1	1,200 × 1
	Air Flow Rate(High)	m <sup>3</sup> /min	240 × 1	240 × 1
		ft <sup>3</sup> /min	8,476 × 1	8,476 × 1
	External Static Pressure (Max, Pa)		DC INVERTER	DC INVERTER
	Drive		80	80
	Discharge	Side / Top	TOP	TOP
Pipe Connections #1	Liquid	mm(inch)	9.52(3/8)	9.52(3/8)
	Low Pressure Gas	mm(inch)	19.05(3/4)	22.2(7/8)
	High Pressure Gas	mm(inch)	15.88(5/8)	19.05(3/4)
Pipe Connections #2	Liquid	mm(inch)	9.52(3/8)	9.52(3/8)
	Gas	mm(inch)	19.05(3/4)	22.2(7/8)
Dimensions(W x H x D)		mm	(930 × 1,690 × 760) × 1	(930 × 1,690 × 760) × 1
		inch	(36-5/8 × 66-17/32 × 29-29/32) × 1	(36-5/8 × 66-17/32 × 29-29/32) × 1

## Note

- Due to our policy of innovation some specifications may be changed without notification.
- Wiring cable size must comply with the applicable local and national codes. And "Electric characteristics" chapter should be considered for electrical work and design. Especially the power cable and circuit breaker should be selected in accordance with that.
- Sound pressure level is measured on the rated condition in the anechoic rooms by ISO 3745 standard.  
Sound power level is measured on the rated condition in the reverberation rooms by ISO 3741 standard.  
Therefore, these values can be increased owing to ambient conditions during operation.
- Sound values of combination model are calculated values based on sound results of independent models.  
Sound values can be increased owing to ambient or installation conditions during operation.  
Sound values of system [dB(A)] = 10\*log [10<sup>A1</sup>(A1/10)+ ... +10<sup>An</sup>(An/10)] , A1~An means sound values of independent models.
- Performances are based on the following conditions :
  - \*Cooling : Indoor Ambient Temp. 27°CDB / 19°CWB, Outdoor Ambient Temp. 35°CDB / 24°CWB
  - \*Heating : Indoor Ambient Temp. 20°CDB / 15°CWB, Outdoor Ambient Temp. 7°CDB / 6°CWB
  - Interconnected Pipe Length is 7.5m and difference of Elevation (Outdoor ~ Indoor Unit) is 0m.
- EUROVENT Test Condition :
  - Performance values in this PDB are based on Ceiling concealed duct combination.
  - Refer to EUROVENT web site([www.eurovent-certification.com](http://www.eurovent-certification.com)) for other indoor unit combination and more detail test conditions.
- \*\*\* : The number in parentheses means maximum connectable indoor units in accordance with outdoor units combination (160~200%).  
The recommended ratio is 130%.
- This product contains Fluorinated greenhouse gases.(R410A, GWP(Global warming potential) = 2,087.5)
- #1 : Heat Recovery system, #2 : Heat Pump system

# 1. Specifications

HP			8	10
Model Name	Combination Unit		ARUM080LTE5	ARUM100LTE5
	Independent Unit		ARUM080LTE5	ARUM100LTE5
Net Weight		kg	198 × 1	215 × 1
		lbs	437 × 1	474 × 1
Sound Pressure Level	Cooling	dB(A)	58.0	58.0
	Heating	dB(A)	59.0	59.0
Sound Power Level	Cooling	dB(A)	79.0	79.0
	Heating	dB(A)	79.0	79.0
Protection Devices	High pressure protection		High pressure sensor / High pressure switch	
	Compressor/Fan		Over-heat protection / Fan driver overload protector	
	Inverter		Over-heat protection / Over-current protection	
Communication Cable (VCTF-SB)	No. × mm <sup>2</sup>		2C × 1.0 ~ 1.5	2C × 1.0 ~ 1.5
Refrigerant	Refrigerant name		R410A	R410A
	Precharged Amount	kg	7.5	9.5
		lbs	16.5	20.9
	t-CO <sub>2</sub> eq		15.656	19.831
Control		Electronic Expansion Valve	Electronic Expansion Valve	
Power Supply		V, Ø, Hz	380-400-415, 3, 50/60	380-400-415, 3, 50/60
Running Current	Cooling (Rated)	A	8.59 - 8.17 - 7.86	11.19 - 10.63 - 10.24
	Heating (Max)	A	8.00 - 7.60 - 7.33	9.70 - 9.22 - 8.88
Number of maximum connectable indoor units ***			13(20)	16(25)

## Note

- Due to our policy of innovation some specifications may be changed without notification.
- Wiring cable size must comply with the applicable local and national codes. And "Electric characteristics" chapter should be considered for electrical work and design. Especially the power cable and circuit breaker should be selected in accordance with that.
- Sound pressure level is measured on the rated condition in the anechoic rooms by ISO 3745 standard.  
Sound power level is measured on the rated condition in the reverberation rooms by ISO 3741 standard.  
Therefore, these values can be increased owing to ambient conditions during operation.
- Sound values of combination model are calculated values based on sound results of independent models.  
Sound values can be increased owing to ambient or installation conditions during operation.  
Sound values of system [dB(A)] =  $10 \cdot \log [10^{(A1/10)} + \dots + 10^{(An/10)}]$ , A1~An means sound values of independent models.
- Performances are based on the following conditions :
  - \*Cooling : Indoor Ambient Temp. 27°CDB / 19°CWB, Outdoor Ambient Temp. 35°CDB / 24°CWB
  - \*Heating : Indoor Ambient Temp. 20°CDB / 15°CWB, Outdoor Ambient Temp. 7°CDB / 6°CWB
  - Interconnected Pipe Length is 7.5m and difference of Elevation (Outdoor ~ Indoor Unit) is 0m.
- EUROVENT Test Condition :
  - Performance values in this PDB are based on Ceiling concealed duct combination.
  - Refer to EUROVENT web site([www.eurovent-certification.com](http://www.eurovent-certification.com)) for other indoor unit combination and more detail test conditions.
- \*\*\* : The number in parentheses means maximum connectable indoor units in accordance with outdoor units combination (160~200%).  
The recommended ratio is 130%.
- This product contains Fluorinated greenhouse gases.(R410A, GWP(Global warming potential) = 2,087.5)
- #1 : Heat Recovery system, #2 : Heat Pump system

# 1. Specifications

HP			12	14
Model Name	Combination Unit		ARUM120LTE5	ARUM140LTE5
	Independent Unit		ARUM120LTE5	ARUM140LTE5
Capacity	Cooling (Rated)	kW	33.6	39.2
		Btu/h	114,600	133,800
	Heating (Rated.)	kW	33.6	39.2
		Btu/h	114,600	133,800
	Heating (Max.)	kW	37.8	44.1
		Btu/h	129,000	150,500
Input	Cooling (Rated)	kW	7.71	8.67
	Heating (Rated)	kW	6.85	8.48
	Heating (Max.)	kW	8.26	9.72
EER (Rated)			4.36	4.52
COP	Rated capacity		4.91	4.62
	Max. capacity		4.58	4.54
SEER			9.57	8.89
SCOP			5.01	4.63
Exterior	Color		Warm Gray / Dawn Gray	Warm Gray / Dawn Gray
	RAL (Classic)		RAL 7044 / RAL 7037	RAL 7044 / RAL 7037
Heat Exchanger			Wide Louver Plus	Wide Louver Plus
Compressor	Type		Hermetically Sealed Scroll	Hermetically Sealed Scroll
	Piston Displacement	cm <sup>3</sup> /rev	62.1	62.1
	Number of Revolution	rev/min	3,600	3,600
	Motor Output x Number	W x No.	5,300 × 1	5,300 × 1
	Starting Method		Direct On Line	Direct On Line
	Oil Type		FVC68D(PVE)	FVC68D(PVE)
Fan	Type		Propeller fan	Propeller fan
	Motor Output x Number	W	1,200 × 1	900 × 2
	Air Flow Rate(High)	m <sup>3</sup> /min	240 × 1	320 × 1
		ft <sup>3</sup> /min	8,476 × 1	1,1301 × 1
	External Static Pressure (Max, Pa)		DC INVERTER	DC INVERTER
	Drive		80	80
	Discharge	Side / Top	TOP	TOP
Pipe Connections #1	Liquid	mm(inch)	12.7(1/2)	12.7(1/2)
	Low Pressure Gas	mm(inch)	28.58(1-1/8)	28.58(1-1/8)
	High Pressure Gas	mm(inch)	19.05(3/4)	22.2(7/8)
Pipe Connections #2	Liquid	mm(inch)	12.7(1/2)	12.7(1/2)
	Gas	mm(inch)	28.58(1-1/8)	28.58(1-1/8)
Dimensions(W x H x D)		mm	(930 × 1,690 × 760) × 1	(1,240 × 1,690 × 760)×1
		inch	(36-5/8 × 66-17/32 × 29-29/32) × 1	(48-13/16 × 66-17/32 × 29-29/32) × 1

## Note

- Due to our policy of innovation some specifications may be changed without notification.
- Wiring cable size must comply with the applicable local and national codes. And "Electric characteristics" chapter should be considered for electrical work and design. Especially the power cable and circuit breaker should be selected in accordance with that.
- Sound pressure level is measured on the rated condition in the anechoic rooms by ISO 3745 standard.  
Sound power level is measured on the rated condition in the reverberation rooms by ISO 3741 standard.  
Therefore, these values can be increased owing to ambient conditions during operation.
- Sound values of combination model are calculated values based on sound results of independent models.  
Sound values can be increased owing to ambient or installation conditions during operation.  
Sound values of system [dB(A)] =  $10 \cdot \log [10^{A1/10} + \dots + 10^{An/10}]$ , A1~An means sound values of independent models.
- Performances are based on the following conditions :
  - \*Cooling : Indoor Ambient Temp. 27°CDB / 19°CWB, Outdoor Ambient Temp. 35°CDB / 24°CWB
  - \*Heating : Indoor Ambient Temp. 20°CDB / 15°CWB, Outdoor Ambient Temp. 7°CDB / 6°CWB
  - Interconnected Pipe Length is 7.5m and difference of Elevation (Outdoor ~ Indoor Unit) is 0m.
- EUROVENT Test Condition :
  - Performance values in this PDB are based on Ceiling concealed duct combination.
  - Refer to EUROVENT web site([www.eurovent-certification.com](http://www.eurovent-certification.com)) for other indoor unit combination and more detail test conditions.
- \*\*\* : The number in parentheses means maximum connectable indoor units in accordance with outdoor units combination (160~200%).  
The recommended ratio is 130%.
- This product contains Fluorinated greenhouse gases.(R410A, GWP(Global warming potential) = 2,087.5)
- #1 : Heat Recovery system, #2 : Heat Pump system

# 1. Specifications

HP			12	14
Model Name	Combination Unit		ARUM120LTE5	ARUM140LTE5
	Independent Unit		ARUM120LTE5	ARUM140LTE5
Net Weight		kg	215 × 1	237 × 1
		lbs	474 × 1	522 × 1
Sound Pressure Level	Cooling	dB(A)	59.0	60.0
	Heating	dB(A)	60.0	61.0
Sound Power Level	Cooling	dB(A)	81.0	81.0
	Heating	dB(A)	81.0	82.0
Protection Devices	High pressure protection		High pressure sensor / High pressure switch	
	Compressor/Fan		Over-heat protection / Fan driver overload protector	
	Inverter		Over-heat protection / Over-current protection	
Communication Cable (VCTF-SB)	No. × mm <sup>2</sup>		2C × 1.0 ~ 1.5	2C × 1.0 ~ 1.5
Refrigerant	Refrigerant name		R410A	R410A
	Precharged Amount	kg	9.5	13.5
		lbs	20.9	29.8
	t-CO <sub>2</sub> eq		19.831	28.181
Control		Electronic Expansion Valve	Electronic Expansion Valve	
Power Supply		V, Ø, Hz	380-400-415, 3, 50/60	380-400-415, 3, 50/60
Running Current	Cooling (Rated)	A	12.61 - 11.98 - 11.54	14.19 - 13.48 - 12.99
	Heating (Max)	A	14.40 - 13.68 - 13.19	15.90 - 15.11 - 14.56
Number of maximum connectable indoor units ***			20(30)	23(35)

### Note

- Due to our policy of innovation some specifications may be changed without notification.
- Wiring cable size must comply with the applicable local and national codes. And "Electric characteristics" chapter should be considered for electrical work and design. Especially the power cable and circuit breaker should be selected in accordance with that.
- Sound pressure level is measured on the rated condition in the anechoic rooms by ISO 3745 standard.  
Sound power level is measured on the rated condition in the reverberation rooms by ISO 3741 standard.  
Therefore, these values can be increased owing to ambient conditions during operation.
- Sound values of combination model are calculated values based on sound results of independent models.  
Sound values can be increased owing to ambient or installation conditions during operation.  
Sound values of system [dB(A)] =  $10 \cdot \log [10^{(A1/10)} + \dots + 10^{(An/10)}]$ , A1~An means sound values of independent models.
- Performances are based on the following conditions :
  - \*Cooling : Indoor Ambient Temp. 27°CDB / 19°CWB, Outdoor Ambient Temp. 35°CDB / 24°CWB
  - \*Heating : Indoor Ambient Temp. 20°CDB / 15°CWB, Outdoor Ambient Temp. 7°CDB / 6°CWB
  - Interconnected Pipe Length is 7.5m and difference of Elevation (Outdoor ~ Indoor Unit) is 0m.
- EUROVENT Test Condition :
  - Performance values in this PDB are based on Ceiling concealed duct combination.
  - Refer to EUROVENT web site([www.eurovent-certification.com](http://www.eurovent-certification.com)) for other indoor unit combination and more detail test conditions.
- \*\*\* : The number in parentheses means maximum connectable indoor units in accordance with outdoor units combination (160~200%).  
The recommended ratio is 130%.
- This product contains Fluorinated greenhouse gases.(R410A, GWP(Global warming potential) = 2,087.5)
- #1 : Heat Recovery system, #2 : Heat Pump system

# 1. Specifications

HP			16	18
Model Name	Combination Unit		ARUM160LTE5	ARUM180LTE5
	Independent Unit		ARUM160LTE5	ARUM180LTE5
Capacity	Cooling (Rated)	kW	44.8	50.4
		Btu/h	152,900	172,000
	Heating (Rated.)	kW	44.8	50.4
		Btu/h	152,900	172,000
	Heating (Max.)	kW	50.4	56.7
		Btu/h	172,000	193,500
Input	Cooling (Rated)	kW	10.90	11.03
	Heating (Rated)	kW	10.28	10.12
	Heating (Max.)	kW	12.39	11.94
EER (Rated)			4.11	4.57
COP	Rated capacity		4.36	4.98
	Max. capacity		4.07	4.75
SEER			8.38	8.21
SCOP			4.83	4.00
Exterior	Color		Warm Gray / Dawn Gray	Warm Gray / Dawn Gray
	RAL (Classic)		RAL 7044 / RAL 7037	RAL 7044 / RAL 7037
Heat Exchanger			Wide Louver Plus	Wide Louver Plus
Compressor	Type		Hermetically Sealed Scroll	Hermetically Sealed Scroll
	Piston Displacement	cm <sup>3</sup> /rev	62.1	62.1 × 1 + 43.8 × 1
	Number of Revolution	rev/min	3,600	3,600 × 2
	Motor Output x Number	W x No.	5,300 × 1	5,300 × 1 + 4,200 × 1
	Starting Method		Direct On Line	Direct On Line
	Oil Type		FVC68D(PVE)	FVC68D(PVE)
Fan	Type		Propeller fan	Propeller fan
	Motor Output x Number	W	900 × 2	900 × 2
	Air Flow Rate(High)	m <sup>3</sup> /min	320 × 1	320 × 1
		ft <sup>3</sup> /min	1,1301 × 1	1,1301 × 1
	External Static Pressure (Max, Pa)		DC INVERTER	DC INVERTER
	Drive		80	80
Discharge	Side / Top	TOP	TOP	
Pipe Connections #1	Liquid	mm(inch)	12.7(1/2)	15.88(5/8)
	Low Pressure Gas	mm(inch)	28.58(1-1/8)	28.58(1-1/8)
	High Pressure Gas	mm(inch)	22.2(7/8)	22.2(7/8)
Pipe Connections #2	Liquid	mm(inch)	12.7(1/2)	15.88(5/8)
	Gas	mm(inch)	28.58(1-1/8)	28.58(1-1/8)
Dimensions(W x H x D)		mm	(1,240 × 1,690 × 760)×1	(1,240 × 1,690 × 760)×1
		inch	(48-13/16 × 66-17/32 × 29-29/32) × 1	(48-13/16 × 66-17/32 × 29-29/32) × 1

## Note

- Due to our policy of innovation some specifications may be changed without notification.
- Wiring cable size must comply with the applicable local and national codes. And "Electric characteristics" chapter should be considered for electrical work and design. Especially the power cable and circuit breaker should be selected in accordance with that.
- Sound pressure level is measured on the rated condition in the anechoic rooms by ISO 3745 standard.  
Sound power level is measured on the rated condition in the reverberation rooms by ISO 3741 standard.  
Therefore, these values can be increased owing to ambient conditions during operation.
- Sound values of combination model are calculated values based on sound results of independent models.  
Sound values can be increased owing to ambient or installation conditions during operation.  
Sound values of system [dB(A)] = 10\*log [10<sup>A1</sup>(A1/10)+ ... +10<sup>An</sup>(An/10)] , A1~An means sound values of independent models.
- Performances are based on the following conditions :
  - \*Cooling : Indoor Ambient Temp. 27°CDB / 19°CWB, Outdoor Ambient Temp. 35°CDB / 24°CWB
  - \*Heating : Indoor Ambient Temp. 20°CDB / 15°CWB, Outdoor Ambient Temp. 7°CDB / 6°CWB
  - Interconnected Pipe Length is 7.5m and difference of Elevation (Outdoor ~ Indoor Unit) is 0m.
- EUROVENT Test Condition :
  - Performance values in this PDB are based on Ceiling concealed duct combination.
  - Refer to EUROVENT web site([www.eurovent-certification.com](http://www.eurovent-certification.com)) for other indoor unit combination and more detail test conditions.
- \*\*\* : The number in parentheses means maximum connectable indoor units in accordance with outdoor units combination (160~200%).  
The recommended ratio is 130%.
- This product contains Fluorinated greenhouse gases.(R410A, GWP(Global warming potential) = 2,087.5)
- #1 : Heat Recovery system, #2 : Heat Pump system

# 1. Specifications

HP			16	18
Model Name	Combination Unit		ARUM160LTE5	ARUM180LTE5
	Independent Unit		ARUM160LTE5	ARUM180LTE5
Net Weight		kg	237 × 1	300 × 1
		lbs	522 × 1	661 × 1
Sound Pressure Level	Cooling	dB(A)	60.5	61.0
	Heating	dB(A)	61.5	62.0
Sound Power Level	Cooling	dB(A)	85.0	87.0
	Heating	dB(A)	86.0	87.0
Protection Devices	High pressure protection		High pressure sensor / High pressure switch	
	Compressor/Fan		Over-heat protection / Fan driver overload protector	
	Inverter		Over-heat protection / Over-current protection	
Communication Cable (VCTF-SB)	No. × mm <sup>2</sup>		2C × 1.0 ~ 1.5	2C × 1.0 ~ 1.5
Refrigerant	Refrigerant name		R410A	R410A
	Precharged Amount	kg	13.5	16.0
		lbs	29.8	35.3
	t-CO <sub>2</sub> eq		28.181	33.400
Control		Electronic Expansion Valve	Electronic Expansion Valve	
Power Supply		V, Ø, Hz	380-400-415, 3, 50/60	380-400-415, 3, 50/60
Running Current	Cooling (Rated)	A	17.82 - 16.93 - 16.32	17.99 - 17.09 - 16.48
	Heating (Max)	A	21.30 - 20.24 - 19.50	19.00 - 18.05 - 17.40
Number of maximum connectable indoor units ***			26(40)	29(45)

### Note

- Due to our policy of innovation some specifications may be changed without notification.
- Wiring cable size must comply with the applicable local and national codes. And "Electric characteristics" chapter should be considered for electrical work and design. Especially the power cable and circuit breaker should be selected in accordance with that.
- Sound pressure level is measured on the rated condition in the anechoic rooms by ISO 3745 standard.  
Sound power level is measured on the rated condition in the reverberation rooms by ISO 3741 standard.  
Therefore, these values can be increased owing to ambient conditions during operation.
- Sound values of combination model are calculated values based on sound results of independent models.  
Sound values can be increased owing to ambient or installation conditions during operation.  
Sound values of system [dB(A)] =  $10 \cdot \log [10^{(A1/10)} + \dots + 10^{(An/10)}]$ , A1~An means sound values of independent models.
- Performances are based on the following conditions :
  - \*Cooling : Indoor Ambient Temp. 27°CDB / 19°CWB, Outdoor Ambient Temp. 35°CDB / 24°CWB
  - \*Heating : Indoor Ambient Temp. 20°CDB / 15°CWB, Outdoor Ambient Temp. 7°CDB / 6°CWB
  - Interconnected Pipe Length is 7.5m and difference of Elevation (Outdoor ~ Indoor Unit) is 0m.
- EUROVENT Test Condition :
  - Performance values in this PDB are based on Ceiling concealed duct combination.
  - Refer to EUROVENT web site([www.eurovent-certification.com](http://www.eurovent-certification.com)) for other indoor unit combination and more detail test conditions.
- \*\*\* : The number in parentheses means maximum connectable indoor units in accordance with outdoor units combination (160~200%).  
The recommended ratio is 130%.
- This product contains Fluorinated greenhouse gases.(R410A, GWP(Global warming potential) = 2,087.5)
- #1 : Heat Recovery system, #2 : Heat Pump system

# 1. Specifications

HP			20	22
Model Name	Combination Unit		ARUM200LTE5	ARUM220LTE5
	Independent Unit		ARUM200LTE5	ARUM220LTE5
Capacity	Cooling (Rated)	kW	56.0	61.6
		Btu/h	191,100	210,200
	Heating (Rated.)	kW	56.0	61.6
		Btu/h	191,100	210,200
	Heating (Max.)	kW	63.0	69.3
		Btu/h	215,000	236,500
Input	Cooling (Rated)	kW	12.76	15.92
	Heating (Rated)	kW	12.20	14.15
	Heating (Max.)	kW	14.69	16.76
EER (Rated)			4.39	3.87
COP	Rated capacity		4.59	4.35
	Max. capacity		4.29	4.13
SEER			8.05	7.49
SCOP			3.98	3.90
Exterior	Color		Warm Gray / Dawn Gray	Warm Gray / Dawn Gray
	RAL (Classic)		RAL 7044 / RAL 7037	RAL 7044 / RAL 7037
Heat Exchanger			Wide Louver Plus	Wide Louver Plus
Compressor	Type		Hermetically Sealed Scroll	Hermetically Sealed Scroll
	Piston Displacement	cm <sup>3</sup> /rev	62.1 × 1 + 43.8 × 1	62.1 × 1 + 43.8 × 1
	Number of Revolution	rev/min	3,600 × 2	3,600 × 2
	Motor Output x Number	W x No.	5,300 × 1 + 4,200 × 1	5,300 × 1 + 4,200 × 1
	Starting Method		Direct On Line	Direct On Line
	Oil Type		FVC68D(PVE)	FVC68D(PVE)
Fan	Type		Propeller fan	Propeller fan
	Motor Output x Number	W	900 × 2	900 × 2
	Air Flow Rate(High)	m <sup>3</sup> /min	320 × 1	320 × 1
		ft <sup>3</sup> /min	1,1301 × 1	1,1301 × 1
	External Static Pressure (Max, Pa)		DC INVERTER	DC INVERTER
	Drive		80	80
	Discharge	Side / Top	TOP	TOP
Pipe Connections #1	Liquid	mm(inch)	15.88(5/8)	15.88(5/8)
	Low Pressure Gas	mm(inch)	28.58(1-1/8)	28.58(1-1/8)
	High Pressure Gas	mm(inch)	22.2(7/8)	28.58(1-1/8)
Pipe Connections #2	Liquid	mm(inch)	15.88(5/8)	15.88(5/8)
	Gas	mm(inch)	28.58(1-1/8)	28.58(1-1/8)
Dimensions(W x H x D)		mm	(1,240 × 1,690 × 760)×1	(1,240 × 1,690 × 760)×1
		inch	(48-13/16 × 66-17/32 × 29-29/32) × 1	(48-13/16 × 66-17/32 × 29-29/32) × 1

## Note

- Due to our policy of innovation some specifications may be changed without notification.
- Wiring cable size must comply with the applicable local and national codes. And "Electric characteristics" chapter should be considered for electrical work and design. Especially the power cable and circuit breaker should be selected in accordance with that.
- Sound pressure level is measured on the rated condition in the anechoic rooms by ISO 3745 standard.  
Sound power level is measured on the rated condition in the reverberation rooms by ISO 3741 standard.  
Therefore, these values can be increased owing to ambient conditions during operation.
- Sound values of combination model are calculated values based on sound results of independent models.  
Sound values can be increased owing to ambient or installation conditions during operation.  
Sound values of system [dB(A)] = 10\*log [10<sup>A1</sup>(A1/10)+ ... +10<sup>An</sup>(An/10)] , A1~An means sound values of independent models.
- Performances are based on the following conditions :
  - \*Cooling : Indoor Ambient Temp. 27°CDB / 19°CWB, Outdoor Ambient Temp. 35°CDB / 24°CWB
  - \*Heating : Indoor Ambient Temp. 20°CDB / 15°CWB, Outdoor Ambient Temp. 7°CDB / 6°CWB
  - Interconnected Pipe Length is 7.5m and difference of Elevation (Outdoor ~ Indoor Unit) is 0m.
- EUROVENT Test Condition :
  - Performance values in this PDB are based on Ceiling concealed duct combination.
  - Refer to EUROVENT web site([www.eurovent-certification.com](http://www.eurovent-certification.com)) for other indoor unit combination and more detail test conditions.
- \*\*\* : The number in parentheses means maximum connectable indoor units in accordance with outdoor units combination (160~200%).  
The recommended ratio is 130%.
- This product contains Fluorinated greenhouse gases.(R410A, GWP(Global warming potential) = 2,087.5)
- #1 : Heat Recovery system, #2 : Heat Pump system



# 1. Specifications

HP			20	22
Model Name	Combination Unit		ARUM200LTE5	ARUM220LTE5
	Independent Unit		ARUM200LTE5	ARUM220LTE5
Net Weight		kg	300 × 1	300 × 1
		lbs	661 × 1	661 × 1
Sound Pressure Level	Cooling	dB(A)	62.0	64.5
	Heating	dB(A)	64.5	65.5
Sound Power Level	Cooling	dB(A)	89.0	91.0
	Heating	dB(A)	90.0	93.0
Protection Devices	High pressure protection		High pressure sensor / High pressure switch	
	Compressor/Fan		Over-heat protection / Fan driver overload protector	
	Inverter		Over-heat protection / Over-current protection	
Communication Cable (VCTF-SB)	No. × mm <sup>2</sup>		2C × 1.0 ~ 1.5	2C × 1.0 ~ 1.5
Refrigerant	Refrigerant name		R410A	R410A
	Precharged Amount	kg	16.0	16.0
		lbs	35.3	35.3
	t-CO <sub>2</sub> eq		33.400	33.400
Control		Electronic Expansion Valve	Electronic Expansion Valve	
Power Supply		V, Ø, Hz	380-400-415, 3, 50/60	380-400-415, 3, 50/60
Running Current	Cooling (Rated)	A	20.88 - 19.84 - 19.12	25.95 - 24.66 - 23.76
	Heating (Max)	A	24.00 - 22.80 - 21.98	27.40 - 26.03 - 25.09
Number of maximum connectable indoor units ***			32(50)	35(56)

### Note

- Due to our policy of innovation some specifications may be changed without notification.
- Wiring cable size must comply with the applicable local and national codes. And "Electric characteristics" chapter should be considered for electrical work and design. Especially the power cable and circuit breaker should be selected in accordance with that.
- Sound pressure level is measured on the rated condition in the anechoic rooms by ISO 3745 standard.  
Sound power level is measured on the rated condition in the reverberation rooms by ISO 3741 standard.  
Therefore, these values can be increased owing to ambient conditions during operation.
- Sound values of combination model are calculated values based on sound results of independent models.  
Sound values can be increased owing to ambient or installation conditions during operation.  
Sound values of system [dB(A)] =  $10 \cdot \log [10^{(A1/10)} + \dots + 10^{(An/10)}]$ , A1~An means sound values of independent models.
- Performances are based on the following conditions :
  - \*Cooling : Indoor Ambient Temp. 27°CDB / 19°CWB, Outdoor Ambient Temp. 35°CDB / 24°CWB
  - \*Heating : Indoor Ambient Temp. 20°CDB / 15°CWB, Outdoor Ambient Temp. 7°CDB / 6°CWB
  - Interconnected Pipe Length is 7.5m and difference of Elevation (Outdoor ~ Indoor Unit) is 0m.
- EUROVENT Test Condition :
  - Performance values in this PDB are based on Ceiling concealed duct combination.
  - Refer to EUROVENT web site([www.eurovent-certification.com](http://www.eurovent-certification.com)) for other indoor unit combination and more detail test conditions.
- \*\*\* : The number in parentheses means maximum connectable indoor units in accordance with outdoor units combination (160~200%).  
The recommended ratio is 130%.
- This product contains Fluorinated greenhouse gases.(R410A, GWP(Global warming potential) = 2,087.5)
- #1 : Heat Recovery system, #2 : Heat Pump system

# 1. Specifications

HP			24	26
Model Name	Combination Unit		ARUM240LTE5	ARUM260LTE5
	Independent Unit		ARUM240LTE5	ARUM260LTE5
Capacity	Cooling (Rated)	kW	67.2	72.8
		Btu/h	229,300	248,400
	Heating (Rated.)	kW	67.2	67.2
		Btu/h	229,300	229,300
	Heating (Max.)	kW	74.3	74.3
		Btu/h	253,400	253,400
Input	Cooling (Rated)	kW	17.41	20.22
	Heating (Rated)	kW	15.89	15.89
	Heating (Max.)	kW	18.80	19.15
EER (Rated)			3.86	3.60
COP	Rated capacity		4.23	4.23
	Max. capacity		3.95	3.88
SEER			7.88	7.55
SCOP			4.34	4.34
Exterior	Color		Warm Gray / Dawn Gray	Warm Gray / Dawn Gray
	RAL (Classic)		RAL 7044 / RAL 7037	RAL 7044 / RAL 7037
Heat Exchanger			Wide Louver Plus	Wide Louver Plus
Compressor	Type		Hermetically Sealed Scroll	Hermetically Sealed Scroll
	Piston Displacement	cm <sup>3</sup> /rev	62.1 × 2	62.1 × 2
	Number of Revolution	rev/min	3,600 × 2	3,600 × 2
	Motor Output x Number	W x No.	5,300 × 2	5,300 × 2
	Starting Method		Direct On Line	Direct On Line
	Oil Type		FVC68D(PVE)	FVC68D(PVE)
Fan	Type		Propeller fan	Propeller fan
	Motor Output x Number	W	900 × 2	900 × 2
	Air Flow Rate(High)	m <sup>3</sup> /min	320 × 1	320 × 1
		ft <sup>3</sup> /min	1,1301 × 1	1,1301 × 1
	External Static Pressure (Max, Pa)		DC INVERTER	DC INVERTER
	Drive		80	80
Discharge	Side / Top	TOP	TOP	
Pipe Connections #1	Liquid	mm(inch)	15.88(5/8)	19.05(3/4)
	Low Pressure Gas	mm(inch)	34.9(1-3/8)	34.9(1-3/8)
	High Pressure Gas	mm(inch)	28.58(1-1/8)	28.58(1-1/8)
Pipe Connections #2	Liquid	mm(inch)	15.88(5/8)	19.05(3/4)
	Gas	mm(inch)	34.9(1-3/8)	34.9(1-3/8)
Dimensions(W x H x D)		mm	(1,240 × 1,690 × 760)×1	(1,240 × 1,690 × 760)×1
		inch	(48-13/16 × 66-17/32 × 29-29/32) × 1	(48-13/16 × 66-17/32 × 29-29/32) × 1

## Note

- Due to our policy of innovation some specifications may be changed without notification.
- Wiring cable size must comply with the applicable local and national codes. And "Electric characteristics" chapter should be considered for electrical work and design. Especially the power cable and circuit breaker should be selected in accordance with that.
- Sound pressure level is measured on the rated condition in the anechoic rooms by ISO 3745 standard.  
Sound power level is measured on the rated condition in the reverberation rooms by ISO 3741 standard.  
Therefore, these values can be increased owing to ambient conditions during operation.
- Sound values of combination model are calculated values based on sound results of independent models.  
Sound values can be increased owing to ambient or installation conditions during operation.  
Sound values of system [dB(A)] = 10\*log [10<sup>A1</sup>(A1/10)+ ... +10<sup>An</sup>(An/10)] , A1~An means sound values of independent models.
- Performances are based on the following conditions :
  - \*Cooling : Indoor Ambient Temp. 27°CDB / 19°CWB, Outdoor Ambient Temp. 35°CDB / 24°CWB
  - \*Heating : Indoor Ambient Temp. 20°CDB / 15°CWB, Outdoor Ambient Temp. 7°CDB / 6°CWB
  - Interconnected Pipe Length is 7.5m and difference of Elevation (Outdoor ~ Indoor Unit) is 0m.
- EUROVENT Test Condition :
  - Performance values in this PDB are based on Ceiling concealed duct combination.
  - Refer to EUROVENT web site([www.eurovent-certification.com](http://www.eurovent-certification.com)) for other indoor unit combination and more detail test conditions.
- \*\*\* : The number in parentheses means maximum connectable indoor units in accordance with outdoor units combination (160~200%).  
The recommended ratio is 130%.
- This product contains Fluorinated greenhouse gases.(R410A, GWP(Global warming potential) = 2,087.5)
- #1 : Heat Recovery system, #2 : Heat Pump system

# 1. Specifications

HP			24	26
Model Name	Combination Unit		ARUM240LTE5	ARUM260LTE5
	Independent Unit		ARUM240LTE5	ARUM260LTE5
Net Weight		kg	310 × 1	310 × 1
		lbs	683 × 1	683 × 1
Sound Pressure Level	Cooling	dB(A)	65.0	65.0
	Heating	dB(A)	67.0	67.0
Sound Power Level	Cooling	dB(A)	91.0	91.0
	Heating	dB(A)	93.0	93.0
Protection Devices	High pressure protection		High pressure sensor / High pressure switch	
	Compressor/Fan		Over-heat protection / Fan driver overload protector	
	Inverter		Over-heat protection / Over-current protection	
Communication Cable (VCTF-SB)	No. × mm <sup>2</sup>		2C × 1.0 ~ 1.5	2C × 1.0 ~ 1.5
Refrigerant	Refrigerant name		R410A	R410A
	Precharged Amount	kg	17.0	17.0
		lbs	37.5	37.5
	t-CO <sub>2</sub> eq		35.488	35.488
Control		Electronic Expansion Valve	Electronic Expansion Valve	
Power Supply		V, Ø, Hz	380-400-415, 3, 50/60	380-400-415, 3, 50/60
Running Current	Cooling (Rated)	A	28.42 - 26.99 - 26.01	33.04 - 31.38 - 30.25
	Heating (Max)	A	30.70 - 29.17 - 28.11	30.60 - 29.07 - 28.02
Number of maximum connectable indoor units ***			39(61)	42(64)

### Note

- Due to our policy of innovation some specifications may be changed without notification.
- Wiring cable size must comply with the applicable local and national codes. And "Electric characteristics" chapter should be considered for electrical work and design. Especially the power cable and circuit breaker should be selected in accordance with that.
- Sound pressure level is measured on the rated condition in the anechoic rooms by ISO 3745 standard.  
Sound power level is measured on the rated condition in the reverberation rooms by ISO 3741 standard.  
Therefore, these values can be increased owing to ambient conditions during operation.
- Sound values of combination model are calculated values based on sound results of independent models.  
Sound values can be increased owing to ambient or installation conditions during operation.  
Sound values of system [dB(A)] =  $10 \cdot \log [10^{(A1/10)} + \dots + 10^{(An/10)}]$ , A1~An means sound values of independent models.
- Performances are based on the following conditions :
  - \*Cooling : Indoor Ambient Temp. 27°CDB / 19°CWB, Outdoor Ambient Temp. 35°CDB / 24°CWB
  - \*Heating : Indoor Ambient Temp. 20°CDB / 15°CWB, Outdoor Ambient Temp. 7°CDB / 6°CWB
  - Interconnected Pipe Length is 7.5m and difference of Elevation (Outdoor ~ Indoor Unit) is 0m.
- EUROVENT Test Condition :
  - Performance values in this PDB are based on Ceiling concealed duct combination.
  - Refer to EUROVENT web site([www.eurovent-certification.com](http://www.eurovent-certification.com)) for other indoor unit combination and more detail test conditions.
- \*\*\* : The number in parentheses means maximum connectable indoor units in accordance with outdoor units combination (160~200%).  
The recommended ratio is 130%.
- This product contains Fluorinated greenhouse gases.(R410A, GWP(Global warming potential) = 2,087.5)
- #1 : Heat Recovery system, #2 : Heat Pump system

# 1. Specifications

HP			22	24
Model Name	Combination Unit		ARUM221LTE5	ARUM241LTE5
	Independent Unit		ARUM120LTE5	ARUM120LTE5
			ARUM100LTE5	ARUM120LTE5
Capacity	Cooling (Rated)	kW	61.6	67.2
		Btu/h	210,200	229,300
	Heating (Rated.)	kW	61.6	67.2
		Btu/h	210,200	229,300
	Heating (Max.)	kW	69.3	75.6
		Btu/h	236,500	257,900
Input	Cooling (Rated)	kW	14.54	15.41
	Heating (Rated)	kW	11.77	13.70
	Heating (Max.)	kW	14.18	16.52
EER (Rated)			4.24	4.36
COP	Rated capacity		5.23	4.91
	Max. capacity		4.89	4.58
SEER			9.66	9.70
SCOP			4.78	5.03
Exterior	Color		Warm Gray / Dawn Gray	Warm Gray / Dawn Gray
	RAL (Classic)		RAL 7044 / RAL 7037	RAL 7044 / RAL 7037
Heat Exchanger			Wide Louver Plus	Wide Louver Plus
Compressor	Type		Hermetically Sealed Scroll	Hermetically Sealed Scroll
	Piston Displacement	cm <sup>3</sup> /rev	62.1 × 2	62.1 × 2
	Number of Revolution	rev/min	3,600 × 2	3,600 × 2
	Motor Output x Number	W x No.	5,300 × 2	5,300 × 2
	Starting Method		Direct On Line	Direct On Line
	Oil Type		FVC68D(PVE)	FVC68D(PVE)
Fan	Type		Propeller fan	Propeller fan
	Motor Output x Number	W	(1200 × 1) + (1,200 × 1)	(1200 × 1) + (1,200 × 1)
	Air Flow Rate(High)	m <sup>3</sup> /min	(240 × 1) + (240 × 1)	(240 × 1) + (240 × 1)
		ft <sup>3</sup> /min	(8,476 × 1) + (8,476 × 1)	(8,476 × 1) + (8,476 × 1)
	External Static Pressure (Max, Pa)		DC INVERTER	DC INVERTER
	Drive		80	80
Discharge		Side / Top	TOP	
Pipe Connections #1	Liquid	mm(inch)	15.88(5/8)	15.88(5/8)
	Low Pressure Gas	mm(inch)	28.58(1-1/8)	34.9(1-3/8)
	High Pressure Gas	mm(inch)	28.58(1-1/8)	28.58(1-1/8)
Pipe Connections #2	Liquid	mm(inch)	15.88(5/8)	15.88(5/8)
	Gas	mm(inch)	28.58(1-1/8)	34.9(1-3/8)

## Note

- Due to our policy of innovation some specifications may be changed without notification.
- Wiring cable size must comply with the applicable local and national codes. And "Electric characteristics" chapter should be considered for electrical work and design. Especially the power cable and circuit breaker should be selected in accordance with that.
- Sound pressure level is measured on the rated condition in the anechoic rooms by ISO 3745 standard.  
Sound power level is measured on the rated condition in the reverberation rooms by ISO 3741 standard.  
Therefore, these values can be increased owing to ambient conditions during operation.
- Sound values of combination model are calculated values based on sound results of independent models.  
Sound values can be increased owing to ambient or installation conditions during operation.  
Sound values of system [dB(A)] = 10\*log [10<sup>A1</sup>/10 + ... + 10<sup>An</sup>/10], A1~An means sound values of independent models.
- Performances are based on the following conditions :
  - \*Cooling : Indoor Ambient Temp. 27°CDB / 19°CWB, Outdoor Ambient Temp. 35°CDB / 24°CWB
  - \*Heating : Indoor Ambient Temp. 20°CDB / 15°CWB, Outdoor Ambient Temp. 7°CDB / 6°CWB
  - Interconnected Pipe Length is 7.5m and difference of Elevation (Outdoor ~ Indoor Unit) is 0m.
- EUROVENT Test Condition :
  - Performance values in this PDB are based on Ceiling concealed duct combination.
  - Refer to EUROVENT web site([www.eurovent-certification.com](http://www.eurovent-certification.com)) for other indoor unit combination and more detail test conditions.
- \*\*\* : The number in parentheses means maximum connectable indoor units in accordance with outdoor units combination (160~200%).  
The recommended ratio is 130%.
- This product contains Fluorinated greenhouse gases.(R410A, GWP(Global warming potential) = 2,087.5)
- #1 : Heat Recovery system, #2 : Heat Pump system

# 1. Specifications

HP			22	24
Model Name	Combination Unit		ARUM221LTE5	ARUM241LTE5
	Independent Unit		ARUM120LTE5	ARUM120LTE5
			ARUM100LTE5	ARUM120LTE5
Dimensions(W x H x D)		mm	$(930 \times 1,690 \times 760) \times 1 + (930 \times 1,690 \times 760) \times 1$	$(930 \times 1,690 \times 760) \times 1 + (930 \times 1,690 \times 760) \times 1$
		inch	$(36-5/8 \times 66-17/32 \times 29-29/32) \times 1 + (36-5/8 \times 66-17/32 \times 29-29/32) \times 1$	$(36-5/8 \times 66-17/32 \times 29-29/32) \times 1 + (36-5/8 \times 66-17/32 \times 29-29/32) \times 1$
Net Weight		kg	$(215 \times 1) + (215 \times 1)$	$(215 \times 1) + (215 \times 1)$
		lbs	$(474 \times 1) + (474 \times 1)$	$(474 \times 1) + (474 \times 1)$
Sound Pressure Level	Cooling	dB(A)	61.5	62.0
	Heating	dB(A)	62.5	63.0
Sound Power Level	Cooling	dB(A)	83.1	84.0
	Heating	dB(A)	83.1	84.0
Protection Devices	High pressure protection		High pressure sensor / High pressure switch	
	Compressor/Fan		Over-heat protection / Fan driver overload protector	
	Inverter		Over-heat protection / Over-current protection	
Communication Cable (VCTF-SB)		No. xmm <sup>2</sup>	2C x 1.0 ~ 1.5	2C x 1.0 ~ 1.5
Refrigerant	Refrigerant name		R410A	R410A
	Precharged Amount	kg	19.0	19.0
		lbs	41.9	41.9
	t-CO <sub>2</sub> eq		39.663	39.663
Control		Electronic Expansion Valve	Electronic Expansion Valve	
Power Supply		V, Ø, Hz	380-400-415, 3, 50/60	380-400-415, 3, 50/60
Running Current	Cooling (Rated)	A	23.79 - 22.61 - 21.78	24.10 - 22.90 - 22.06
	Heating (Max)	A	24.10 - 22.90 - 22.07	25.60 - 24.32 - 23.44
Number of maximum connectable indoor units ***			35(44)	39(48)
<b>Note</b>				
1. Due to our policy of innovation some specifications may be changed without notification.				
2. Wiring cable size must comply with the applicable local and national codes. And "Electric characteristics" chapter should be considered for electrical work and design. Especially the power cable and circuit breaker should be selected in accordance with that.				
3. Sound pressure level is measured on the rated condition in the anechoic rooms by ISO 3745 standard. Sound power level is measured on the rated condition in the reverberation rooms by ISO 3741 standard. Therefore, these values can be increased owing to ambient conditions during operation.				
4. Sound values of combination model are calculated values based on sound results of independent models. Sound values can be increased owing to ambient or installation conditions during operation. Sound values of system [dB(A)] = $10 \cdot \log [10^{A1/10} + \dots + 10^{An/10}]$ , A1~An means sound values of independent models.				
5. Performances are based on the following conditions : <ul style="list-style-type: none"> <li>• *Cooling : Indoor Ambient Temp. 27°CDB / 19°CWB, Outdoor Ambient Temp. 35°CDB / 24°CWB</li> <li>• *Heating : Indoor Ambient Temp. 20°CDB / 15°CWB, Outdoor Ambient Temp. 7°CDB / 6°CWB</li> <li>• Interconnected Pipe Length is 7.5m and difference of Elevation (Outdoor ~ Indoor Unit) is 0m.</li> </ul>				
6. EUROVENT Test Condition : <ul style="list-style-type: none"> <li>• Performance values in this PDB are based on Ceiling concealed duct combination.</li> <li>• Refer to EUROVENT web site(<a href="http://www.eurovent-certification.com">www.eurovent-certification.com</a>) for other indoor unit combination and more detail test conditions.</li> </ul>				
7. *** : The number in parentheses means maximum connectable indoor units in accordance with outdoor units combination (160~200%). The recommended ratio is 130%.				
8. This product contains Fluorinated greenhouse gases.(R410A, GWP(Global warming potential) = 2,087.5)				
9. #1 : Heat Recovery system, #2 : Heat Pump system				

# 1. Specifications

HP			26	28
Model Name	Combination Unit		ARUM261LTE5	ARUM280LTE5
	Independent Unit		ARUM140LTE5	ARUM160LTE5
			ARUM120LTE5	ARUM120LTE5
Capacity	Cooling (Rated)	kW	72.8	78.4
		Btu/h	248,400	267,500
	Heating (Rated.)	kW	72.8	78.4
		Btu/h	248,400	267,500
	Heating (Max.)	kW	81.9	88.2
		Btu/h	279,400	300,900
Input	Cooling (Rated)	kW	16.38	18.61
	Heating (Rated)	kW	15.33	17.13
	Heating (Max.)	kW	17.98	20.65
EER (Rated)			4.44	4.21
COP	Rated capacity		4.75	4.58
	Max. capacity		4.56	4.27
SEER			9.29	8.98
SCOP			4.81	4.92
Exterior	Color		Warm Gray / Dawn Gray	Warm Gray / Dawn Gray
	RAL (Classic)		RAL 7044 / RAL 7037	RAL 7044 / RAL 7037
Heat Exchanger			Wide Louver Plus	Wide Louver Plus
Compressor	Type		Hermetically Sealed Scroll	Hermetically Sealed Scroll
	Piston Displacement	cm <sup>3</sup> /rev	62.1 × 2	62.1 × 2
	Number of Revolution	rev/min	3,600 × 2	3,600 × 2
	Motor Output x Number	W x No.	5,300 × 2	5,300 × 2
	Starting Method		Direct On Line	Direct On Line
	Oil Type		FVC68D(PVE)	FVC68D(PVE)
Fan	Type		Propeller fan	Propeller fan
	Motor Output x Number	W	(900 × 2) + (1,200 × 1)	(900 × 2) + (1,200 × 1)
	Air Flow Rate(High)	m <sup>3</sup> /min	(320 × 1) + (240 × 1)	(320 × 1) + (240 × 1)
		ft <sup>3</sup> /min	(11,301 × 1) + (8,476 × 1)	(11,301 × 1) + (8,476 × 1)
	External Static Pressure (Max, Pa)		DC INVERTER	DC INVERTER
	Drive		80	80
Discharge	Side / Top	TOP	TOP	
Pipe Connections #1	Liquid	mm(inch)	19.05(3/4)	19.05(3/4)
	Low Pressure Gas	mm(inch)	34.9(1-3/8)	34.9(1-3/8)
	High Pressure Gas	mm(inch)	28.58(1-1/8)	28.58(1-1/8)
Pipe Connections #2	Liquid	mm(inch)	19.05(3/4)	19.05(3/4)
	Gas	mm(inch)	34.9(1-3/8)	34.9(1-3/8)

## Note

- Due to our policy of innovation some specifications may be changed without notification.
- Wiring cable size must comply with the applicable local and national codes. And "Electric characteristics" chapter should be considered for electrical work and design. Especially the power cable and circuit breaker should be selected in accordance with that.
- Sound pressure level is measured on the rated condition in the anechoic rooms by ISO 3745 standard.  
Sound power level is measured on the rated condition in the reverberation rooms by ISO 3741 standard.  
Therefore, these values can be increased owing to ambient conditions during operation.
- Sound values of combination model are calculated values based on sound results of independent models.  
Sound values can be increased owing to ambient or installation conditions during operation.  
Sound values of system [dB(A)] = 10\*log [10<sup>A1</sup>/10 + ... + 10<sup>An</sup>/10], A1~An means sound values of independent models.
- Performances are based on the following conditions :
  - \*Cooling : Indoor Ambient Temp. 27°CDB / 19°CWB, Outdoor Ambient Temp. 35°CDB / 24°CWB
  - \*Heating : Indoor Ambient Temp. 20°CDB / 15°CWB, Outdoor Ambient Temp. 7°CDB / 6°CWB
  - Interconnected Pipe Length is 7.5m and difference of Elevation (Outdoor ~ Indoor Unit) is 0m.
- EUROVENT Test Condition :
  - Performance values in this PDB are based on Ceiling concealed duct combination.
  - Refer to EUROVENT web site([www.eurovent-certification.com](http://www.eurovent-certification.com)) for other indoor unit combination and more detail test conditions.
- \*\*\* : The number in parentheses means maximum connectable indoor units in accordance with outdoor units combination (160~200%).  
The recommended ratio is 130%.
- This product contains Fluorinated greenhouse gases.(R410A, GWP(Global warming potential) = 2,087.5)
- #1 : Heat Recovery system, #2 : Heat Pump system

# 1. Specifications

HP			26	28
Model Name	Combination Unit		ARUM261LTE5	ARUM280LTE5
	Independent Unit		ARUM140LTE5	ARUM160LTE5
			ARUM120LTE5	ARUM120LTE5
Dimensions(W x H x D)		mm	$(1,240 \times 1,690 \times 760) \times 1 + (930 \times 1,690 \times 760) \times 1$	$(1,240 \times 1,690 \times 760) \times 1 + (930 \times 1,690 \times 760) \times 1$
		inch	$(48-13/16 \times 66-17/32 \times 29-29/32) \times 1 + (36-5/8 \times 66-17/32 \times 29-29/32) \times 1$	$(48-13/16 \times 66-17/32 \times 29-29/32) \times 1 + (36-5/8 \times 66-17/32 \times 29-29/32) \times 1$
Net Weight		kg	$(237 \times 1) + (215 \times 1)$	$(237 \times 1) + (215 \times 1)$
		lbs	$(522 \times 1) + (474 \times 1)$	$(522 \times 1) + (474 \times 1)$
Sound Pressure Level	Cooling	dB(A)	62.5	62.8
	Heating	dB(A)	63.5	63.8
Sound Power Level	Cooling	dB(A)	84.0	86.5
	Heating	dB(A)	84.5	87.2
Protection Devices	High pressure protection		High pressure sensor / High pressure switch	
	Compressor/Fan		Over-heat protection / Fan driver overload protector	
	Inverter		Over-heat protection / Over-current protection	
Communication Cable (VCTF-SB)		No. xmm <sup>2</sup>	2C x 1.0 ~ 1.5	2C x 1.0 ~ 1.5
Refrigerant	Refrigerant name		R410A	R410A
	Precharged Amount	kg	23.0	23.0
		lbs	50.7	50.7
	t-CO <sub>2</sub> eq		48.013	48.013
Control		Electronic Expansion Valve	Electronic Expansion Valve	
Power Supply		V, Ø, Hz	380-400-415, 3, 50/60	380-400-415, 3, 50/60
Running Current	Cooling (Rated)	A	26.79 - 25.45 - 24.54	30.42 - 28.90 - 27.85
	Heating (Max)	A	30.40 - 28.88 - 27.84	35.70 - 33.92 - 32.69
Number of maximum connectable indoor units ***			42(52)	45(56)
<b>Note</b>				
1. Due to our policy of innovation some specifications may be changed without notification.				
2. Wiring cable size must comply with the applicable local and national codes. And "Electric characteristics" chapter should be considered for electrical work and design. Especially the power cable and circuit breaker should be selected in accordance with that.				
3. Sound pressure level is measured on the rated condition in the anechoic rooms by ISO 3745 standard. Sound power level is measured on the rated condition in the reverberation rooms by ISO 3741 standard. Therefore, these values can be increased owing to ambient conditions during operation.				
4. Sound values of combination model are calculated values based on sound results of independent models. Sound values can be increased owing to ambient or installation conditions during operation. Sound values of system [dB(A)] = $10 \cdot \log [10^{A1/10} + \dots + 10^{An/10}]$ , A1~An means sound values of independent models.				
5. Performances are based on the following conditions : <ul style="list-style-type: none"> <li>*Cooling : Indoor Ambient Temp. 27°CDB / 19°CWB, Outdoor Ambient Temp. 35°CDB / 24°CWB</li> <li>*Heating : Indoor Ambient Temp. 20°CDB / 15°CWB, Outdoor Ambient Temp. 7°CDB / 6°CWB</li> <li>Interconnected Pipe Length is 7.5m and difference of Elevation (Outdoor ~ Indoor Unit) is 0m.</li> </ul>				
6. EUROVENT Test Condition : <ul style="list-style-type: none"> <li>Performance values in this PDB are based on Ceiling concealed duct combination.</li> <li>Refer to EUROVENT web site(<a href="http://www.eurovent-certification.com">www.eurovent-certification.com</a>) for other indoor unit combination and more detail test conditions.</li> </ul>				
7. *** : The number in parentheses means maximum connectable indoor units in accordance with outdoor units combination (160~200%). The recommended ratio is 130%.				
8. This product contains Fluorinated greenhouse gases.(R410A, GWP(Global warming potential) = 2,087.5)				
9. #1 : Heat Recovery system, #2 : Heat Pump system				

# 1. Specifications

HP			30	32
Model Name	Combination Unit		ARUM300LTE5	ARUM320LTE5
	Independent Unit		ARUM180LTE5	ARUM200LTE5
			ARUM120LTE5	ARUM120LTE5
Capacity	Cooling (Rated)	kW	84.0	89.6
		Btu/h	286,600	305,700
	Heating (Rated.)	kW	84.0	89.6
		Btu/h	286,600	305,700
	Heating (Max.)	kW	94.5	100.8
		Btu/h	322,400	343,900
Input	Cooling (Rated)	kW	18.73	20.46
	Heating (Rated)	kW	16.97	19.05
	Heating (Max.)	kW	20.20	22.95
EER (Rated)			4.48	4.38
COP	Rated capacity		4.95	4.70
	Max. capacity		4.68	4.39
SEER			8.79	8.63
SCOP			4.54	4.33
Exterior	Color		Warm Gray / Dawn Gray	Warm Gray / Dawn Gray
	RAL (Classic)		RAL 7044 / RAL 7037	RAL 7044 / RAL 7037
Heat Exchanger			Wide Louver Plus	Wide Louver Plus
Compressor	Type		Hermetically Sealed Scroll	Hermetically Sealed Scroll
	Piston Displacement	cm <sup>3</sup> /rev	(62.1 × 2) + (43.8 × 1)	(62.1 × 2) + (43.8 × 1)
	Number of Revolution	rev/min	3,600 × 3	3,600 × 3
	Motor Output x Number	W x No.	(5,300 × 2) + (4,200 × 1)	(5,300 × 2) + (4,200 × 1)
	Starting Method		Direct On Line	Direct On Line
	Oil Type		FVC68D(PVE)	FVC68D(PVE)
Fan	Type		Propeller fan	Propeller fan
	Motor Output x Number	W	(900 × 2) + (1,200 × 1)	(900 × 2) + (1,200 × 1)
	Air Flow Rate(High)	m <sup>3</sup> /min	(320 × 1) + (240 × 1)	(320 × 1) + (240 × 1)
		ft <sup>3</sup> /min	(11,301 × 1) + (8,476 × 1)	(11,301 × 1) + (8,476 × 1)
	External Static Pressure (Max, Pa)		DC INVERTER	DC INVERTER
	Drive		80	80
Discharge	Side / Top	TOP	TOP	
Pipe Connections #1	Liquid	mm(inch)	19.05(3/4)	19.05(3/4)
	Low Pressure Gas	mm(inch)	34.9(1-3/8)	34.9(1-3/8)
	High Pressure Gas	mm(inch)	28.58(1-1/8)	28.58(1-1/8)
Pipe Connections #2	Liquid	mm(inch)	19.05(3/4)	19.05(3/4)
	Gas	mm(inch)	34.9(1-3/8)	34.9(1-3/8)

## Note

- Due to our policy of innovation some specifications may be changed without notification.
- Wiring cable size must comply with the applicable local and national codes. And "Electric characteristics" chapter should be considered for electrical work and design. Especially the power cable and circuit breaker should be selected in accordance with that.
- Sound pressure level is measured on the rated condition in the anechoic rooms by ISO 3745 standard.  
Sound power level is measured on the rated condition in the reverberation rooms by ISO 3741 standard.  
Therefore, these values can be increased owing to ambient conditions during operation.
- Sound values of combination model are calculated values based on sound results of independent models.  
Sound values can be increased owing to ambient or installation conditions during operation.  
Sound values of system [dB(A)] = 10\*log [10<sup>A1</sup>(A1/10)+ ... +10<sup>An</sup>(An/10)] , A1~An means sound values of independent models.
- Performances are based on the following conditions :
  - \*Cooling : Indoor Ambient Temp. 27°CDB / 19°CWB, Outdoor Ambient Temp. 35°CDB / 24°CWB
  - \*Heating : Indoor Ambient Temp. 20°CDB / 15°CWB, Outdoor Ambient Temp. 7°CDB / 6°CWB
  - Interconnected Pipe Length is 7.5m and difference of Elevation (Outdoor ~ Indoor Unit) is 0m.
- EUROVENT Test Condition :
  - Performance values in this PDB are based on Ceiling concealed duct combination.
  - Refer to EUROVENT web site([www.eurovent-certification.com](http://www.eurovent-certification.com)) for other indoor unit combination and more detail test conditions.
- \*\*\* : The number in parentheses means maximum connectable indoor units in accordance with outdoor units combination (160~200%).  
The recommended ratio is 130%.
- This product contains Fluorinated greenhouse gases.(R410A, GWP(Global warming potential) = 2,087.5)
- #1 : Heat Recovery system, #2 : Heat Pump system



# 1. Specifications

HP			30	32
Model Name	Combination Unit		ARUM300LTE5	ARUM320LTE5
	Independent Unit		ARUM180LTE5	ARUM200LTE5
			ARUM120LTE5	ARUM120LTE5
Dimensions(W x H x D)		mm	$(1,240 \times 1,690 \times 760) \times 1 + (930 \times 1,690 \times 760) \times 1$	$(1,240 \times 1,690 \times 760) \times 1 + (930 \times 1,690 \times 760) \times 1$
		inch	$(48-13/16 \times 66-17/32 \times 29-29/32) \times 1 + (36-5/8 \times 66-17/32 \times 29-29/32) \times 1$	$(48-13/16 \times 66-17/32 \times 29-29/32) \times 1 + (36-5/8 \times 66-17/32 \times 29-29/32) \times 1$
Net Weight		kg	$(300 \times 1) + (215 \times 1)$	$(300 \times 1) + (215 \times 1)$
		lbs	$(661 \times 1) + (474 \times 1)$	$(661 \times 1) + (474 \times 1)$
Sound Pressure Level	Cooling	dB(A)	63.1	63.8
	Heating	dB(A)	64.1	65.8
Sound Power Level	Cooling	dB(A)	88.0	89.6
	Heating	dB(A)	88.0	90.5
Protection Devices	High pressure protection		High pressure sensor / High pressure switch	
	Compressor/Fan		Over-heat protection / Fan driver overload protector	
	Inverter		Over-heat protection / Over-current protection	
Communication Cable (VCTF-SB)		No. xmm <sup>2</sup>	2C x 1.0 ~ 1.5	2C x 1.0 ~ 1.5
Refrigerant	Refrigerant name		R410A	R410A
	Precharged Amount	kg	25.5	25.5
		lbs	56.2	56.2
	t-CO <sub>2</sub> eq		53.231	53.231
Control		Electronic Expansion Valve	Electronic Expansion Valve	
Power Supply		V, Ø, Hz	380-400-415, 3, 50/60	380-400-415, 3, 50/60
Running Current	Cooling (Rated)	A	30.60 - 29.07 - 28.02	33.38 - 31.71 - 30.57
	Heating (Max)	A	33.50 - 31.83 - 30.67	38.40 - 36.48 - 35.16
Number of maximum connectable indoor units ***			49(60)	52(64)
<b>Note</b>				
1. Due to our policy of innovation some specifications may be changed without notification.				
2. Wiring cable size must comply with the applicable local and national codes. And "Electric characteristics" chapter should be considered for electrical work and design. Especially the power cable and circuit breaker should be selected in accordance with that.				
3. Sound pressure level is measured on the rated condition in the anechoic rooms by ISO 3745 standard. Sound power level is measured on the rated condition in the reverberation rooms by ISO 3741 standard. Therefore, these values can be increased owing to ambient conditions during operation.				
4. Sound values of combination model are calculated values based on sound results of independent models. Sound values can be increased owing to ambient or installation conditions during operation. Sound values of system [dB(A)] = $10 \cdot \log [10^{A1/10} + \dots + 10^{An/10}]$ , A1~An means sound values of independent models.				
5. Performances are based on the following conditions : <ul style="list-style-type: none"> <li>• *Cooling : Indoor Ambient Temp. 27°CDB / 19°CWB, Outdoor Ambient Temp. 35°CDB / 24°CWB</li> <li>• *Heating : Indoor Ambient Temp. 20°CDB / 15°CWB, Outdoor Ambient Temp. 7°CDB / 6°CWB</li> <li>• Interconnected Pipe Length is 7.5m and difference of Elevation (Outdoor ~ Indoor Unit) is 0m.</li> </ul>				
6. EUROVENT Test Condition : <ul style="list-style-type: none"> <li>• Performance values in this PDB are based on Ceiling concealed duct combination.</li> <li>• Refer to EUROVENT web site(<a href="http://www.eurovent-certification.com">www.eurovent-certification.com</a>) for other indoor unit combination and more detail test conditions.</li> </ul>				
7. *** : The number in parentheses means maximum connectable indoor units in accordance with outdoor units combination (160~200%). The recommended ratio is 130%.				
8. This product contains Fluorinated greenhouse gases.(R410A, GWP(Global warming potential) = 2,087.5)				
9. #1 : Heat Recovery system, #2 : Heat Pump system				

# 1. Specifications

HP			34	36
Model Name	Combination Unit		ARUM340LTE5	ARUM360LTE5
	Independent Unit		ARUM220LTE5	ARUM240LTE5
			ARUM120LTE5	ARUM120LTE5
Capacity	Cooling (Rated)	kW	95.2	100.8
		Btu/h	324,800	343,900
	Heating (Rated.)	kW	95.2	100.8
		Btu/h	324,800	343,900
	Heating (Max.)	kW	107.1	112.1
		Btu/h	365,400	382,300
Input	Cooling (Rated)	kW	23.62	25.12
	Heating (Rated)	kW	21.00	22.74
	Heating (Max.)	kW	25.02	27.06
EER (Rated)			4.03	4.01
COP	Rated capacity		4.53	4.43
	Max. capacity		4.28	4.14
SEER			8.17	8.43
SCOP			4.24	4.55
Exterior	Color		Warm Gray / Dawn Gray	Warm Gray / Dawn Gray
	RAL (Classic)		RAL 7044 / RAL 7037	RAL 7044 / RAL 7037
Heat Exchanger			Wide Louver Plus	Wide Louver Plus
Compressor	Type		Hermetically Sealed Scroll	Hermetically Sealed Scroll
	Piston Displacement	cm <sup>3</sup> /rev	(62.1 × 2) + (43.8 × 1)	62.1 × 3
	Number of Revolution	rev/min	3,600 × 3	3,600 × 3
	Motor Output x Number	W x No.	(5,300 × 2) + (4,200 × 1)	5,300 × 3
	Starting Method		Direct On Line	Direct On Line
Oil Type		FVC68D(PVE)	FVC68D(PVE)	
Fan	Type		Propeller fan	Propeller fan
	Motor Output x Number	W	(900 × 2) + (1,200 × 1)	(900 × 2) + (1,200 × 1)
	Air Flow Rate(High)	m <sup>3</sup> /min	(320 × 1) + (240 × 1)	(320 × 1) + (240 × 1)
		ft <sup>3</sup> /min	(11,301 × 1) + (8,476 × 1)	(11,301 × 1) + (8,476 × 1)
	External Static Pressure (Max, Pa)		DC INVERTER	DC INVERTER
	Drive		80	80
Discharge	Side / Top	TOP	TOP	
Pipe Connections #1	Liquid	mm(inch)	19.05(3/4)	19.05(3/4)
	Low Pressure Gas	mm(inch)	34.9(1-3/8)	41.3(1-5/8)
	High Pressure Gas	mm(inch)	28.58(1-1/8)	28.58(1-1/8)
Pipe Connections #2	Liquid	mm(inch)	19.05(3/4)	19.05(3/4)
	Gas	mm(inch)	34.9(1-3/8)	41.3(1-5/8)

## Note

- Due to our policy of innovation some specifications may be changed without notification.
- Wiring cable size must comply with the applicable local and national codes. And "Electric characteristics" chapter should be considered for electrical work and design. Especially the power cable and circuit breaker should be selected in accordance with that.
- Sound pressure level is measured on the rated condition in the anechoic rooms by ISO 3745 standard.  
Sound power level is measured on the rated condition in the reverberation rooms by ISO 3741 standard.  
Therefore, these values can be increased owing to ambient conditions during operation.
- Sound values of combination model are calculated values based on sound results of independent models.  
Sound values can be increased owing to ambient or installation conditions during operation.  
Sound values of system [dB(A)] = 10\*log [10<sup>A1</sup>(A1/10)+ ... +10<sup>An</sup>(An/10)] , A1~An means sound values of independent models.
- Performances are based on the following conditions :
  - \*Cooling : Indoor Ambient Temp. 27°CDB / 19°CWB, Outdoor Ambient Temp. 35°CDB / 24°CWB
  - \*Heating : Indoor Ambient Temp. 20°CDB / 15°CWB, Outdoor Ambient Temp. 7°CDB / 6°CWB
  - Interconnected Pipe Length is 7.5m and difference of Elevation (Outdoor ~ Indoor Unit) is 0m.
- EUROVENT Test Condition :
  - Performance values in this PDB are based on Ceiling concealed duct combination.
  - Refer to EUROVENT web site([www.eurovent-certification.com](http://www.eurovent-certification.com)) for other indoor unit combination and more detail test conditions.
- \*\*\* : The number in parentheses means maximum connectable indoor units in accordance with outdoor units combination (160~200%).  
The recommended ratio is 130%.
- This product contains Fluorinated greenhouse gases.(R410A, GWP(Global warming potential) = 2,087.5)
- #1 : Heat Recovery system, #2 : Heat Pump system

# 1. Specifications

HP			34	36
Model Name	Combination Unit		ARUM340LTE5	ARUM360LTE5
	Independent Unit		ARUM220LTE5	ARUM240LTE5
			ARUM120LTE5	ARUM120LTE5
Dimensions(W x H x D)		mm	$(1,240 \times 1,690 \times 760) \times 1 + (930 \times 1,690 \times 760) \times 1$	$(1,240 \times 1,690 \times 760) \times 1 + (930 \times 1,690 \times 760) \times 1$
		inch	$(48-13/16 \times 66-17/32 \times 29-29/32) \times 1 + (36-5/8 \times 66-17/32 \times 29-29/32) \times 1$	$(48-13/16 \times 66-17/32 \times 29-29/32) \times 1 + (36-5/8 \times 66-17/32 \times 29-29/32) \times 1$
Net Weight		kg	$(300 \times 1) + (215 \times 1)$	$(310 \times 1) + (215 \times 1)$
		lbs	$(661 \times 1) + (474 \times 1)$	$(683 \times 1) + (474 \times 1)$
Sound Pressure Level	Cooling	dB(A)	65.6	66.0
	Heating	dB(A)	66.6	67.8
Sound Power Level	Cooling	dB(A)	91.4	91.4
	Heating	dB(A)	93.3	93.3
Protection Devices	High pressure protection		High pressure sensor / High pressure switch	
	Compressor/Fan		Over-heat protection / Fan driver overload protector	
	Inverter		Over-heat protection / Over-current protection	
Communication Cable (VCTF-SB)		No. xmm <sup>2</sup>	2C x 1.0 ~ 1.5	2C x 1.0 ~ 1.5
Refrigerant	Refrigerant name		R410A	R410A
	Precharged Amount	kg	25.5	26.5
		lbs	56.2	58.4
	t-CO <sub>2</sub> eq		53.231	55.319
Control		Electronic Expansion Valve	Electronic Expansion Valve	
Power Supply		V, Ø, Hz	380-400-415, 3, 50/60	380-400-415, 3, 50/60
Running Current	Cooling (Rated)	A	38.56 - 36.63 - 35.31	41.02 - 38.97 - 37.56
	Heating (Max)	A	41.80 - 39.71 - 38.27	45.10 - 42.85 - 41.30
Number of maximum connectable indoor units ***			55(64)	58(64)
<b>Note</b>				
1. Due to our policy of innovation some specifications may be changed without notification.				
2. Wiring cable size must comply with the applicable local and national codes. And "Electric characteristics" chapter should be considered for electrical work and design. Especially the power cable and circuit breaker should be selected in accordance with that.				
3. Sound pressure level is measured on the rated condition in the anechoic rooms by ISO 3745 standard. Sound power level is measured on the rated condition in the reverberation rooms by ISO 3741 standard. Therefore, these values can be increased owing to ambient conditions during operation.				
4. Sound values of combination model are calculated values based on sound results of independent models. Sound values can be increased owing to ambient or installation conditions during operation. Sound values of system [dB(A)] = $10 \cdot \log [10^{A1/10} + \dots + 10^{An/10}]$ , A1~An means sound values of independent models.				
5. Performances are based on the following conditions : <ul style="list-style-type: none"> <li>*Cooling : Indoor Ambient Temp. 27°CDB / 19°CWB, Outdoor Ambient Temp. 35°CDB / 24°CWB</li> <li>*Heating : Indoor Ambient Temp. 20°CDB / 15°CWB, Outdoor Ambient Temp. 7°CDB / 6°CWB</li> <li>Interconnected Pipe Length is 7.5m and difference of Elevation (Outdoor ~ Indoor Unit) is 0m.</li> </ul>				
6. EUROVENT Test Condition : <ul style="list-style-type: none"> <li>Performance values in this PDB are based on Ceiling concealed duct combination.</li> <li>Refer to EUROVENT web site(<a href="http://www.eurovent-certification.com">www.eurovent-certification.com</a>) for other indoor unit combination and more detail test conditions.</li> </ul>				
7. *** : The number in parentheses means maximum connectable indoor units in accordance with outdoor units combination (160~200%). The recommended ratio is 130%.				
8. This product contains Fluorinated greenhouse gases.(R410A, GWP(Global warming potential) = 2,087.5)				
9. #1 : Heat Recovery system, #2 : Heat Pump system				

# 1. Specifications

HP			38	40
Model Name	Combination Unit		ARUM380LTE5	ARUM400LTE5
	Independent Unit		ARUM240LTE5	ARUM240LTE5
			ARUM140LTE5	ARUM160LTE5
Capacity	Cooling (Rated)	kW	106.4	112.0
		Btu/h	363,000	382,100
	Heating (Rated.)	kW	106.4	112.0
		Btu/h	363,000	382,100
	Heating (Max.)	kW	118.4	124.7
		Btu/h	403,800	425,300
Input	Cooling (Rated)	kW	26.08	28.31
	Heating (Rated)	kW	24.37	26.17
	Heating (Max.)	kW	28.52	31.19
EER (Rated)			4.08	3.96
COP	Rated capacity		4.37	4.28
	Max. capacity		4.15	4.00
SEER			8.24	8.11
SCOP			4.45	4.53
Exterior	Color		Warm Gray / Dawn Gray	Warm Gray / Dawn Gray
	RAL (Classic)		RAL 7044 / RAL 7037	RAL 7044 / RAL 7037
Heat Exchanger			Wide Louver Plus	Wide Louver Plus
Compressor	Type		Hermetically Sealed Scroll	Hermetically Sealed Scroll
	Piston Displacement	cm <sup>3</sup> /rev	62.1 × 3	62.1 × 3
	Number of Revolution	rev/min	3,600 × 3	3,600 × 3
	Motor Output x Number	W x No.	5,300 × 3	5,300 × 3
	Starting Method		Direct On Line	Direct On Line
Oil Type		FVC68D(PVE)	FVC68D(PVE)	
Fan	Type		Propeller fan	Propeller fan
	Motor Output x Number	W	900 × 4	900 × 4
	Air Flow Rate(High)	m <sup>3</sup> /min	320 × 2	320 × 2
		ft <sup>3</sup> /min	11,301 × 2	11,301 × 2
	External Static Pressure (Max, Pa)		DC INVERTER	DC INVERTER
	Drive		80	80
Discharge	Side / Top	TOP	TOP	
Pipe Connections #1	Liquid	mm(inch)	19.05(3/4)	19.05(3/4)
	Low Pressure Gas	mm(inch)	41.3(1-5/8)	41.3(1-5/8)
	High Pressure Gas	mm(inch)	34.9(1-3/8)	34.9(1-3/8)
Pipe Connections #2	Liquid	mm(inch)	19.05(3/4)	19.05(3/4)
	Gas	mm(inch)	41.3(1-5/8)	41.3(1-5/8)
Dimensions(W x H x D)		mm	(1,240 × 1,690 × 760) × 2	(1,240 × 1,690 × 760) × 2
		inch	(48-13/16 × 66-17/32 × 29-29/32) × 2	(48-13/16 × 66-17/32 × 29-29/32) × 2

## Note

- Due to our policy of innovation some specifications may be changed without notification.
- Wiring cable size must comply with the applicable local and national codes. And "Electric characteristics" chapter should be considered for electrical work and design. Especially the power cable and circuit breaker should be selected in accordance with that.
- Sound pressure level is measured on the rated condition in the anechoic rooms by ISO 3745 standard.  
Sound power level is measured on the rated condition in the reverberation rooms by ISO 3741 standard.  
Therefore, these values can be increased owing to ambient conditions during operation.
- Sound values of combination model are calculated values based on sound results of independent models.  
Sound values can be increased owing to ambient or installation conditions during operation.  
Sound values of system [dB(A)] = 10\*log [10<sup>A1</sup>(A1/10)+ ... +10<sup>An</sup>(An/10)] , A1~An means sound values of independent models.
- Performances are based on the following conditions :
  - \*Cooling : Indoor Ambient Temp. 27°CDB / 19°CWB, Outdoor Ambient Temp. 35°CDB / 24°CWB
  - \*Heating : Indoor Ambient Temp. 20°CDB / 15°CWB, Outdoor Ambient Temp. 7°CDB / 6°CWB
  - Interconnected Pipe Length is 7.5m and difference of Elevation (Outdoor ~ Indoor Unit) is 0m.
- EUROVENT Test Condition :
  - Performance values in this PDB are based on Ceiling concealed duct combination.
  - Refer to EUROVENT web site([www.eurovent-certification.com](http://www.eurovent-certification.com)) for other indoor unit combination and more detail test conditions.
- \*\*\* : The number in parentheses means maximum connectable indoor units in accordance with outdoor units combination (160~200%).  
The recommended ratio is 130%.
- This product contains Fluorinated greenhouse gases.(R410A, GWP(Global warming potential) = 2,087.5)
- #1 : Heat Recovery system, #2 : Heat Pump system

# 1. Specifications

HP			38	40
Model Name	Combination Unit		ARUM380LTE5	ARUM400LTE5
	Independent Unit		ARUM240LTE5	ARUM240LTE5
			ARUM140LTE5	ARUM160LTE5
Net Weight		kg	(310 × 1) + (237 × 1)	(310 × 1) + (237 × 1)
		lbs	(683 × 1) + (522 × 1)	(683 × 1) + (522 × 1)
Sound Pressure Level	Cooling	dB(A)	66.2	66.3
	Heating	dB(A)	68.0	68.1
Sound Power Level	Cooling	dB(A)	91.4	92.0
	Heating	dB(A)	93.3	93.8
Protection Devices	High pressure protection		High pressure sensor / High pressure switch	
	Compressor/Fan		Over-heat protection / Fan driver overload protector	
	Inverter		Over-heat protection / Over-current protection	
Communication Cable (VCTF-SB)	No. × mm <sup>2</sup>		2C × 1.0 ~ 1.5	2C × 1.0 ~ 1.5
Refrigerant	Refrigerant name		R410A	R410A
	Precharged Amount	kg	30.5	30.5
		lbs	67.2	67.2
	t-CO <sub>2</sub> eq		63.669	63.669
Control		Electronic Expansion Valve	Electronic Expansion Valve	
Power Supply	V, Ø, Hz		380-400-415, 3, 50/60	380-400-415, 3, 50/60
Running Current	Cooling (Rated)	A	42.60 - 40.47 - 39.01	46.23 - 43.92 - 42.33
	Heating (Max)	A	46.60 - 44.27 - 42.67	52.00 - 49.40 - 47.61
Number of maximum connectable indoor units ***			61(64)	64

## Note

- Due to our policy of innovation some specifications may be changed without notification.
- Wiring cable size must comply with the applicable local and national codes. And "Electric characteristics" chapter should be considered for electrical work and design. Especially the power cable and circuit breaker should be selected in accordance with that.
- Sound pressure level is measured on the rated condition in the anechoic rooms by ISO 3745 standard.  
Sound power level is measured on the rated condition in the reverberation rooms by ISO 3741 standard.  
Therefore, these values can be increased owing to ambient conditions during operation.
- Sound values of combination model are calculated values based on sound results of independent models.  
Sound values can be increased owing to ambient or installation conditions during operation.  
Sound values of system [dB(A)] =  $10 \cdot \log [10^{(A1/10)} + \dots + 10^{(An/10)}]$ , A1~An means sound values of independent models.
- Performances are based on the following conditions :
  - \*Cooling : Indoor Ambient Temp. 27°CDB / 19°CWB, Outdoor Ambient Temp. 35°CDB / 24°CWB
  - \*Heating : Indoor Ambient Temp. 20°CDB / 15°CWB, Outdoor Ambient Temp. 7°CDB / 6°CWB
  - Interconnected Pipe Length is 7.5m and difference of Elevation (Outdoor ~ Indoor Unit) is 0m.
- EUROVENT Test Condition :
  - Performance values in this PDB are based on Ceiling concealed duct combination.
  - Refer to EUROVENT web site([www.eurovent-certification.com](http://www.eurovent-certification.com)) for other indoor unit combination and more detail test conditions.
- \*\*\* : The number in parentheses means maximum connectable indoor units in accordance with outdoor units combination (160~200%).  
The recommended ratio is 130%.
- This product contains Fluorinated greenhouse gases.(R410A, GWP(Global warming potential) = 2,087.5)
- #1 : Heat Recovery system, #2 : Heat Pump system

# 1. Specifications

HP			42	44
Model Name	Combination Unit		ARUM420LTE5	ARUM440LTE5
	Independent Unit		ARUM240LTE5	ARUM240LTE5
			ARUM180LTE5	ARUM200LTE5
Capacity	Cooling (Rated)	kW	117.6	123.2
		Btu/h	401,300	420,400
	Heating (Rated.)	kW	117.6	123.2
		Btu/h	401,300	420,400
	Heating (Max.)	kW	131.0	137.3
		Btu/h	446,800	468,300
Input	Cooling (Rated)	kW	28.44	30.17
	Heating (Rated)	kW	26.01	28.09
	Heating (Max.)	kW	30.74	33.48
EER (Rated)			4.14	4.08
COP	Rated capacity		4.52	4.39
	Max. capacity		4.26	4.10
SEER			8.07	8.00
SCOP			4.24	4.18
Exterior	Color		Warm Gray / Dawn Gray	Warm Gray / Dawn Gray
	RAL (Classic)		RAL 7044 / RAL 7037	RAL 7044 / RAL 7037
Heat Exchanger			Wide Louver Plus	Wide Louver Plus
Compressor	Type		Hermetically Sealed Scroll	Hermetically Sealed Scroll
	Piston Displacement	cm <sup>3</sup> /rev	(62.1 × 3) + (43.8 × 1)	(62.1 × 3) + (43.8 × 1)
	Number of Revolution	rev/min	3,600 × 4	3,600 × 4
	Motor Output x Number	W x No.	(5,300 × 3) + (4,200 × 1)	(5,300 × 3) + (4,200 × 1)
	Starting Method		Direct On Line	Direct On Line
Oil Type		FVC68D(PVE)	FVC68D(PVE)	
Fan	Type		Propeller fan	Propeller fan
	Motor Output x Number	W	900 × 4	900 × 4
	Air Flow Rate(High)	m <sup>3</sup> /min	320 × 2	320 × 2
		ft <sup>3</sup> /min	11,301 × 2	11,301 × 2
	External Static Pressure (Max, Pa)		DC INVERTER	DC INVERTER
	Drive		80	80
Discharge	Side / Top	TOP	TOP	
Pipe Connections #1	Liquid	mm(inch)	19.05(3/4)	19.05(3/4)
	Low Pressure Gas	mm(inch)	41.3(1-5/8)	41.3(1-5/8)
	High Pressure Gas	mm(inch)	34.9(1-3/8)	34.9(1-3/8)
Pipe Connections #2	Liquid	mm(inch)	19.05(3/4)	19.05(3/4)
	Gas	mm(inch)	41.3(1-5/8)	41.3(1-5/8)
Dimensions(W x H x D)		mm	(1,240 × 1,690 × 760) × 2	(1,240 × 1,690 × 760) × 2
		inch	(48-13/16 × 66-17/32 × 29-29/32) × 2	(48-13/16 × 66-17/32 × 29-29/32) × 2

## Note

- Due to our policy of innovation some specifications may be changed without notification.
- Wiring cable size must comply with the applicable local and national codes. And "Electric characteristics" chapter should be considered for electrical work and design. Especially the power cable and circuit breaker should be selected in accordance with that.
- Sound pressure level is measured on the rated condition in the anechoic rooms by ISO 3745 standard.  
Sound power level is measured on the rated condition in the reverberation rooms by ISO 3741 standard.  
Therefore, these values can be increased owing to ambient conditions during operation.
- Sound values of combination model are calculated values based on sound results of independent models.  
Sound values can be increased owing to ambient or installation conditions during operation.  
Sound values of system [dB(A)] = 10\*log [10<sup>A1</sup>(A1/10)+ ... +10<sup>An</sup>(An/10)] , A1~An means sound values of independent models.
- Performances are based on the following conditions :
  - \*Cooling : Indoor Ambient Temp. 27°CDB / 19°CWB, Outdoor Ambient Temp. 35°CDB / 24°CWB
  - \*Heating : Indoor Ambient Temp. 20°CDB / 15°CWB, Outdoor Ambient Temp. 7°CDB / 6°CWB
  - Interconnected Pipe Length is 7.5m and difference of Elevation (Outdoor ~ Indoor Unit) is 0m.
- EUROVENT Test Condition :
  - Performance values in this PDB are based on Ceiling concealed duct combination.
  - Refer to EUROVENT web site([www.eurovent-certification.com](http://www.eurovent-certification.com)) for other indoor unit combination and more detail test conditions.
- \*\*\* : The number in parentheses means maximum connectable indoor units in accordance with outdoor units combination (160~200%).  
The recommended ratio is 130%.
- This product contains Fluorinated greenhouse gases.(R410A, GWP(Global warming potential) = 2,087.5)
- #1 : Heat Recovery system, #2 : Heat Pump system

# 1. Specifications

HP			42	44
Model Name	Combination Unit		ARUM420LTE5	ARUM440LTE5
	Independent Unit		ARUM240LTE5	ARUM240LTE5
			ARUM180LTE5	ARUM200LTE5
Net Weight		kg	(310 × 1) + (300 × 1)	(310 × 1) + (300 × 1)
		lbs	(683 × 1) + (661 × 1)	(683 × 1) + (661 × 1)
Sound Pressure Level	Cooling	dB(A)	66.5	66.8
	Heating	dB(A)	68.2	68.9
Sound Power Level	Cooling	dB(A)	92.5	93.1
	Heating	dB(A)	94.0	94.8
Protection Devices	High pressure protection		High pressure sensor / High pressure switch	
	Compressor/Fan		Over-heat protection / Fan driver overload protector	
	Inverter		Over-heat protection / Over-current protection	
Communication Cable (VCTF-SB)	No. × mm <sup>2</sup>		2C × 1.0 ~ 1.5	2C × 1.0 ~ 1.5
Refrigerant	Refrigerant name		R410A	R410A
	Precharged Amount	kg	33.0	33.0
		lbs	72.8	72.8
	t-CO <sub>2</sub> eq		68.888	68.888
Control		Electronic Expansion Valve	Electronic Expansion Valve	
Power Supply	V, Ø, Hz		380-400-415, 3, 50/60	380-400-415, 3, 50/60
Running Current	Cooling (Rated)	A	46.51 - 44.19 - 42.59	49.29 - 46.83 - 45.13
	Heating (Max)	A	49.80 - 47.31 - 45.60	54.70 - 51.97 - 50.09
Number of maximum connectable indoor units ***			64	64

### Note

- Due to our policy of innovation some specifications may be changed without notification.
- Wiring cable size must comply with the applicable local and national codes. And "Electric characteristics" chapter should be considered for electrical work and design. Especially the power cable and circuit breaker should be selected in accordance with that.
- Sound pressure level is measured on the rated condition in the anechoic rooms by ISO 3745 standard.  
Sound power level is measured on the rated condition in the reverberation rooms by ISO 3741 standard.  
Therefore, these values can be increased owing to ambient conditions during operation.
- Sound values of combination model are calculated values based on sound results of independent models.  
Sound values can be increased owing to ambient or installation conditions during operation.  
Sound values of system [dB(A)] =  $10 \cdot \log [10^{(A1/10)} + \dots + 10^{(An/10)}]$ , A1~An means sound values of independent models.
- Performances are based on the following conditions :
  - \*Cooling : Indoor Ambient Temp. 27°CDB / 19°CWB, Outdoor Ambient Temp. 35°CDB / 24°CWB
  - \*Heating : Indoor Ambient Temp. 20°CDB / 15°CWB, Outdoor Ambient Temp. 7°CDB / 6°CWB
  - Interconnected Pipe Length is 7.5m and difference of Elevation (Outdoor ~ Indoor Unit) is 0m.
- EUROVENT Test Condition :
  - Performance values in this PDB are based on Ceiling concealed duct combination.
  - Refer to EUROVENT web site([www.eurovent-certification.com](http://www.eurovent-certification.com)) for other indoor unit combination and more detail test conditions.
- \*\*\* : The number in parentheses means maximum connectable indoor units in accordance with outdoor units combination (160~200%).  
The recommended ratio is 130%.
- This product contains Fluorinated greenhouse gases.(R410A, GWP(Global warming potential) = 2,087.5)
- #1 : Heat Recovery system, #2 : Heat Pump system

# 1. Specifications

HP			46	48
Model Name	Combination Unit		ARUM460LTE5	ARUM480LTE5
	Independent Unit		ARUM240LTE5	ARUM240LTE5
			ARUM220LTE5	ARUM240LTE5
Capacity	Cooling (Rated)	kW	128.8	134.4
		Btu/h	439,500	458,600
	Heating (Rated.)	kW	128.8	134.4
		Btu/h	439,500	458,600
	Heating (Max.)	kW	143.6	148.5
		Btu/h	489,800	506,700
Input	Cooling (Rated)	kW	33.33	34.82
	Heating (Rated)	kW	30.04	31.78
	Heating (Max.)	kW	35.56	37.60
EER (Rated)			3.86	3.86
COP	Rated capacity		4.29	4.23
	Max. capacity		4.04	3.95
SEER			7.73	7.92
SCOP			4.13	4.36
Exterior	Color		Warm Gray / Dawn Gray	Warm Gray / Dawn Gray
	RAL (Classic)		RAL 7044 / RAL 7037	RAL 7044 / RAL 7037
Heat Exchanger			Wide Louver Plus	Wide Louver Plus
Compressor	Type		Hermetically Sealed Scroll	Hermetically Sealed Scroll
	Piston Displacement	cm <sup>3</sup> /rev	(62.1 × 3) + (43.8 × 1)	62.1 × 4
	Number of Revolution	rev/min	3,600 × 4	3,600 × 4
	Motor Output x Number	W x No.	(5,300 × 3) + (4,200 × 1)	5,300 × 4
	Starting Method		Direct On Line	Direct On Line
Oil Type		FVC68D(PVE)	FVC68D(PVE)	
Fan	Type		Propeller fan	Propeller fan
	Motor Output x Number	W	900 × 4	900 × 4
	Air Flow Rate(High)	m <sup>3</sup> /min	320 × 2	320 × 2
		ft <sup>3</sup> /min	11,301 × 2	11,301 × 2
	External Static Pressure (Max, Pa)		DC INVERTER	DC INVERTER
	Drive		80	80
Discharge	Side / Top	TOP	TOP	
Pipe Connections #1	Liquid	mm(inch)	19.05(3/4)	19.05(3/4)
	Low Pressure Gas	mm(inch)	41.3(1-5/8)	41.3(1-5/8)
	High Pressure Gas	mm(inch)	34.9(1-3/8)	34.9(1-3/8)
Pipe Connections #2	Liquid	mm(inch)	19.05(3/4)	19.05(3/4)
	Gas	mm(inch)	41.3(1-5/8)	41.3(1-5/8)
Dimensions(W x H x D)		mm	(1,240 × 1,690 × 760) × 2	(1,240 × 1,690 × 760) × 2
		inch	(48-13/16 × 66-17/32 × 29-29/32) × 2	(48-13/16 × 66-17/32 × 29-29/32) × 2

## Note

- Due to our policy of innovation some specifications may be changed without notification.
- Wiring cable size must comply with the applicable local and national codes. And "Electric characteristics" chapter should be considered for electrical work and design. Especially the power cable and circuit breaker should be selected in accordance with that.
- Sound pressure level is measured on the rated condition in the anechoic rooms by ISO 3745 standard.  
Sound power level is measured on the rated condition in the reverberation rooms by ISO 3741 standard.  
Therefore, these values can be increased owing to ambient conditions during operation.
- Sound values of combination model are calculated values based on sound results of independent models.  
Sound values can be increased owing to ambient or installation conditions during operation.  
Sound values of system [dB(A)] =  $10 \cdot \log [10^{A_1/10} + \dots + 10^{A_n/10}]$ , A<sub>1</sub>~A<sub>n</sub> means sound values of independent models.
- Performances are based on the following conditions :
  - \*Cooling : Indoor Ambient Temp. 27°CDB / 19°CWB, Outdoor Ambient Temp. 35°CDB / 24°CWB
  - \*Heating : Indoor Ambient Temp. 20°CDB / 15°CWB, Outdoor Ambient Temp. 7°CDB / 6°CWB
  - Interconnected Pipe Length is 7.5m and difference of Elevation (Outdoor ~ Indoor Unit) is 0m.
- EUROVENT Test Condition :
  - Performance values in this PDB are based on Ceiling concealed duct combination.
  - Refer to EUROVENT web site([www.eurovent-certification.com](http://www.eurovent-certification.com)) for other indoor unit combination and more detail test conditions.
- \*\*\* : The number in parentheses means maximum connectable indoor units in accordance with outdoor units combination (160~200%).  
The recommended ratio is 130%.
- This product contains Fluorinated greenhouse gases.(R410A, GWP(Global warming potential) = 2,087.5)
- #1 : Heat Recovery system, #2 : Heat Pump system



# 1. Specifications

HP			46	48
Model Name	Combination Unit		ARUM460LTE5	ARUM480LTE5
	Independent Unit		ARUM240LTE5	ARUM240LTE5
			ARUM220LTE5	ARUM240LTE5
Net Weight		kg	(310 × 1) + (300 × 1)	310 × 2
		lbs	(683 × 1) + (661 × 1)	683 × 2
Sound Pressure Level	Cooling	dB(A)	67.8	68.0
	Heating	dB(A)	69.3	70.0
Sound Power Level	Cooling	dB(A)	94.0	94.0
	Heating	dB(A)	96.0	96.0
Protection Devices	High pressure protection		High pressure sensor / High pressure switch	
	Compressor/Fan		Over-heat protection / Fan driver overload protector	
	Inverter		Over-heat protection / Over-current protection	
Communication Cable (VCTF-SB)	No. × mm <sup>2</sup>		2C × 1.0 ~ 1.5	2C × 1.0 ~ 1.5
Refrigerant	Refrigerant name		R410A	R410A
	Precharged Amount	kg	33.0	34.0
		lbs	72.8	75.0
	t-CO <sub>2</sub> eq		68.888	70.975
Control		Electronic Expansion Valve	Electronic Expansion Valve	
Power Supply	V, Ø, Hz		380-400-415, 3, 50/60	380-400-415, 3, 50/60
Running Current	Cooling (Rated)	A	54.47 - 51.75 - 49.88	56.93 - 54.09 - 52.13
	Heating (Max)	A	58.10 - 55.20 - 53.20	61.40 - 58.33 - 56.22
Number of maximum connectable indoor units ***			64	64

### Note

- Due to our policy of innovation some specifications may be changed without notification.
- Wiring cable size must comply with the applicable local and national codes. And "Electric characteristics" chapter should be considered for electrical work and design. Especially the power cable and circuit breaker should be selected in accordance with that.
- Sound pressure level is measured on the rated condition in the anechoic rooms by ISO 3745 standard.  
Sound power level is measured on the rated condition in the reverberation rooms by ISO 3741 standard.  
Therefore, these values can be increased owing to ambient conditions during operation.
- Sound values of combination model are calculated values based on sound results of independent models.  
Sound values can be increased owing to ambient or installation conditions during operation.  
Sound values of system [dB(A)] =  $10 \cdot \log [10^{(A1/10)} + \dots + 10^{(An/10)}]$ , A1~An means sound values of independent models.
- Performances are based on the following conditions :
  - \*Cooling : Indoor Ambient Temp. 27°CDB / 19°CWB, Outdoor Ambient Temp. 35°CDB / 24°CWB
  - \*Heating : Indoor Ambient Temp. 20°CDB / 15°CWB, Outdoor Ambient Temp. 7°CDB / 6°CWB
  - Interconnected Pipe Length is 7.5m and difference of Elevation (Outdoor ~ Indoor Unit) is 0m.
- EUROVENT Test Condition :
  - Performance values in this PDB are based on Ceiling concealed duct combination.
  - Refer to EUROVENT web site([www.eurovent-certification.com](http://www.eurovent-certification.com)) for other indoor unit combination and more detail test conditions.
- \*\*\* : The number in parentheses means maximum connectable indoor units in accordance with outdoor units combination (160~200%).  
The recommended ratio is 130%.
- This product contains Fluorinated greenhouse gases.(R410A, GWP(Global warming potential) = 2,087.5)
- #1 : Heat Recovery system, #2 : Heat Pump system

# 1. Specifications

HP			50	52
Model Name	Combination Unit		ARUM500LTE5	ARUM520LTE5
	Independent Unit		ARUM240LTE5	ARUM240LTE5
			ARUM140LTE5	ARUM160LTE5
			ARUM120LTE5	ARUM120LTE5
Capacity	Cooling (Rated)	kW	140.0	145.6
		Btu/h	477,700	496,800
	Heating (Rated.)	kW	140.0	145.6
		Btu/h	477,700	496,800
	Heating (Max.)	kW	156.2	162.5
		Btu/h	532,800	554,300
Input	Cooling (Rated)	kW	33.79	36.02
	Heating (Rated)	kW	31.22	33.02
	Heating (Max.)	kW	36.78	39.45
EER (Rated)			4.14	4.04
COP	Rated capacity		4.48	4.41
	Max. capacity		4.25	4.12
SEER			8.57	8.46
SCOP			4.58	4.64
Exterior	Color		Warm Gray / Dawn Gray	Warm Gray / Dawn Gray
	RAL (Classic)		RAL 7044 / RAL 7037	RAL 7044 / RAL 7037
Heat Exchanger			Wide Louver Plus	Wide Louver Plus
Compressor	Type		Hermetically Sealed Scroll	Hermetically Sealed Scroll
	Piston Displacement	cm <sup>3</sup> /rev	62.1 × 4	62.1 × 4
	Number of Revolution	rev/min	3,600 × 4	3,600 × 4
	Motor Output x Number	W x No.	5,300 × 4	5,300 × 4
	Starting Method		Direct On Line	Direct On Line
	Oil Type		FVC68D(PVE)	FVC68D(PVE)
Fan	Type		Propeller fan	Propeller fan
	Motor Output x Number	W	(900 × 4) + (1,200 × 1)	(900 × 4) + (1,200 × 1)
	Air Flow Rate(High)	m <sup>3</sup> /min	(320 × 2) + (240 × 1)	(320 × 2) + (240 × 1)
		ft <sup>3</sup> /min	(11,301 × 2) + (8,476 × 1)	(11,301 × 2) + (8,476 × 1)
	External Static Pressure (Max, Pa)		DC INVERTER	DC INVERTER
	Drive		80	80
Discharge	Side / Top	TOP	TOP	
Pipe Connections #1	Liquid	mm(inch)	19.05(3/4)	19.05(3/4)
	Low Pressure Gas	mm(inch)	41.3(1-5/8)	41.3(1-5/8)
	High Pressure Gas	mm(inch)	34.9(1-3/8)	34.9(1-3/8)
Pipe Connections #2	Liquid	mm(inch)	19.05(3/4)	19.05(3/4)
	Gas	mm(inch)	41.3(1-5/8)	41.3(1-5/8)

## Note

- Due to our policy of innovation some specifications may be changed without notification.
- Wiring cable size must comply with the applicable local and national codes. And "Electric characteristics" chapter should be considered for electrical work and design. Especially the power cable and circuit breaker should be selected in accordance with that.
- Sound pressure level is measured on the rated condition in the anechoic rooms by ISO 3745 standard.  
Sound power level is measured on the rated condition in the reverberation rooms by ISO 3741 standard.  
Therefore, these values can be increased owing to ambient conditions during operation.
- Sound values of combination model are calculated values based on sound results of independent models.  
Sound values can be increased owing to ambient or installation conditions during operation.  
Sound values of system [dB(A)] = 10\*log [10<sup>A1</sup>(A1/10)+ ... +10<sup>An</sup>(An/10)] , A1~An means sound values of independent models.
- Performances are based on the following conditions :
  - \*Cooling : Indoor Ambient Temp. 27°CDB / 19°CWB, Outdoor Ambient Temp. 35°CDB / 24°CWB
  - \*Heating : Indoor Ambient Temp. 20°CDB / 15°CWB, Outdoor Ambient Temp. 7°CDB / 6°CWB
  - Interconnected Pipe Length is 7.5m and difference of Elevation (Outdoor ~ Indoor Unit) is 0m.
- EUROVENT Test Condition :
  - Performance values in this PDB are based on Ceiling concealed duct combination.
  - Refer to EUROVENT web site([www.eurovent-certification.com](http://www.eurovent-certification.com)) for other indoor unit combination and more detail test conditions.
- \*\*\* : The number in parentheses means maximum connectable indoor units in accordance with outdoor units combination (160~200%).  
The recommended ratio is 130%.
- This product contains Fluorinated greenhouse gases.(R410A, GWP(Global warming potential) = 2,087.5)
- #1 : Heat Recovery system, #2 : Heat Pump system

# 1. Specifications

HP			50	52
Model Name	Combination Unit		ARUM500LTE5	ARUM520LTE5
	Independent Unit		ARUM240LTE5	ARUM240LTE5
			ARUM140LTE5	ARUM160LTE5
			ARUM120LTE5	ARUM120LTE5
Dimensions(W x H x D)		mm	$(1,240 \times 1,690 \times 760) \times 2 + (930 \times 1,690 \times 760) \times 1$	$(1,240 \times 1,690 \times 760) \times 2 + (930 \times 1,690 \times 760) \times 1$
		inch	$(48-13/16 \times 66-17/32 \times 29-29/32) \times 2 + (36-5/8 \times 66-17/32 \times 29-29/32) \times 1$	$(48-13/16 \times 66-17/32 \times 29-29/32) \times 2 + (36-5/8 \times 66-17/32 \times 29-29/32) \times 1$
Net Weight		kg	$(310 \times 1) + (237 \times 1) + (215 \times 1)$	$(310 \times 1) + (237 \times 1) + (215 \times 1)$
		lbs	$(683 \times 1) + (522 \times 1) + (474 \times 1)$	$(683 \times 1) + (522 \times 1) + (474 \times 1)$
Sound Pressure Level	Cooling	dB(A)	67.0	67.1
	Heating	dB(A)	68.6	68.7
Sound Power Level	Cooling	dB(A)	91.8	92.3
	Heating	dB(A)	93.6	94.0
Protection Devices	High pressure protection		High pressure sensor / High pressure switch	
	Compressor/Fan		Over-heat protection / Fan driver overload protector	
	Inverter		Over-heat protection / Over-current protection	
Communication Cable (VCTF-SB)		No. xmm <sup>2</sup>	2C x 1.0 ~ 1.5	2C x 1.0 ~ 1.5
Refrigerant	Refrigerant name		R410A	R410A
	Precharged Amount	kg	40.0	40.0
		lbs	88.2	88.2
	t-CO <sub>2</sub> eq		83.500	83.500
Control		Electronic Expansion Valve	Electronic Expansion Valve	
Power Supply		V, Ø, Hz	380-400-415, 3, 50/60	380-400-415, 3, 50/60
Running Current	Cooling (Rated)	A	55.21 - 52.45 - 50.55	58.84 - 55.90 - 53.88
	Heating (Max)	A	61.10 - 58.05 - 55.95	66.40 - 63.08 - 60.80
Number of maximum connectable indoor units ***			64	64

### Note

- Due to our policy of innovation some specifications may be changed without notification.
- Wiring cable size must comply with the applicable local and national codes. And "Electric characteristics" chapter should be considered for electrical work and design. Especially the power cable and circuit breaker should be selected in accordance with that.
- Sound pressure level is measured on the rated condition in the anechoic rooms by ISO 3745 standard.  
Sound power level is measured on the rated condition in the reverberation rooms by ISO 3741 standard.  
Therefore, these values can be increased owing to ambient conditions during operation.
- Sound values of combination model are calculated values based on sound results of independent models.  
Sound values can be increased owing to ambient or installation conditions during operation.  
Sound values of system [dB(A)] =  $10 \cdot \log [10^{A1/10} + \dots + 10^{An/10}]$ , A1~An means sound values of independent models.
- Performances are based on the following conditions :
  - \*Cooling : Indoor Ambient Temp. 27°CDB / 19°CWB, Outdoor Ambient Temp. 35°CDB / 24°CWB
  - \*Heating : Indoor Ambient Temp. 20°CDB / 15°CWB, Outdoor Ambient Temp. 7°CDB / 6°CWB
  - Interconnected Pipe Length is 7.5m and difference of Elevation (Outdoor ~ Indoor Unit) is 0m.
- EUROVENT Test Condition :
  - Performance values in this PDB are based on Ceiling concealed duct combination.
  - Refer to EUROVENT web site([www.eurovent-certification.com](http://www.eurovent-certification.com)) for other indoor unit combination and more detail test conditions.
- \*\*\* : The number in parentheses means maximum connectable indoor units in accordance with outdoor units combination (160~200%).  
The recommended ratio is 130%.
- This product contains Fluorinated greenhouse gases.(R410A, GWP(Global warming potential) = 2,087.5)
- #1 : Heat Recovery system, #2 : Heat Pump system

# 1. Specifications

HP			54	56
Model Name	Combination Unit		ARUM540LTE5	ARUM560LTE5
	Independent Unit		ARUM240LTE5	ARUM240LTE5
			ARUM180LTE5	ARUM200LTE5
			ARUM120LTE5	ARUM120LTE5
Capacity	Cooling (Rated)	kW	151.2	156.8
		Btu/h	515,900	535,000
	Heating (Rated.)	kW	151.2	156.8
		Btu/h	515,900	535,000
	Heating (Max.)	kW	168.8	175.1
		Btu/h	575,800	597,300
Input	Cooling (Rated)	kW	36.14	37.87
	Heating (Rated)	kW	32.86	34.94
	Heating (Max.)	kW	39.00	41.74
EER (Rated)			4.18	4.14
COP	Rated capacity		4.60	4.49
	Max. capacity		4.33	4.19
SEER			8.40	8.33
SCOP			4.42	4.34
Exterior	Color		Warm Gray / Dawn Gray	Warm Gray / Dawn Gray
	RAL (Classic)		RAL 7044 / RAL 7037	RAL 7044 / RAL 7037
Heat Exchanger			Wide Louver Plus	Wide Louver Plus
Compressor	Type		Hermetically Sealed Scroll	Hermetically Sealed Scroll
	Piston Displacement	cm <sup>3</sup> /rev	(62.1 × 4) + (43.8 × 1)	(62.1 × 4) + (43.8 × 1)
	Number of Revolution	rev/min	3,600 × 5	3,600 × 5
	Motor Output x Number	W x No.	(5,300 × 4) + (4,200 × 1)	(5,300 × 4) + (4,200 × 1)
	Starting Method		Direct On Line	Direct On Line
Oil Type		FVC68D(PVE)	FVC68D(PVE)	
Fan	Type		Propeller fan	Propeller fan
	Motor Output x Number	W	(900 × 4) + (1,200 × 1)	(900 × 4) + (1,200 × 1)
	Air Flow Rate(High)	m <sup>3</sup> /min	(320 × 2) + (240 × 1)	(320 × 2) + (240 × 1)
		ft <sup>3</sup> /min	(11,301 × 2) + (8,476 × 1)	(11,301 × 2) + (8,476 × 1)
	External Static Pressure (Max, Pa)		DC INVERTER	DC INVERTER
	Drive		80	80
Discharge	Side / Top	TOP	TOP	
Pipe Connections #1	Liquid	mm(inch)	19.05(3/4)	19.05(3/4)
	Low Pressure Gas	mm(inch)	41.3(1-5/8)	41.3(1-5/8)
	High Pressure Gas	mm(inch)	34.9(1-3/8)	34.9(1-3/8)
Pipe Connections #2	Liquid	mm(inch)	19.05(3/4)	19.05(3/4)
	Gas	mm(inch)	41.3(1-5/8)	41.3(1-5/8)

## Note

- Due to our policy of innovation some specifications may be changed without notification.
- Wiring cable size must comply with the applicable local and national codes. And "Electric characteristics" chapter should be considered for electrical work and design. Especially the power cable and circuit breaker should be selected in accordance with that.
- Sound pressure level is measured on the rated condition in the anechoic rooms by ISO 3745 standard.  
Sound power level is measured on the rated condition in the reverberation rooms by ISO 3741 standard.  
Therefore, these values can be increased owing to ambient conditions during operation.
- Sound values of combination model are calculated values based on sound results of independent models.  
Sound values can be increased owing to ambient or installation conditions during operation.  
Sound values of system [dB(A)] = 10\*log [10<sup>A1</sup>(A1/10)+ ... +10<sup>An</sup>(An/10)] , A1~An means sound values of independent models.
- Performances are based on the following conditions :
  - \*Cooling : Indoor Ambient Temp. 27°CDB / 19°CWB, Outdoor Ambient Temp. 35°CDB / 24°CWB
  - \*Heating : Indoor Ambient Temp. 20°CDB / 15°CWB, Outdoor Ambient Temp. 7°CDB / 6°CWB
  - Interconnected Pipe Length is 7.5m and difference of Elevation (Outdoor ~ Indoor Unit) is 0m.
- EUROVENT Test Condition :
  - Performance values in this PDB are based on Ceiling concealed duct combination.
  - Refer to EUROVENT web site([www.eurovent-certification.com](http://www.eurovent-certification.com)) for other indoor unit combination and more detail test conditions.
- \*\*\* : The number in parentheses means maximum connectable indoor units in accordance with outdoor units combination (160~200%).  
The recommended ratio is 130%.
- This product contains Fluorinated greenhouse gases.(R410A, GWP(Global warming potential) = 2,087.5)
- #1 : Heat Recovery system, #2 : Heat Pump system

# 1. Specifications

HP			54	56
Model Name	Combination Unit		ARUM540LTE5	ARUM560LTE5
	Independent Unit		ARUM240LTE5	ARUM240LTE5
			ARUM180LTE5	ARUM200LTE5
			ARUM120LTE5	ARUM120LTE5
Dimensions(W x H x D)		mm	$(1,240 \times 1,690 \times 760) \times 2 + (930 \times 1,690 \times 760) \times 1$	$(1,240 \times 1,690 \times 760) \times 2 + (930 \times 1,690 \times 760) \times 1$
		inch	$(48-13/16 \times 66-17/32 \times 29-29/32) \times 2 + (36-5/8 \times 66-17/32 \times 29-29/32) \times 1$	$(48-13/16 \times 66-17/32 \times 29-29/32) \times 2 + (36-5/8 \times 66-17/32 \times 29-29/32) \times 1$
Net Weight		kg	$(310 \times 1) + (300 \times 1) + (215 \times 1)$	$(310 \times 1) + (300 \times 1) + (215 \times 1)$
		lbs	$(683 \times 1) + (661 \times 1) + (474 \times 1)$	$(683 \times 1) + (661 \times 1) + (474 \times 1)$
Sound Pressure Level	Cooling	dB(A)	67.2	67.4
	Heating	dB(A)	68.8	69.5
Sound Power Level	Cooling	dB(A)	92.8	93.4
	Heating	dB(A)	94.2	94.9
Protection Devices	High pressure protection		High pressure sensor / High pressure switch	
	Compressor/Fan		Over-heat protection / Fan driver overload protector	
	Inverter		Over-heat protection / Over-current protection	
Communication Cable (VCTF-SB)		No. xmm <sup>2</sup>	2C x 1.0 ~ 1.5	2C x 1.0 ~ 1.5
Refrigerant	Refrigerant name		R410A	R410A
	Precharged Amount	kg	42.5	42.5
		lbs	93.7	93.7
	t-CO <sub>2</sub> eq		88.719	88.719
Control		Electronic Expansion Valve	Electronic Expansion Valve	
Power Supply		V, Ø, Hz	380-400-415, 3, 50/60	380-400-415, 3, 50/60
Running Current	Cooling (Rated)	A	59.02 - 56.06 - 54.04	61.90 - 58.81 - 56.68
	Heating (Max)	A	64.20 - 60.99 - 58.79	69.10 - 65.65 - 63.27
Number of maximum connectable indoor units ***			64	64

### Note

- Due to our policy of innovation some specifications may be changed without notification.
- Wiring cable size must comply with the applicable local and national codes. And "Electric characteristics" chapter should be considered for electrical work and design. Especially the power cable and circuit breaker should be selected in accordance with that.
- Sound pressure level is measured on the rated condition in the anechoic rooms by ISO 3745 standard.  
Sound power level is measured on the rated condition in the reverberation rooms by ISO 3741 standard.  
Therefore, these values can be increased owing to ambient conditions during operation.
- Sound values of combination model are calculated values based on sound results of independent models.  
Sound values can be increased owing to ambient or installation conditions during operation.  
Sound values of system [dB(A)] =  $10 \cdot \log [10^{A1/10} + \dots + 10^{An/10}]$ , A1~An means sound values of independent models.
- Performances are based on the following conditions :
  - \*Cooling : Indoor Ambient Temp. 27°CDB / 19°CWB, Outdoor Ambient Temp. 35°CDB / 24°CWB
  - \*Heating : Indoor Ambient Temp. 20°CDB / 15°CWB, Outdoor Ambient Temp. 7°CDB / 6°CWB
  - Interconnected Pipe Length is 7.5m and difference of Elevation (Outdoor ~ Indoor Unit) is 0m.
- EUROVENT Test Condition :
  - Performance values in this PDB are based on Ceiling concealed duct combination.
  - Refer to EUROVENT web site([www.eurovent-certification.com](http://www.eurovent-certification.com)) for other indoor unit combination and more detail test conditions.
- \*\*\* : The number in parentheses means maximum connectable indoor units in accordance with outdoor units combination (160~200%).  
The recommended ratio is 130%.
- This product contains Fluorinated greenhouse gases.(R410A, GWP(Global warming potential) = 2,087.5)
- #1 : Heat Recovery system, #2 : Heat Pump system

# 1. Specifications

HP			58	60
Model Name	Combination Unit		ARUM580LTE5	ARUM600LTE5
	Independent Unit		ARUM240LTE5	ARUM240LTE5
			ARUM220LTE5	ARUM240LTE5
			ARUM120LTE5	ARUM120LTE5
Capacity	Cooling (Rated)	kW	162.4	168.0
		Btu/h	554,100	573,200
	Heating (Rated.)	kW	162.4	168.0
		Btu/h	554,100	573,200
	Heating (Max.)	kW	181.4	186.3
		Btu/h	618,800	635,700
Input	Cooling (Rated)	kW	41.03	42.53
	Heating (Rated)	kW	36.89	38.63
	Heating (Max.)	kW	43.82	45.86
EER (Rated)			3.96	3.95
COP	Rated capacity		4.40	4.35
	Max. capacity		4.14	4.06
SEER			8.08	8.24
SCOP			4.29	4.47
Exterior	Color		Warm Gray / Dawn Gray	Warm Gray / Dawn Gray
	RAL (Classic)		RAL 7044 / RAL 7037	RAL 7044 / RAL 7037
Heat Exchanger			Wide Louver Plus	Wide Louver Plus
Compressor	Type		Hermetically Sealed Scroll	Hermetically Sealed Scroll
	Piston Displacement	cm <sup>3</sup> /rev	(62.1 × 4) + (43.8 × 1)	62.1 × 5
	Number of Revolution	rev/min	3,600 × 5	3,600 × 5
	Motor Output x Number	W x No.	(5,300 × 4) + (4,200 × 1)	5,300 × 5
	Starting Method		Direct On Line	Direct On Line
Oil Type		FVC68D(PVE)	FVC68D(PVE)	
Fan	Type		Propeller fan	Propeller fan
	Motor Output x Number	W	(900 × 4) + (1,200 × 1)	(900 × 4) + (1,200 × 1)
	Air Flow Rate(High)	m <sup>3</sup> /min	(320 × 2) + (240 × 1)	(320 × 2) + (240 × 1)
		ft <sup>3</sup> /min	(11,301 × 2) + (8,476 × 1)	(11,301 × 2) + (8,476 × 1)
	External Static Pressure (Max, Pa)		DC INVERTER	DC INVERTER
	Drive		80	80
Discharge	Side / Top	TOP	TOP	
Pipe Connections #1	Liquid	mm(inch)	19.05(3/4)	19.05(3/4)
	Low Pressure Gas	mm(inch)	41.3(1-5/8)	41.3(1-5/8)
	High Pressure Gas	mm(inch)	34.9(1-3/8)	34.9(1-3/8)
Pipe Connections #2	Liquid	mm(inch)	19.05(3/4)	19.05(3/4)
	Gas	mm(inch)	41.3(1-5/8)	41.3(1-5/8)

## Note

- Due to our policy of innovation some specifications may be changed without notification.
- Wiring cable size must comply with the applicable local and national codes. And "Electric characteristics" chapter should be considered for electrical work and design. Especially the power cable and circuit breaker should be selected in accordance with that.
- Sound pressure level is measured on the rated condition in the anechoic rooms by ISO 3745 standard.  
Sound power level is measured on the rated condition in the reverberation rooms by ISO 3741 standard.  
Therefore, these values can be increased owing to ambient conditions during operation.
- Sound values of combination model are calculated values based on sound results of independent models.  
Sound values can be increased owing to ambient or installation conditions during operation.  
Sound values of system [dB(A)] = 10\*log [10<sup>A1</sup>(A1/10)+ ... +10<sup>An</sup>(An/10)] , A1~An means sound values of independent models.
- Performances are based on the following conditions :
  - \*Cooling : Indoor Ambient Temp. 27°CDB / 19°CWB, Outdoor Ambient Temp. 35°CDB / 24°CWB
  - \*Heating : Indoor Ambient Temp. 20°CDB / 15°CWB, Outdoor Ambient Temp. 7°CDB / 6°CWB
  - Interconnected Pipe Length is 7.5m and difference of Elevation (Outdoor ~ Indoor Unit) is 0m.
- EUROVENT Test Condition :
  - Performance values in this PDB are based on Ceiling concealed duct combination.
  - Refer to EUROVENT web site([www.eurovent-certification.com](http://www.eurovent-certification.com)) for other indoor unit combination and more detail test conditions.
- \*\*\* : The number in parentheses means maximum connectable indoor units in accordance with outdoor units combination (160~200%).  
The recommended ratio is 130%.
- This product contains Fluorinated greenhouse gases.(R410A, GWP(Global warming potential) = 2,087.5)
- #1 : Heat Recovery system, #2 : Heat Pump system

# 1. Specifications

HP			58	60
Model Name	Combination Unit		ARUM580LTE5	ARUM600LTE5
	Independent Unit		ARUM240LTE5	ARUM240LTE5
			ARUM220LTE5	ARUM240LTE5
			ARUM120LTE5	ARUM120LTE5
Dimensions(W x H x D)		mm	$(1,240 \times 1,690 \times 760) \times 2 + (930 \times 1,690 \times 760) \times 1$	$(1,240 \times 1,690 \times 760) \times 2 + (930 \times 1,690 \times 760) \times 1$
		inch	$(48-13/16 \times 66-17/32 \times 29-29/32) \times 2 + (36-5/8 \times 66-17/32 \times 29-29/32) \times 1$	$(48-13/16 \times 66-17/32 \times 29-29/32) \times 2 + (36-5/8 \times 66-17/32 \times 29-29/32) \times 1$
Net Weight		kg	$(310 \times 1) + (300 \times 1) + (215 \times 1)$	$(310 \times 2) + (215 \times 1)$
		lbs	$(683 \times 1) + (661 \times 1) + (474 \times 1)$	$(683 \times 2) + (474 \times 1)$
Sound Pressure Level	Cooling	dB(A)	68.3	68.5
	Heating	dB(A)	69.8	70.4
Sound Power Level	Cooling	dB(A)	94.2	94.2
	Heating	dB(A)	96.1	96.1
Protection Devices	High pressure protection		High pressure sensor / High pressure switch	
	Compressor/Fan		Over-heat protection / Fan driver overload protector	
	Inverter		Over-heat protection / Over-current protection	
Communication Cable (VCTF-SB)		No. xmm <sup>2</sup>	2C x 1.0 ~ 1.5	2C x 1.0 ~ 1.5
Refrigerant	Refrigerant name		R410A	R410A
	Precharged Amount	kg	42.5	43.5
		lbs	93.7	95.9
	t-CO <sub>2</sub> eq		88.719	90.806
Control		Electronic Expansion Valve	Electronic Expansion Valve	
Power Supply		V, Ø, Hz	380-400-415, 3, 50/60	380-400-415, 3, 50/60
Running Current	Cooling (Rated)	A	67.08 - 63.73 - 61.42	69.44 - 65.97 - 63.58
	Heating (Max)	A	72.50 - 68.88 - 66.39	75.80 - 72.01 - 69.41
Number of maximum connectable indoor units ***			64	64

### Note

- Due to our policy of innovation some specifications may be changed without notification.
- Wiring cable size must comply with the applicable local and national codes. And "Electric characteristics" chapter should be considered for electrical work and design. Especially the power cable and circuit breaker should be selected in accordance with that.
- Sound pressure level is measured on the rated condition in the anechoic rooms by ISO 3745 standard.  
Sound power level is measured on the rated condition in the reverberation rooms by ISO 3741 standard.  
Therefore, these values can be increased owing to ambient conditions during operation.
- Sound values of combination model are calculated values based on sound results of independent models.  
Sound values can be increased owing to ambient or installation conditions during operation.  
Sound values of system [dB(A)] =  $10 \cdot \log [10^{A1/10} + \dots + 10^{An/10}]$ , A1~An means sound values of independent models.
- Performances are based on the following conditions :
  - \*Cooling : Indoor Ambient Temp. 27°CDB / 19°CWB, Outdoor Ambient Temp. 35°CDB / 24°CWB
  - \*Heating : Indoor Ambient Temp. 20°CDB / 15°CWB, Outdoor Ambient Temp. 7°CDB / 6°CWB
  - Interconnected Pipe Length is 7.5m and difference of Elevation (Outdoor ~ Indoor Unit) is 0m.
- EUROVENT Test Condition :
  - Performance values in this PDB are based on Ceiling concealed duct combination.
  - Refer to EUROVENT web site([www.eurovent-certification.com](http://www.eurovent-certification.com)) for other indoor unit combination and more detail test conditions.
- \*\*\* : The number in parentheses means maximum connectable indoor units in accordance with outdoor units combination (160~200%).  
The recommended ratio is 130%.
- This product contains Fluorinated greenhouse gases.(R410A, GWP(Global warming potential) = 2,087.5)
- #1 : Heat Recovery system, #2 : Heat Pump system

# 1. Specifications

HP			62	64
Model Name	Combination Unit		ARUM620LTE5	ARUM640LTE5
	Independent Unit		ARUM240LTE5	ARUM240LTE5
			ARUM240LTE5	ARUM240LTE5
			ARUM140LTE5	ARUM160LTE5
Capacity	Cooling (Rated)	kW	173.6	179.2
		Btu/h	592,300	611,400
	Heating (Rated.)	kW	173.6	179.2
		Btu/h	592,300	611,400
	Heating (Max.)	kW	192.6	198.9
		Btu/h	657,200	678,700
Input	Cooling (Rated)	kW	43.49	45.72
	Heating (Rated)	kW	40.26	42.06
	Heating (Max.)	kW	47.32	49.99
EER (Rated)			3.99	3.92
COP	Rated capacity		4.31	4.26
	Max. capacity		4.07	3.98
SEER			8.16	8.05
SCOP			4.41	4.47
Exterior	Color		Warm Gray / Dawn Gray	Warm Gray / Dawn Gray
	RAL (Classic)		RAL 7044 / RAL 7037	RAL 7044 / RAL 7037
Heat Exchanger			Wide Louver Plus	Wide Louver Plus
Compressor	Type		Hermetically Sealed Scroll	Hermetically Sealed Scroll
	Piston Displacement	cm <sup>3</sup> /rev	62.1 × 5	62.1 × 5
	Number of Revolution	rev/min	3,600 × 5	3,600 × 5
	Motor Output x Number	W x No.	5,300 × 5	5,300 × 5
	Starting Method		Direct On Line	Direct On Line
	Oil Type		FVC68D(PVE)	FVC68D(PVE)
Fan	Type		Propeller fan	Propeller fan
	Motor Output x Number	W	900 × 6	900 × 6
	Air Flow Rate(High)	m <sup>3</sup> /min	320 × 3	320 × 3
		ft <sup>3</sup> /min	11,301 × 3	11,301 × 3
	External Static Pressure (Max, Pa)		DC INVERTER	DC INVERTER
	Drive		80	80
	Discharge	Side / Top	TOP	TOP
Pipe Connections #1	Liquid	mm(inch)	22.2(7/8)	22.2(7/8)
	Low Pressure Gas	mm(inch)	41.3(1-5/8)	41.3(1-5/8)
	High Pressure Gas	mm(inch)	34.9(1-3/8)	34.9(1-3/8)
Pipe Connections #2	Liquid	mm(inch)	22.2(7/8)	22.2(7/8)
	Gas	mm(inch)	41.3(1-5/8)	41.3(1-5/8)
Dimensions(W x H x D)		mm	(1,240 × 1,690 × 760) × 3	(1,240 × 1,690 × 760) × 3
		inch	(48-13/16 × 66-17/32 × 29-29/32) × 3	(48-13/16 × 66-17/32 × 29-29/32) × 3

## Note

- Due to our policy of innovation some specifications may be changed without notification.
- Wiring cable size must comply with the applicable local and national codes. And "Electric characteristics" chapter should be considered for electrical work and design. Especially the power cable and circuit breaker should be selected in accordance with that.
- Sound pressure level is measured on the rated condition in the anechoic rooms by ISO 3745 standard.  
Sound power level is measured on the rated condition in the reverberation rooms by ISO 3741 standard.  
Therefore, these values can be increased owing to ambient conditions during operation.
- Sound values of combination model are calculated values based on sound results of independent models.  
Sound values can be increased owing to ambient or installation conditions during operation.  
Sound values of system [dB(A)] = 10\*log [10<sup>A1</sup>(A1/10)+ ... +10<sup>An</sup>(An/10)] , A1~An means sound values of independent models.
- Performances are based on the following conditions :
  - \*Cooling : Indoor Ambient Temp. 27°CDB / 19°CWB, Outdoor Ambient Temp. 35°CDB / 24°CWB
  - \*Heating : Indoor Ambient Temp. 20°CDB / 15°CWB, Outdoor Ambient Temp. 7°CDB / 6°CWB
  - Interconnected Pipe Length is 7.5m and difference of Elevation (Outdoor ~ Indoor Unit) is 0m.
- EUROVENT Test Condition :
  - Performance values in this PDB are based on Ceiling concealed duct combination.
  - Refer to EUROVENT web site([www.eurovent-certification.com](http://www.eurovent-certification.com)) for other indoor unit combination and more detail test conditions.
- \*\*\* : The number in parentheses means maximum connectable indoor units in accordance with outdoor units combination (160~200%).  
The recommended ratio is 130%.
- This product contains Fluorinated greenhouse gases.(R410A, GWP(Global warming potential) = 2,087.5)
- #1 : Heat Recovery system, #2 : Heat Pump system



# 1. Specifications

HP			62	64
Model Name	Combination Unit		ARUM620LTE5	ARUM640LTE5
	Independent Unit		ARUM240LTE5	ARUM240LTE5
			ARUM240LTE5	ARUM240LTE5
			ARUM140LTE5	ARUM160LTE5
Net Weight		kg	(310 × 2) + (237 × 1)	(310 × 2) + (237 × 1)
		lbs	(683 × 2) + (522 × 1)	(683 × 2) + (522 × 1)
Sound Pressure Level	Cooling	dB(A)	68.6	68.7
	Heating	dB(A)	70.5	70.6
Sound Power Level	Cooling	dB(A)	94.2	94.5
	Heating	dB(A)	96.2	96.4
Protection Devices	High pressure protection		High pressure sensor / High pressure switch	
	Compressor/Fan		Over-heat protection / Fan driver overload protector	
	Inverter		Over-heat protection / Over-current protection	
Communication Cable (VCTF-SB)	No. × mm <sup>2</sup>		2C × 1.0 ~ 1.5	2C × 1.0 ~ 1.5
Refrigerant	Refrigerant name		R410A	R410A
	Precharged Amount	kg	47.5	47.5
		lbs	104.7	104.7
	t-CO <sub>2</sub> eq		99.156	99.156
Control		Electronic Expansion Valve	Electronic Expansion Valve	
Power Supply	V, Ø, Hz		380-400-415, 3, 50/60	380-400-415, 3, 50/60
Running Current	Cooling (Rated)	A	71.02 - 67.47 - 65.03	74.65 - 70.91 - 68.35
	Heating (Max)	A	77.40 - 73.53 - 70.87	82.70 - 78.57 - 75.73
Number of maximum connectable indoor units ***			64	64

### Note

- Due to our policy of innovation some specifications may be changed without notification.
- Wiring cable size must comply with the applicable local and national codes. And "Electric characteristics" chapter should be considered for electrical work and design. Especially the power cable and circuit breaker should be selected in accordance with that.
- Sound pressure level is measured on the rated condition in the anechoic rooms by ISO 3745 standard.  
Sound power level is measured on the rated condition in the reverberation rooms by ISO 3741 standard.  
Therefore, these values can be increased owing to ambient conditions during operation.
- Sound values of combination model are calculated values based on sound results of independent models.  
Sound values can be increased owing to ambient or installation conditions during operation.  
Sound values of system [dB(A)] =  $10 \cdot \log [10^{(A1/10)} + \dots + 10^{(An/10)}]$ , A1~An means sound values of independent models.
- Performances are based on the following conditions :
  - \*Cooling : Indoor Ambient Temp. 27°CDB / 19°CWB, Outdoor Ambient Temp. 35°CDB / 24°CWB
  - \*Heating : Indoor Ambient Temp. 20°CDB / 15°CWB, Outdoor Ambient Temp. 7°CDB / 6°CWB
  - Interconnected Pipe Length is 7.5m and difference of Elevation (Outdoor ~ Indoor Unit) is 0m.
- EUROVENT Test Condition :
  - Performance values in this PDB are based on Ceiling concealed duct combination.
  - Refer to EUROVENT web site([www.eurovent-certification.com](http://www.eurovent-certification.com)) for other indoor unit combination and more detail test conditions.
- \*\*\* : The number in parentheses means maximum connectable indoor units in accordance with outdoor units combination (160~200%).  
The recommended ratio is 130%.
- This product contains Fluorinated greenhouse gases.(R410A, GWP(Global warming potential) = 2,087.5)
- #1 : Heat Recovery system, #2 : Heat Pump system

# 1. Specifications

HP			66	68
Model Name	Combination Unit		ARUM660LTE5	ARUM680LTE5
	Independent Unit		ARUM240LTE5	ARUM240LTE5
			ARUM240LTE5	ARUM240LTE5
			ARUM180LTE5	ARUM200LTE5
Capacity	Cooling (Rated)	kW	184.8	190.4
		Btu/h	630,500	649,600
	Heating (Rated.)	kW	184.8	190.4
		Btu/h	630,500	649,600
	Heating (Max.)	kW	205.2	211.5
		Btu/h	700,200	721,700
Input	Cooling (Rated)	kW	45.85	47.57
	Heating (Rated)	kW	41.90	43.98
	Heating (Max.)	kW	49.54	52.28
EER (Rated)			4.03	4.00
COP	Rated capacity		4.41	4.33
	Max. capacity		4.14	4.05
SEER			8.03	7.99
SCOP			4.28	4.24
Exterior	Color		Warm Gray / Dawn Gray	Warm Gray / Dawn Gray
	RAL (Classic)		RAL 7044 / RAL 7037	RAL 7044 / RAL 7037
Heat Exchanger			Wide Louver Plus	Wide Louver Plus
Compressor	Type		Hermetically Sealed Scroll	Hermetically Sealed Scroll
	Piston Displacement	cm <sup>3</sup> /rev	(62.1 × 5) + (43.8 × 1)	(62.1 × 5) + (43.8 × 1)
	Number of Revolution	rev/min	3,600 × 6	3,600 × 6
	Motor Output x Number	W x No.	(5,300 × 5) + (4,200 × 1)	(5,300 × 5) + (4,200 × 1)
	Starting Method		Direct On Line	Direct On Line
Oil Type		FVC68D(PVE)	FVC68D(PVE)	
Fan	Type		Propeller fan	Propeller fan
	Motor Output x Number	W	900 × 6	900 × 6
	Air Flow Rate(High)	m <sup>3</sup> /min	320 × 3	320 × 3
		ft <sup>3</sup> /min	11,301 × 3	11,301 × 3
	External Static Pressure (Max, Pa)		DC INVERTER	DC INVERTER
	Drive		80	80
Discharge	Side / Top	TOP	TOP	
Pipe Connections #1	Liquid	mm(inch)	22.2(7/8)	22.2(7/8)
	Low Pressure Gas	mm(inch)	53.98(2-1/8)	53.98(2-1/8)
	High Pressure Gas	mm(inch)	41.3(1-5/8)	41.3(1-5/8)
Pipe Connections #2	Liquid	mm(inch)	22.2(7/8)	22.2(7/8)
	Gas	mm(inch)	53.98(2-1/8)	53.98(2-1/8)
Dimensions(W x H x D)		mm	(1,240 × 1,690 × 760) × 3	(1,240 × 1,690 × 760) × 3
		inch	(48-13/16 × 66-17/32 × 29-29/32) × 3	(48-13/16 × 66-17/32 × 29-29/32) × 3

## Note

- Due to our policy of innovation some specifications may be changed without notification.
- Wiring cable size must comply with the applicable local and national codes. And "Electric characteristics" chapter should be considered for electrical work and design. Especially the power cable and circuit breaker should be selected in accordance with that.
- Sound pressure level is measured on the rated condition in the anechoic rooms by ISO 3745 standard.  
Sound power level is measured on the rated condition in the reverberation rooms by ISO 3741 standard.  
Therefore, these values can be increased owing to ambient conditions during operation.
- Sound values of combination model are calculated values based on sound results of independent models.  
Sound values can be increased owing to ambient or installation conditions during operation.  
Sound values of system [dB(A)] =  $10 \cdot \log [10^{A1/10} + \dots + 10^{An/10}]$ , A1~An means sound values of independent models.
- Performances are based on the following conditions :
  - \*Cooling : Indoor Ambient Temp. 27°CDB / 19°CWB, Outdoor Ambient Temp. 35°CDB / 24°CWB
  - \*Heating : Indoor Ambient Temp. 20°CDB / 15°CWB, Outdoor Ambient Temp. 7°CDB / 6°CWB
  - Interconnected Pipe Length is 7.5m and difference of Elevation (Outdoor ~ Indoor Unit) is 0m.
- EUROVENT Test Condition :
  - Performance values in this PDB are based on Ceiling concealed duct combination.
  - Refer to EUROVENT web site([www.eurovent-certification.com](http://www.eurovent-certification.com)) for other indoor unit combination and more detail test conditions.
- \*\*\* : The number in parentheses means maximum connectable indoor units in accordance with outdoor units combination (160~200%).  
The recommended ratio is 130%.
- This product contains Fluorinated greenhouse gases.(R410A, GWP(Global warming potential) = 2,087.5)
- #1 : Heat Recovery system, #2 : Heat Pump system

# 1. Specifications

HP			66	68
Model Name	Combination Unit		ARUM660LTE5	ARUM680LTE5
	Independent Unit		ARUM240LTE5	ARUM240LTE5
			ARUM240LTE5	ARUM240LTE5
			ARUM180LTE5	ARUM200LTE5
Net Weight		kg	(310 × 2) + (300 × 1)	(310 × 2) + (300 × 1)
		lbs	(683 × 2) + (661 × 1)	(683 × 2) + (661 × 1)
Sound Pressure Level	Cooling	dB(A)	68.8	69.0
	Heating	dB(A)	70.6	71.1
Sound Power Level	Cooling	dB(A)	94.8	95.2
	Heating	dB(A)	96.5	97.0
Protection Devices	High pressure protection		High pressure sensor / High pressure switch	
	Compressor/Fan		Over-heat protection / Fan driver overload protector	
	Inverter		Over-heat protection / Over-current protection	
Communication Cable (VCTF-SB)	No. × mm <sup>2</sup>		2C × 1.0 ~ 1.5	2C × 1.0 ~ 1.5
Refrigerant	Refrigerant name		R410A	R410A
	Precharged Amount	kg	50.0	50.0
		lbs	110.2	110.2
	t-CO <sub>2</sub> eq		104.375	104.375
Control		Electronic Expansion Valve	Electronic Expansion Valve	
Power Supply		V, Ø, Hz	380-400-415, 3, 50/60	380-400-415, 3, 50/60
Running Current	Cooling (Rated)	A	74.92 - 71.18 - 68.61	77.71 - 73.83 - 71.16
	Heating (Max)	A	80.50 - 76.48 - 73.71	85.40 - 81.13 - 78.20
Number of maximum connectable indoor units ***			64	64

### Note

- Due to our policy of innovation some specifications may be changed without notification.
- Wiring cable size must comply with the applicable local and national codes. And "Electric characteristics" chapter should be considered for electrical work and design. Especially the power cable and circuit breaker should be selected in accordance with that.
- Sound pressure level is measured on the rated condition in the anechoic rooms by ISO 3745 standard.  
Sound power level is measured on the rated condition in the reverberation rooms by ISO 3741 standard.  
Therefore, these values can be increased owing to ambient conditions during operation.
- Sound values of combination model are calculated values based on sound results of independent models.  
Sound values can be increased owing to ambient or installation conditions during operation.  
Sound values of system [dB(A)] =  $10 \cdot \log [10^{(A1/10)} + \dots + 10^{(An/10)}]$ , A1~An means sound values of independent models.
- Performances are based on the following conditions :
  - \*Cooling : Indoor Ambient Temp. 27°CDB / 19°CWB, Outdoor Ambient Temp. 35°CDB / 24°CWB
  - \*Heating : Indoor Ambient Temp. 20°CDB / 15°CWB, Outdoor Ambient Temp. 7°CDB / 6°CWB
  - Interconnected Pipe Length is 7.5m and difference of Elevation (Outdoor ~ Indoor Unit) is 0m.
- EUROVENT Test Condition :
  - Performance values in this PDB are based on Ceiling concealed duct combination.
  - Refer to EUROVENT web site([www.eurovent-certification.com](http://www.eurovent-certification.com)) for other indoor unit combination and more detail test conditions.
- \*\*\* : The number in parentheses means maximum connectable indoor units in accordance with outdoor units combination (160~200%).  
The recommended ratio is 130%.
- This product contains Fluorinated greenhouse gases.(R410A, GWP(Global warming potential) = 2,087.5)
- #1 : Heat Recovery system, #2 : Heat Pump system

# 1. Specifications

HP			70	72
Model Name	Combination Unit		ARUM700LTE5	ARUM720LTE5
	Independent Unit		ARUM240LTE5	ARUM240LTE5
			ARUM240LTE5	ARUM240LTE5
			ARUM220LTE5	ARUM240LTE5
Capacity	Cooling (Rated)	kW	196.0	201.6
		Btu/h	668,800	687,900
	Heating (Rated.)	kW	196.0	201.6
		Btu/h	668,800	687,900
	Heating (Max.)	kW	217.8	222.8
		Btu/h	743,200	760,100
Input	Cooling (Rated)	kW	50.74	52.23
	Heating (Rated)	kW	45.93	47.67
	Heating (Max.)	kW	54.36	56.40
EER (Rated)			3.86	3.86
COP	Rated capacity		4.27	4.23
	Max. capacity		4.01	3.95
SEER			7.81	7.93
SCOP			4.20	4.36
Exterior	Color		Warm Gray / Dawn Gray	Warm Gray / Dawn Gray
	RAL (Classic)		RAL 7044 / RAL 7037	RAL 7044 / RAL 7037
Heat Exchanger			Wide Louver Plus	Wide Louver Plus
Compressor	Type		Hermetically Sealed Scroll	Hermetically Sealed Scroll
	Piston Displacement	cm <sup>3</sup> /rev	(62.1 × 5) + (43.8 × 1)	62.1 × 6
	Number of Revolution	rev/min	3,600 × 6	3,600 × 6
	Motor Output x Number	W x No.	(5,300 × 5) + (4,200 × 1)	5,300 × 6
	Starting Method		Direct On Line	Direct On Line
Oil Type		FVC68D(PVE)	FVC68D(PVE)	
Fan	Type		Propeller fan	Propeller fan
	Motor Output x Number	W	900 × 6	900 × 6
	Air Flow Rate(High)	m <sup>3</sup> /min	320 × 3	320 × 3
		ft <sup>3</sup> /min	11,301 × 3	11,301 × 3
	External Static Pressure (Max, Pa)		DC INVERTER	DC INVERTER
	Drive		80	80
Discharge	Side / Top	TOP	TOP	
Pipe Connections #1	Liquid	mm(inch)	22.2(7/8)	22.2(7/8)
	Low Pressure Gas	mm(inch)	53.98(2-1/8)	53.98(2-1/8)
	High Pressure Gas	mm(inch)	41.3(1-5/8)	41.3(1-5/8)
Pipe Connections #2	Liquid	mm(inch)	22.2(7/8)	22.2(7/8)
	Gas	mm(inch)	53.98(2-1/8)	53.98(2-1/8)
Dimensions(W x H x D)		mm	(1,240 × 1,690 × 760) × 3	(1,240 × 1,690 × 760) × 3
		inch	(48-13/16 × 66-17/32 × 29-29/32) × 3	(48-13/16 × 66-17/32 × 29-29/32) × 3

## Note

- Due to our policy of innovation some specifications may be changed without notification.
- Wiring cable size must comply with the applicable local and national codes. And "Electric characteristics" chapter should be considered for electrical work and design. Especially the power cable and circuit breaker should be selected in accordance with that.
- Sound pressure level is measured on the rated condition in the anechoic rooms by ISO 3745 standard.  
Sound power level is measured on the rated condition in the reverberation rooms by ISO 3741 standard.  
Therefore, these values can be increased owing to ambient conditions during operation.
- Sound values of combination model are calculated values based on sound results of independent models.  
Sound values can be increased owing to ambient or installation conditions during operation.  
Sound values of system [dB(A)] = 10\*log [10<sup>A1</sup>(A1/10)+ ... +10<sup>An</sup>(An/10)] , A1~An means sound values of independent models.
- Performances are based on the following conditions :
  - \*Cooling : Indoor Ambient Temp. 27°CDB / 19°CWB, Outdoor Ambient Temp. 35°CDB / 24°CWB
  - \*Heating : Indoor Ambient Temp. 20°CDB / 15°CWB, Outdoor Ambient Temp. 7°CDB / 6°CWB
  - Interconnected Pipe Length is 7.5m and difference of Elevation (Outdoor ~ Indoor Unit) is 0m.
- EUROVENT Test Condition :
  - Performance values in this PDB are based on Ceiling concealed duct combination.
  - Refer to EUROVENT web site([www.eurovent-certification.com](http://www.eurovent-certification.com)) for other indoor unit combination and more detail test conditions.
- \*\*\* : The number in parentheses means maximum connectable indoor units in accordance with outdoor units combination (160~200%).  
The recommended ratio is 130%.
- This product contains Fluorinated greenhouse gases.(R410A, GWP(Global warming potential) = 2,087.5)
- #1 : Heat Recovery system, #2 : Heat Pump system

# 1. Specifications

HP			70	72
Model Name	Combination Unit		ARUM700LTE5	ARUM720LTE5
	Independent Unit		ARUM240LTE5	ARUM240LTE5
			ARUM240LTE5	ARUM240LTE5
			ARUM220LTE5	ARUM240LTE5
Net Weight		kg	(310 × 2) + (300 × 1)	310 × 3
		lbs	(683 × 2) + (661 × 1)	683 × 3
Sound Pressure Level	Cooling	dB(A)	69.6	69.8
	Heating	dB(A)	71.3	71.8
Sound Power Level	Cooling	dB(A)	95.8	95.8
	Heating	dB(A)	97.8	97.8
Protection Devices	High pressure protection		High pressure sensor / High pressure switch	
	Compressor/Fan		Over-heat protection / Fan driver overload protector	
	Inverter		Over-heat protection / Over-current protection	
Communication Cable (VCTF-SB)	No. × mm <sup>2</sup>		2C × 1.0 ~ 1.5	2C × 1.0 ~ 1.5
Refrigerant	Refrigerant name		R410A	R410A
	Precharged Amount	kg	50.0	51.0
		lbs	110.2	112.4
	t-CO <sub>2</sub> eq		104.375	106.463
Control		Electronic Expansion Valve	Electronic Expansion Valve	
Power Supply	V, Ø, Hz		380-400-415, 3, 50/60	380-400-415, 3, 50/60
Running Current	Cooling (Rated)	A	82.89 - 78.75 - 75.89	85.35 - 81.08 - 78.15
	Heating (Max)	A	88.80 - 84.36 - 81.31	92.10 - 87.50 - 84.33
Number of maximum connectable indoor units ***			64	64

### Note

- Due to our policy of innovation some specifications may be changed without notification.
- Wiring cable size must comply with the applicable local and national codes. And "Electric characteristics" chapter should be considered for electrical work and design. Especially the power cable and circuit breaker should be selected in accordance with that.
- Sound pressure level is measured on the rated condition in the anechoic rooms by ISO 3745 standard.  
Sound power level is measured on the rated condition in the reverberation rooms by ISO 3741 standard.  
Therefore, these values can be increased owing to ambient conditions during operation.
- Sound values of combination model are calculated values based on sound results of independent models.  
Sound values can be increased owing to ambient or installation conditions during operation.  
Sound values of system [dB(A)] =  $10 \cdot \log [10^{(A1/10)} + \dots + 10^{(An/10)}]$ , A1~An means sound values of independent models.
- Performances are based on the following conditions :
  - \*Cooling : Indoor Ambient Temp. 27°CDB / 19°CWB, Outdoor Ambient Temp. 35°CDB / 24°CWB
  - \*Heating : Indoor Ambient Temp. 20°CDB / 15°CWB, Outdoor Ambient Temp. 7°CDB / 6°CWB
  - Interconnected Pipe Length is 7.5m and difference of Elevation (Outdoor ~ Indoor Unit) is 0m.
- EUROVENT Test Condition :
  - Performance values in this PDB are based on Ceiling concealed duct combination.
  - Refer to EUROVENT web site([www.eurovent-certification.com](http://www.eurovent-certification.com)) for other indoor unit combination and more detail test conditions.
- \*\*\* : The number in parentheses means maximum connectable indoor units in accordance with outdoor units combination (160~200%).  
The recommended ratio is 130%.
- This product contains Fluorinated greenhouse gases.(R410A, GWP(Global warming potential) = 2,087.5)
- #1 : Heat Recovery system, #2 : Heat Pump system

# 1. Specifications

HP			74	76
Model Name	Combination Unit		ARUM740LTE5	ARUM760LTE5
	Independent Unit		ARUM240LTE5	ARUM240LTE5
			ARUM240LTE5	ARUM240LTE5
			ARUM140LTE5	ARUM160LTE5
			ARUM120LTE5	ARUM120LTE5
Capacity	Cooling (Rated)	kW	207.2	212.8
		Btu/h	707,000	726,100
	Heating (Rated.)	kW	207.2	212.8
		Btu/h	707,000	726,100
	Heating (Max.)	kW	230.4	236.7
		Btu/h	786,200	807,700
Input	Cooling (Rated)	kW	51.20	53.43
	Heating (Rated)	kW	47.11	48.91
	Heating (Max.)	kW	55.58	58.25
EER (Rated)			4.05	3.98
COP	Rated capacity		4.40	4.35
	Max. capacity		4.15	4.06
SEER			8.35	8.29
SCOP			4.50	4.55
Exterior	Color		Warm Gray / Dawn Gray	Warm Gray / Dawn Gray
	RAL (Classic)		RAL 7044 / RAL 7037	RAL 7044 / RAL 7037
Heat Exchanger			Wide Louver Plus	Wide Louver Plus
Compressor	Type		Hermetically Sealed Scroll	Hermetically Sealed Scroll
	Piston Displacement	cm <sup>3</sup> /rev	62.1 × 6	62.1 × 6
	Number of Revolution	rev/min	3,600 × 6	3,600 × 6
	Motor Output x Number	W x No.	5,300 × 6	5,300 × 6
	Starting Method		Direct On Line	Direct On Line
Oil Type		FVC68D(PVE)	FVC68D(PVE)	
Fan	Type		Propeller fan	Propeller fan
	Motor Output x Number	W	(900 × 6) + (1,200 × 1)	(900 × 6) + (1,200 × 1)
	Air Flow Rate(High)	m <sup>3</sup> /min	(320 × 3) + (240 × 1)	(320 × 3) + (240 × 1)
		ft <sup>3</sup> /min	(11,301 × 3) + (8,476 × 1)	(11,301 × 3) + (8,476 × 1)
	External Static Pressure (Max, Pa)		DC INVERTER	DC INVERTER
	Drive		80	80
Discharge	Side / Top	TOP	TOP	
Pipe Connections #1	Liquid	mm(inch)	22.2(7/8)	22.2(7/8)
	Low Pressure Gas	mm(inch)	53.98(2-1/8)	53.98(2-1/8)
	High Pressure Gas	mm(inch)	41.3(1-5/8)	41.3(1-5/8)
Pipe Connections #2	Liquid	mm(inch)	22.2(7/8)	22.2(7/8)
	Gas	mm(inch)	53.98(2-1/8)	53.98(2-1/8)

## Note

- Due to our policy of innovation some specifications may be changed without notification.
- Wiring cable size must comply with the applicable local and national codes. And "Electric characteristics" chapter should be considered for electrical work and design. Especially the power cable and circuit breaker should be selected in accordance with that.
- Sound pressure level is measured on the rated condition in the anechoic rooms by ISO 3745 standard.  
Sound power level is measured on the rated condition in the reverberation rooms by ISO 3741 standard.  
Therefore, these values can be increased owing to ambient conditions during operation.
- Sound values of combination model are calculated values based on sound results of independent models.  
Sound values can be increased owing to ambient or installation conditions during operation.  
Sound values of system [dB(A)] = 10\*log [10<sup>A1</sup>(A1/10)+ ... +10<sup>An</sup>(An/10)] , A1~An means sound values of independent models.
- Performances are based on the following conditions :
  - \*Cooling : Indoor Ambient Temp. 27°CDB / 19°CWB, Outdoor Ambient Temp. 35°CDB / 24°CWB
  - \*Heating : Indoor Ambient Temp. 20°CDB / 15°CWB, Outdoor Ambient Temp. 7°CDB / 6°CWB
  - Interconnected Pipe Length is 7.5m and difference of Elevation (Outdoor ~ Indoor Unit) is 0m.
- EUROVENT Test Condition :
  - Performance values in this PDB are based on Ceiling concealed duct combination.
  - Refer to EUROVENT web site([www.eurovent-certification.com](http://www.eurovent-certification.com)) for other indoor unit combination and more detail test conditions.
- \*\*\* : The number in parentheses means maximum connectable indoor units in accordance with outdoor units combination (160~200%).  
The recommended ratio is 130%.
- This product contains Fluorinated greenhouse gases.(R410A, GWP(Global warming potential) = 2,087.5)
- #1 : Heat Recovery system, #2 : Heat Pump system

# 1. Specifications

HP			74	76
Model Name	Combination Unit		ARUM740LTE5	ARUM760LTE5
	Independent Unit		ARUM240LTE5	ARUM240LTE5
			ARUM240LTE5	ARUM240LTE5
			ARUM140LTE5	ARUM160LTE5
			ARUM120LTE5	ARUM120LTE5
Dimensions(W x H x D)	mm	(1,240 × 1,690 × 760) × 3 + (930 × 1,690 × 760) × 1	(1,240 × 1,690 × 760) × 3 + (930 × 1,690 × 760) × 1	
	inch	(48-13/16 × 66-17/32 × 29-29/32) × 3 + (36-5/8 × 66-17/32 × 29-29/32) × 1	(48-13/16 × 66-17/32 × 29-29/32) × 3 + (36-5/8 × 66-17/32 × 29-29/32) × 1	
Net Weight	kg	(310 × 2) + (237 × 1) + (215 × 1)	(310 × 2) + (237 × 1) + (215 × 1)	
	lbs	(683 × 2) + (522 × 1) + (474 × 1)	(683 × 2) + (522 × 1) + (474 × 1)	
Sound Pressure Level	Cooling	dB(A)	69.1	69.2
	Heating	dB(A)	70.9	70.9
Sound Power Level	Cooling	dB(A)	94.4	94.7
	Heating	dB(A)	96.3	96.5
Protection Devices	High pressure protection		High pressure sensor / High pressure switch	
	Compressor/Fan		Over-heat protection / Fan driver overload protector	
	Inverter		Over-heat protection / Over-current protection	
Communication Cable (VCTF-SB)		No. xmm <sup>2</sup>	2C × 1.0 ~ 1.5	2C × 1.0 ~ 1.5
Refrigerant	Refrigerant name		R410A	R410A
	Precharged Amount	kg	57.0	57.0
		lbs	125.7	125.7
	t-CO <sub>2</sub> eq		118.988	118.988
Control		Electronic Expansion Valve	Electronic Expansion Valve	
Power Supply		V, Ø, Hz	380-400-415, 3, 50/60	380-400-415, 3, 50/60
Running Current	Cooling (Rated)	A	83.62 - 79.44 - 76.58	87.25 - 82.89 - 79.89
	Heating (Max)	A	91.80 - 87.21 - 84.06	97.10 - 92.25 - 88.91
Number of maximum connectable indoor units ***			64	64

### Note

- Due to our policy of innovation some specifications may be changed without notification.
- Wiring cable size must comply with the applicable local and national codes. And "Electric characteristics" chapter should be considered for electrical work and design. Especially the power cable and circuit breaker should be selected in accordance with that.
- Sound pressure level is measured on the rated condition in the anechoic rooms by ISO 3745 standard.  
Sound power level is measured on the rated condition in the reverberation rooms by ISO 3741 standard.  
Therefore, these values can be increased owing to ambient conditions during operation.
- Sound values of combination model are calculated values based on sound results of independent models.  
Sound values can be increased owing to ambient or installation conditions during operation.  
Sound values of system [dB(A)] = 10\*log [10<sup>A1</sup>/10 + ... + 10<sup>An</sup>/10], A1~An means sound values of independent models.
- Performances are based on the following conditions :
  - \*Cooling : Indoor Ambient Temp. 27°CDB / 19°CWB, Outdoor Ambient Temp. 35°CDB / 24°CWB
  - \*Heating : Indoor Ambient Temp. 20°CDB / 15°CWB, Outdoor Ambient Temp. 7°CDB / 6°CWB
  - Interconnected Pipe Length is 7.5m and difference of Elevation (Outdoor ~ Indoor Unit) is 0m.
- EUROVENT Test Condition :
  - Performance values in this PDB are based on Ceiling concealed duct combination.
  - Refer to EUROVENT web site([www.eurovent-certification.com](http://www.eurovent-certification.com)) for other indoor unit combination and more detail test conditions.
- \*\*\* : The number in parentheses means maximum connectable indoor units in accordance with outdoor units combination (160~200%).  
The recommended ratio is 130%.
- This product contains Fluorinated greenhouse gases.(R410A, GWP(Global warming potential) = 2,087.5)
- #1 : Heat Recovery system, #2 : Heat Pump system

# 1. Specifications

HP			78	80
Model Name	Combination Unit		ARUM780LTE5	ARUM800LTE5
	Independent Unit		ARUM240LTE5	ARUM240LTE5
			ARUM240LTE5	ARUM240LTE5
			ARUM180LTE5	ARUM200LTE5
			ARUM120LTE5	ARUM120LTE5
Capacity	Cooling (Rated)	kW	218.4	224.0
		Btu/h	745,200	764,300
	Heating (Rated.)	kW	218.4	224.0
		Btu/h	745,200	764,300
	Heating (Max.)	kW	243.0	249.3
		Btu/h	829,200	850,700
Input	Cooling (Rated)	kW	53.55	55.28
	Heating (Rated)	kW	48.75	50.83
	Heating (Max.)	kW	57.80	60.54
EER (Rated)			4.08	4.05
COP	Rated capacity		4.48	4.41
	Max. capacity		4.20	4.12
SEER			8.26	8.21
SCOP			4.39	4.34
Exterior	Color		Warm Gray / Dawn Gray	Warm Gray / Dawn Gray
	RAL (Classic)		RAL 7044 / RAL 7037	RAL 7044 / RAL 7037
Heat Exchanger			Wide Louver Plus	Wide Louver Plus
Compressor	Type		Hermetically Sealed Scroll	Hermetically Sealed Scroll
	Piston Displacement	cm <sup>3</sup> /rev	(62.1 × 6) + (43.8 × 1)	(62.1 × 6) + (43.8 × 1)
	Number of Revolution	rev/min	3,600 × 6	3,600 × 6
	Motor Output x Number	W x No.	(5,300 × 6) + (4,200 × 1)	(5,300 × 6) + (4,200 × 1)
	Starting Method		Direct On Line	Direct On Line
	Oil Type		FVC68D(PVE)	FVC68D(PVE)
Fan	Type		Propeller fan	Propeller fan
	Motor Output x Number	W	(900 × 6) + (1,200 × 1)	(900 × 6) + (1,200 × 1)
	Air Flow Rate(High)	m <sup>3</sup> /min	(320 × 3) + (240 × 1)	(320 × 3) + (240 × 1)
		ft <sup>3</sup> /min	(11,301 × 3) + (8,476 × 1)	(11,301 × 3) + (8,476 × 1)
	External Static Pressure (Max, Pa)		DC INVERTER	DC INVERTER
	Drive		80	80
	Discharge	Side / Top	TOP	TOP
Pipe Connections #1	Liquid	mm(inch)	22.2(7/8)	22.2(7/8)
	Low Pressure Gas	mm(inch)	53.98(2-1/8)	53.98(2-1/8)
	High Pressure Gas	mm(inch)	41.3(1-5/8)	41.3(1-5/8)
Pipe Connections #2	Liquid	mm(inch)	22.2(7/8)	22.2(7/8)
	Gas	mm(inch)	53.98(2-1/8)	53.98(2-1/8)

## Note

- Due to our policy of innovation some specifications may be changed without notification.
- Wiring cable size must comply with the applicable local and national codes. And "Electric characteristics" chapter should be considered for electrical work and design. Especially the power cable and circuit breaker should be selected in accordance with that.
- Sound pressure level is measured on the rated condition in the anechoic rooms by ISO 3745 standard.  
Sound power level is measured on the rated condition in the reverberation rooms by ISO 3741 standard.  
Therefore, these values can be increased owing to ambient conditions during operation.
- Sound values of combination model are calculated values based on sound results of independent models.  
Sound values can be increased owing to ambient or installation conditions during operation.  
Sound values of system [dB(A)] = 10\*log [10<sup>A1</sup>(A1/10)+ ... +10<sup>An</sup>(An/10)] , A1~An means sound values of independent models.
- Performances are based on the following conditions :
  - \*Cooling : Indoor Ambient Temp. 27°CDB / 19°CWB, Outdoor Ambient Temp. 35°CDB / 24°CWB
  - \*Heating : Indoor Ambient Temp. 20°CDB / 15°CWB, Outdoor Ambient Temp. 7°CDB / 6°CWB
  - Interconnected Pipe Length is 7.5m and difference of Elevation (Outdoor ~ Indoor Unit) is 0m.
- EUROVENT Test Condition :
  - Performance values in this PDB are based on Ceiling concealed duct combination.
  - Refer to EUROVENT web site([www.eurovent-certification.com](http://www.eurovent-certification.com)) for other indoor unit combination and more detail test conditions.
- \*\*\* : The number in parentheses means maximum connectable indoor units in accordance with outdoor units combination (160~200%).  
The recommended ratio is 130%.
- This product contains Fluorinated greenhouse gases.(R410A, GWP(Global warming potential) = 2,087.5)
- #1 : Heat Recovery system, #2 : Heat Pump system



# 1. Specifications

HP			78	80
Model Name	Combination Unit		ARUM780LTE5	ARUM800LTE5
	Independent Unit		ARUM240LTE5	ARUM240LTE5
			ARUM240LTE5	ARUM240LTE5
			ARUM180LTE5	ARUM200LTE5
			ARUM120LTE5	ARUM120LTE5
Dimensions(W x H x D)	mm	(1,240 × 1,690 × 760) × 3 + (930 × 1,690 × 760) × 1	(1,240 × 1,690 × 760) × 3 + (930 × 1,690 × 760) × 1	
	inch	(48-13/16 × 66-17/32 × 29-29/32) × 3 + (36-5/8 × 66-17/32 × 29-29/32) × 1	(48-13/16 × 66-17/32 × 29-29/32) × 3 + (36-5/8 × 66-17/32 × 29-29/32) × 1	
Net Weight	kg	(310 × 2) + (300 × 1) + (215 × 1)	(310 × 2) + (300 × 1) + (215 × 1)	
	lbs	(683 × 2) + (661 × 1) + (474 × 1)	(683 × 2) + (661 × 1) + (474 × 1)	
Sound Pressure Level	Cooling	dB(A)	69.2	69.4
	Heating	dB(A)	71.0	71.4
Sound Power Level	Cooling	dB(A)	95.0	95.4
	Heating	dB(A)	96.6	97.1
Protection Devices	High pressure protection		High pressure sensor / High pressure switch	
	Compressor/Fan		Over-heat protection / Fan driver overload protector	
	Inverter		Over-heat protection / Over-current protection	
Communication Cable (VCTF-SB)		No. xmm <sup>2</sup>	2C × 1.0 ~ 1.5	2C × 1.0 ~ 1.5
Refrigerant	Refrigerant name		R410A	R410A
	Precharged Amount	kg	59.5	59.5
		lbs	131.2	131.2
	t-CO <sub>2</sub> eq		124.206	124.206
Control		Electronic Expansion Valve	Electronic Expansion Valve	
Power Supply		V, Ø, Hz	380-400-415, 3, 50/60	380-400-415, 3, 50/60
Running Current	Cooling (Rated)	A	87.53 - 83.16 - 80.14	90.31 - 85.80 - 82.70
	Heating (Max)	A	94.90 - 90.16 - 86.90	99.80 - 94.81 - 91.38
Number of maximum connectable indoor units ***			64	64

### Note

- Due to our policy of innovation some specifications may be changed without notification.
- Wiring cable size must comply with the applicable local and national codes. And "Electric characteristics" chapter should be considered for electrical work and design. Especially the power cable and circuit breaker should be selected in accordance with that.
- Sound pressure level is measured on the rated condition in the anechoic rooms by ISO 3745 standard.  
Sound power level is measured on the rated condition in the reverberation rooms by ISO 3741 standard.  
Therefore, these values can be increased owing to ambient conditions during operation.
- Sound values of combination model are calculated values based on sound results of independent models.  
Sound values can be increased owing to ambient or installation conditions during operation.  
Sound values of system [dB(A)] =  $10 \cdot \log [10^{A1/10} + \dots + 10^{An/10}]$ , A1~An means sound values of independent models.
- Performances are based on the following conditions :
  - \*Cooling : Indoor Ambient Temp. 27°CDB / 19°CWB, Outdoor Ambient Temp. 35°CDB / 24°CWB
  - \*Heating : Indoor Ambient Temp. 20°CDB / 15°CWB, Outdoor Ambient Temp. 7°CDB / 6°CWB
  - Interconnected Pipe Length is 7.5m and difference of Elevation (Outdoor ~ Indoor Unit) is 0m.
- EUROVENT Test Condition :
  - Performance values in this PDB are based on Ceiling concealed duct combination.
  - Refer to EUROVENT web site([www.eurovent-certification.com](http://www.eurovent-certification.com)) for other indoor unit combination and more detail test conditions.
- \*\*\* : The number in parentheses means maximum connectable indoor units in accordance with outdoor units combination (160~200%).  
The recommended ratio is 130%.
- This product contains Fluorinated greenhouse gases.(R410A, GWP(Global warming potential) = 2,087.5)
- #1 : Heat Recovery system, #2 : Heat Pump system

# 1. Specifications

HP			82	84
Model Name	Combination Unit		ARUM820LTE5	ARUM840LTE5
	Independent Unit		ARUM240LTE5	ARUM240LTE5
			ARUM240LTE5	ARUM240LTE5
			ARUM220LTE5	ARUM240LTE5
			ARUM120LTE5	ARUM120LTE5
Capacity	Cooling (Rated)	kW	229.6	235.2
		Btu/h	783,400	802,500
	Heating (Rated.)	kW	229.6	235.2
		Btu/h	783,400	802,500
	Heating (Max.)	kW	255.6	260.6
		Btu/h	872,100	889,100
Input	Cooling (Rated)	kW	58.44	59.93
	Heating (Rated)	kW	52.78	54.52
	Heating (Max.)	kW	62.62	64.66
EER (Rated)			3.93	3.92
COP	Rated capacity		4.35	4.31
	Max. capacity		4.08	4.03
SEER			8.05	8.15
SCOP			4.31	4.44
Exterior	Color		Warm Gray / Dawn Gray	Warm Gray / Dawn Gray
	RAL (Classic)		RAL 7044 / RAL 7037	RAL 7044 / RAL 7037
Heat Exchanger			Wide Louver Plus	Wide Louver Plus
Compressor	Type		Hermetically Sealed Scroll	Hermetically Sealed Scroll
	Piston Displacement	cm <sup>3</sup> /rev	(62.1 × 6) + (43.8 × 1)	62.1 × 7
	Number of Revolution	rev/min	3,600 × 6	3,600 × 7
	Motor Output x Number	W x No.	(5,300 × 6) + (4,200 × 1)	5,300 × 7
	Starting Method		Direct On Line	Direct On Line
Oil Type		FVC68D(PVE)	FVC68D(PVE)	
Fan	Type		Propeller fan	Propeller fan
	Motor Output x Number	W	(900 × 6) + (1,200 × 1)	(900 × 6) + (1,200 × 1)
	Air Flow Rate(High)	m <sup>3</sup> /min	(320 × 3) + (240 × 1)	(320 × 3) + (240 × 1)
		ft <sup>3</sup> /min	(11,301 × 3) + (8,476 × 1)	(11,301 × 3) + (8,476 × 1)
	External Static Pressure (Max, Pa)		DC INVERTER	DC INVERTER
	Drive		80	80
Discharge	Side / Top	TOP	TOP	
Pipe Connections #1	Liquid	mm(inch)	22.2(7/8)	22.2(7/8)
	Low Pressure Gas	mm(inch)	53.98(2-1/8)	53.98(2-1/8)
	High Pressure Gas	mm(inch)	41.3(1-5/8)	41.3(1-5/8)
Pipe Connections #2	Liquid	mm(inch)	22.2(7/8)	22.2(7/8)
	Gas	mm(inch)	53.98(2-1/8)	53.98(2-1/8)

## Note

- Due to our policy of innovation some specifications may be changed without notification.
- Wiring cable size must comply with the applicable local and national codes. And "Electric characteristics" chapter should be considered for electrical work and design. Especially the power cable and circuit breaker should be selected in accordance with that.
- Sound pressure level is measured on the rated condition in the anechoic rooms by ISO 3745 standard.  
Sound power level is measured on the rated condition in the reverberation rooms by ISO 3741 standard.  
Therefore, these values can be increased owing to ambient conditions during operation.
- Sound values of combination model are calculated values based on sound results of independent models.  
Sound values can be increased owing to ambient or installation conditions during operation.  
Sound values of system [dB(A)] = 10\*log [10<sup>A1</sup>(A1/10)+ ... +10<sup>An</sup>(An/10)] , A1~An means sound values of independent models.
- Performances are based on the following conditions :
  - \*Cooling : Indoor Ambient Temp. 27°CDB / 19°CWB, Outdoor Ambient Temp. 35°CDB / 24°CWB
  - \*Heating : Indoor Ambient Temp. 20°CDB / 15°CWB, Outdoor Ambient Temp. 7°CDB / 6°CWB
  - Interconnected Pipe Length is 7.5m and difference of Elevation (Outdoor ~ Indoor Unit) is 0m.
- EUROVENT Test Condition :
  - Performance values in this PDB are based on Ceiling concealed duct combination.
  - Refer to EUROVENT web site([www.eurovent-certification.com](http://www.eurovent-certification.com)) for other indoor unit combination and more detail test conditions.
- \*\*\* : The number in parentheses means maximum connectable indoor units in accordance with outdoor units combination (160~200%).  
The recommended ratio is 130%.
- This product contains Fluorinated greenhouse gases.(R410A, GWP(Global warming potential) = 2,087.5)
- #1 : Heat Recovery system, #2 : Heat Pump system

# 1. Specifications

HP			82	84
Model Name	Combination Unit		ARUM820LTE5	ARUM840LTE5
	Independent Unit		ARUM240LTE5	ARUM240LTE5
			ARUM240LTE5	ARUM240LTE5
			ARUM220LTE5	ARUM240LTE5
			ARUM120LTE5	ARUM120LTE5
Dimensions(W x H x D)	mm	(1,240 × 1,690 × 760) × 3 + (930 × 1,690 × 760) × 1	(1,240 × 1,690 × 760) × 3 + (930 × 1,690 × 760) × 1	
	inch	(48-13/16 × 66-17/32 × 29-29/32) × 3 + (36-5/8 × 66-17/32 × 29-29/32) × 1	(48-13/16 × 66-17/32 × 29-29/32) × 3 + (36-5/8 × 66-17/32 × 29-29/32) × 1	
Net Weight	kg	(310 × 2) + (300 × 1) + (215 × 1)	(310 × 3) + (215 × 1)	
	lbs	(683 × 2) + (661 × 1) + (474 × 1)	(683 × 3) + (474 × 1)	
Sound Pressure Level	Cooling	dB(A)	70.0	70.1
	Heating	dB(A)	71.6	72.1
Sound Power Level	Cooling	dB(A)	95.9	95.9
	Heating	dB(A)	97.9	97.9
Protection Devices	High pressure protection		High pressure sensor / High pressure switch	
	Compressor/Fan		Over-heat protection / Fan driver overload protector	
	Inverter		Over-heat protection / Over-current protection	
Communication Cable (VCTF-SB)		No. xmm <sup>2</sup>	2C × 1.0 ~ 1.5	2C × 1.0 ~ 1.5
Refrigerant	Refrigerant name		R410A	R410A
	Precharged Amount	kg	59.5	60.5
		lbs	131.2	133.4
	t-CO <sub>2</sub> eq		124.206	126.294
Control		Electronic Expansion Valve	Electronic Expansion Valve	
Power Supply		V, Ø, Hz	380-400-415, 3, 50/60	380-400-415, 3, 50/60
Running Current	Cooling (Rated)	A	95.49 - 90.72 - 87.44	97.95 - 93.06 - 89.69
	Heating (Max)	A	103.2 - 98.04 - 94.50	106.6 - 101.3 - 97.61
Number of maximum connectable indoor units ***			64	64

### Note

- Due to our policy of innovation some specifications may be changed without notification.
- Wiring cable size must comply with the applicable local and national codes. And "Electric characteristics" chapter should be considered for electrical work and design. Especially the power cable and circuit breaker should be selected in accordance with that.
- Sound pressure level is measured on the rated condition in the anechoic rooms by ISO 3745 standard.  
Sound power level is measured on the rated condition in the reverberation rooms by ISO 3741 standard.  
Therefore, these values can be increased owing to ambient conditions during operation.
- Sound values of combination model are calculated values based on sound results of independent models.  
Sound values can be increased owing to ambient or installation conditions during operation.  
Sound values of system [dB(A)] =  $10 \cdot \log [10^{A1/10} + \dots + 10^{An/10}]$ , A1~An means sound values of independent models.
- Performances are based on the following conditions :
  - \*Cooling : Indoor Ambient Temp. 27°CDB / 19°CWB, Outdoor Ambient Temp. 35°CDB / 24°CWB
  - \*Heating : Indoor Ambient Temp. 20°CDB / 15°CWB, Outdoor Ambient Temp. 7°CDB / 6°CWB
  - Interconnected Pipe Length is 7.5m and difference of Elevation (Outdoor ~ Indoor Unit) is 0m.
- EUROVENT Test Condition :
  - Performance values in this PDB are based on Ceiling concealed duct combination.
  - Refer to EUROVENT web site([www.eurovent-certification.com](http://www.eurovent-certification.com)) for other indoor unit combination and more detail test conditions.
- \*\*\* : The number in parentheses means maximum connectable indoor units in accordance with outdoor units combination (160~200%).  
The recommended ratio is 130%.
- This product contains Fluorinated greenhouse gases.(R410A, GWP(Global warming potential) = 2,087.5)
- #1 : Heat Recovery system, #2 : Heat Pump system

# 1. Specifications

HP			86	88
Model Name	Combination Unit		ARUM860LTE5	ARUM880LTE5
	Independent Unit		ARUM240LTE5	ARUM240LTE5
			ARUM240LTE5	ARUM240LTE5
			ARUM240LTE5	ARUM240LTE5
			ARUM140LTE5	ARUM160LTE5
Capacity	Cooling (Rated)	kW	240.8	246.4
		Btu/h	821,600	840,700
	Heating (Rated.)	kW	240.8	246.4
		Btu/h	821,600	840,700
	Heating (Max.)	kW	266.9	273.2
		Btu/h	910,600	932,000
Input	Cooling (Rated)	kW	60.90	63.13
	Heating (Rated)	kW	56.15	57.95
	Heating (Max.)	kW	66.12	68.79
EER (Rated)			3.95	3.90
COP	Rated capacity		4.29	4.25
	Max. capacity		4.04	3.97
SEER			8.10	8.02
SCOP			4.40	4.44
Exterior	Color		Warm Gray / Dawn Gray	Warm Gray / Dawn Gray
	RAL (Classic)		RAL 7044 / RAL 7037	RAL 7044 / RAL 7037
Heat Exchanger			Wide Louver Plus	Wide Louver Plus
Compressor	Type		Hermetically Sealed Scroll	Hermetically Sealed Scroll
	Piston Displacement	cm <sup>3</sup> /rev	62.1 × 7	62.1 × 7
	Number of Revolution	rev/min	3,600 × 7	3,600 × 7
	Motor Output x Number	W x No.	5,300 × 7	5,300 × 7
	Starting Method		Direct On Line	Direct On Line
	Oil Type		FVC68D(PVE)	FVC68D(PVE)
Fan	Type		Propeller fan	Propeller fan
	Motor Output x Number	W	900 × 8	900 × 8
	Air Flow Rate(High)	m <sup>3</sup> /min	320 × 4	320 × 4
		ft <sup>3</sup> /min	11,301 × 4	11,301 × 4
	External Static Pressure (Max, Pa)		DC INVERTER	DC INVERTER
	Drive		80	80
	Discharge	Side / Top	TOP	TOP
Pipe Connections #1	Liquid	mm(inch)	22.2(7/8)	22.2(7/8)
	Low Pressure Gas	mm(inch)	53.98(2-1/8)	53.98(2-1/8)
	High Pressure Gas	mm(inch)	41.3(1-5/8)	41.3(1-5/8)
Pipe Connections #2	Liquid	mm(inch)	22.2(7/8)	22.2(7/8)
	Gas	mm(inch)	53.98(2-1/8)	53.98(2-1/8)
Dimensions(W x H x D)		mm	(1,240 × 1,690 × 760) × 4	(1,240 × 1,690 × 760) × 4
		inch	(48-13/16 × 66-17/32 × 29-29/32) × 4	(48-13/16 × 66-17/32 × 29-29/32) × 4

## Note

- Due to our policy of innovation some specifications may be changed without notification.
- Wiring cable size must comply with the applicable local and national codes. And "Electric characteristics" chapter should be considered for electrical work and design. Especially the power cable and circuit breaker should be selected in accordance with that.
- Sound pressure level is measured on the rated condition in the anechoic rooms by ISO 3745 standard.  
Sound power level is measured on the rated condition in the reverberation rooms by ISO 3741 standard.  
Therefore, these values can be increased owing to ambient conditions during operation.
- Sound values of combination model are calculated values based on sound results of independent models.  
Sound values can be increased owing to ambient or installation conditions during operation.  
Sound values of system [dB(A)] = 10\*log [10<sup>A1</sup>(A1/10)+ ... +10<sup>An</sup>(An/10)] , A1~An means sound values of independent models.
- Performances are based on the following conditions :
  - \*Cooling : Indoor Ambient Temp. 27°CDB / 19°CWB, Outdoor Ambient Temp. 35°CDB / 24°CWB
  - \*Heating : Indoor Ambient Temp. 20°CDB / 15°CWB, Outdoor Ambient Temp. 7°CDB / 6°CWB
  - Interconnected Pipe Length is 7.5m and difference of Elevation (Outdoor ~ Indoor Unit) is 0m.
- EUROVENT Test Condition :
  - Performance values in this PDB are based on Ceiling concealed duct combination.
  - Refer to EUROVENT web site([www.eurovent-certification.com](http://www.eurovent-certification.com)) for other indoor unit combination and more detail test conditions.
- \*\*\* : The number in parentheses means maximum connectable indoor units in accordance with outdoor units combination (160~200%).  
The recommended ratio is 130%.
- This product contains Fluorinated greenhouse gases.(R410A, GWP(Global warming potential) = 2,087.5)
- #1 : Heat Recovery system, #2 : Heat Pump system

# 1. Specifications

HP			86	88
Model Name	Combination Unit		ARUM860LTE5	ARUM880LTE5
	Independent Unit		ARUM240LTE5	ARUM240LTE5
			ARUM240LTE5	ARUM240LTE5
			ARUM240LTE5	ARUM240LTE5
			ARUM140LTE5	ARUM160LTE5
Net Weight		kg	(310 × 3) + (237 × 1)	(310 × 3) + (237 × 1)
		lbs	(683 × 3) + (522 × 1)	(683 × 3) + (522 × 1)
Sound Pressure Level	Cooling	dB(A)	70.2	70.3
	Heating	dB(A)	72.1	72.2
Sound Power Level	Cooling	dB(A)	95.9	96.1
	Heating	dB(A)	97.9	98.1
Protection Devices	High pressure protection		High pressure sensor / High pressure switch	
	Compressor/Fan		Over-heat protection / Fan driver overload protector	
	Inverter		Over-heat protection / Over-current protection	
Communication Cable (VCTF-SB)	No. × mm <sup>2</sup>		2C × 1.0 ~ 1.5	2C × 1.0 ~ 1.5
Refrigerant	Refrigerant name		R410A	R410A
	Precharged Amount	kg	64.5	64.5
		lbs	142.2	142.2
	t-CO <sub>2</sub> eq		134.644	134.644
Control		Electronic Expansion Valve	Electronic Expansion Valve	
Power Supply	V, Ø, Hz		380-400-415, 3, 50/60	380-400-415, 3, 50/60
Running Current	Cooling (Rated)	A	99.53 - 94.56 - 91.14	103.2 - 98.01 - 94.46
	Heating (Max)	A	108.1 - 102.7 - 98.98	113.4 - 107.7 - 103.8
Number of maximum connectable indoor units ***			64	64

### Note

- Due to our policy of innovation some specifications may be changed without notification.
- Wiring cable size must comply with the applicable local and national codes. And "Electric characteristics" chapter should be considered for electrical work and design. Especially the power cable and circuit breaker should be selected in accordance with that.
- Sound pressure level is measured on the rated condition in the anechoic rooms by ISO 3745 standard.  
Sound power level is measured on the rated condition in the reverberation rooms by ISO 3741 standard.  
Therefore, these values can be increased owing to ambient conditions during operation.
- Sound values of combination model are calculated values based on sound results of independent models.  
Sound values can be increased owing to ambient or installation conditions during operation.  
Sound values of system [dB(A)] =  $10 \cdot \log [10^{(A1/10)} + \dots + 10^{(An/10)}]$ , A1~An means sound values of independent models.
- Performances are based on the following conditions :
  - \*Cooling : Indoor Ambient Temp. 27°CDB / 19°CWB, Outdoor Ambient Temp. 35°CDB / 24°CWB
  - \*Heating : Indoor Ambient Temp. 20°CDB / 15°CWB, Outdoor Ambient Temp. 7°CDB / 6°CWB
  - Interconnected Pipe Length is 7.5m and difference of Elevation (Outdoor ~ Indoor Unit) is 0m.
- EUROVENT Test Condition :
  - Performance values in this PDB are based on Ceiling concealed duct combination.
  - Refer to EUROVENT web site([www.eurovent-certification.com](http://www.eurovent-certification.com)) for other indoor unit combination and more detail test conditions.
- \*\*\* : The number in parentheses means maximum connectable indoor units in accordance with outdoor units combination (160~200%).  
The recommended ratio is 130%.
- This product contains Fluorinated greenhouse gases.(R410A, GWP(Global warming potential) = 2,087.5)
- #1 : Heat Recovery system, #2 : Heat Pump system

# 1. Specifications

HP			90	92
Model Name	Combination Unit		ARUM900LTE5	ARUM920LTE5
	Independent Unit		ARUM240LTE5	ARUM240LTE5
			ARUM240LTE5	ARUM240LTE5
			ARUM240LTE5	ARUM240LTE5
			ARUM180LTE5	ARUM200LTE5
Capacity	Cooling (Rated)	kW	252.0	257.6
		Btu/h	859,800	878,900
	Heating (Rated.)	kW	252.0	257.6
		Btu/h	859,800	878,900
	Heating (Max.)	kW	279.5	285.8
		Btu/h	953,500	975,000
Input	Cooling (Rated)	kW	63.26	64.98
	Heating (Rated)	kW	57.79	59.87
	Heating (Max.)	kW	68.34	71.08
EER (Rated)			3.98	3.96
COP	Rated capacity		4.36	4.30
	Max. capacity		4.09	4.02
SEER			8.01	7.98
SCOP			4.30	4.27
Exterior	Color		Warm Gray / Dawn Gray	Warm Gray / Dawn Gray
	RAL (Classic)		RAL 7044 / RAL 7037	RAL 7044 / RAL 7037
Heat Exchanger			Wide Louver Plus	Wide Louver Plus
Compressor	Type		Hermetically Sealed Scroll	Hermetically Sealed Scroll
	Piston Displacement	cm <sup>3</sup> /rev	(62.1 × 7) + (43.8 × 1)	(62.1 × 7) + (43.8 × 1)
	Number of Revolution	rev/min	3,600 × 8	3,600 × 8
	Motor Output x Number	W x No.	(5,300 × 7) + (4,200 × 1)	(5,300 × 7) + (4,200 × 1)
	Starting Method		Direct On Line	Direct On Line
	Oil Type		FVC68D(PVE)	FVC68D(PVE)
Fan	Type		Propeller fan	Propeller fan
	Motor Output x Number	W	900 × 8	900 × 8
	Air Flow Rate(High)	m <sup>3</sup> /min	320 × 4	320 × 4
		ft <sup>3</sup> /min	11,301 × 4	11,301 × 4
	External Static Pressure (Max, Pa)		DC INVERTER	DC INVERTER
	Drive		80	80
Discharge	Side / Top	TOP	TOP	
Pipe Connections #1	Liquid	mm(inch)	22.2(7/8)	22.2(7/8)
	Low Pressure Gas	mm(inch)	53.98(2-1/8)	53.98(2-1/8)
	High Pressure Gas	mm(inch)	41.3(1-5/8)	41.3(1-5/8)
Pipe Connections #2	Liquid	mm(inch)	22.2(7/8)	22.2(7/8)
	Gas	mm(inch)	53.98(2-1/8)	53.98(2-1/8)
Dimensions(W x H x D)		mm	(1,240 × 1,690 × 760) × 4	(1,240 × 1,690 × 760) × 4
		inch	(48-13/16 × 66-17/32 × 29-29/32) × 4	(48-13/16 × 66-17/32 × 29-29/32) × 4

## Note

- Due to our policy of innovation some specifications may be changed without notification.
- Wiring cable size must comply with the applicable local and national codes. And "Electric characteristics" chapter should be considered for electrical work and design. Especially the power cable and circuit breaker should be selected in accordance with that.
- Sound pressure level is measured on the rated condition in the anechoic rooms by ISO 3745 standard.  
Sound power level is measured on the rated condition in the reverberation rooms by ISO 3741 standard.  
Therefore, these values can be increased owing to ambient conditions during operation.
- Sound values of combination model are calculated values based on sound results of independent models.  
Sound values can be increased owing to ambient or installation conditions during operation.  
Sound values of system [dB(A)] = 10\*log [10<sup>A1</sup>(A1/10)+ ... +10<sup>An</sup>(An/10)] , A1~An means sound values of independent models.
- Performances are based on the following conditions :
  - \*Cooling : Indoor Ambient Temp. 27°CDB / 19°CWB, Outdoor Ambient Temp. 35°CDB / 24°CWB
  - \*Heating : Indoor Ambient Temp. 20°CDB / 15°CWB, Outdoor Ambient Temp. 7°CDB / 6°CWB
  - Interconnected Pipe Length is 7.5m and difference of Elevation (Outdoor ~ Indoor Unit) is 0m.
- EUROVENT Test Condition :
  - Performance values in this PDB are based on Ceiling concealed duct combination.
  - Refer to EUROVENT web site([www.eurovent-certification.com](http://www.eurovent-certification.com)) for other indoor unit combination and more detail test conditions.
- \*\*\* : The number in parentheses means maximum connectable indoor units in accordance with outdoor units combination (160~200%).  
The recommended ratio is 130%.
- This product contains Fluorinated greenhouse gases.(R410A, GWP(Global warming potential) = 2,087.5)
- #1 : Heat Recovery system, #2 : Heat Pump system

# 1. Specifications

HP			90	92
Model Name	Combination Unit		ARUM900LTE5	ARUM920LTE5
	Independent Unit		ARUM240LTE5	ARUM240LTE5
			ARUM240LTE5	ARUM240LTE5
			ARUM240LTE5	ARUM240LTE5
			ARUM180LTE5	ARUM200LTE5
Net Weight		kg	(310 × 3) + (300 × 1)	(310 × 3) + (300 × 1)
		lbs	(683 × 3) + (661 × 1)	(683 × 3) + (661 × 1)
Sound Pressure Level	Cooling	dB(A)	70.3	70.4
	Heating	dB(A)	72.2	72.5
Sound Power Level	Cooling	dB(A)	96.3	96.6
	Heating	dB(A)	98.1	98.4
Protection Devices	High pressure protection		High pressure sensor / High pressure switch	
	Compressor/Fan		Over-heat protection / Fan driver overload protector	
	Inverter		Over-heat protection / Over-current protection	
Communication Cable (VCTF-SB)	No. × mm <sup>2</sup>		2C × 1.0 ~ 1.5	2C × 1.0 ~ 1.5
Refrigerant	Refrigerant name		R410A	R410A
	Precharged Amount	kg	67.0	67.0
		lbs	147.7	147.7
	t-CO <sub>2</sub> eq		139.863	139.863
Control		Electronic Expansion Valve	Electronic Expansion Valve	
Power Supply	V, Ø, Hz		380-400-415, 3, 50/60	380-400-415, 3, 50/60
Running Current	Cooling (Rated)	A	103.3 - 98.18 - 94.62	106.1 - 100.8 - 97.17
	Heating (Max)	A	111.2 - 105.6 - 101.8	116.1 - 110.3 - 106.3
Number of maximum connectable indoor units ***			64	64

### Note

- Due to our policy of innovation some specifications may be changed without notification.
- Wiring cable size must comply with the applicable local and national codes. And "Electric characteristics" chapter should be considered for electrical work and design. Especially the power cable and circuit breaker should be selected in accordance with that.
- Sound pressure level is measured on the rated condition in the anechoic rooms by ISO 3745 standard.  
Sound power level is measured on the rated condition in the reverberation rooms by ISO 3741 standard.  
Therefore, these values can be increased owing to ambient conditions during operation.
- Sound values of combination model are calculated values based on sound results of independent models.  
Sound values can be increased owing to ambient or installation conditions during operation.  
Sound values of system [dB(A)] =  $10 \cdot \log [10^{(A1/10)} + \dots + 10^{(An/10)}]$ , A1~An means sound values of independent models.
- Performances are based on the following conditions :
  - \*Cooling : Indoor Ambient Temp. 27°CDB / 19°CWB, Outdoor Ambient Temp. 35°CDB / 24°CWB
  - \*Heating : Indoor Ambient Temp. 20°CDB / 15°CWB, Outdoor Ambient Temp. 7°CDB / 6°CWB
  - Interconnected Pipe Length is 7.5m and difference of Elevation (Outdoor ~ Indoor Unit) is 0m.
- EUROVENT Test Condition :
  - Performance values in this PDB are based on Ceiling concealed duct combination.
  - Refer to EUROVENT web site([www.eurovent-certification.com](http://www.eurovent-certification.com)) for other indoor unit combination and more detail test conditions.
- \*\*\* : The number in parentheses means maximum connectable indoor units in accordance with outdoor units combination (160~200%).  
The recommended ratio is 130%.
- This product contains Fluorinated greenhouse gases.(R410A, GWP(Global warming potential) = 2,087.5)
- #1 : Heat Recovery system, #2 : Heat Pump system

# 1. Specifications

HP			94	96
Model Name	Combination Unit		ARUM940LTE5	ARUM960LTE5
	Independent Unit		ARUM240LTE5	ARUM240LTE5
			ARUM240LTE5	ARUM240LTE5
			ARUM240LTE5	ARUM240LTE5
			ARUM220LTE5	ARUM240LTE5
Capacity	Cooling (Rated)	kW	263.2	268.8
		Btu/h	898,000	917,100
	Heating (Rated.)	kW	263.2	268.8
		Btu/h	898,000	917,100
	Heating (Max.)	kW	292.1	297.0
		Btu/h	996,500	1,013,400
Input	Cooling (Rated)	kW	68.15	69.64
	Heating (Rated)	kW	61.82	63.56
	Heating (Max.)	kW	73.16	75.19
EER (Rated)			3.86	3.86
COP	Rated capacity		4.26	4.23
	Max. capacity		3.99	3.95
SEER			7.85	7.94
SCOP			4.24	4.36
Exterior	Color		Warm Gray / Dawn Gray	Warm Gray / Dawn Gray
	RAL (Classic)		RAL 7044 / RAL 7037	RAL 7044 / RAL 7037
Heat Exchanger			Wide Louver Plus	Wide Louver Plus
Compressor	Type		Hermetically Sealed Scroll	Hermetically Sealed Scroll
	Piston Displacement	cm <sup>3</sup> /rev	(62.1 × 7) + (43.8 × 1)	62.1 × 8
	Number of Revolution	rev/min	3,600 × 8	3,600 × 8
	Motor Output x Number	W x No.	(5,300 × 7) + (4,200 × 1)	5,300 × 8
	Starting Method		Direct On Line	Direct On Line
Oil Type		FVC68D(PVE)	FVC68D(PVE)	
Fan	Type		Propeller fan	Propeller fan
	Motor Output x Number	W	900 × 8	900 × 8
	Air Flow Rate(High)	m <sup>3</sup> /min	320 × 4	320 × 4
		ft <sup>3</sup> /min	11,301 × 4	11,301 × 4
	External Static Pressure (Max, Pa)		DC INVERTER	DC INVERTER
	Drive		80	80
Discharge	Side / Top	TOP	TOP	
Pipe Connections #1	Liquid	mm(inch)	22.2(7/8)	22.2(7/8)
	Low Pressure Gas	mm(inch)	53.98(2-1/8)	53.98(2-1/8)
	High Pressure Gas	mm(inch)	41.3(1-5/8)	41.3(1-5/8)
Pipe Connections #2	Liquid	mm(inch)	22.2(7/8)	22.2(7/8)
	Gas	mm(inch)	53.98(2-1/8)	53.98(2-1/8)
Dimensions(W x H x D)		mm	(1,240 × 1,690 × 760) × 4	(1,240 × 1,690 × 760) × 4
		inch	(48-13/16 × 66-17/32 × 29-29/32) × 4	(48-13/16 × 66-17/32 × 29-29/32) × 4

## Note

- Due to our policy of innovation some specifications may be changed without notification.
- Wiring cable size must comply with the applicable local and national codes. And "Electric characteristics" chapter should be considered for electrical work and design. Especially the power cable and circuit breaker should be selected in accordance with that.
- Sound pressure level is measured on the rated condition in the anechoic rooms by ISO 3745 standard.  
Sound power level is measured on the rated condition in the reverberation rooms by ISO 3741 standard.  
Therefore, these values can be increased owing to ambient conditions during operation.
- Sound values of combination model are calculated values based on sound results of independent models.  
Sound values can be increased owing to ambient or installation conditions during operation.  
Sound values of system [dB(A)] = 10\*log [10<sup>A1</sup>(A1/10)+ ... +10<sup>An</sup>(An/10)] , A1~An means sound values of independent models.
- Performances are based on the following conditions :
  - \*Cooling : Indoor Ambient Temp. 27°CDB / 19°CWB, Outdoor Ambient Temp. 35°CDB / 24°CWB
  - \*Heating : Indoor Ambient Temp. 20°CDB / 15°CWB, Outdoor Ambient Temp. 7°CDB / 6°CWB
  - Interconnected Pipe Length is 7.5m and difference of Elevation (Outdoor ~ Indoor Unit) is 0m.
- EUROVENT Test Condition :
  - Performance values in this PDB are based on Ceiling concealed duct combination.
  - Refer to EUROVENT web site([www.eurovent-certification.com](http://www.eurovent-certification.com)) for other indoor unit combination and more detail test conditions.
- \*\*\* : The number in parentheses means maximum connectable indoor units in accordance with outdoor units combination (160~200%).  
The recommended ratio is 130%.
- This product contains Fluorinated greenhouse gases.(R410A, GWP(Global warming potential) = 2,087.5)
- #1 : Heat Recovery system, #2 : Heat Pump system



# 1. Specifications

HP			94	96
Model Name	Combination Unit		ARUM940LTE5	ARUM960LTE5
	Independent Unit		ARUM240LTE5	ARUM240LTE5
			ARUM240LTE5	ARUM240LTE5
			ARUM240LTE5	ARUM240LTE5
			ARUM220LTE5	ARUM240LTE5
Net Weight		kg	(310 × 3) + (300 × 1)	310 × 4
		lbs	(683 × 3) + (661 × 1)	683 × 4
Sound Pressure Level	Cooling	dB(A)	70.9	71.0
	Heating	dB(A)	72.7	73.0
Sound Power Level	Cooling	dB(A)	97.0	97.0
	Heating	dB(A)	99.0	99.0
Protection Devices	High pressure protection		High pressure sensor / High pressure switch	
	Compressor/Fan		Over-heat protection / Fan driver overload protector	
	Inverter		Over-heat protection / Over-current protection	
Communication Cable (VCTF-SB)	No. × mm <sup>2</sup>		2C × 1.0 ~ 1.5	2C × 1.0 ~ 1.5
Refrigerant	Refrigerant name		R410A	R410A
	Precharged Amount	kg	67.0	68.0
		lbs	147.7	149.9
	t-CO <sub>2</sub> eq		139.863	141.950
Control		Electronic Expansion Valve	Electronic Expansion Valve	
Power Supply	V, Ø, Hz		380-400-415, 3, 50/60	380-400-415, 3, 50/60
Running Current	Cooling (Rated)	A	111.3 - 105.8 - 101.9	113.8 - 108.1 - 104.2
	Heating (Max)	A	119.5 - 113.5 - 109.4	122.8 - 116.7 - 112.4
Number of maximum connectable indoor units ***			64	64

### Note

- Due to our policy of innovation some specifications may be changed without notification.
- Wiring cable size must comply with the applicable local and national codes. And "Electric characteristics" chapter should be considered for electrical work and design. Especially the power cable and circuit breaker should be selected in accordance with that.
- Sound pressure level is measured on the rated condition in the anechoic rooms by ISO 3745 standard.  
Sound power level is measured on the rated condition in the reverberation rooms by ISO 3741 standard.  
Therefore, these values can be increased owing to ambient conditions during operation.
- Sound values of combination model are calculated values based on sound results of independent models.  
Sound values can be increased owing to ambient or installation conditions during operation.  
Sound values of system [dB(A)] =  $10 \cdot \log [10^{(A1/10)} + \dots + 10^{(An/10)}]$ , A1~An means sound values of independent models.
- Performances are based on the following conditions :
  - \*Cooling : Indoor Ambient Temp. 27°CDB / 19°CWB, Outdoor Ambient Temp. 35°CDB / 24°CWB
  - \*Heating : Indoor Ambient Temp. 20°CDB / 15°CWB, Outdoor Ambient Temp. 7°CDB / 6°CWB
  - Interconnected Pipe Length is 7.5m and difference of Elevation (Outdoor ~ Indoor Unit) is 0m.
- EUROVENT Test Condition :
  - Performance values in this PDB are based on Ceiling concealed duct combination.
  - Refer to EUROVENT web site([www.eurovent-certification.com](http://www.eurovent-certification.com)) for other indoor unit combination and more detail test conditions.
- \*\*\* : The number in parentheses means maximum connectable indoor units in accordance with outdoor units combination (160~200%).  
The recommended ratio is 130%.
- This product contains Fluorinated greenhouse gases.(R410A, GWP(Global warming potential) = 2,087.5)
- #1 : Heat Recovery system, #2 : Heat Pump system

# 2. Dimensions

## ARUM080LTE5 / ARUM100LTE5 / ARUM120LTE5

[Unit: mm]  
Chassis code : UXA

Gravity point

**Note**

- Unit should be installed in compliance with the installation manual in the product box.
- Unit should be grounded in accordance with the local regulations or applicable national codes.
- All electrical components and materials to be supplied from the site must comply with the local regulations or international codes.
- Electrical characteristics chapter should be considered for electrical work and design. Especially the power cable and circuit breaker should be selected in accordance with that.

System	Heat Recovery		Heat Pump	
	Liquid pipe	High Pressure Gas pipe	Liquid pipe	Gas pipe
HP				
8	Ø 9.52 (3/8)	Ø 15.88 (5/8)	Ø 9.52 (3/8)	Ø 19.05 (3/4)
10	Ø 9.52 (3/8)	Ø 19.05 (3/4)	Ø 9.52 (3/8)	Ø 22.2 (7/8)
12	Ø 12.7 (1/2)	Ø 28.58 (1-1/8)	Ø 12.7 (1/2)	Ø 28.58 (1-1/8)

No.	Part Name	Description
7	Wire routing hole(front)	2- Ø 30
6	Power cord routing hole(front)	2- Ø 45
5	Pipe routing hole(bottom)	2- Ø 66, Ø 53.88
4	Pipe routing hole(front)	-
3	Power cord routing hole(bottom)	2- Ø 50
2	Wire routing hole(bottom)	2- Ø 22.2
1	Leakage test hole(side)	Ø 22.2
	Part Name	Description

# 2. Dimensions

## ARUM140LTE5 / ARUM160LTE5 / ARUM180LTE5 / ARUM200LTE5 ARUM220LTE5 / ARUM240LTE5 / ARUM260LTE5

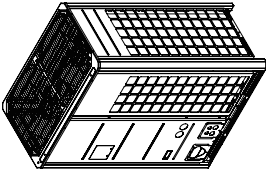
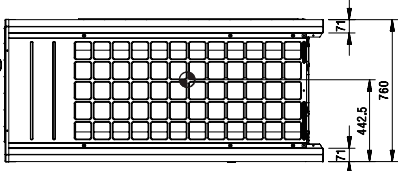
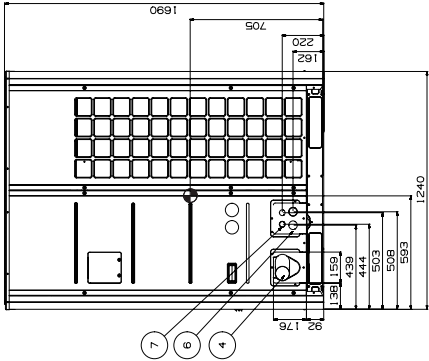
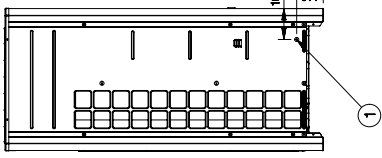

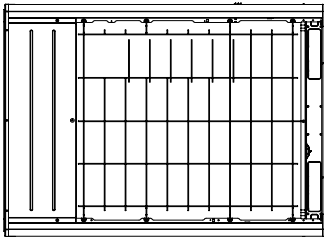



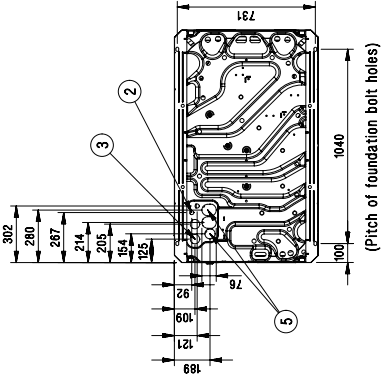

System	Heat Recovery		Heat Pump	
	Liquid pipe	High Pressure Gas pipe	Liquid pipe	Gas pipe
HP				
14-16	Ø 12.7 (1/2)	Ø 28.58 (1-1/8)	Ø 12.7 (1/2)	Ø 28.58 (1-1/8)
18-20	Ø 15.88 (5/8)	Ø 28.58 (1-1/8)	Ø 22.2 (7/8)	Ø 28.58 (1-1/8)
22	Ø 15.88 (5/8)	Ø 28.58 (1-1/8)	Ø 15.88 (5/8)	Ø 28.58 (1-1/8)
24	Ø 15.88 (5/8)	Ø 34.9 (1-3/8)	Ø 28.58 (5/8)	Ø 34.9 (1-3/8)
26-34	Ø 19.05 (3/4)	Ø 34.9 (1-3/8)	Ø 28.58 (1-1/8)	Ø 34.9 (1-3/8)
36	Ø 19.05 (3/4)	Ø 41.3 (1-5/8)	Ø 28.58 (1-1/8)	Ø 41.3 (1-5/8)
38-40	Ø 19.05 (3/4)	Ø 41.3 (1-5/8)	Ø 28.58 (1-1/8)	Ø 41.3 (1-5/8)
42-60	Ø 19.05 (3/4)	Ø 41.3 (1-5/8)	Ø 34.9 (1-3/8)	Ø 41.3 (1-5/8)
62-64	Ø 22.2 (7/8)	Ø 41.3 (1-5/8)	Ø 34.9 (1-3/8)	Ø 41.3 (1-5/8)
66-96	Ø 22.2 (7/8)	Ø 53.98 (2-1/8)	Ø 41.3 (1-5/8)	Ø 53.98 (2-1/8)

**Note**

- Unit should be installed in compliance with the installation manual in the product box.
- Unit should be grounded in accordance with the local regulations or applicable national codes.
- All electrical components and materials to be supplied from the site must comply with the local regulations or international codes.
- Electrical characteristics chapter should be considered for electrical work and design. Especially the power cable and circuit breaker should be selected in accordance with that.



(Pitch of foundation bolt holes)

No.	Part Name	Description
7	Wire routing hole(front)	2- Ø 30
6	Power cord routing hole(front)	2- Ø 45
5	Pipe routing hole(bottom)	2- Ø 66, Ø 53.88
4	Pipe routing hole(front)	-
3	Power cord routing hole(bottom)	2- Ø 50
2	Wire routing hole(bottom)	2- Ø 22.2
1	Leakage test hole(side)	Ø 22.2

[Unit: mm]  
Chassis code : UXB  
● Gravity point

### 3. Piping Diagrams

#### 3.1 8 / 10 / 12 / 14 / 16 HP (1 Comp)

##### 3.1.1 Heat Recovery System

##### ■ Cooling Operation

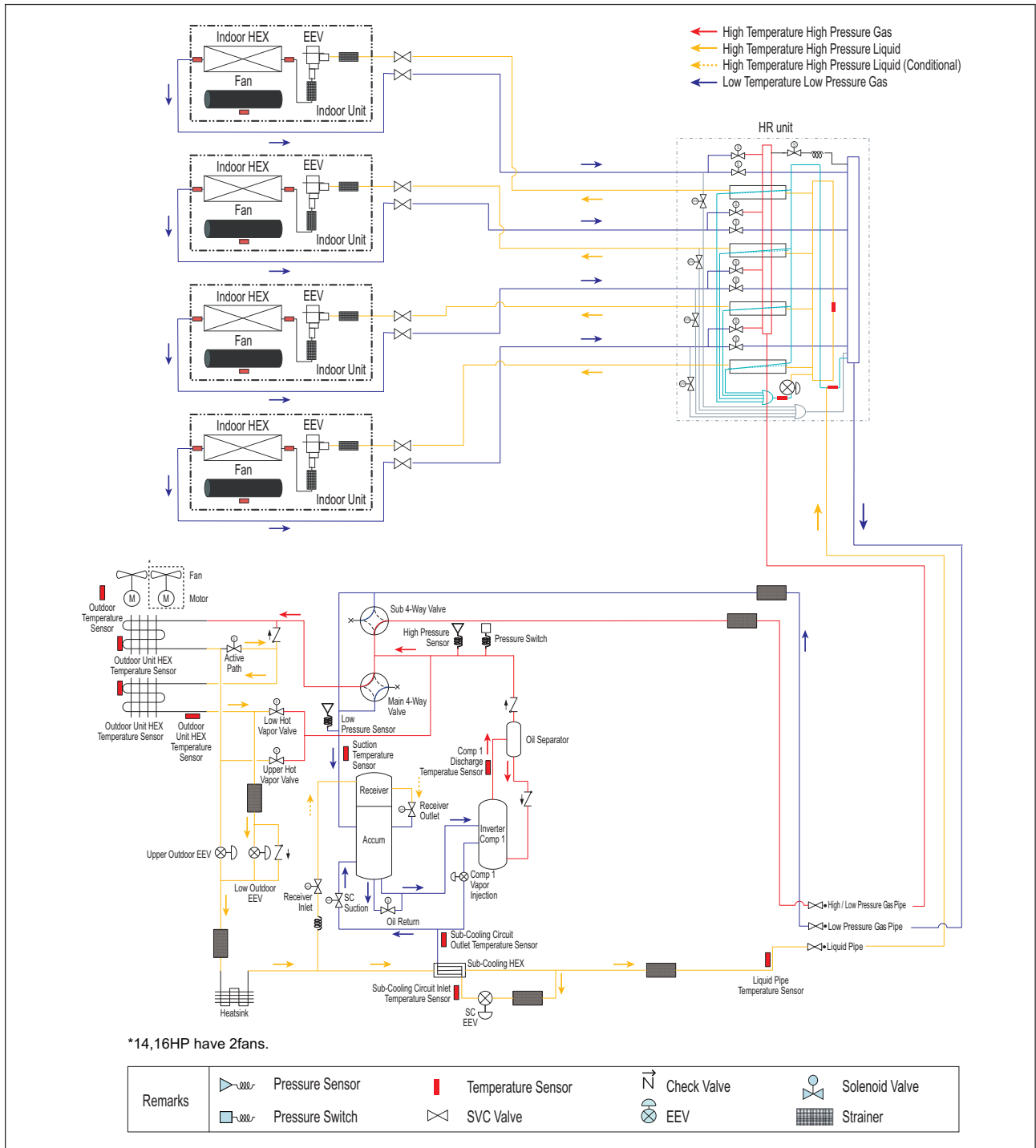

# 3. Piping Diagrams

## ■ Heating Operation

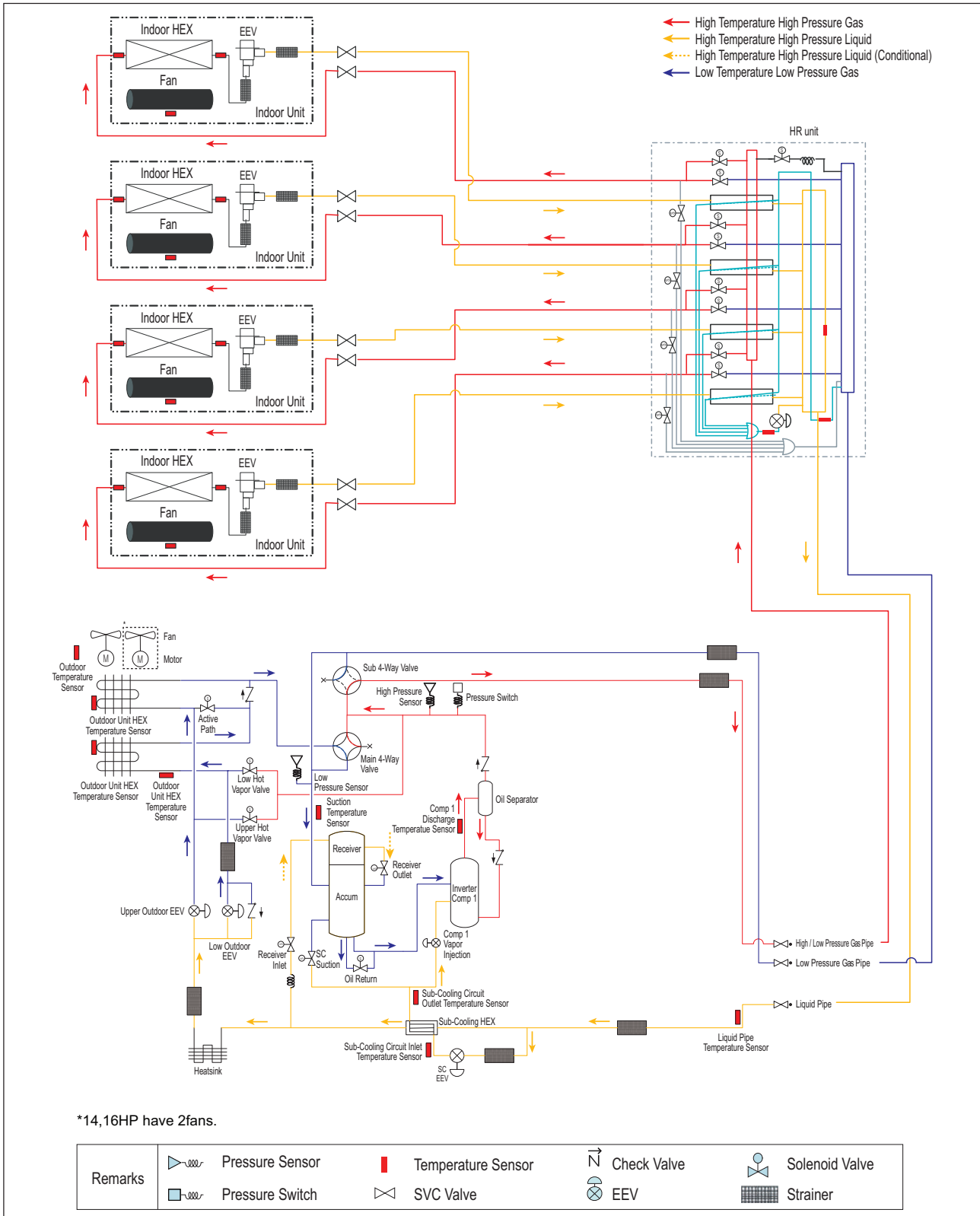

# 3. Piping Diagrams

## Oil Return/ Defrost Operation

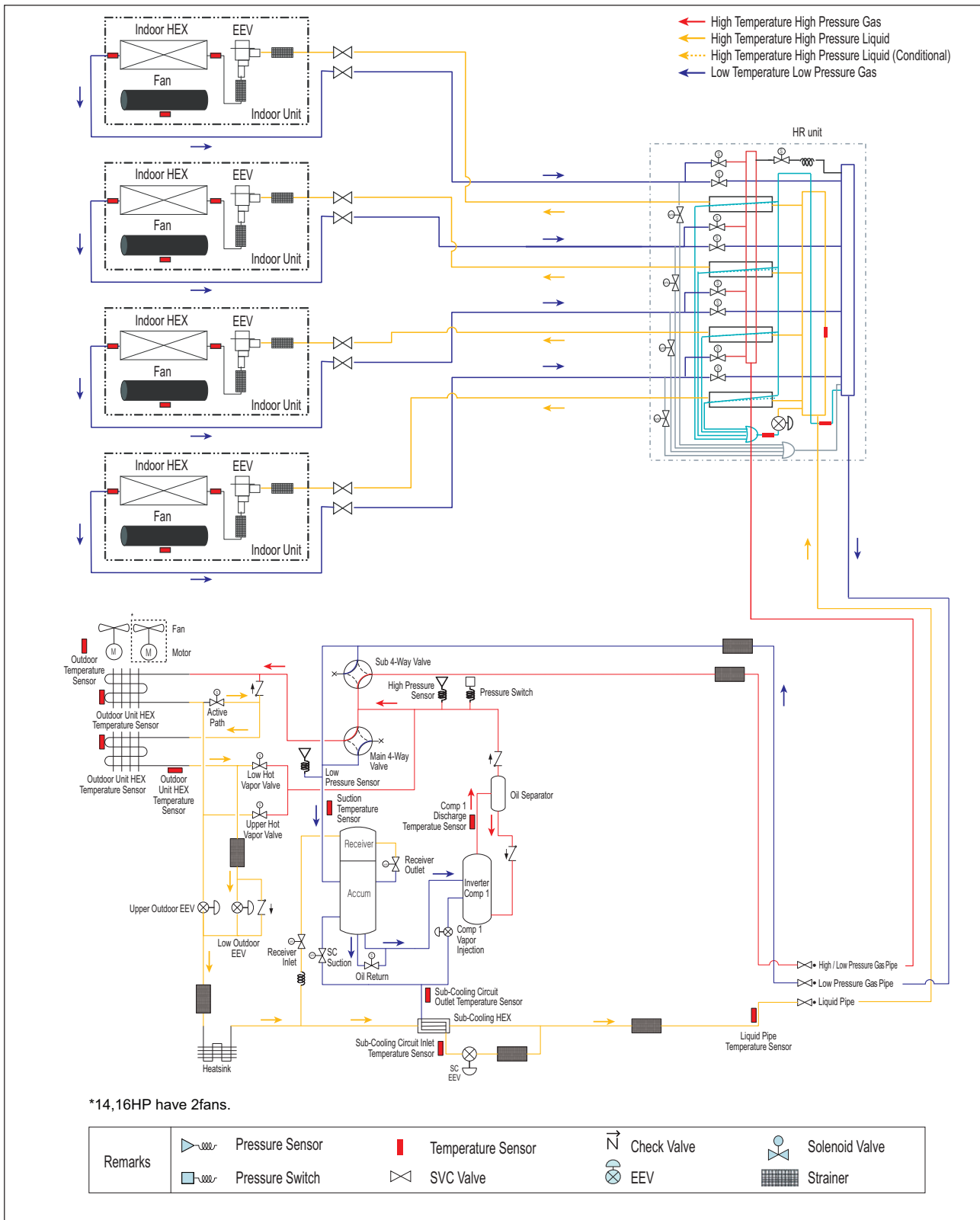

# 3. Piping Diagrams

## ■ Cooling-based Simultaneous Operation

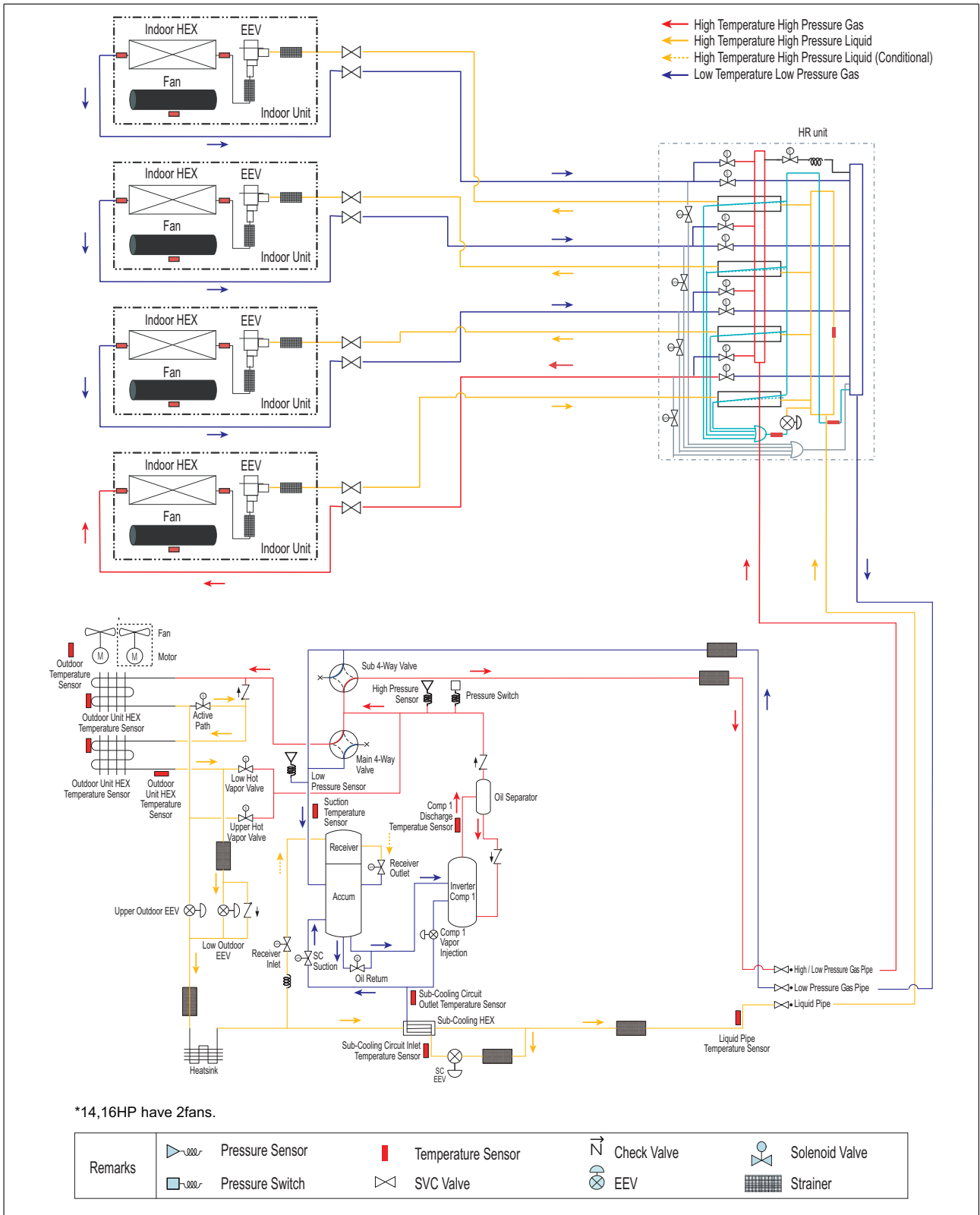

# 3. Piping Diagrams

## ■ Heating-based Simultaneous Operation

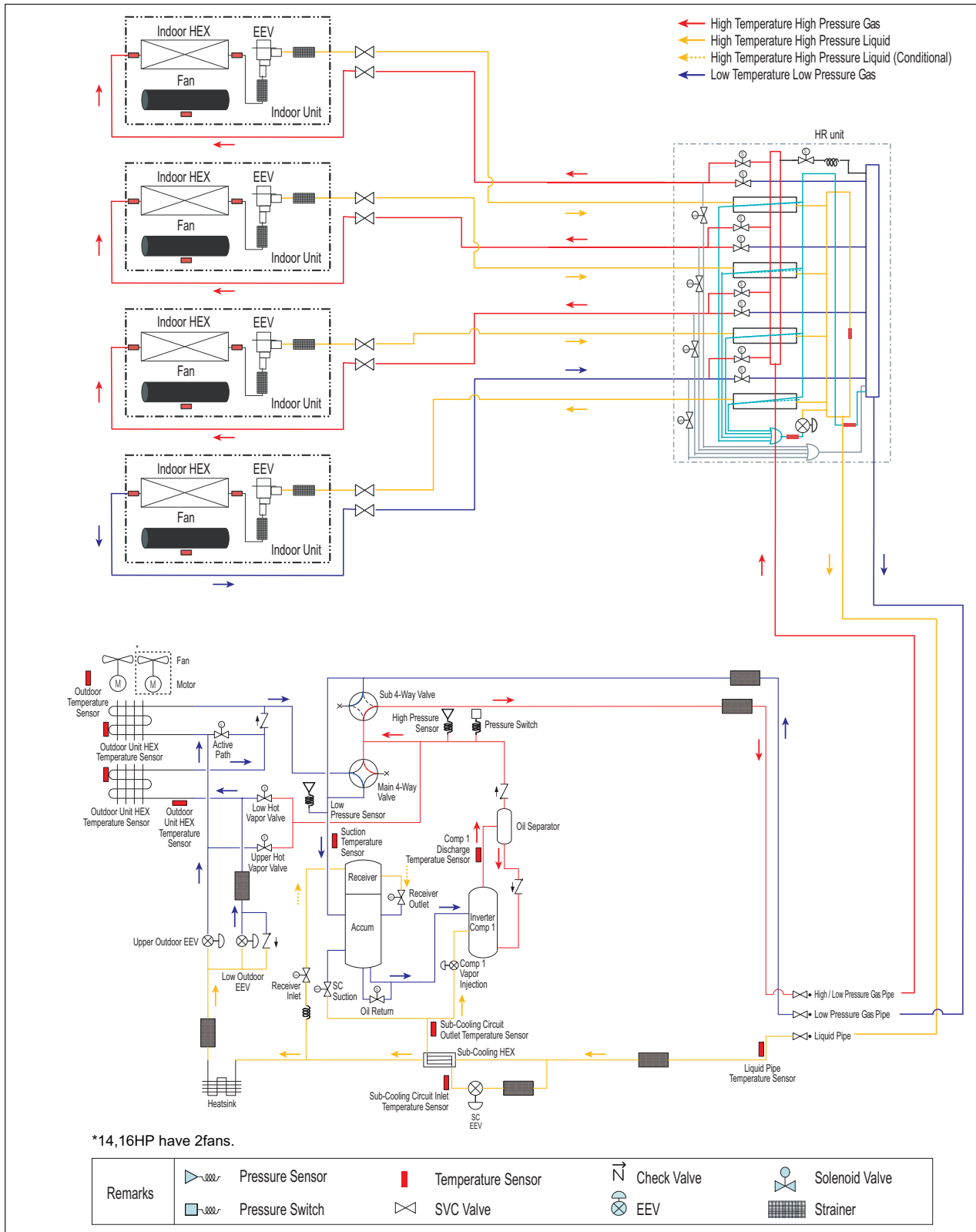



# 3. Piping Diagrams

## Balanced Simultaneous Operation

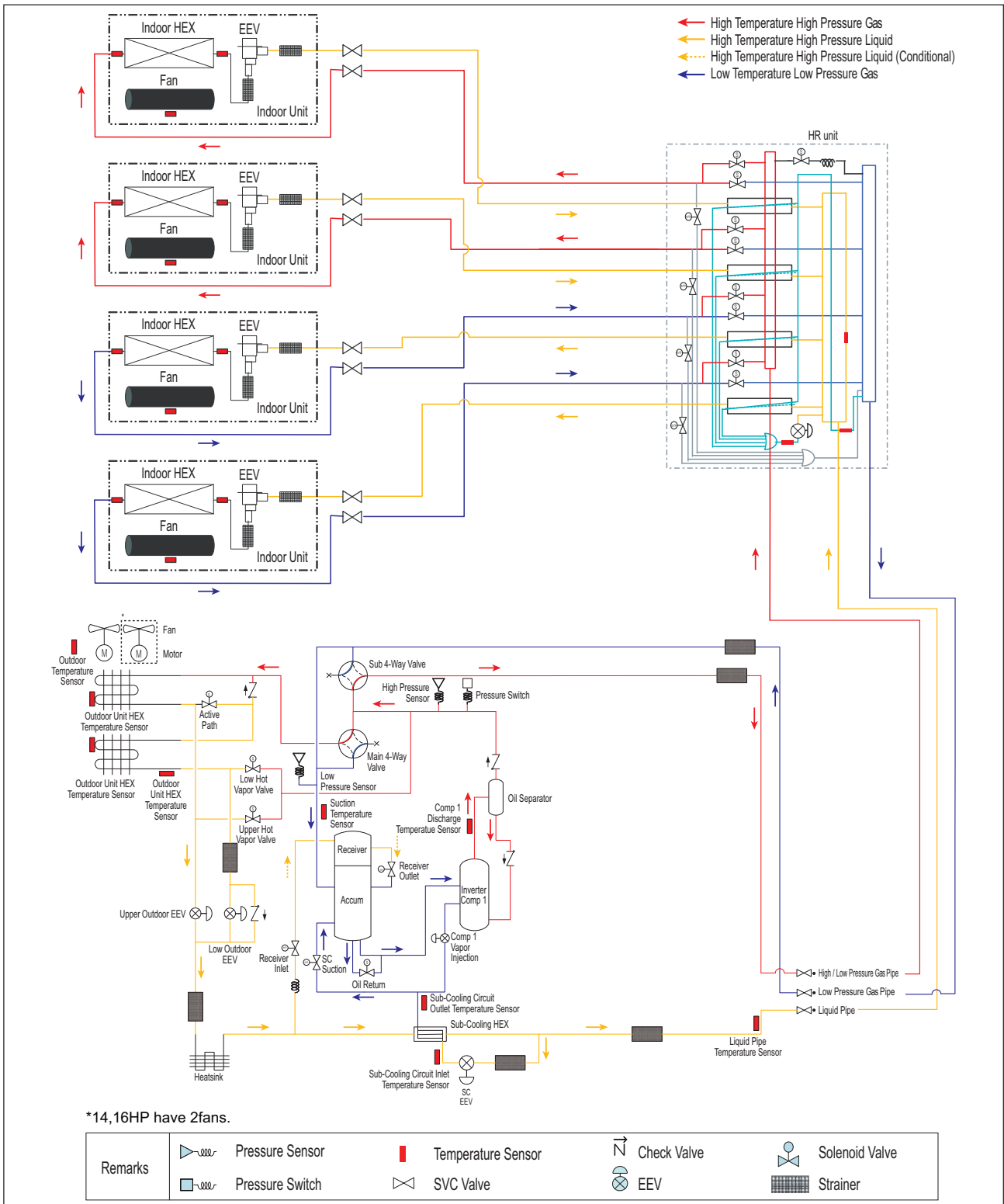

# 3. Piping Diagrams

## ■ Upper HEX Defrost Operation

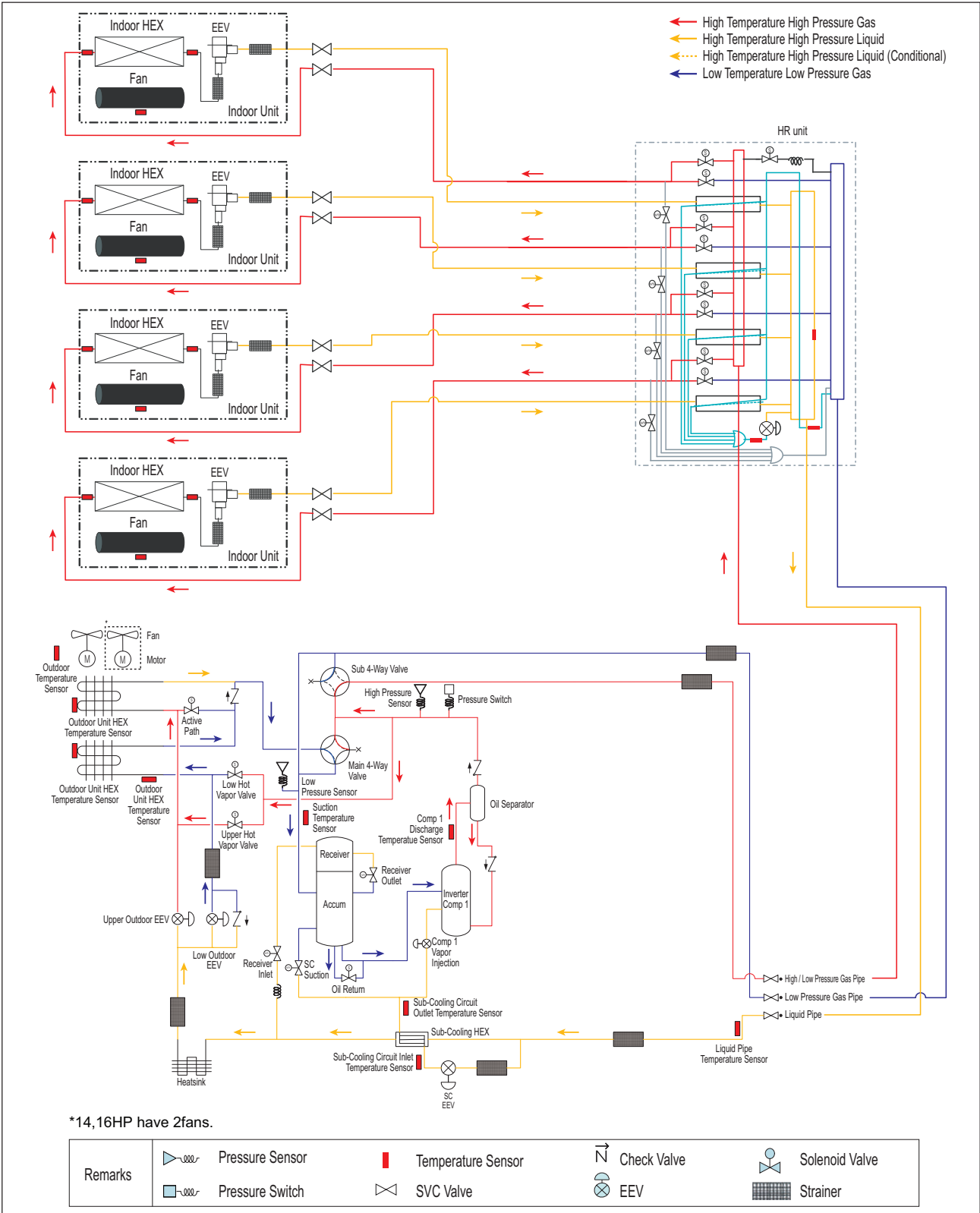

# 3. Piping Diagrams

## Low HEX Defrost Operation

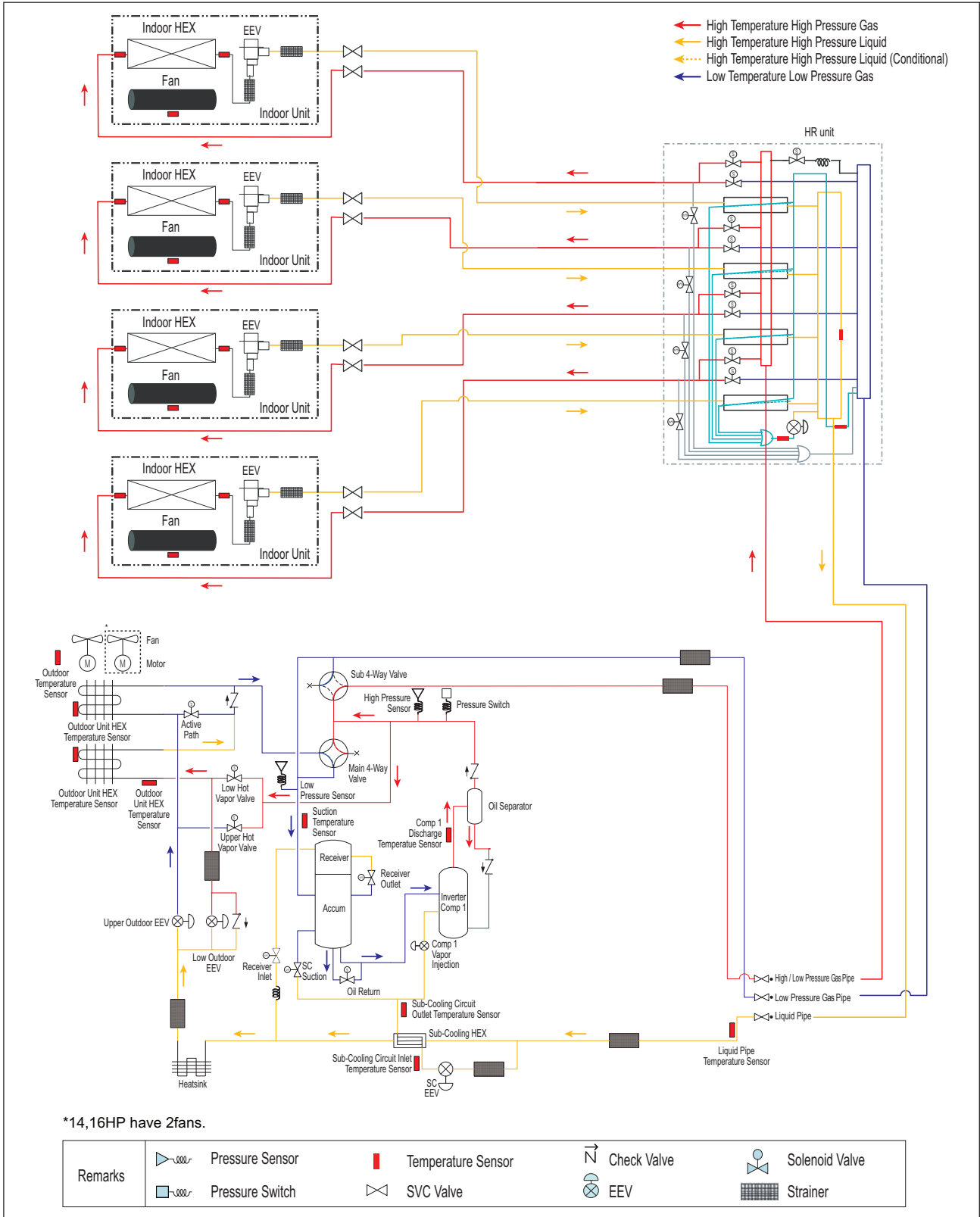

### 3. Piping Diagrams

#### 3.1.2 Heat Pump System

##### ■ Cooling Operation

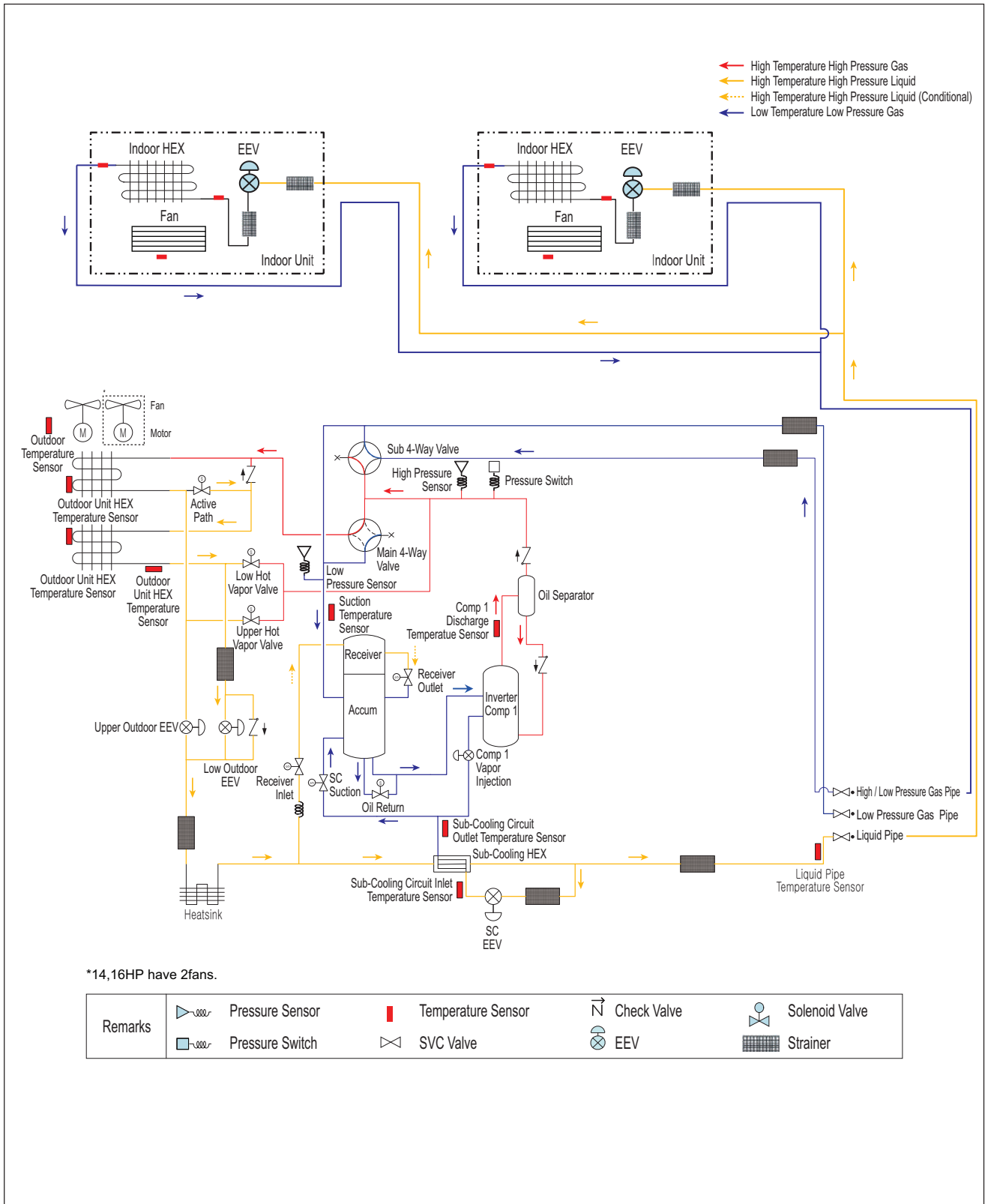

# 3. Piping Diagrams

## ■ Heating Operation

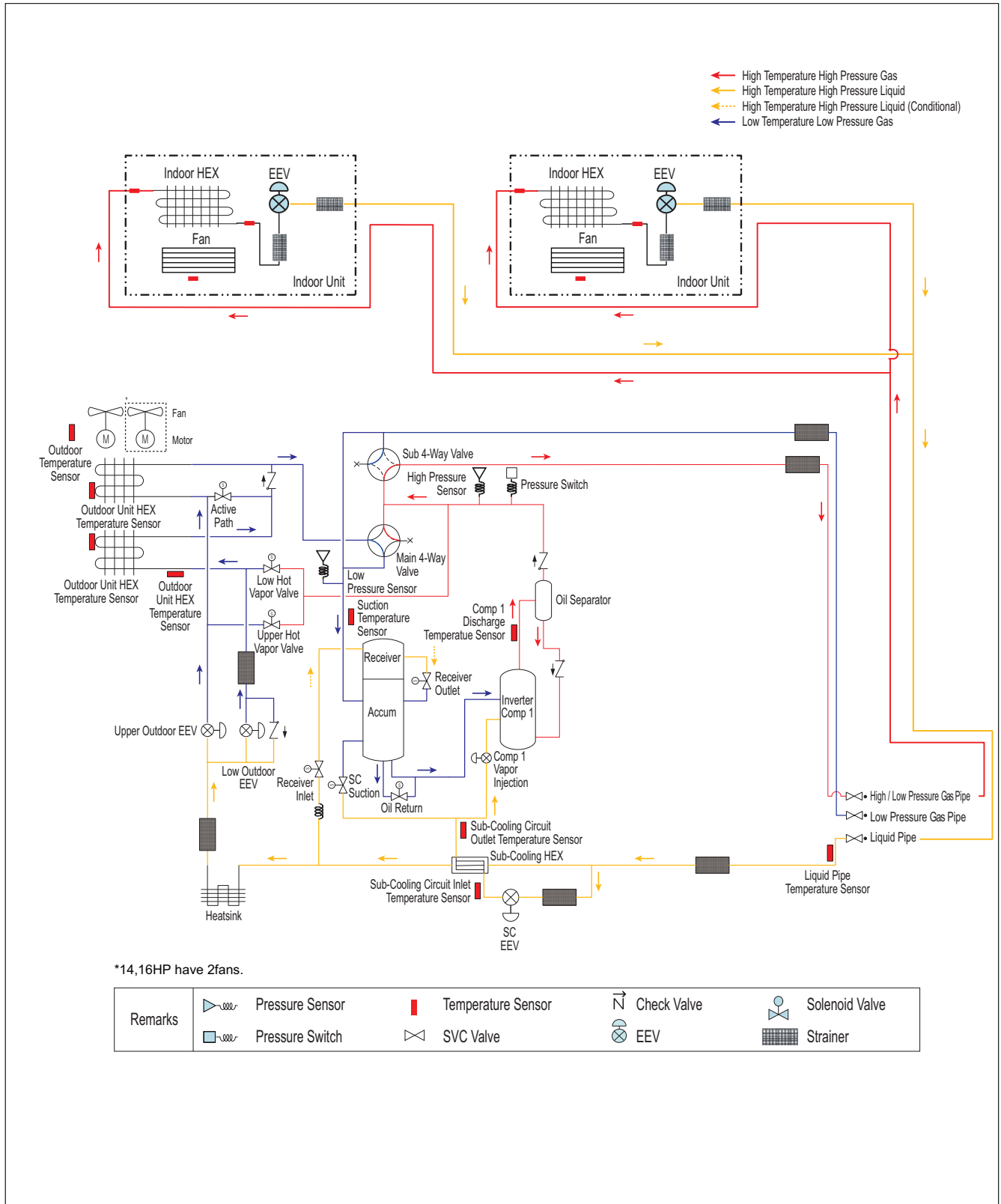

### 3. Piping Diagrams

#### Oil Return/ Defrost Operation

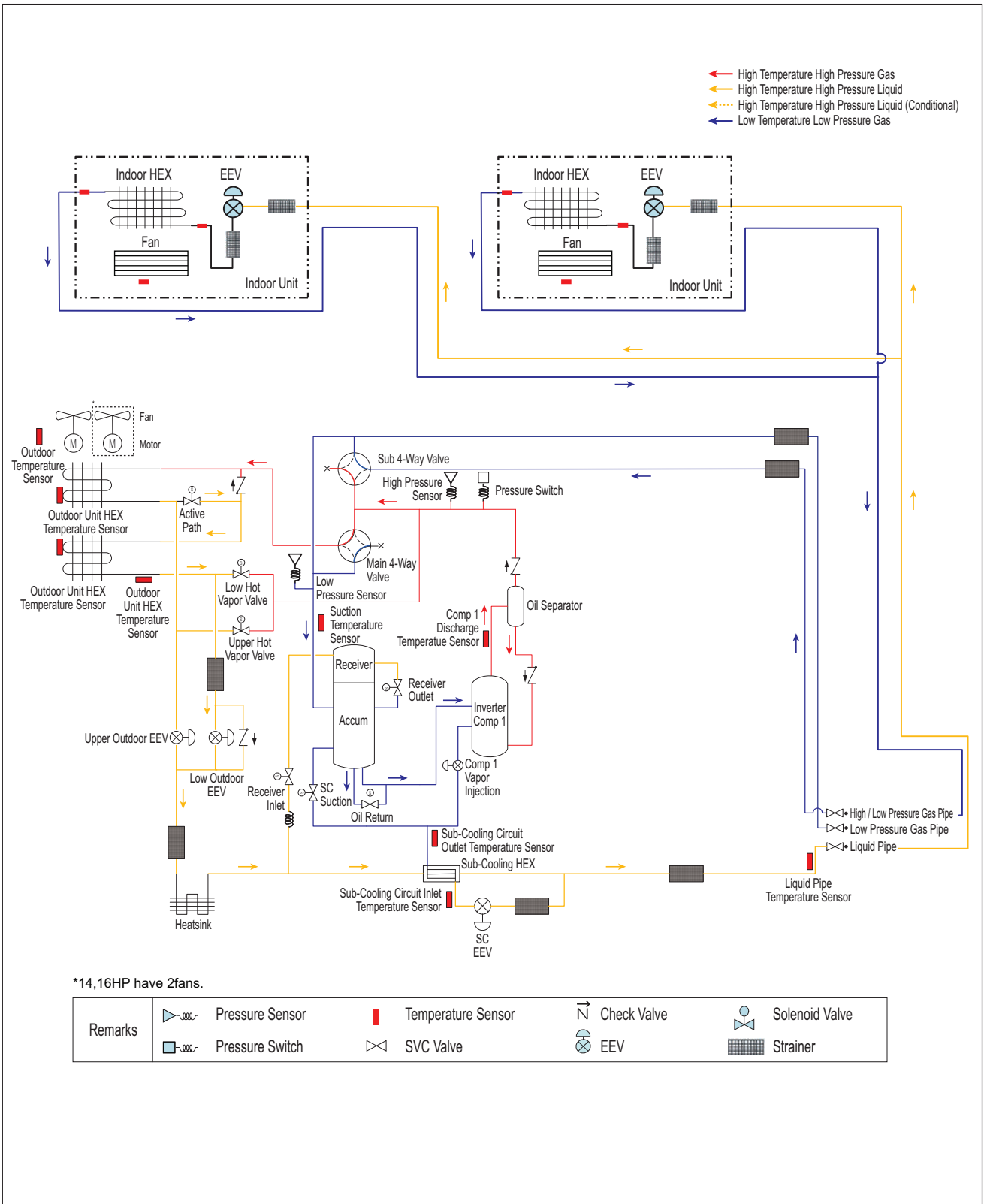

# 3. Piping Diagrams

## Upper HEX Defrost Operation

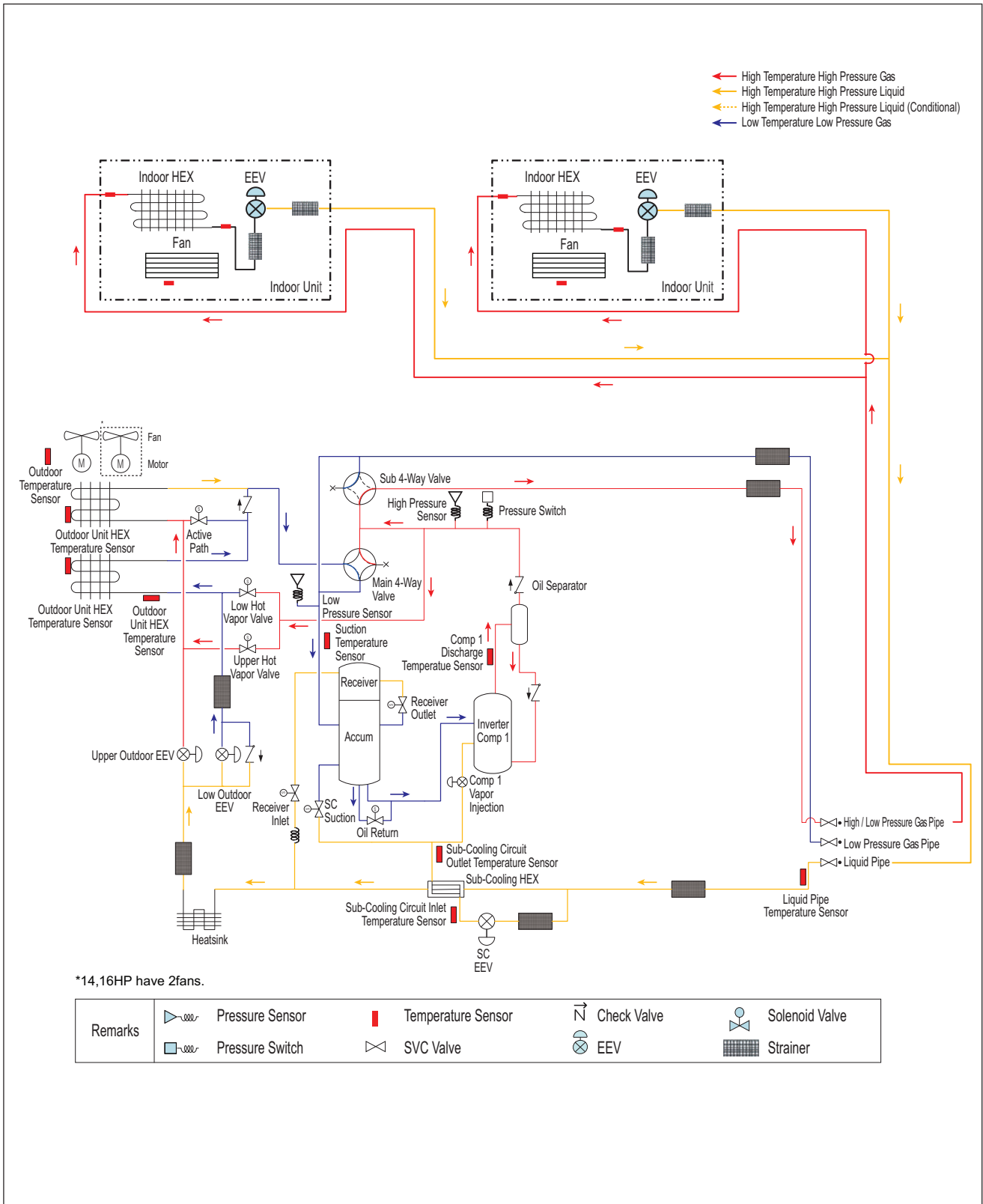

### 3. Piping Diagrams

#### Low HEX Defrost Operation

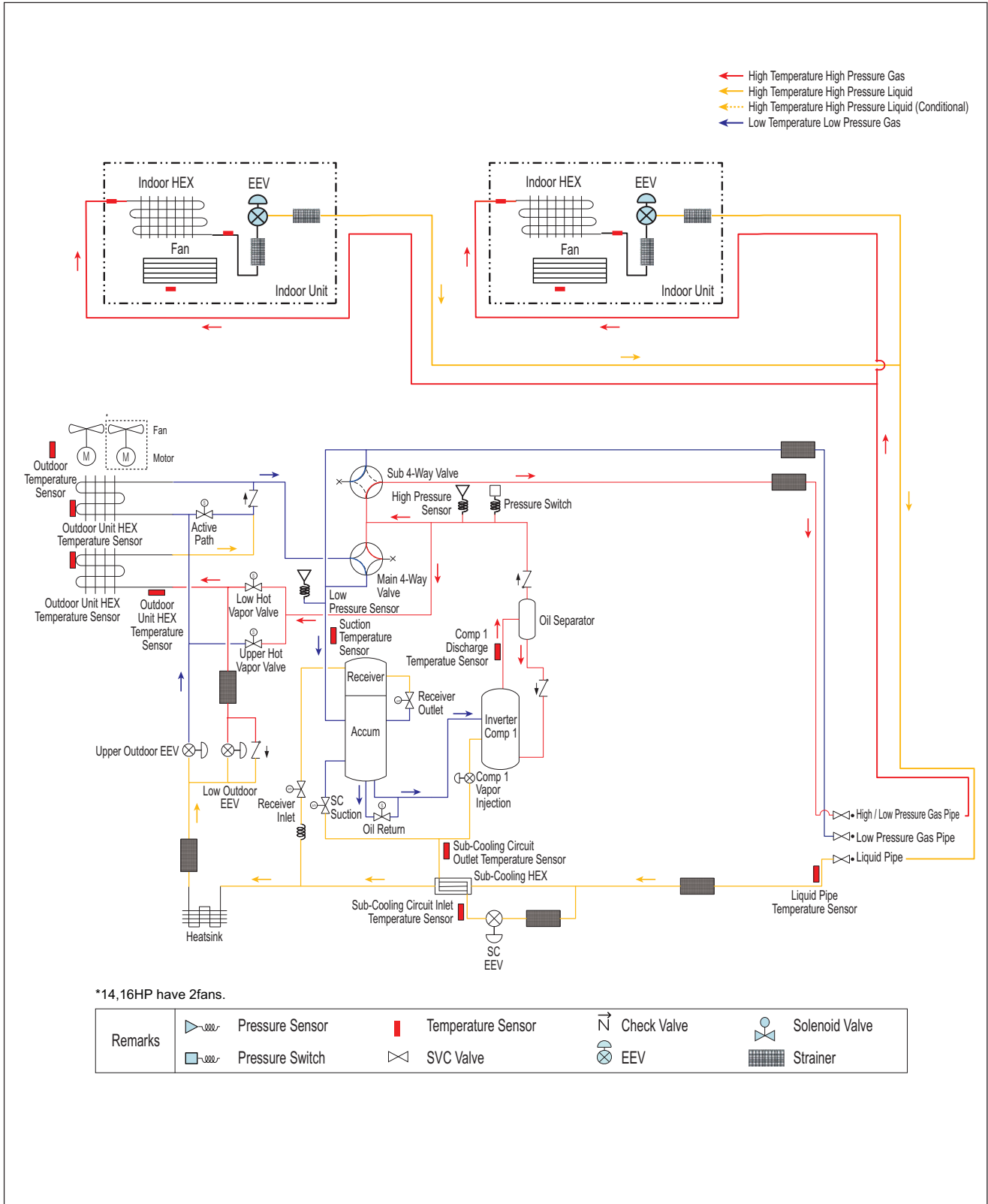



# 3. Piping Diagrams

## 3.2 18 / 20 / 22 / 24 / 26HP (2 Comp)

### 3.2.1 Heat Recovery System

#### ■ Cooling Operation

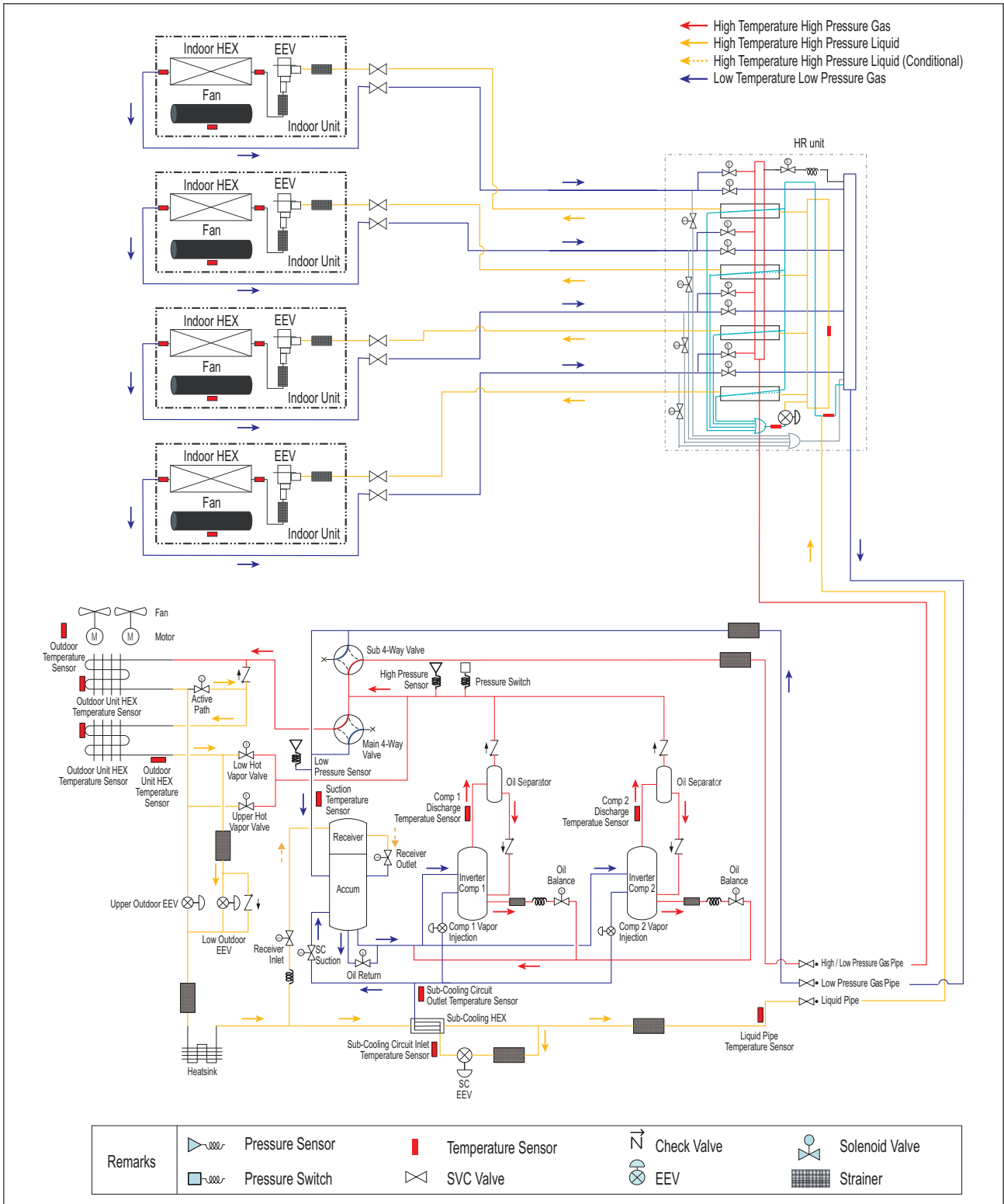

# 3. Piping Diagrams

## ■ Heating Operation

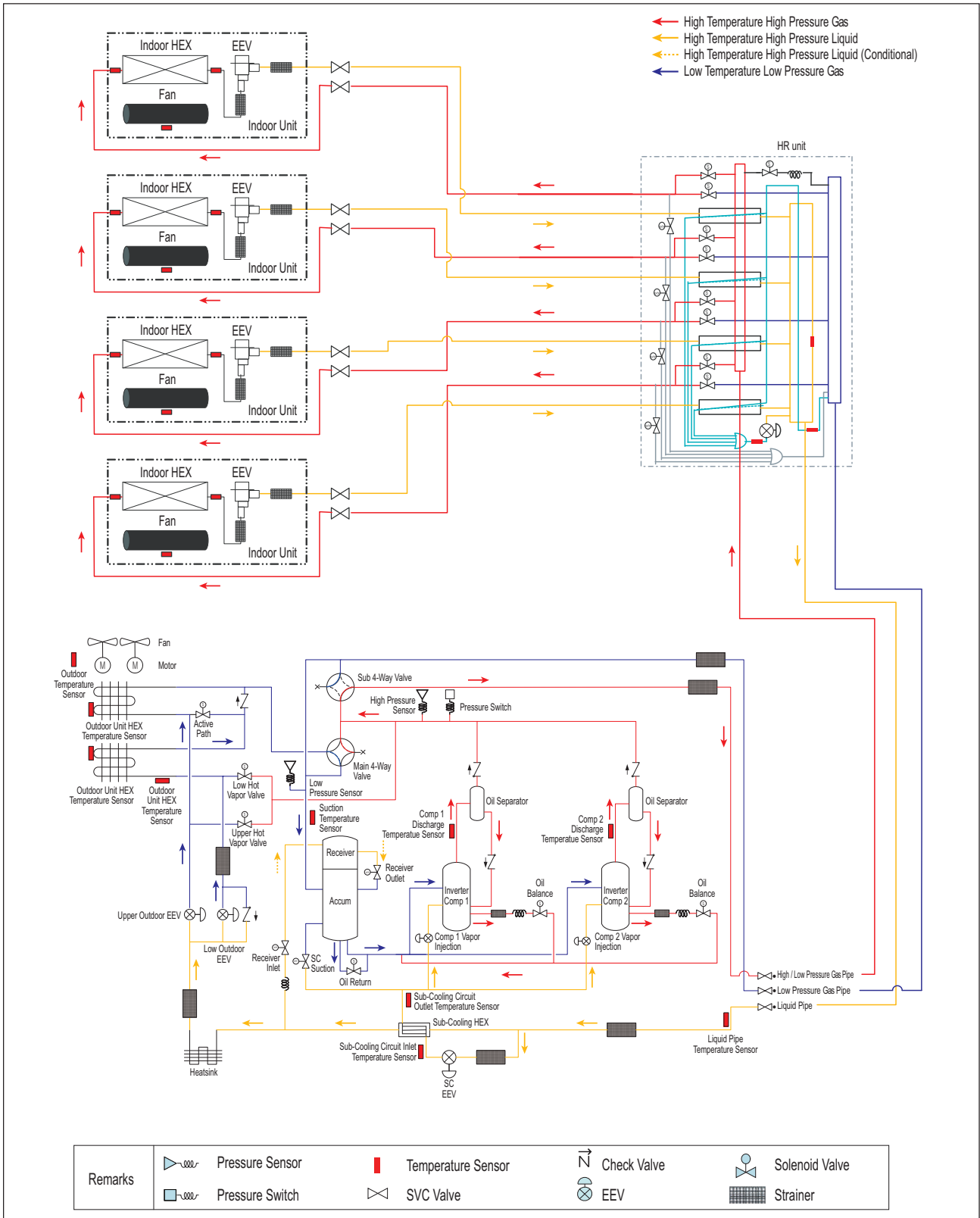

# 3. Piping Diagrams

## Oil Return/ Defrost Operation

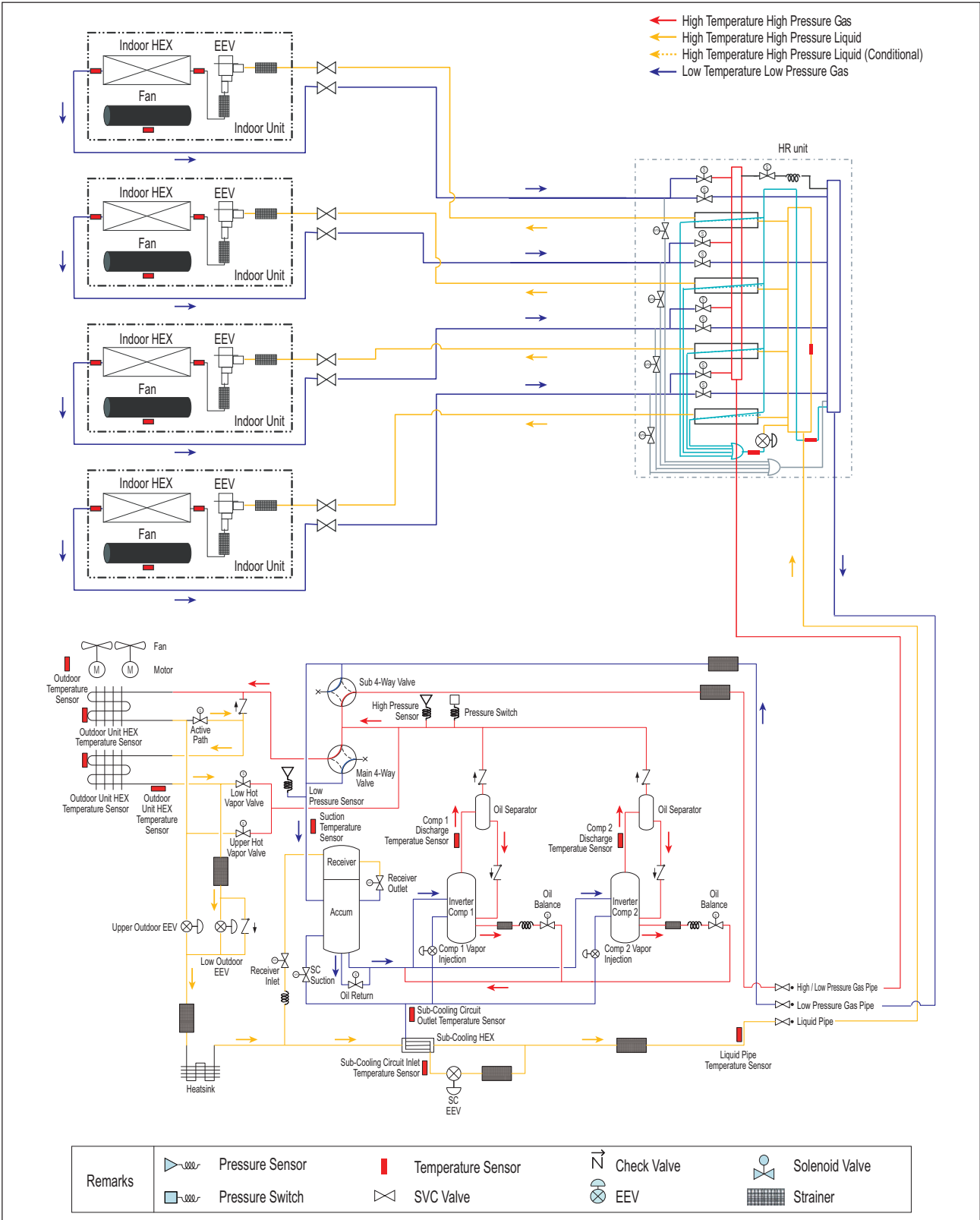

# 3. Piping Diagrams

## ■ Cooling-based Simultaneous Operation

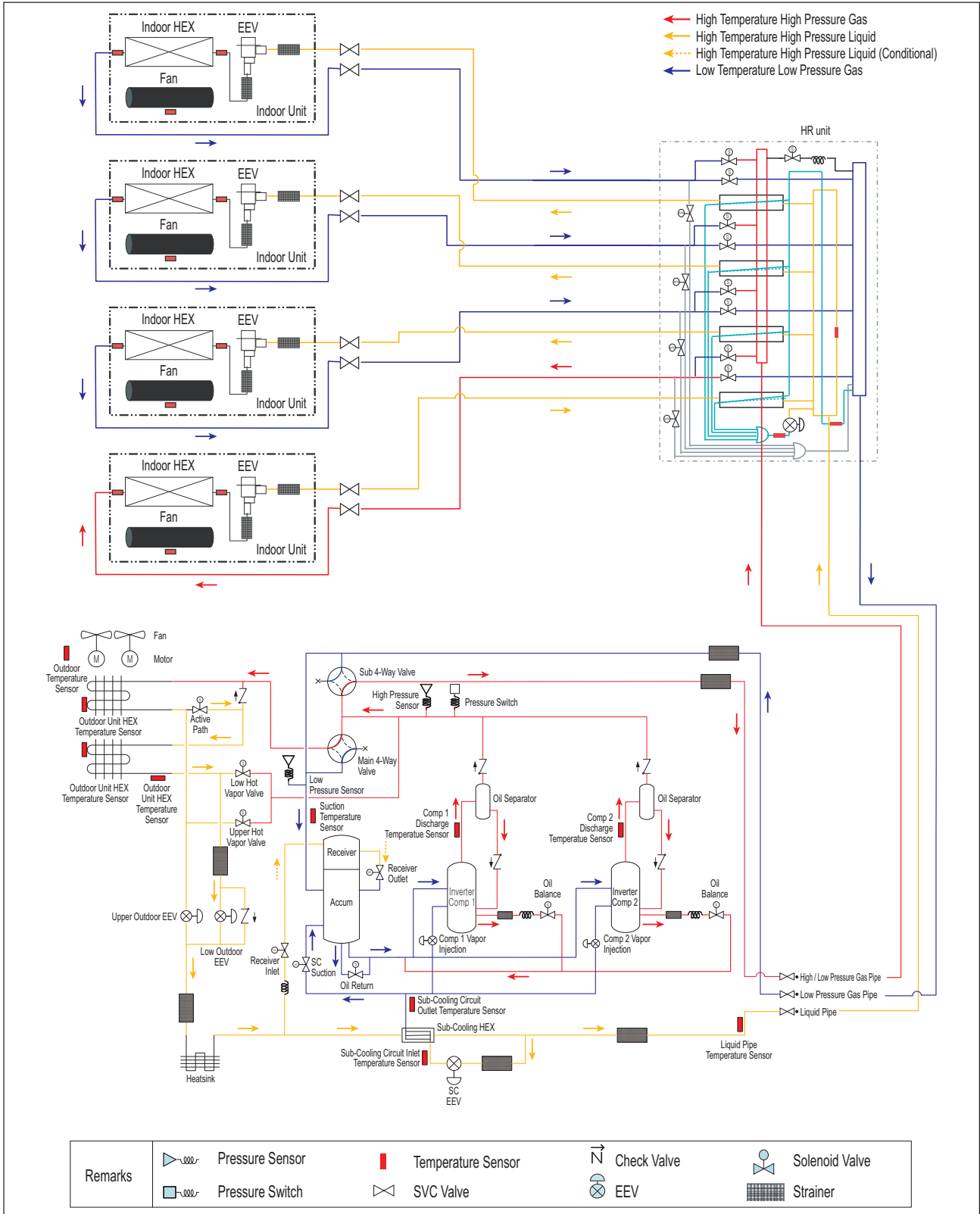

# 3. Piping Diagrams

## ■ Heating-based Simultaneous Operation

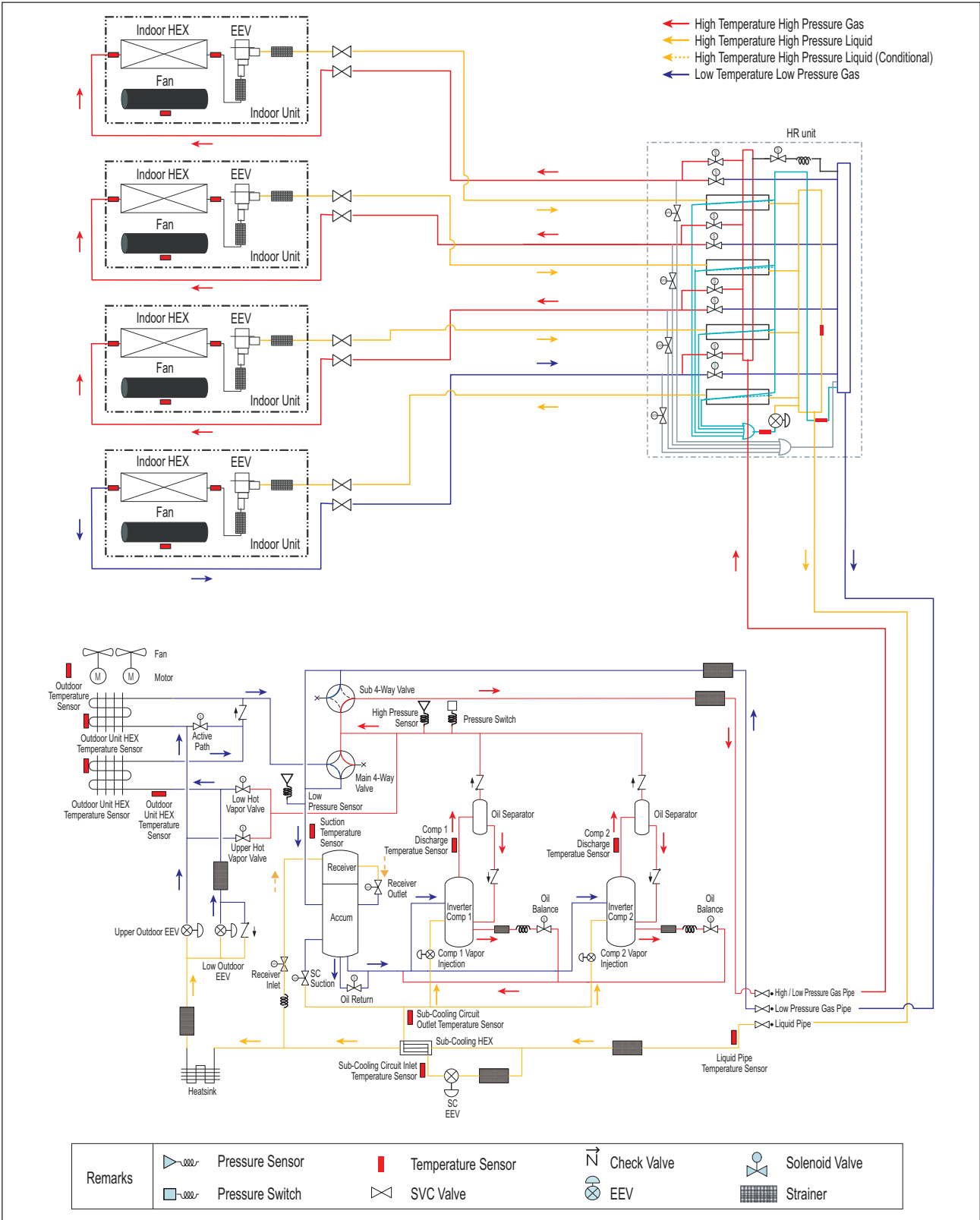

# 3. Piping Diagrams

## Balanced Simultaneous Operation

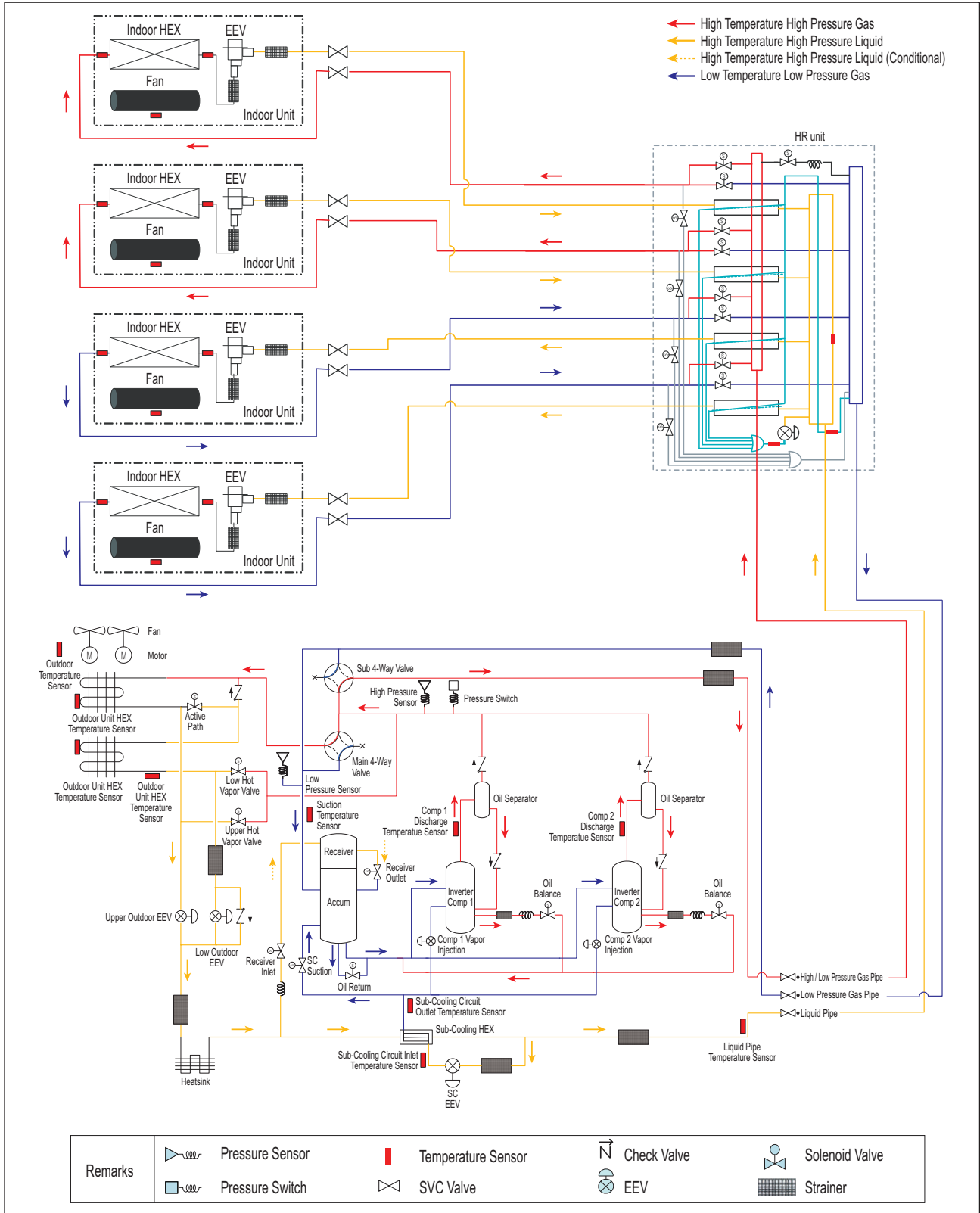

# 3. Piping Diagrams

## Upper HEX Defrost Operation

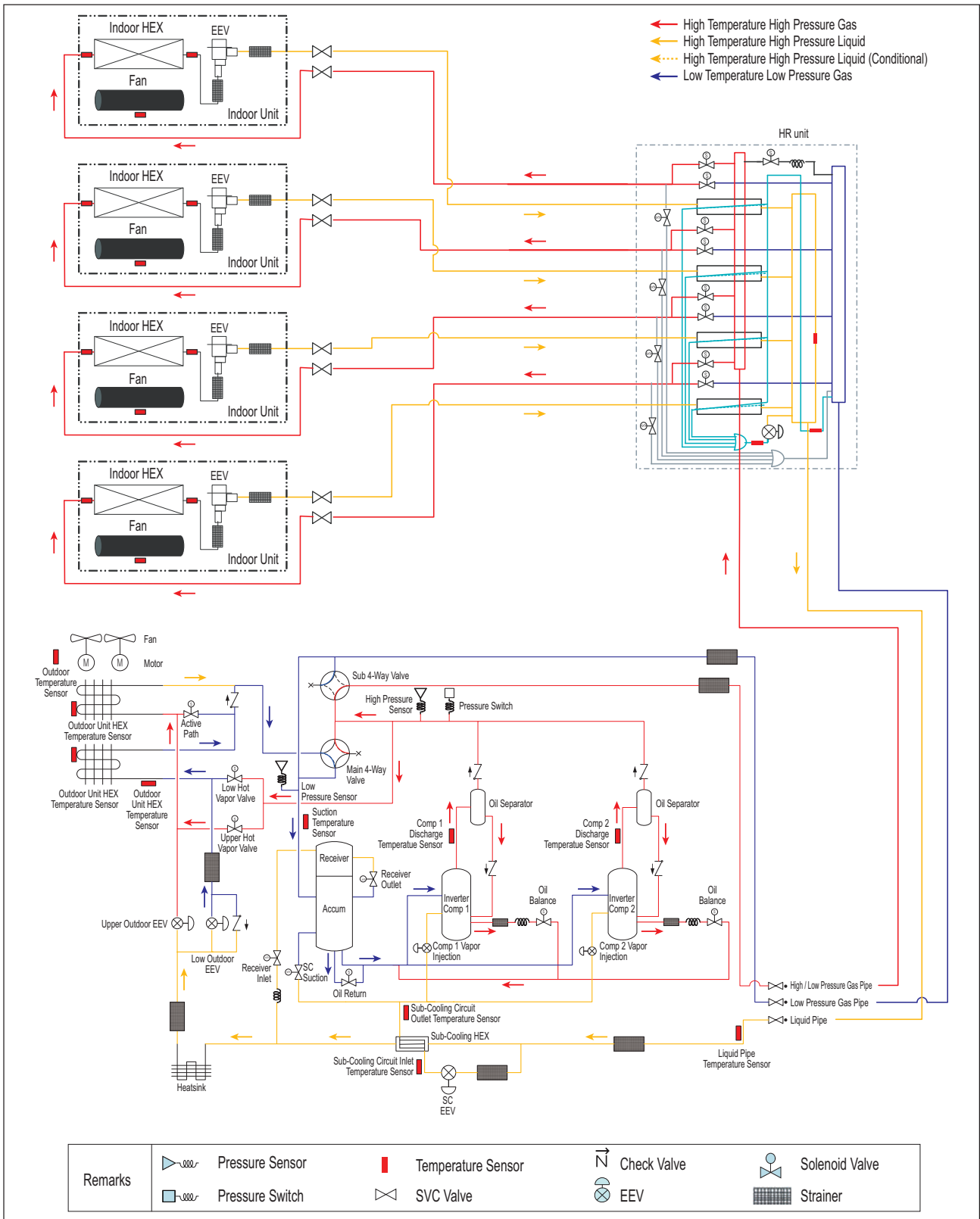

# 3. Piping Diagrams

## Low HEX Defrost Operation

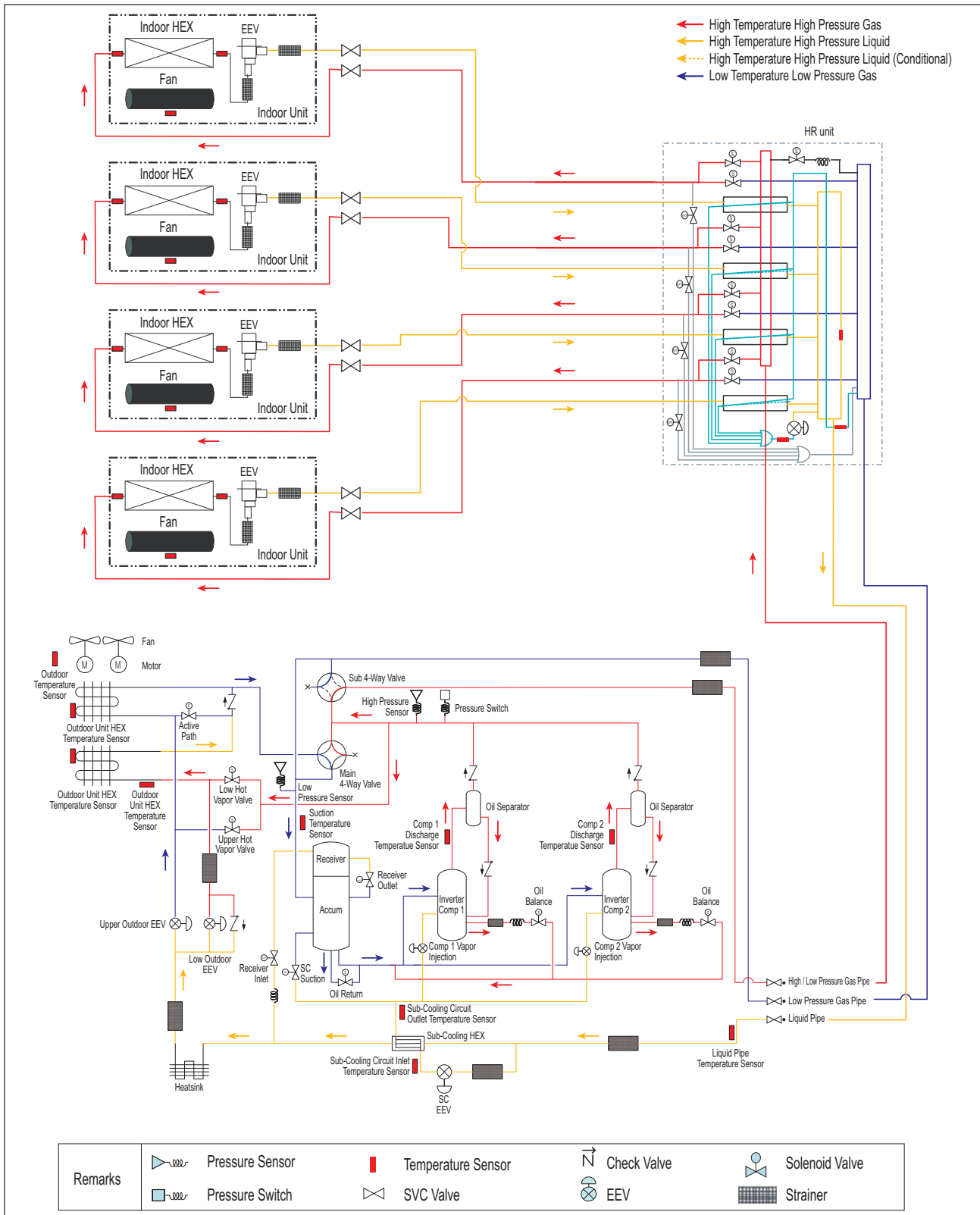



### 3. Piping Diagrams

#### 3.2.2 Heat Pump System

##### ■ Cooling Operation

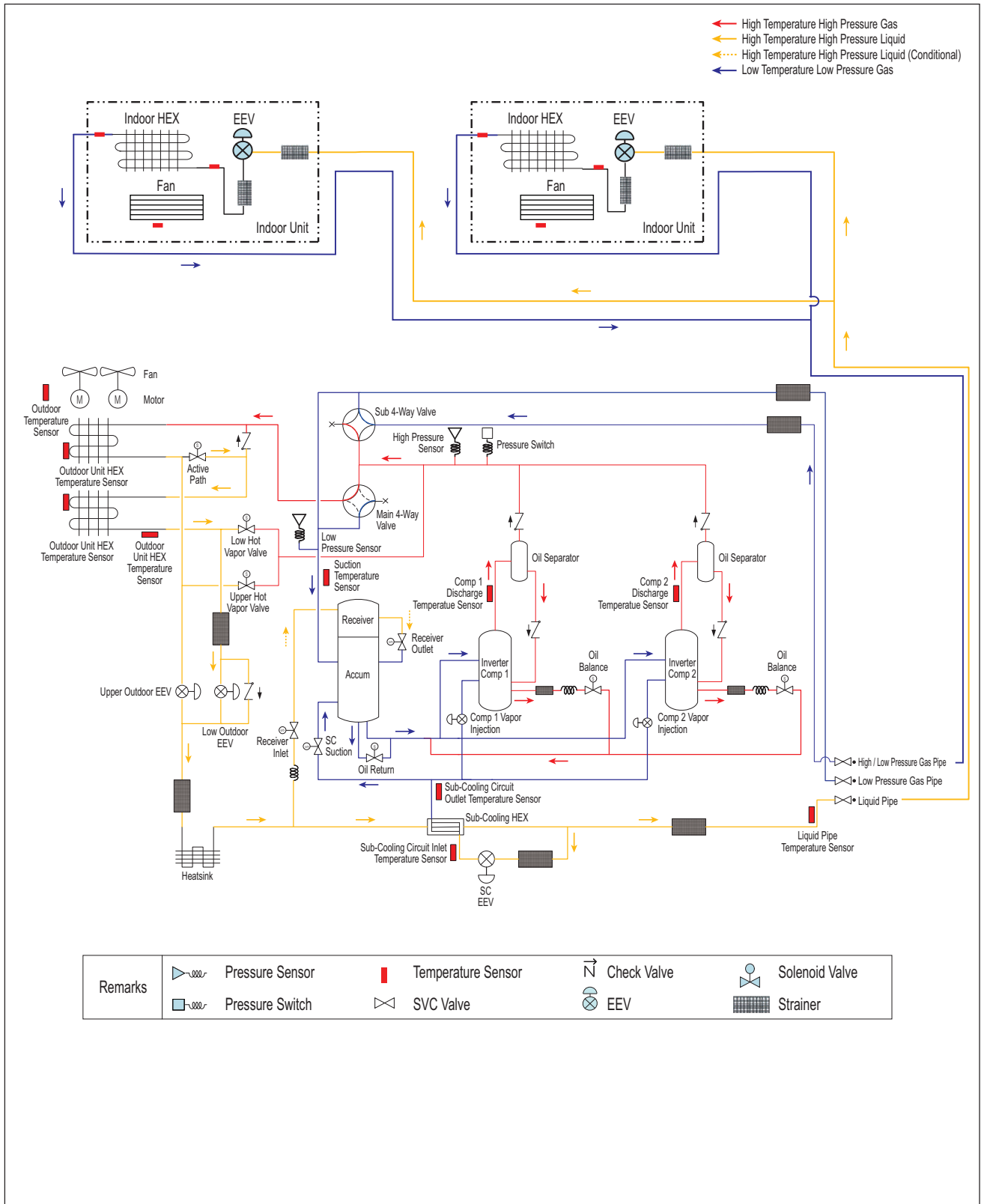

# 3. Piping Diagrams

## ■ Heating Operation

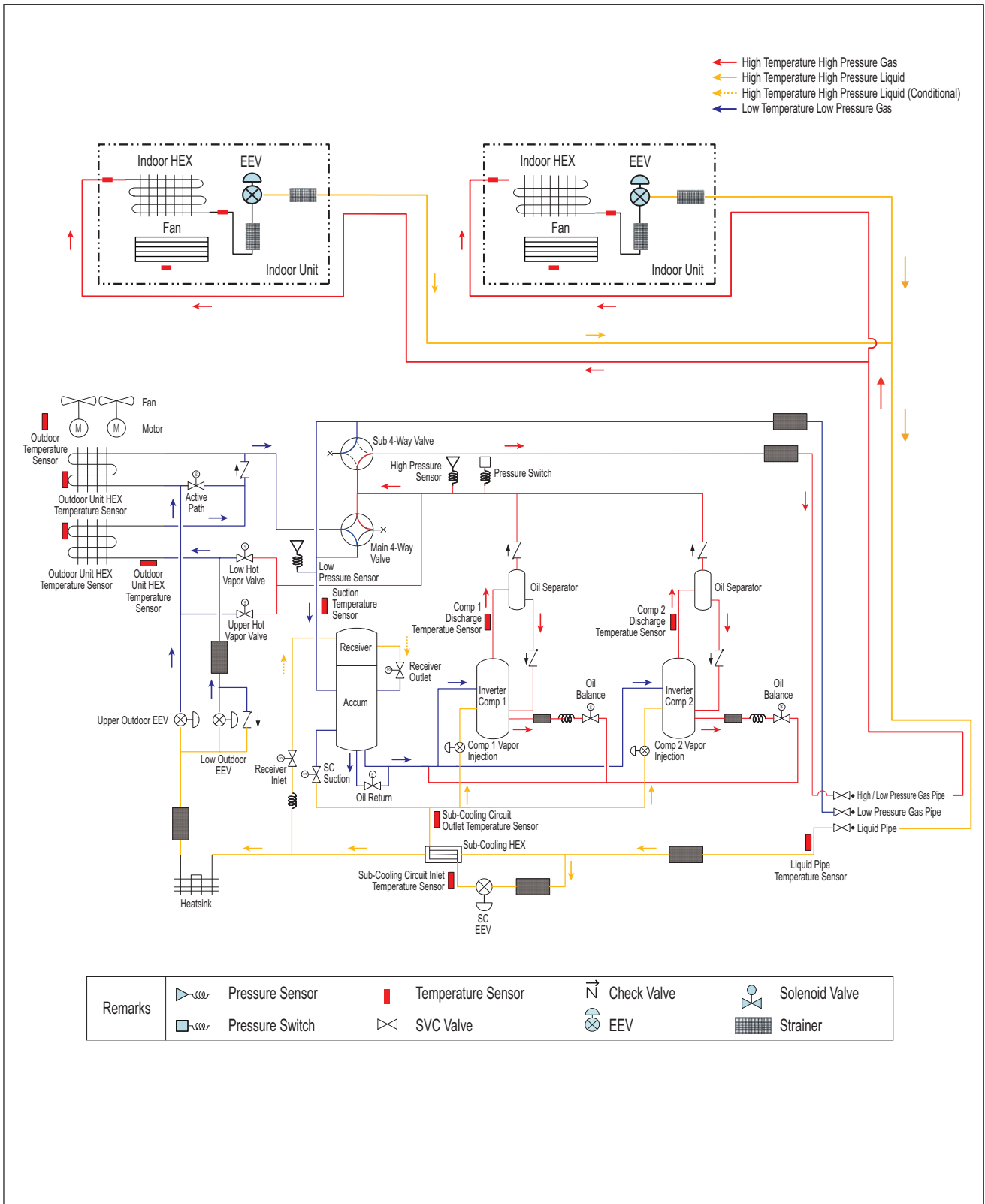

# 3. Piping Diagrams

## Oil Return/ Defrost Operation

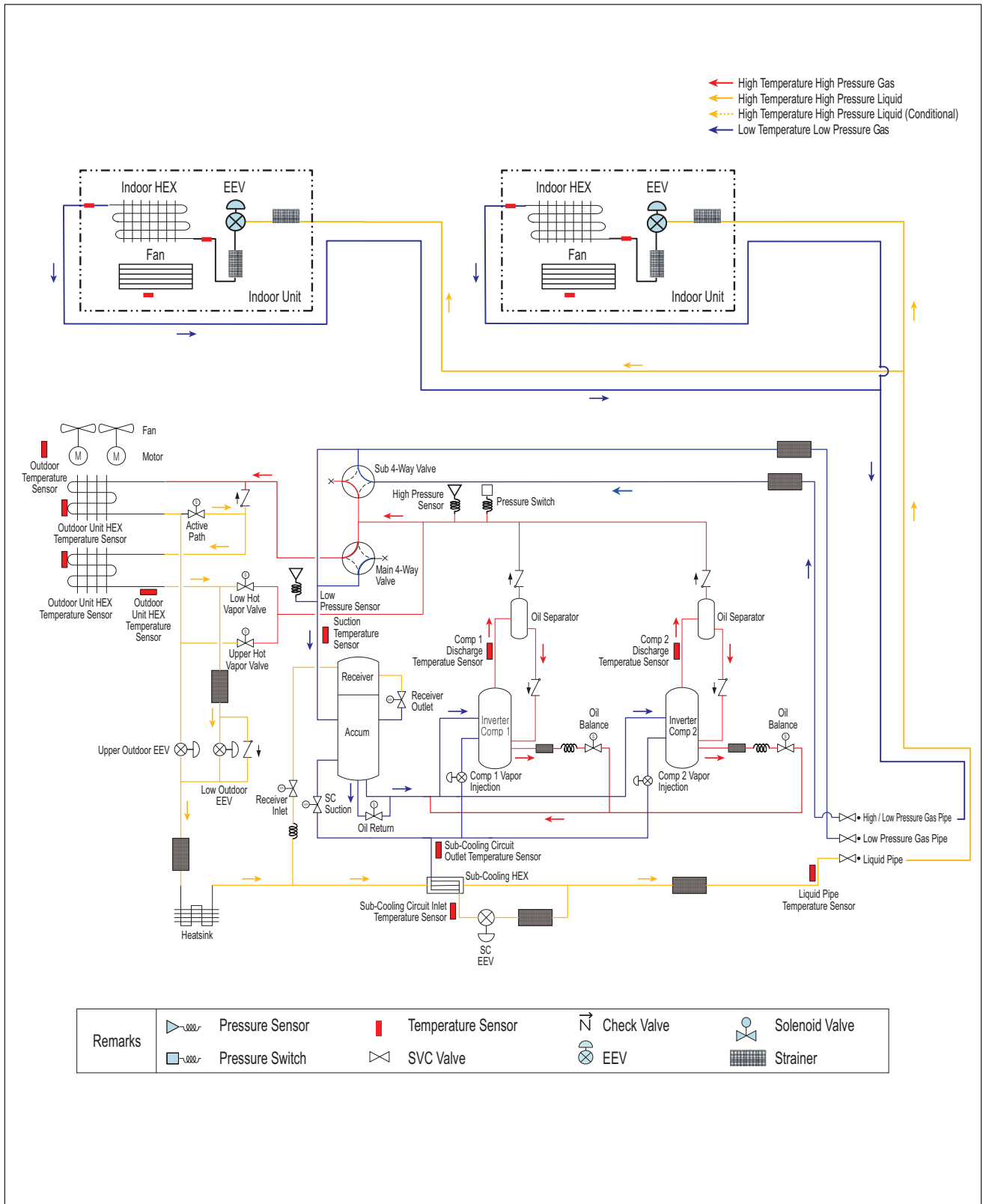

# 3. Piping Diagrams

## Upper HEX Defrost Operation

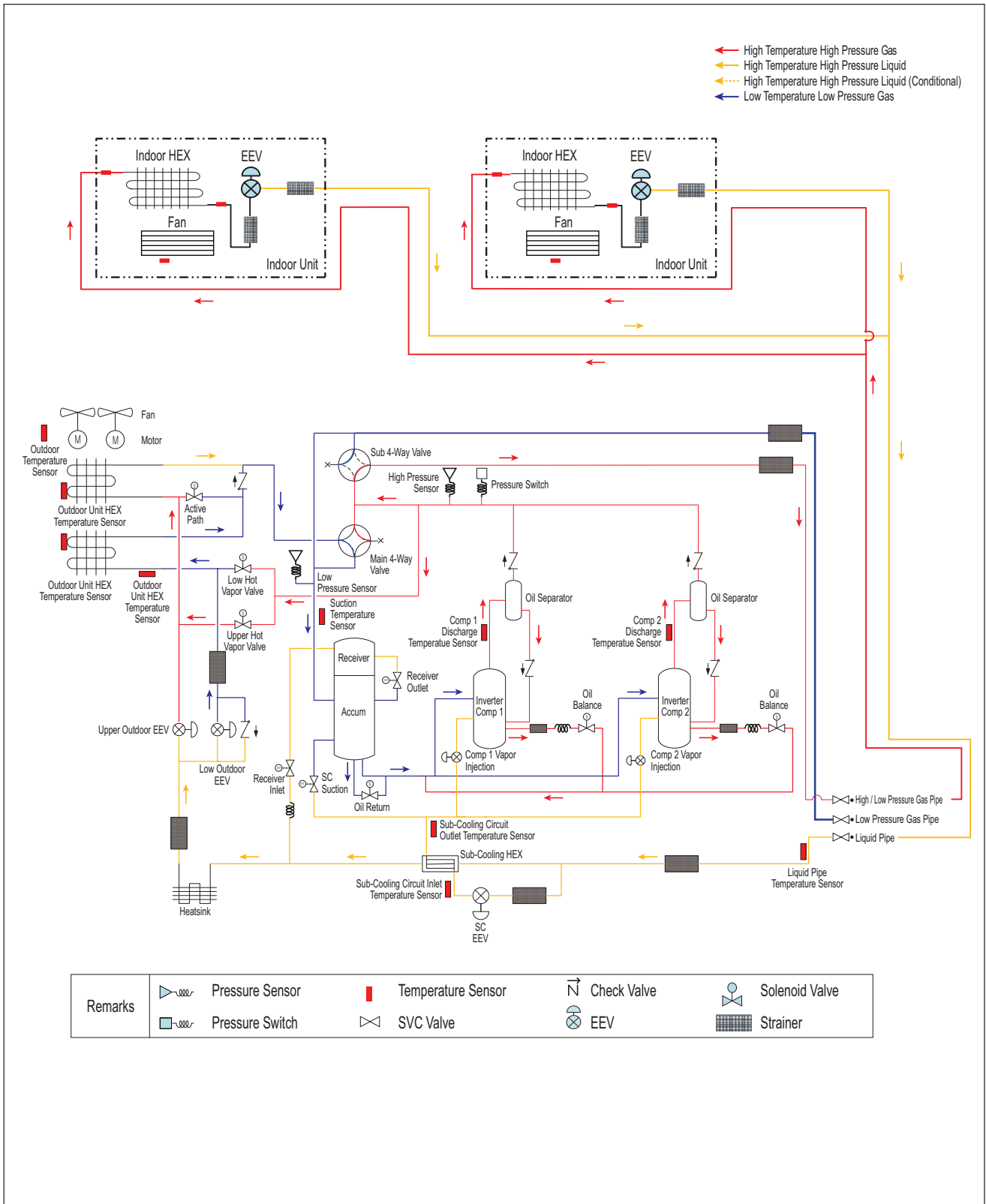

# 3. Piping Diagrams

## Low HEX Defrost Operation

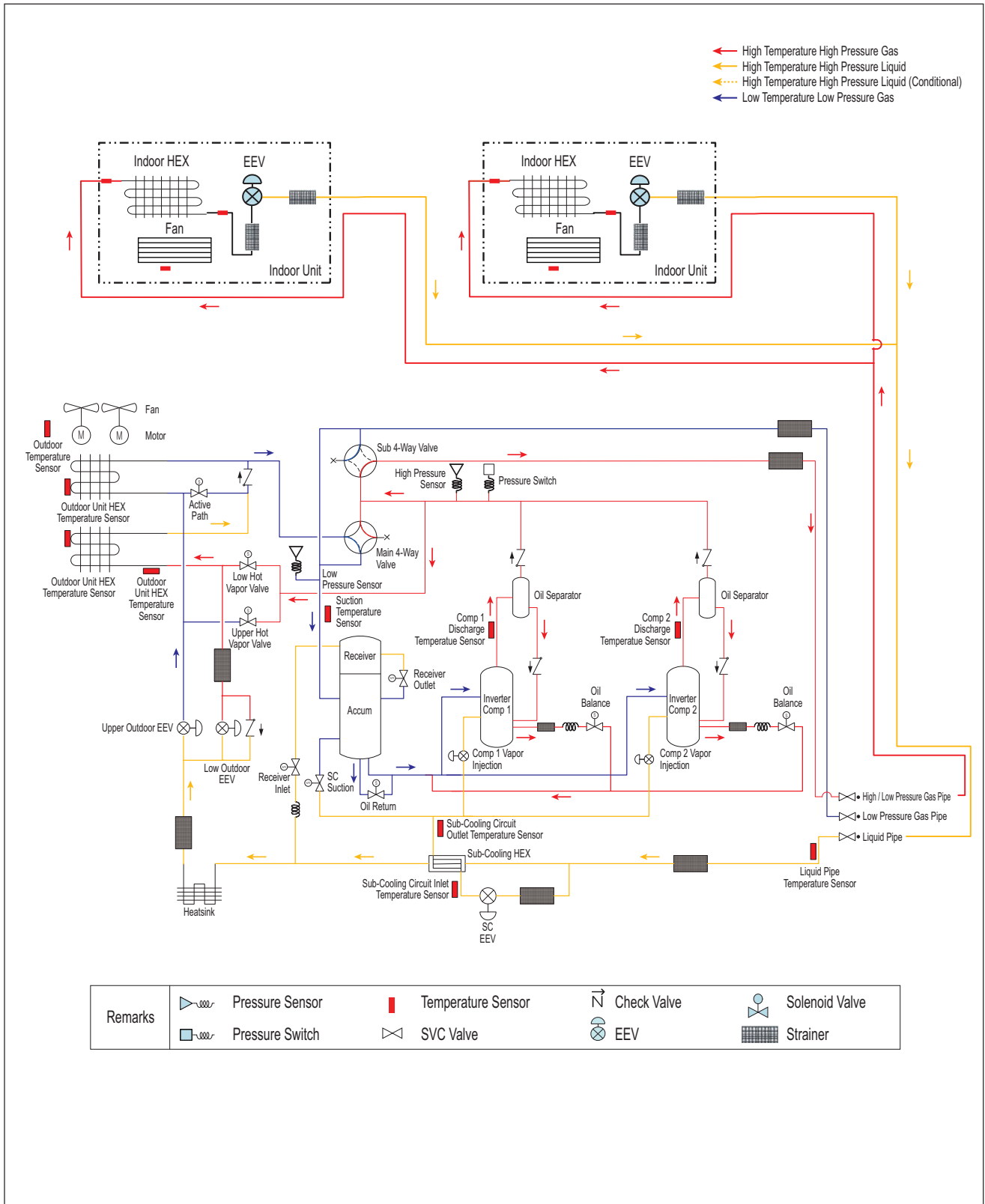

# 4. Wiring Diagrams

## 4.1 8 / 10 / 12 HP (UXA, 1 Comp)

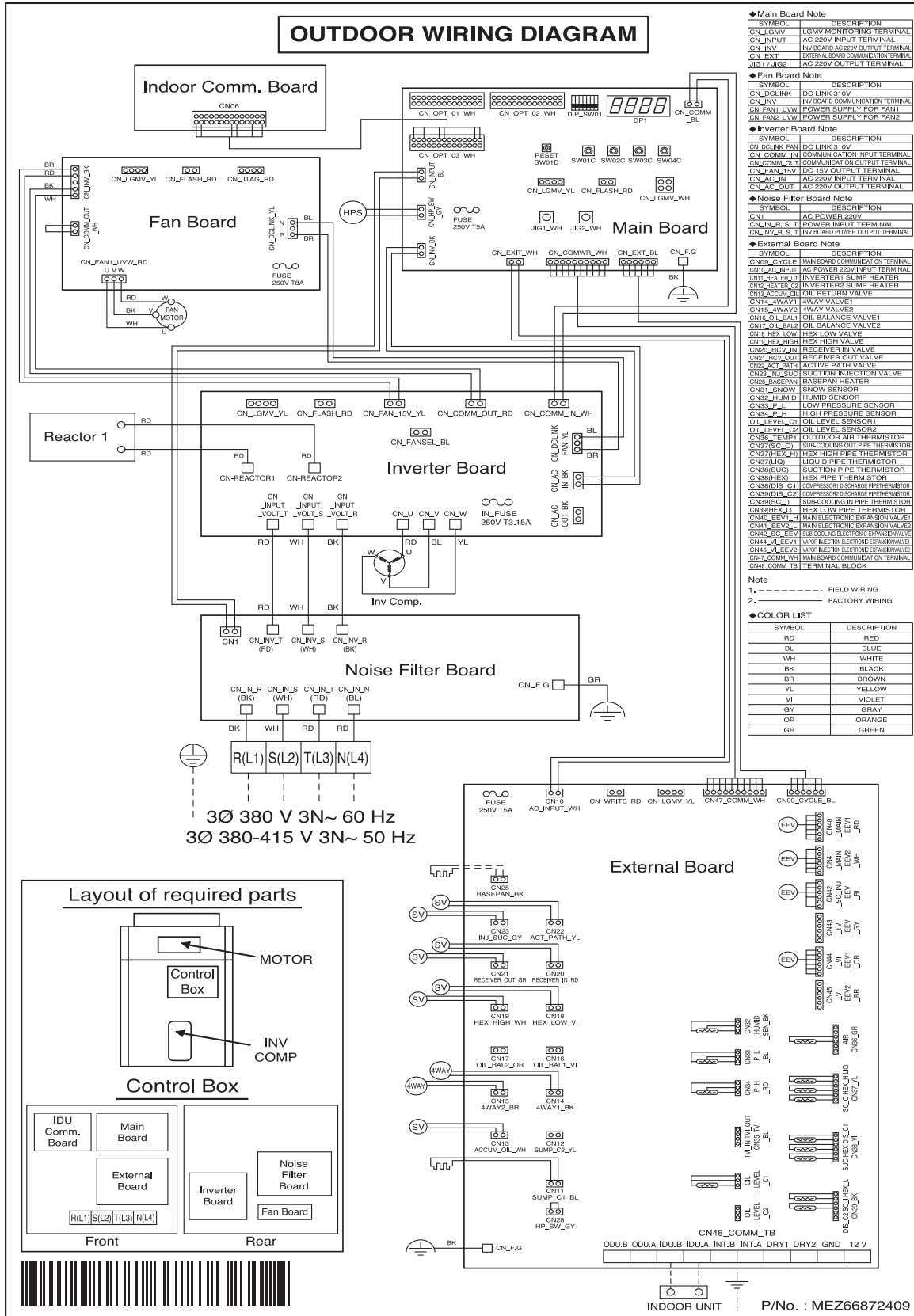

# 4. Wiring Diagrams

## 4.2 14 / 16 HP (UXB, 1 Comp)

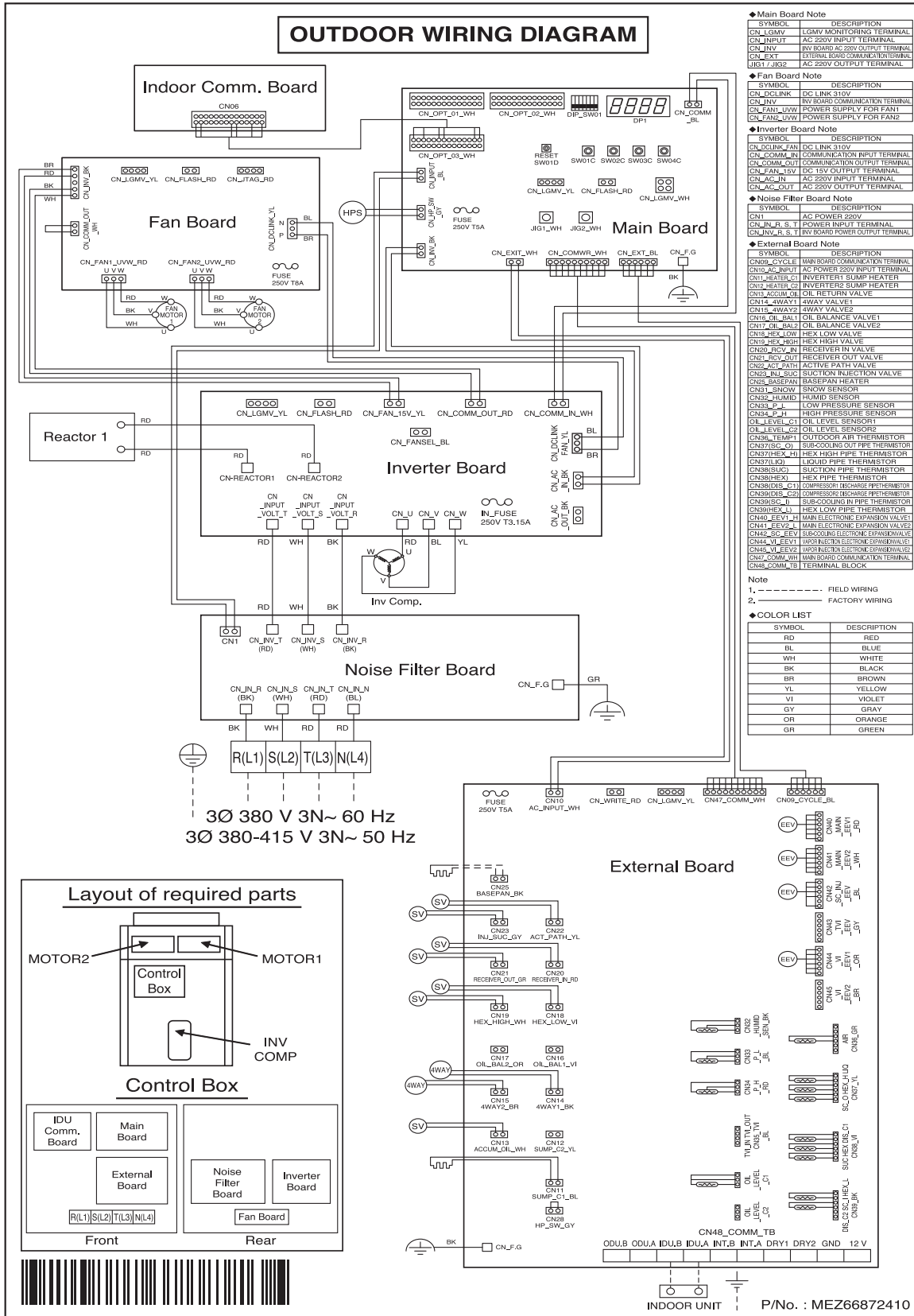

# 4. Wiring Diagrams

## 4.3 18 / 20 / 22 / 24 / 26HP (UXB, 2 Comp)

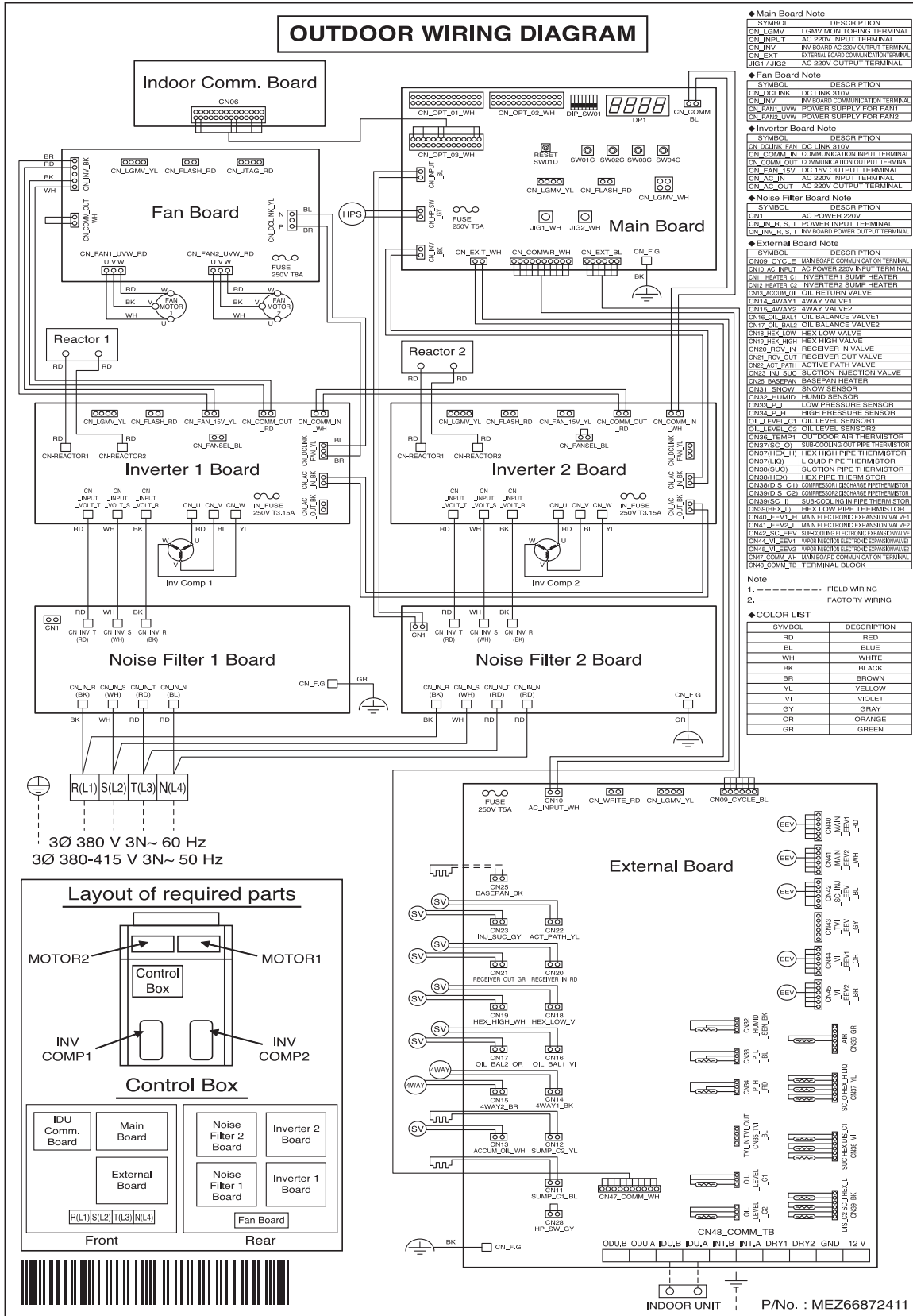



# 5. Field Wiring

## 5.1 Heat Recovery System

### ■ Example Connection of Communication Cable

#### ◆ Single Outdoor Unit

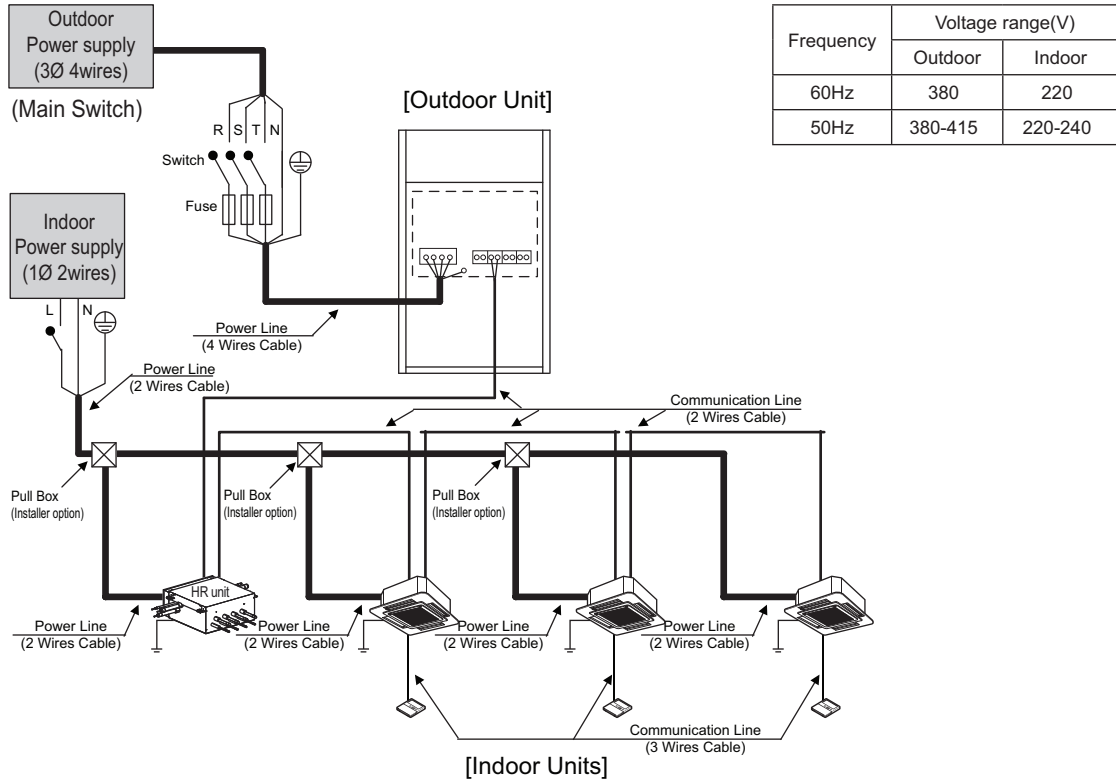

### ⚠ WARNING

- Indoor Unit ground Lines are required for preventing electrical shock accident during current leakage, Communication disorder by noise effect and motor current leakage (without connection to pipe).
  - Don't install an individual switch or electrical outlet to disconnect each of indoor unit separately from the power supply.
  - Install the main switch that can interrupt all the power sources in an integrated manner because this system consists of the equipment utilizing the multiple power sources.
  - If there exists the possibility of reversed phase, lose phase, momentary blackout or the power goes on and off while the product is operating, attach a reversed phase protection circuit locally.
- Running the product in reversed phase may break the compressor and other parts.

Between Indoor and Master Outdoor unit

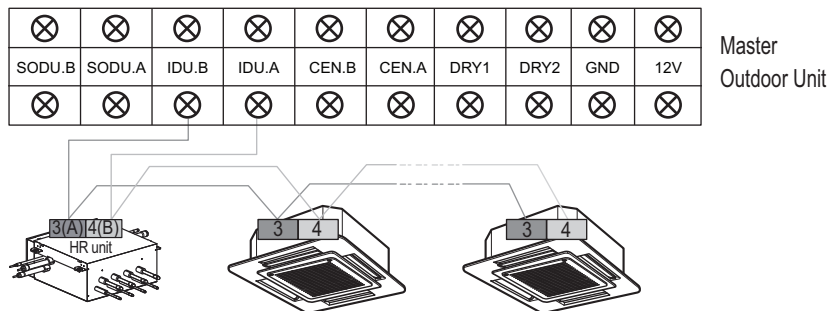

The GND terminal at the main PCB is a '-' terminal for day contact, it is not the point to make ground connection.

# 5. Field Wiring

## Series Outdoor Unit

### When the power source is connected In series between the units.

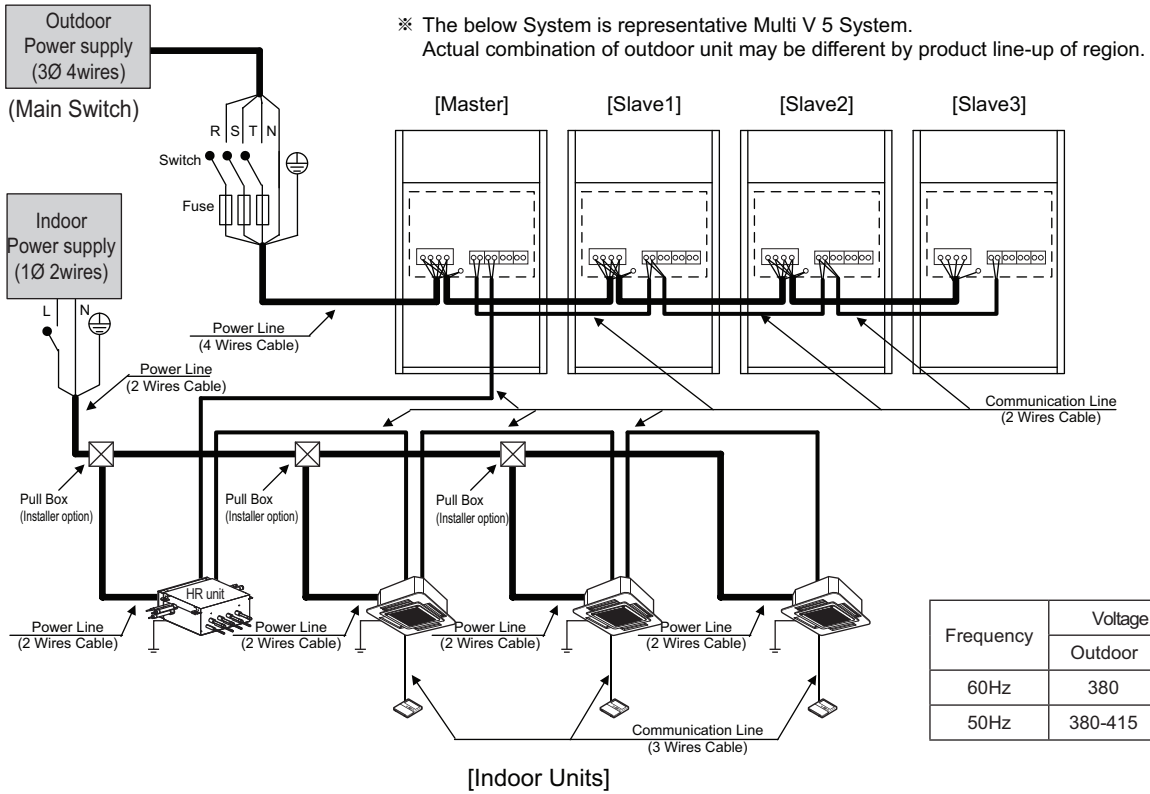

## WARNING

When the total capacity is over than 68Hp, the power source do not use in series between the outdoor units. The First terminal block could be burnt out.

### When the power source is supplied to Each outdoor unit individually.

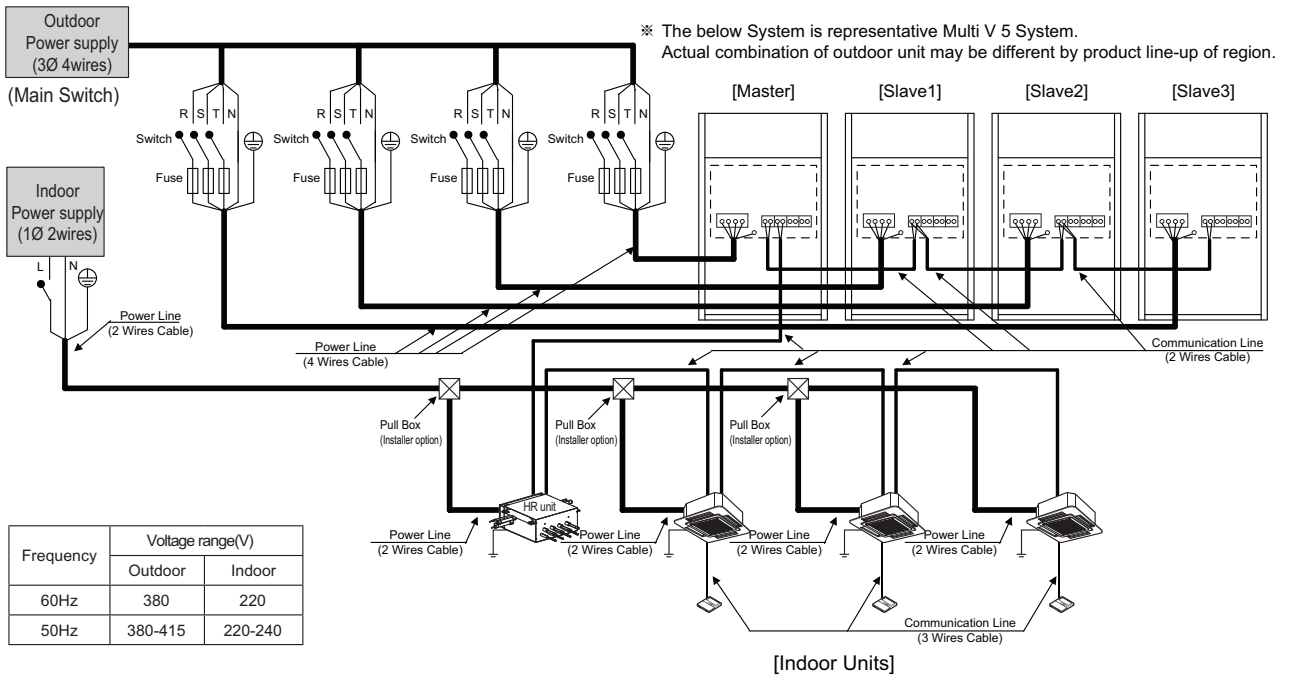

# 5. Field Wiring

## ⚠ WARNING

- Indoor Unit ground Lines are required for preventing electrical shock accident during current leakage, Communication disorder by noise effect and motor current leakage (without connection to pipe).
- Don't install an individual switch or electrical outlet to disconnect each of indoor unit separately from the power supply.
- Install the main switch that can interrupt all the power sources in an integrated manner because this system consists of the equipment utilizing the multiple power sources.
- If there exists the possibility of reversed phase, lose phase, momentary blackout or the power goes on and off while the product is operating, attach a reversed phase protection circuit locally.  
Running the product in reversed phase may break the compressor and other parts.

### ◆ Between Indoor and Master Outdoor unit

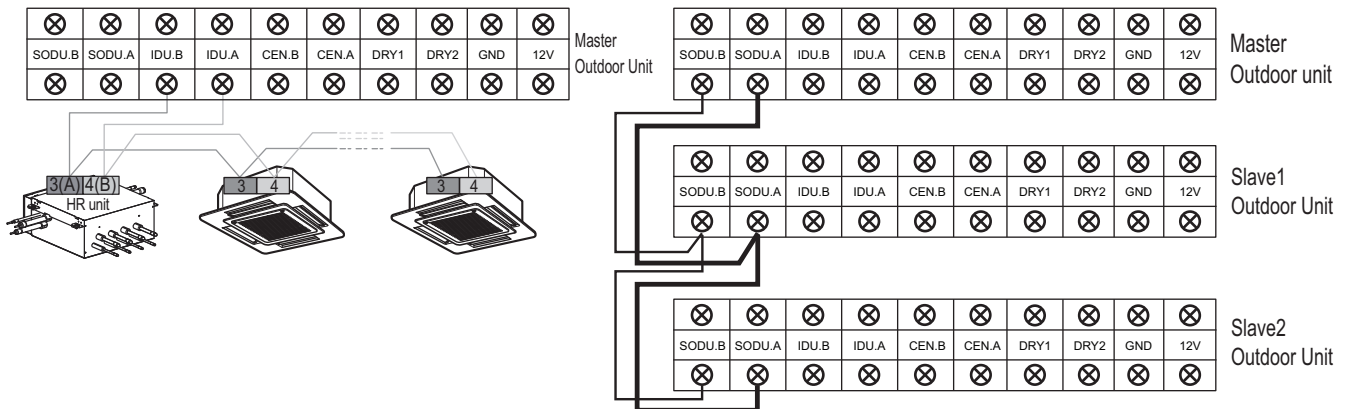

The GND terminal at the main PCB is a 'L' terminal for dry contact. It is not the point to make ground connection.

- Make sure that terminal number of master and slave outdoor units are matched.(A-A,B-B)

### ■ Example Connection of Communication Cable

- Connection of communication cable must be installed like below figure between indoor unit to outdoor unit.
- Abnormal operation can be caused by communication defect, when connection of communication cable is installed like below figure.

BUS Type

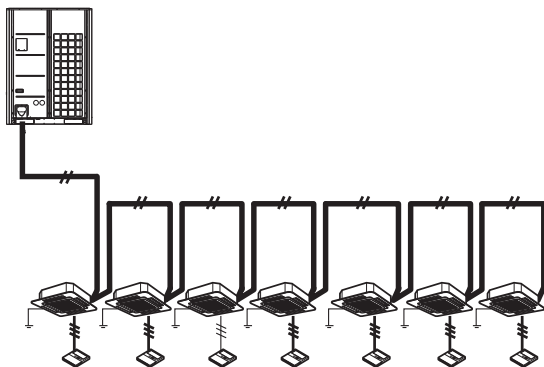

STAR Type

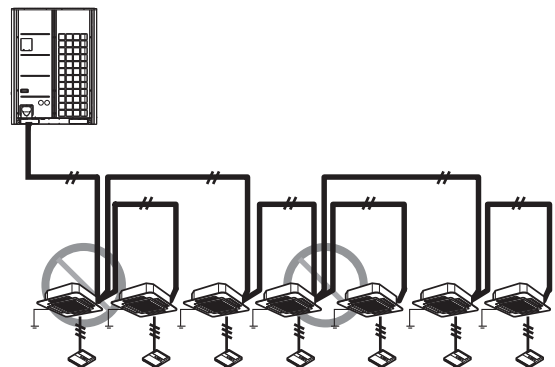

# 5. Field Wiring

## 5.2 Heat Pump System

### ■ Example Connection of Communication Cable

#### ◆ Single Outdoor Unit

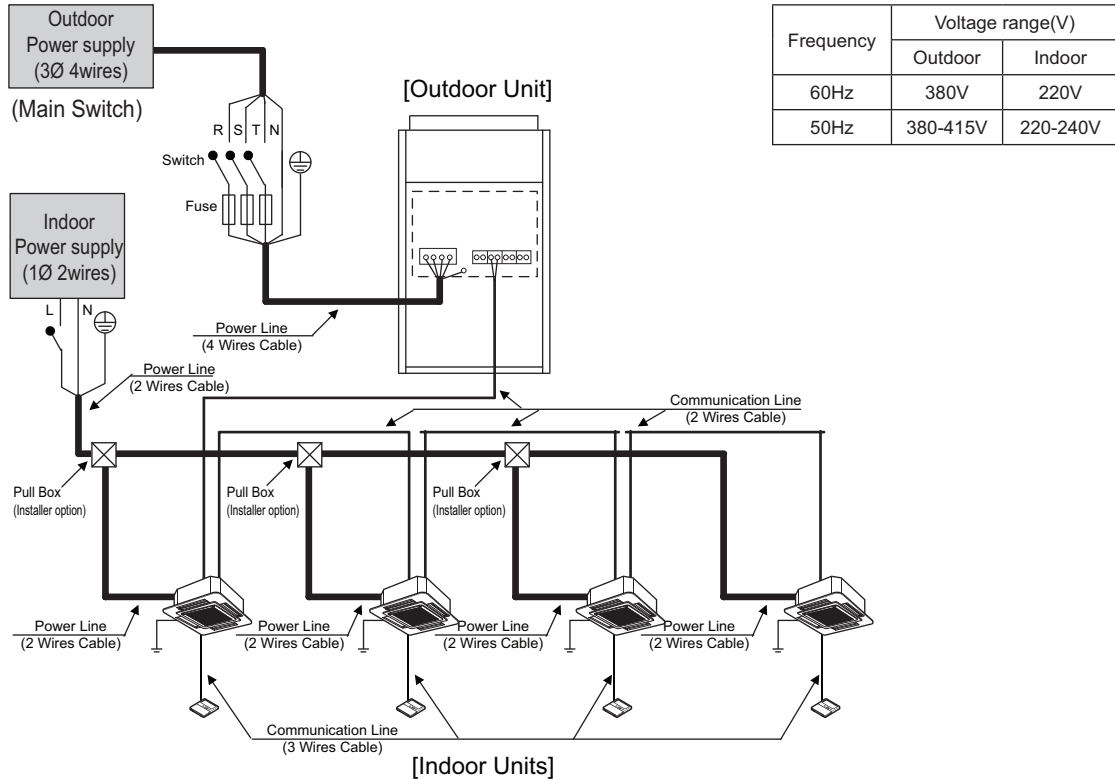

### ⚠ WARNING

- Indoor Unit ground Lines are required for preventing electrical shock accident during current leakage, Communication disorder by noise effect and motor current leakage (without connection to pipe).
  - Don't install an individual switch or electrical outlet to disconnect each of indoor unit separately from the power supply.
  - Install the main switch that can interrupt all the power sources in an integrated manner because this system consists of the equipment utilizing the multiple power sources.
  - If there exists the possibility of reversed phase, lose phase, momentary blackout or the power goes on and off while the product is operating, attach a reversed phase protection circuit locally.
- Running the product in reversed phase may break the compressor and other parts.

Between Indoor and Master Outdoor unit

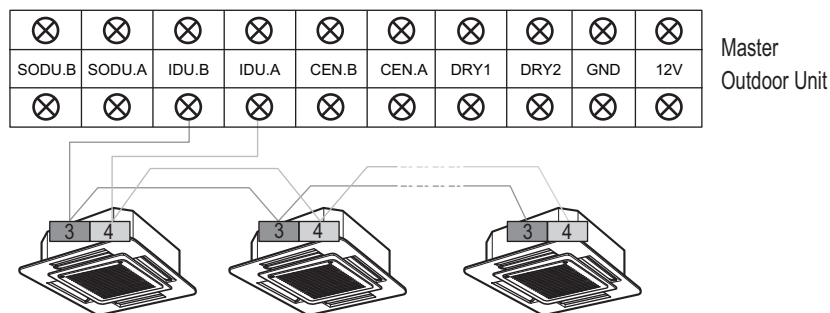

The GND terminal at the main PCB is a '-' terminal for day contact, it is not the point to make ground connection.

# 5. Field Wiring

## Series Outdoor Unit

◆ When the power source is connected In series between the units.

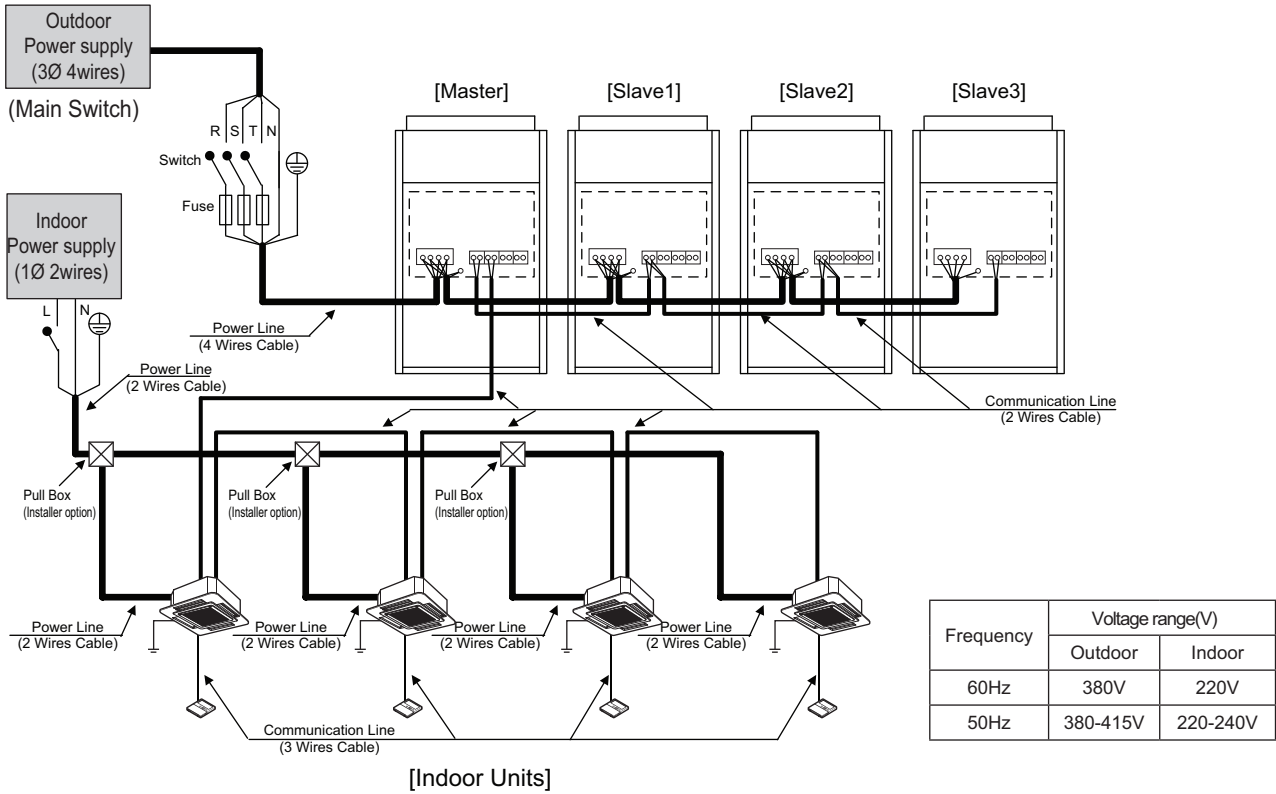

### ⚠ WARNING

When the total capacity is over than 68Hp, the power source do not use in series between the outdoor units. The First terminal block could be burnt out.

◆ When the power source is supplied to Each outdoor unit individually.

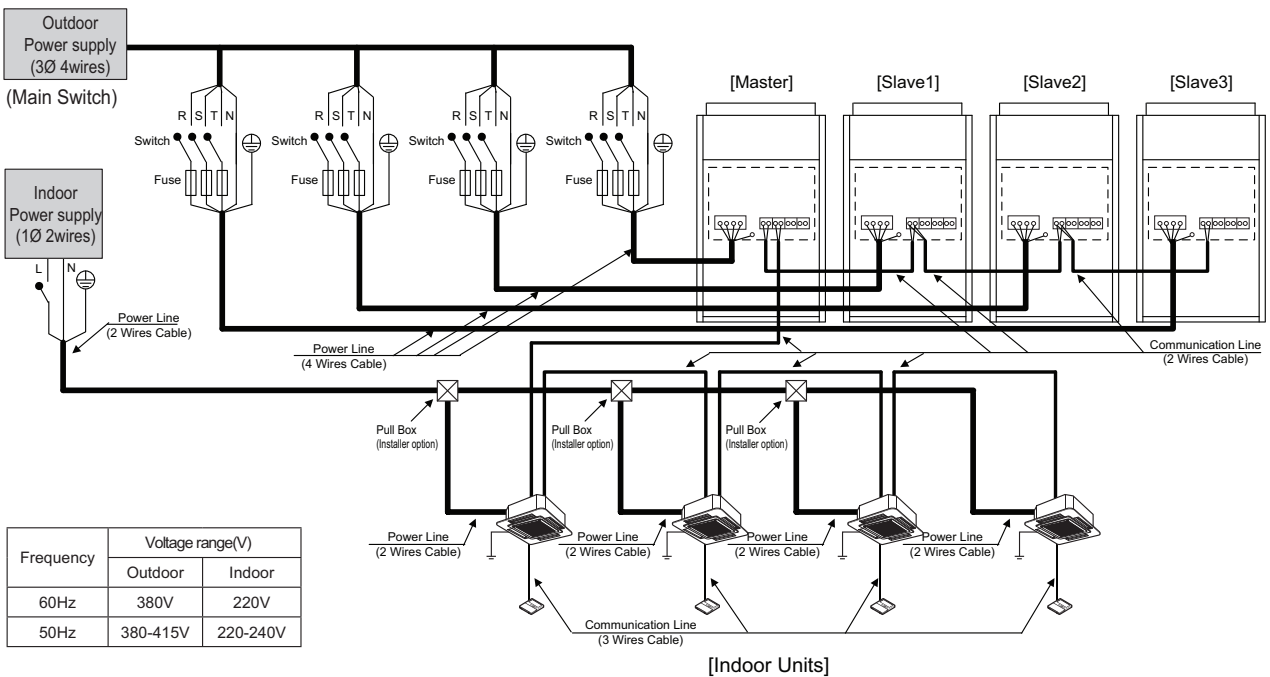

# 5. Field Wiring

## ⚠ WARNING

- Indoor Unit ground Lines are required for preventing electrical shock accident during current leakage, Communication disorder by noise effect and motor current leakage (without connection to pipe).
- Don't install an individual switch or electrical outlet to disconnect each of indoor unit separately from the power supply.
- Install the main switch that can interrupt all the power sources in an integrated manner because this system consists of the equipment utilizing the multiple power sources.
- If there exists the possibility of reversed phase, lose phase, momentary blackout or the power goes on and off while the product is operating, attach a reversed phase protection circuit locally.  
Running the product in reversed phase may break the compressor and other parts.

### ◆ Between Indoor and Master Outdoor unit

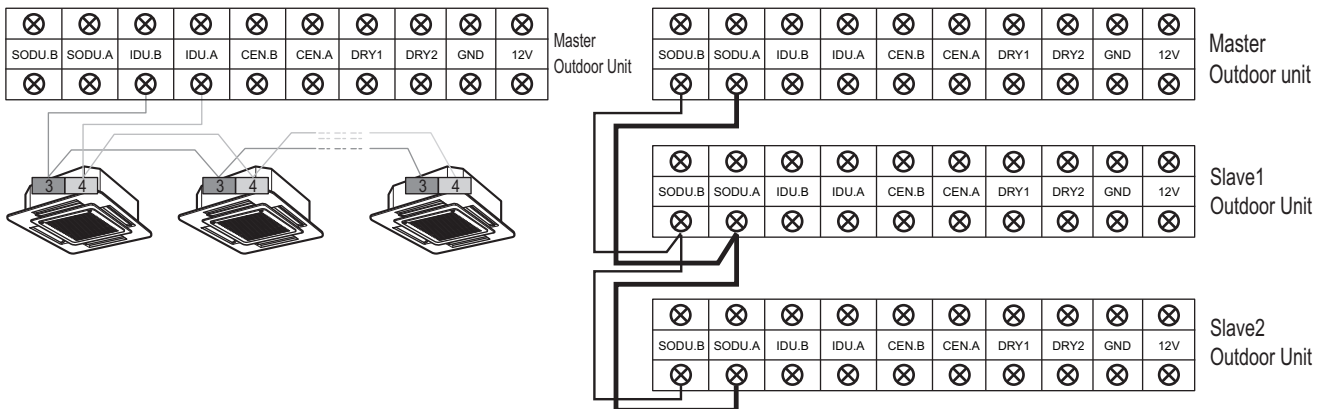

The GND terminal at the main PCB is a 'L' terminal for dry contact. It is not the point to make ground connection.

- Make sure that terminal number of master and slave outdoor units are matched.(A-A,B-B)

### ■ Example Connection of Communication Cable

- Connection of communication cable must be installed like below figure between indoor unit to outdoor unit.
- Abnormal operation can be caused by communication defect, when connection of communication cable is installed like below figure.

BUS Type

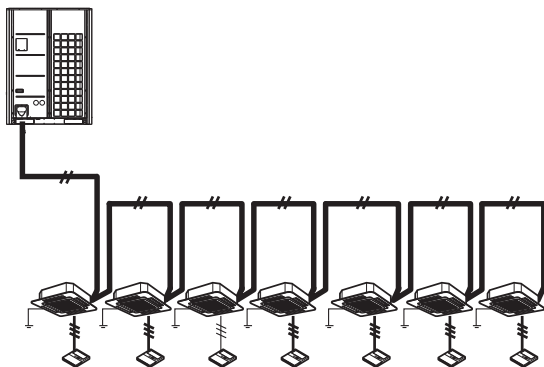

STAR Type

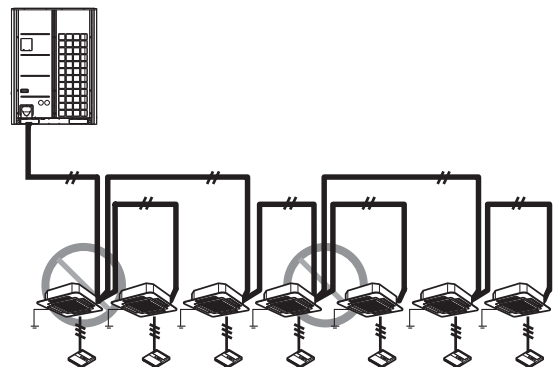

## 6. Electric Characteristics

---

### ■ Wiring of Main Power Supply and Equipment Capacity

1. Use a separate power supply for the Outdoor Unit and Indoor Unit.
2. Bear in mind ambient conditions (ambient temperature, direct sunlight, rain liquid, etc.) when proceeding with the wiring and connections
3. The wire size is the minimum value for metal conduit wiring. The power cord size should be 1 rank thicker taking into account the line voltage drops. Make sure the power-supply voltage does not drop more than 10%.
4. Specific wiring requirements should adhere to the wiring regulations of the region.
5. Power supply cords of parts of appliances for outdoor use should not be lighter than polychloroprene sheathed flexible cord.
6. Don't install an individual switch or electrical outlet to disconnect each of indoor unit separately from the power supply.

---

### WARNING

- Follow ordinance of your governmental organization for technical standard related to electrical equipment, wiring regulations and guidance of each electric power company.
- Make sure to use specified wires for connections so that no external force is imparted to terminal connections. If connections are not fixed firmly, it may cause heating or fire.
- Make sure to use the appropriate type of overcurrent protection switch. Note that generated overcurrent may include some amount of direct current.
- All installation site may require attachment of an earth leakage breaker. If no earth leakage breaker is installed, it may cause an electric shock.

---

### CAUTION

- Do not use anything other than breaker and fuse with correct capacity. Using fuse and wire or copper wire with too large capacity may cause a malfunction of unit or fire.
-

## 6. Electric Characteristics

### ■ 50Hz

Model	Unit			Power Supply			COMP			OFM	
	Hz	Volts	Voltage-range	MCA	TOCA	MFA	MSC	RLA(Cooling)	RLA(Heating)	kW	FLA
8 HP	50	380-415	Min.:342, Max.:456	18.2	20.0	20	4.3	6.1	5.5	1.20	2.5
10 HP	50	380-415	Min.:342, Max.:456	25.5	28.0	32	5.9	8.7	7.2	1.20	2.5
12 HP	50	380-415	Min.:342, Max.:456	25.5	28.0	32	5.9	10.1	11.9	1.20	2.5
14 HP	50	380-415	Min.:342, Max.:456	25.5	28.0	32	5.9	11.7	13.4	1.80	2.5
16 HP	50	380-415	Min.:342, Max.:456	25.5	28.0	32	5.9	15.3	18.8	1.80	2.5
18 HP	50	380-415	Min.:342, Max.:456	42.7	47.0	50	10.2	15.5	16.5	1.80	2.5
20 HP	50	380-415	Min.:342, Max.:456	44.5	49.0	50	10.2	18.4	21.5	1.80	2.5
22 HP	50	380-415	Min.:342, Max.:456	45.5	50.0	50	10.2	23.5	24.9	1.80	2.5
24 HP	50	380-415	Min.:342, Max.:456	49.1	54.0	63	11.8	25.9	28.2	1.80	2.5
26 HP	50	380-415	Min.:342, Max.:456	49.1	54.0	63	11.8	30.5	28.1	1.80	2.5
22' HP	50	380-415	Min.:342, Max.:456	50.9	56.0	63	11.8	18.8	19.1	2.40	5.0
24' HP	50	380-415	Min.:342, Max.:456	50.9	56.0	63	11.8	19.1	20.6	2.40	5.0
26' HP	50	380-415	Min.:342, Max.:456	50.9	56.0	63	11.8	21.8	25.4	2.40	5.0
28 HP	50	380-415	Min.:342, Max.:456	50.9	56.0	63	11.8	25.4	30.7	3.00	5.0
30 HP	50	380-415	Min.:342, Max.:456	68.2	75.0	80	16.1	25.6	28.5	3.00	5.0
32 HP	50	380-415	Min.:342, Max.:456	70.0	77.0	80	16.1	28.4	33.4	3.00	5.0
34 HP	50	380-415	Min.:342, Max.:456	69.6	78.0	80	16.1	33.6	36.8	3.00	5.0
36 HP	50	380-415	Min.:342, Max.:456	71.9	82.0	80	17.7	36.0	40.1	3.00	5.0
38 HP	50	380-415	Min.:342, Max.:456	72.6	82.0	100	17.7	37.6	41.6	3.60	5.0
40 HP	50	380-415	Min.:342, Max.:456	74.5	82.0	100	17.7	41.2	47.0	3.60	5.0
42 HP	50	380-415	Min.:342, Max.:456	91.0	101.0	100	22.0	41.5	44.8	3.60	5.0
44 HP	50	380-415	Min.:342, Max.:456	92.0	103.0	100	22.0	44.3	49.7	3.60	5.0
46 HP	50	380-415	Min.:342, Max.:456	91.2	104.0	100	22.0	49.5	53.1	3.60	5.0
48 HP	50	380-415	Min.:342, Max.:456	98.2	108.0	125	23.6	51.9	56.4	3.60	5.0
50 HP	50	380-415	Min.:342, Max.:456	100.0	110.0	125	23.6	47.7	53.6	4.80	7.5
52 HP	50	380-415	Min.:342, Max.:456	100.0	110.0	125	23.6	51.3	58.9	4.80	7.5
54 HP	50	380-415	Min.:342, Max.:456	113.2	129.0	125	27.9	51.5	56.7	4.80	7.5
56 HP	50	380-415	Min.:342, Max.:456	115.9	131.0	125	27.9	54.4	61.6	4.80	7.5
58 HP	50	380-415	Min.:342, Max.:456	120.0	132.0	150	27.9	59.6	65.0	4.80	7.5
60 HP	50	380-415	Min.:342, Max.:456	123.6	136.0	150	29.5	61.9	68.3	4.80	7.5
62 HP	50	380-415	Min.:342, Max.:456	123.6	136.0	150	29.5	63.5	69.9	5.40	7.5
64 HP	50	380-415	Min.:342, Max.:456	123.6	136.0	150	29.5	67.2	75.2	5.40	7.5
66 HP	50	380-415	Min.:342, Max.:456	134.8	155.0	150	33.8	67.4	73.0	5.40	7.5
68 HP	50	380-415	Min.:342, Max.:456	136.5	157.0	150	33.8	70.2	77.9	5.40	7.5
70 HP	50	380-415	Min.:342, Max.:456	136.2	158.0	150	33.8	75.4	81.3	5.40	7.5
72 HP	50	380-415	Min.:342, Max.:456	147.3	162.0	175	35.4	77.9	84.6	5.40	7.5
74 HP	50	380-415	Min.:342, Max.:456	149.1	164.0	175	35.4	73.6	81.8	6.60	10.0
76 HP	50	380-415	Min.:342, Max.:456	149.1	164.0	175	35.4	77.3	87.1	6.60	10.0
78 HP	50	380-415	Min.:342, Max.:456	166.4	183.0	200	39.7	77.5	84.9	6.60	10.0
80 HP	50	380-415	Min.:342, Max.:456	168.2	185.0	200	39.7	80.3	89.8	6.60	10.0
82 HP	50	380-415	Min.:342, Max.:456	169.1	186.0	200	39.7	85.5	93.2	6.60	10.0
84 HP	50	380-415	Min.:342, Max.:456	172.7	190.0	200	41.3	88.0	96.6	6.60	10.0

#### Note

- Voltage supplied to the unit terminals should be within the minimum and maximum range.
- Maximum allowable voltage unbalance between phase is 2%.
- MSC means the Max. current during the starting of compressor.
- MSC and RLA are measured as the compressor only test condition.
- OFM are measured as the outdoor unit test condition.
- TOCA means the total over current value of each outdoor unit.
- Select the wire size based on the larger value among MCA or TOCA.
- MFA is used to select the circuit breaker and ground fault circuit interrupter, and all installation site must require attachment of an earth leakage breaker. [circuit breaker type is ELCB(Earth Leakage Circuit Breaker)].
  - It is recommended that the fuse capacity is equal than Sum of MCA of each combined outdoor unit \* 1.1
- Select the electrical equipment of combination unit according to the electrical characteristics of individual unit.

\* : 2 unit combination models

#### Symbols

- MCA** : Minimum Circuit Amperes (A)  
**TOCA** : Total Over Current Amperes (A)  
**MFA** : Maximum Fuse Amperes (A)  
**MSC** : Maximum Starting Current (A)  
**RLA** : Rated Load Amperes (A)  
**OFM** : Outdoor Fan Motor  
**kW** : Fan Motor rated output (kW)  
**FLA** : Full Load Amperes (A)



## 6. Electric Characteristics

Model	Unit			Power Supply			COMP			OFM	
	Hz	Volts	Voltage-range	MCA	TOCA	MFA	MSC	RLA(Cooling)	RLA(Heating)	kW	FLA
86 HP	50	380-415	Min.:342, Max.:456	172.7	190.0	200	41.3	89.5	98.1	7.20	10.0
88 HP	50	380-415	Min.:342, Max.:456	172.7	190.0	200	41.3	93.2	103.4	7.20	10.0
90 HP	50	380-415	Min.:342, Max.:456	190.0	209.0	200	45.6	93.3	101.2	7.20	10.0
92 HP	50	380-415	Min.:342, Max.:456	191.8	211.0	200	45.6	96.1	106.1	7.20	10.0
94 HP	50	380-415	Min.:342, Max.:456	192.7	212.0	200	45.6	101.3	109.5	7.20	10.0
96 HP	50	380-415	Min.:342, Max.:456	196.4	216.0	250	47.2	103.8	112.8	7.20	10.0

### Note

- Voltage supplied to the unit terminals should be within the minimum and maximum range.
  - Maximum allowable voltage unbalance between phase is 2%.
  - MSC means the Max. current during the starting of compressor.
  - MSC and RLA are measured as the compressor only test condition.
  - OFM are measured as the outdoor unit test condition.
  - TOCA means the total over current value of each outdoor unit.
  - Select the wire size based on the larger value among MCA or TOCA.
  - MFA is used to select the circuit breaker and ground fault circuit interrupter, and all installation site must require attachment of an earth leakage breaker. [circuit breaker type is ELCB(Earth Leakage Circuit Breaker)].
    - It is recommended that the fuse capacity is equal than Sum of MCA of each combined outdoor unit \* 1.1
  - Select the electrical equipment of combination unit according to the electrical characteristics of individual unit.
- \* : 2 unit combination models

### Symbols

- MCA** : Minimum Circuit Amperes (A)  
**TOCA** : Total Over Current Amperes (A)  
**MFA** : Maximum Fuse Amperes (A)  
**MSC** : Maximum Starting Current (A)  
**RLA** : Rated Load Amperes (A)  
**OFM** : Outdoor Fan Motor  
**kW** : Fan Motor rated output (kW)  
**FLA** : Full Load Amperes (A)

## 6. Electric Characteristics

### 60Hz

Model	Unit			Power Supply			COMP			OFM	
	Hz	Volts	Voltage-range	MCA	TOCA	MFA	MSC	RLA(Cooling)	RLA(Heating)	kW	FLA
8 HP	60	380	Min.:342, Max.:418	18.2	20.0	20	4.3	6.1	5.5	1.20	2.5
10 HP	60	380	Min.:342, Max.:418	25.5	28.0	32	5.9	8.7	7.2	1.20	2.5
12 HP	60	380	Min.:342, Max.:418	25.5	28.0	32	5.9	10.1	11.9	1.20	2.5
14 HP	60	380	Min.:342, Max.:418	25.5	28.0	32	5.9	11.7	13.4	1.80	2.5
16 HP	60	380	Min.:342, Max.:418	25.5	28.0	32	5.9	15.3	18.8	1.80	2.5
18 HP	60	380	Min.:342, Max.:418	42.7	47.0	50	10.2	15.5	16.5	1.80	2.5
20 HP	60	380	Min.:342, Max.:418	44.5	49.0	50	10.2	18.4	21.5	1.80	2.5
22 HP	60	380	Min.:342, Max.:418	45.5	50.0	50	10.2	23.5	24.9	1.80	2.5
24 HP	60	380	Min.:342, Max.:418	49.1	54.0	63	11.8	25.9	28.2	1.80	2.5
26 HP	60	380	Min.:342, Max.:418	49.1	54.0	63	11.8	30.5	28.1	1.80	2.5
22' HP	60	380	Min.:342, Max.:418	50.9	56.0	63	11.8	18.8	19.1	2.40	5.0
24' HP	60	380	Min.:342, Max.:418	50.9	56.0	63	11.8	19.1	20.6	2.40	5.0
26' HP	60	380	Min.:342, Max.:418	50.9	56.0	63	11.8	21.8	25.4	2.40	5.0
28 HP	60	380	Min.:342, Max.:418	50.9	56.0	63	11.8	25.4	30.7	3.00	5.0
30 HP	60	380	Min.:342, Max.:418	68.2	75.0	80	16.1	25.6	28.5	3.00	5.0
32 HP	60	380	Min.:342, Max.:418	70.0	77.0	80	16.1	28.4	33.4	3.00	5.0
34 HP	60	380	Min.:342, Max.:418	69.6	78.0	80	16.1	33.6	36.8	3.00	5.0
36 HP	60	380	Min.:342, Max.:418	71.9	82.0	80	17.7	36.0	40.1	3.00	5.0
38 HP	60	380	Min.:342, Max.:418	72.6	82.0	100	17.7	37.6	41.6	3.60	5.0
40 HP	60	380	Min.:342, Max.:418	74.5	82.0	100	17.7	41.2	47.0	3.60	5.0
42 HP	60	380	Min.:342, Max.:418	91.0	101.0	100	22.0	41.5	44.8	3.60	5.0
44 HP	60	380	Min.:342, Max.:418	92.0	103.0	100	22.0	44.3	49.7	3.60	5.0
46 HP	60	380	Min.:342, Max.:418	91.2	104.0	100	22.0	49.5	53.1	3.60	5.0
48 HP	60	380	Min.:342, Max.:418	98.2	108.0	125	23.6	51.9	56.4	3.60	5.0
50 HP	60	380	Min.:342, Max.:418	100.0	110.0	125	23.6	47.7	53.6	4.80	7.5
52 HP	60	380	Min.:342, Max.:418	100.0	110.0	125	23.6	51.3	58.9	4.80	7.5
54 HP	60	380	Min.:342, Max.:418	113.2	129.0	125	27.9	51.5	56.7	4.80	7.5
56 HP	60	380	Min.:342, Max.:418	115.9	131.0	125	27.9	54.4	61.6	4.80	7.5
58 HP	60	380	Min.:342, Max.:418	120.0	132.0	150	27.9	59.6	65.0	4.80	7.5
60 HP	60	380	Min.:342, Max.:418	123.6	136.0	150	29.5	61.9	68.3	4.80	7.5
62 HP	60	380	Min.:342, Max.:418	123.6	136.0	150	29.5	63.5	69.9	5.40	7.5
64 HP	60	380	Min.:342, Max.:418	123.6	136.0	150	29.5	67.2	75.2	5.40	7.5
66 HP	60	380	Min.:342, Max.:418	134.8	155.0	150	33.8	67.4	73.0	5.40	7.5
68 HP	60	380	Min.:342, Max.:418	136.5	157.0	150	33.8	70.2	77.9	5.40	7.5
70 HP	60	380	Min.:342, Max.:418	136.2	158.0	150	33.8	75.4	81.3	5.40	7.5
72 HP	60	380	Min.:342, Max.:418	147.3	162.0	175	35.4	77.9	84.6	5.40	7.5
74 HP	60	380	Min.:342, Max.:418	149.1	164.0	175	35.4	73.6	81.8	6.60	10.0
76 HP	60	380	Min.:342, Max.:418	149.1	164.0	175	35.4	77.3	87.1	6.60	10.0
78 HP	60	380	Min.:342, Max.:418	166.4	183.0	200	39.7	77.5	84.9	6.60	10.0
80 HP	60	380	Min.:342, Max.:418	168.2	185.0	200	39.7	80.3	89.8	6.60	10.0
82 HP	60	380	Min.:342, Max.:418	169.1	186.0	200	39.7	85.5	93.2	6.60	10.0
84 HP	60	380	Min.:342, Max.:418	172.7	190.0	200	41.3	88.0	96.6	6.60	10.0

#### Note

- Voltage supplied to the unit terminals should be within the minimum and maximum range.
- Maximum allowable voltage unbalance between phase is 2%.
- MSC means the Max. current during the starting of compressor.
- MSC and RLA are measured as the compressor only test condition.
- OFM are measured as the outdoor unit test condition.
- TOCA means the total over current value of each outdoor unit.
- Select the wire size based on the larger value among MCA or TOCA.
- MFA is used to select the circuit breaker and ground fault circuit interrupter, and all installation site must require attachment of an earth leakage breaker. [circuit breaker type is ELCB(Earth Leakage Circuit Breaker)].
  - It is recommended that the fuse capacity is equal than Sum of MCA of each combined outdoor unit \* 1.1
- Select the electrical equipment of combination unit according to the electrical characteristics of individual unit.

\* : 2 unit combination models

#### Symbols

- MCA** : Minimum Circuit Amperes (A)  
**TOCA** : Total Over Current Amperes (A)  
**MFA** : Maximum Fuse Amperes (A)  
**MSC** : Maximum Starting Current (A)  
**RLA** : Rated Load Amperes (A)  
**OFM** : Outdoor Fan Motor  
**kW** : Fan Motor rated output (kW)  
**FLA** : Full Load Amperes (A)

## 6. Electric Characteristics

Model	Unit			Power Supply			COMP			OFM	
	Hz	Volts	Voltage-range	MCA	TOCA	MFA	MSC	RLA(Cooling)	RLA(Heating)	kW	FLA
86 HP	60	380	Min.:342, Max.:418	172.7	190.0	200	41.3	89.5	98.1	7.20	10.0
88 HP	60	380	Min.:342, Max.:418	172.7	190.0	200	41.3	93.2	103.4	7.20	10.0
90 HP	60	380	Min.:342, Max.:418	190.0	209.0	200	45.6	93.3	101.2	7.20	10.0
92 HP	60	380	Min.:342, Max.:418	191.8	211.0	200	45.6	96.1	106.1	7.20	10.0
94 HP	60	380	Min.:342, Max.:418	192.7	212.0	200	45.6	101.3	109.5	7.20	10.0
96 HP	60	380	Min.:342, Max.:418	196.4	216.0	250	47.2	103.8	112.8	7.20	10.0

### Note

- Voltage supplied to the unit terminals should be within the minimum and maximum range.
  - Maximum allowable voltage unbalance between phase is 2%.
  - MSC means the Max. current during the starting of compressor.
  - MSC and RLA are measured as the compressor only test condition.
  - OFM are measured as the outdoor unit test condition.
  - TOCA means the total over current value of each outdoor unit.
  - Select the wire size based on the larger value among MCA or TOCA.
  - MFA is used to select the circuit breaker and ground fault circuit interrupter, and all installation site must require attachment of an earth leakage breaker. [circuit breaker type is ELCB(Earth Leakage Circuit Breaker)].
    - It is recommended that the fuse capacity is equal than Sum of MCA of each combined outdoor unit \* 1.1
  - Select the electrical equipment of combination unit according to the electrical characteristics of individual unit.
- \* : 2 unit combination models

### Symbols

- MCA** : Minimum Circuit Amperes (A)  
**TOCA** : Total Over Current Amperes (A)  
**MFA** : Maximum Fuse Amperes (A)  
**MSC** : Maximum Starting Current (A)  
**RLA** : Rated Load Amperes (A)  
**OFM** : Outdoor Fan Motor  
**kW** : Fan Motor rated output (kW)  
**FLA** : Full Load Amperes (A)

# 7. Capacity Tables

## 7.1 Cooling Capacity

### 7.1.1 Standard Mode

◆ ARUM080LTE5

Cooling Capacity (8HP)

Combination (%)	Outdoor air temp. (DB, °C)	Indoor air temp. (DB/WB, °C)													
		20		23		26		27		28		30		32	
		14	16	18	19	20	22	24	TC	PI	TC	PI	TC	PI	
130	10	22.2	2.24	26.4	2.74	28.3	3.18	29.1	3.24	29.9	3.27	31.4	3.29	32.2	3.30
	12	22.2	2.30	26.4	2.84	28.3	3.31	29.1	3.33	29.9	3.35	31.4	3.38	32.2	3.41
	14	22.2	2.37	26.4	2.94	28.3	3.43	29.1	3.46	29.9	3.48	31.4	3.51	32.2	3.54
	16	22.2	2.46	26.4	3.04	28.3	3.58	29.1	3.62	29.9	3.65	31.4	3.68	32.2	3.71
	18	22.2	2.56	26.4	3.22	28.3	3.75	29.1	3.83	29.9	3.86	31.4	3.90	32.2	3.93
	20	22.2	2.68	26.4	3.43	28.3	3.93	29.1	4.21	29.9	4.25	30.9	4.29	31.7	4.32
	21	22.2	2.75	26.4	3.55	28.3	4.02	29.1	4.46	29.9	4.49	30.8	4.54	31.6	4.57
	23	22.2	2.95	26.4	3.73	28.3	4.23	29.1	4.92	29.6	4.96	30.3	5.01	31.1	5.04
	25	22.2	3.15	26.4	3.95	28.3	4.51	28.8	5.46	29.1	5.50	29.9	5.55	30.8	5.59
	27	22.2	3.37	26.4	4.22	28.0	4.81	28.3	6.01	28.8	6.05	29.6	6.11	30.3	6.16
	29	22.2	3.59	26.4	4.51	27.5	5.18	27.9	6.60	28.3	6.64	29.1	6.70	29.9	6.73
	31	22.2	3.83	26.3	4.75	27.1	5.50	27.5	6.57	27.9	6.61	28.7	6.67	29.5	6.70
	33	22.2	4.08	25.9	5.03	26.7	5.90	27.1	6.51	27.5	6.55	28.3	6.61	29.0	6.64
	35	22.2	4.35	25.4	5.27	26.2	6.40	26.7	6.43	27.1	6.47	27.9	6.52	28.7	6.55
	37	22.2	4.64	25.1	5.53	25.9	6.31	26.2	6.34	26.7	6.38	27.4	6.44	28.2	6.46
	39	22.2	4.94	24.6	5.82	25.4	6.23	25.9	6.26	26.2	6.30	27.1	6.35	27.9	6.38
	41	21.6	5.24	23.6	6.11	24.4	6.14	24.8	6.17	25.2	6.21	26.0	6.27	26.7	6.29
	43	21.1	5.52	22.6	6.03	23.4	6.06	23.8	6.09	24.2	6.12	25.0	6.18	25.7	6.20
46	19.8	5.91	20.6	5.90	21.4	5.93	21.7	5.96	22.2	6.00	22.9	6.05	23.5	6.07	
48	17.5	5.75	17.9	5.77	18.6	5.78	18.9	5.79	19.3	5.84	19.9	5.88	20.5	5.90	
120	10	20.1	2.01	23.9	2.47	26.1	2.94	26.9	3.17	27.7	3.22	29.2	3.24	29.9	3.26
	12	20.1	2.07	23.9	2.55	26.1	3.05	26.9	3.24	27.7	3.34	29.2	3.38	29.9	3.41
	14	20.1	2.14	23.9	2.64	26.1	3.18	26.9	3.36	27.7	3.46	29.2	3.52	29.9	3.54
	16	20.1	2.22	23.9	2.75	26.1	3.30	26.9	3.49	27.7	3.63	29.2	3.67	29.9	3.70
	18	20.1	2.30	23.9	2.87	26.1	3.43	26.9	3.67	27.7	3.81	29.2	3.85	29.9	3.89
	20	20.1	2.39	23.9	3.05	26.1	3.62	26.9	3.86	27.7	4.01	29.2	4.07	29.9	4.10
	21	20.1	2.46	23.9	3.16	26.1	3.72	26.9	3.98	27.7	4.14	29.2	4.20	29.9	4.23
	23	20.1	2.63	23.9	3.38	26.1	3.98	26.9	4.23	27.7	4.42	29.2	4.46	29.9	4.50
	25	20.1	2.82	23.9	3.62	26.1	4.20	26.9	4.51	27.7	4.74	28.8	4.78	29.5	4.82
	27	20.1	3.01	23.9	3.87	26.1	4.47	26.9	4.81	27.7	5.09	28.4	5.13	29.1	5.17
	29	20.1	3.21	23.9	4.13	26.1	4.71	26.9	5.15	27.2	5.43	27.9	5.51	28.7	5.55
	31	20.1	3.42	23.9	4.41	26.1	4.95	26.5	5.52	26.9	5.82	27.6	5.93	28.3	5.97
	33	20.1	3.64	23.9	4.70	25.7	5.24	26.1	5.99	26.4	6.25	27.1	6.32	27.9	6.37
	35	20.1	3.87	23.9	5.01	25.3	5.54	25.6	6.60	26.1	6.63	26.8	6.65	27.5	6.71
	37	20.1	4.16	23.9	5.29	24.9	5.91	25.3	6.46	25.6	6.49	26.4	6.51	27.1	6.56
	39	20.1	4.48	23.8	5.59	24.5	6.27	24.8	6.33	25.2	6.36	26.0	6.38	26.7	6.43
	41	19.6	4.80	22.7	5.89	23.5	6.14	23.8	6.20	24.2	6.23	24.9	6.25	25.6	6.29
	43	19.1	5.12	21.8	5.80	22.6	6.00	22.9	6.06	23.2	6.09	23.9	6.11	24.6	6.16
46	17.9	5.51	19.9	5.67	20.6	5.82	20.9	5.86	21.2	5.89	21.9	5.91	22.5	5.96	
48	15.8	5.39	17.3	5.56	17.9	5.70	18.2	5.74	18.4	5.76	19.0	5.78	19.6	5.80	
110	10	18.0	1.81	21.4	2.21	24.0	2.62	24.6	2.84	26.2	3.06	26.8	3.14	28.6	3.19
	12	18.0	1.87	21.4	2.28	24.0	2.73	24.6	2.92	26.2	3.17	26.8	3.27	28.6	3.35
	14	18.0	1.93	21.4	2.39	24.0	2.86	24.6	3.07	26.2	3.33	26.8	3.43	28.6	3.50
	16	18.0	2.00	21.4	2.47	24.0	2.97	24.6	3.20	26.2	3.48	26.8	3.58	28.6	3.64
	18	18.0	2.07	21.4	2.58	24.0	3.15	24.6	3.37	26.2	3.68	26.8	3.75	28.6	3.82
	20	18.0	2.14	21.4	2.71	24.0	3.34	24.6	3.52	26.2	3.85	26.8	3.95	28.6	4.01
	21	18.0	2.19	21.4	2.79	24.0	3.42	24.6	3.62	26.2	3.96	26.8	4.06	28.6	4.13
	23	18.0	2.33	21.4	2.99	24.0	3.61	24.6	3.82	26.2	4.19	26.8	4.28	28.6	4.35
	25	18.0	2.49	21.4	3.19	24.0	3.82	24.6	4.04	26.2	4.42	26.8	4.49	28.3	4.58
	27	18.0	2.67	21.4	3.41	24.0	4.03	24.6	4.27	26.2	4.62	26.8	4.72	27.8	4.80
	29	18.0	2.85	21.4	3.64	24.0	4.26	24.6	4.53	26.2	4.88	26.8	4.96	27.5	5.04
	31	18.0	3.03	21.4	3.88	24.0	4.50	24.6	4.80	25.8	5.13	26.5	5.23	27.1	5.28
	33	18.0	3.23	21.4	4.13	24.0	4.76	24.6	5.08	25.4	5.42	26.0	5.51	26.7	5.54
	35	18.0	3.43	21.4	4.41	24.0	5.03	24.6	5.38	25.0	5.72	25.6	5.77	26.3	5.80
	37	18.0	3.63	21.4	4.68	24.0	5.31	24.3	5.70	24.6	6.03	25.2	6.05	25.9	6.07
	39	18.0	3.92	21.4	4.97	23.5	5.60	23.9	6.10	24.2	6.33	24.8	6.34	25.5	6.34
	41	17.5	4.20	20.9	5.26	22.5	5.90	22.9	6.60	23.2	6.60	23.8	6.65	24.4	6.71
	43	17.1	4.41	20.4	5.49	21.6	6.26	21.9	6.33	22.2	6.32	22.9	6.35	23.4	6.37
46	16.0	4.30	19.1	5.30	19.7	5.94	20.0	5.94	20.3	5.99	20.9	6.03	21.4	6.04	
48	14.2	4.18	16.6	5.10	17.1	5.65	17.4	5.69	17.6	5.72	18.2	5.73	18.7	5.76	

# 7. Capacity Tables

Cooling Capacity (8HP)

Combination (%)	Outdoor air temp. (DB, °C)	Indoor air temp. (DB/WB, °C)													
		20		23		26		27		28		30		32	
		14		16		18		19		20		22		24	
		TC	PI	TC	PI	TC	PI	TC	PI	TC	PI	TC	PI	TC	PI
100	10	15.1	1.63	18.0	1.98	21.0	2.35	22.4	2.54	23.8	2.73	26.4	3.04	27.0	3.07
	12	15.1	1.68	18.0	2.06	21.0	2.43	22.4	2.61	23.8	2.82	26.4	3.20	27.0	3.24
	14	15.1	1.74	18.0	2.15	21.0	2.54	22.4	2.72	23.8	2.94	26.4	3.38	27.0	3.42
	16	15.1	1.79	18.0	2.22	21.0	2.64	22.4	2.85	23.8	3.10	26.4	3.55	27.0	3.60
	18	15.1	1.84	18.0	2.30	21.0	2.75	22.4	2.99	23.8	3.29	26.4	3.75	27.0	3.78
	20	15.1	1.91	18.0	2.39	21.0	2.91	22.4	3.21	23.8	3.52	26.4	3.93	27.0	3.96
	21	15.1	1.95	18.0	2.44	21.0	3.01	22.4	3.32	23.8	3.65	26.4	4.02	27.0	4.05
	23	15.1	2.06	18.0	2.61	21.0	3.23	22.4	3.56	23.8	3.91	26.4	4.21	27.0	4.24
	25	15.1	2.19	18.0	2.79	21.0	3.45	22.4	3.81	23.8	4.18	26.4	4.39	26.8	4.42
	27	15.1	2.34	18.0	2.98	21.0	3.69	22.4	4.07	23.8	4.44	25.9	4.59	26.5	4.63
	29	15.1	2.49	18.0	3.18	21.0	3.94	22.4	4.35	23.8	4.70	25.4	4.78	26.1	4.82
	31	15.1	2.67	18.0	3.39	21.0	4.20	22.4	4.64	23.8	4.94	25.1	4.96	25.7	5.00
	33	15.1	2.83	18.0	3.61	21.0	4.48	22.4	4.95	23.8	5.13	24.7	5.15	25.3	5.19
	35	15.1	3.01	18.0	3.84	21.0	4.77	22.4	5.28	23.5	5.31	24.2	5.33	24.8	5.38
	37	15.1	3.22	18.0	4.12	21.0	5.05	22.4	5.53	23.1	5.56	23.8	5.58	24.3	5.63
	39	15.1	3.45	18.0	4.42	21.0	5.35	22.4	5.80	22.7	5.83	23.4	5.85	23.9	5.90
	41	14.9	3.68	17.7	4.73	20.6	5.65	21.5	6.07	22.0	6.10	22.5	6.12	23.2	6.17
	43	14.4	3.90	17.1	5.01	19.9	5.92	20.6	6.30	20.8	6.33	21.5	6.35	22.1	6.41
46	13.5	4.19	16.0	5.40	18.7	6.28	18.8	6.60	19.0	6.62	19.6	6.64	20.2	6.70	
48	11.9	3.62	14.2	4.67	16.1	5.37	16.4	5.60	16.5	5.62	17.1	5.63	17.5	5.68	
90	10	13.6	1.52	16.2	1.83	18.9	2.15	20.2	2.32	21.4	2.50	24.1	2.80	26.7	3.07
	12	13.6	1.54	16.2	1.86	18.9	2.19	20.2	2.37	21.4	2.56	24.1	2.85	26.7	3.17
	14	13.6	1.57	16.2	1.89	18.9	2.24	20.2	2.42	21.4	2.60	24.1	2.91	26.7	3.23
	16	13.6	1.59	16.2	1.93	18.9	2.29	20.2	2.46	21.4	2.65	24.1	2.96	26.7	3.29
	18	13.6	1.62	16.2	1.97	18.9	2.32	20.2	2.52	21.4	2.70	24.1	3.03	26.7	3.45
	20	13.6	1.65	16.2	2.01	18.9	2.37	20.2	2.56	21.4	2.81	24.1	3.24	26.7	3.62
	21	13.6	1.67	16.2	2.02	18.9	2.42	20.2	2.65	21.4	2.91	24.1	3.29	26.7	3.70
	23	13.6	1.71	16.2	2.11	18.9	2.58	20.2	2.84	21.4	3.12	24.1	3.49	26.4	3.87
	25	13.6	1.79	16.2	2.25	18.9	2.76	20.2	3.04	21.4	3.33	24.1	3.74	26.0	4.04
	27	13.6	1.91	16.2	2.40	18.9	2.95	20.2	3.25	21.4	3.56	24.1	3.97	25.6	4.23
	29	13.6	2.02	16.2	2.56	18.9	3.15	20.2	3.47	21.4	3.81	24.1	4.21	25.2	4.40
	31	13.6	2.15	16.2	2.72	18.9	3.36	20.2	3.69	21.4	4.06	24.1	4.42	24.8	4.57
	33	13.6	2.29	16.2	2.90	18.9	3.58	20.2	3.94	21.4	4.30	24.1	4.63	24.4	4.74
	35	13.6	2.43	16.2	3.08	18.9	3.81	20.2	4.20	21.4	4.56	23.7	4.90	24.1	5.01
	37	13.6	2.58	16.2	3.27	18.9	4.06	20.2	4.46	21.4	4.82	23.3	5.12	23.7	5.23
	39	13.6	2.74	16.2	3.48	18.9	4.29	20.2	4.74	21.4	5.07	22.9	5.40	23.3	5.46
	41	13.3	3.06	15.8	3.86	18.4	4.71	19.6	5.19	20.9	5.47	21.9	5.69	22.3	5.82
	43	12.9	3.30	15.4	4.17	17.9	5.15	19.2	5.59	20.4	5.86	21.0	6.09	21.4	6.16
46	12.1	3.72	14.5	4.75	16.8	5.87	18.0	6.34	18.5	6.51	19.2	6.64	19.6	6.69	
48	10.7	3.25	12.8	4.16	14.9	5.13	15.9	5.53	16.1	5.61	16.7	5.63	17.0	5.68	
80	10	12.1	1.42	14.4	1.70	16.7	2.00	17.9	2.15	19.1	2.31	21.4	2.64	23.8	2.86
	12	12.1	1.45	14.4	1.72	16.7	2.04	17.9	2.19	19.1	2.35	21.4	2.69	23.8	2.92
	14	12.1	1.47	14.4	1.76	16.7	2.07	17.9	2.23	19.1	2.39	21.4	2.74	23.8	2.98
	16	12.1	1.49	14.4	1.79	16.7	2.11	17.9	2.27	19.1	2.44	21.4	2.79	23.8	3.03
	18	12.1	1.52	14.4	1.82	16.7	2.14	17.9	2.31	19.1	2.49	21.4	2.84	23.8	3.10
	20	12.1	1.54	14.4	1.86	16.7	2.19	17.9	2.36	19.1	2.54	21.4	2.95	23.8	3.28
	21	12.1	1.55	14.4	1.88	16.7	2.21	17.9	2.39	19.1	2.60	21.4	3.04	23.8	3.37
	23	12.1	1.58	14.4	1.91	16.7	2.31	17.9	2.54	19.1	2.77	21.4	3.21	23.8	3.54
	25	12.1	1.64	14.4	2.04	16.7	2.48	17.9	2.72	19.1	2.97	21.4	3.44	23.8	3.78
	27	12.1	1.74	14.4	2.16	16.7	2.65	17.9	2.90	19.1	3.17	21.4	3.66	23.8	3.98
	29	12.1	1.85	14.4	2.31	16.7	2.81	17.9	3.09	19.1	3.38	21.4	3.92	23.8	4.18
	31	12.1	1.97	14.4	2.45	16.7	3.00	17.9	3.30	19.1	3.60	21.4	4.16	23.8	4.39
	33	12.1	2.09	14.4	2.62	16.7	3.20	17.9	3.51	19.1	3.84	21.4	4.38	23.8	4.60
	35	12.1	2.21	14.4	2.77	16.7	3.40	17.9	3.74	19.1	4.09	21.4	4.64	23.5	4.86
	37	12.1	2.34	14.4	2.95	16.7	3.61	17.9	3.97	19.1	4.35	21.4	4.90	23.1	5.08
	39	12.1	2.47	14.4	3.12	16.7	3.86	17.9	4.27	19.1	4.67	21.4	5.18	22.7	5.36
	41	11.8	2.74	14.0	3.46	16.3	4.24	17.5	4.68	18.6	5.13	20.9	5.57	21.8	5.70
	43	11.5	3.01	13.7	3.77	15.9	4.63	17.0	5.10	18.2	5.61	20.4	5.97	20.9	6.10
46	10.8	3.35	12.8	4.25	14.9	5.21	16.0	5.68	17.0	6.33	18.6	6.64	19.1	6.69	
48	9.5	2.93	11.3	3.71	13.2	4.56	14.1	4.96	15.1	5.54	16.2	5.63	16.6	5.68	

# 7. Capacity Tables

Cooling Capacity (8HP)

Combination (%)	Outdoor air temp. (DB, °C)	Indoor air temp. (DB/WB, °C)													
		20		23		26		27		28		30		32	
		14		16		18		19		20		22		24	
		TC	PI	TC	PI	TC	PI	TC	PI	TC	PI	TC	PI	TC	PI
70	10	10.6	1.25	12.6	1.49	14.6	1.73	15.7	1.86	16.7	1.99	18.7	2.27	20.8	2.54
	12	10.6	1.27	12.6	1.51	14.6	1.76	15.7	1.89	16.7	2.03	18.7	2.31	20.8	2.58
	14	10.6	1.29	12.6	1.53	14.6	1.79	15.7	1.92	16.7	2.06	18.7	2.36	20.8	2.63
	16	10.6	1.31	12.6	1.56	14.6	1.82	15.7	1.96	16.7	2.10	18.7	2.40	20.8	2.69
	18	10.6	1.33	12.6	1.59	14.6	1.86	15.7	2.00	16.7	2.14	18.7	2.44	20.8	2.74
	20	10.6	1.35	12.6	1.62	14.6	1.89	15.7	2.04	16.7	2.19	18.7	2.49	20.8	2.84
	21	10.6	1.37	12.6	1.63	14.6	1.91	15.7	2.06	16.7	2.21	18.7	2.53	20.8	2.90
	23	10.6	1.39	12.6	1.67	14.6	1.95	15.7	2.13	16.7	2.32	18.7	2.71	20.8	3.06
	25	10.6	1.41	12.6	1.73	14.6	2.08	15.7	2.28	16.7	2.47	18.7	2.90	20.8	3.21
	27	10.6	1.49	12.6	1.84	14.6	2.22	15.7	2.42	16.7	2.64	18.7	3.10	20.8	3.41
	29	10.6	1.59	12.6	1.95	14.6	2.36	15.7	2.57	16.7	2.81	18.7	3.30	20.8	3.65
	31	10.6	1.69	12.6	2.08	14.6	2.51	15.7	2.75	16.7	3.00	18.7	3.52	20.8	3.88
	33	10.6	1.78	12.6	2.20	14.6	2.67	15.7	2.92	16.7	3.18	18.7	3.75	20.8	4.13
	35	10.6	1.88	12.6	2.35	14.6	2.84	15.7	3.11	16.7	3.39	18.7	3.99	20.8	4.38
	37	10.6	2.00	12.6	2.49	14.6	3.02	15.7	3.30	16.7	3.61	18.7	4.25	20.8	4.62
	39	10.6	2.13	12.6	2.65	14.6	3.23	15.7	3.55	16.7	3.90	18.7	4.55	20.8	4.98
41	10.3	2.35	12.3	2.90	14.3	3.54	15.3	3.90	16.3	4.24	18.2	4.99	20.3	5.37	
43	10.0	2.56	12.0	3.16	13.9	3.86	14.9	4.25	15.9	4.63	17.8	5.46	19.8	5.81	
46	9.4	2.84	11.3	3.56	13.0	4.35	14.0	4.73	14.9	5.22	16.7	6.15	18.5	6.47	
48	8.3	2.48	10.0	3.11	11.5	3.80	12.4	4.14	13.2	4.56	14.7	5.39	16.4	5.60	
60	10	9.0	1.09	10.8	1.27	12.6	1.48	13.4	1.59	14.3	1.69	16.1	1.92	17.8	2.14
	12	9.0	1.11	10.8	1.29	12.6	1.50	13.4	1.61	14.3	1.72	16.1	1.95	17.8	2.18
	14	9.0	1.12	10.8	1.31	12.6	1.53	13.4	1.64	14.3	1.75	16.1	1.99	17.8	2.22
	16	9.0	1.14	10.8	1.34	12.6	1.55	13.4	1.67	14.3	1.79	16.1	2.03	17.8	2.26
	18	9.0	1.16	10.8	1.36	12.6	1.58	13.4	1.70	14.3	1.82	16.1	2.05	17.8	2.31
	20	9.0	1.18	10.8	1.38	12.6	1.61	13.4	1.73	14.3	1.85	16.1	2.09	17.8	2.36
	21	9.0	1.19	10.8	1.39	12.6	1.63	13.4	1.75	14.3	1.87	16.1	2.12	17.8	2.38
	23	9.0	1.21	10.8	1.42	12.6	1.65	13.4	1.78	14.3	1.91	16.1	2.20	17.8	2.53
	25	9.0	1.22	10.8	1.45	12.6	1.72	13.4	1.87	14.3	2.03	16.1	2.35	17.8	2.71
	27	9.0	1.26	10.8	1.53	12.6	1.83	13.4	1.99	14.3	2.15	16.1	2.50	17.8	2.88
	29	9.0	1.34	10.8	1.63	12.6	1.95	13.4	2.11	14.3	2.29	16.1	2.67	17.8	3.08
	31	9.0	1.42	10.8	1.73	12.6	2.06	13.4	2.25	14.3	2.44	16.1	2.85	17.8	3.28
	33	9.0	1.50	10.8	1.83	12.6	2.19	13.4	2.39	14.3	2.60	16.1	3.02	17.8	3.50
	35	9.0	1.59	10.8	1.95	12.6	2.33	13.4	2.54	14.3	2.76	16.1	3.22	17.8	3.71
	37	9.0	1.68	10.8	2.05	12.6	2.47	13.4	2.70	14.3	2.92	16.1	3.42	17.8	3.95
	39	9.0	1.79	10.8	2.19	12.6	2.67	13.4	2.89	14.3	3.15	16.1	3.66	17.8	4.23
41	8.8	1.94	10.5	2.39	12.2	2.89	13.1	3.16	14.0	3.42	15.7	4.02	17.4	4.60	
43	8.6	2.10	10.3	2.61	11.9	3.16	12.8	3.44	13.6	3.72	15.3	4.39	17.0	5.03	
46	8.1	2.36	9.6	2.93	11.2	3.55	12.0	3.87	12.8	4.19	14.3	4.95	15.9	5.73	
48	7.1	2.05	8.5	2.55	9.9	3.10	10.6	3.38	11.3	3.66	12.7	4.33	14.1	5.01	
50	10	7.6	0.94	9.0	1.09	10.5	1.24	11.2	1.33	11.9	1.41	13.4	1.58	14.9	1.76
	12	7.6	0.95	9.0	1.10	10.5	1.26	11.2	1.35	11.9	1.44	13.4	1.61	14.9	1.79
	14	7.6	0.96	9.0	1.12	10.5	1.28	11.2	1.37	11.9	1.46	13.4	1.63	14.9	1.82
	16	7.6	0.98	9.0	1.14	10.5	1.30	11.2	1.40	11.9	1.47	13.4	1.66	14.9	1.85
	18	7.6	0.99	9.0	1.15	10.5	1.32	11.2	1.42	11.9	1.50	13.4	1.69	14.9	1.89
	20	7.6	1.00	9.0	1.17	10.5	1.35	11.2	1.44	11.9	1.53	13.4	1.72	14.9	1.93
	21	7.6	1.01	9.0	1.18	10.5	1.36	11.2	1.46	11.9	1.54	13.4	1.74	14.9	1.95
	23	7.6	1.03	9.0	1.20	10.5	1.38	11.2	1.47	11.9	1.57	13.4	1.77	14.9	1.99
	25	7.6	1.04	9.0	1.22	10.5	1.41	11.2	1.50	11.9	1.62	13.4	1.86	14.9	2.13
	27	7.6	1.06	9.0	1.26	10.5	1.48	11.2	1.60	11.9	1.72	13.4	1.99	14.9	2.27
	29	7.6	1.12	9.0	1.34	10.5	1.57	11.2	1.70	11.9	1.83	13.4	2.11	14.9	2.41
	31	7.6	1.18	9.0	1.42	10.5	1.67	11.2	1.80	11.9	1.95	13.4	2.25	14.9	2.56
	33	7.6	1.25	9.0	1.49	10.5	1.77	11.2	1.91	11.9	2.07	13.4	2.39	14.9	2.73
	35	7.6	1.32	9.0	1.58	10.5	1.87	11.2	2.03	11.9	2.19	13.4	2.52	14.9	2.90
	37	7.6	1.40	9.0	1.67	10.5	1.98	11.2	2.15	11.9	2.32	13.4	2.69	14.9	3.08
	39	7.6	1.49	9.0	1.79	10.5	2.12	11.2	2.31	11.9	2.49	13.4	2.87	14.9	3.33
41	7.4	1.61	8.8	1.94	10.2	2.32	10.9	2.50	11.6	2.69	13.0	3.14	14.5	3.61	
43	7.2	1.75	8.6	2.11	10.0	2.52	10.6	2.73	11.3	2.93	12.7	3.43	14.1	3.94	
46	6.7	1.96	8.1	2.37	9.3	2.83	10.0	3.06	10.6	3.29	11.9	3.86	13.3	4.43	
48	6.0	1.71	7.1	2.07	8.3	2.47	8.8	2.67	9.4	2.87	10.5	3.37	11.7	3.88	

**Note**

1. TC: Total Capacity(kW), PI : Power Input(kW, Comp. + Outdoor fan motor)
2. Capacity tables show the average value of conditions which may occur.

# 7. Capacity Tables

◆ ARUM100LTE5

Cooling Capacity (10HP)

Combination (%)	Outdoor air temp. (DB, °C)	Indoor air temp. (DB/WB, °C)													
		20		23		26		27		28		30		32	
		14	16	16	18	18	19	19	20	20	22	22	24	24	
		TC	PI	TC	PI	TC	PI	TC	PI	TC	PI	TC	PI	TC	PI
130	10	27.7	2.90	33.0	3.54	35.4	4.11	36.4	4.19	37.4	4.22	39.2	4.26	40.2	4.28
	12	27.7	2.97	33.0	3.67	35.4	4.28	36.4	4.30	37.4	4.34	39.2	4.37	40.2	4.41
	14	27.7	3.07	33.0	3.80	35.4	4.44	36.4	4.47	37.4	4.51	39.2	4.54	40.2	4.58
	16	27.7	3.18	33.0	3.93	35.4	4.64	36.4	4.68	37.4	4.72	39.2	4.76	40.2	4.80
	18	27.7	3.31	33.0	4.16	35.4	4.85	36.4	4.95	37.4	4.99	39.2	5.04	40.2	5.08
	20	27.7	3.46	33.0	4.43	35.4	5.09	36.4	5.45	37.4	5.49	38.7	5.55	39.7	5.59
	21	27.7	3.55	33.0	4.59	35.4	5.19	36.4	5.77	37.4	5.81	38.4	5.87	39.5	5.91
	23	27.7	3.81	33.0	4.83	35.4	5.47	36.4	6.36	37.0	6.41	37.9	6.48	38.9	6.52
	25	27.7	4.07	33.0	5.10	35.4	5.84	36.0	7.06	36.4	7.11	37.4	7.18	38.4	7.23
	27	27.7	4.35	33.0	5.46	35.0	6.22	35.4	7.77	36.0	7.83	37.0	7.91	37.9	7.96
	29	27.7	4.64	33.0	5.83	34.4	6.69	34.9	8.54	35.4	8.59	36.4	8.67	37.4	8.70
	31	27.7	4.95	32.9	6.14	33.8	7.12	34.4	8.50	34.9	8.55	35.8	8.63	36.9	8.66
	33	27.7	5.27	32.4	6.51	33.4	7.64	33.9	8.42	34.4	8.47	35.4	8.55	36.3	8.58
	35	27.7	5.62	31.8	6.82	32.8	8.27	33.4	8.31	33.9	8.36	34.8	8.44	35.8	8.47
	37	27.7	6.00	31.3	7.15	32.4	8.16	32.8	8.20	33.4	8.25	34.3	8.33	35.3	8.36
	39	27.7	6.39	30.8	7.53	31.8	8.05	32.4	8.09	32.8	8.14	33.8	8.22	34.8	8.25
41	27.0	6.78	29.5	7.91	30.5	7.94	31.0	7.98	31.6	8.03	32.5	8.10	33.4	8.14	
43	26.4	7.15	28.3	7.80	29.3	7.84	29.7	7.88	30.3	7.92	31.2	7.99	32.1	8.02	
46	24.7	7.65	25.8	7.63	26.7	7.67	27.1	7.71	27.7	7.76	28.6	7.83	29.4	7.86	
48	21.8	7.44	22.4	7.46	23.2	7.47	23.6	7.49	24.1	7.56	24.9	7.61	25.6	7.64	
120	10	25.1	2.61	29.8	3.20	32.6	3.80	33.6	4.10	34.6	4.17	36.5	4.19	37.4	4.22
	12	25.1	2.68	29.8	3.30	32.6	3.95	33.6	4.19	34.6	4.32	36.5	4.38	37.4	4.41
	14	25.1	2.77	29.8	3.42	32.6	4.11	33.6	4.35	34.6	4.48	36.5	4.55	37.4	4.58
	16	25.1	2.87	29.8	3.56	32.6	4.27	33.6	4.51	34.6	4.69	36.5	4.75	37.4	4.78
	18	25.1	2.98	29.8	3.72	32.6	4.44	33.6	4.75	34.6	4.93	36.5	4.99	37.4	5.03
	20	25.1	3.09	29.8	3.94	32.6	4.68	33.6	5.00	34.6	5.19	36.5	5.26	37.4	5.30
	21	25.1	3.19	29.8	4.08	32.6	4.81	33.6	5.15	34.6	5.36	36.5	5.43	37.4	5.47
	23	25.1	3.41	29.8	4.37	32.6	5.15	33.6	5.47	34.6	5.72	36.5	5.77	37.4	5.82
	25	25.1	3.64	29.8	4.68	32.6	5.44	33.6	5.83	34.6	6.13	36.0	6.18	36.9	6.23
	27	25.1	3.89	29.8	5.00	32.6	5.78	33.6	6.23	34.6	6.59	35.5	6.63	36.4	6.68
	29	25.1	4.15	29.8	5.34	32.6	6.09	33.6	6.66	34.0	7.02	34.9	7.13	35.9	7.18
	31	25.1	4.42	29.8	5.70	32.6	6.40	33.2	7.14	33.6	7.53	34.5	7.66	35.4	7.73
	33	25.1	4.70	29.8	6.08	32.2	6.77	32.6	7.75	33.0	8.09	33.9	8.18	34.8	8.24
	35	25.1	5.00	29.8	6.48	31.6	7.17	32.1	8.54	32.6	8.58	33.5	8.61	34.4	8.67
	37	25.1	5.38	29.8	6.84	31.2	7.64	31.6	8.36	32.1	8.40	32.9	8.42	33.8	8.49
	39	25.1	5.79	29.7	7.23	30.6	8.11	31.1	8.19	31.5	8.23	32.5	8.25	33.4	8.32
41	24.5	6.20	28.4	7.62	29.4	7.95	29.8	8.01	30.2	8.05	31.1	8.08	32.0	8.14	
43	23.8	6.62	27.2	7.51	28.2	7.77	28.6	7.84	29.0	7.88	29.9	7.91	30.7	7.97	
46	22.3	7.12	24.8	7.33	25.7	7.52	26.1	7.59	26.5	7.62	27.3	7.65	28.1	7.71	
48	19.8	6.98	21.6	7.20	22.4	7.38	22.7	7.42	23.1	7.45	23.8	7.48	24.5	7.50	
110	10	22.5	2.34	26.8	2.86	29.9	3.39	30.8	3.67	32.7	3.95	33.5	4.06	35.8	4.13
	12	22.5	2.42	26.8	2.95	29.9	3.53	30.8	3.78	32.7	4.10	33.5	4.23	35.8	4.33
	14	22.5	2.49	26.8	3.09	29.9	3.70	30.8	3.96	32.7	4.31	33.5	4.43	35.8	4.53
	16	22.5	2.58	26.8	3.20	29.9	3.85	30.8	4.14	32.7	4.51	33.5	4.63	35.8	4.71
	18	22.5	2.68	26.8	3.33	29.9	4.07	30.8	4.36	32.7	4.76	33.5	4.85	35.8	4.94
	20	22.5	2.77	26.8	3.50	29.9	4.32	30.8	4.56	32.7	4.99	33.5	5.11	35.8	5.19
	21	22.5	2.83	26.8	3.60	29.9	4.43	30.8	4.68	32.7	5.12	33.5	5.25	35.8	5.34
	23	22.5	3.02	26.8	3.86	29.9	4.67	30.8	4.94	32.7	5.41	33.5	5.53	35.8	5.62
	25	22.5	3.23	26.8	4.12	29.9	4.94	30.8	5.22	32.7	5.72	33.5	5.80	35.3	5.92
	27	22.5	3.45	26.8	4.41	29.9	5.22	30.8	5.53	32.7	5.97	33.5	6.11	34.8	6.21
	29	22.5	3.68	26.8	4.70	29.9	5.51	30.8	5.85	32.7	6.31	33.5	6.42	34.4	6.52
	31	22.5	3.91	26.8	5.02	29.9	5.83	30.8	6.20	32.2	6.63	33.1	6.76	33.8	6.83
	33	22.5	4.17	26.8	5.34	29.9	6.16	30.8	6.57	31.8	7.01	32.5	7.12	33.4	7.16
	35	22.5	4.43	26.8	5.70	29.9	6.50	30.8	6.97	31.2	7.39	32.0	7.46	32.9	7.50
	37	22.5	4.70	26.8	6.05	29.9	6.86	30.4	7.38	30.7	7.80	31.6	7.83	32.3	7.85
	39	22.5	5.06	26.8	6.43	29.4	7.24	29.8	7.89	30.3	8.18	31.0	8.20	31.9	8.21
41	21.9	5.43	26.1	6.81	28.1	7.64	28.6	8.54	28.9	8.54	29.8	8.61	30.5	8.67	
43	21.4	5.70	25.5	7.10	27.0	8.10	27.4	8.19	27.8	8.17	28.6	8.22	29.3	8.24	
46	20.0	5.57	23.9	6.85	24.6	7.69	25.0	7.69	25.4	7.75	26.1	7.79	26.8	7.82	
48	17.7	5.41	20.7	6.60	21.4	7.31	21.8	7.36	22.0	7.40	22.7	7.42	23.3	7.45	

# 7. Capacity Tables

Cooling Capacity (10HP)

Combination (%)	Outdoor air temp. (DB, °C)	Indoor air temp. (DB/WB, °C)													
		20		23		26		27		28		30		32	
		14		16		18		19		20		22		24	
		TC	PI	TC	PI	TC	PI	TC	PI	TC	PI	TC	PI	TC	PI
100	10	18.9	2.11	22.5	2.57	26.2	3.04	28.0	3.29	29.8	3.53	33.0	3.93	33.8	3.97
	12	18.9	2.18	22.5	2.67	26.2	3.15	28.0	3.38	29.8	3.65	33.0	4.15	33.8	4.19
	14	18.9	2.25	22.5	2.78	26.2	3.28	28.0	3.52	29.8	3.80	33.0	4.38	33.8	4.42
	16	18.9	2.32	22.5	2.87	26.2	3.42	28.0	3.69	29.8	4.01	33.0	4.59	33.8	4.65
	18	18.9	2.38	22.5	2.98	26.2	3.55	28.0	3.87	29.8	4.25	33.0	4.85	33.8	4.89
	20	18.9	2.47	22.5	3.09	26.2	3.76	28.0	4.15	29.8	4.55	33.0	5.08	33.8	5.12
	21	18.9	2.52	22.5	3.16	26.2	3.89	28.0	4.29	29.8	4.72	33.0	5.20	33.8	5.24
	23	18.9	2.67	22.5	3.38	26.2	4.17	28.0	4.60	29.8	5.05	33.0	5.44	33.8	5.49
	25	18.9	2.84	22.5	3.60	26.2	4.46	28.0	4.92	29.8	5.40	33.0	5.67	33.5	5.72
	27	18.9	3.03	22.5	3.85	26.2	4.77	28.0	5.26	29.8	5.75	32.4	5.94	33.1	5.99
	29	18.9	3.23	22.5	4.11	26.2	5.09	28.0	5.62	29.8	6.08	31.8	6.18	32.6	6.23
	31	18.9	3.45	22.5	4.38	26.2	5.43	28.0	6.00	29.8	6.39	31.3	6.42	32.1	6.47
	33	18.9	3.65	22.5	4.67	26.2	5.79	28.0	6.40	29.8	6.63	30.8	6.66	31.6	6.71
	35	18.9	3.89	22.5	4.96	26.2	6.17	28.0	6.83	29.3	6.87	30.3	6.90	31.0	6.95
	37	18.9	4.16	22.5	5.32	26.2	6.53	28.0	7.16	28.9	7.19	29.7	7.22	30.4	7.29
	39	18.9	4.46	22.5	5.72	26.2	6.92	28.0	7.50	28.4	7.54	29.2	7.57	29.9	7.64
	41	18.6	4.76	22.1	6.11	25.8	7.31	26.9	7.85	27.5	7.89	28.1	7.91	29.0	7.99
43	18.0	5.04	21.4	6.48	24.9	7.66	25.8	8.16	26.1	8.18	26.9	8.21	27.6	8.29	
46	16.8	5.42	20.0	6.99	23.3	8.13	23.5	8.54	23.8	8.56	24.5	8.59	25.2	8.67	
48	14.9	4.68	17.7	6.05	20.1	6.95	20.4	7.24	20.7	7.27	21.3	7.28	21.9	7.34	
90	10	17.0	1.97	20.3	2.36	23.6	2.79	25.2	3.00	26.8	3.23	30.1	3.62	33.4	3.97
	12	17.0	1.99	20.3	2.40	23.6	2.84	25.2	3.06	26.8	3.31	30.1	3.69	33.4	4.10
	14	17.0	2.03	20.3	2.45	23.6	2.90	25.2	3.12	26.8	3.37	30.1	3.76	33.4	4.18
	16	17.0	2.06	20.3	2.50	23.6	2.96	25.2	3.19	26.8	3.43	30.1	3.83	33.4	4.25
	18	17.0	2.10	20.3	2.55	23.6	3.00	25.2	3.26	26.8	3.50	30.1	3.92	33.4	4.46
	20	17.0	2.14	20.3	2.59	23.6	3.06	25.2	3.32	26.8	3.63	30.1	4.19	33.4	4.68
	21	17.0	2.16	20.3	2.62	23.6	3.12	25.2	3.43	26.8	3.76	30.1	4.26	33.4	4.78
	23	17.0	2.21	20.3	2.73	23.6	3.34	25.2	3.68	26.8	4.03	30.1	4.52	32.9	5.01
	25	17.0	2.32	20.3	2.91	23.6	3.57	25.2	3.93	26.8	4.31	30.1	4.83	32.5	5.22
	27	17.0	2.47	20.3	3.10	23.6	3.81	25.2	4.20	26.8	4.61	30.1	5.14	32.0	5.47
	29	17.0	2.62	20.3	3.31	23.6	4.08	25.2	4.49	26.8	4.92	30.1	5.44	31.5	5.69
	31	17.0	2.79	20.3	3.52	23.6	4.34	25.2	4.78	26.8	5.25	30.1	5.71	31.0	5.91
	33	17.0	2.97	20.3	3.75	23.6	4.63	25.2	5.09	26.8	5.57	30.1	5.99	30.6	6.13
	35	17.0	3.15	20.3	3.98	23.6	4.92	25.2	5.43	26.8	5.90	29.6	6.33	30.1	6.48
	37	17.0	3.34	20.3	4.23	23.6	5.25	25.2	5.77	26.8	6.23	29.1	6.62	29.6	6.77
	39	17.0	3.54	20.3	4.50	23.6	5.56	25.2	6.14	26.8	6.55	28.6	6.98	29.1	7.06
	41	16.6	3.96	19.8	4.99	23.0	6.10	24.6	6.71	26.1	7.07	27.4	7.36	27.9	7.52
43	16.2	4.27	19.3	5.40	22.4	6.66	23.9	7.23	25.5	7.59	26.3	7.88	26.8	7.97	
46	15.1	4.81	18.1	6.15	21.0	7.59	22.4	8.20	23.1	8.43	24.0	8.59	24.5	8.66	
48	13.4	4.20	16.0	5.38	18.6	6.64	19.9	7.15	20.1	7.26	20.9	7.28	21.3	7.34	
80	10	15.1	1.83	18.0	2.20	20.9	2.58	22.4	2.79	23.9	2.99	26.8	3.41	29.7	3.70
	12	15.1	1.87	18.0	2.23	20.9	2.63	22.4	2.84	23.9	3.04	26.8	3.47	29.7	3.78
	14	15.1	1.90	18.0	2.28	20.9	2.67	22.4	2.89	23.9	3.09	26.8	3.54	29.7	3.85
	16	15.1	1.92	18.0	2.32	20.9	2.72	22.4	2.94	23.9	3.16	26.8	3.61	29.7	3.92
	18	15.1	1.96	18.0	2.35	20.9	2.77	22.4	2.99	23.9	3.22	26.8	3.68	29.7	4.01
	20	15.1	2.00	18.0	2.41	20.9	2.84	22.4	3.05	23.9	3.28	26.8	3.82	29.7	4.25
	21	15.1	2.01	18.0	2.43	20.9	2.86	22.4	3.09	23.9	3.36	26.8	3.94	29.7	4.36
	23	15.1	2.05	18.0	2.47	20.9	2.99	22.4	3.28	23.9	3.59	26.8	4.16	29.7	4.58
	25	15.1	2.13	18.0	2.63	20.9	3.21	22.4	3.51	23.9	3.84	26.8	4.45	29.7	4.89
	27	15.1	2.25	18.0	2.80	20.9	3.42	22.4	3.75	23.9	4.10	26.8	4.73	29.7	5.15
	29	15.1	2.39	18.0	2.99	20.9	3.64	22.4	4.00	23.9	4.38	26.8	5.07	29.7	5.41
	31	15.1	2.55	18.0	3.17	20.9	3.88	22.4	4.26	23.9	4.66	26.8	5.38	29.7	5.67
	33	15.1	2.70	18.0	3.39	20.9	4.14	22.4	4.54	23.9	4.96	26.8	5.66	29.7	5.95
	35	15.1	2.86	18.0	3.59	20.9	4.40	22.4	4.84	23.9	5.29	26.8	6.01	29.4	6.28
	37	15.1	3.03	18.0	3.82	20.9	4.67	22.4	5.14	23.9	5.63	26.8	6.34	28.9	6.57
	39	15.1	3.20	18.0	4.03	20.9	5.00	22.4	5.53	23.9	6.05	26.8	6.70	28.4	6.93
	41	14.7	3.54	17.5	4.47	20.4	5.48	21.8	6.06	23.3	6.64	26.1	7.21	27.2	7.37
43	14.3	3.90	17.1	4.88	19.9	5.99	21.3	6.60	22.7	7.26	25.5	7.72	26.1	7.89	
46	13.4	4.34	16.0	5.49	18.6	6.74	19.9	7.35	21.3	8.19	23.3	8.59	23.8	8.66	
48	11.9	3.79	14.2	4.80	16.5	5.90	17.6	6.42	18.8	7.17	20.2	7.28	20.7	7.34	



# 7. Capacity Tables

Cooling Capacity (10HP)

Combination (%)	Outdoor air temp. (DB, °C)	Indoor air temp. (DB/WB, °C)													
		20		23		26		27		28		30		32	
		14		16		18		19		20		22		24	
		TC	PI	TC	PI	TC	PI	TC	PI	TC	PI	TC	PI	TC	PI
70	10	13.2	1.62	15.8	1.93	18.3	2.23	19.6	2.41	20.9	2.58	23.4	2.93	26.0	3.28
	12	13.2	1.65	15.8	1.95	18.3	2.28	19.6	2.45	20.9	2.63	23.4	2.98	26.0	3.34
	14	13.2	1.67	15.8	1.98	18.3	2.32	19.6	2.49	20.9	2.67	23.4	3.05	26.0	3.40
	16	13.2	1.70	15.8	2.01	18.3	2.36	19.6	2.54	20.9	2.72	23.4	3.10	26.0	3.48
	18	13.2	1.72	15.8	2.05	18.3	2.41	19.6	2.59	20.9	2.77	23.4	3.15	26.0	3.54
	20	13.2	1.75	15.8	2.09	18.3	2.45	19.6	2.64	20.9	2.83	23.4	3.23	26.0	3.67
	21	13.2	1.77	15.8	2.10	18.3	2.47	19.6	2.67	20.9	2.86	23.4	3.28	26.0	3.75
	23	13.2	1.80	15.8	2.16	18.3	2.52	19.6	2.75	20.9	3.00	23.4	3.51	26.0	3.96
	25	13.2	1.82	15.8	2.23	18.3	2.69	19.6	2.95	20.9	3.20	23.4	3.75	26.0	4.15
	27	13.2	1.93	15.8	2.38	18.3	2.87	19.6	3.12	20.9	3.42	23.4	4.00	26.0	4.41
	29	13.2	2.05	15.8	2.52	18.3	3.05	19.6	3.33	20.9	3.63	23.4	4.27	26.0	4.73
	31	13.2	2.18	15.8	2.69	18.3	3.25	19.6	3.56	20.9	3.88	23.4	4.55	26.0	5.02
	33	13.2	2.31	15.8	2.84	18.3	3.46	19.6	3.77	20.9	4.12	23.4	4.85	26.0	5.34
	35	13.2	2.44	15.8	3.04	18.3	3.67	19.6	4.02	20.9	4.39	23.4	5.16	26.0	5.66
	37	13.2	2.59	15.8	3.22	18.3	3.90	19.6	4.27	20.9	4.67	23.4	5.50	26.0	5.98
	39	13.2	2.75	15.8	3.43	18.3	4.17	19.6	4.60	20.9	5.04	23.4	5.88	26.0	6.44
	41	12.9	3.04	15.4	3.76	17.8	4.58	19.1	5.04	20.4	5.48	22.8	6.46	25.3	6.95
43	12.5	3.31	15.0	4.09	17.4	4.99	18.6	5.50	19.9	5.99	22.2	7.06	24.7	7.51	
46	11.8	3.68	14.1	4.60	16.3	5.62	17.5	6.12	18.6	6.75	20.8	7.96	23.2	8.38	
48	10.4	3.21	12.4	4.02	14.4	4.92	15.4	5.35	16.5	5.90	18.4	6.97	20.5	7.25	
60	10	11.3	1.41	13.5	1.65	15.7	1.92	16.8	2.06	17.9	2.19	20.1	2.48	22.3	2.77
	12	11.3	1.43	13.5	1.67	15.7	1.94	16.8	2.08	17.9	2.22	20.1	2.52	22.3	2.82
	14	11.3	1.44	13.5	1.70	15.7	1.98	16.8	2.12	17.9	2.26	20.1	2.57	22.3	2.88
	16	11.3	1.47	13.5	1.74	15.7	2.01	16.8	2.16	17.9	2.31	20.1	2.62	22.3	2.93
	18	11.3	1.50	13.5	1.76	15.7	2.04	16.8	2.20	17.9	2.35	20.1	2.66	22.3	2.99
	20	11.3	1.52	13.5	1.79	15.7	2.08	16.8	2.24	17.9	2.39	20.1	2.71	22.3	3.05
	21	11.3	1.53	13.5	1.80	15.7	2.11	16.8	2.26	17.9	2.42	20.1	2.75	22.3	3.08
	23	11.3	1.56	13.5	1.84	15.7	2.13	16.8	2.30	17.9	2.47	20.1	2.85	22.3	3.27
	25	11.3	1.58	13.5	1.88	15.7	2.22	16.8	2.42	17.9	2.62	20.1	3.04	22.3	3.50
	27	11.3	1.64	13.5	1.98	15.7	2.36	16.8	2.57	17.9	2.79	20.1	3.23	22.3	3.73
	29	11.3	1.74	13.5	2.11	15.7	2.52	16.8	2.73	17.9	2.96	20.1	3.45	22.3	3.99
	31	11.3	1.84	13.5	2.24	15.7	2.67	16.8	2.91	17.9	3.16	20.1	3.68	22.3	4.24
	33	11.3	1.94	13.5	2.36	15.7	2.84	16.8	3.09	17.9	3.36	20.1	3.91	22.3	4.52
	35	11.3	2.06	13.5	2.52	15.7	3.02	16.8	3.28	17.9	3.57	20.1	4.17	22.3	4.80
	37	11.3	2.17	13.5	2.66	15.7	3.19	16.8	3.49	17.9	3.78	20.1	4.42	22.3	5.11
	39	11.3	2.31	13.5	2.83	15.7	3.45	16.8	3.74	17.9	4.07	20.1	4.74	22.3	5.48
	41	11.0	2.51	13.2	3.10	15.3	3.74	16.4	4.09	17.4	4.42	19.6	5.20	21.7	5.95
43	10.7	2.72	12.8	3.37	14.9	4.08	16.0	4.46	17.0	4.82	19.1	5.68	21.2	6.50	
46	10.1	3.05	12.0	3.78	14.0	4.59	15.0	5.01	15.9	5.42	17.9	6.40	19.9	7.41	
48	8.9	2.66	10.6	3.30	12.4	4.01	13.2	4.37	14.1	4.74	15.8	5.60	17.6	6.48	
50	10	9.5	1.22	11.3	1.41	13.1	1.60	14.0	1.72	14.9	1.82	16.7	2.05	18.6	2.28
	12	9.5	1.23	11.3	1.42	13.1	1.63	14.0	1.74	14.9	1.86	16.7	2.09	18.6	2.32
	14	9.5	1.24	11.3	1.45	13.1	1.65	14.0	1.77	14.9	1.88	16.7	2.11	18.6	2.36
	16	9.5	1.27	11.3	1.47	13.1	1.68	14.0	1.81	14.9	1.91	16.7	2.15	18.6	2.39
	18	9.5	1.28	11.3	1.49	13.1	1.70	14.0	1.83	14.9	1.95	16.7	2.19	18.6	2.45
	20	9.5	1.29	11.3	1.51	13.1	1.74	14.0	1.86	14.9	1.98	16.7	2.23	18.6	2.50
	21	9.5	1.31	11.3	1.52	13.1	1.75	14.0	1.88	14.9	2.00	16.7	2.25	18.6	2.52
	23	9.5	1.33	11.3	1.55	13.1	1.78	14.0	1.91	14.9	2.04	16.7	2.29	18.6	2.57
	25	9.5	1.34	11.3	1.57	13.1	1.82	14.0	1.95	14.9	2.10	16.7	2.41	18.6	2.75
	27	9.5	1.37	11.3	1.63	13.1	1.92	14.0	2.07	14.9	2.23	16.7	2.57	18.6	2.93
	29	9.5	1.45	11.3	1.73	13.1	2.04	14.0	2.20	14.9	2.37	16.7	2.73	18.6	3.11
	31	9.5	1.52	11.3	1.83	13.1	2.16	14.0	2.33	14.9	2.52	16.7	2.91	18.6	3.32
	33	9.5	1.61	11.3	1.93	13.1	2.29	14.0	2.47	14.9	2.68	16.7	3.09	18.6	3.53
	35	9.5	1.70	11.3	2.05	13.1	2.42	14.0	2.62	14.9	2.83	16.7	3.27	18.6	3.75
	37	9.5	1.81	11.3	2.16	13.1	2.56	14.0	2.78	14.9	3.00	16.7	3.48	18.6	3.98
	39	9.5	1.93	11.3	2.32	13.1	2.74	14.0	2.99	14.9	3.22	16.7	3.71	18.6	4.30
	41	9.2	2.08	11.0	2.51	12.8	3.00	13.6	3.24	14.5	3.48	16.3	4.07	18.1	4.67
43	9.0	2.26	10.7	2.73	12.4	3.26	13.3	3.53	14.2	3.79	15.9	4.43	17.7	5.10	
46	8.4	2.53	10.1	3.06	11.7	3.66	12.5	3.96	13.3	4.26	14.9	4.99	16.6	5.74	
48	7.4	2.21	8.9	2.67	10.3	3.19	11.0	3.46	11.7	3.72	13.2	4.36	14.7	5.01	

**Note**

1. TC: Total Capacity(kW), PI : Power Input(kW, Comp. + Outdoor fan motor)
2. Capacity tables show the average value of conditions which may occur.

# 7. Capacity Tables

## ◆ ARUM120LTE5

Cooling Capacity (12HP)

Combination (%)	Outdoor air temp. (DB, °C)	Indoor air temp. (DB/WB, °C)													
		20		23		26		27		28		30		32	
		14	16	16	18	18	19	19	20	20	22	22	24	24	
		TC	PI	TC	PI	TC	PI	TC	PI	TC	PI	TC	PI	TC	PI
130	10	33.3	3.27	39.6	4.00	42.5	4.64	43.7	4.73	44.9	4.77	47.1	4.81	48.3	4.83
	12	33.3	3.35	39.6	4.14	42.5	4.83	43.7	4.86	44.9	4.90	47.1	4.94	48.3	4.98
	14	33.3	3.46	39.6	4.29	42.5	5.01	43.7	5.05	44.9	5.09	47.1	5.13	48.3	5.17
	16	33.3	3.59	39.6	4.44	42.5	5.23	43.7	5.28	44.9	5.32	47.1	5.37	48.3	5.41
	18	33.3	3.74	39.6	4.70	42.5	5.47	43.7	5.59	44.9	5.64	47.1	5.69	48.3	5.73
	20	33.3	3.91	39.6	5.00	42.5	5.74	43.7	6.15	44.9	6.20	46.4	6.26	47.6	6.30
	21	33.3	4.01	39.6	5.18	42.5	5.86	43.7	6.51	44.9	6.56	46.1	6.63	47.4	6.67
	23	33.3	4.30	39.6	5.45	42.5	6.17	43.7	7.18	44.3	7.24	45.5	7.31	46.7	7.36
	25	33.3	4.59	39.6	5.76	42.5	6.59	43.2	7.97	43.7	8.03	44.9	8.11	46.1	8.16
	27	33.3	4.92	39.6	6.16	41.9	7.02	42.5	8.77	43.2	8.84	44.3	8.93	45.5	8.99
	29	33.3	5.24	39.6	6.58	41.3	7.56	41.9	9.64	42.5	9.70	43.7	9.78	44.9	9.82
	31	33.3	5.59	39.5	6.94	40.6	8.04	41.3	9.60	41.9	9.65	43.0	9.74	44.2	9.78
	33	33.3	5.95	38.8	7.35	40.0	8.62	40.7	9.51	41.3	9.57	42.5	9.65	43.5	9.69
	35	33.3	6.35	38.1	7.70	39.4	9.34	40.0	9.39	40.7	9.44	41.8	9.53	43.0	9.56
	37	33.3	6.77	37.6	8.08	38.8	9.22	39.4	9.26	40.0	9.32	41.1	9.40	42.3	9.44
	39	33.3	7.21	36.9	8.50	38.1	9.09	38.8	9.14	39.4	9.19	40.6	9.27	41.8	9.31
	41	32.4	7.65	35.4	8.93	36.6	8.97	37.1	9.01	37.9	9.07	39.0	9.15	40.1	9.18
	43	31.6	8.07	33.9	8.80	35.1	8.85	35.6	8.89	36.4	8.94	37.5	9.02	38.5	9.06
46	29.6	8.63	30.9	8.62	32.1	8.66	32.6	8.70	33.3	8.76	34.3	8.83	35.2	8.87	
48	26.2	8.39	26.9	8.42	27.9	8.44	28.3	8.46	28.9	8.53	29.9	8.59	30.7	8.62	
120	10	30.1	2.94	35.8	3.61	39.1	4.29	40.3	4.63	41.5	4.71	43.8	4.73	44.8	4.76
	12	30.1	3.02	35.8	3.73	39.1	4.46	40.3	4.73	41.5	4.88	43.8	4.94	44.8	4.98
	14	30.1	3.13	35.8	3.86	39.1	4.64	40.3	4.91	41.5	5.06	43.8	5.13	44.8	5.18
	16	30.1	3.24	35.8	4.01	39.1	4.82	40.3	5.09	41.5	5.29	43.8	5.36	44.8	5.40
	18	30.1	3.37	35.8	4.19	39.1	5.01	40.3	5.36	41.5	5.57	43.8	5.63	44.8	5.67
	20	30.1	3.49	35.8	4.45	39.1	5.28	40.3	5.64	41.5	5.86	43.8	5.94	44.8	5.98
	21	30.1	3.60	35.8	4.61	39.1	5.43	40.3	5.81	41.5	6.05	43.8	6.13	44.8	6.18
	23	30.1	3.85	35.8	4.93	39.1	5.82	40.3	6.17	41.5	6.45	43.8	6.52	44.8	6.57
	25	30.1	4.11	35.8	5.28	39.1	6.14	40.3	6.58	41.5	6.92	43.2	6.98	44.3	7.03
	27	30.1	4.39	35.8	5.65	39.1	6.53	40.3	7.03	41.5	7.44	42.6	7.49	43.6	7.55
	29	30.1	4.68	35.8	6.03	39.1	6.87	40.3	7.52	40.8	7.93	41.9	8.04	43.1	8.11
	31	30.1	4.99	35.8	6.44	39.1	7.23	39.8	8.06	40.3	8.50	41.4	8.65	42.4	8.72
	33	30.1	5.31	35.8	6.86	38.6	7.64	39.1	8.75	39.7	9.13	40.7	9.23	41.8	9.31
	35	30.1	5.65	35.8	7.31	37.9	8.09	38.5	9.64	39.1	9.69	40.2	9.71	41.2	9.79
	37	30.1	6.07	35.8	7.72	37.4	8.63	37.9	9.43	38.5	9.48	39.5	9.51	40.6	9.59
	39	30.1	6.54	35.7	8.16	36.7	9.15	37.3	9.24	37.8	9.29	39.0	9.31	40.1	9.39
	41	29.3	7.00	34.1	8.60	35.3	8.97	35.8	9.05	36.3	9.09	37.3	9.12	38.4	9.19
	43	28.6	7.48	32.7	8.47	33.8	8.77	34.3	8.85	34.8	8.90	35.8	8.92	36.9	9.00
46	26.8	8.04	29.8	8.27	30.9	8.49	31.3	8.56	31.8	8.61	32.8	8.63	33.8	8.70	
48	23.7	7.87	25.9	8.13	26.8	8.33	27.3	8.38	27.7	8.40	28.5	8.44	29.4	8.47	
110	10	27.0	2.65	32.2	3.23	35.9	3.83	37.0	4.15	39.3	4.46	40.2	4.59	42.9	4.66
	12	27.0	2.73	32.2	3.33	35.9	3.99	37.0	4.26	39.3	4.63	40.2	4.78	42.9	4.89
	14	27.0	2.81	32.2	3.48	35.9	4.17	37.0	4.48	39.3	4.86	40.2	5.00	42.9	5.11
	16	27.0	2.91	32.2	3.61	35.9	4.34	37.0	4.67	39.3	5.09	40.2	5.23	42.9	5.32
	18	27.0	3.02	32.2	3.76	35.9	4.59	37.0	4.92	39.3	5.37	40.2	5.47	42.9	5.58
	20	27.0	3.13	32.2	3.95	35.9	4.87	37.0	5.14	39.3	5.63	40.2	5.77	42.9	5.86
	21	27.0	3.20	32.2	4.07	35.9	5.00	37.0	5.28	39.3	5.78	40.2	5.93	42.9	6.02
	23	27.0	3.41	32.2	4.36	35.9	5.28	37.0	5.58	39.3	6.11	40.2	6.24	42.9	6.35
	25	27.0	3.64	32.2	4.65	35.9	5.57	37.0	5.90	39.3	6.46	40.2	6.55	42.4	6.68
	27	27.0	3.89	32.2	4.97	35.9	5.89	37.0	6.24	39.3	6.74	40.2	6.90	41.8	7.02
	29	27.0	4.15	32.2	5.31	35.9	6.22	37.0	6.61	39.3	7.13	40.2	7.25	41.2	7.36
	31	27.0	4.42	32.2	5.66	35.9	6.58	37.0	7.00	38.7	7.49	39.7	7.64	40.6	7.72
	33	27.0	4.71	32.2	6.03	35.9	6.95	37.0	7.42	38.1	7.91	39.0	8.04	40.1	8.08
	35	27.0	5.00	32.2	6.44	35.9	7.34	37.0	7.86	37.5	8.35	38.4	8.42	39.4	8.46
	37	27.0	5.30	32.2	6.83	35.9	7.75	36.4	8.33	36.8	8.80	37.9	8.83	38.8	8.86
	39	27.0	5.72	32.2	7.26	35.3	8.17	35.8	8.91	36.3	9.24	37.2	9.25	38.3	9.26
	41	26.3	6.13	31.3	7.69	33.8	8.62	34.3	9.64	34.7	9.64	35.8	9.71	36.6	9.79
	43	25.6	6.44	30.6	8.01	32.4	9.14	32.9	9.24	33.3	9.22	34.3	9.28	35.2	9.30
46	24.0	6.28	28.6	7.73	29.5	8.68	30.0	8.68	30.4	8.75	31.4	8.80	32.2	8.82	
48	21.3	6.10	24.9	7.45	25.6	8.25	26.1	8.31	26.5	8.35	27.3	8.37	28.0	8.41	

# 7. Capacity Tables

Cooling Capacity (12HP)

Combination (%)	Outdoor air temp. (DB, °C)	Indoor air temp. (DB/WB, °C)													
		20		23		26		27		28		30		32	
		14		16		18		19		20		22		24	
		TC	PI	TC	PI	TC	PI	TC	PI	TC	PI	TC	PI	TC	PI
100	10	22.7	2.38	27.0	2.90	31.4	3.44	33.6	3.71	35.8	3.99	39.6	4.44	40.5	4.48
	12	22.7	2.46	27.0	3.01	31.4	3.55	33.6	3.81	35.8	4.12	39.6	4.68	40.5	4.73
	14	22.7	2.54	27.0	3.14	31.4	3.70	33.6	3.98	35.8	4.29	39.6	4.94	40.5	4.99
	16	22.7	2.61	27.0	3.24	31.4	3.86	33.6	4.17	35.8	4.53	39.6	5.18	40.5	5.25
	18	22.7	2.69	27.0	3.36	31.4	4.01	33.6	4.37	35.8	4.80	39.6	5.47	40.5	5.52
	20	22.7	2.79	27.0	3.49	31.4	4.24	33.6	4.68	35.8	5.14	39.6	5.74	40.5	5.78
	21	22.7	2.84	27.0	3.57	31.4	4.39	33.6	4.84	35.8	5.33	39.6	5.87	40.5	5.91
	23	22.7	3.01	27.0	3.82	31.4	4.71	33.6	5.19	35.8	5.71	39.6	6.14	40.5	6.19
	25	22.7	3.20	27.0	4.07	31.4	5.03	33.6	5.56	35.8	6.10	39.6	6.41	40.2	6.46
	27	22.7	3.42	27.0	4.35	31.4	5.38	33.6	5.94	35.8	6.49	38.9	6.71	39.7	6.76
	29	22.7	3.64	27.0	4.64	31.4	5.75	33.6	6.35	35.8	6.86	38.2	6.98	39.1	7.03
	31	22.7	3.89	27.0	4.94	31.4	6.13	33.6	6.77	35.8	7.21	37.6	7.25	38.5	7.30
	33	22.7	4.13	27.0	5.27	31.4	6.54	33.6	7.23	35.8	7.48	37.0	7.52	37.9	7.58
	35	22.7	4.39	27.0	5.60	31.4	6.96	33.6	7.71	35.2	7.76	36.3	7.79	37.2	7.85
	37	22.7	4.70	27.0	6.01	31.4	7.38	33.6	8.08	34.6	8.12	35.6	8.15	36.5	8.22
	39	22.7	5.04	27.0	6.46	31.4	7.82	33.6	8.47	34.1	8.51	35.1	8.54	35.9	8.62
	41	22.3	5.38	26.6	6.90	30.9	8.26	32.2	8.87	32.9	8.90	33.7	8.93	34.8	9.02
43	21.6	5.69	25.7	7.32	29.9	8.65	30.9	9.21	31.3	9.24	32.2	9.27	33.1	9.36	
46	20.2	6.12	24.0	7.89	28.0	9.18	28.2	9.64	28.5	9.67	29.4	9.69	30.2	9.79	
48	17.9	5.29	21.3	6.82	24.2	7.85	24.5	8.18	24.8	8.20	25.6	8.22	26.3	8.29	
90	10	20.4	2.22	24.4	2.67	28.3	3.15	30.2	3.39	32.2	3.65	36.1	4.09	40.1	4.48
	12	20.4	2.25	24.4	2.71	28.3	3.20	30.2	3.46	32.2	3.73	36.1	4.17	40.1	4.62
	14	20.4	2.29	24.4	2.76	28.3	3.27	30.2	3.53	32.2	3.80	36.1	4.25	40.1	4.72
	16	20.4	2.33	24.4	2.82	28.3	3.34	30.2	3.60	32.2	3.87	36.1	4.33	40.1	4.80
	18	20.4	2.37	24.4	2.87	28.3	3.39	30.2	3.68	32.2	3.95	36.1	4.42	40.1	5.04
	20	20.4	2.41	24.4	2.93	28.3	3.46	30.2	3.75	32.2	4.10	36.1	4.73	40.1	5.28
	21	20.4	2.44	24.4	2.96	28.3	3.53	30.2	3.87	32.2	4.25	36.1	4.81	40.1	5.40
	23	20.4	2.49	24.4	3.08	28.3	3.77	30.2	4.15	32.2	4.55	36.1	5.10	39.5	5.66
	25	20.4	2.62	24.4	3.28	28.3	4.03	30.2	4.44	32.2	4.86	36.1	5.45	39.0	5.90
	27	20.4	2.79	24.4	3.50	28.3	4.30	30.2	4.74	32.2	5.20	36.1	5.80	38.4	6.17
	29	20.4	2.96	24.4	3.73	28.3	4.60	30.2	5.07	32.2	5.56	36.1	6.14	37.8	6.42
	31	20.4	3.15	24.4	3.98	28.3	4.90	30.2	5.39	32.2	5.92	36.1	6.45	37.2	6.67
	33	20.4	3.35	24.4	4.24	28.3	5.23	30.2	5.75	32.2	6.28	36.1	6.76	36.7	6.92
	35	20.4	3.55	24.4	4.49	28.3	5.56	30.2	6.13	32.2	6.66	35.5	7.15	36.1	7.31
	37	20.4	3.77	24.4	4.78	28.3	5.93	30.2	6.51	32.2	7.03	34.9	7.47	35.5	7.64
	39	20.4	3.99	24.4	5.08	28.3	6.27	30.2	6.93	32.2	7.40	34.4	7.88	35.0	7.97
	41	19.9	4.47	23.7	5.64	27.6	6.88	29.5	7.58	31.3	7.99	32.9	8.30	33.5	8.49
43	19.4	4.82	23.1	6.09	26.9	7.52	28.7	8.16	30.6	8.56	31.6	8.89	32.1	9.00	
46	18.2	5.43	21.7	6.94	25.2	8.57	26.9	9.25	27.8	9.51	28.8	9.69	29.4	9.77	
48	16.1	4.75	19.2	6.07	22.3	7.50	23.8	8.07	24.1	8.20	25.0	8.22	25.5	8.29	
80	10	18.1	2.07	21.6	2.49	25.1	2.92	26.9	3.15	28.7	3.38	32.2	3.85	35.6	4.18
	12	18.1	2.11	21.6	2.51	25.1	2.97	26.9	3.20	28.7	3.43	32.2	3.92	35.6	4.26
	14	18.1	2.14	21.6	2.57	25.1	3.02	26.9	3.26	28.7	3.49	32.2	3.99	35.6	4.35
	16	18.1	2.17	21.6	2.61	25.1	3.07	26.9	3.32	28.7	3.56	32.2	4.08	35.6	4.43
	18	18.1	2.21	21.6	2.66	25.1	3.13	26.9	3.38	28.7	3.63	32.2	4.15	35.6	4.53
	20	18.1	2.26	21.6	2.72	25.1	3.20	26.9	3.45	28.7	3.71	32.2	4.31	35.6	4.79
	21	18.1	2.27	21.6	2.74	25.1	3.23	26.9	3.49	28.7	3.79	32.2	4.45	35.6	4.92
	23	18.1	2.31	21.6	2.79	25.1	3.38	26.9	3.71	28.7	4.05	32.2	4.69	35.6	5.17
	25	18.1	2.40	21.6	2.97	25.1	3.62	26.9	3.97	28.7	4.34	32.2	5.02	35.6	5.52
	27	18.1	2.54	21.6	3.16	25.1	3.86	26.9	4.24	28.7	4.63	32.2	5.34	35.6	5.81
	29	18.1	2.70	21.6	3.38	25.1	4.11	26.9	4.51	28.7	4.94	32.2	5.72	35.6	6.10
	31	18.1	2.87	21.6	3.58	25.1	4.38	26.9	4.81	28.7	5.26	32.2	6.07	35.6	6.41
	33	18.1	3.05	21.6	3.82	25.1	4.67	26.9	5.13	28.7	5.60	32.2	6.39	35.6	6.71
	35	18.1	3.23	21.6	4.05	25.1	4.97	26.9	5.46	28.7	5.98	32.2	6.78	35.3	7.09
	37	18.1	3.42	21.6	4.31	25.1	5.27	26.9	5.80	28.7	6.35	32.2	7.16	34.7	7.42
	39	18.1	3.61	21.6	4.55	25.1	5.64	26.9	6.24	28.7	6.82	32.2	7.56	34.1	7.83
	41	17.7	4.00	21.0	5.05	24.4	6.19	26.2	6.84	27.9	7.50	31.3	8.14	32.7	8.32
43	17.2	4.40	20.5	5.51	23.8	6.76	25.5	7.45	27.3	8.19	30.6	8.71	31.3	8.91	
46	16.1	4.90	19.2	6.20	22.3	7.61	23.9	8.30	25.5	9.25	27.9	9.69	28.6	9.77	
48	14.3	4.28	17.0	5.42	19.8	6.66	21.2	7.25	22.6	8.09	24.3	8.22	24.9	8.29	

# 7. Capacity Tables

Cooling Capacity (12HP)

Combination (%)	Outdoor air temp. (DB, °C)	Indoor air temp. (DB/WB, °C)													
		20		23		26		27		28		30		32	
		14		16		18		19		20		22		24	
		TC	PI	TC	PI	TC	PI	TC	PI	TC	PI	TC	PI	TC	PI
70	10	15.8	1.83	19.0	2.17	22.0	2.52	23.5	2.72	25.1	2.91	28.1	3.31	31.2	3.70
	12	15.8	1.86	19.0	2.20	22.0	2.58	23.5	2.76	25.1	2.97	28.1	3.37	31.2	3.77
	14	15.8	1.89	19.0	2.23	22.0	2.62	23.5	2.81	25.1	3.01	28.1	3.44	31.2	3.84
	16	15.8	1.91	19.0	2.27	22.0	2.66	23.5	2.86	25.1	3.07	28.1	3.50	31.2	3.92
	18	15.8	1.94	19.0	2.32	22.0	2.72	23.5	2.92	25.1	3.12	28.1	3.56	31.2	3.99
	20	15.8	1.97	19.0	2.36	22.0	2.76	23.5	2.98	25.1	3.20	28.1	3.64	31.2	4.15
	21	15.8	2.00	19.0	2.38	22.0	2.79	23.5	3.01	25.1	3.22	28.1	3.70	31.2	4.23
	23	15.8	2.03	19.0	2.43	22.0	2.85	23.5	3.11	25.1	3.38	28.1	3.96	31.2	4.47
	25	15.8	2.06	19.0	2.52	22.0	3.04	23.5	3.33	25.1	3.61	28.1	4.23	31.2	4.69
	27	15.8	2.17	19.0	2.69	22.0	3.24	23.5	3.53	25.1	3.86	28.1	4.52	31.2	4.98
	29	15.8	2.32	19.0	2.85	22.0	3.44	23.5	3.76	25.1	4.10	28.1	4.82	31.2	5.34
	31	15.8	2.46	19.0	3.04	22.0	3.67	23.5	4.02	25.1	4.38	28.1	5.14	31.2	5.66
	33	15.8	2.61	19.0	3.21	22.0	3.90	23.5	4.26	25.1	4.65	28.1	5.47	31.2	6.03
	35	15.8	2.75	19.0	3.43	22.0	4.15	23.5	4.53	25.1	4.95	28.1	5.83	31.2	6.39
	37	15.8	2.92	19.0	3.63	22.0	4.41	23.5	4.82	25.1	5.27	28.1	6.20	31.2	6.75
	39	15.8	3.10	19.0	3.87	22.0	4.71	23.5	5.19	25.1	5.69	28.1	6.64	31.2	7.27
	41	15.4	3.43	18.5	4.24	21.4	5.17	22.9	5.69	24.4	6.19	27.4	7.29	30.4	7.85
43	15.1	3.73	18.0	4.62	20.9	5.64	22.4	6.21	23.8	6.76	26.7	7.97	29.6	8.48	
46	14.1	4.15	16.9	5.19	19.6	6.35	20.9	6.91	22.3	7.62	25.0	8.99	27.8	9.45	
48	12.5	3.62	14.9	4.54	17.3	5.55	18.5	6.04	19.8	6.66	22.1	7.86	24.6	8.18	
60	10	13.6	1.59	16.2	1.86	18.8	2.16	20.2	2.32	21.5	2.47	24.1	2.80	26.8	3.13
	12	13.6	1.62	16.2	1.89	18.8	2.19	20.2	2.35	21.5	2.51	24.1	2.84	26.8	3.19
	14	13.6	1.63	16.2	1.92	18.8	2.24	20.2	2.39	21.5	2.55	24.1	2.90	26.8	3.25
	16	13.6	1.66	16.2	1.96	18.8	2.26	20.2	2.44	21.5	2.61	24.1	2.96	26.8	3.30
	18	13.6	1.69	16.2	1.99	18.8	2.31	20.2	2.48	21.5	2.65	24.1	3.00	26.8	3.38
	20	13.6	1.72	16.2	2.02	18.8	2.35	20.2	2.52	21.5	2.70	24.1	3.06	26.8	3.45
	21	13.6	1.73	16.2	2.03	18.8	2.38	20.2	2.55	21.5	2.73	24.1	3.10	26.8	3.48
	23	13.6	1.76	16.2	2.08	18.8	2.41	20.2	2.60	21.5	2.78	24.1	3.22	26.8	3.69
	25	13.6	1.79	16.2	2.12	18.8	2.51	20.2	2.73	21.5	2.96	24.1	3.43	26.8	3.95
	27	13.6	1.85	16.2	2.24	18.8	2.67	20.2	2.90	21.5	3.14	24.1	3.65	26.8	4.21
	29	13.6	1.96	16.2	2.38	18.8	2.84	20.2	3.09	21.5	3.35	24.1	3.89	26.8	4.50
	31	13.6	2.08	16.2	2.52	18.8	3.01	20.2	3.29	21.5	3.56	24.1	4.15	26.8	4.79
	33	13.6	2.19	16.2	2.67	18.8	3.20	20.2	3.49	21.5	3.79	24.1	4.41	26.8	5.11
	35	13.6	2.32	16.2	2.84	18.8	3.40	20.2	3.71	21.5	4.02	24.1	4.70	26.8	5.42
	37	13.6	2.45	16.2	3.00	18.8	3.61	20.2	3.94	21.5	4.27	24.1	4.99	26.8	5.77
	39	13.6	2.61	16.2	3.19	18.8	3.89	20.2	4.23	21.5	4.59	24.1	5.35	26.8	6.18
	41	13.2	2.83	15.8	3.49	18.4	4.23	19.6	4.62	20.9	4.99	23.5	5.87	26.1	6.72
43	12.9	3.07	15.4	3.80	17.9	4.61	19.2	5.03	20.4	5.44	22.9	6.41	25.4	7.34	
46	12.1	3.44	14.4	4.27	16.8	5.18	18.0	5.65	19.1	6.12	21.5	7.22	23.8	8.36	
48	10.7	3.00	12.8	3.73	14.8	4.53	15.9	4.94	16.9	5.35	19.0	6.32	21.1	7.32	
50	10	11.3	1.37	13.6	1.59	15.7	1.81	16.8	1.94	17.9	2.05	20.0	2.31	22.3	2.57
	12	11.3	1.39	13.6	1.60	15.7	1.84	16.8	1.97	17.9	2.10	20.0	2.36	22.3	2.62
	14	11.3	1.40	13.6	1.63	15.7	1.86	16.8	1.99	17.9	2.12	20.0	2.38	22.3	2.66
	16	11.3	1.43	13.6	1.66	15.7	1.89	16.8	2.04	17.9	2.15	20.0	2.43	22.3	2.70
	18	11.3	1.45	13.6	1.68	15.7	1.92	16.8	2.07	17.9	2.20	20.0	2.47	22.3	2.76
	20	11.3	1.46	13.6	1.71	15.7	1.97	16.8	2.10	17.9	2.24	20.0	2.52	22.3	2.82
	21	11.3	1.47	13.6	1.72	15.7	1.98	16.8	2.12	17.9	2.25	20.0	2.54	22.3	2.85
	23	11.3	1.50	13.6	1.75	15.7	2.01	16.8	2.15	17.9	2.30	20.0	2.59	22.3	2.91
	25	11.3	1.52	13.6	1.78	15.7	2.05	16.8	2.20	17.9	2.37	20.0	2.72	22.3	3.11
	27	11.3	1.55	13.6	1.84	15.7	2.17	16.8	2.34	17.9	2.52	20.0	2.91	22.3	3.31
	29	11.3	1.63	13.6	1.95	15.7	2.30	16.8	2.49	17.9	2.67	20.0	3.08	22.3	3.51
	31	11.3	1.72	13.6	2.07	15.7	2.44	16.8	2.63	17.9	2.85	20.0	3.28	22.3	3.74
	33	11.3	1.82	13.6	2.18	15.7	2.59	16.8	2.79	17.9	3.02	20.0	3.48	22.3	3.99
	35	11.3	1.92	13.6	2.31	15.7	2.73	16.8	2.96	17.9	3.19	20.0	3.69	22.3	4.24
	37	11.3	2.04	13.6	2.44	15.7	2.89	16.8	3.14	17.9	3.38	20.0	3.93	22.3	4.50
	39	11.3	2.17	13.6	2.62	15.7	3.10	16.8	3.38	17.9	3.63	20.0	4.19	22.3	4.86
	41	11.0	2.35	13.2	2.83	15.3	3.39	16.4	3.66	17.4	3.93	19.5	4.59	21.7	5.27
43	10.8	2.55	12.9	3.08	14.9	3.68	16.0	3.98	17.0	4.28	19.0	5.01	21.2	5.75	
46	10.1	2.86	12.1	3.46	14.0	4.13	15.0	4.47	15.9	4.81	17.8	5.63	19.9	6.48	
48	8.9	2.49	10.7	3.02	12.4	3.61	13.2	3.90	14.1	4.19	15.8	4.92	17.6	5.66	

**Note**

1. TC: Total Capacity(kW), PI : Power Input(kW, Comp. + Outdoor fan motor)
2. Capacity tables show the average value of conditions which may occur.

# 7. Capacity Tables

## ◆ ARUM140LTE5

Cooling Capacity (14HP)

Combination (%)	Outdoor air temp. (DB, °C)	Indoor air temp. (DB/WB, °C)													
		20		23		26		27		28		30		32	
		14	16	16	18	18	19	19	20	20	22	22	24	24	
		TC	PI	TC	PI	TC	PI	TC	PI	TC	PI	TC	PI	TC	PI
130	10	38.8	3.68	46.2	4.50	49.6	5.21	51.0	5.32	52.4	5.36	54.9	5.41	56.3	5.43
	12	38.8	3.77	46.2	4.66	49.6	5.43	51.0	5.46	52.4	5.51	54.9	5.55	56.3	5.60
	14	38.8	3.90	46.2	4.82	49.6	5.63	51.0	5.67	52.4	5.72	54.9	5.76	56.3	5.82
	16	38.8	4.04	46.2	4.99	49.6	5.89	51.0	5.94	52.4	5.99	54.9	6.04	56.3	6.09
	18	38.8	4.21	46.2	5.28	49.6	6.16	51.0	6.29	52.4	6.34	54.9	6.40	56.3	6.45
	20	38.8	4.39	46.2	5.63	49.6	6.46	51.0	6.92	52.4	6.97	54.1	7.04	55.5	7.09
	21	38.8	4.51	46.2	5.82	49.6	6.59	51.0	7.32	52.4	7.38	53.8	7.45	55.2	7.50
	23	38.8	4.84	46.2	6.13	49.6	6.94	51.0	8.08	51.7	8.14	53.0	8.22	54.4	8.28
	25	38.8	5.17	46.2	6.48	49.6	7.41	50.4	8.96	51.0	9.03	52.4	9.12	53.8	9.18
	27	38.8	5.53	46.2	6.93	48.9	7.90	49.6	9.86	50.4	9.94	51.7	10.04	53.0	10.11
	29	38.8	5.89	46.2	7.40	48.1	8.50	48.8	10.84	49.6	10.90	51.0	11.00	52.4	11.04
	31	38.8	6.28	46.1	7.80	47.3	9.04	48.1	10.79	48.8	10.86	50.2	10.95	51.6	11.00
	33	38.8	6.70	45.3	8.26	46.7	9.69	47.5	10.69	48.1	10.76	49.6	10.85	50.8	10.90
	35	38.8	7.14	44.5	8.65	45.9	10.50	46.7	10.55	47.5	10.62	48.8	10.71	50.2	10.75
	37	38.8	7.61	43.9	9.08	45.3	10.36	45.9	10.41	46.7	10.48	48.0	10.57	49.4	10.61
	39	38.8	8.11	43.1	9.56	44.5	10.22	45.3	10.28	45.9	10.34	47.3	10.43	48.8	10.47
	41	37.8	8.60	41.3	10.04	42.7	10.09	43.3	10.14	44.2	10.20	45.5	10.29	46.7	10.33
	43	36.9	9.07	39.6	9.90	41.0	9.95	41.6	10.00	42.4	10.06	43.7	10.15	44.9	10.19
46	34.6	9.71	36.1	9.69	37.4	9.74	38.0	9.79	38.8	9.85	40.0	9.93	41.1	9.97	
48	30.6	9.44	31.4	9.47	32.5	9.49	33.0	9.51	33.8	9.60	34.8	9.66	35.8	9.69	
120	10	35.1	3.31	41.8	4.06	45.7	4.82	47.0	5.21	48.4	5.29	51.1	5.31	52.3	5.36
	12	35.1	3.40	41.8	4.19	45.7	5.01	47.0	5.32	48.4	5.49	51.1	5.55	52.3	5.60
	14	35.1	3.52	41.8	4.34	45.7	5.22	47.0	5.52	48.4	5.69	51.1	5.77	52.3	5.82
	16	35.1	3.64	41.8	4.51	45.7	5.42	47.0	5.73	48.4	5.95	51.1	6.03	52.3	6.07
	18	35.1	3.78	41.8	4.72	45.7	5.64	47.0	6.03	48.4	6.26	51.1	6.33	52.3	6.38
	20	35.1	3.93	41.8	5.00	45.7	5.94	47.0	6.35	48.4	6.59	51.1	6.68	52.3	6.73
	21	35.1	4.05	41.8	5.18	45.7	6.11	47.0	6.53	48.4	6.81	51.1	6.89	52.3	6.95
	23	35.1	4.33	41.8	5.54	45.7	6.54	47.0	6.94	48.4	7.26	51.1	7.33	52.3	7.39
	25	35.1	4.62	41.8	5.94	45.7	6.90	47.0	7.40	48.4	7.78	50.5	7.85	51.7	7.91
	27	35.1	4.94	41.8	6.35	45.7	7.34	47.0	7.91	48.4	8.36	49.7	8.42	50.9	8.49
	29	35.1	5.26	41.8	6.78	45.7	7.73	47.0	8.46	47.7	8.91	48.9	9.05	50.3	9.12
	31	35.1	5.61	41.8	7.24	45.7	8.13	46.4	9.06	47.0	9.56	48.3	9.73	49.5	9.81
	33	35.1	5.97	41.8	7.72	45.0	8.60	45.7	9.84	46.3	10.26	47.5	10.38	48.7	10.46
	35	35.1	6.35	41.8	8.23	44.3	9.10	44.9	10.84	45.7	10.89	46.9	10.92	48.1	11.01
	37	35.1	6.83	41.8	8.68	43.6	9.70	44.3	10.61	44.9	10.66	46.1	10.69	47.4	10.78
	39	35.1	7.35	41.6	9.17	42.9	10.29	43.5	10.39	44.1	10.44	45.5	10.47	46.7	10.56
	41	34.2	7.88	39.8	9.67	41.2	10.09	41.7	10.17	42.3	10.22	43.6	10.26	44.8	10.34
	43	33.4	8.41	38.1	9.53	39.5	9.86	40.0	9.96	40.6	10.01	41.8	10.04	43.0	10.12
46	31.3	9.04	34.8	9.30	36.0	9.55	36.6	9.63	37.1	9.68	38.2	9.71	39.4	9.78	
48	27.7	8.86	30.2	9.14	31.3	9.36	31.8	9.42	32.3	9.45	33.3	9.49	34.3	9.53	
110	10	31.5	2.98	37.5	3.63	41.9	4.31	43.1	4.66	45.8	5.02	46.9	5.16	50.1	5.24
	12	31.5	3.07	37.5	3.75	41.9	4.49	43.1	4.80	45.8	5.21	46.9	5.38	50.1	5.50
	14	31.5	3.16	37.5	3.92	41.9	4.69	43.1	5.03	45.8	5.47	46.9	5.63	50.1	5.74
	16	31.5	3.28	37.5	4.06	41.9	4.89	43.1	5.25	45.8	5.72	46.9	5.88	50.1	5.98
	18	31.5	3.40	37.5	4.23	41.9	5.17	43.1	5.53	45.8	6.04	46.9	6.16	50.1	6.27
	20	31.5	3.52	37.5	4.44	41.9	5.48	43.1	5.79	45.8	6.33	46.9	6.49	50.1	6.59
	21	31.5	3.60	37.5	4.57	41.9	5.62	43.1	5.94	45.8	6.51	46.9	6.67	50.1	6.77
	23	31.5	3.83	37.5	4.90	41.9	5.93	43.1	6.27	45.8	6.87	46.9	7.02	50.1	7.14
	25	31.5	4.10	37.5	5.23	41.9	6.27	43.1	6.63	45.8	7.26	46.9	7.37	49.5	7.52
	27	31.5	4.38	37.5	5.59	41.9	6.62	43.1	7.02	45.8	7.58	46.9	7.76	48.7	7.89
	29	31.5	4.67	37.5	5.97	41.9	7.00	43.1	7.43	45.8	8.01	46.9	8.15	48.1	8.28
	31	31.5	4.97	37.5	6.37	41.9	7.40	43.1	7.87	45.1	8.42	46.3	8.59	47.4	8.68
	33	31.5	5.30	37.5	6.78	41.9	7.81	43.1	8.34	44.5	8.89	45.5	9.04	46.7	9.09
	35	31.5	5.63	37.5	7.24	41.9	8.25	43.1	8.84	43.7	9.39	44.8	9.47	46.0	9.52
	37	31.5	5.96	37.5	7.68	41.9	8.71	42.5	9.37	43.0	9.90	44.2	9.93	45.2	9.96
	39	31.5	6.43	37.5	8.16	41.2	9.19	41.8	10.02	42.4	10.39	43.4	10.41	44.6	10.42
	41	30.7	6.89	36.6	8.65	39.4	9.69	40.0	10.84	40.5	10.84	41.7	10.92	42.7	11.01
	43	29.9	7.24	35.7	9.01	37.7	10.28	38.4	10.40	38.9	10.37	40.0	10.43	41.0	10.46
46	28.0	7.07	33.4	8.70	34.4	9.76	35.0	9.76	35.5	9.84	36.6	9.89	37.5	9.92	
48	24.8	6.86	29.0	8.38	29.9	9.28	30.5	9.34	30.9	9.39	31.8	9.42	32.7	9.45	

# 7. Capacity Tables

Cooling Capacity (14HP)

Combination (%)	Outdoor air temp. (DB, °C)	Indoor air temp. (DB/WB, °C)													
		20		23		26		27		28		30		32	
		14		16		18		19		20		22		24	
		TC	PI	TC	PI	TC	PI	TC	PI	TC	PI	TC	PI	TC	PI
100	10	26.5	2.68	31.5	3.26	36.7	3.86	39.2	4.18	41.7	4.49	46.3	4.99	47.3	5.03
	12	26.5	2.77	31.5	3.39	36.7	3.99	39.2	4.29	41.7	4.63	46.3	5.26	47.3	5.31
	14	26.5	2.85	31.5	3.53	36.7	4.16	39.2	4.47	41.7	4.83	46.3	5.56	47.3	5.61
	16	26.5	2.94	31.5	3.64	36.7	4.34	39.2	4.69	41.7	5.09	46.3	5.83	47.3	5.91
	18	26.5	3.03	31.5	3.78	36.7	4.51	39.2	4.91	41.7	5.40	46.3	6.15	47.3	6.20
	20	26.5	3.13	31.5	3.92	36.7	4.77	39.2	5.26	41.7	5.77	46.3	6.45	47.3	6.50
	21	26.5	3.20	31.5	4.01	36.7	4.94	39.2	5.45	41.7	5.99	46.3	6.60	47.3	6.65
	23	26.5	3.39	31.5	4.29	36.7	5.30	39.2	5.84	41.7	6.42	46.3	6.91	47.3	6.96
	25	26.5	3.60	31.5	4.57	36.7	5.66	39.2	6.25	41.7	6.86	46.3	7.20	46.9	7.26
	27	26.5	3.85	31.5	4.89	36.7	6.05	39.2	6.68	41.7	7.29	45.4	7.54	46.3	7.60
	29	26.5	4.10	31.5	5.22	36.7	6.47	39.2	7.14	41.7	7.72	44.5	7.85	45.6	7.91
	31	26.5	4.38	31.5	5.56	36.7	6.89	39.2	7.62	41.7	8.11	43.8	8.15	44.9	8.21
	33	26.5	4.64	31.5	5.92	36.7	7.35	39.2	8.13	41.7	8.42	43.1	8.45	44.2	8.52
	35	26.5	4.94	31.5	6.30	36.7	7.83	39.2	8.67	41.1	8.72	42.4	8.76	43.4	8.83
	37	26.5	5.29	31.5	6.76	36.7	8.30	39.2	9.08	40.4	9.13	41.6	9.16	42.6	9.25
	39	26.5	5.67	31.5	7.26	36.7	8.79	39.2	9.53	39.7	9.57	40.9	9.60	41.9	9.69
	41	26.0	6.05	31.0	7.76	36.1	9.29	37.6	9.97	38.4	10.01	39.3	10.05	40.6	10.14
	43	25.1	6.40	29.9	8.23	34.9	9.73	36.1	10.35	36.5	10.39	37.6	10.42	38.6	10.52
46	23.6	6.88	28.1	8.87	32.7	10.32	32.9	10.84	33.3	10.87	34.4	10.90	35.3	11.00	
48	20.8	5.94	24.8	7.67	28.2	8.82	28.6	9.20	28.9	9.23	29.9	9.25	30.7	9.32	
90	10	23.8	2.51	28.4	3.01	33.0	3.55	35.3	3.83	37.5	4.12	42.1	4.61	46.8	5.03
	12	23.8	2.54	28.4	3.06	33.0	3.61	35.3	3.91	37.5	4.21	42.1	4.70	46.8	5.22
	14	23.8	2.58	28.4	3.12	33.0	3.69	35.3	3.98	37.5	4.29	42.1	4.80	46.8	5.33
	16	23.8	2.63	28.4	3.18	33.0	3.77	35.3	4.06	37.5	4.37	42.1	4.89	46.8	5.42
	18	23.8	2.68	28.4	3.24	33.0	3.83	35.3	4.15	37.5	4.46	42.1	4.99	46.8	5.69
	20	23.8	2.72	28.4	3.31	33.0	3.91	35.3	4.23	37.5	4.63	42.1	5.34	46.8	5.96
	21	23.8	2.75	28.4	3.34	33.0	3.98	35.3	4.37	37.5	4.80	42.1	5.43	46.8	6.10
	23	23.8	2.81	28.4	3.48	33.0	4.26	35.3	4.69	37.5	5.14	42.1	5.76	46.1	6.39
	25	23.8	2.95	28.4	3.71	33.0	4.55	35.3	5.01	37.5	5.49	42.1	6.16	45.5	6.66
	27	23.8	3.15	28.4	3.95	33.0	4.86	35.3	5.35	37.5	5.87	42.1	6.55	44.8	6.97
	29	23.8	3.34	28.4	4.21	33.0	5.20	35.3	5.72	37.5	6.27	42.1	6.93	44.1	7.25
	31	23.8	3.55	28.4	4.49	33.0	5.54	35.3	6.09	37.5	6.69	42.1	7.28	43.5	7.53
	33	23.8	3.78	28.4	4.78	33.0	5.90	35.3	6.49	37.5	7.09	42.1	7.63	42.8	7.81
	35	23.8	4.01	28.4	5.07	33.0	6.27	35.3	6.92	37.5	7.52	41.4	8.07	42.1	8.26
	37	23.8	4.26	28.4	5.40	33.0	6.69	35.3	7.35	37.5	7.94	40.7	8.44	41.5	8.63
	39	23.8	4.51	28.4	5.74	33.0	7.08	35.3	7.82	37.5	8.35	40.1	8.89	40.8	9.00
	41	23.2	5.05	27.7	6.36	32.2	7.77	34.4	8.55	36.6	9.02	38.4	9.37	39.1	9.59
	43	22.6	5.45	27.0	6.88	31.4	8.49	33.5	9.21	35.7	9.67	36.8	10.04	37.5	10.16
46	21.2	6.13	25.3	7.83	29.4	9.67	31.4	10.44	32.4	10.74	33.6	10.90	34.2	11.00	
48	18.8	5.36	22.4	6.85	26.0	8.46	27.8	9.11	28.1	9.23	29.2	9.25	29.8	9.32	
80	10	21.1	2.34	25.2	2.82	29.3	3.31	31.4	3.57	33.5	3.83	37.5	4.36	41.6	4.74
	12	21.1	2.39	25.2	2.85	29.3	3.37	31.4	3.63	33.5	3.89	37.5	4.45	41.6	4.83
	14	21.1	2.43	25.2	2.91	29.3	3.42	31.4	3.70	33.5	3.96	37.5	4.53	41.6	4.93
	16	21.1	2.46	25.2	2.96	29.3	3.48	31.4	3.76	33.5	4.04	37.5	4.62	41.6	5.02
	18	21.1	2.51	25.2	3.01	29.3	3.55	31.4	3.83	33.5	4.12	37.5	4.71	41.6	5.13
	20	21.1	2.56	25.2	3.08	29.3	3.63	31.4	3.91	33.5	4.20	37.5	4.89	41.6	5.43
	21	21.1	2.57	25.2	3.11	29.3	3.66	31.4	3.96	33.5	4.30	37.5	5.04	41.6	5.58
	23	21.1	2.62	25.2	3.16	29.3	3.83	31.4	4.20	33.5	4.59	37.5	5.32	41.6	5.85
	25	21.1	2.72	25.2	3.37	29.3	4.10	31.4	4.49	33.5	4.92	37.5	5.69	41.6	6.26
	27	21.1	2.88	25.2	3.58	29.3	4.38	31.4	4.80	33.5	5.24	37.5	6.05	41.6	6.59
	29	21.1	3.06	25.2	3.83	29.3	4.66	31.4	5.11	33.5	5.60	37.5	6.48	41.6	6.89
	31	21.1	3.26	25.2	4.05	29.3	4.97	31.4	5.46	33.5	5.96	37.5	6.88	41.6	7.23
	33	21.1	3.45	25.2	4.33	29.3	5.29	31.4	5.81	33.5	6.35	37.5	7.25	41.6	7.58
	35	21.1	3.66	25.2	4.59	29.3	5.63	31.4	6.19	33.5	6.77	37.5	7.69	41.1	8.01
	37	21.1	3.88	25.2	4.88	29.3	5.98	31.4	6.58	33.5	7.20	37.5	8.11	40.5	8.41
	39	21.1	4.10	25.2	5.16	29.3	6.39	31.4	7.07	33.5	7.73	37.5	8.57	39.8	8.87
	41	20.6	4.53	24.6	5.72	28.5	7.02	30.6	7.75	32.6	8.50	36.6	9.19	38.1	9.40
	43	20.1	4.99	23.9	6.24	27.8	7.66	29.8	8.45	31.8	9.29	35.7	9.84	36.6	10.06
46	18.8	5.55	22.4	7.03	26.1	8.63	27.9	9.40	29.8	10.48	32.6	10.90	33.4	11.00	
48	16.7	4.85	19.9	6.15	23.1	7.55	24.7	8.21	26.4	9.17	28.3	9.25	29.0	9.32	

# 7. Capacity Tables

Cooling Capacity (14HP)

Combination (%)	Outdoor air temp. (DB, °C)	Indoor air temp. (DB/WB, °C)													
		20		23		26		27		28		30		32	
		14		16		18		19		20		22		24	
		TC	PI	TC	PI	TC	PI	TC	PI	TC	PI	TC	PI	TC	PI
70	10	18.5	2.08	22.1	2.47	25.6	2.87	27.4	3.10	29.3	3.31	32.8	3.77	36.4	4.21
	12	18.5	2.11	22.1	2.51	25.6	2.93	27.4	3.15	29.3	3.37	32.8	3.83	36.4	4.29
	14	18.5	2.15	22.1	2.54	25.6	2.98	27.4	3.19	29.3	3.42	32.8	3.92	36.4	4.37
	16	18.5	2.18	22.1	2.59	25.6	3.03	27.4	3.26	29.3	3.49	32.8	3.98	36.4	4.47
	18	18.5	2.21	22.1	2.64	25.6	3.10	27.4	3.33	29.3	3.55	32.8	4.05	36.4	4.55
	20	18.5	2.24	22.1	2.69	25.6	3.15	27.4	3.39	29.3	3.64	32.8	4.14	36.4	4.72
	21	18.5	2.28	22.1	2.70	25.6	3.18	27.4	3.42	29.3	3.67	32.8	4.21	36.4	4.82
	23	18.5	2.31	22.1	2.77	25.6	3.24	27.4	3.54	29.3	3.85	32.8	4.51	36.4	5.09
	25	18.5	2.34	22.1	2.87	25.6	3.46	27.4	3.78	29.3	4.11	32.8	4.82	36.4	5.33
	27	18.5	2.47	22.1	3.06	25.6	3.69	27.4	4.01	29.3	4.39	32.8	5.14	36.4	5.67
	29	18.5	2.64	22.1	3.24	25.6	3.92	27.4	4.28	29.3	4.67	32.8	5.49	36.4	6.07
	31	18.5	2.80	22.1	3.46	25.6	4.18	27.4	4.57	29.3	4.98	32.8	5.85	36.4	6.44
	33	18.5	2.97	22.1	3.65	25.6	4.44	27.4	4.85	29.3	5.29	32.8	6.23	36.4	6.86
	35	18.5	3.13	22.1	3.90	25.6	4.72	27.4	5.16	29.3	5.64	32.8	6.63	36.4	7.27
	37	18.5	3.33	22.1	4.13	25.6	5.01	27.4	5.49	29.3	6.00	32.8	7.06	36.4	7.68
	39	18.5	3.53	22.1	4.40	25.6	5.36	27.4	5.90	29.3	6.48	32.8	7.56	36.4	8.28
41	18.0	3.90	21.6	4.82	25.0	5.88	26.7	6.48	28.5	7.04	31.9	8.30	35.5	8.93	
43	17.6	4.25	21.0	5.26	24.3	6.42	26.1	7.06	27.8	7.69	31.1	9.07	34.6	9.65	
46	16.5	4.72	19.7	5.91	22.8	7.22	24.4	7.87	26.1	8.67	29.2	10.23	32.4	10.76	
48	14.6	4.12	17.4	5.16	20.2	6.32	21.6	6.87	23.1	7.58	25.8	8.95	28.7	9.31	
60	10	15.8	1.81	18.9	2.13	22.0	2.47	23.5	2.65	25.1	2.82	28.1	3.20	31.2	3.58
	12	15.8	1.85	18.9	2.16	22.0	2.51	23.5	2.69	25.1	2.87	28.1	3.25	31.2	3.64
	14	15.8	1.86	18.9	2.19	22.0	2.55	23.5	2.74	25.1	2.92	28.1	3.31	31.2	3.71
	16	15.8	1.90	18.9	2.24	22.0	2.59	23.5	2.79	25.1	2.98	28.1	3.38	31.2	3.77
	18	15.8	1.93	18.9	2.27	22.0	2.64	23.5	2.83	25.1	3.03	28.1	3.43	31.2	3.86
	20	15.8	1.96	18.9	2.31	22.0	2.69	23.5	2.88	25.1	3.08	28.1	3.49	31.2	3.94
	21	15.8	1.98	18.9	2.32	22.0	2.72	23.5	2.92	25.1	3.11	28.1	3.54	31.2	3.97
	23	15.8	2.01	18.9	2.37	22.0	2.75	23.5	2.97	25.1	3.18	28.1	3.68	31.2	4.22
	25	15.8	2.04	18.9	2.42	22.0	2.87	23.5	3.11	25.1	3.38	28.1	3.92	31.2	4.52
	27	15.8	2.11	18.9	2.55	22.0	3.05	23.5	3.31	25.1	3.59	28.1	4.17	31.2	4.81
	29	15.8	2.24	18.9	2.72	22.0	3.25	23.5	3.53	25.1	3.82	28.1	4.45	31.2	5.14
	31	15.8	2.37	18.9	2.88	22.0	3.44	23.5	3.76	25.1	4.07	28.1	4.75	31.2	5.47
	33	15.8	2.51	18.9	3.05	22.0	3.66	23.5	3.99	25.1	4.33	28.1	5.04	31.2	5.83
	35	15.8	2.65	18.9	3.25	22.0	3.89	23.5	4.24	25.1	4.60	28.1	5.37	31.2	6.20
	37	15.8	2.80	18.9	3.43	22.0	4.12	23.5	4.50	25.1	4.88	28.1	5.70	31.2	6.59
	39	15.8	2.98	18.9	3.65	22.0	4.45	23.5	4.83	25.1	5.25	28.1	6.11	31.2	7.06
41	15.4	3.23	18.4	3.99	21.4	4.83	22.9	5.27	24.4	5.70	27.4	6.71	30.4	7.68	
43	15.0	3.51	18.0	4.35	20.9	5.26	22.4	5.75	23.8	6.21	26.7	7.32	29.7	8.38	
46	14.1	3.93	16.8	4.88	19.6	5.92	20.9	6.46	22.3	6.99	25.1	8.25	27.8	9.55	
48	12.5	3.43	14.9	4.26	17.3	5.17	18.5	5.64	19.7	6.11	22.2	7.22	24.6	8.36	
50	10	13.2	1.58	15.8	1.82	18.3	2.07	19.6	2.22	20.9	2.35	23.4	2.65	26.0	2.95
	12	13.2	1.59	15.8	1.84	18.3	2.11	19.6	2.25	20.9	2.40	23.4	2.70	26.0	3.00
	14	13.2	1.61	15.8	1.87	18.3	2.14	19.6	2.29	20.9	2.44	23.4	2.74	26.0	3.05
	16	13.2	1.64	15.8	1.91	18.3	2.17	19.6	2.34	20.9	2.47	23.4	2.79	26.0	3.10
	18	13.2	1.66	15.8	1.92	18.3	2.21	19.6	2.37	20.9	2.52	23.4	2.84	26.0	3.17
	20	13.2	1.67	15.8	1.96	18.3	2.25	19.6	2.40	20.9	2.57	23.4	2.88	26.0	3.23
	21	13.2	1.69	15.8	1.97	18.3	2.27	19.6	2.44	20.9	2.59	23.4	2.92	26.0	3.27
	23	13.2	1.72	15.8	2.01	18.3	2.30	19.6	2.47	20.9	2.64	23.4	2.97	26.0	3.33
	25	13.2	1.74	15.8	2.04	18.3	2.35	19.6	2.52	20.9	2.72	23.4	3.12	26.0	3.56
	27	13.2	1.77	15.8	2.11	18.3	2.49	19.6	2.69	20.9	2.88	23.4	3.33	26.0	3.80
	29	13.2	1.87	15.8	2.24	18.3	2.64	19.6	2.85	20.9	3.07	23.4	3.53	26.0	4.03
	31	13.2	1.97	15.8	2.37	18.3	2.80	19.6	3.02	20.9	3.27	23.4	3.76	26.0	4.29
	33	13.2	2.09	15.8	2.50	18.3	2.97	19.6	3.20	20.9	3.47	23.4	4.00	26.0	4.58
	35	13.2	2.21	15.8	2.65	18.3	3.13	19.6	3.40	20.9	3.66	23.4	4.23	26.0	4.86
	37	13.2	2.34	15.8	2.80	18.3	3.32	19.6	3.60	20.9	3.88	23.4	4.51	26.0	5.16
	39	13.2	2.49	15.8	3.00	18.3	3.55	19.6	3.87	20.9	4.16	23.4	4.80	26.0	5.57
41	12.9	2.70	15.4	3.25	17.9	3.88	19.1	4.19	20.3	4.51	22.8	5.27	25.4	6.05	
43	12.6	2.93	15.0	3.54	17.4	4.23	18.6	4.57	19.8	4.91	22.2	5.74	24.7	6.60	
46	11.8	3.28	14.1	3.97	16.3	4.74	17.5	5.13	18.6	5.51	20.8	6.46	23.2	7.43	
48	10.4	2.86	12.5	3.46	14.4	4.14	15.4	4.48	16.4	4.81	18.4	5.65	20.5	6.49	

**Note**

1. TC: Total Capacity(kW), PI : Power Input(kW, Comp. + Outdoor fan motor)
2. Capacity tables show the average value of conditions which may occur.

# 7. Capacity Tables

## ◆ ARUM160LTE5

Cooling Capacity (16HP)

Combination (%)	Outdoor air temp. (DB, °C)	Indoor air temp. (DB/WB, °C)													
		20		23		26		27		28		30		32	
		14	16	16	18	18	19	19	20	20	22	22	24	24	
		TC	PI	TC	PI	TC	PI	TC	PI	TC	PI	TC	PI	TC	PI
130	10	44.4	4.62	52.8	5.65	56.6	6.56	58.3	6.69	59.9	6.74	62.8	6.80	64.4	6.82
	12	44.4	4.74	52.8	5.85	56.6	6.82	58.3	6.87	59.9	6.92	62.8	6.98	64.4	7.04
	14	44.4	4.90	52.8	6.07	56.6	7.08	58.3	7.13	59.9	7.19	62.8	7.25	64.4	7.31
	16	44.4	5.08	52.8	6.28	56.6	7.40	58.3	7.47	59.9	7.53	62.8	7.59	64.4	7.65
	18	44.4	5.29	52.8	6.64	56.6	7.74	58.3	7.91	59.9	7.97	62.8	8.05	64.4	8.10
	20	44.4	5.52	52.8	7.07	56.6	8.12	58.3	8.70	59.9	8.77	61.9	8.85	63.5	8.91
	21	44.4	5.67	52.8	7.32	56.6	8.29	58.3	9.20	59.9	9.28	61.5	9.37	63.1	9.43
	23	44.4	6.08	52.8	7.70	56.6	8.72	58.3	10.15	59.1	10.24	60.6	10.34	62.2	10.41
	25	44.4	6.49	52.8	8.15	56.6	9.32	57.6	11.26	58.3	11.35	59.9	11.46	61.5	11.54
	27	44.4	6.95	52.8	8.71	55.9	9.93	56.6	12.40	57.6	12.50	59.1	12.62	60.6	12.71
	29	44.4	7.40	52.8	9.31	55.0	10.68	55.8	13.63	56.6	13.71	58.3	13.83	59.9	13.88
	31	44.4	7.90	52.7	9.81	54.1	11.36	55.0	13.57	55.8	13.65	57.4	13.77	59.0	13.83
	33	44.4	8.42	51.8	10.39	53.4	12.19	54.3	13.44	55.0	13.52	56.6	13.65	58.1	13.70
	35	44.4	8.98	50.9	10.88	52.5	13.20	53.4	13.27	54.3	13.35	55.7	13.47	57.4	13.52
	37	44.4	9.57	50.1	11.42	51.8	13.03	52.5	13.09	53.4	13.17	54.8	13.29	56.5	13.34
	39	44.4	10.19	49.2	12.02	50.9	12.85	51.8	12.92	52.5	13.00	54.1	13.11	55.7	13.16
41	43.2	10.81	47.2	12.62	48.8	12.68	49.5	12.74	50.5	12.82	52.0	12.93	53.4	12.99	
43	42.2	11.40	45.2	12.44	46.8	12.50	47.5	12.57	48.5	12.64	50.0	12.76	51.3	12.81	
46	39.5	12.21	41.3	12.18	42.8	12.24	43.4	12.30	44.3	12.38	45.7	12.49	47.0	12.54	
48	35.0	11.87	35.8	11.90	37.2	11.93	37.8	11.96	38.6	12.06	39.8	12.14	40.9	12.19	
120	10	40.2	4.16	47.7	5.10	52.2	6.06	53.8	6.55	55.4	6.65	58.4	6.68	59.8	6.73
	12	40.2	4.27	47.7	5.27	52.2	6.30	53.8	6.69	55.4	6.90	58.4	6.98	59.8	7.04
	14	40.2	4.42	47.7	5.45	52.2	6.56	53.8	6.94	55.4	7.15	58.4	7.26	59.8	7.32
	16	40.2	4.58	47.7	5.67	52.2	6.81	53.8	7.20	55.4	7.48	58.4	7.58	59.8	7.64
	18	40.2	4.76	47.7	5.93	52.2	7.09	53.8	7.58	55.4	7.87	58.4	7.96	59.8	8.02
	20	40.2	4.94	47.7	6.29	52.2	7.47	53.8	7.98	55.4	8.28	58.4	8.39	59.8	8.46
	21	40.2	5.09	47.7	6.52	52.2	7.68	53.8	8.21	55.4	8.56	58.4	8.67	59.8	8.73
	23	40.2	5.44	47.7	6.97	52.2	8.22	53.8	8.73	55.4	9.12	58.4	9.21	59.8	9.29
	25	40.2	5.81	47.7	7.47	52.2	8.68	53.8	9.30	55.4	9.78	57.7	9.86	59.1	9.94
	27	40.2	6.20	47.7	7.98	52.2	9.23	53.8	9.94	55.4	10.51	56.8	10.58	58.2	10.67
	29	40.2	6.62	47.7	8.52	52.2	9.71	53.8	10.64	54.5	11.20	55.9	11.37	57.5	11.46
	31	40.2	7.05	47.7	9.10	52.2	10.22	53.1	11.39	53.8	12.02	55.2	12.23	56.6	12.33
	33	40.2	7.51	47.7	9.70	51.5	10.81	52.2	12.37	52.9	12.90	54.3	13.05	55.7	13.16
	35	40.2	7.98	47.7	10.34	50.6	11.44	51.3	13.63	52.2	13.69	53.6	13.73	55.0	13.84
	37	40.2	8.59	47.7	10.91	49.9	12.20	50.6	13.34	51.3	13.41	52.7	13.45	54.1	13.55
	39	40.2	9.24	47.6	11.53	49.0	12.94	49.7	13.06	50.4	13.13	52.0	13.17	53.4	13.27
41	39.1	9.90	45.5	12.15	47.0	12.68	47.7	12.79	48.4	12.85	49.8	12.89	51.2	13.00	
43	38.2	10.57	43.6	11.98	45.1	12.40	45.8	12.52	46.4	12.58	47.8	12.62	49.2	12.72	
46	35.8	11.36	39.7	11.69	41.2	12.01	41.8	12.11	42.4	12.17	43.7	12.20	45.0	12.30	
48	31.6	11.13	34.5	11.49	35.8	11.77	36.3	11.84	36.9	11.88	38.0	11.93	39.2	11.98	
110	10	36.0	3.74	42.9	4.56	47.9	5.42	49.3	5.86	52.4	6.31	53.6	6.49	57.2	6.59
	12	36.0	3.86	42.9	4.71	47.9	5.64	49.3	6.03	52.4	6.55	53.6	6.76	57.2	6.91
	14	36.0	3.98	42.9	4.93	47.9	5.90	49.3	6.33	52.4	6.88	53.6	7.07	57.2	7.22
	16	36.0	4.12	42.9	5.11	47.9	6.14	49.3	6.60	52.4	7.19	53.6	7.39	57.2	7.52
	18	36.0	4.27	42.9	5.32	47.9	6.49	49.3	6.95	52.4	7.59	53.6	7.74	57.2	7.88
	20	36.0	4.43	42.9	5.58	47.9	6.89	49.3	7.27	52.4	7.96	53.6	8.15	57.2	8.28
	21	36.0	4.52	42.9	5.75	47.9	7.06	49.3	7.47	52.4	8.18	53.6	8.39	57.2	8.52
	23	36.0	4.82	42.9	6.16	47.9	7.46	49.3	7.89	52.4	8.64	53.6	8.83	57.2	8.97
	25	36.0	5.15	42.9	6.58	47.9	7.88	49.3	8.34	52.4	9.13	53.6	9.26	56.5	9.45
	27	36.0	5.50	42.9	7.03	47.9	8.33	49.3	8.82	52.4	9.53	53.6	9.75	55.7	9.92
	29	36.0	5.87	42.9	7.51	47.9	8.80	49.3	9.34	52.4	10.07	53.6	10.25	55.0	10.40
	31	36.0	6.25	42.9	8.00	47.9	9.30	49.3	9.90	51.5	10.59	52.9	10.79	54.1	10.91
	33	36.0	6.66	42.9	8.52	47.9	9.82	49.3	10.49	50.8	11.18	52.1	11.37	53.4	11.43
	35	36.0	7.07	42.9	9.10	47.9	10.38	49.3	11.12	50.0	11.80	51.2	11.91	52.6	11.97
	37	36.0	7.50	42.9	9.66	47.9	10.95	48.6	11.78	49.1	12.44	50.5	12.49	51.7	12.52
	39	36.0	8.08	42.9	10.26	47.0	11.56	47.7	12.60	48.4	13.06	49.6	13.08	51.0	13.10
41	35.0	8.67	41.8	10.87	45.0	12.19	45.7	13.63	46.3	13.63	47.7	13.73	48.9	13.84	
43	34.2	9.10	40.7	11.32	43.1	12.92	43.8	13.07	44.4	13.04	45.7	13.12	46.9	13.15	
46	32.0	8.88	38.2	10.93	39.4	12.27	40.0	12.27	40.6	12.37	41.8	12.44	42.9	12.47	
48	28.3	8.63	33.2	10.53	34.2	11.67	34.8	11.75	35.3	11.80	36.4	11.84	37.3	11.89	



# 7. Capacity Tables

Cooling Capacity (16HP)

Combination (%)	Outdoor air temp. (DB, °C)	Indoor air temp. (DB/WB, °C)													
		20		23		26		27		28		30		32	
		14		16		18		19		20		22		24	
		TC	PI	TC	PI	TC	PI	TC	PI	TC	PI	TC	PI	TC	PI
100	10	30.2	3.37	36.0	4.10	41.9	4.86	44.8	5.25	47.7	5.64	52.9	6.28	54.0	6.33
	12	30.2	3.48	36.0	4.26	41.9	5.02	44.8	5.39	47.7	5.82	52.9	6.62	54.0	6.68
	14	30.2	3.59	36.0	4.43	41.9	5.23	44.8	5.62	47.7	6.07	52.9	6.99	54.0	7.05
	16	30.2	3.70	36.0	4.58	41.9	5.46	44.8	5.89	47.7	6.40	52.9	7.32	54.0	7.43
	18	30.2	3.80	36.0	4.75	41.9	5.67	44.8	6.18	47.7	6.78	52.9	7.74	54.0	7.80
	20	30.2	3.94	36.0	4.93	41.9	6.00	44.8	6.62	47.7	7.26	52.9	8.11	54.0	8.17
	21	30.2	4.02	36.0	5.05	41.9	6.20	44.8	6.85	47.7	7.53	52.9	8.29	54.0	8.36
	23	30.2	4.26	36.0	5.40	41.9	6.66	44.8	7.34	47.7	8.07	52.9	8.68	54.0	8.75
	25	30.2	4.53	36.0	5.75	41.9	7.11	44.8	7.86	47.7	8.62	52.9	9.06	53.6	9.13
	27	30.2	4.84	36.0	6.14	41.9	7.61	44.8	8.40	47.7	9.17	51.8	9.48	52.9	9.56
	29	30.2	5.15	36.0	6.56	41.9	8.13	44.8	8.98	47.7	9.71	50.9	9.86	52.1	9.94
	31	30.2	5.50	36.0	6.99	41.9	8.67	44.8	9.58	47.7	10.20	50.1	10.24	51.3	10.33
	33	30.2	5.83	36.0	7.45	41.9	9.25	44.8	10.22	47.7	10.58	49.3	10.63	50.5	10.71
	35	30.2	6.20	36.0	7.92	41.9	9.85	44.8	10.90	47.0	10.97	48.4	11.01	49.6	11.10
	37	30.2	6.65	36.0	8.50	41.9	10.43	44.8	11.42	46.2	11.48	47.5	11.52	48.6	11.63
	39	30.2	7.12	36.0	9.13	41.9	11.05	44.8	11.98	45.4	12.03	46.7	12.08	47.8	12.19
	41	29.8	7.60	35.4	9.76	41.3	11.67	43.0	12.54	43.9	12.59	45.0	12.63	46.4	12.75
43	28.7	8.05	34.2	10.34	39.8	12.23	41.2	13.01	41.7	13.06	43.0	13.10	44.1	13.23	
46	26.9	8.66	32.1	11.15	37.3	12.97	37.6	13.63	38.0	13.66	39.3	13.70	40.3	13.83	
48	23.8	7.47	28.4	9.65	32.2	11.09	32.7	11.56	33.0	11.60	34.1	11.62	35.1	11.72	
90	10	27.2	3.18	32.5	3.83	37.8	4.51	40.3	4.86	42.9	5.23	48.2	5.86	53.4	6.33
	12	27.2	3.22	32.5	3.89	37.8	4.59	40.3	4.96	42.9	5.35	48.2	5.97	53.4	6.63
	14	27.2	3.28	32.5	3.96	37.8	4.69	40.3	5.06	42.9	5.45	48.2	6.09	53.4	6.76
	16	27.2	3.34	32.5	4.04	37.8	4.78	40.3	5.15	42.9	5.54	48.2	6.20	53.4	6.88
	18	27.2	3.40	32.5	4.12	37.8	4.86	40.3	5.27	42.9	5.66	48.2	6.34	53.4	7.22
	20	27.2	3.46	32.5	4.20	37.8	4.96	40.3	5.37	42.9	5.88	48.2	6.78	53.4	7.57
	21	27.2	3.49	32.5	4.24	37.8	5.06	40.3	5.54	42.9	6.09	48.2	6.89	53.4	7.74
	23	27.2	3.57	32.5	4.41	37.8	5.41	40.3	5.95	42.9	6.52	48.2	7.31	52.7	8.11
	25	27.2	3.75	32.5	4.71	37.8	5.78	40.3	6.36	42.9	6.97	48.2	7.82	51.9	8.45
	27	27.2	4.00	32.5	5.02	37.8	6.17	40.3	6.79	42.9	7.46	48.2	8.31	51.2	8.85
	29	27.2	4.24	32.5	5.35	37.8	6.60	40.3	7.26	42.9	7.97	48.2	8.80	50.4	9.21
	31	27.2	4.51	32.5	5.70	37.8	7.03	40.3	7.73	42.9	8.49	48.2	9.24	49.7	9.56
	33	27.2	4.80	32.5	6.07	37.8	7.50	40.3	8.24	42.9	9.01	48.2	9.69	48.9	9.92
	35	27.2	5.10	32.5	6.44	37.8	7.97	40.3	8.79	42.9	9.55	47.3	10.25	48.1	10.48
	37	27.2	5.41	32.5	6.85	37.8	8.49	40.3	9.33	42.9	10.08	46.6	10.71	47.4	10.95
	39	27.2	5.73	32.5	7.29	37.8	8.99	40.3	9.93	42.9	10.60	45.8	11.29	46.6	11.43
	41	26.5	6.41	31.6	8.08	36.8	9.87	39.3	10.86	41.8	11.45	43.9	11.90	44.7	12.17
43	25.8	6.92	30.9	8.73	35.9	10.78	38.3	11.70	40.7	12.27	42.1	12.71	42.9	12.90	
46	24.2	7.78	28.9	9.94	33.6	12.28	35.9	13.26	37.0	13.64	38.4	13.70	39.1	13.83	
48	21.4	6.80	25.6	8.70	29.7	10.74	31.8	11.56	32.2	11.60	33.4	11.62	34.0	11.72	
80	10	24.2	2.98	28.8	3.58	33.4	4.20	35.8	4.53	38.2	4.86	42.9	5.54	47.5	6.02
	12	24.2	3.04	28.8	3.62	33.4	4.28	35.8	4.61	38.2	4.94	42.9	5.64	47.5	6.14
	14	24.2	3.08	28.8	3.70	33.4	4.34	35.8	4.69	38.2	5.02	42.9	5.75	47.5	6.25
	16	24.2	3.12	28.8	3.76	33.4	4.42	35.8	4.78	38.2	5.13	42.9	5.87	47.5	6.37
	18	24.2	3.18	28.8	3.82	33.4	4.51	35.8	4.86	38.2	5.23	42.9	5.98	47.5	6.51
	20	24.2	3.25	28.8	3.91	33.4	4.61	35.8	4.96	38.2	5.33	42.9	6.20	47.5	6.90
	21	24.2	3.27	28.8	3.95	33.4	4.65	35.8	5.02	38.2	5.46	42.9	6.40	47.5	7.08
	23	24.2	3.33	28.8	4.01	33.4	4.86	35.8	5.33	38.2	5.83	42.9	6.76	47.5	7.43
	25	24.2	3.45	28.8	4.28	33.4	5.21	35.8	5.71	38.2	6.24	42.9	7.23	47.5	7.95
	27	24.2	3.66	28.8	4.55	33.4	5.56	35.8	6.10	38.2	6.66	42.9	7.68	47.5	8.36
	29	24.2	3.89	28.8	4.86	33.4	5.91	35.8	6.49	38.2	7.11	42.9	8.23	47.5	8.75
	31	24.2	4.14	28.8	5.15	33.4	6.31	35.8	6.93	38.2	7.57	42.9	8.73	47.5	9.18
	33	24.2	4.38	28.8	5.50	33.4	6.72	35.8	7.38	38.2	8.06	42.9	9.20	47.5	9.62
	35	24.2	4.65	28.8	5.83	33.4	7.15	35.8	7.86	38.2	8.60	42.9	9.76	47.0	10.17
	37	24.2	4.92	28.8	6.20	33.4	7.59	35.8	8.35	38.2	9.14	42.9	10.30	46.3	10.68
	39	24.2	5.20	28.8	6.55	33.4	8.12	35.8	8.98	38.2	9.82	42.9	10.88	45.5	11.26
	41	23.5	5.75	28.1	7.26	32.6	8.91	34.9	9.84	37.3	10.79	41.8	11.66	43.6	11.93
43	23.0	6.33	27.4	7.93	31.8	9.72	34.1	10.73	36.3	11.79	40.7	12.46	41.8	12.77	
46	21.5	7.05	25.6	8.93	29.8	10.96	31.9	11.94	34.1	13.31	37.3	13.70	38.1	13.83	
48	19.0	6.15	22.7	7.81	26.3	9.58	28.2	10.43	30.1	11.60	32.4	11.62	33.1	11.72	

# 7. Capacity Tables

Cooling Capacity (16HP)

Combination (%)	Outdoor air temp. (DB, °C)	Indoor air temp. (DB/WB, °C)													
		20		23		26		27		28		30		32	
		14		16		18		19		20		22		24	
		TC	PI	TC	PI	TC	PI	TC	PI	TC	PI	TC	PI	TC	PI
70	10	21.1	2.64	25.3	3.14	29.3	3.64	31.4	3.93	33.4	4.20	37.4	4.78	41.6	5.35
	12	21.1	2.68	25.3	3.18	29.3	3.72	31.4	3.99	33.4	4.28	37.4	4.87	41.6	5.45
	14	21.1	2.72	25.3	3.22	29.3	3.79	31.4	4.06	33.4	4.35	37.4	4.97	41.6	5.55
	16	21.1	2.77	25.3	3.29	29.3	3.85	31.4	4.14	33.4	4.43	37.4	5.05	41.6	5.67
	18	21.1	2.81	25.3	3.35	29.3	3.93	31.4	4.22	33.4	4.51	37.4	5.14	41.6	5.77
	20	21.1	2.85	25.3	3.41	29.3	3.99	31.4	4.31	33.4	4.62	37.4	5.26	41.6	5.99
	21	21.1	2.89	25.3	3.43	29.3	4.04	31.4	4.35	33.4	4.66	37.4	5.35	41.6	6.12
	23	21.1	2.93	25.3	3.52	29.3	4.12	31.4	4.49	33.4	4.89	37.4	5.72	41.6	6.46
	25	21.1	2.97	25.3	3.64	29.3	4.39	31.4	4.80	33.4	5.22	37.4	6.12	41.6	6.77
	27	21.1	3.14	25.3	3.89	29.3	4.68	31.4	5.10	33.4	5.57	37.4	6.53	41.6	7.20
	29	21.1	3.35	25.3	4.12	29.3	4.97	31.4	5.43	33.4	5.93	37.4	6.97	41.6	7.71
	31	21.1	3.56	25.3	4.39	29.3	5.30	31.4	5.80	33.4	6.32	37.4	7.43	41.6	8.18
	33	21.1	3.76	25.3	4.64	29.3	5.64	31.4	6.16	33.4	6.72	37.4	7.90	41.6	8.71
	35	21.1	3.97	25.3	4.95	29.3	5.99	31.4	6.55	33.4	7.16	37.4	8.42	41.6	9.24
	37	21.1	4.22	25.3	5.24	29.3	6.36	31.4	6.97	33.4	7.61	37.4	8.96	41.6	9.75
	39	21.1	4.48	25.3	5.59	29.3	6.81	31.4	7.50	33.4	8.22	37.4	9.59	41.6	10.51
	41	20.6	4.96	24.6	6.12	28.5	7.46	30.6	8.22	32.6	8.94	36.5	10.54	40.5	11.33
	43	20.1	5.40	24.0	6.68	27.8	8.15	29.8	8.97	31.8	9.76	35.6	11.51	39.5	12.26
46	18.8	6.00	22.5	7.51	26.1	9.17	27.9	9.99	29.8	11.00	33.3	12.98	37.0	13.66	
48	16.6	5.23	19.9	6.56	23.1	8.02	24.7	8.73	26.3	9.63	29.5	11.36	32.8	11.72	
60	10	18.1	2.30	21.6	2.70	25.1	3.14	26.9	3.37	28.6	3.58	32.2	4.06	35.7	4.54
	12	18.1	2.34	21.6	2.74	25.1	3.18	26.9	3.41	28.6	3.64	32.2	4.12	35.7	4.62
	14	18.1	2.36	21.6	2.78	25.1	3.24	26.9	3.47	28.6	3.70	32.2	4.21	35.7	4.71
	16	18.1	2.41	21.6	2.85	25.1	3.29	26.9	3.54	28.6	3.79	32.2	4.29	35.7	4.79
	18	18.1	2.45	21.6	2.89	25.1	3.35	26.9	3.60	28.6	3.85	32.2	4.35	35.7	4.90
	20	18.1	2.49	21.6	2.93	25.1	3.41	26.9	3.66	28.6	3.91	32.2	4.44	35.7	5.00
	21	18.1	2.51	21.6	2.95	25.1	3.45	26.9	3.70	28.6	3.95	32.2	4.50	35.7	5.04
	23	18.1	2.55	21.6	3.01	25.1	3.49	26.9	3.77	28.6	4.04	32.2	4.67	35.7	5.36
	25	18.1	2.59	21.6	3.08	25.1	3.64	26.9	3.95	28.6	4.29	32.2	4.98	35.7	5.73
	27	18.1	2.68	21.6	3.24	25.1	3.87	26.9	4.21	28.6	4.56	32.2	5.29	35.7	6.11
	29	18.1	2.85	21.6	3.45	25.1	4.12	26.9	4.48	28.6	4.85	32.2	5.65	35.7	6.53
	31	18.1	3.01	21.6	3.66	25.1	4.37	26.9	4.77	28.6	5.17	32.2	6.03	35.7	6.95
	33	18.1	3.18	21.6	3.87	25.1	4.65	26.9	5.06	28.6	5.50	32.2	6.40	35.7	7.41
	35	18.1	3.37	21.6	4.12	25.1	4.94	26.9	5.38	28.6	5.84	32.2	6.82	35.7	7.87
	37	18.1	3.56	21.6	4.35	25.1	5.23	26.9	5.71	28.6	6.19	32.2	7.24	35.7	8.37
	39	18.1	3.78	21.6	4.63	25.1	5.65	26.9	6.13	28.6	6.67	32.2	7.76	35.7	8.97
	41	17.6	4.10	21.0	5.07	24.5	6.13	26.2	6.69	27.9	7.23	31.3	8.52	34.8	9.75
	43	17.2	4.46	20.5	5.52	23.9	6.68	25.5	7.30	27.2	7.89	30.6	9.30	33.9	10.65
46	16.1	4.99	19.2	6.20	22.4	7.52	23.9	8.20	25.5	8.88	28.6	10.48	31.8	12.13	
48	14.2	4.35	17.0	5.41	19.8	6.57	21.2	7.16	22.6	7.76	25.3	9.16	28.1	10.61	
50	10	15.1	2.00	18.1	2.32	21.0	2.63	22.4	2.82	23.8	2.99	26.7	3.37	29.8	3.75
	12	15.1	2.02	18.1	2.34	21.0	2.67	22.4	2.86	23.8	3.05	26.7	3.43	29.8	3.81
	14	15.1	2.04	18.1	2.38	21.0	2.72	22.4	2.90	23.8	3.09	26.7	3.47	29.8	3.87
	16	15.1	2.08	18.1	2.42	21.0	2.76	22.4	2.97	23.8	3.14	26.7	3.54	29.8	3.94
	18	15.1	2.10	18.1	2.44	21.0	2.80	22.4	3.01	23.8	3.20	26.7	3.60	29.8	4.02
	20	15.1	2.13	18.1	2.48	21.0	2.86	22.4	3.05	23.8	3.26	26.7	3.66	29.8	4.10
	21	15.1	2.15	18.1	2.50	21.0	2.88	22.4	3.09	23.8	3.28	26.7	3.70	29.8	4.15
	23	15.1	2.19	18.1	2.55	21.0	2.93	22.4	3.14	23.8	3.35	26.7	3.77	29.8	4.23
	25	15.1	2.21	18.1	2.59	21.0	2.99	22.4	3.20	23.8	3.45	26.7	3.96	29.8	4.53
	27	15.1	2.25	18.1	2.67	21.0	3.16	22.4	3.41	23.8	3.66	26.7	4.23	29.8	4.82
	29	15.1	2.38	18.1	2.84	21.0	3.35	22.4	3.62	23.8	3.89	26.7	4.48	29.8	5.11
	31	15.1	2.50	18.1	3.01	21.0	3.56	22.4	3.83	23.8	4.15	26.7	4.78	29.8	5.45
	33	15.1	2.65	18.1	3.18	21.0	3.77	22.4	4.06	23.8	4.40	26.7	5.07	29.8	5.81
	35	15.1	2.80	18.1	3.37	21.0	3.98	22.4	4.31	23.8	4.65	26.7	5.37	29.8	6.17
	37	15.1	2.97	18.1	3.56	21.0	4.21	22.4	4.57	23.8	4.93	26.7	5.72	29.8	6.55
	39	15.1	3.17	18.1	3.81	21.0	4.51	22.4	4.92	23.8	5.28	26.7	6.10	29.8	7.07
	41	14.7	3.42	17.6	4.13	20.4	4.93	21.8	5.32	23.2	5.73	26.0	6.68	29.0	7.68
	43	14.4	3.72	17.2	4.49	19.9	5.37	21.3	5.80	22.7	6.23	25.4	7.29	28.3	8.38
46	13.5	4.17	16.1	5.04	18.7	6.02	19.9	6.51	21.2	7.00	23.8	8.20	26.5	9.43	
48	11.9	3.63	14.2	4.39	16.5	5.25	17.6	5.68	18.8	6.11	21.1	7.17	23.4	8.24	

**Note**

1. TC: Total Capacity(kW), PI : Power Input(kW, Comp. + Outdoor fan motor)
2. Capacity tables show the average value of conditions which may occur.

# 7. Capacity Tables

## ◆ ARUM180LTE5

Cooling Capacity (18HP)

Combination (%)	Outdoor air temp. (DB, °C)	Indoor air temp. (DB/WB, °C)													
		20		23		26		27		28		30		32	
		14	16	18	19	20	22	24	TC	PI	TC	PI	TC	PI	
130	10	49.9	4.68	59.5	5.72	63.7	6.63	65.5	6.77	67.4	6.82	70.6	6.88	72.4	6.90
	12	49.9	4.79	59.5	5.92	63.7	6.91	65.5	6.95	67.4	7.01	70.6	7.06	72.4	7.13
	14	49.9	4.96	59.5	6.14	63.7	7.17	65.5	7.22	67.4	7.28	70.6	7.33	72.4	7.40
	16	49.9	5.14	59.5	6.35	63.7	7.49	65.5	7.56	67.4	7.62	70.6	7.69	72.4	7.75
	18	49.9	5.35	59.5	6.72	63.7	7.83	65.5	8.00	67.4	8.06	70.6	8.14	72.4	8.20
	20	49.9	5.59	59.5	7.16	63.7	8.22	65.5	8.80	67.4	8.87	69.6	8.96	71.4	9.02
	21	49.9	5.73	59.5	7.41	63.7	8.39	65.5	9.31	67.4	9.39	69.2	9.48	71.0	9.55
	23	49.9	6.15	59.5	7.79	63.7	8.83	65.5	10.28	66.5	10.36	68.2	10.46	70.0	10.53
	25	49.9	6.57	59.5	8.24	63.7	9.43	64.8	11.40	65.5	11.49	67.4	11.60	69.2	11.68
	27	49.9	7.03	59.5	8.81	62.9	10.05	63.7	12.55	64.8	12.65	66.5	12.77	68.2	12.86
	29	49.9	7.49	59.5	9.42	61.9	10.81	62.8	13.79	63.7	13.87	65.5	13.99	67.4	14.05
	31	49.9	8.00	59.3	9.92	60.9	11.50	61.9	13.73	62.8	13.81	64.5	13.94	66.3	13.99
	33	49.9	8.52	58.2	10.51	60.1	12.33	61.0	13.60	61.9	13.69	63.7	13.81	65.3	13.86
	35	49.9	9.08	57.2	11.01	59.0	13.36	60.1	13.43	61.0	13.51	62.7	13.63	64.5	13.68
	37	49.9	9.69	56.4	11.55	58.2	13.18	59.0	13.25	60.1	13.33	61.7	13.45	63.5	13.50
	39	49.9	10.31	55.4	12.16	57.2	13.01	58.2	13.07	59.0	13.15	60.9	13.27	62.7	13.32
41	48.6	10.94	53.1	12.77	54.9	12.83	55.7	12.90	56.8	12.97	58.5	13.09	60.1	13.14	
43	47.4	11.54	50.9	12.59	52.7	12.65	53.5	12.72	54.5	12.79	56.2	12.91	57.7	12.96	
46	44.5	12.35	46.4	12.33	48.1	12.39	48.9	12.45	49.9	12.53	51.4	12.64	52.9	12.69	
48	39.3	12.01	40.3	12.04	41.8	12.07	42.5	12.10	43.4	12.21	44.8	12.28	46.0	12.33	
120	10	45.2	4.21	53.7	5.16	58.7	6.13	60.5	6.63	62.3	6.73	65.7	6.76	67.3	6.81
	12	45.2	4.32	53.7	5.34	58.7	6.38	60.5	6.77	62.3	6.98	65.7	7.07	67.3	7.12
	14	45.2	4.47	53.7	5.52	58.7	6.64	60.5	7.03	62.3	7.24	65.7	7.35	67.3	7.40
	16	45.2	4.63	53.7	5.74	58.7	6.89	60.5	7.29	62.3	7.57	65.7	7.67	67.3	7.73
	18	45.2	4.81	53.7	6.00	58.7	7.17	60.5	7.67	62.3	7.96	65.7	8.05	67.3	8.12
	20	45.2	5.00	53.7	6.36	58.7	7.56	60.5	8.07	62.3	8.38	65.7	8.49	67.3	8.56
	21	45.2	5.15	53.7	6.59	58.7	7.77	60.5	8.31	62.3	8.66	65.7	8.77	67.3	8.84
	23	45.2	5.50	53.7	7.05	58.7	8.32	60.5	8.83	62.3	9.23	65.7	9.32	67.3	9.40
	25	45.2	5.88	53.7	7.56	58.7	8.78	60.5	9.41	62.3	9.90	64.9	9.98	66.4	10.06
	27	45.2	6.28	53.7	8.08	58.7	9.34	60.5	10.06	62.3	10.64	63.9	10.71	65.5	10.80
	29	45.2	6.70	53.7	8.62	58.7	9.83	60.5	10.76	61.3	11.34	62.9	11.51	64.7	11.60
	31	45.2	7.14	53.7	9.21	58.7	10.34	59.7	11.53	60.5	12.16	62.1	12.38	63.7	12.48
	33	45.2	7.60	53.7	9.82	57.9	10.94	58.7	12.52	59.5	13.06	61.1	13.21	62.7	13.31
	35	45.2	8.08	53.7	10.46	56.9	11.58	57.7	13.79	58.7	13.86	60.3	13.90	61.9	14.01
	37	45.2	8.69	53.7	11.04	56.1	12.34	56.9	13.50	57.7	13.57	59.3	13.61	60.9	13.71
	39	45.2	9.36	53.5	11.67	55.1	13.09	55.9	13.22	56.7	13.29	58.5	13.33	60.1	13.43
41	44.0	10.02	51.2	12.30	52.9	12.83	53.7	12.94	54.4	13.01	56.0	13.05	57.6	13.15	
43	42.9	10.70	49.0	12.12	50.7	12.54	51.5	12.67	52.2	12.73	53.8	12.77	55.3	12.87	
46	40.2	11.50	44.7	11.83	46.3	12.15	47.0	12.25	47.7	12.31	49.2	12.35	50.6	12.45	
48	35.6	11.27	38.8	11.62	40.3	11.91	40.9	11.99	41.5	12.02	42.8	12.07	44.1	12.12	
110	10	40.5	3.79	48.2	4.62	53.9	5.48	55.4	5.93	58.9	6.39	60.3	6.56	64.4	6.67
	12	40.5	3.90	48.2	4.77	53.9	5.71	55.4	6.10	58.9	6.63	60.3	6.84	64.4	7.00
	14	40.5	4.03	48.2	4.99	53.9	5.97	55.4	6.40	58.9	6.96	60.3	7.16	64.4	7.31
	16	40.5	4.17	48.2	5.17	53.9	6.21	55.4	6.68	58.9	7.28	60.3	7.48	64.4	7.61
	18	40.5	4.32	48.2	5.38	53.9	6.57	55.4	7.04	58.9	7.68	60.3	7.83	64.4	7.98
	20	40.5	4.48	48.2	5.65	53.9	6.97	55.4	7.36	58.9	8.05	60.3	8.25	64.4	8.38
	21	40.5	4.58	48.2	5.82	53.9	7.15	55.4	7.56	58.9	8.28	60.3	8.49	64.4	8.62
	23	40.5	4.88	48.2	6.24	53.9	7.55	55.4	7.98	58.9	8.74	60.3	8.93	64.4	9.08
	25	40.5	5.21	48.2	6.66	53.9	7.97	55.4	8.44	58.9	9.24	60.3	9.37	63.6	9.56
	27	40.5	5.57	48.2	7.12	53.9	8.43	55.4	8.93	58.9	9.65	60.3	9.87	62.7	10.04
	29	40.5	5.94	48.2	7.60	53.9	8.90	55.4	9.45	58.9	10.20	60.3	10.37	61.9	10.53
	31	40.5	6.32	48.2	8.10	53.9	9.41	55.4	10.02	58.0	10.71	59.5	10.92	60.9	11.04
	33	40.5	6.74	48.2	8.62	53.9	9.94	55.4	10.62	57.2	11.31	58.6	11.50	60.1	11.56
	35	40.5	7.16	48.2	9.21	53.9	10.50	55.4	11.25	56.2	11.94	57.6	12.05	59.1	12.11
	37	40.5	7.59	48.2	9.77	53.9	11.08	54.7	11.92	55.2	12.59	56.8	12.64	58.2	12.67
	39	40.5	8.18	48.2	10.39	52.9	11.70	53.7	12.75	54.5	13.22	55.8	13.24	57.4	13.25
41	39.4	8.77	47.0	11.00	50.6	12.33	51.4	13.79	52.1	13.79	53.6	13.90	55.0	14.01	
43	38.5	9.21	45.8	11.46	48.5	13.08	49.3	13.23	50.0	13.20	51.5	13.27	52.8	13.31	
46	36.0	8.99	43.0	11.06	44.3	12.41	45.1	12.41	45.6	12.52	47.0	12.59	48.3	12.62	
48	31.9	8.73	37.3	10.66	38.5	11.81	39.2	11.89	39.7	11.95	40.9	11.98	42.0	12.03	

# 7. Capacity Tables

Cooling Capacity (18HP)

Combination (%)	Outdoor air temp. (DB, °C)	Indoor air temp. (DB/WB, °C)													
		20		23		26		27		28		30		32	
		14		16		18		19		20		22		24	
		TC	PI	TC	PI	TC	PI	TC	PI	TC	PI	TC	PI	TC	PI
100	10	34.0	3.41	40.5	4.14	47.2	4.92	50.4	5.31	53.6	5.71	59.5	6.35	60.8	6.40
	12	34.0	3.52	40.5	4.31	47.2	5.08	50.4	5.46	53.6	5.89	59.5	6.70	60.8	6.76
	14	34.0	3.63	40.5	4.49	47.2	5.30	50.4	5.69	53.6	6.14	59.5	7.07	60.8	7.14
	16	34.0	3.74	40.5	4.63	47.2	5.52	50.4	5.96	53.6	6.47	59.5	7.41	60.8	7.52
	18	34.0	3.85	40.5	4.81	47.2	5.74	50.4	6.25	53.6	6.86	59.5	7.83	60.8	7.89
	20	34.0	3.99	40.5	4.99	47.2	6.07	50.4	6.70	53.6	7.35	59.5	8.21	60.8	8.27
	21	34.0	4.07	40.5	5.11	47.2	6.28	50.4	6.93	53.6	7.62	59.5	8.39	60.8	8.46
	23	34.0	4.31	40.5	5.46	47.2	6.74	50.4	7.43	53.6	8.16	59.5	8.79	60.8	8.86
	25	34.0	4.58	40.5	5.82	47.2	7.20	50.4	7.95	53.6	8.73	59.5	9.16	60.3	9.24
	27	34.0	4.90	40.5	6.22	47.2	7.70	50.4	8.50	53.6	9.28	58.3	9.59	59.5	9.67
	29	34.0	5.21	40.5	6.63	47.2	8.23	50.4	9.08	53.6	9.82	57.2	9.98	58.6	10.06
	31	34.0	5.57	40.5	7.07	47.2	8.77	50.4	9.69	53.6	10.32	56.4	10.37	57.7	10.45
	33	34.0	5.90	40.5	7.53	47.2	9.36	50.4	10.34	53.6	10.71	55.5	10.75	56.8	10.84
	35	34.0	6.28	40.5	8.02	47.2	9.96	50.4	11.03	52.8	11.10	54.5	11.14	55.8	11.23
	37	34.0	6.72	40.5	8.60	47.2	10.55	50.4	11.56	52.0	11.61	53.4	11.66	54.7	11.77
	39	34.0	7.21	40.5	9.24	47.2	11.18	50.4	12.12	51.1	12.17	52.6	12.22	53.8	12.33
	41	33.5	7.69	39.9	9.87	46.4	11.81	48.4	12.68	49.4	12.74	50.6	12.78	52.2	12.90
	43	32.3	8.14	38.5	10.47	44.8	12.38	46.4	13.17	46.9	13.22	48.4	13.26	49.6	13.38
46	30.3	8.76	36.1	11.28	42.0	13.13	42.3	13.79	42.8	13.83	44.2	13.87	45.4	14.00	
48	26.8	7.56	31.9	9.76	36.3	11.22	36.8	11.70	37.2	11.74	38.4	11.76	39.4	11.86	
90	10	30.6	3.22	36.5	3.87	42.5	4.56	45.4	4.92	48.2	5.29	54.2	5.93	60.1	6.40
	12	30.6	3.26	36.5	3.93	42.5	4.64	45.4	5.02	48.2	5.41	54.2	6.04	60.1	6.71
	14	30.6	3.32	36.5	4.01	42.5	4.74	45.4	5.12	48.2	5.51	54.2	6.16	60.1	6.84
	16	30.6	3.38	36.5	4.09	42.5	4.84	45.4	5.22	48.2	5.61	54.2	6.28	60.1	6.96
	18	30.6	3.44	36.5	4.17	42.5	4.92	45.4	5.33	48.2	5.73	54.2	6.42	60.1	7.31
	20	30.6	3.50	36.5	4.25	42.5	5.02	45.4	5.43	48.2	5.95	54.2	6.87	60.1	7.66
	21	30.6	3.54	36.5	4.29	42.5	5.12	45.4	5.61	48.2	6.16	54.2	6.98	60.1	7.83
	23	30.6	3.62	36.5	4.46	42.5	5.47	45.4	6.03	48.2	6.60	54.2	7.40	59.3	8.20
	25	30.6	3.79	36.5	4.76	42.5	5.85	45.4	6.44	48.2	7.05	54.2	7.91	58.4	8.55
	27	30.6	4.05	36.5	5.08	42.5	6.24	45.4	6.88	48.2	7.55	54.2	8.41	57.6	8.96
	29	30.6	4.29	36.5	5.41	42.5	6.68	45.4	7.35	48.2	8.06	54.2	8.91	56.7	9.32
	31	30.6	4.56	36.5	5.77	42.5	7.11	45.4	7.82	48.2	8.59	54.2	9.35	55.9	9.68
	33	30.6	4.86	36.5	6.14	42.5	7.59	45.4	8.34	48.2	9.11	54.2	9.81	55.0	10.04
	35	30.6	5.16	36.5	6.52	42.5	8.06	45.4	8.89	48.2	9.67	53.2	10.37	54.2	10.61
	37	30.6	5.47	36.5	6.93	42.5	8.59	45.4	9.44	48.2	10.20	52.4	10.84	53.3	11.08
	39	30.6	5.79	36.5	7.38	42.5	9.10	45.4	10.05	48.2	10.73	51.5	11.43	52.4	11.57
	41	29.8	6.48	35.6	8.18	41.4	9.98	44.2	10.99	47.0	11.58	49.4	12.04	50.3	12.32
	43	29.1	7.00	34.7	8.84	40.4	10.91	43.1	11.84	45.8	12.42	47.3	12.86	48.2	13.05
46	27.3	7.88	32.5	10.06	37.8	12.43	40.4	13.42	41.7	13.80	43.2	13.87	44.0	14.00	
48	24.1	6.88	28.8	8.80	33.5	10.87	35.7	11.70	36.2	11.74	37.6	11.76	38.3	11.86	
80	10	27.2	3.01	32.4	3.62	37.6	4.25	40.3	4.58	43.0	4.92	48.2	5.61	53.5	6.09
	12	27.2	3.08	32.4	3.66	37.6	4.33	40.3	4.67	43.0	5.00	48.2	5.71	53.5	6.21
	14	27.2	3.12	32.4	3.75	37.6	4.39	40.3	4.75	43.0	5.08	48.2	5.82	53.5	6.33
	16	27.2	3.16	32.4	3.81	37.6	4.48	40.3	4.83	43.0	5.19	48.2	5.94	53.5	6.45
	18	27.2	3.22	32.4	3.87	37.6	4.56	40.3	4.92	43.0	5.29	48.2	6.05	53.5	6.59
	20	27.2	3.28	32.4	3.95	37.6	4.67	40.3	5.02	43.0	5.40	48.2	6.28	53.5	6.98
	21	27.2	3.31	32.4	4.00	37.6	4.71	40.3	5.08	43.0	5.52	48.2	6.47	53.5	7.17
	23	27.2	3.37	32.4	4.06	37.6	4.92	40.3	5.40	43.0	5.90	48.2	6.84	53.5	7.52
	25	27.2	3.49	32.4	4.33	37.6	5.27	40.3	5.77	43.0	6.32	48.2	7.32	53.5	8.04
	27	27.2	3.70	32.4	4.60	37.6	5.63	40.3	6.17	43.0	6.74	48.2	7.77	53.5	8.46
	29	27.2	3.93	32.4	4.92	37.6	5.98	40.3	6.57	43.0	7.20	48.2	8.33	53.5	8.85
	31	27.2	4.18	32.4	5.21	37.6	6.38	40.3	7.01	43.0	7.66	48.2	8.84	53.5	9.29
	33	27.2	4.44	32.4	5.57	37.6	6.80	40.3	7.47	43.0	8.16	48.2	9.31	53.5	9.74
	35	27.2	4.71	32.4	5.90	37.6	7.24	40.3	7.95	43.0	8.70	48.2	9.87	52.9	10.29
	37	27.2	4.98	32.4	6.27	37.6	7.68	40.3	8.45	43.0	9.25	48.2	10.42	52.0	10.80
	39	27.2	5.26	32.4	6.63	37.6	8.21	40.3	9.09	43.0	9.94	48.2	11.01	51.2	11.40
	41	26.5	5.82	31.6	7.35	36.7	9.01	39.3	9.96	41.9	10.92	47.0	11.80	49.0	12.07
	43	25.8	6.41	30.8	8.02	35.8	9.84	38.3	10.86	40.9	11.93	45.8	12.60	47.0	12.92
46	24.2	7.13	28.9	9.03	33.5	11.09	35.9	12.08	38.3	13.47	41.9	13.87	42.9	14.00	
48	21.4	6.23	25.5	7.90	29.6	9.70	31.8	10.55	33.9	11.74	36.4	11.76	37.3	11.86	

# 7. Capacity Tables

Cooling Capacity (18HP)

Combination (%)	Outdoor air temp. (DB, °C)	Indoor air temp. (DB/WB, °C)													
		20		23		26		27		28		30		32	
		14		16		18		19		20		22		24	
		TC	PI	TC	PI	TC	PI	TC	PI	TC	PI	TC	PI	TC	PI
70	10	23.8	2.67	28.4	3.18	32.9	3.68	35.3	3.98	37.6	4.25	42.1	4.84	46.8	5.42
	12	23.8	2.72	28.4	3.22	32.9	3.77	35.3	4.04	37.6	4.34	42.1	4.93	46.8	5.52
	14	23.8	2.76	28.4	3.26	32.9	3.83	35.3	4.10	37.6	4.40	42.1	5.03	46.8	5.62
	16	23.8	2.80	28.4	3.33	32.9	3.89	35.3	4.19	37.6	4.48	42.1	5.11	46.8	5.74
	18	23.8	2.84	28.4	3.39	32.9	3.98	35.3	4.27	37.6	4.57	42.1	5.20	46.8	5.84
	20	23.8	2.88	28.4	3.45	32.9	4.04	35.3	4.36	37.6	4.67	42.1	5.33	46.8	6.06
	21	23.8	2.93	28.4	3.47	32.9	4.08	35.3	4.40	37.6	4.71	42.1	5.41	46.8	6.19
	23	23.8	2.97	28.4	3.56	32.9	4.17	35.3	4.55	37.6	4.95	42.1	5.79	46.8	6.54
	25	23.8	3.01	28.4	3.68	32.9	4.44	35.3	4.86	37.6	5.28	42.1	6.19	46.8	6.85
	27	23.8	3.18	28.4	3.94	32.9	4.74	35.3	5.16	37.6	5.64	42.1	6.61	46.8	7.28
	29	23.8	3.39	28.4	4.17	32.9	5.03	35.3	5.49	37.6	6.00	42.1	7.05	46.8	7.80
	31	23.8	3.60	28.4	4.44	32.9	5.37	35.3	5.87	37.6	6.40	42.1	7.51	46.8	8.28
	33	23.8	3.81	28.4	4.69	32.9	5.70	35.3	6.23	37.6	6.80	42.1	8.00	46.8	8.81
	35	23.8	4.02	28.4	5.01	32.9	6.06	35.3	6.63	37.6	7.24	42.1	8.52	46.8	9.35
	37	23.8	4.27	28.4	5.31	32.9	6.44	35.3	7.05	37.6	7.70	42.1	9.07	46.8	9.86
	39	23.8	4.54	28.4	5.66	32.9	6.89	35.3	7.59	37.6	8.32	42.1	9.71	46.8	10.63
	41	23.2	5.02	27.7	6.20	32.1	7.55	34.4	8.32	36.7	9.05	41.0	10.66	45.6	11.47
43	22.6	5.46	27.0	6.76	31.3	8.24	33.5	9.07	35.8	9.88	40.0	11.65	44.5	12.40	
46	21.2	6.07	25.3	7.60	29.3	9.28	31.4	10.11	33.5	11.14	37.5	13.14	41.7	13.82	
48	18.7	5.30	22.4	6.63	26.0	8.11	27.8	8.83	29.6	9.74	33.2	11.50	36.9	11.86	
60	10	20.3	2.33	24.3	2.73	28.3	3.18	30.2	3.41	32.2	3.62	36.2	4.11	40.1	4.59
	12	20.3	2.37	24.3	2.77	28.3	3.22	30.2	3.45	32.2	3.68	36.2	4.17	40.1	4.68
	14	20.3	2.39	24.3	2.82	28.3	3.28	30.2	3.51	32.2	3.75	36.2	4.26	40.1	4.76
	16	20.3	2.43	24.3	2.88	28.3	3.32	30.2	3.58	32.2	3.83	36.2	4.34	40.1	4.85
	18	20.3	2.48	24.3	2.92	28.3	3.39	30.2	3.64	32.2	3.90	36.2	4.40	40.1	4.95
	20	20.3	2.52	24.3	2.96	28.3	3.45	30.2	3.71	32.2	3.96	36.2	4.49	40.1	5.06
	21	20.3	2.54	24.3	2.99	28.3	3.49	30.2	3.75	32.2	4.00	36.2	4.55	40.1	5.10
	23	20.3	2.58	24.3	3.05	28.3	3.54	30.2	3.81	32.2	4.09	36.2	4.72	40.1	5.42
	25	20.3	2.63	24.3	3.11	28.3	3.68	30.2	4.00	32.2	4.34	36.2	5.04	40.1	5.80
	27	20.3	2.71	24.3	3.28	28.3	3.92	30.2	4.26	32.2	4.62	36.2	5.36	40.1	6.18
	29	20.3	2.88	24.3	3.49	28.3	4.17	30.2	4.53	32.2	4.91	36.2	5.72	40.1	6.61
	31	20.3	3.05	24.3	3.71	28.3	4.43	30.2	4.83	32.2	5.23	36.2	6.10	40.1	7.03
	33	20.3	3.22	24.3	3.92	28.3	4.70	30.2	5.12	32.2	5.57	36.2	6.48	40.1	7.50
	35	20.3	3.41	24.3	4.17	28.3	5.00	30.2	5.44	32.2	5.91	36.2	6.90	40.1	7.96
	37	20.3	3.60	24.3	4.40	28.3	5.29	30.2	5.78	32.2	6.27	36.2	7.33	40.1	8.47
	39	20.3	3.83	24.3	4.69	28.3	5.71	30.2	6.20	32.2	6.74	36.2	7.86	40.1	9.08
	41	19.8	4.15	23.7	5.13	27.5	6.20	29.5	6.77	31.4	7.32	35.3	8.62	39.1	9.86
43	19.3	4.51	23.1	5.58	26.9	6.76	28.7	7.38	30.6	7.98	34.4	9.41	38.1	10.77	
46	18.1	5.05	21.6	6.27	25.2	7.61	26.9	8.30	28.7	8.98	32.2	10.60	35.7	12.27	
48	16.0	4.40	19.1	5.47	22.3	6.65	23.8	7.25	25.4	7.85	28.5	9.27	31.6	10.74	
50	10	17.0	2.02	20.3	2.34	23.6	2.66	25.2	2.85	26.8	3.02	30.1	3.41	33.5	3.79
	12	17.0	2.04	20.3	2.36	23.6	2.70	25.2	2.90	26.8	3.09	30.1	3.47	33.5	3.86
	14	17.0	2.07	20.3	2.41	23.6	2.75	25.2	2.94	26.8	3.13	30.1	3.51	33.5	3.92
	16	17.0	2.11	20.3	2.45	23.6	2.79	25.2	3.00	26.8	3.17	30.1	3.58	33.5	3.98
	18	17.0	2.13	20.3	2.47	23.6	2.83	25.2	3.05	26.8	3.24	30.1	3.64	33.5	4.07
	20	17.0	2.15	20.3	2.51	23.6	2.90	25.2	3.09	26.8	3.30	30.1	3.71	33.5	4.15
	21	17.0	2.17	20.3	2.53	23.6	2.92	25.2	3.13	26.8	3.32	30.1	3.75	33.5	4.20
	23	17.0	2.22	20.3	2.58	23.6	2.96	25.2	3.17	26.8	3.39	30.1	3.81	33.5	4.28
	25	17.0	2.24	20.3	2.62	23.6	3.02	25.2	3.24	26.8	3.49	30.1	4.00	33.5	4.58
	27	17.0	2.28	20.3	2.70	23.6	3.19	25.2	3.45	26.8	3.71	30.1	4.28	33.5	4.88
	29	17.0	2.41	20.3	2.88	23.6	3.39	25.2	3.66	26.8	3.94	30.1	4.54	33.5	5.18
	31	17.0	2.53	20.3	3.05	23.6	3.60	25.2	3.88	26.8	4.20	30.1	4.83	33.5	5.52
	33	17.0	2.68	20.3	3.22	23.6	3.81	25.2	4.11	26.8	4.45	30.1	5.13	33.5	5.88
	35	17.0	2.83	20.3	3.41	23.6	4.03	25.2	4.37	26.8	4.71	30.1	5.43	33.5	6.24
	37	17.0	3.00	20.3	3.60	23.6	4.26	25.2	4.62	26.8	4.98	30.1	5.79	33.5	6.62
	39	17.0	3.20	20.3	3.86	23.6	4.56	25.2	4.97	26.8	5.35	30.1	6.17	33.5	7.15
	41	16.6	3.46	19.8	4.18	23.0	4.99	24.6	5.39	26.1	5.79	29.3	6.76	32.6	7.77
43	16.2	3.76	19.3	4.54	22.4	5.43	23.9	5.87	25.5	6.31	28.6	7.38	31.8	8.48	
46	15.1	4.22	18.1	5.10	21.0	6.09	22.4	6.59	23.9	7.08	26.8	8.30	29.8	9.54	
48	13.4	3.67	16.0	4.44	18.6	5.31	19.9	5.75	21.1	6.18	23.7	7.25	26.4	8.34	

**Note**

1. TC: Total Capacity(kW), PI : Power Input(kW, Comp. + Outdoor fan motor)
2. Capacity tables show the average value of conditions which may occur.

# 7. Capacity Tables

## ◆ ARUM200LTE5

Cooling Capacity (20HP)

Combination (%)	Outdoor air temp. (DB, °C)	Indoor air temp. (DB/WB, °C)													
		20		23		26		27		28		30		32	
		14	16	16	18	18	19	20	20	22	22	24	24		
		TC	PI	TC	PI	TC	PI	TC	PI	TC	PI	TC	PI	TC	PI
130	10	55.5	5.41	66.1	6.62	70.8	7.67	72.8	7.83	74.9	7.89	78.5	7.96	80.5	7.99
	12	55.5	5.55	66.1	6.85	70.8	7.99	72.8	8.04	74.9	8.11	78.5	8.17	80.5	8.24
	14	55.5	5.73	66.1	7.10	70.8	8.29	72.8	8.35	74.9	8.42	78.5	8.48	80.5	8.56
	16	55.5	5.94	66.1	7.35	70.8	8.66	72.8	8.74	74.9	8.81	78.5	8.89	80.5	8.96
	18	55.5	6.19	66.1	7.77	70.8	9.06	72.8	9.25	74.9	9.33	78.5	9.42	80.5	9.49
	20	55.5	6.46	66.1	8.28	70.8	9.51	72.8	10.18	74.9	10.26	77.3	10.36	79.4	10.43
	21	55.5	6.63	66.1	8.57	70.8	9.71	72.8	10.77	74.9	10.86	76.9	10.97	78.9	11.04
	23	55.5	7.12	66.1	9.02	70.8	10.21	72.8	11.89	73.9	11.98	75.8	12.10	77.8	12.18
	25	55.5	7.60	66.1	9.54	70.8	10.91	72.0	13.18	72.8	13.29	74.9	13.42	76.9	13.51
	27	55.5	8.14	66.1	10.19	69.9	11.62	70.8	14.51	72.0	14.63	73.9	14.77	75.8	14.88
	29	55.5	8.67	66.1	10.90	68.8	12.51	69.8	15.95	70.8	16.05	72.8	16.19	74.9	16.25
	31	55.5	9.25	65.8	11.48	67.6	13.30	68.8	15.88	69.8	15.98	71.7	16.12	73.7	16.19
	33	55.5	9.85	64.7	12.16	66.7	14.27	67.8	15.74	68.8	15.83	70.8	15.97	72.6	16.04
	35	55.5	10.51	63.6	12.74	65.6	15.46	66.7	15.53	67.8	15.63	69.7	15.77	71.7	15.83
	37	55.5	11.21	62.7	13.37	64.7	15.25	65.6	15.33	66.7	15.42	68.5	15.56	70.6	15.62
	39	55.5	11.93	61.6	14.07	63.6	15.05	64.7	15.12	65.6	15.21	67.6	15.35	69.7	15.41
41	54.0	12.66	59.0	14.77	61.0	14.84	61.9	14.92	63.1	15.01	65.0	15.14	66.8	15.20	
43	52.7	13.35	56.5	14.57	58.5	14.64	59.4	14.71	60.6	14.80	62.4	14.93	64.1	14.99	
46	49.4	14.29	51.6	14.26	53.5	14.33	54.3	14.40	55.4	14.49	57.2	14.62	58.7	14.68	
48	43.7	13.89	44.8	13.93	46.5	13.96	47.2	14.00	48.2	14.12	49.8	14.21	51.1	14.27	
120	10	50.2	4.87	59.7	5.97	65.2	7.09	67.2	7.67	69.2	7.79	73.0	7.82	74.7	7.88
	12	50.2	5.00	59.7	6.17	65.2	7.38	67.2	7.83	69.2	8.08	73.0	8.18	74.7	8.24
	14	50.2	5.17	59.7	6.38	65.2	7.68	67.2	8.13	69.2	8.37	73.0	8.50	74.7	8.57
	16	50.2	5.36	59.7	6.64	65.2	7.98	67.2	8.43	69.2	8.76	73.0	8.87	74.7	8.94
	18	50.2	5.57	59.7	6.94	65.2	8.29	67.2	8.87	69.2	9.21	73.0	9.31	74.7	9.39
	20	50.2	5.78	59.7	7.36	65.2	8.74	67.2	9.34	69.2	9.70	73.0	9.83	74.7	9.90
	21	50.2	5.96	59.7	7.63	65.2	8.99	67.2	9.61	69.2	10.02	73.0	10.14	74.7	10.23
	23	50.2	6.37	59.7	8.16	65.2	9.63	67.2	10.22	69.2	10.68	73.0	10.79	74.7	10.87
	25	50.2	6.80	59.7	8.74	65.2	10.16	67.2	10.89	69.2	11.45	72.1	11.55	73.8	11.64
	27	50.2	7.26	59.7	9.35	65.2	10.81	67.2	11.63	69.2	12.31	71.0	12.39	72.7	12.49
	29	50.2	7.75	59.7	9.98	65.2	11.37	67.2	12.45	68.1	13.12	69.9	13.31	71.8	13.42
	31	50.2	8.26	59.7	10.65	65.2	11.96	66.3	13.34	67.2	14.07	69.0	14.32	70.7	14.43
	33	50.2	8.79	59.7	11.36	64.3	12.65	65.2	14.48	66.1	15.11	67.9	15.28	69.6	15.40
	35	50.2	9.35	59.7	12.11	63.2	13.39	64.1	15.95	65.2	16.03	67.0	16.08	68.7	16.21
	37	50.2	10.05	59.7	12.77	62.3	14.28	63.2	15.61	64.1	15.69	65.9	15.74	67.7	15.86
	39	50.2	10.82	59.5	13.50	61.2	15.14	62.1	15.29	63.0	15.37	65.0	15.42	66.8	15.54
41	48.9	11.59	56.9	14.23	58.8	14.84	59.6	14.97	60.5	15.05	62.2	15.09	64.0	15.21	
43	47.7	12.37	54.5	14.03	56.4	14.51	57.2	14.65	58.0	14.73	59.7	14.77	61.5	14.89	
46	44.7	13.30	49.7	13.69	51.5	14.06	52.2	14.17	53.0	14.24	54.6	14.28	56.3	14.40	
48	39.5	13.03	43.1	13.45	44.7	13.78	45.4	13.86	46.1	13.91	47.5	13.97	49.0	14.02	
110	10	45.0	4.38	53.6	5.34	59.9	6.34	61.6	6.86	65.5	7.39	67.0	7.59	71.5	7.72
	12	45.0	4.52	53.6	5.52	59.9	6.60	61.6	7.06	65.5	7.66	67.0	7.91	71.5	8.09
	14	45.0	4.66	53.6	5.77	59.9	6.90	61.6	7.41	65.5	8.05	67.0	8.28	71.5	8.45
	16	45.0	4.82	53.6	5.98	59.9	7.19	61.6	7.73	65.5	8.42	67.0	8.65	71.5	8.80
	18	45.0	5.00	53.6	6.23	59.9	7.60	61.6	8.14	65.5	8.88	67.0	9.06	71.5	9.23
	20	45.0	5.18	53.6	6.54	59.9	8.06	61.6	8.51	65.5	9.31	67.0	9.54	71.5	9.70
	21	45.0	5.30	53.6	6.73	59.9	8.27	61.6	8.74	65.5	9.57	67.0	9.82	71.5	9.97
	23	45.0	5.64	53.6	7.22	59.9	8.73	61.6	9.23	65.5	10.11	67.0	10.33	71.5	10.50
	25	45.0	6.03	53.6	7.70	59.9	9.22	61.6	9.76	65.5	10.69	67.0	10.84	70.7	11.06
	27	45.0	6.44	53.6	8.23	59.9	9.75	61.6	10.33	65.5	11.16	67.0	11.42	69.6	11.61
	29	45.0	6.88	53.6	8.79	59.9	10.30	61.6	10.94	65.5	11.79	67.0	12.00	68.7	12.18
	31	45.0	7.31	53.6	9.37	59.9	10.89	61.6	11.59	64.4	12.39	66.1	12.64	67.7	12.77
	33	45.0	7.80	53.6	9.98	59.9	11.50	61.6	12.28	63.5	13.09	65.1	13.30	66.8	13.38
	35	45.0	8.28	53.6	10.65	59.9	12.15	61.6	13.01	62.5	13.81	64.0	13.94	65.7	14.01
	37	45.0	8.78	53.6	11.31	59.9	12.82	60.7	13.79	61.4	14.57	63.1	14.62	64.6	14.66
	39	45.0	9.46	53.6	12.02	58.8	13.53	59.6	14.75	60.5	15.29	62.0	15.32	63.8	15.33
41	43.8	10.15	52.2	12.72	56.3	14.27	57.2	15.95	57.9	15.95	59.6	16.08	61.1	16.21	
43	42.7	10.66	50.9	13.26	53.9	15.13	54.8	15.30	55.5	15.27	57.2	15.35	58.6	15.40	
46	40.0	10.40	47.7	12.80	49.2	14.36	50.1	14.36	50.7	14.48	52.3	14.56	53.6	14.60	
48	35.4	10.10	41.5	12.33	42.7	13.66	43.5	13.75	44.1	13.82	45.5	13.86	46.7	13.91	

# 7. Capacity Tables

Cooling Capacity (20HP)

Combination (%)	Outdoor air temp. (DB, °C)	Indoor air temp. (DB/WB, °C)													
		20		23		26		27		28		30		32	
		14		16		18		19		20		22		24	
		TC	PI	TC	PI	TC	PI	TC	PI	TC	PI	TC	PI	TC	PI
100	10	37.8	3.94	45.0	4.79	52.4	5.69	56.0	6.15	59.6	6.60	66.1	7.35	67.5	7.41
	12	37.8	4.07	45.0	4.99	52.4	5.88	56.0	6.31	59.6	6.81	66.1	7.75	67.5	7.82
	14	37.8	4.20	45.0	5.19	52.4	6.13	56.0	6.58	59.6	7.11	66.1	8.18	67.5	8.26
	16	37.8	4.33	45.0	5.36	52.4	6.39	56.0	6.90	59.6	7.49	66.1	8.57	67.5	8.69
	18	37.8	4.45	45.0	5.56	52.4	6.64	56.0	7.23	59.6	7.94	66.1	9.06	67.5	9.13
	20	37.8	4.61	45.0	5.77	52.4	7.02	56.0	7.75	59.6	8.50	66.1	9.49	67.5	9.57
	21	37.8	4.71	45.0	5.91	52.4	7.26	56.0	8.01	59.6	8.81	66.1	9.71	67.5	9.79
	23	37.8	4.99	45.0	6.32	52.4	7.80	56.0	8.60	59.6	9.44	66.1	10.17	67.5	10.25
	25	37.8	5.30	45.0	6.73	52.4	8.33	56.0	9.20	59.6	10.10	66.1	10.60	67.0	10.69
	27	37.8	5.67	45.0	7.19	52.4	8.91	56.0	9.83	59.6	10.73	64.8	11.10	66.2	11.19
	29	37.8	6.03	45.0	7.68	52.4	9.52	56.0	10.51	59.6	11.36	63.6	11.55	65.2	11.64
	31	37.8	6.44	45.0	8.18	52.4	10.15	56.0	11.21	59.6	11.94	62.6	11.99	64.2	12.09
	33	37.8	6.83	45.0	8.72	52.4	10.82	56.0	11.96	59.6	12.39	61.6	12.44	63.2	12.54
	35	37.8	7.26	45.0	9.27	52.4	11.53	56.0	12.76	58.7	12.84	60.5	12.89	62.0	12.99
	37	37.8	7.78	45.0	9.95	52.4	12.21	56.0	13.37	57.7	13.43	59.4	13.49	60.8	13.61
	39	37.8	8.34	45.0	10.68	52.4	12.94	56.0	14.02	56.8	14.08	58.4	14.14	59.8	14.27
	41	37.2	8.90	44.3	11.42	51.6	13.67	53.7	14.67	54.9	14.73	56.2	14.78	58.0	14.92
	43	35.9	9.42	42.8	12.11	49.8	14.32	51.5	15.24	52.1	15.29	53.7	15.34	55.1	15.48
46	33.7	10.13	40.1	13.05	46.7	15.19	47.0	15.95	47.5	16.00	49.1	16.04	50.4	16.20	
48	29.8	8.75	35.5	11.29	40.3	12.98	40.9	13.53	41.3	13.58	42.7	13.61	43.8	13.72	
90	10	34.0	3.73	40.6	4.48	47.2	5.28	50.4	5.69	53.6	6.13	60.2	6.86	66.8	7.41
	12	34.0	3.77	40.6	4.55	47.2	5.37	50.4	5.81	53.6	6.26	60.2	6.99	66.8	7.76
	14	34.0	3.84	40.6	4.64	47.2	5.49	50.4	5.92	53.6	6.38	60.2	7.13	66.8	7.92
	16	34.0	3.91	40.6	4.73	47.2	5.60	50.4	6.03	53.6	6.49	60.2	7.26	66.8	8.05
	18	34.0	3.98	40.6	4.82	47.2	5.69	50.4	6.17	53.6	6.63	60.2	7.42	66.8	8.46
	20	34.0	4.05	40.6	4.91	47.2	5.81	50.4	6.29	53.6	6.88	60.2	7.94	66.8	8.86
	21	34.0	4.09	40.6	4.96	47.2	5.92	50.4	6.49	53.6	7.13	60.2	8.07	66.8	9.06
	23	34.0	4.18	40.6	5.17	47.2	6.33	50.4	6.97	53.6	7.63	60.2	8.56	65.9	9.49
	25	34.0	4.39	40.6	5.51	47.2	6.77	50.4	7.45	53.6	8.16	60.2	9.15	64.9	9.90
	27	34.0	4.69	40.6	5.87	47.2	7.22	50.4	7.95	53.6	8.73	60.2	9.73	64.0	10.36
	29	34.0	4.96	40.6	6.26	47.2	7.73	50.4	8.50	53.6	9.32	60.2	10.31	63.0	10.78
	31	34.0	5.28	40.6	6.67	47.2	8.23	50.4	9.05	53.6	9.94	60.2	10.82	62.1	11.20
	33	34.0	5.62	40.6	7.11	47.2	8.78	50.4	9.64	53.6	10.54	60.2	11.34	61.1	11.61
	35	34.0	5.97	40.6	7.54	47.2	9.32	50.4	10.28	53.6	11.18	59.2	12.00	60.2	12.27
	37	34.0	6.33	40.6	8.02	47.2	9.94	50.4	10.93	53.6	11.80	58.2	12.54	59.2	12.82
	39	34.0	6.70	40.6	8.53	47.2	10.52	50.4	11.63	53.6	12.41	57.3	13.22	58.3	13.38
	41	33.1	7.50	39.6	9.46	46.0	11.55	49.1	12.72	52.2	13.40	54.9	13.93	55.8	14.25
	43	32.3	8.10	38.6	10.22	44.9	12.62	47.9	13.69	50.9	14.37	52.6	14.88	53.6	15.10
46	30.3	9.11	36.2	11.64	42.0	14.37	44.9	15.52	46.3	15.96	48.0	16.04	48.9	16.20	
48	26.8	7.96	32.0	10.18	37.2	12.58	39.7	13.53	40.2	13.58	41.7	13.61	42.5	13.72	
80	10	30.2	3.49	36.0	4.19	41.8	4.91	44.8	5.30	47.8	5.69	53.6	6.49	59.4	7.04
	12	30.2	3.56	36.0	4.24	41.8	5.01	44.8	5.40	47.8	5.78	53.6	6.61	59.4	7.18
	14	30.2	3.61	36.0	4.33	41.8	5.08	44.8	5.49	47.8	5.88	53.6	6.73	59.4	7.32
	16	30.2	3.65	36.0	4.41	41.8	5.18	44.8	5.59	47.8	6.00	53.6	6.87	59.4	7.46
	18	30.2	3.73	36.0	4.48	41.8	5.28	44.8	5.69	47.8	6.12	53.6	6.99	59.4	7.62
	20	30.2	3.80	36.0	4.57	41.8	5.40	44.8	5.81	47.8	6.24	53.6	7.26	59.4	8.08
	21	30.2	3.82	36.0	4.62	41.8	5.45	44.8	5.88	47.8	6.39	53.6	7.49	59.4	8.29
	23	30.2	3.90	36.0	4.70	41.8	5.69	44.8	6.24	47.8	6.83	53.6	7.91	59.4	8.70
	25	30.2	4.04	36.0	5.01	41.8	6.10	44.8	6.68	47.8	7.31	53.6	8.46	59.4	9.30
	27	30.2	4.28	36.0	5.32	41.8	6.51	44.8	7.14	47.8	7.79	53.6	8.99	59.4	9.79
	29	30.2	4.55	36.0	5.69	41.8	6.92	44.8	7.60	47.8	8.33	53.6	9.64	59.4	10.24
	31	30.2	4.84	36.0	6.03	41.8	7.38	44.8	8.11	47.8	8.86	53.6	10.23	59.4	10.75
	33	30.2	5.13	36.0	6.44	41.8	7.87	44.8	8.64	47.8	9.44	53.6	10.77	59.4	11.26
	35	30.2	5.45	36.0	6.83	41.8	8.37	44.8	9.20	47.8	10.07	53.6	11.42	58.8	11.90
	37	30.2	5.76	36.0	7.26	41.8	8.88	44.8	9.78	47.8	10.70	53.6	12.06	57.8	12.50
	39	30.2	6.09	36.0	7.67	41.8	9.50	44.8	10.51	47.8	11.50	53.6	12.74	56.9	13.18
	41	29.4	6.73	35.1	8.50	40.7	10.43	43.7	11.52	46.6	12.63	52.2	13.65	54.5	13.97
	43	28.7	7.41	34.2	9.28	39.7	11.38	42.6	12.56	45.4	13.80	50.9	14.58	52.2	14.95
46	26.9	8.25	32.1	10.45	37.2	12.83	39.9	13.98	42.6	15.58	46.6	16.04	47.7	16.20	
48	23.8	7.20	28.4	9.14	32.9	11.22	35.3	12.21	37.7	13.58	40.5	13.61	41.4	13.72	

# 7. Capacity Tables

Cooling Capacity (20HP)

Combination (%)	Outdoor air temp. (DB, °C)	Indoor air temp. (DB/WB, °C)													
		20		23		26		27		28		30		32	
		14		16		18		19		20		22		24	
		TC	PI	TC	PI	TC	PI	TC	PI	TC	PI	TC	PI	TC	PI
70	10	26.4	3.09	31.6	3.68	36.6	4.26	39.2	4.60	41.8	4.92	46.8	5.60	52.0	6.26
	12	26.4	3.14	31.6	3.73	36.6	4.36	39.2	4.67	41.8	5.02	46.8	5.70	52.0	6.38
	14	26.4	3.19	31.6	3.77	36.6	4.43	39.2	4.75	41.8	5.09	46.8	5.82	52.0	6.50
	16	26.4	3.24	31.6	3.85	36.6	4.50	39.2	4.85	41.8	5.19	46.8	5.92	52.0	6.64
	18	26.4	3.29	31.6	3.92	36.6	4.60	39.2	4.94	41.8	5.28	46.8	6.01	52.0	6.76
	20	26.4	3.34	31.6	3.99	36.6	4.67	39.2	5.04	41.8	5.41	46.8	6.16	52.0	7.01
	21	26.4	3.38	31.6	4.02	36.6	4.72	39.2	5.09	41.8	5.45	46.8	6.26	52.0	7.16
	23	26.4	3.43	31.6	4.11	36.6	4.82	39.2	5.26	41.8	5.72	46.8	6.70	52.0	7.56
	25	26.4	3.48	31.6	4.26	36.6	5.14	39.2	5.62	41.8	6.11	46.8	7.16	52.0	7.93
	27	26.4	3.68	31.6	4.55	36.6	5.48	39.2	5.97	41.8	6.53	46.8	7.65	52.0	8.42
	29	26.4	3.92	31.6	4.82	36.6	5.82	39.2	6.36	41.8	6.94	46.8	8.16	52.0	9.03
	31	26.4	4.16	31.6	5.14	36.6	6.21	39.2	6.79	41.8	7.40	46.8	8.69	52.0	9.58
	33	26.4	4.41	31.6	5.43	36.6	6.60	39.2	7.21	41.8	7.86	46.8	9.25	52.0	10.20
	35	26.4	4.65	31.6	5.80	36.6	7.01	39.2	7.67	41.8	8.38	46.8	9.86	52.0	10.81
	37	26.4	4.94	31.6	6.14	36.6	7.45	39.2	8.16	41.8	8.91	46.8	10.49	52.0	11.41
	39	26.4	5.25	31.6	6.54	36.6	7.97	39.2	8.78	41.8	9.63	46.8	11.23	52.0	12.30
	41	25.7	5.80	30.8	7.17	35.7	8.74	38.2	9.63	40.7	10.47	45.6	12.34	50.7	13.27
	43	25.1	6.32	30.0	7.81	34.8	9.54	37.3	10.50	39.7	11.43	44.5	13.48	49.4	14.35
46	23.5	7.02	28.1	8.79	32.6	10.74	34.9	11.69	37.2	12.88	41.7	15.20	46.3	15.99	
48	20.8	6.13	24.9	7.68	28.8	9.39	30.9	10.22	32.9	11.27	36.9	13.30	41.0	13.72	
60	10	22.6	2.69	27.0	3.16	31.4	3.67	33.6	3.94	35.8	4.19	40.2	4.75	44.6	5.32
	12	22.6	2.74	27.0	3.21	31.4	3.72	33.6	3.99	35.8	4.26	40.2	4.83	44.6	5.41
	14	22.6	2.77	27.0	3.26	31.4	3.80	33.6	4.07	35.8	4.34	40.2	4.92	44.6	5.51
	16	22.6	2.82	27.0	3.33	31.4	3.85	33.6	4.14	35.8	4.43	40.2	5.02	44.6	5.61
	18	22.6	2.87	27.0	3.38	31.4	3.92	33.6	4.21	35.8	4.51	40.2	5.09	44.6	5.73
	20	22.6	2.91	27.0	3.43	31.4	3.99	33.6	4.29	35.8	4.58	40.2	5.19	44.6	5.85
	21	22.6	2.94	27.0	3.45	31.4	4.04	33.6	4.34	35.8	4.63	40.2	5.27	44.6	5.90
	23	22.6	2.99	27.0	3.53	31.4	4.09	33.6	4.41	35.8	4.73	40.2	5.46	44.6	6.27
	25	22.6	3.04	27.0	3.60	31.4	4.26	33.6	4.63	35.8	5.02	40.2	5.83	44.6	6.71
	27	22.6	3.14	27.0	3.80	31.4	4.53	33.6	4.92	35.8	5.34	40.2	6.20	44.6	7.15
	29	22.6	3.33	27.0	4.04	31.4	4.83	33.6	5.24	35.8	5.68	40.2	6.61	44.6	7.64
	31	22.6	3.53	27.0	4.29	31.4	5.12	33.6	5.58	35.8	6.05	40.2	7.05	44.6	8.13
	33	22.6	3.72	27.0	4.53	31.4	5.44	33.6	5.93	35.8	6.44	40.2	7.50	44.6	8.67
	35	22.6	3.94	27.0	4.83	31.4	5.78	33.6	6.29	35.8	6.83	40.2	7.99	44.6	9.21
	37	22.6	4.16	27.0	5.09	31.4	6.12	33.6	6.69	35.8	7.25	40.2	8.47	44.6	9.80
	39	22.6	4.43	27.0	5.42	31.4	6.61	33.6	7.17	35.8	7.80	40.2	9.09	44.6	10.50
	41	22.0	4.80	26.3	5.93	30.6	7.18	32.7	7.84	34.9	8.47	39.2	9.97	43.5	11.41
	43	21.5	5.22	25.7	6.46	29.8	7.82	31.9	8.54	34.0	9.24	38.2	10.89	42.4	12.46
46	20.1	5.85	24.0	7.25	28.0	8.80	29.9	9.60	31.9	10.39	35.8	12.27	39.7	14.20	
48	17.8	5.09	21.3	6.33	24.7	7.69	26.5	8.38	28.2	9.08	31.7	10.73	35.1	12.42	
50	10	18.9	2.34	22.6	2.71	26.2	3.08	28.0	3.30	29.8	3.50	33.4	3.94	37.2	4.39
	12	18.9	2.37	22.6	2.73	26.2	3.13	28.0	3.35	29.8	3.57	33.4	4.02	37.2	4.46
	14	18.9	2.39	22.6	2.78	26.2	3.18	28.0	3.40	29.8	3.62	33.4	4.07	37.2	4.53
	16	18.9	2.44	22.6	2.83	26.2	3.23	28.0	3.47	29.8	3.67	33.4	4.14	37.2	4.61
	18	18.9	2.46	22.6	2.86	26.2	3.28	28.0	3.52	29.8	3.75	33.4	4.21	37.2	4.71
	20	18.9	2.49	22.6	2.91	26.2	3.35	28.0	3.57	29.8	3.82	33.4	4.29	37.2	4.80
	21	18.9	2.51	22.6	2.93	26.2	3.38	28.0	3.62	29.8	3.84	33.4	4.34	37.2	4.85
	23	18.9	2.56	22.6	2.98	26.2	3.42	28.0	3.67	29.8	3.92	33.4	4.41	37.2	4.95
	25	18.9	2.59	22.6	3.03	26.2	3.50	28.0	3.75	29.8	4.04	33.4	4.63	37.2	5.30
	27	18.9	2.64	22.6	3.13	26.2	3.70	28.0	3.99	29.8	4.29	33.4	4.95	37.2	5.64
	29	18.9	2.78	22.6	3.33	26.2	3.92	28.0	4.24	29.8	4.56	33.4	5.25	37.2	5.99
	31	18.9	2.93	22.6	3.52	26.2	4.16	28.0	4.48	29.8	4.85	33.4	5.59	37.2	6.38
	33	18.9	3.10	22.6	3.72	26.2	4.41	28.0	4.76	29.8	5.15	33.4	5.94	37.2	6.80
	35	18.9	3.28	22.6	3.94	26.2	4.66	28.0	5.05	29.8	5.45	33.4	6.28	37.2	7.22
	37	18.9	3.47	22.6	4.16	26.2	4.93	28.0	5.35	29.8	5.77	33.4	6.70	37.2	7.66
	39	18.9	3.71	22.6	4.46	26.2	5.28	28.0	5.76	29.8	6.19	33.4	7.14	37.2	8.28
	41	18.4	4.01	22.0	4.83	25.5	5.77	27.3	6.23	29.0	6.70	32.5	7.82	36.2	8.99
	43	18.0	4.35	21.5	5.26	24.9	6.28	26.6	6.79	28.3	7.30	31.7	8.53	35.4	9.80
46	16.8	4.88	20.1	5.89	23.3	7.05	24.9	7.62	26.5	8.19	29.7	9.60	33.1	11.04	
48	14.9	4.25	17.8	5.14	20.6	6.15	22.1	6.65	23.5	7.15	26.3	8.39	29.3	9.65	

**Note**

1. TC: Total Capacity(kW), PI : Power Input(kW, Comp. + Outdoor fan motor)
2. Capacity tables show the average value of conditions which may occur.



# 7. Capacity Tables

## ◆ ARUM220LTE5

Cooling Capacity (22HP)

Combination (%)	Outdoor air temp. (DB, °C)	Indoor air temp. (DB/WB, °C)													
		20		23		26		27		28		30		32	
		14	16	16	18	18	19	19	20	20	22	22	24	24	
		TC	PI	TC	PI	TC	PI	TC	PI	TC	PI	TC	PI	TC	PI
130	10	61.0	6.75	72.7	8.25	77.9	9.57	80.1	9.77	82.3	9.85	86.3	9.93	88.5	9.96
	12	61.0	6.92	72.7	8.55	77.9	9.97	80.1	10.03	82.3	10.11	86.3	10.19	88.5	10.28
	14	61.0	7.15	72.7	8.86	77.9	10.34	80.1	10.42	82.3	10.50	86.3	10.59	88.5	10.68
	16	61.0	7.41	72.7	9.17	77.9	10.81	80.1	10.91	82.3	10.99	86.3	11.09	88.5	11.18
	18	61.0	7.73	72.7	9.70	77.9	11.30	80.1	11.55	82.3	11.64	86.3	11.75	88.5	11.83
	20	61.0	8.07	72.7	10.33	77.9	11.86	80.1	12.70	82.3	12.80	85.1	12.93	87.3	13.02
	21	61.0	8.28	72.7	10.69	77.9	12.11	80.1	13.44	82.3	13.55	84.6	13.68	86.8	13.78
	23	61.0	8.88	72.7	11.25	77.9	12.74	80.1	14.83	81.3	14.95	83.3	15.10	85.6	15.20
	25	61.0	9.49	72.7	11.90	77.9	13.61	79.2	16.45	80.1	16.58	82.3	16.74	84.6	16.86
	27	61.0	10.15	72.7	12.72	76.9	14.50	77.9	18.11	79.2	18.25	81.3	18.43	83.3	18.56
	29	61.0	10.81	72.7	13.60	75.6	15.60	76.7	19.90	77.9	20.02	80.1	20.20	82.3	20.28
	31	61.0	11.54	72.4	14.32	74.4	16.60	75.6	19.82	76.7	19.94	78.9	20.11	81.1	20.19
	33	61.0	12.29	71.2	15.17	73.4	17.80	74.6	19.64	75.6	19.75	77.9	19.93	79.8	20.01
	35	61.0	13.11	69.9	15.89	72.2	19.28	73.4	19.38	74.6	19.50	76.6	19.67	78.9	19.75
	37	61.0	13.98	68.9	16.68	71.2	19.03	72.2	19.12	73.4	19.24	75.4	19.41	77.6	19.49
	39	61.0	14.89	67.7	17.55	69.9	18.77	71.2	18.87	72.2	18.98	74.4	19.15	76.6	19.23
41	59.5	15.79	64.9	18.43	67.1	18.52	68.1	18.61	69.4	18.72	71.5	18.89	73.5	18.97	
43	58.0	16.66	62.2	18.17	64.4	18.26	65.3	18.36	66.6	18.47	68.7	18.63	70.6	18.70	
46	54.3	17.83	56.7	17.79	58.8	17.88	59.7	17.97	61.0	18.08	62.9	18.24	64.6	18.31	
48	48.1	17.33	49.3	17.38	51.1	17.42	51.9	17.47	53.0	17.62	54.7	17.73	56.3	17.80	
120	10	55.2	6.08	65.6	7.45	71.7	8.85	73.9	9.57	76.1	9.72	80.2	9.76	82.2	9.83
	12	55.2	6.24	65.6	7.70	71.7	9.21	73.9	9.77	76.1	10.08	80.2	10.20	82.2	10.28
	14	55.2	6.45	65.6	7.96	71.7	9.58	73.9	10.14	76.1	10.45	80.2	10.60	82.2	10.69
	16	55.2	6.69	65.6	8.29	71.7	9.95	73.9	10.52	76.1	10.93	80.2	11.06	82.2	11.15
	18	55.2	6.95	65.6	8.66	71.7	10.35	73.9	11.07	76.1	11.49	80.2	11.62	82.2	11.71
	20	55.2	7.21	65.6	9.18	71.7	10.91	73.9	11.65	76.1	12.10	80.2	12.26	82.2	12.36
	21	55.2	7.43	65.6	9.52	71.7	11.21	73.9	11.99	76.1	12.50	80.2	12.66	82.2	12.76
	23	55.2	7.94	65.6	10.18	71.7	12.01	73.9	12.75	76.1	13.32	80.2	13.46	82.2	13.57
	25	55.2	8.49	65.6	10.91	71.7	12.67	73.9	13.59	76.1	14.29	79.3	14.41	81.2	14.52
	27	55.2	9.06	65.6	11.66	71.7	13.48	73.9	14.52	76.1	15.35	78.1	15.46	80.0	15.58
	29	55.2	9.67	65.6	12.45	71.7	14.19	73.9	15.53	74.9	16.36	76.8	16.61	79.0	16.74
	31	55.2	10.30	65.6	13.29	71.7	14.92	73.0	16.64	73.9	17.55	75.9	17.87	77.8	18.01
	33	55.2	10.97	65.6	14.17	70.8	15.79	71.7	18.06	72.7	18.85	74.7	19.06	76.6	19.22
	35	55.2	11.66	65.6	15.10	69.6	16.71	70.5	19.90	71.7	20.00	73.7	20.06	75.6	20.22
	37	55.2	12.54	65.6	15.94	68.6	17.81	69.6	19.48	70.5	19.58	72.5	19.64	74.4	19.79
	39	55.2	13.50	65.4	16.85	67.4	18.89	68.3	19.08	69.3	19.18	71.5	19.23	73.4	19.39
41	53.8	14.46	62.6	17.75	64.7	18.52	65.6	18.68	66.5	18.77	68.5	18.83	70.4	18.98	
43	52.5	15.44	59.9	17.50	62.0	18.11	62.9	18.28	63.8	18.37	65.7	18.43	67.6	18.57	
46	49.2	16.60	54.7	17.08	56.6	17.54	57.5	17.68	58.3	17.77	60.1	17.82	61.9	17.96	
48	43.5	16.26	47.5	16.78	49.2	17.19	50.0	17.30	50.7	17.35	52.3	17.42	53.9	17.49	
110	10	49.5	5.46	59.0	6.66	65.9	7.91	67.7	8.56	72.0	9.22	73.7	9.47	78.7	9.63
	12	49.5	5.64	59.0	6.89	65.9	8.24	67.7	8.81	72.0	9.56	73.7	9.87	78.7	10.10
	14	49.5	5.81	59.0	7.20	65.9	8.61	67.7	9.24	72.0	10.04	73.7	10.33	78.7	10.55
	16	49.5	6.02	59.0	7.46	65.9	8.97	67.7	9.65	72.0	10.51	73.7	10.79	78.7	10.98
	18	49.5	6.24	59.0	7.77	65.9	9.49	67.7	10.16	72.0	11.08	73.7	11.30	78.7	11.51
	20	49.5	6.46	59.0	8.16	65.9	10.06	67.7	10.62	72.0	11.62	73.7	11.91	78.7	12.10
	21	49.5	6.61	59.0	8.40	65.9	10.32	67.7	10.91	72.0	11.94	73.7	12.25	78.7	12.44
	23	49.5	7.04	59.0	9.00	65.9	10.89	67.7	11.52	72.0	12.62	73.7	12.89	78.7	13.10
	25	49.5	7.52	59.0	9.61	65.9	11.51	67.7	12.18	72.0	13.33	73.7	13.52	77.7	13.80
	27	49.5	8.04	59.0	10.27	65.9	12.16	67.7	12.89	72.0	13.93	73.7	14.24	76.6	14.49
	29	49.5	8.58	59.0	10.97	65.9	12.85	67.7	13.65	72.0	14.71	73.7	14.97	75.6	15.20
	31	49.5	9.12	59.0	11.69	65.9	13.58	67.7	14.46	70.9	15.46	72.7	15.77	74.4	15.93
	33	49.5	9.73	59.0	12.45	65.9	14.35	67.7	15.32	69.9	16.33	71.6	16.60	73.5	16.69
	35	49.5	10.33	59.0	13.29	65.9	15.15	67.7	16.24	68.7	17.23	70.4	17.39	72.3	17.48
	37	49.5	10.95	59.0	14.11	65.9	16.00	66.8	17.20	67.5	18.18	69.4	18.24	71.1	18.29
	39	49.5	11.80	59.0	14.99	64.7	16.88	65.6	18.40	66.6	19.08	68.2	19.11	70.1	19.13
41	48.2	12.66	57.5	15.87	61.9	17.80	62.9	19.90	63.7	19.90	65.5	20.06	67.2	20.22	
43	47.0	13.29	56.0	16.54	59.3	18.88	60.3	19.09	61.1	19.05	62.9	19.16	64.5	19.21	
46	44.0	12.98	52.5	15.97	54.1	17.91	55.1	17.91	55.8	18.07	57.5	18.17	59.0	18.22	
48	39.0	12.60	45.6	15.38	47.0	17.04	47.9	17.16	48.5	17.24	50.0	17.29	51.3	17.36	

# 7. Capacity Tables

Cooling Capacity (22HP)

Combination (%)	Outdoor air temp. (DB, °C)	Indoor air temp. (DB/WB, °C)													
		20		23		26		27		28		30		32	
		14		16		18		19		20		22		24	
		TC	PI	TC	PI	TC	PI	TC	PI	TC	PI	TC	PI	TC	PI
100	10	41.6	4.92	49.5	5.98	57.6	7.10	61.6	7.67	65.6	8.24	72.7	9.17	74.3	9.24
	12	41.6	5.08	49.5	6.23	57.6	7.34	61.6	7.87	65.6	8.50	72.7	9.66	74.3	9.76
	14	41.6	5.24	49.5	6.47	57.6	7.65	61.6	8.21	65.6	8.87	72.7	10.20	74.3	10.30
	16	41.6	5.40	49.5	6.69	57.6	7.97	61.6	8.60	65.6	9.35	72.7	10.70	74.3	10.85
	18	41.6	5.56	49.5	6.94	57.6	8.28	61.6	9.02	65.6	9.91	72.7	11.30	74.3	11.39
	20	41.6	5.76	49.5	7.20	57.6	8.76	61.6	9.67	65.6	10.60	72.7	11.84	74.3	11.94
	21	41.6	5.87	49.5	7.37	57.6	9.06	61.6	10.00	65.6	11.00	72.7	12.11	74.3	12.21
	23	41.6	6.22	49.5	7.88	57.6	9.73	61.6	10.72	65.6	11.78	72.7	12.68	74.3	12.79
	25	41.6	6.62	49.5	8.40	57.6	10.39	61.6	11.48	65.6	12.60	72.7	13.23	73.7	13.33
	27	41.6	7.07	49.5	8.97	57.6	11.12	61.6	12.26	65.6	13.39	71.3	13.85	72.8	13.96
	29	41.6	7.52	49.5	9.58	57.6	11.87	61.6	13.11	65.6	14.18	69.9	14.41	71.7	14.52
	31	41.6	8.04	49.5	10.21	57.6	12.66	61.6	13.99	65.6	14.89	68.9	14.96	70.6	15.08
	33	41.6	8.52	49.5	10.88	57.6	13.50	61.6	14.92	65.6	15.46	67.8	15.52	69.5	15.64
	35	41.6	9.06	49.5	11.57	57.6	14.38	61.6	15.92	64.6	16.02	66.6	16.08	68.3	16.21
	37	41.6	9.71	49.5	12.41	57.6	15.23	61.6	16.68	63.5	16.76	65.3	16.83	66.9	16.98
	39	41.6	10.41	49.5	13.33	57.6	16.14	61.6	17.49	62.4	17.57	64.3	17.64	65.8	17.80
	41	40.9	11.11	48.7	14.25	56.7	17.05	59.1	18.31	60.4	18.38	61.8	18.45	63.8	18.62
	43	39.5	11.75	47.0	15.11	54.8	17.86	56.7	19.01	57.3	19.08	59.1	19.14	60.6	19.32
46	37.0	12.64	44.1	16.29	51.3	18.95	51.7	19.90	52.3	19.96	54.0	20.02	55.4	20.21	
48	32.8	10.92	39.0	14.09	44.3	16.20	45.0	16.88	45.4	16.94	46.9	16.98	48.2	17.11	
90	10	37.4	4.54	44.7	5.46	51.9	6.43	55.4	6.93	59.0	7.46	66.2	8.35	73.5	9.24
	12	37.4	4.59	44.7	5.54	51.9	6.54	55.4	7.07	59.0	7.63	66.2	8.52	73.5	9.45
	14	37.4	4.68	44.7	5.65	51.9	6.68	55.4	7.21	59.0	7.77	66.2	8.68	73.5	9.64
	16	37.4	4.76	44.7	5.76	51.9	6.82	55.4	7.35	59.0	7.91	66.2	8.85	73.5	9.81
	18	37.4	4.84	44.7	5.87	51.9	6.93	55.4	7.52	59.0	8.07	66.2	9.04	73.5	10.30
	20	37.4	4.93	44.7	5.99	51.9	7.07	55.4	7.66	59.0	8.38	66.2	9.67	73.5	10.79
	21	37.4	4.98	44.7	6.04	51.9	7.21	55.4	7.91	59.0	8.69	66.2	9.83	73.5	11.04
	23	37.4	5.10	44.7	6.29	51.9	7.71	55.4	8.49	59.0	9.30	66.2	10.43	72.5	11.56
	25	37.4	5.35	44.7	6.71	51.9	8.24	55.4	9.08	59.0	9.94	66.2	11.15	71.4	12.06
	27	37.4	5.71	44.7	7.16	51.9	8.80	55.4	9.69	59.0	10.64	66.2	11.85	70.4	12.62
	29	37.4	6.04	44.7	7.63	51.9	9.41	55.4	10.36	59.0	11.36	66.2	12.56	69.3	13.13
	31	37.4	6.43	44.7	8.13	51.9	10.02	55.4	11.03	59.0	12.11	66.2	13.18	68.3	13.64
	33	37.4	6.85	44.7	8.66	51.9	10.69	55.4	11.75	59.0	12.85	66.2	13.82	67.2	14.15
	35	37.4	7.27	44.7	9.19	51.9	11.36	55.4	12.53	59.0	13.62	65.1	14.61	66.2	14.95
	37	37.4	7.71	44.7	9.77	51.9	12.11	55.4	13.31	59.0	14.38	64.0	15.28	65.1	15.62
	39	37.4	8.17	44.7	10.39	51.9	12.82	55.4	14.16	59.0	15.12	63.0	16.10	64.1	16.30
	41	36.4	9.14	43.5	11.52	50.6	14.07	54.0	15.49	57.5	16.32	60.4	16.97	61.4	17.36
	43	35.5	9.86	42.4	12.45	49.3	15.37	52.7	16.68	56.0	17.50	57.9	18.17	58.9	18.39
46	33.3	11.10	39.8	14.18	46.2	17.51	49.4	18.91	50.9	19.45	52.8	19.95	53.8	19.98	
48	29.5	9.70	35.2	12.40	40.9	15.32	43.7	16.50	44.2	16.76	45.9	16.98	46.8	17.11	
80	10	33.2	4.23	39.6	5.08	46.0	5.96	49.3	6.43	52.6	6.90	59.0	7.87	65.3	8.55
	12	33.2	4.32	39.6	5.14	46.0	6.08	49.3	6.55	52.6	7.02	59.0	8.02	65.3	8.71
	14	33.2	4.38	39.6	5.26	46.0	6.17	49.3	6.67	52.6	7.14	59.0	8.16	65.3	8.88
	16	33.2	4.43	39.6	5.34	46.0	6.28	49.3	6.78	52.6	7.28	59.0	8.34	65.3	9.05
	18	33.2	4.52	39.6	5.43	46.0	6.40	49.3	6.90	52.6	7.43	59.0	8.49	65.3	9.25
	20	33.2	4.61	39.6	5.55	46.0	6.55	49.3	7.05	52.6	7.58	59.0	8.81	65.3	9.80
	21	33.2	4.64	39.6	5.61	46.0	6.61	49.3	7.14	52.6	7.75	59.0	9.09	65.3	10.06
	23	33.2	4.73	39.6	5.70	46.0	6.90	49.3	7.58	52.6	8.28	59.0	9.60	65.3	10.56
	25	33.2	4.90	39.6	6.08	46.0	7.40	49.3	8.11	52.6	8.87	59.0	10.27	65.3	11.29
	27	33.2	5.20	39.6	6.46	46.0	7.90	49.3	8.66	52.6	9.46	59.0	10.91	65.3	11.88
	29	33.2	5.52	39.6	6.90	46.0	8.40	49.3	9.22	52.6	10.10	59.0	11.69	65.3	12.47
	31	33.2	5.87	39.6	7.31	46.0	8.96	49.3	9.84	52.6	10.75	59.0	12.41	65.3	13.09
	33	33.2	6.23	39.6	7.81	46.0	9.54	49.3	10.48	52.6	11.45	59.0	13.07	65.3	13.72
	35	33.2	6.61	39.6	8.28	46.0	10.16	49.3	11.16	52.6	12.22	59.0	13.86	64.6	14.50
	37	33.2	6.99	39.6	8.80	46.0	10.78	49.3	11.86	52.6	12.98	59.0	14.63	63.6	15.16
	39	33.2	7.39	39.6	9.31	46.0	11.53	49.3	12.76	52.6	13.95	59.0	15.45	62.6	16.00
	41	32.4	8.17	38.6	10.32	44.8	12.65	48.0	13.98	51.2	15.33	57.5	16.63	59.9	17.01
	43	31.6	9.00	37.6	11.26	43.7	13.81	46.8	15.24	50.0	16.75	56.0	17.81	57.5	18.21
46	29.6	10.01	35.3	12.68	40.9	15.56	43.9	16.96	46.8	18.90	51.2	19.95	52.4	19.98	
48	26.2	8.74	31.2	11.09	36.2	13.61	38.8	14.81	41.4	16.54	44.5	16.98	45.6	17.11	

# 7. Capacity Tables

Cooling Capacity (22HP)

Combination (%)	Outdoor air temp. (DB, °C)	Indoor air temp. (DB/WB, °C)													
		20		23		26		27		28		30		32	
		14		16		18		19		20		22		24	
		TC	PI	TC	PI	TC	PI	TC	PI	TC	PI	TC	PI	TC	PI
70	10	29.0	3.74	34.8	4.44	40.3	5.15	43.1	5.56	46.0	5.94	51.5	6.77	57.2	7.57
	12	29.0	3.80	34.8	4.50	40.3	5.27	43.1	5.65	46.0	6.06	51.5	6.89	57.2	7.71
	14	29.0	3.85	34.8	4.56	40.3	5.36	43.1	5.74	46.0	6.15	51.5	7.03	57.2	7.85
	16	29.0	3.91	34.8	4.65	40.3	5.44	43.1	5.86	46.0	6.27	51.5	7.15	57.2	8.02
	18	29.0	3.97	34.8	4.74	40.3	5.56	43.1	5.97	46.0	6.39	51.5	7.27	57.2	8.16
	20	29.0	4.03	34.8	4.83	40.3	5.65	43.1	6.09	46.0	6.53	51.5	7.45	57.2	8.48
	21	29.0	4.09	34.8	4.86	40.3	5.71	43.1	6.15	46.0	6.59	51.5	7.56	57.2	8.66
	23	29.0	4.15	34.8	4.97	40.3	5.83	43.1	6.36	46.0	6.92	51.5	8.09	57.2	9.14
	25	29.0	4.21	34.8	5.15	40.3	6.21	43.1	6.80	46.0	7.39	51.5	8.65	57.2	9.58
	27	29.0	4.44	34.8	5.50	40.3	6.62	43.1	7.21	46.0	7.89	51.5	9.24	57.2	10.18
	29	29.0	4.74	34.8	5.83	40.3	7.03	43.1	7.68	46.0	8.39	51.5	9.86	57.2	10.91
	31	29.0	5.03	34.8	6.21	40.3	7.50	43.1	8.21	46.0	8.95	51.5	10.51	57.2	11.58
	33	29.0	5.33	34.8	6.56	40.3	7.97	43.1	8.71	46.0	9.51	51.5	11.18	57.2	12.32
	35	29.0	5.62	34.8	7.01	40.3	8.48	43.1	9.27	46.0	10.12	51.5	11.92	57.2	13.07
	37	29.0	5.97	34.8	7.42	40.3	9.00	43.1	9.86	46.0	10.77	51.5	12.68	57.2	13.79
	39	29.0	6.34	34.8	7.91	40.3	9.63	43.1	10.61	46.0	11.63	51.5	13.57	57.2	14.87
41	28.3	7.01	33.9	8.67	39.2	10.56	42.0	11.63	44.8	12.65	50.2	14.91	55.7	16.04	
43	27.6	7.63	33.0	9.44	38.3	11.52	41.0	12.69	43.7	13.81	48.9	16.29	54.4	17.34	
46	25.9	8.48	31.0	10.62	35.9	12.98	38.4	14.13	40.9	15.57	45.8	18.37	50.9	19.33	
48	22.9	7.40	27.4	9.28	31.7	11.35	34.0	12.35	36.2	13.62	40.6	16.08	45.1	16.73	
60	10	24.9	3.24	29.7	3.80	34.5	4.42	37.0	4.75	39.4	5.04	44.2	5.72	49.1	6.40
	12	24.9	3.30	29.7	3.86	34.5	4.48	37.0	4.81	39.4	5.13	44.2	5.81	49.1	6.52
	14	24.9	3.33	29.7	3.92	34.5	4.57	37.0	4.89	39.4	5.22	44.2	5.93	49.1	6.63
	16	24.9	3.39	29.7	4.01	34.5	4.63	37.0	4.98	39.4	5.34	44.2	6.04	49.1	6.75
	18	24.9	3.45	29.7	4.07	34.5	4.72	37.0	5.07	39.4	5.43	44.2	6.13	49.1	6.90
	20	24.9	3.51	29.7	4.13	34.5	4.81	37.0	5.16	39.4	5.51	44.2	6.25	49.1	7.05
	21	24.9	3.54	29.7	4.16	34.5	4.87	37.0	5.22	39.4	5.57	44.2	6.34	49.1	7.11
	23	24.9	3.60	29.7	4.25	34.5	4.92	37.0	5.31	39.4	5.69	44.2	6.58	49.1	7.55
	25	24.9	3.66	29.7	4.33	34.5	5.13	37.0	5.57	39.4	6.04	44.2	7.02	49.1	8.08
	27	24.9	3.77	29.7	4.57	34.5	5.46	37.0	5.93	39.4	6.43	44.2	7.46	49.1	8.61
	29	24.9	4.01	29.7	4.87	34.5	5.81	37.0	6.31	39.4	6.84	44.2	7.96	49.1	9.20
	31	24.9	4.25	29.7	5.16	34.5	6.16	37.0	6.72	39.4	7.28	44.2	8.49	49.1	9.79
	33	24.9	4.48	29.7	5.46	34.5	6.55	37.0	7.14	39.4	7.76	44.2	9.02	49.1	10.44
	35	24.9	4.75	29.7	5.81	34.5	6.96	37.0	7.58	39.4	8.23	44.2	9.61	49.1	11.09
	37	24.9	5.01	29.7	6.13	34.5	7.37	37.0	8.05	39.4	8.73	44.2	10.20	49.1	11.79
	39	24.9	5.33	29.7	6.53	34.5	7.96	37.0	8.64	39.4	9.39	44.2	10.94	49.1	12.64
41	24.2	5.78	28.9	7.14	33.7	8.64	36.0	9.43	38.4	10.20	43.1	12.01	47.8	13.73	
43	23.6	6.28	28.2	7.78	32.8	9.42	35.1	10.28	37.4	11.12	42.0	13.11	46.6	15.00	
46	22.1	7.04	26.5	8.73	30.8	10.59	32.9	11.56	35.1	12.51	39.4	14.77	43.7	17.09	
48	19.6	6.13	23.4	7.62	27.2	9.26	29.1	10.09	31.0	10.93	34.8	12.91	38.7	14.95	
50	10	20.8	2.81	24.9	3.25	28.8	3.69	30.8	3.96	32.8	4.20	36.7	4.73	40.9	5.26
	12	20.8	2.84	24.9	3.28	28.8	3.75	30.8	4.02	32.8	4.28	36.7	4.82	40.9	5.35
	14	20.8	2.87	24.9	3.34	28.8	3.81	30.8	4.08	32.8	4.34	36.7	4.88	40.9	5.44
	16	20.8	2.93	24.9	3.40	28.8	3.87	30.8	4.17	32.8	4.40	36.7	4.96	40.9	5.53
	18	20.8	2.95	24.9	3.43	28.8	3.93	30.8	4.23	32.8	4.49	36.7	5.05	40.9	5.64
	20	20.8	2.98	24.9	3.49	28.8	4.02	30.8	4.28	32.8	4.58	36.7	5.14	40.9	5.76
	21	20.8	3.01	24.9	3.52	28.8	4.05	30.8	4.34	32.8	4.61	36.7	5.20	40.9	5.82
	23	20.8	3.07	24.9	3.58	28.8	4.11	30.8	4.40	32.8	4.70	36.7	5.29	40.9	5.94
	25	20.8	3.10	24.9	3.63	28.8	4.20	30.8	4.49	32.8	4.85	36.7	5.55	40.9	6.35
	27	20.8	3.16	24.9	3.75	28.8	4.43	30.8	4.79	32.8	5.14	36.7	5.94	40.9	6.77
	29	20.8	3.34	24.9	3.99	28.8	4.70	30.8	5.08	32.8	5.47	36.7	6.29	40.9	7.18
	31	20.8	3.52	24.9	4.23	28.8	4.99	30.8	5.38	32.8	5.82	36.7	6.71	40.9	7.65
	33	20.8	3.72	24.9	4.46	28.8	5.29	30.8	5.70	32.8	6.18	36.7	7.12	40.9	8.16
	35	20.8	3.93	24.9	4.73	28.8	5.58	30.8	6.06	32.8	6.53	36.7	7.53	40.9	8.66
	37	20.8	4.17	24.9	4.99	28.8	5.91	30.8	6.41	32.8	6.91	36.7	8.04	40.9	9.19
	39	20.8	4.44	24.9	5.35	28.8	6.33	30.8	6.90	32.8	7.42	36.7	8.56	40.9	9.93
41	20.3	4.81	24.2	5.79	28.1	6.92	30.0	7.48	31.9	8.04	35.8	9.38	39.9	10.78	
43	19.8	5.22	23.6	6.30	27.4	7.53	29.3	8.14	31.2	8.75	34.9	10.23	38.9	11.76	
46	18.5	5.85	22.1	7.07	25.7	8.45	27.4	9.14	29.2	9.82	32.7	11.51	36.4	13.24	
48	16.4	5.10	19.6	6.16	22.7	7.37	24.3	7.98	25.8	8.57	28.9	10.06	32.2	11.57	

**Note**

1. TC: Total Capacity(kW), PI : Power Input(kW, Comp. + Outdoor fan motor)
2. Capacity tables show the average value of conditions which may occur.

# 7. Capacity Tables

## ◆ ARUM240LTE5

Cooling Capacity (24HP)

Combination (%)	Outdoor air temp. (DB, °C)	Indoor air temp. (DB/WB, °C)													
		20		23		26		27		28		30		32	
		14	16	16	18	18	19	19	20	20	22	22	24	24	
		TC	PI	TC	PI	TC	PI	TC	PI	TC	PI	TC	PI	TC	PI
130	10	66.6	7.39	79.3	9.03	85.0	10.47	87.4	10.68	89.8	10.77	94.2	10.85	96.6	10.90
	12	66.6	7.57	79.3	9.35	85.0	10.90	87.4	10.97	89.8	11.06	94.2	11.15	96.6	11.25
	14	66.6	7.82	79.3	9.69	85.0	11.31	87.4	11.39	89.8	11.48	94.2	11.58	96.6	11.68
	16	66.6	8.11	79.3	10.03	85.0	11.82	87.4	11.93	89.8	12.02	94.2	12.13	96.6	12.23
	18	66.6	8.45	79.3	10.60	85.0	12.36	87.4	12.63	89.8	12.73	94.2	12.85	96.6	12.94
	20	66.6	8.82	79.3	11.30	85.0	12.97	87.4	13.89	89.8	14.00	92.8	14.14	95.2	14.24
	21	66.6	9.05	79.3	11.69	85.0	13.24	87.4	14.70	89.8	14.82	92.3	14.96	94.7	15.07
	23	66.6	9.71	79.3	12.30	85.0	13.93	87.4	16.22	88.7	16.35	90.9	16.51	93.3	16.62
	25	66.6	10.37	79.3	13.01	85.0	14.89	86.4	17.99	87.4	18.13	89.8	18.31	92.3	18.44
	27	66.6	11.10	79.3	13.91	83.9	15.86	85.0	19.80	86.4	19.96	88.7	20.16	90.9	20.30
	29	66.6	11.83	79.3	14.87	82.5	17.07	83.7	21.76	85.0	21.89	87.4	22.09	89.8	22.18
	31	66.6	12.62	79.0	15.66	81.2	18.15	82.5	21.67	83.7	21.80	86.0	22.00	88.5	22.08
	33	66.6	13.45	77.6	16.59	80.1	19.47	81.4	21.47	82.5	21.60	85.0	21.80	87.1	21.88
	35	66.6	14.34	76.3	17.38	78.7	21.09	80.1	21.19	81.4	21.32	83.6	21.51	86.0	21.60
	37	66.6	15.29	75.2	18.24	77.6	20.81	78.7	20.91	80.1	21.04	82.3	21.23	84.7	21.31
	39	66.6	16.28	73.9	19.20	76.3	20.53	77.6	20.63	78.7	20.76	81.2	20.94	83.6	21.03
41	64.9	17.27	70.8	20.16	73.2	20.25	74.3	20.35	75.7	20.48	78.0	20.66	80.1	20.74	
43	63.3	18.22	67.9	19.87	70.2	19.97	71.3	20.07	72.7	20.19	74.9	20.37	77.0	20.46	
46	59.3	19.50	61.9	19.46	64.1	19.56	65.1	19.65	66.5	19.77	68.6	19.95	70.5	20.03	
48	52.4	18.95	53.8	19.01	55.8	19.05	56.7	19.10	57.9	19.27	59.7	19.39	61.4	19.47	
120	10	60.2	6.64	71.6	8.15	78.3	9.68	80.6	10.46	83.0	10.63	87.5	10.67	89.7	10.76
	12	60.2	6.82	71.6	8.42	78.3	10.07	80.6	10.68	83.0	11.02	87.5	11.15	89.7	11.24
	14	60.2	7.06	71.6	8.71	78.3	10.48	80.6	11.09	83.0	11.42	87.5	11.59	89.7	11.69
	16	60.2	7.31	71.6	9.06	78.3	10.88	80.6	11.50	83.0	11.95	87.5	12.10	89.7	12.20
	18	60.2	7.60	71.6	9.47	78.3	11.32	80.6	12.11	83.0	12.57	87.5	12.71	89.7	12.81
	20	60.2	7.89	71.6	10.04	78.3	11.93	80.6	12.74	83.0	13.23	87.5	13.41	89.7	13.51
	21	60.2	8.13	71.6	10.41	78.3	12.26	80.6	13.12	83.0	13.67	87.5	13.84	89.7	13.95
	23	60.2	8.69	71.6	11.13	78.3	13.14	80.6	13.94	83.0	14.57	87.5	14.72	89.7	14.84
	25	60.2	9.28	71.6	11.93	78.3	13.86	80.6	14.86	83.0	15.63	86.5	15.76	88.6	15.88
	27	60.2	9.91	71.6	12.75	78.3	14.74	80.6	15.87	83.0	16.79	85.2	16.91	87.3	17.04
	29	60.2	10.57	71.6	13.61	78.3	15.52	80.6	16.99	81.7	17.90	83.8	18.17	86.2	18.31
	31	60.2	11.27	71.6	14.54	78.3	16.32	79.6	18.20	80.6	19.20	82.8	19.54	84.9	19.69
	33	60.2	11.99	71.6	15.49	77.2	17.26	78.3	19.76	79.3	20.61	81.4	20.85	83.6	21.01
	35	60.2	12.75	71.6	16.52	75.9	18.27	76.9	21.76	78.3	21.87	80.4	21.94	82.5	22.11
	37	60.2	13.72	71.6	17.43	74.8	19.48	75.9	21.30	76.9	21.41	79.1	21.48	81.2	21.65
	39	60.2	14.77	71.4	18.42	73.5	20.66	74.5	20.87	75.6	20.97	78.0	21.03	80.1	21.20
41	58.7	15.82	68.2	19.41	70.5	20.25	71.5	20.43	72.6	20.53	74.7	20.59	76.8	20.76	
43	57.2	16.88	65.4	19.14	67.7	19.80	68.6	19.99	69.6	20.09	71.7	20.15	73.8	20.31	
46	53.6	18.15	59.6	18.68	61.8	19.18	62.7	19.34	63.6	19.43	65.6	19.49	67.5	19.64	
48	47.5	17.78	51.8	18.35	53.7	18.80	54.5	18.92	55.3	18.98	57.1	19.05	58.8	19.13	
110	10	54.0	5.98	64.3	7.28	71.9	8.65	73.9	9.37	78.6	10.08	80.4	10.36	85.8	10.53
	12	54.0	6.16	64.3	7.53	71.9	9.01	73.9	9.63	78.6	10.46	80.4	10.79	85.8	11.04
	14	54.0	6.35	64.3	7.87	71.9	9.42	73.9	10.11	78.6	10.98	80.4	11.30	85.8	11.54
	16	54.0	6.58	64.3	8.16	71.9	9.81	73.9	10.55	78.6	11.49	80.4	11.80	85.8	12.01
	18	54.0	6.82	64.3	8.50	71.9	10.37	73.9	11.11	78.6	12.12	80.4	12.36	85.8	12.59
	20	54.0	7.07	64.3	8.92	71.9	11.00	73.9	11.62	78.6	12.71	80.4	13.02	85.8	13.23
	21	54.0	7.23	64.3	9.18	71.9	11.28	73.9	11.93	78.6	13.06	80.4	13.39	85.8	13.60
	23	54.0	7.70	64.3	9.84	71.9	11.91	73.9	12.59	78.6	13.80	80.4	14.10	85.8	14.33
	25	54.0	8.23	64.3	10.51	71.9	12.59	73.9	13.32	78.6	14.58	80.4	14.79	84.8	15.09
	27	54.0	8.79	64.3	11.23	71.9	13.30	73.9	14.09	78.6	15.23	80.4	15.58	83.5	15.84
	29	54.0	9.38	64.3	11.99	71.9	14.06	73.9	14.92	78.6	16.09	80.4	16.37	82.5	16.62
	31	54.0	9.98	64.3	12.78	71.9	14.85	73.9	15.81	77.3	16.91	79.4	17.24	81.2	17.42
	33	54.0	10.64	64.3	13.61	71.9	15.69	73.9	16.76	76.2	17.86	78.1	18.15	80.1	18.25
	35	54.0	11.30	64.3	14.54	71.9	16.57	73.9	17.75	75.0	18.85	76.8	19.02	78.9	19.11
	37	54.0	11.97	64.3	15.43	71.9	17.50	72.9	18.81	73.7	19.88	75.7	19.95	77.6	20.00
	39	54.0	12.91	64.3	16.39	70.5	18.46	71.6	20.12	72.6	20.86	74.4	20.90	76.5	20.92
41	52.6	13.85	62.7	17.36	67.5	19.47	68.6	21.76	69.5	21.76	71.5	21.94	73.3	22.11	
43	51.3	14.54	61.1	18.09	64.7	20.64	65.8	20.88	66.6	20.83	68.6	20.95	70.3	21.01	
46	48.0	14.19	57.3	17.46	59.0	19.59	60.1	19.59	60.9	19.76	62.7	19.87	64.3	19.92	
48	42.5	13.78	49.8	16.82	51.3	18.64	52.2	18.76	52.9	18.86	54.5	18.91	56.0	18.98	

# 7. Capacity Tables

Cooling Capacity (24HP)

Combination (%)	Outdoor air temp. (DB, °C)	Indoor air temp. (DB/WB, °C)													
		20		23		26		27		28		30		32	
		14		16		18		19		20		22		24	
		TC	PI	TC	PI	TC	PI	TC	PI	TC	PI	TC	PI	TC	PI
100	10	45.4	5.38	54.0	6.54	62.9	7.76	67.2	8.38	71.5	9.01	79.3	10.03	81.0	10.11
	12	45.4	5.55	54.0	6.81	62.9	8.02	67.2	8.61	71.5	9.30	79.3	10.57	81.0	10.67
	14	45.4	5.73	54.0	7.08	62.9	8.36	67.2	8.98	71.5	9.70	79.3	11.16	81.0	11.26
	16	45.4	5.90	54.0	7.31	62.9	8.72	67.2	9.41	71.5	10.22	79.3	11.70	81.0	11.86
	18	45.4	6.08	54.0	7.59	62.9	9.06	67.2	9.87	71.5	10.84	79.3	12.36	81.0	12.46
	20	45.4	6.29	54.0	7.87	62.9	9.58	67.2	10.57	71.5	11.60	79.3	12.95	81.0	13.05
	21	45.4	6.42	54.0	8.06	62.9	9.91	67.2	10.93	71.5	12.03	79.3	13.25	81.0	13.35
	23	45.4	6.81	54.0	8.62	62.9	10.64	67.2	11.73	71.5	12.88	79.3	13.87	81.0	13.98
	25	45.4	7.23	54.0	9.18	62.9	11.36	67.2	12.55	71.5	13.78	79.3	14.46	80.4	14.58
	27	45.4	7.73	54.0	9.81	62.9	12.16	67.2	13.41	71.5	14.65	77.8	15.14	79.4	15.26
	29	45.4	8.23	54.0	10.47	62.9	12.98	67.2	14.34	71.5	15.50	76.3	15.75	78.2	15.88
	31	45.4	8.79	54.0	11.17	62.9	13.84	67.2	15.30	71.5	16.29	75.2	16.36	77.0	16.49
	33	45.4	9.32	54.0	11.89	62.9	14.77	67.2	16.32	71.5	16.90	74.0	16.97	75.8	17.11
	35	45.4	9.91	54.0	12.65	62.9	15.73	67.2	17.41	70.4	17.51	72.6	17.58	74.5	17.72
	37	45.4	10.61	54.0	13.57	62.9	16.66	67.2	18.24	69.3	18.33	71.3	18.40	73.0	18.57
	39	45.4	11.38	54.0	14.58	62.9	17.65	67.2	19.13	68.1	19.22	70.1	19.29	71.8	19.47
	41	44.6	12.14	53.1	15.59	61.9	18.65	64.5	20.02	65.9	20.10	67.4	20.17	69.6	20.36
	43	43.1	12.85	51.3	16.52	59.8	19.54	61.8	20.79	62.5	20.86	64.5	20.93	66.2	21.13
46	40.4	13.83	48.1	17.81	56.0	20.72	56.4	21.76	57.1	21.83	58.9	21.89	60.5	22.10	
48	35.7	11.94	42.5	15.41	48.3	17.72	49.1	18.47	49.6	18.53	51.2	18.57	52.6	18.72	
90	10	40.8	4.96	48.7	5.97	56.6	7.03	60.5	7.58	64.3	8.16	72.2	9.13	80.2	10.11
	12	40.8	5.02	48.7	6.06	56.6	7.16	60.5	7.73	64.3	8.34	72.2	9.31	80.2	10.34
	14	40.8	5.12	48.7	6.18	56.6	7.31	60.5	7.89	64.3	8.49	72.2	9.50	80.2	10.55
	16	40.8	5.21	48.7	6.30	56.6	7.46	60.5	8.04	64.3	8.65	72.2	9.68	80.2	10.73
	18	40.8	5.30	48.7	6.42	56.6	7.58	60.5	8.22	64.3	8.83	72.2	9.89	80.2	11.27
	20	40.8	5.39	48.7	6.55	56.6	7.73	60.5	8.37	64.3	9.16	72.2	10.58	80.2	11.81
	21	40.8	5.45	48.7	6.61	56.6	7.89	60.5	8.65	64.3	9.50	72.2	10.75	80.2	12.07
	23	40.8	5.57	48.7	6.88	56.6	8.43	60.5	9.29	64.3	10.17	72.2	11.40	79.1	12.64
	25	40.8	5.85	48.7	7.34	56.6	9.01	60.5	9.93	64.3	10.87	72.2	12.19	77.9	13.18
	27	40.8	6.24	48.7	7.83	56.6	9.62	60.5	10.60	64.3	11.63	72.2	12.96	76.8	13.80
	29	40.8	6.61	48.7	8.34	56.6	10.29	60.5	11.33	64.3	12.42	72.2	13.73	75.6	14.36
	31	40.8	7.03	48.7	8.89	56.6	10.96	60.5	12.06	64.3	13.24	72.2	14.42	74.5	14.92
	33	40.8	7.49	48.7	9.47	56.6	11.69	60.5	12.85	64.3	14.05	72.2	15.11	73.3	15.47
	35	40.8	7.95	48.7	10.05	56.6	12.42	60.5	13.70	64.3	14.90	71.0	15.98	72.2	16.35
	37	40.8	8.43	48.7	10.69	56.6	13.25	60.5	14.56	64.3	15.72	69.9	16.71	71.1	17.08
	39	40.8	8.93	48.7	11.37	56.6	14.02	60.5	15.49	64.3	16.54	68.7	17.61	69.9	17.82
	41	39.8	9.99	47.5	12.60	55.2	15.39	58.9	16.94	62.7	17.85	65.8	18.56	67.0	18.99
	43	38.8	10.79	46.3	13.62	53.8	16.81	57.5	18.24	61.1	19.14	63.1	19.88	64.3	20.12
46	36.3	12.14	43.4	15.51	50.4	19.15	53.9	20.68	55.5	21.27	57.6	21.82	58.7	21.85	
48	32.1	10.61	38.4	13.57	44.6	16.76	47.6	18.04	48.2	18.33	50.1	18.57	51.0	18.72	
80	10	36.2	4.62	43.2	5.56	50.2	6.52	53.8	7.03	57.4	7.55	64.3	8.61	71.3	9.34
	12	36.2	4.72	43.2	5.62	50.2	6.65	53.8	7.16	57.4	7.68	64.3	8.77	71.3	9.53
	14	36.2	4.79	43.2	5.75	50.2	6.74	53.8	7.29	57.4	7.80	64.3	8.93	71.3	9.71
	16	36.2	4.85	43.2	5.85	50.2	6.87	53.8	7.42	57.4	7.96	64.3	9.12	71.3	9.90
	18	36.2	4.95	43.2	5.94	50.2	7.00	53.8	7.55	57.4	8.13	64.3	9.28	71.3	10.12
	20	36.2	5.04	43.2	6.07	50.2	7.16	53.8	7.71	57.4	8.29	64.3	9.63	71.3	10.72
	21	36.2	5.07	43.2	6.13	50.2	7.23	53.8	7.80	57.4	8.48	64.3	9.94	71.3	11.00
	23	36.2	5.17	43.2	6.23	50.2	7.55	53.8	8.29	57.4	9.06	64.3	10.49	71.3	11.55
	25	36.2	5.36	43.2	6.65	50.2	8.09	53.8	8.86	57.4	9.70	64.3	11.23	71.3	12.35
	27	36.2	5.68	43.2	7.07	50.2	8.64	53.8	9.47	57.4	10.34	64.3	11.93	71.3	12.99
	29	36.2	6.04	43.2	7.55	50.2	9.19	53.8	10.08	57.4	11.05	64.3	12.79	71.3	13.64
	31	36.2	6.42	43.2	8.00	50.2	9.80	53.8	10.76	57.4	11.75	64.3	13.57	71.3	14.32
	33	36.2	6.81	43.2	8.54	50.2	10.44	53.8	11.47	57.4	12.53	64.3	14.30	71.3	15.01
	35	36.2	7.23	43.2	9.06	50.2	11.11	53.8	12.20	57.4	13.36	64.3	15.16	70.5	15.86
	37	36.2	7.64	43.2	9.63	50.2	11.79	53.8	12.97	57.4	14.20	64.3	16.00	69.4	16.58
	39	36.2	8.08	43.2	10.18	50.2	12.61	53.8	13.95	57.4	15.25	64.3	16.90	68.2	17.49
	41	35.3	8.94	42.1	11.28	48.9	13.84	52.4	15.29	55.9	16.76	62.7	18.19	65.4	18.61
	43	34.4	9.84	41.1	12.31	47.7	15.10	51.1	16.66	54.5	18.32	61.1	19.48	62.7	19.92
46	32.3	10.94	38.5	13.87	44.7	17.02	47.9	18.55	51.1	20.67	55.9	21.82	57.2	21.85	
48	28.6	9.56	34.0	12.12	39.5	14.88	42.4	16.20	45.2	18.09	48.5	18.57	49.7	18.72	

# 7. Capacity Tables

Cooling Capacity (24HP)

Combination (%)	Outdoor air temp. (DB, °C)	Indoor air temp. (DB/WB, °C)													
		20		23		26		27		28		30		32	
		14		16		18		19		20		22		24	
		TC	PI	TC	PI	TC	PI	TC	PI	TC	PI	TC	PI	TC	PI
70	10	31.7	4.09	37.9	4.86	43.9	5.63	47.0	6.08	50.2	6.50	56.2	7.40	62.4	8.28
	12	31.7	4.15	37.9	4.92	43.9	5.76	47.0	6.18	50.2	6.63	56.2	7.53	62.4	8.43
	14	31.7	4.22	37.9	4.99	43.9	5.86	47.0	6.28	50.2	6.73	56.2	7.69	62.4	8.59
	16	31.7	4.28	37.9	5.08	43.9	5.95	47.0	6.40	50.2	6.85	56.2	7.82	62.4	8.77
	18	31.7	4.34	37.9	5.18	43.9	6.08	47.0	6.53	50.2	6.98	56.2	7.95	62.4	8.93
	20	31.7	4.41	37.9	5.28	43.9	6.18	47.0	6.66	50.2	7.14	56.2	8.14	62.4	9.27
	21	31.7	4.47	37.9	5.31	43.9	6.24	47.0	6.73	50.2	7.21	56.2	8.27	62.4	9.47
	23	31.7	4.54	37.9	5.44	43.9	6.37	47.0	6.95	50.2	7.56	56.2	8.85	62.4	9.99
	25	31.7	4.60	37.9	5.63	43.9	6.79	47.0	7.43	50.2	8.08	56.2	9.46	62.4	10.48
	27	31.7	4.86	37.9	6.02	43.9	7.24	47.0	7.88	50.2	8.62	56.2	10.10	62.4	11.13
	29	31.7	5.18	37.9	6.37	43.9	7.69	47.0	8.40	50.2	9.17	56.2	10.78	62.4	11.93
	31	31.7	5.50	37.9	6.79	43.9	8.21	47.0	8.98	50.2	9.78	56.2	11.49	62.4	12.66
	33	31.7	5.82	37.9	7.18	43.9	8.72	47.0	9.53	50.2	10.39	56.2	12.23	62.4	13.48
	35	31.7	6.15	37.9	7.66	43.9	9.27	47.0	10.14	50.2	11.07	56.2	13.03	62.4	14.29
	37	31.7	6.53	37.9	8.11	43.9	9.85	47.0	10.78	50.2	11.78	56.2	13.87	62.4	15.08
	39	31.7	6.94	37.9	8.65	43.9	10.53	47.0	11.60	50.2	12.72	56.2	14.84	62.4	16.26
41	30.9	7.67	36.9	9.48	42.8	11.55	45.8	12.72	48.9	13.83	54.7	16.30	60.8	17.54	
43	30.1	8.35	36.0	10.33	41.7	12.60	44.7	13.87	47.7	15.10	53.4	17.81	59.3	18.96	
46	28.2	9.28	33.8	11.61	39.1	14.19	41.9	15.45	44.7	17.03	50.0	20.09	55.6	21.14	
48	25.0	8.10	29.9	10.14	34.6	12.41	37.1	13.50	39.5	14.90	44.2	17.58	49.2	18.29	
60	10	27.1	3.55	32.4	4.16	37.7	4.84	40.3	5.19	43.0	5.51	48.2	6.26	53.5	7.00
	12	27.1	3.61	32.4	4.22	37.7	4.90	40.3	5.26	43.0	5.61	48.2	6.35	53.5	7.13
	14	27.1	3.64	32.4	4.29	37.7	5.00	40.3	5.35	43.0	5.71	48.2	6.48	53.5	7.26
	16	27.1	3.71	32.4	4.39	37.7	5.06	40.3	5.45	43.0	5.84	48.2	6.61	53.5	7.38
	18	27.1	3.77	32.4	4.45	37.7	5.16	40.3	5.55	43.0	5.93	48.2	6.71	53.5	7.55
	20	27.1	3.84	32.4	4.51	37.7	5.26	40.3	5.64	43.0	6.03	48.2	6.84	53.5	7.71
	21	27.1	3.87	32.4	4.55	37.7	5.32	40.3	5.71	43.0	6.09	48.2	6.93	53.5	7.77
	23	27.1	3.93	32.4	4.64	37.7	5.39	40.3	5.80	43.0	6.22	48.2	7.19	53.5	8.26
	25	27.1	4.00	32.4	4.74	37.7	5.61	40.3	6.09	43.0	6.61	48.2	7.67	53.5	8.84
	27	27.1	4.13	32.4	5.00	37.7	5.97	40.3	6.48	43.0	7.03	48.2	8.16	53.5	9.42
	29	27.1	4.39	32.4	5.32	37.7	6.35	40.3	6.90	43.0	7.48	48.2	8.71	53.5	10.06
	31	27.1	4.64	32.4	5.64	37.7	6.74	40.3	7.35	43.0	7.97	48.2	9.29	53.5	10.71
	33	27.1	4.90	32.4	5.97	37.7	7.16	40.3	7.80	43.0	8.48	48.2	9.87	53.5	11.42
	35	27.1	5.19	32.4	6.35	37.7	7.61	40.3	8.29	43.0	9.00	48.2	10.51	53.5	12.12
	37	27.1	5.48	32.4	6.70	37.7	8.06	40.3	8.80	43.0	9.55	48.2	11.16	53.5	12.90
	39	27.1	5.83	32.4	7.14	37.7	8.70	40.3	9.45	43.0	10.27	48.2	11.96	53.5	13.82
41	26.4	6.32	31.6	7.81	36.7	9.45	39.3	10.32	41.9	11.15	47.0	13.13	52.2	15.02	
43	25.8	6.87	30.8	8.50	35.8	10.30	38.3	11.24	40.8	12.16	45.8	14.33	50.9	16.41	
46	24.2	7.70	28.9	9.55	33.6	11.59	35.9	12.64	38.3	13.68	43.0	16.15	47.7	18.69	
48	21.4	6.71	25.5	8.33	29.7	10.12	31.8	11.04	33.8	11.96	38.0	14.12	42.2	16.35	
50	10	22.7	3.07	27.1	3.55	31.4	4.04	33.6	4.33	35.8	4.59	40.1	5.17	44.6	5.75
	12	22.7	3.10	27.1	3.59	31.4	4.10	33.6	4.39	35.8	4.69	40.1	5.27	44.6	5.85
	14	22.7	3.13	27.1	3.65	31.4	4.17	33.6	4.46	35.8	4.75	40.1	5.33	44.6	5.95
	16	22.7	3.20	27.1	3.72	31.4	4.23	33.6	4.56	35.8	4.81	40.1	5.43	44.6	6.04
	18	22.7	3.23	27.1	3.75	31.4	4.30	33.6	4.62	35.8	4.91	40.1	5.53	44.6	6.17
	20	22.7	3.26	27.1	3.81	31.4	4.39	33.6	4.69	35.8	5.01	40.1	5.62	44.6	6.30
	21	22.7	3.30	27.1	3.85	31.4	4.43	33.6	4.75	35.8	5.04	40.1	5.69	44.6	6.37
	23	22.7	3.36	27.1	3.91	31.4	4.49	33.6	4.81	35.8	5.14	40.1	5.78	44.6	6.49
	25	22.7	3.39	27.1	3.97	31.4	4.59	33.6	4.91	35.8	5.30	40.1	6.07	44.6	6.95
	27	22.7	3.46	27.1	4.10	31.4	4.85	33.6	5.23	35.8	5.62	40.1	6.49	44.6	7.40
	29	22.7	3.65	27.1	4.36	31.4	5.14	33.6	5.56	35.8	5.98	40.1	6.88	44.6	7.85
	31	22.7	3.85	27.1	4.62	31.4	5.46	33.6	5.88	35.8	6.37	40.1	7.34	44.6	8.37
	33	22.7	4.07	27.1	4.88	31.4	5.78	33.6	6.24	35.8	6.75	40.1	7.79	44.6	8.92
	35	22.7	4.30	27.1	5.17	31.4	6.11	33.6	6.62	35.8	7.14	40.1	8.24	44.6	9.47
	37	22.7	4.56	27.1	5.46	31.4	6.46	33.6	7.01	35.8	7.56	40.1	8.79	44.6	10.05
	39	22.7	4.86	27.1	5.85	31.4	6.92	33.6	7.55	35.8	8.11	40.1	9.36	44.6	10.85
41	22.1	5.26	26.4	6.34	30.6	7.57	32.7	8.17	34.8	8.79	39.1	10.26	43.5	11.79	
43	21.6	5.71	25.8	6.89	29.9	8.24	31.9	8.90	34.0	9.57	38.1	11.19	42.4	12.86	
46	20.2	6.40	24.2	7.73	28.0	9.24	29.9	10.00	31.8	10.74	35.7	12.59	39.8	14.48	
48	17.9	5.57	21.4	6.74	24.8	8.06	26.5	8.72	28.2	9.38	31.6	11.00	35.2	12.65	

**Note**

1. TC: Total Capacity(kW), PI : Power Input(kW, Comp. + Outdoor fan motor)
2. Capacity tables show the average value of conditions which may occur.

# 7. Capacity Tables

## ◆ ARUM260LTE5

Cooling Capacity (26HP)

Combination (%)	Outdoor air temp. (DB, °C)	Indoor air temp. (DB/WB, °C)													
		20		23		26		27		28		30		32	
		14	16	16	18	18	19	19	20	20	22	22	24	24	
		TC	PI	TC	PI	TC	PI	TC	PI	TC	PI	TC	PI	TC	PI
130	10	72.1	8.58	85.9	10.48	92.0	12.16	94.7	12.41	97.3	12.51	102.0	12.61	104.6	12.66
	12	72.1	8.79	85.9	10.86	92.0	12.66	94.7	12.74	97.3	12.84	102.0	12.95	104.6	13.06
	14	72.1	9.08	85.9	11.25	92.0	13.14	94.7	13.23	97.3	13.34	102.0	13.44	104.6	13.56
	16	72.1	9.42	85.9	11.64	92.0	13.73	94.7	13.85	97.3	13.96	102.0	14.09	104.6	14.20
	18	72.1	9.81	85.9	12.32	92.0	14.36	94.7	14.66	97.3	14.78	102.0	14.93	104.6	15.03
	20	72.1	10.24	85.9	13.12	92.0	15.06	94.7	16.13	97.3	16.26	100.5	16.42	103.2	16.54
	21	72.1	10.51	85.9	13.58	92.0	15.38	94.7	17.07	97.3	17.21	100.0	17.38	102.6	17.50
	23	72.1	11.28	85.9	14.29	92.0	16.18	94.7	18.84	96.1	18.99	98.5	19.18	101.1	19.31
	25	72.1	12.05	85.9	15.11	92.0	17.29	93.5	20.89	94.7	21.06	97.3	21.27	100.0	21.41
	27	72.1	12.89	85.9	16.15	90.9	18.42	92.0	23.00	93.5	23.18	96.1	23.41	98.5	23.57
	29	72.1	13.74	85.9	17.27	89.4	19.82	90.7	25.28	92.0	25.43	94.7	25.65	97.3	25.76
	31	72.1	14.66	85.6	18.19	87.9	21.08	89.4	25.17	90.7	25.32	93.2	25.55	95.8	25.65
	33	72.1	15.62	84.1	19.27	86.8	22.61	88.2	24.94	89.4	25.09	92.0	25.31	94.4	25.41
	35	72.1	16.65	82.6	20.18	85.3	24.49	86.8	24.61	88.2	24.76	90.6	24.98	93.2	25.08
	37	72.1	17.76	81.5	21.18	84.1	24.17	85.3	24.29	86.8	24.43	89.1	24.65	91.8	24.75
	39	72.1	18.91	80.0	22.30	82.6	23.84	84.1	23.96	85.3	24.11	87.9	24.32	90.6	24.42
	41	70.3	20.06	76.7	23.41	79.3	23.52	80.5	23.64	82.1	23.78	84.5	23.99	86.8	24.09
	43	68.5	21.16	73.5	23.08	76.1	23.20	77.2	23.31	78.8	23.45	81.2	23.66	83.4	23.76
46	64.2	22.64	67.1	22.60	69.5	22.71	70.6	22.83	72.0	22.96	74.3	23.17	76.4	23.26	
48	56.8	22.01	58.2	22.08	60.4	22.13	61.4	22.19	62.7	22.38	64.7	22.52	66.5	22.61	
120	10	65.2	7.72	77.6	9.46	84.8	11.24	87.4	12.15	89.9	12.34	94.8	12.39	97.1	12.49
	12	65.2	7.93	77.6	9.78	84.8	11.70	87.4	12.41	89.9	12.80	94.8	12.95	97.1	13.06
	14	65.2	8.20	77.6	10.11	84.8	12.17	87.4	12.88	89.9	13.27	94.8	13.46	97.1	13.57
	16	65.2	8.49	77.6	10.53	84.8	12.64	87.4	13.36	89.9	13.88	94.8	14.05	97.1	14.17
	18	65.2	8.83	77.6	11.00	84.8	13.14	87.4	14.06	89.9	14.59	94.8	14.76	97.1	14.88
	20	65.2	9.16	77.6	11.66	84.8	13.85	87.4	14.80	89.9	15.37	94.8	15.57	97.1	15.69
	21	65.2	9.44	77.6	12.09	84.8	14.24	87.4	15.23	89.9	15.87	94.8	16.07	97.1	16.20
	23	65.2	10.09	77.6	12.93	84.8	15.26	87.4	16.19	89.9	16.92	94.8	17.09	97.1	17.23
	25	65.2	10.78	77.6	13.85	84.8	16.09	87.4	17.26	89.9	18.15	93.7	18.30	96.0	18.45
	27	65.2	11.51	77.6	14.81	84.8	17.12	87.4	18.44	89.9	19.50	92.3	19.63	94.6	19.79
	29	65.2	12.28	77.6	15.81	84.8	18.02	87.4	19.73	88.5	20.78	90.8	21.10	93.4	21.27
	31	65.2	13.08	77.6	16.88	84.8	18.95	86.2	21.14	87.4	22.30	89.7	22.69	91.9	22.87
	33	65.2	13.93	77.6	17.99	83.6	20.05	84.8	22.94	85.9	23.94	88.2	24.21	90.5	24.41
	35	65.2	14.81	77.6	19.18	82.2	21.22	83.3	25.28	84.8	25.40	87.1	25.48	89.4	25.68
	37	65.2	15.93	77.6	20.24	81.0	22.62	82.2	24.74	83.3	24.87	85.6	24.94	88.0	25.14
	39	65.2	17.15	77.3	21.40	79.6	24.00	80.8	24.24	81.9	24.36	84.5	24.43	86.8	24.62
	41	63.6	18.37	73.9	22.55	76.4	23.52	77.5	23.73	78.6	23.85	80.9	23.92	83.2	24.11
	43	62.0	19.61	70.8	22.22	73.3	23.00	74.3	23.22	75.4	23.33	77.7	23.40	79.9	23.59
46	58.1	21.08	64.6	21.69	66.9	22.27	67.9	22.46	69.0	22.57	71.0	22.64	73.1	22.82	
48	51.4	20.65	56.1	21.31	58.2	21.84	59.1	21.97	60.0	22.04	61.8	22.13	63.7	22.22	
110	10	58.4	6.94	69.7	8.46	77.8	10.05	80.1	10.88	85.1	11.71	87.1	12.03	93.0	12.23
	12	58.4	7.16	69.7	8.74	77.8	10.47	80.1	11.18	85.1	12.15	87.1	12.54	93.0	12.83
	14	58.4	7.38	69.7	9.14	77.8	10.94	80.1	11.74	85.1	12.76	87.1	13.12	93.0	13.40
	16	58.4	7.64	69.7	9.47	77.8	11.39	80.1	12.25	85.1	13.35	87.1	13.71	93.0	13.95
	18	58.4	7.93	69.7	9.87	77.8	12.05	80.1	12.90	85.1	14.08	87.1	14.36	93.0	14.62
	20	58.4	8.21	69.7	10.36	77.8	12.78	80.1	13.49	85.1	14.76	87.1	15.12	93.0	15.37
	21	58.4	8.39	69.7	10.67	77.8	13.10	80.1	13.85	85.1	15.17	87.1	15.56	93.0	15.80
	23	58.4	8.94	69.7	11.43	77.8	13.84	80.1	14.63	85.1	16.03	87.1	16.37	93.0	16.64
	25	58.4	9.55	69.7	12.20	77.8	14.62	80.1	15.46	85.1	16.93	87.1	17.18	91.9	17.53
	27	58.4	10.21	69.7	13.05	77.8	15.45	80.1	16.37	85.1	17.69	87.1	18.09	90.5	18.40
	29	58.4	10.90	69.7	13.93	77.8	16.32	80.1	17.33	85.1	18.69	87.1	19.01	89.4	19.30
	31	58.4	11.59	69.7	14.85	77.8	17.25	80.1	18.36	83.7	19.64	86.0	20.02	88.0	20.23
	33	58.4	12.35	69.7	15.81	77.8	18.22	80.1	19.46	82.6	20.74	84.6	21.08	86.8	21.20
	35	58.4	13.12	69.7	16.88	77.8	19.25	80.1	20.62	81.2	21.89	83.2	22.09	85.4	22.20
	37	58.4	13.91	69.7	17.92	77.8	20.32	79.0	21.85	79.8	23.09	82.1	23.17	84.0	23.23
	39	58.4	14.99	69.7	19.04	76.4	21.44	77.5	23.37	78.7	24.23	80.6	24.27	82.9	24.29
	41	57.0	16.08	67.9	20.16	73.2	22.61	74.3	25.28	75.3	25.28	77.5	25.48	79.4	25.68
	43	55.5	16.88	66.2	21.01	70.1	23.97	71.3	24.25	72.2	24.19	74.3	24.33	76.2	24.40
46	52.1	16.48	62.1	20.28	64.0	22.75	65.1	22.75	65.9	22.95	67.9	23.08	69.7	23.14	
48	46.0	16.01	53.9	19.54	55.6	21.65	56.6	21.79	57.3	21.90	59.1	21.96	60.6	22.05	

# 7. Capacity Tables

Cooling Capacity (26HP)

Combination (%)	Outdoor air temp. (DB, °C)	Indoor air temp. (DB/WB, °C)													
		20		23		26		27		28		30		32	
		14		16		18		19		20		22		24	
		TC	PI	TC	PI	TC	PI	TC	PI	TC	PI	TC	PI	TC	PI
100	10	49.1	6.25	58.5	7.60	68.1	9.01	72.8	9.74	77.5	10.46	85.9	11.65	87.8	11.74
	12	49.1	6.45	58.5	7.91	68.1	9.32	72.8	10.00	77.5	10.80	85.9	12.27	87.8	12.39
	14	49.1	6.65	58.5	8.22	68.1	9.71	72.8	10.43	77.5	11.26	85.9	12.96	87.8	13.08
	16	49.1	6.85	58.5	8.49	68.1	10.12	72.8	10.93	77.5	11.87	85.9	13.59	87.8	13.78
	18	49.1	7.06	58.5	8.81	68.1	10.52	72.8	11.46	77.5	12.58	85.9	14.35	87.8	14.47
	20	49.1	7.31	58.5	9.14	68.1	11.13	72.8	12.28	77.5	13.47	85.9	15.04	87.8	15.16
	21	49.1	7.46	58.5	9.36	68.1	11.51	72.8	12.70	77.5	13.97	85.9	15.39	87.8	15.51
	23	49.1	7.90	58.5	10.01	68.1	12.35	72.8	13.62	77.5	14.96	85.9	16.11	87.8	16.24
	25	49.1	8.40	58.5	10.67	68.1	13.20	72.8	14.58	77.5	16.00	85.9	16.80	87.0	16.93
	27	49.1	8.98	58.5	11.40	68.1	14.12	72.8	15.58	77.5	17.01	84.2	17.59	86.0	17.73
	29	49.1	9.55	58.5	12.16	68.1	15.08	72.8	16.65	77.5	18.00	82.7	18.30	84.7	18.44
	31	49.1	10.21	58.5	12.97	68.1	16.08	72.8	17.76	77.5	18.92	81.4	19.00	83.4	19.16
	33	49.1	10.82	58.5	13.81	68.1	17.15	72.8	18.95	77.5	19.63	80.1	19.71	82.1	19.87
	35	49.1	11.51	58.5	14.69	68.1	18.26	72.8	20.22	76.3	20.34	78.7	20.42	80.7	20.58
	37	49.1	12.33	58.5	15.76	68.1	19.35	72.8	21.18	75.0	21.29	77.2	21.37	79.0	21.57
	39	49.1	13.22	58.5	16.93	68.1	20.50	72.8	22.22	73.8	22.32	76.0	22.40	77.7	22.61
	41	48.4	14.11	57.6	18.10	67.0	21.65	69.9	23.25	71.4	23.35	73.1	23.43	75.4	23.65
43	46.7	14.93	55.6	19.19	64.7	22.69	67.0	24.14	67.7	24.23	69.8	24.31	71.7	24.54	
46	43.8	16.06	52.1	20.69	60.7	24.07	61.2	25.28	61.8	25.35	63.8	25.42	65.5	25.66	
48	38.7	13.86	46.1	17.90	52.4	20.57	53.1	21.45	53.7	21.52	55.5	21.56	57.0	21.74	
90	10	44.2	5.59	52.8	6.72	61.4	7.92	65.5	8.54	69.7	9.19	78.3	10.29	86.8	11.44
	12	44.2	5.66	52.8	6.82	61.4	8.06	65.5	8.71	69.7	9.40	78.3	10.49	86.8	11.64
	14	44.2	5.76	52.8	6.96	61.4	8.23	65.5	8.88	69.7	9.57	78.3	10.69	86.8	11.88
	16	44.2	5.86	52.8	7.10	61.4	8.40	65.5	9.05	69.7	9.74	78.3	10.90	86.8	12.08
	18	44.2	5.97	52.8	7.24	61.4	8.54	65.5	9.26	69.7	9.94	78.3	11.13	86.8	12.69
	20	44.2	6.07	52.8	7.37	61.4	8.71	65.5	9.43	69.7	10.32	78.3	11.92	86.8	13.29
	21	44.2	6.14	52.8	7.44	61.4	8.88	65.5	9.74	69.7	10.70	78.3	12.11	86.8	13.60
	23	44.2	6.28	52.8	7.75	61.4	9.50	65.5	10.46	69.7	11.45	78.3	12.84	85.6	14.24
	25	44.2	6.58	52.8	8.26	61.4	10.15	65.5	11.18	69.7	12.24	78.3	13.73	84.4	14.85
	27	44.2	7.03	52.8	8.81	61.4	10.84	65.5	11.93	69.7	13.10	78.3	14.60	83.2	15.55
	29	44.2	7.44	52.8	9.40	61.4	11.59	65.5	12.76	69.7	13.99	78.3	15.46	81.9	16.17
	31	44.2	7.92	52.8	10.01	61.4	12.34	65.5	13.58	69.7	14.92	78.3	16.24	80.7	16.80
	33	44.2	8.44	52.8	10.66	61.4	13.17	65.5	14.47	69.7	15.82	78.3	17.02	79.5	17.42
	35	44.2	8.95	52.8	11.32	61.4	13.99	65.5	15.43	69.7	16.78	76.9	18.00	78.2	18.41
	37	44.2	9.50	52.8	12.04	61.4	14.92	65.5	16.39	69.7	17.71	75.7	18.81	77.0	19.24
	39	44.2	10.06	52.8	12.80	61.4	15.79	65.5	17.44	69.7	18.62	74.4	19.83	75.7	20.07
	41	43.1	11.25	51.4	14.19	59.8	17.33	63.8	19.08	67.9	20.11	71.3	20.90	72.6	21.38
43	42.0	12.15	50.2	15.34	58.3	18.93	62.3	20.54	66.2	21.56	68.4	22.38	69.6	22.66	
46	39.4	13.67	47.0	17.47	54.6	21.57	58.4	23.29	60.2	23.95	62.4	24.57	63.6	24.61	
48	34.8	11.95	41.6	15.28	48.3	18.87	51.6	20.32	52.2	20.64	54.3	21.15	55.3	21.18	
80	10	39.3	5.21	46.8	6.26	54.3	7.34	58.2	7.92	62.1	8.50	69.7	9.69	77.2	10.52
	12	39.3	5.32	46.8	6.33	54.3	7.49	58.2	8.07	62.1	8.64	69.7	9.87	77.2	10.73
	14	39.3	5.39	46.8	6.47	54.3	7.60	58.2	8.21	62.1	8.79	69.7	10.05	77.2	10.94
	16	39.3	5.46	46.8	6.58	54.3	7.74	58.2	8.36	62.1	8.97	69.7	10.27	77.2	11.15
	18	39.3	5.57	46.8	6.69	54.3	7.88	58.2	8.50	62.1	9.15	69.7	10.45	77.2	11.39
	20	39.3	5.68	46.8	6.84	54.3	8.07	58.2	8.68	62.1	9.33	69.7	10.85	77.2	12.07
	21	39.3	5.71	46.8	6.91	54.3	8.14	58.2	8.79	62.1	9.55	69.7	11.19	77.2	12.39
	23	39.3	5.82	46.8	7.02	54.3	8.50	58.2	9.33	62.1	10.20	69.7	11.82	77.2	13.00
	25	39.3	6.04	46.8	7.49	54.3	9.11	58.2	9.98	62.1	10.92	69.7	12.65	77.2	13.90
	27	39.3	6.40	46.8	7.96	54.3	9.73	58.2	10.67	62.1	11.65	69.7	13.44	77.2	14.63
	29	39.3	6.80	46.8	8.50	54.3	10.34	58.2	11.36	62.1	12.44	69.7	14.40	77.2	15.36
	31	39.3	7.23	46.8	9.01	54.3	11.03	58.2	12.12	62.1	13.24	69.7	15.28	77.2	16.13
	33	39.3	7.67	46.8	9.62	54.3	11.75	58.2	12.91	62.1	14.11	69.7	16.10	77.2	16.90
	35	39.3	8.14	46.8	10.20	54.3	12.51	58.2	13.74	62.1	15.05	69.7	17.07	76.4	17.86
	37	39.3	8.61	46.8	10.84	54.3	13.27	58.2	14.61	62.1	15.99	69.7	18.02	75.2	18.68
	39	39.3	9.10	46.8	11.47	54.3	14.20	58.2	15.71	62.1	17.18	69.7	19.03	73.9	19.70
	41	38.3	10.06	45.6	12.70	52.9	15.58	56.7	17.22	60.5	18.88	67.9	20.49	70.8	20.96
43	37.3	11.08	44.5	13.86	51.6	17.01	55.3	18.77	59.1	20.63	66.2	21.94	67.9	22.43	
46	35.0	12.33	41.7	15.62	48.4	19.17	51.9	20.89	55.3	23.28	60.6	24.57	62.0	24.61	
48	30.9	10.76	36.9	13.65	42.8	16.76	45.9	18.24	49.0	20.38	52.6	21.15	53.9	21.18	



# 7. Capacity Tables

Cooling Capacity (26HP)

Combination (%)	Outdoor air temp. (DB, °C)	Indoor air temp. (DB/WB, °C)													
		20		23		26		27		28		30		32	
		14		16		18		19		20		22		24	
		TC	PI	TC	PI	TC	PI	TC	PI	TC	PI	TC	PI	TC	PI
70	10	34.3	4.60	41.1	5.47	47.6	6.34	51.0	6.85	54.3	7.32	60.8	8.34	67.6	9.32
	12	34.3	4.68	41.1	5.55	47.6	6.49	51.0	6.96	54.3	7.47	60.8	8.48	67.6	9.50
	14	34.3	4.75	41.1	5.62	47.6	6.60	51.0	7.07	54.3	7.57	60.8	8.66	67.6	9.67
	16	34.3	4.82	41.1	5.73	47.6	6.70	51.0	7.21	54.3	7.72	60.8	8.81	67.6	9.88
	18	34.3	4.89	41.1	5.84	47.6	6.85	51.0	7.36	54.3	7.86	60.8	8.95	67.6	10.06
	20	34.3	4.97	41.1	5.94	47.6	6.96	51.0	7.50	54.3	8.05	60.8	9.17	67.6	10.44
	21	34.3	5.04	41.1	5.98	47.6	7.03	51.0	7.57	54.3	8.12	60.8	9.31	67.6	10.66
	23	34.3	5.11	41.1	6.13	47.6	7.18	51.0	7.83	54.3	8.52	60.8	9.97	67.6	11.25
	25	34.3	5.18	41.1	6.34	47.6	7.65	51.0	8.37	54.3	9.10	60.8	10.66	67.6	11.80
	27	34.3	5.47	41.1	6.78	47.6	8.15	51.0	8.88	54.3	9.71	60.8	11.38	67.6	12.54
	29	34.3	5.84	41.1	7.18	47.6	8.66	51.0	9.46	54.3	10.33	60.8	12.14	67.6	13.44
	31	34.3	6.20	41.1	7.65	47.6	9.24	51.0	10.11	54.3	11.02	60.8	12.94	67.6	14.26
	33	34.3	6.56	41.1	8.08	47.6	9.82	51.0	10.73	54.3	11.71	60.8	13.77	67.6	15.18
	35	34.3	6.92	41.1	8.63	47.6	10.44	51.0	11.42	54.3	12.47	60.8	14.68	67.6	16.09
	37	34.3	7.36	41.1	9.14	47.6	11.09	51.0	12.14	54.3	13.26	60.8	15.62	67.6	16.98
	39	34.3	7.81	41.1	9.74	47.6	11.86	51.0	13.06	54.3	14.33	60.8	16.72	67.6	18.31
	41	33.4	8.64	40.0	10.67	46.4	13.01	49.7	14.33	52.9	15.58	59.3	18.36	65.9	19.75
	43	32.6	9.40	39.0	11.63	45.2	14.19	48.4	15.62	51.6	17.01	57.8	20.06	64.2	21.36
46	30.6	10.45	36.6	13.08	42.4	15.98	45.4	17.40	48.4	19.18	54.2	22.62	60.2	23.80	
48	27.0	9.12	32.4	11.42	37.5	13.97	40.1	15.21	42.8	16.78	47.9	19.80	53.3	20.60	
60	10	29.4	3.99	35.1	4.68	40.8	5.45	43.7	5.85	46.5	6.21	52.3	7.05	58.0	7.88
	12	29.4	4.07	35.1	4.76	40.8	5.52	43.7	5.92	46.5	6.32	52.3	7.15	58.0	8.03
	14	29.4	4.10	35.1	4.83	40.8	5.63	43.7	6.03	46.5	6.43	52.3	7.30	58.0	8.17
	16	29.4	4.18	35.1	4.94	40.8	5.70	43.7	6.14	46.5	6.57	52.3	7.44	58.0	8.32
	18	29.4	4.25	35.1	5.01	40.8	5.81	43.7	6.25	46.5	6.68	52.3	7.55	58.0	8.50
	20	29.4	4.32	35.1	5.08	40.8	5.92	43.7	6.36	46.5	6.79	52.3	7.70	58.0	8.68
	21	29.4	4.36	35.1	5.12	40.8	5.99	43.7	6.43	46.5	6.86	52.3	7.81	58.0	8.75
	23	29.4	4.43	35.1	5.23	40.8	6.06	43.7	6.54	46.5	7.01	52.3	8.10	58.0	9.30
	25	29.4	4.50	35.1	5.34	40.8	6.32	43.7	6.86	46.5	7.44	52.3	8.64	58.0	9.95
	27	29.4	4.65	35.1	5.63	40.8	6.72	43.7	7.30	46.5	7.92	52.3	9.19	58.0	10.60
	29	29.4	4.94	35.1	5.99	40.8	7.15	43.7	7.77	46.5	8.43	52.3	9.81	58.0	11.33
	31	29.4	5.23	35.1	6.36	40.8	7.59	43.7	8.28	46.5	8.97	52.3	10.46	58.0	12.06
	33	29.4	5.52	35.1	6.72	40.8	8.06	43.7	8.79	46.5	9.55	52.3	11.11	58.0	12.86
	35	29.4	5.85	35.1	7.15	40.8	8.57	43.7	9.33	46.5	10.13	52.3	11.84	58.0	13.66
	37	29.4	6.17	35.1	7.55	40.8	9.08	43.7	9.91	46.5	10.75	52.3	12.57	58.0	14.53
	39	29.4	6.57	35.1	8.04	40.8	9.80	43.7	10.64	46.5	11.57	52.3	13.47	58.0	15.57
	41	28.6	7.12	34.2	8.80	39.8	10.64	42.6	11.62	45.3	12.56	50.9	14.79	56.5	16.92
	43	27.9	7.74	33.4	9.58	38.8	11.60	41.5	12.66	44.2	13.69	49.7	16.14	55.1	18.48
46	26.2	8.67	31.3	10.75	36.4	13.05	38.9	14.23	41.4	15.41	46.5	18.19	51.6	21.05	
48	23.1	7.55	27.7	9.39	32.2	11.40	34.4	12.43	36.7	13.47	41.2	15.91	45.7	18.42	
50	10	24.6	3.46	29.4	4.00	34.1	4.55	36.4	4.88	38.7	5.17	43.4	5.82	48.4	6.48
	12	24.6	3.49	29.4	4.04	34.1	4.62	36.4	4.95	38.7	5.28	43.4	5.93	48.4	6.59
	14	24.6	3.53	29.4	4.11	34.1	4.69	36.4	5.02	38.7	5.35	43.4	6.00	48.4	6.70
	16	24.6	3.60	29.4	4.18	34.1	4.77	36.4	5.13	38.7	5.42	43.4	6.11	48.4	6.81
	18	24.6	3.64	29.4	4.22	34.1	4.84	36.4	5.20	38.7	5.53	43.4	6.22	48.4	6.95
	20	24.6	3.68	29.4	4.29	34.1	4.95	36.4	5.28	38.7	5.64	43.4	6.33	48.4	7.10
	21	24.6	3.71	29.4	4.33	34.1	4.99	36.4	5.35	38.7	5.68	43.4	6.40	48.4	7.17
	23	24.6	3.78	29.4	4.40	34.1	5.06	36.4	5.42	38.7	5.79	43.4	6.51	48.4	7.31
	25	24.6	3.82	29.4	4.48	34.1	5.17	36.4	5.53	38.7	5.97	43.4	6.84	48.4	7.82
	27	24.6	3.89	29.4	4.62	34.1	5.46	36.4	5.90	38.7	6.33	43.4	7.31	48.4	8.33
	29	24.6	4.11	29.4	4.91	34.1	5.79	36.4	6.26	38.7	6.73	43.4	7.75	48.4	8.84
	31	24.6	4.33	29.4	5.20	34.1	6.15	36.4	6.62	38.7	7.17	43.4	8.26	48.4	9.43
	33	24.6	4.59	29.4	5.50	34.1	6.51	36.4	7.02	38.7	7.61	43.4	8.77	48.4	10.04
	35	24.6	4.84	29.4	5.82	34.1	6.88	36.4	7.46	38.7	8.04	43.4	9.28	48.4	10.66
	37	24.6	5.13	29.4	6.15	34.1	7.28	36.4	7.90	38.7	8.52	43.4	9.90	48.4	11.32
	39	24.6	5.47	29.4	6.59	34.1	7.80	36.4	8.50	38.7	9.14	43.4	10.54	48.4	12.22
	41	23.9	5.92	28.6	7.14	33.2	8.53	35.5	9.21	37.7	9.90	42.3	11.56	47.1	13.27
	43	23.3	6.43	27.9	7.76	32.4	9.28	34.6	10.02	36.8	10.78	41.3	12.60	46.0	14.48
46	21.9	7.20	26.2	8.71	30.3	10.41	32.4	11.26	34.5	12.10	38.7	14.18	43.1	16.30	
48	19.4	6.28	23.1	7.59	26.8	9.08	28.7	9.83	30.5	10.56	34.2	12.39	38.1	14.25	

**Note**

1. TC: Total Capacity(kW), PI : Power Input(kW, Comp. + Outdoor fan motor)
2. Capacity tables show the average value of conditions which may occur.

# 7. Capacity Tables

◆ ARUM221LTE5

Cooling Capacity (22HP)

Combination (%)	Outdoor air temp. (DB, °C)	Indoor air temp. (DB/WB, °C)													
		20		23		26		27		28		30		32	
		14	16	16	18	19	20	22	24	22	24	24	24		
		TC	PI	TC	PI	TC	PI	TC	PI	TC	PI	TC	PI	TC	PI
130	10	61.0	6.17	72.7	7.54	77.9	8.74	80.1	8.92	82.3	8.99	86.3	9.07	88.5	9.10
	12	61.0	6.32	72.7	7.81	77.9	9.10	80.1	9.16	82.3	9.24	86.3	9.31	88.5	9.39
	14	61.0	6.53	72.7	8.09	77.9	9.45	80.1	9.52	82.3	9.59	86.3	9.67	88.5	9.75
	16	61.0	6.77	72.7	8.37	77.9	9.87	80.1	9.96	82.3	10.04	86.3	10.13	88.5	10.21
	18	61.0	7.06	72.7	8.86	77.9	10.32	80.1	10.55	82.3	10.63	86.3	10.74	88.5	10.81
	20	61.0	7.37	72.7	9.44	77.9	10.83	80.1	11.60	82.3	11.69	85.1	11.81	87.3	11.89
	21	61.0	7.56	72.7	9.77	77.9	11.06	80.1	12.28	82.3	12.37	84.6	12.50	86.8	12.58
	23	61.0	8.11	72.7	10.27	77.9	11.63	80.1	13.55	81.3	13.65	83.3	13.79	85.6	13.88
	25	61.0	8.66	72.7	10.87	77.9	12.43	79.2	15.02	80.1	15.14	82.3	15.29	84.6	15.40
	27	61.0	9.27	72.7	11.61	76.9	13.25	77.9	16.54	79.2	16.67	81.3	16.84	83.3	16.95
	29	61.0	9.88	72.7	12.42	75.6	14.25	76.7	18.18	77.9	18.28	80.1	18.45	82.3	18.52
	31	61.0	10.54	72.4	13.08	74.4	15.16	75.6	18.10	76.7	18.21	78.9	18.37	81.1	18.44
	33	61.0	11.23	71.2	13.86	73.4	16.26	74.6	17.93	75.6	18.04	77.9	18.20	79.8	18.27
	35	61.0	11.97	69.9	14.51	72.2	17.61	73.4	17.70	74.6	17.81	76.6	17.97	78.9	18.04
	37	61.0	12.77	68.9	15.23	71.2	17.38	72.2	17.47	73.4	17.57	75.4	17.73	77.6	17.80
	39	61.0	13.60	67.7	16.03	69.9	17.15	71.2	17.23	72.2	17.34	74.4	17.49	76.6	17.56
	41	59.5	14.42	64.9	16.83	67.1	16.91	68.1	17.00	69.4	17.10	71.5	17.25	73.5	17.32
	43	58.0	15.21	62.2	16.60	64.4	16.68	65.3	16.76	66.6	16.87	68.7	17.02	70.6	17.08
46	54.3	16.28	56.7	16.25	58.8	16.33	59.7	16.41	61.0	16.51	62.9	16.66	64.6	16.73	
48	48.1	15.83	49.3	15.88	51.1	15.91	51.9	15.95	53.0	16.09	54.7	16.19	56.3	16.26	
120	10	55.2	5.55	65.6	6.80	71.7	8.08	73.9	8.74	76.1	8.88	80.2	8.91	82.2	8.98
	12	55.2	5.70	65.6	7.03	71.7	8.41	73.9	8.92	76.1	9.20	80.2	9.32	82.2	9.39
	14	55.2	5.89	65.6	7.27	71.7	8.75	73.9	9.26	76.1	9.54	80.2	9.68	82.2	9.76
	16	55.2	6.11	65.6	7.57	71.7	9.09	73.9	9.61	76.1	9.98	80.2	10.11	82.2	10.19
	18	55.2	6.35	65.6	7.91	71.7	9.45	73.9	10.11	76.1	10.49	80.2	10.61	82.2	10.70
	20	55.2	6.59	65.6	8.39	71.7	9.96	73.9	10.64	76.1	11.05	80.2	11.20	82.2	11.29
	21	55.2	6.79	65.6	8.69	71.7	10.24	73.9	10.95	76.1	11.41	80.2	11.56	82.2	11.65
	23	55.2	7.26	65.6	9.30	71.7	10.97	73.9	11.64	76.1	12.17	80.2	12.29	82.2	12.39
	25	55.2	7.75	65.6	9.96	71.7	11.57	73.9	12.41	76.1	13.05	79.3	13.16	81.2	13.26
	27	55.2	8.28	65.6	10.65	71.7	12.31	73.9	13.26	76.1	14.02	78.1	14.12	80.0	14.23
	29	55.2	8.83	65.6	11.37	71.7	12.96	73.9	14.19	74.9	14.95	76.8	15.17	79.0	15.29
	31	55.2	9.41	65.6	12.14	71.7	13.63	73.0	15.20	73.9	16.03	75.9	16.32	77.8	16.45
	33	55.2	10.02	65.6	12.94	70.8	14.42	71.7	16.50	72.7	17.21	74.7	17.41	76.6	17.55
	35	55.2	10.65	65.6	13.80	69.6	15.26	70.5	18.18	71.7	18.27	73.7	18.32	75.6	18.47
	37	55.2	11.46	65.6	14.56	68.6	16.27	69.6	17.79	70.5	17.88	72.5	17.94	74.4	18.08
	39	55.2	12.33	65.4	15.39	67.4	17.26	68.3	17.43	69.3	17.51	71.5	17.57	73.4	17.71
	41	53.8	13.21	62.6	16.21	64.7	16.92	65.6	17.06	66.5	17.15	68.5	17.20	70.4	17.33
	43	52.5	14.10	59.9	15.98	62.0	16.54	62.9	16.70	63.8	16.78	65.7	16.83	67.6	16.96
46	49.2	15.16	54.7	15.60	56.6	16.02	57.5	16.15	58.3	16.23	60.1	16.28	61.9	16.41	
48	43.5	14.85	47.5	15.32	49.2	15.70	50.0	15.80	50.7	15.85	52.3	15.91	53.9	15.98	
110	10	49.5	4.99	59.0	6.08	65.9	7.23	67.7	7.82	72.0	8.42	73.7	8.65	78.7	8.80
	12	49.5	5.15	59.0	6.29	65.9	7.53	67.7	8.04	72.0	8.73	73.7	9.01	78.7	9.22
	14	49.5	5.31	59.0	6.57	65.9	7.87	67.7	8.44	72.0	9.17	73.7	9.43	78.7	9.63
	16	49.5	5.50	59.0	6.81	65.9	8.19	67.7	8.81	72.0	9.60	73.7	9.86	78.7	10.03
	18	49.5	5.70	59.0	7.09	65.9	8.66	67.7	9.28	72.0	10.12	73.7	10.32	78.7	10.52
	20	49.5	5.90	59.0	7.45	65.9	9.19	67.7	9.70	72.0	10.61	73.7	10.88	78.7	11.05
	21	49.5	6.03	59.0	7.67	65.9	9.42	67.7	9.96	72.0	10.91	73.7	11.19	78.7	11.36
	23	49.5	6.43	59.0	8.22	65.9	9.95	67.7	10.52	72.0	11.53	73.7	11.77	78.7	11.97
	25	49.5	6.87	59.0	8.77	65.9	10.51	67.7	11.12	72.0	12.18	73.7	12.35	77.7	12.60
	27	49.5	7.34	59.0	9.38	65.9	11.11	67.7	11.77	72.0	12.72	73.7	13.01	76.6	13.23
	29	49.5	7.84	59.0	10.02	65.9	11.74	67.7	12.46	72.0	13.44	73.7	13.67	75.6	13.88
	31	49.5	8.33	59.0	10.68	65.9	12.40	67.7	13.21	70.9	14.12	72.7	14.40	74.4	14.55
	33	49.5	8.88	59.0	11.37	65.9	13.10	67.7	13.99	69.9	14.91	71.6	15.16	73.5	15.25
	35	49.5	9.44	59.0	12.14	65.9	13.84	67.7	14.83	68.7	15.74	70.4	15.88	72.3	15.96
	37	49.5	10.00	59.0	12.88	65.9	14.61	66.8	15.71	67.5	16.60	69.4	16.66	71.1	16.71
	39	49.5	10.78	59.0	13.69	64.7	15.42	65.6	16.80	66.6	17.42	68.2	17.45	70.1	17.47
	41	48.2	11.56	57.5	14.50	61.9	16.26	62.9	18.18	63.7	18.18	65.5	18.32	67.2	18.47
	43	47.0	12.14	56.0	15.10	59.3	17.24	60.3	17.43	61.1	17.40	62.9	17.50	64.5	17.54
46	44.0	11.85	52.5	14.58	54.1	16.36	55.1	16.36	55.8	16.50	57.5	16.59	59.0	16.64	
48	39.0	11.51	45.6	14.05	47.0	15.57	47.9	15.67	48.5	15.75	50.0	15.79	51.3	15.85	

# 7. Capacity Tables

Cooling Capacity (22HP)

Combination (%)	Outdoor air temp. (DB, °C)	Indoor air temp. (DB/WB, °C)													
		20		23		26		27		28		30		32	
		14		16		18		19		20		22		24	
		TC	PI	TC	PI	TC	PI	TC	PI	TC	PI	TC	PI	TC	PI
100	10	41.6	4.49	49.5	5.46	57.6	6.48	61.6	7.00	65.6	7.52	72.7	8.38	74.3	8.44
	12	41.6	4.64	49.5	5.69	57.6	6.70	61.6	7.19	65.6	7.76	72.7	8.83	74.3	8.91
	14	41.6	4.78	49.5	5.91	57.6	6.98	61.6	7.50	65.6	8.10	72.7	9.32	74.3	9.41
	16	41.6	4.93	49.5	6.11	57.6	7.28	61.6	7.86	65.6	8.53	72.7	9.77	74.3	9.91
	18	41.6	5.07	49.5	6.34	57.6	7.56	61.6	8.24	65.6	9.05	72.7	10.32	74.3	10.40
	20	41.6	5.26	49.5	6.58	57.6	8.00	61.6	8.83	65.6	9.68	72.7	10.82	74.3	10.90
	21	41.6	5.37	49.5	6.73	57.6	8.28	61.6	9.13	65.6	10.04	72.7	11.06	74.3	11.15
	23	41.6	5.68	49.5	7.20	57.6	8.88	61.6	9.79	65.6	10.76	72.7	11.58	74.3	11.68
	25	41.6	6.04	49.5	7.67	57.6	9.49	61.6	10.48	65.6	11.51	72.7	12.08	73.7	12.18
	27	41.6	6.46	49.5	8.19	57.6	10.15	61.6	11.20	65.6	12.23	71.3	12.65	72.8	12.75
	29	41.6	6.87	49.5	8.75	57.6	10.84	61.6	11.97	65.6	12.95	69.9	13.16	71.7	13.26
	31	41.6	7.34	49.5	9.33	57.6	11.56	61.6	12.77	65.6	13.60	68.9	13.67	70.6	13.78
	33	41.6	7.78	49.5	9.93	57.6	12.33	61.6	13.63	65.6	14.12	67.8	14.18	69.5	14.29
	35	41.6	8.28	49.5	10.57	57.6	13.13	61.6	14.54	64.6	14.63	66.6	14.68	68.3	14.80
	37	41.6	8.86	49.5	11.33	57.6	13.91	61.6	15.23	63.5	15.31	65.3	15.37	66.9	15.51
	39	41.6	9.50	49.5	12.18	57.6	14.74	61.6	15.98	62.4	16.05	64.3	16.11	65.8	16.26
	41	40.9	10.14	48.7	13.02	56.7	15.57	59.1	16.72	60.4	16.79	61.8	16.85	63.8	17.00
	43	39.5	10.73	47.0	13.80	54.8	16.32	56.7	17.36	57.3	17.42	59.1	17.48	60.6	17.64
46	37.0	11.55	44.1	14.88	51.3	17.31	51.7	18.18	52.3	18.23	54.0	18.28	55.4	18.45	
48	32.8	9.97	39.0	12.87	44.3	14.79	45.0	15.42	45.4	15.47	46.9	15.51	48.2	15.63	
90	10	37.4	4.19	44.7	5.03	51.9	5.93	55.4	6.40	59.0	6.88	66.2	7.70	73.5	8.44
	12	37.4	4.24	44.7	5.11	51.9	6.04	55.4	6.52	59.0	7.04	66.2	7.86	73.5	8.72
	14	37.4	4.32	44.7	5.21	51.9	6.16	55.4	6.65	59.0	7.17	66.2	8.01	73.5	8.90
	16	37.4	4.39	44.7	5.32	51.9	6.29	55.4	6.78	59.0	7.29	66.2	8.16	73.5	9.05
	18	37.4	4.47	44.7	5.42	51.9	6.40	55.4	6.94	59.0	7.45	66.2	8.34	73.5	9.50
	20	37.4	4.55	44.7	5.52	51.9	6.52	55.4	7.06	59.0	7.73	66.2	8.93	73.5	9.96
	21	37.4	4.60	44.7	5.57	51.9	6.65	55.4	7.29	59.0	8.01	66.2	9.07	73.5	10.19
	23	37.4	4.70	44.7	5.80	51.9	7.11	55.4	7.83	59.0	8.58	66.2	9.62	72.5	10.67
	25	37.4	4.93	44.7	6.19	51.9	7.60	55.4	8.37	59.0	9.17	66.2	10.29	71.4	11.12
	27	37.4	5.27	44.7	6.60	51.9	8.12	55.4	8.94	59.0	9.81	66.2	10.94	70.4	11.64
	29	37.4	5.57	44.7	7.04	51.9	8.68	55.4	9.55	59.0	10.48	66.2	11.58	69.3	12.11
	31	37.4	5.93	44.7	7.50	51.9	9.25	55.4	10.17	59.0	11.17	66.2	12.16	68.3	12.58
	33	37.4	6.32	44.7	7.99	51.9	9.86	55.4	10.84	59.0	11.85	66.2	12.75	67.2	13.05
	35	37.4	6.70	44.7	8.48	51.9	10.48	55.4	11.56	59.0	12.57	65.1	13.48	66.2	13.79
	37	37.4	7.11	44.7	9.02	51.9	11.17	55.4	12.28	59.0	13.27	64.0	14.09	65.1	14.41
	39	37.4	7.53	44.7	9.59	51.9	11.83	55.4	13.07	59.0	13.95	63.0	14.86	64.1	15.04
	41	36.4	8.43	43.5	10.63	50.6	12.98	54.0	14.29	57.5	15.06	60.4	15.66	61.4	16.02
	43	35.5	9.10	42.4	11.49	49.3	14.18	52.7	15.39	56.0	16.15	57.9	16.77	58.9	16.97
46	33.3	10.24	39.8	13.08	46.2	16.15	49.4	17.45	50.9	17.94	52.8	18.28	53.8	18.43	
48	29.5	8.95	35.2	11.44	40.9	14.13	43.7	15.22	44.2	15.46	45.9	15.51	46.8	15.63	
80	10	33.2	3.90	39.6	4.69	46.0	5.50	49.3	5.93	52.6	6.37	59.0	7.26	65.3	7.88
	12	33.2	3.98	39.6	4.74	46.0	5.61	49.3	6.04	52.6	6.48	59.0	7.40	65.3	8.04
	14	33.2	4.04	39.6	4.85	46.0	5.69	49.3	6.15	52.6	6.58	59.0	7.53	65.3	8.20
	16	33.2	4.09	39.6	4.93	46.0	5.80	49.3	6.26	52.6	6.72	59.0	7.69	65.3	8.35
	18	33.2	4.17	39.6	5.01	46.0	5.91	49.3	6.37	52.6	6.85	59.0	7.83	65.3	8.53
	20	33.2	4.25	39.6	5.12	46.0	6.04	49.3	6.50	52.6	6.99	59.0	8.13	65.3	9.04
	21	33.2	4.28	39.6	5.17	46.0	6.10	49.3	6.58	52.6	7.15	59.0	8.38	65.3	9.28
	23	33.2	4.36	39.6	5.26	46.0	6.37	49.3	6.99	52.6	7.64	59.0	8.85	65.3	9.74
	25	33.2	4.52	39.6	5.61	46.0	6.83	49.3	7.48	52.6	8.18	59.0	9.47	65.3	10.42
	27	33.2	4.80	39.6	5.96	46.0	7.29	49.3	7.99	52.6	8.72	59.0	10.07	65.3	10.96
	29	33.2	5.09	39.6	6.37	46.0	7.75	49.3	8.51	52.6	9.32	59.0	10.79	65.3	11.51
	31	33.2	5.42	39.6	6.75	46.0	8.26	49.3	9.08	52.6	9.92	59.0	11.45	65.3	12.08
	33	33.2	5.74	39.6	7.21	46.0	8.81	49.3	9.67	52.6	10.57	59.0	12.06	65.3	12.66
	35	33.2	6.10	39.6	7.64	46.0	9.37	49.3	10.30	52.6	11.27	59.0	12.79	64.6	13.38
	37	33.2	6.45	39.6	8.12	46.0	9.94	49.3	10.95	52.6	11.97	59.0	13.50	63.6	13.99
	39	33.2	6.81	39.6	8.59	46.0	10.64	49.3	11.77	52.6	12.87	59.0	14.26	62.6	14.76
	41	32.4	7.54	38.6	9.52	44.8	11.67	48.0	12.90	51.2	14.14	57.5	15.34	59.9	15.70
	43	31.6	8.30	37.6	10.39	43.7	12.74	46.8	14.06	50.0	15.45	56.0	16.43	57.5	16.80
46	29.6	9.23	35.3	11.70	40.9	14.36	43.9	15.65	46.8	17.44	51.2	18.28	52.4	18.43	
48	26.2	8.06	31.2	10.23	36.2	12.56	38.8	13.67	41.4	15.26	44.5	15.51	45.6	15.63	

# 7. Capacity Tables

Cooling Capacity (22HP)

Combination (%)	Outdoor air temp. (DB, °C)	Indoor air temp. (DB/WB, °C)													
		20		23		26		27		28		30		32	
		14		16		18		19		20		22		24	
		TC	PI	TC	PI	TC	PI	TC	PI	TC	PI	TC	PI	TC	PI
70	10	29.0	3.45	34.8	4.10	40.3	4.75	43.1	5.13	46.0	5.48	51.5	6.24	57.2	6.98
	12	29.0	3.50	34.8	4.15	40.3	4.86	43.1	5.21	46.0	5.59	51.5	6.35	57.2	7.11
	14	29.0	3.56	34.8	4.21	40.3	4.94	43.1	5.29	46.0	5.67	51.5	6.49	57.2	7.25
	16	29.0	3.61	34.8	4.29	40.3	5.02	43.1	5.40	46.0	5.78	51.5	6.60	57.2	7.40
	18	29.0	3.66	34.8	4.37	40.3	5.13	43.1	5.51	46.0	5.89	51.5	6.71	57.2	7.53
	20	29.0	3.72	34.8	4.45	40.3	5.21	43.1	5.62	46.0	6.03	51.5	6.87	57.2	7.82
	21	29.0	3.77	34.8	4.48	40.3	5.27	43.1	5.67	46.0	6.08	51.5	6.98	57.2	7.98
	23	29.0	3.83	34.8	4.59	40.3	5.38	43.1	5.86	46.0	6.38	51.5	7.47	57.2	8.43
	25	29.0	3.88	34.8	4.75	40.3	5.73	43.1	6.27	46.0	6.81	51.5	7.98	57.2	8.84
	27	29.0	4.10	34.8	5.08	40.3	6.11	43.1	6.65	46.0	7.28	51.5	8.52	57.2	9.39
	29	29.0	4.37	34.8	5.38	40.3	6.49	43.1	7.09	46.0	7.74	51.5	9.09	57.2	10.06
	31	29.0	4.64	34.8	5.73	40.3	6.92	43.1	7.57	46.0	8.25	51.5	9.69	57.2	10.68
	33	29.0	4.91	34.8	6.05	40.3	7.36	43.1	8.04	46.0	8.77	51.5	10.32	57.2	11.37
	35	29.0	5.19	34.8	6.46	40.3	7.82	43.1	8.55	46.0	9.34	51.5	10.99	57.2	12.05
	37	29.0	5.51	34.8	6.84	40.3	8.31	43.1	9.09	46.0	9.94	51.5	11.70	57.2	12.72
	39	29.0	5.85	34.8	7.30	40.3	8.88	43.1	9.78	46.0	10.73	51.5	12.52	57.2	13.72
	41	28.3	6.47	33.9	7.99	39.2	9.74	42.0	10.73	44.8	11.67	50.2	13.75	55.7	14.80
	43	27.6	7.04	33.0	8.71	38.3	10.63	41.0	11.70	43.7	12.74	48.9	15.03	54.4	16.00
46	25.9	7.83	31.0	9.80	35.9	11.97	38.4	13.04	40.9	14.36	45.8	16.95	50.9	17.83	
48	22.9	6.83	27.4	8.56	31.7	10.47	34.0	11.39	36.2	12.57	40.6	14.83	45.1	15.43	
60	10	24.9	2.99	29.7	3.51	34.5	4.08	37.0	4.38	39.4	4.65	44.2	5.28	49.1	5.90
	12	24.9	3.05	29.7	3.56	34.5	4.13	37.0	4.43	39.4	4.73	44.2	5.36	49.1	6.01
	14	24.9	3.07	29.7	3.62	34.5	4.22	37.0	4.52	39.4	4.81	44.2	5.47	49.1	6.12
	16	24.9	3.13	29.7	3.70	34.5	4.27	37.0	4.60	39.4	4.92	44.2	5.58	49.1	6.23
	18	24.9	3.18	29.7	3.75	34.5	4.35	37.0	4.68	39.4	5.01	44.2	5.66	49.1	6.37
	20	24.9	3.24	29.7	3.81	34.5	4.43	37.0	4.76	39.4	5.09	44.2	5.77	49.1	6.50
	21	24.9	3.26	29.7	3.84	34.5	4.49	37.0	4.81	39.4	5.14	44.2	5.85	49.1	6.56
	23	24.9	3.32	29.7	3.92	34.5	4.54	37.0	4.90	39.4	5.25	44.2	6.07	49.1	6.96
	25	24.9	3.37	29.7	4.00	34.5	4.73	37.0	5.14	39.4	5.58	44.2	6.47	49.1	7.45
	27	24.9	3.48	29.7	4.22	34.5	5.03	37.0	5.47	39.4	5.93	44.2	6.88	49.1	7.94
	29	24.9	3.70	29.7	4.49	34.5	5.36	37.0	5.82	39.4	6.31	44.2	7.34	49.1	8.49
	31	24.9	3.92	29.7	4.76	34.5	5.69	37.0	6.20	39.4	6.72	44.2	7.83	49.1	9.03
	33	24.9	4.13	29.7	5.03	34.5	6.04	37.0	6.58	39.4	7.15	44.2	8.32	49.1	9.63
	35	24.9	4.38	29.7	5.36	34.5	6.42	37.0	6.99	39.4	7.59	44.2	8.87	49.1	10.23
	37	24.9	4.62	29.7	5.66	34.5	6.80	37.0	7.43	39.4	8.05	44.2	9.41	49.1	10.88
	39	24.9	4.92	29.7	6.02	34.5	7.34	37.0	7.97	39.4	8.67	44.2	10.09	49.1	11.66
	41	24.2	5.33	28.9	6.59	33.7	7.97	36.0	8.70	38.4	9.41	43.1	11.08	47.8	12.67
	43	23.6	5.80	28.2	7.17	32.8	8.69	35.1	9.48	37.4	10.26	42.0	12.09	46.6	13.84
46	22.1	6.49	26.5	8.06	30.8	9.77	32.9	10.66	35.1	11.54	39.4	13.62	43.7	15.77	
48	19.6	5.66	23.4	7.03	27.2	8.54	29.1	9.31	31.0	10.09	34.8	11.91	38.7	13.80	
50	10	20.8	2.59	24.9	3.00	28.8	3.41	30.8	3.65	32.8	3.87	36.7	4.36	40.9	4.85
	12	20.8	2.62	24.9	3.03	28.8	3.46	30.8	3.71	32.8	3.95	36.7	4.44	40.9	4.93
	14	20.8	2.64	24.9	3.08	28.8	3.52	30.8	3.76	32.8	4.01	36.7	4.50	40.9	5.02
	16	20.8	2.70	24.9	3.13	28.8	3.57	30.8	3.84	32.8	4.06	36.7	4.58	40.9	5.10
	18	20.8	2.73	24.9	3.16	28.8	3.63	30.8	3.90	32.8	4.14	36.7	4.66	40.9	5.21
	20	20.8	2.75	24.9	3.22	28.8	3.71	30.8	3.95	32.8	4.23	36.7	4.74	40.9	5.32
	21	20.8	2.78	24.9	3.24	28.8	3.73	30.8	4.01	32.8	4.25	36.7	4.80	40.9	5.37
	23	20.8	2.83	24.9	3.30	28.8	3.79	30.8	4.06	32.8	4.33	36.7	4.88	40.9	5.48
	25	20.8	2.86	24.9	3.35	28.8	3.87	30.8	4.14	32.8	4.47	36.7	5.12	40.9	5.86
	27	20.8	2.92	24.9	3.46	28.8	4.09	30.8	4.42	32.8	4.74	36.7	5.48	40.9	6.24
	29	20.8	3.08	24.9	3.68	28.8	4.33	30.8	4.69	32.8	5.04	36.7	5.81	40.9	6.62
	31	20.8	3.24	24.9	3.90	28.8	4.61	30.8	4.96	32.8	5.37	36.7	6.19	40.9	7.06
	33	20.8	3.43	24.9	4.12	28.8	4.88	30.8	5.26	32.8	5.70	36.7	6.57	40.9	7.52
	35	20.8	3.63	24.9	4.36	28.8	5.15	30.8	5.59	32.8	6.02	36.7	6.95	40.9	7.99
	37	20.8	3.84	24.9	4.61	28.8	5.45	30.8	5.92	32.8	6.38	36.7	7.41	40.9	8.48
	39	20.8	4.10	24.9	4.94	28.8	5.84	30.8	6.37	32.8	6.84	36.7	7.90	40.9	9.16
	41	20.3	4.43	24.2	5.35	28.1	6.39	30.0	6.90	31.9	7.42	35.8	8.66	39.9	9.94
	43	19.8	4.82	23.6	5.81	27.4	6.95	29.3	7.51	31.2	8.07	34.9	9.44	38.9	10.85
46	18.5	5.40	22.1	6.52	25.7	7.80	27.4	8.43	29.2	9.06	32.7	10.62	36.4	12.21	
48	16.4	4.70	19.6	5.69	22.7	6.80	24.3	7.36	25.8	7.91	28.9	9.28	32.2	10.67	

**Note**

1. TC: Total Capacity(kW), PI : Power Input(kW, Comp. + Outdoor fan motor)
2. Capacity tables show the average value of conditions which may occur.

# 7. Capacity Tables

◆ ARUM241LTE5

Cooling Capacity (24HP)

Combination (%)	Outdoor air temp. (DB, °C)	Indoor air temp. (DB/WB, °C)													
		20		23		26		27		28		30		32	
		14	16	18	19	20	22	24	TC	PI	TC	PI			
130	10	66.6	6.54	79.3	7.99	85.0	9.27	87.4	9.46	89.8	9.54	94.2	9.61	96.6	9.65
	12	66.6	6.70	79.3	8.28	85.0	9.65	87.4	9.72	89.8	9.80	94.2	9.87	96.6	9.96
	14	66.6	6.93	79.3	8.58	85.0	10.02	87.4	10.09	89.8	10.17	94.2	10.25	96.6	10.34
	16	66.6	7.18	79.3	8.88	85.0	10.47	87.4	10.56	89.8	10.65	94.2	10.74	96.6	10.83
	18	66.6	7.48	79.3	9.39	85.0	10.95	87.4	11.18	89.8	11.27	94.2	11.38	96.6	11.46
	20	66.6	7.81	79.3	10.01	85.0	11.49	87.4	12.30	89.8	12.40	92.8	12.52	95.2	12.61
	21	66.6	8.02	79.3	10.36	85.0	11.73	87.4	13.02	89.8	13.12	92.3	13.25	94.7	13.34
	23	66.6	8.60	79.3	10.90	85.0	12.34	87.4	14.37	88.7	14.48	90.9	14.62	93.3	14.72
	25	66.6	9.19	79.3	11.52	85.0	13.18	86.4	15.93	87.4	16.06	89.8	16.22	92.3	16.33
	27	66.6	9.83	79.3	12.32	83.9	14.05	85.0	17.54	86.4	17.68	88.7	17.85	90.9	17.98
	29	66.6	10.48	79.3	13.17	82.5	15.11	83.7	19.28	85.0	19.39	87.4	19.56	89.8	19.64
	31	66.6	11.18	79.0	13.87	81.2	16.08	82.5	19.19	83.7	19.31	86.0	19.48	88.5	19.56
	33	66.6	11.91	77.6	14.70	80.1	17.24	81.4	19.02	82.5	19.13	85.0	19.30	87.1	19.38
	35	66.6	12.70	76.3	15.39	78.7	18.68	80.1	18.77	81.4	18.88	83.6	19.05	86.0	19.13
	37	66.6	13.54	75.2	16.15	77.6	18.43	78.7	18.52	80.1	18.63	82.3	18.80	84.7	18.88
	39	66.6	14.42	73.9	17.00	76.3	18.18	77.6	18.28	78.7	18.38	81.2	18.55	83.6	18.62
	41	64.9	15.30	70.8	17.85	73.2	17.94	74.3	18.03	75.7	18.14	78.0	18.30	80.1	18.37
	43	63.3	16.13	67.9	17.60	70.2	17.69	71.3	17.78	72.7	17.89	74.9	18.05	77.0	18.12
46	59.3	17.27	61.9	17.23	64.1	17.32	65.1	17.41	66.5	17.51	68.6	17.67	70.5	17.74	
48	52.4	16.79	53.8	16.84	55.8	16.87	56.7	16.92	57.9	17.07	59.7	17.17	61.4	17.24	
120	10	60.2	5.88	71.6	7.22	78.3	8.57	80.6	9.27	83.0	9.41	87.5	9.45	89.7	9.53
	12	60.2	6.04	71.6	7.46	78.3	8.92	80.6	9.46	83.0	9.76	87.5	9.88	89.7	9.96
	14	60.2	6.25	71.6	7.71	78.3	9.28	80.6	9.82	83.0	10.12	87.5	10.27	89.7	10.35
	16	60.2	6.48	71.6	8.03	78.3	9.64	80.6	10.19	83.0	10.59	87.5	10.72	89.7	10.80
	18	60.2	6.73	71.6	8.39	78.3	10.02	80.6	10.72	83.0	11.13	87.5	11.26	89.7	11.35
	20	60.2	6.99	71.6	8.90	78.3	10.56	80.6	11.29	83.0	11.72	87.5	11.87	89.7	11.97
	21	60.2	7.20	71.6	9.22	78.3	10.86	80.6	11.62	83.0	12.10	87.5	12.26	89.7	12.36
	23	60.2	7.70	71.6	9.86	78.3	11.64	80.6	12.35	83.0	12.90	87.5	13.04	89.7	13.14
	25	60.2	8.22	71.6	10.56	78.3	12.27	80.6	13.16	83.0	13.84	86.5	13.96	88.6	14.07
	27	60.2	8.78	71.6	11.29	78.3	13.06	80.6	14.06	83.0	14.87	85.2	14.97	87.3	15.09
	29	60.2	9.36	71.6	12.06	78.3	13.74	80.6	15.05	81.7	15.85	83.8	16.09	86.2	16.22
	31	60.2	9.98	71.6	12.87	78.3	14.45	79.6	16.12	80.6	17.00	82.8	17.30	84.9	17.44
	33	60.2	10.62	71.6	13.72	77.2	15.29	78.3	17.50	79.3	18.26	81.4	18.46	83.6	18.61
	35	60.2	11.29	71.6	14.63	75.9	16.18	76.9	19.28	78.3	19.37	80.4	19.43	82.5	19.58
	37	60.2	12.15	71.6	15.44	74.8	17.25	75.9	18.87	76.9	18.96	79.1	19.02	81.2	19.17
	39	60.2	13.08	71.4	16.32	73.5	18.30	74.5	18.48	75.6	18.57	78.0	18.63	80.1	18.78
	41	58.7	14.01	68.2	17.19	70.5	17.94	71.5	18.09	72.6	18.18	74.7	18.24	76.8	18.38
	43	57.2	14.95	65.4	16.95	67.7	17.54	68.6	17.71	69.6	17.80	71.7	17.85	73.8	17.99
46	53.6	16.08	59.6	16.54	61.8	16.99	62.7	17.13	63.6	17.21	65.6	17.26	67.5	17.40	
48	47.5	15.75	51.8	16.25	53.7	16.65	54.5	16.76	55.3	16.81	57.1	16.88	58.8	16.94	
110	10	54.0	5.29	64.3	6.45	71.9	7.66	73.9	8.30	78.6	8.93	80.4	9.17	85.8	9.33
	12	54.0	5.46	64.3	6.67	71.9	7.98	73.9	8.53	78.6	9.26	80.4	9.56	85.8	9.78
	14	54.0	5.63	64.3	6.97	71.9	8.34	73.9	8.95	78.6	9.73	80.4	10.01	85.8	10.22
	16	54.0	5.83	64.3	7.22	71.9	8.69	73.9	9.34	78.6	10.18	80.4	10.45	85.8	10.64
	18	54.0	6.04	64.3	7.52	71.9	9.19	73.9	9.84	78.6	10.74	80.4	10.95	85.8	11.15
	20	54.0	6.26	64.3	7.90	71.9	9.74	73.9	10.29	78.6	11.26	80.4	11.53	85.8	11.72
	21	54.0	6.40	64.3	8.13	71.9	9.99	73.9	10.57	78.6	11.57	80.4	11.86	85.8	12.05
	23	54.0	6.82	64.3	8.72	71.9	10.55	73.9	11.15	78.6	12.22	80.4	12.49	85.8	12.69
	25	54.0	7.29	64.3	9.30	71.9	11.15	73.9	11.79	78.6	12.91	80.4	13.10	84.8	13.37
	27	54.0	7.78	64.3	9.95	71.9	11.78	73.9	12.48	78.6	13.49	80.4	13.80	83.5	14.03
	29	54.0	8.31	64.3	10.62	71.9	12.45	73.9	13.22	78.6	14.25	80.4	14.50	82.5	14.72
	31	54.0	8.84	64.3	11.32	71.9	13.15	73.9	14.00	77.3	14.98	79.4	15.27	81.2	15.43
	33	54.0	9.42	64.3	12.06	71.9	13.90	73.9	14.84	76.2	15.82	78.1	16.08	80.1	16.17
	35	54.0	10.01	64.3	12.87	71.9	14.68	73.9	15.73	75.0	16.69	76.8	16.85	78.9	16.93
	37	54.0	10.61	64.3	13.66	71.9	15.50	72.9	16.66	73.7	17.61	75.7	17.67	77.6	17.72
	39	54.0	11.43	64.3	14.52	70.5	16.35	71.6	17.82	72.6	18.48	74.4	18.51	76.5	18.53
	41	52.6	12.26	62.7	15.38	67.5	17.24	68.6	19.28	69.5	19.28	71.5	19.43	73.3	19.58
	43	51.3	12.88	61.1	16.02	64.7	18.28	65.8	18.49	66.6	18.45	68.6	18.55	70.3	18.61
46	48.0	12.57	57.3	15.46	59.0	17.35	60.1	17.35	60.9	17.50	62.7	17.60	64.3	17.65	
48	42.5	12.21	49.8	14.90	51.3	16.51	52.2	16.62	52.9	16.70	54.5	16.75	56.0	16.81	

# 7. Capacity Tables

Cooling Capacity (24HP)

Combination (%)	Outdoor air temp. (DB, °C)	Indoor air temp. (DB/WB, °C)													
		20		23		26		27		28		30		32	
		14	16	18	19	20	22	24	TC	PI	TC	PI	TC	PI	
100	10	45.4	4.77	54.0	5.79	62.9	6.87	67.2	7.43	71.5	7.98	79.3	8.88	81.0	8.95
	12	45.4	4.92	54.0	6.03	62.9	7.10	67.2	7.63	71.5	8.23	79.3	9.36	81.0	9.45
	14	45.4	5.07	54.0	6.27	62.9	7.41	67.2	7.96	71.5	8.59	79.3	9.88	81.0	9.98
	16	45.4	5.23	54.0	6.48	62.9	7.72	67.2	8.33	71.5	9.05	79.3	10.36	81.0	10.51
	18	45.4	5.38	54.0	6.72	62.9	8.02	67.2	8.74	71.5	9.60	79.3	10.95	81.0	11.03
	20	45.4	5.57	54.0	6.97	62.9	8.49	67.2	9.36	71.5	10.27	79.3	11.47	81.0	11.56
	21	45.4	5.69	54.0	7.14	62.9	8.78	67.2	9.69	71.5	10.65	79.3	11.73	81.0	11.83
	23	45.4	6.03	54.0	7.64	62.9	9.42	67.2	10.39	71.5	11.41	79.3	12.29	81.0	12.38
	25	45.4	6.41	54.0	8.13	62.9	10.07	67.2	11.12	71.5	12.20	79.3	12.81	80.4	12.91
	27	45.4	6.85	54.0	8.69	62.9	10.77	67.2	11.88	71.5	12.97	77.8	13.41	79.4	13.52
	29	45.4	7.29	54.0	9.28	62.9	11.50	67.2	12.70	71.5	13.73	76.3	13.95	78.2	14.06
	31	45.4	7.78	54.0	9.89	62.9	12.26	67.2	13.55	71.5	14.43	75.2	14.49	77.0	14.61
	33	45.4	8.25	54.0	10.53	62.9	13.08	67.2	14.45	71.5	14.97	74.0	15.03	75.8	15.15
	35	45.4	8.78	54.0	11.21	62.9	13.93	67.2	15.42	70.4	15.51	72.6	15.57	74.5	15.70
	37	45.4	9.40	54.0	12.02	62.9	14.75	67.2	16.15	69.3	16.23	71.3	16.30	73.0	16.45
	39	45.4	10.08	54.0	12.91	62.9	15.63	67.2	16.94	68.1	17.02	70.1	17.08	71.8	17.24
	41	44.6	10.76	53.1	13.80	61.9	16.51	64.5	17.73	65.9	17.80	67.4	17.87	69.6	18.03
	43	43.1	11.38	51.3	14.63	59.8	17.30	61.8	18.41	62.5	18.48	64.5	18.54	66.2	18.71
46	40.4	12.25	48.1	15.78	56.0	18.35	56.4	19.28	57.1	19.33	58.9	19.39	60.5	19.57	
48	35.7	10.57	42.5	13.65	48.3	15.69	49.1	16.35	49.6	16.41	51.2	16.44	52.6	16.58	
90	10	40.8	4.44	48.7	5.34	56.6	6.29	60.5	6.78	64.3	7.30	72.2	8.17	80.2	8.95
	12	40.8	4.49	48.7	5.42	56.6	6.40	60.5	6.92	64.3	7.46	72.2	8.33	80.2	9.25
	14	40.8	4.58	48.7	5.53	56.6	6.54	60.5	7.06	64.3	7.60	72.2	8.49	80.2	9.44
	16	40.8	4.66	48.7	5.64	56.6	6.67	60.5	7.19	64.3	7.74	72.2	8.66	80.2	9.60
	18	40.8	4.74	48.7	5.75	56.6	6.78	60.5	7.35	64.3	7.90	72.2	8.85	80.2	10.08
	20	40.8	4.82	48.7	5.86	56.6	6.92	60.5	7.49	64.3	8.20	72.2	9.47	80.2	10.56
	21	40.8	4.88	48.7	5.91	56.6	7.06	60.5	7.74	64.3	8.50	72.2	9.62	80.2	10.80
	23	40.8	4.98	48.7	6.16	56.6	7.55	60.5	8.31	64.3	9.10	72.2	10.20	79.1	11.31
	25	40.8	5.23	48.7	6.56	56.6	8.06	60.5	8.88	64.3	9.72	72.2	10.91	77.9	11.79
	27	40.8	5.58	48.7	7.00	56.6	8.61	60.5	9.48	64.3	10.41	72.2	11.60	76.8	12.35
	29	40.8	5.91	48.7	7.46	56.6	9.21	60.5	10.13	64.3	11.11	72.2	12.28	75.6	12.85
	31	40.8	6.29	48.7	7.95	56.6	9.81	60.5	10.79	64.3	11.85	72.2	12.90	74.5	13.34
	33	40.8	6.70	48.7	8.47	56.6	10.46	60.5	11.50	64.3	12.57	72.2	13.52	73.3	13.84
	35	40.8	7.11	48.7	8.99	56.6	11.11	60.5	12.26	64.3	13.33	71.0	14.30	72.2	14.63
	37	40.8	7.55	48.7	9.56	56.6	11.85	60.5	13.02	64.3	14.07	69.9	14.95	71.1	15.28
	39	40.8	7.99	48.7	10.17	56.6	12.54	60.5	13.86	64.3	14.79	68.7	15.76	69.9	15.95
	41	39.8	8.94	47.5	11.27	55.2	13.77	58.9	15.15	62.7	15.97	65.8	16.61	67.0	16.99
	43	38.8	9.65	46.3	12.18	53.8	15.04	57.5	16.32	61.1	17.12	63.1	17.78	64.3	18.00
46	36.3	10.86	43.4	13.87	50.4	17.13	53.9	18.50	55.5	19.03	57.6	19.39	58.7	19.55	
48	32.1	9.49	38.4	12.14	44.6	14.99	47.6	16.14	48.2	16.39	50.1	16.44	51.0	16.58	
80	10	36.2	4.14	43.2	4.97	50.2	5.83	53.8	6.29	57.4	6.75	64.3	7.70	71.3	8.36
	12	36.2	4.22	43.2	5.03	50.2	5.95	53.8	6.41	57.4	6.87	64.3	7.84	71.3	8.53
	14	36.2	4.28	43.2	5.14	50.2	6.03	53.8	6.52	57.4	6.98	64.3	7.99	71.3	8.69
	16	36.2	4.34	43.2	5.23	50.2	6.15	53.8	6.64	57.4	7.13	64.3	8.16	71.3	8.86
	18	36.2	4.42	43.2	5.32	50.2	6.26	53.8	6.75	57.4	7.27	64.3	8.30	71.3	9.05
	20	36.2	4.51	43.2	5.43	50.2	6.41	53.8	6.90	57.4	7.41	64.3	8.62	71.3	9.59
	21	36.2	4.54	43.2	5.49	50.2	6.46	53.8	6.98	57.4	7.59	64.3	8.89	71.3	9.84
	23	36.2	4.63	43.2	5.57	50.2	6.75	53.8	7.41	57.4	8.10	64.3	9.39	71.3	10.33
	25	36.2	4.80	43.2	5.95	50.2	7.24	53.8	7.93	57.4	8.68	64.3	10.05	71.3	11.05
	27	36.2	5.09	43.2	6.32	50.2	7.73	53.8	8.48	57.4	9.25	64.3	10.68	71.3	11.62
	29	36.2	5.40	43.2	6.75	50.2	8.22	53.8	9.02	57.4	9.88	64.3	11.44	71.3	12.20
	31	36.2	5.75	43.2	7.15	50.2	8.76	53.8	9.63	57.4	10.52	64.3	12.14	71.3	12.81
	33	36.2	6.09	43.2	7.64	50.2	9.34	53.8	10.26	57.4	11.21	64.3	12.79	71.3	13.43
	35	36.2	6.46	43.2	8.10	50.2	9.94	53.8	10.92	57.4	11.95	64.3	13.56	70.5	14.19
	37	36.2	6.84	43.2	8.61	50.2	10.54	53.8	11.61	57.4	12.70	64.3	14.31	69.4	14.84
	39	36.2	7.23	43.2	9.11	50.2	11.28	53.8	12.48	57.4	13.65	64.3	15.12	68.2	15.65
	41	35.3	7.99	42.1	10.09	48.9	12.38	52.4	13.68	55.9	15.00	62.7	16.27	65.4	16.65
	43	34.4	8.80	41.1	11.01	47.7	13.51	51.1	14.91	54.5	16.39	61.1	17.43	62.7	17.82
46	32.3	9.79	38.5	12.41	44.7	15.23	47.9	16.59	51.1	18.49	55.9	19.39	57.2	19.55	
48	28.6	8.55	34.0	10.85	39.5	13.32	42.4	14.49	45.2	16.19	48.5	16.44	49.7	16.58	

# 7. Capacity Tables

Cooling Capacity (24HP)

Combination (%)	Outdoor air temp. (DB, °C)	Indoor air temp. (DB/WB, °C)													
		20		23		26		27		28		30		32	
		14		16		18		19		20		22		24	
		TC	PI	TC	PI	TC	PI	TC	PI	TC	PI	TC	PI	TC	PI
70	10	31.7	3.66	37.9	4.35	43.9	5.04	47.0	5.44	50.2	5.82	56.2	6.62	62.4	7.41
	12	31.7	3.71	37.9	4.41	43.9	5.15	47.0	5.53	50.2	5.93	56.2	6.74	62.4	7.55
	14	31.7	3.77	37.9	4.46	43.9	5.24	47.0	5.61	50.2	6.02	56.2	6.88	62.4	7.68
	16	31.7	3.83	37.9	4.55	43.9	5.33	47.0	5.73	50.2	6.13	56.2	7.00	62.4	7.85
	18	31.7	3.89	37.9	4.64	43.9	5.44	47.0	5.84	50.2	6.25	56.2	7.11	62.4	7.99
	20	31.7	3.94	37.9	4.72	43.9	5.53	47.0	5.96	50.2	6.39	56.2	7.28	62.4	8.29
	21	31.7	4.00	37.9	4.75	43.9	5.59	47.0	6.02	50.2	6.45	56.2	7.40	62.4	8.47
	23	31.7	4.06	37.9	4.87	43.9	5.70	47.0	6.22	50.2	6.77	56.2	7.92	62.4	8.94
	25	31.7	4.12	37.9	5.04	43.9	6.07	47.0	6.65	50.2	7.23	56.2	8.46	62.4	9.37
	27	31.7	4.35	37.9	5.38	43.9	6.48	47.0	7.05	50.2	7.72	56.2	9.04	62.4	9.96
	29	31.7	4.64	37.9	5.70	43.9	6.88	47.0	7.51	50.2	8.21	56.2	9.64	62.4	10.67
	31	31.7	4.92	37.9	6.07	43.9	7.34	47.0	8.03	50.2	8.75	56.2	10.28	62.4	11.33
	33	31.7	5.21	37.9	6.42	43.9	7.80	47.0	8.52	50.2	9.30	56.2	10.94	62.4	12.06
	35	31.7	5.50	37.9	6.86	43.9	8.29	47.0	9.07	50.2	9.90	56.2	11.66	62.4	12.78
	37	31.7	5.84	37.9	7.26	43.9	8.81	47.0	9.64	50.2	10.54	56.2	12.41	62.4	13.49
	39	31.7	6.21	37.9	7.74	43.9	9.42	47.0	10.38	50.2	11.38	56.2	13.28	62.4	14.55
	41	30.9	6.86	36.9	8.48	42.8	10.33	45.8	11.38	48.9	12.37	54.7	14.59	60.8	15.69
	43	30.1	7.47	36.0	9.24	41.7	11.27	44.7	12.41	47.7	13.51	53.4	15.93	59.3	16.97
46	28.2	8.30	33.8	10.39	39.1	12.70	41.9	13.82	44.7	15.23	50.0	17.97	55.6	18.91	
48	25.0	7.24	29.9	9.08	34.6	11.10	37.1	12.08	39.5	13.33	44.2	15.73	49.2	16.37	
60	10	27.1	3.17	32.4	3.72	37.7	4.33	40.3	4.64	43.0	4.93	48.2	5.60	53.5	6.26
	12	27.1	3.23	32.4	3.78	37.7	4.39	40.3	4.70	43.0	5.02	48.2	5.68	53.5	6.38
	14	27.1	3.26	32.4	3.84	37.7	4.47	40.3	4.79	43.0	5.11	48.2	5.80	53.5	6.49
	16	27.1	3.32	32.4	3.92	37.7	4.53	40.3	4.88	43.0	5.22	48.2	5.91	53.5	6.61
	18	27.1	3.38	32.4	3.98	37.7	4.62	40.3	4.96	43.0	5.31	48.2	6.00	53.5	6.75
	20	27.1	3.43	32.4	4.04	37.7	4.70	40.3	5.05	43.0	5.39	48.2	6.12	53.5	6.90
	21	27.1	3.46	32.4	4.07	37.7	4.76	40.3	5.11	43.0	5.45	48.2	6.20	53.5	6.95
	23	27.1	3.52	32.4	4.15	37.7	4.82	40.3	5.19	43.0	5.57	48.2	6.43	53.5	7.39
	25	27.1	3.58	32.4	4.24	37.7	5.02	40.3	5.45	43.0	5.91	48.2	6.87	53.5	7.90
	27	27.1	3.69	32.4	4.47	37.7	5.34	40.3	5.80	43.0	6.29	48.2	7.30	53.5	8.42
	29	27.1	3.92	32.4	4.76	37.7	5.68	40.3	6.17	43.0	6.69	48.2	7.79	53.5	9.00
	31	27.1	4.15	32.4	5.05	37.7	6.03	40.3	6.58	43.0	7.13	48.2	8.31	53.5	9.58
	33	27.1	4.39	32.4	5.34	37.7	6.40	40.3	6.98	43.0	7.59	48.2	8.83	53.5	10.21
	35	27.1	4.64	32.4	5.68	37.7	6.81	40.3	7.41	43.0	8.05	48.2	9.41	53.5	10.85
	37	27.1	4.90	32.4	6.00	37.7	7.21	40.3	7.88	43.0	8.54	48.2	9.98	53.5	11.54
	39	27.1	5.22	32.4	6.39	37.7	7.78	40.3	8.45	43.0	9.19	48.2	10.70	53.5	12.37
	41	26.4	5.66	31.6	6.99	36.7	8.45	39.3	9.23	41.9	9.98	47.0	11.75	52.2	13.44
	43	25.8	6.15	30.8	7.61	35.8	9.22	38.3	10.06	40.8	10.88	45.8	12.82	50.9	14.68
46	24.2	6.88	28.9	8.54	33.6	10.37	35.9	11.31	38.3	12.24	43.0	14.45	47.7	16.72	
48	21.4	6.00	25.5	7.46	29.7	9.06	31.8	9.88	33.8	10.70	38.0	12.64	42.2	14.63	
50	10	22.7	2.75	27.1	3.18	31.4	3.61	33.6	3.87	35.8	4.11	40.1	4.63	44.6	5.15
	12	22.7	2.78	27.1	3.21	31.4	3.67	33.6	3.93	35.8	4.19	40.1	4.71	44.6	5.23
	14	22.7	2.80	27.1	3.27	31.4	3.73	33.6	3.99	35.8	4.25	40.1	4.77	44.6	5.32
	16	22.7	2.86	27.1	3.32	31.4	3.79	33.6	4.08	35.8	4.31	40.1	4.86	44.6	5.41
	18	22.7	2.89	27.1	3.35	31.4	3.84	33.6	4.13	35.8	4.39	40.1	4.94	44.6	5.52
	20	22.7	2.92	27.1	3.41	31.4	3.93	33.6	4.19	35.8	4.48	40.1	5.03	44.6	5.64
	21	22.7	2.95	27.1	3.44	31.4	3.96	33.6	4.25	35.8	4.51	40.1	5.09	44.6	5.69
	23	22.7	3.01	27.1	3.50	31.4	4.02	33.6	4.31	35.8	4.60	40.1	5.17	44.6	5.81
	25	22.7	3.04	27.1	3.56	31.4	4.11	33.6	4.39	35.8	4.74	40.1	5.43	44.6	6.22
	27	22.7	3.09	27.1	3.67	31.4	4.34	33.6	4.68	35.8	5.03	40.1	5.81	44.6	6.62
	29	22.7	3.27	27.1	3.90	31.4	4.60	33.6	4.97	35.8	5.35	40.1	6.16	44.6	7.02
	31	22.7	3.44	27.1	4.13	31.4	4.89	33.6	5.26	35.8	5.69	40.1	6.56	44.6	7.49
	33	22.7	3.64	27.1	4.37	31.4	5.17	33.6	5.58	35.8	6.04	40.1	6.97	44.6	7.98
	35	22.7	3.84	27.1	4.63	31.4	5.46	33.6	5.93	35.8	6.39	40.1	7.37	44.6	8.47
	37	22.7	4.08	27.1	4.89	31.4	5.78	33.6	6.27	35.8	6.76	40.1	7.86	44.6	8.99
	39	22.7	4.35	27.1	5.24	31.4	6.19	33.6	6.75	35.8	7.26	40.1	8.38	44.6	9.71
	41	22.1	4.70	26.4	5.67	30.6	6.77	32.7	7.31	34.8	7.86	39.1	9.18	43.5	10.55
	43	21.6	5.11	25.8	6.17	29.9	7.37	31.9	7.96	34.0	8.56	38.1	10.01	42.4	11.50
46	20.2	5.72	24.2	6.92	28.0	8.27	29.9	8.94	31.8	9.61	35.7	11.26	39.8	12.95	
48	17.9	4.99	21.4	6.03	24.8	7.21	26.5	7.81	28.2	8.39	31.6	9.84	35.2	11.32	

**Note**

1. TC: Total Capacity(kW), PI : Power Input(kW, Comp. + Outdoor fan motor)
2. Capacity tables show the average value of conditions which may occur.

# 7. Capacity Tables

◆ ARUM261LTE5

Cooling Capacity (26HP)

Combination (%)	Outdoor air temp. (DB, °C)	Indoor air temp. (DB/WB, °C)													
		20		23		26		27		28		30		32	
		14	16	18	19	20	22	24	TC	PI	TC	PI	TC	PI	
130	10	72.1	6.95	85.9	8.49	92.0	9.85	94.7	10.05	97.3	10.13	102.0	10.21	104.6	10.25
	12	72.1	7.12	85.9	8.80	92.0	10.26	94.7	10.32	97.3	10.41	102.0	10.49	104.6	10.58
	14	72.1	7.36	85.9	9.11	92.0	10.64	94.7	10.72	97.3	10.81	102.0	10.89	104.6	10.99
	16	72.1	7.63	85.9	9.43	92.0	11.12	94.7	11.22	97.3	11.31	102.0	11.41	104.6	11.50
	18	72.1	7.95	85.9	9.98	92.0	11.63	94.7	11.88	97.3	11.97	102.0	12.09	104.6	12.18
	20	72.1	8.30	85.9	10.63	92.0	12.20	94.7	13.07	97.3	13.17	100.5	13.30	103.2	13.39
	21	72.1	8.52	85.9	11.00	92.0	12.46	94.7	13.83	97.3	13.94	100.0	14.08	102.6	14.17
	23	72.1	9.14	85.9	11.57	92.0	13.11	94.7	15.26	96.1	15.38	98.5	15.53	101.1	15.64
	25	72.1	9.76	85.9	12.24	92.0	14.00	93.5	16.92	94.7	17.06	97.3	17.23	100.0	17.35
	27	72.1	10.44	85.9	13.08	90.9	14.92	92.0	18.63	93.5	18.78	96.1	18.97	98.5	19.10
	29	72.1	11.13	85.9	13.99	89.4	16.06	90.7	20.48	92.0	20.60	94.7	20.78	97.3	20.86
	31	72.1	11.87	85.6	14.74	87.9	17.08	89.4	20.39	90.7	20.51	93.2	20.70	95.8	20.78
	33	72.1	12.65	84.1	15.61	86.8	18.32	88.2	20.20	89.4	20.32	92.0	20.51	94.4	20.59
	35	72.1	13.49	82.6	16.35	85.3	19.84	86.8	19.94	88.2	20.06	90.6	20.24	93.2	20.32
	37	72.1	14.38	81.5	17.16	84.1	19.58	85.3	19.68	86.8	19.79	89.1	19.97	91.8	20.05
	39	72.1	15.32	80.0	18.06	82.6	19.32	84.1	19.41	85.3	19.53	87.9	19.70	90.6	19.78
41	70.3	16.25	76.7	18.96	79.3	19.05	80.5	19.15	82.1	19.26	84.5	19.44	86.8	19.51	
43	68.5	17.14	73.5	18.70	76.1	18.79	77.2	18.89	78.8	19.00	81.2	19.17	83.4	19.25	
46	64.2	18.34	67.1	18.31	69.5	18.40	70.6	18.49	72.0	18.60	74.3	18.77	76.4	18.84	
48	56.8	17.83	58.2	17.89	60.4	17.92	61.4	17.97	62.7	18.13	64.7	18.24	66.5	18.31	
120	10	65.2	6.25	77.6	7.67	84.8	9.11	87.4	9.84	89.9	10.00	94.8	10.04	97.1	10.12
	12	65.2	6.42	77.6	7.92	84.8	9.47	87.4	10.05	89.9	10.37	94.8	10.49	97.1	10.58
	14	65.2	6.64	77.6	8.19	84.8	9.86	87.4	10.43	89.9	10.75	94.8	10.91	97.1	10.99
	16	65.2	6.88	77.6	8.53	84.8	10.24	87.4	10.82	89.9	11.25	94.8	11.38	97.1	11.48
	18	65.2	7.15	77.6	8.91	84.8	10.65	87.4	11.39	89.9	11.82	94.8	11.96	97.1	12.05
	20	65.2	7.42	77.6	9.45	84.8	11.22	87.4	11.99	89.9	12.45	94.8	12.61	97.1	12.71
	21	65.2	7.65	77.6	9.79	84.8	11.54	87.4	12.34	89.9	12.86	94.8	13.02	97.1	13.13
	23	65.2	8.17	77.6	10.47	84.8	12.36	87.4	13.11	89.9	13.71	94.8	13.85	97.1	13.96
	25	65.2	8.73	77.6	11.22	84.8	13.04	87.4	13.98	89.9	14.70	93.7	14.82	96.0	14.94
	27	65.2	9.32	77.6	12.00	84.8	13.87	87.4	14.94	89.9	15.80	92.3	15.90	94.6	16.03
	29	65.2	9.95	77.6	12.81	84.8	14.60	87.4	15.98	88.5	16.84	90.8	17.09	93.4	17.23
	31	65.2	10.60	77.6	13.68	84.8	15.35	86.2	17.12	87.4	18.06	89.7	18.38	91.9	18.53
	33	65.2	11.28	77.6	14.58	83.6	16.24	84.8	18.59	85.9	19.39	88.2	19.61	90.5	19.77
	35	65.2	12.00	77.6	15.54	82.2	17.19	83.3	20.48	84.8	20.58	87.1	20.64	89.4	20.80
	37	65.2	12.90	77.6	16.40	81.0	18.33	82.2	20.04	83.3	20.14	85.6	20.20	88.0	20.37
	39	65.2	13.89	77.3	17.33	79.6	19.44	80.8	19.63	81.9	19.73	84.5	19.79	86.8	19.95
41	63.6	14.88	73.9	18.26	76.4	19.06	77.5	19.22	78.6	19.32	80.9	19.37	83.2	19.53	
43	62.0	15.88	70.8	18.00	73.3	18.63	74.3	18.81	75.4	18.90	77.7	18.96	79.9	19.11	
46	58.1	17.08	64.6	17.57	66.9	18.04	67.9	18.19	69.0	18.28	71.0	18.34	73.1	18.48	
48	51.4	16.73	56.1	17.26	58.2	17.69	59.1	17.80	60.0	17.86	61.8	17.93	63.7	18.00	
110	10	58.4	5.62	69.7	6.85	77.8	8.14	80.1	8.81	85.1	9.48	87.1	9.75	93.0	9.91
	12	58.4	5.80	69.7	7.08	77.8	8.48	80.1	9.06	85.1	9.84	87.1	10.16	93.0	10.39
	14	58.4	5.98	69.7	7.40	77.8	8.86	80.1	9.51	85.1	10.33	87.1	10.63	93.0	10.85
	16	58.4	6.19	69.7	7.67	77.8	9.23	80.1	9.92	85.1	10.81	87.1	11.11	93.0	11.30
	18	58.4	6.42	69.7	7.99	77.8	9.76	80.1	10.45	85.1	11.40	87.1	11.63	93.0	11.85
	20	58.4	6.65	69.7	8.39	77.8	10.35	80.1	10.93	85.1	11.96	87.1	12.25	93.0	12.45
	21	58.4	6.80	69.7	8.64	77.8	10.62	80.1	11.22	85.1	12.29	87.1	12.60	93.0	12.80
	23	58.4	7.24	69.7	9.26	77.8	11.21	80.1	11.85	85.1	12.98	87.1	13.26	93.0	13.48
	25	58.4	7.74	69.7	9.88	77.8	11.84	80.1	12.53	85.1	13.72	87.1	13.91	91.9	14.20
	27	58.4	8.27	69.7	10.57	77.8	12.51	80.1	13.26	85.1	14.33	87.1	14.66	90.5	14.90
	29	58.4	8.83	69.7	11.28	77.8	13.22	80.1	14.04	85.1	15.14	87.1	15.40	89.4	15.63
	31	58.4	9.39	69.7	12.03	77.8	13.97	80.1	14.88	83.7	15.91	86.0	16.22	88.0	16.39
	33	58.4	10.01	69.7	12.81	77.8	14.76	80.1	15.76	82.6	16.80	84.6	17.08	86.8	17.17
	35	58.4	10.63	69.7	13.68	77.8	15.59	80.1	16.70	81.2	17.73	83.2	17.90	85.4	17.98
	37	58.4	11.27	69.7	14.51	77.8	16.46	79.0	17.70	79.8	18.70	82.1	18.77	84.0	18.82
	39	58.4	12.15	69.7	15.42	76.4	17.37	77.5	18.93	78.7	19.63	80.6	19.66	82.9	19.68
41	57.0	13.03	67.9	16.33	73.2	18.31	74.3	20.48	75.3	20.48	77.5	20.64	79.4	20.80	
43	55.5	13.68	66.2	17.02	70.1	19.42	71.3	19.64	72.2	19.60	74.3	19.71	76.2	19.76	
46	52.1	13.35	62.1	16.43	64.0	18.43	65.1	18.43	65.9	18.59	67.9	18.69	69.7	18.74	
48	46.0	12.97	53.9	15.83	55.6	17.54	56.6	17.65	57.3	17.74	59.1	17.79	60.6	17.86	



# 7. Capacity Tables

Cooling Capacity (26HP)

Combination (%)	Outdoor air temp. (DB, °C)	Indoor air temp. (DB/WB, °C)													
		20		23		26		27		28		30		32	
		14		16		18		19		20		22		24	
		TC	PI	TC	PI	TC	PI	TC	PI	TC	PI	TC	PI	TC	PI
100	10	49.1	5.06	58.5	6.15	68.1	7.30	72.8	7.89	77.5	8.48	85.9	9.44	87.8	9.51
	12	49.1	5.23	58.5	6.41	68.1	7.55	72.8	8.10	77.5	8.75	85.9	9.94	87.8	10.04
	14	49.1	5.39	58.5	6.66	68.1	7.87	72.8	8.45	77.5	9.12	85.9	10.50	87.8	10.60
	16	49.1	5.55	58.5	6.88	68.1	8.20	72.8	8.85	77.5	9.62	85.9	11.01	87.8	11.16
	18	49.1	5.72	58.5	7.14	68.1	8.52	72.8	9.29	77.5	10.19	85.9	11.63	87.8	11.72
	20	49.1	5.92	58.5	7.41	68.1	9.01	72.8	9.95	77.5	10.91	85.9	12.18	87.8	12.28
	21	49.1	6.04	58.5	7.58	68.1	9.32	72.8	10.29	77.5	11.31	85.9	12.46	87.8	12.56
	23	49.1	6.40	58.5	8.11	68.1	10.01	72.8	11.03	77.5	12.12	85.9	13.05	87.8	13.16
	25	49.1	6.81	58.5	8.64	68.1	10.69	72.8	11.81	77.5	12.96	85.9	13.61	87.0	13.72
	27	49.1	7.27	58.5	9.23	68.1	11.44	72.8	12.62	77.5	13.78	84.2	14.25	86.0	14.36
	29	49.1	7.74	58.5	9.85	68.1	12.22	72.8	13.49	77.5	14.58	82.7	14.82	84.7	14.94
	31	49.1	8.27	58.5	10.51	68.1	13.02	72.8	14.39	77.5	15.33	81.4	15.40	83.4	15.52
	33	49.1	8.77	58.5	11.19	68.1	13.89	72.8	15.35	77.5	15.90	80.1	15.97	82.1	16.10
	35	49.1	9.32	58.5	11.90	68.1	14.79	72.8	16.38	76.3	16.48	78.7	16.54	80.7	16.67
	37	49.1	9.99	58.5	12.77	68.1	15.67	72.8	17.16	75.0	17.24	77.2	17.31	79.0	17.47
	39	49.1	10.71	58.5	13.72	68.1	16.61	72.8	18.00	73.8	18.08	76.0	18.15	77.7	18.31
	41	48.4	11.43	57.6	14.66	67.0	17.54	69.9	18.84	71.4	18.91	73.1	18.98	75.4	19.16
	43	46.7	12.09	55.6	15.54	64.7	18.38	67.0	19.56	67.7	19.63	69.8	19.69	71.7	19.88
46	43.8	13.01	52.1	16.76	60.7	19.50	61.2	20.48	61.8	20.54	63.8	20.60	65.5	20.79	
48	38.7	11.23	46.1	14.50	52.4	16.67	53.1	17.37	53.7	17.43	55.5	17.47	57.0	17.61	
90	10	44.2	4.73	52.8	5.68	61.4	6.70	65.5	7.22	69.7	7.77	78.3	8.70	86.8	9.51
	12	44.2	4.78	52.8	5.77	61.4	6.81	65.5	7.37	69.7	7.94	78.3	8.87	86.8	9.84
	14	44.2	4.87	52.8	5.89	61.4	6.96	65.5	7.51	69.7	8.09	78.3	9.04	86.8	10.04
	16	44.2	4.96	52.8	6.00	61.4	7.10	65.5	7.65	69.7	8.23	78.3	9.21	86.8	10.22
	18	44.2	5.05	52.8	6.12	61.4	7.22	65.5	7.83	69.7	8.41	78.3	9.42	86.8	10.73
	20	44.2	5.13	52.8	6.23	61.4	7.37	65.5	7.97	69.7	8.73	78.3	10.08	86.8	11.24
	21	44.2	5.19	52.8	6.29	61.4	7.51	65.5	8.23	69.7	9.05	78.3	10.24	86.8	11.50
	23	44.2	5.31	52.8	6.55	61.4	8.03	65.5	8.84	69.7	9.68	78.3	10.86	85.6	12.04
	25	44.2	5.57	52.8	6.99	61.4	8.58	65.5	9.45	69.7	10.35	78.3	11.61	84.4	12.55
	27	44.2	5.94	52.8	7.45	61.4	9.16	65.5	10.09	69.7	11.08	78.3	12.35	83.2	13.15
	29	44.2	6.29	52.8	7.94	61.4	9.80	65.5	10.79	69.7	11.83	78.3	13.08	81.9	13.67
	31	44.2	6.70	52.8	8.47	61.4	10.44	65.5	11.48	69.7	12.61	78.3	13.73	80.7	14.20
	33	44.2	7.13	52.8	9.02	61.4	11.13	65.5	12.24	69.7	13.38	78.3	14.39	79.5	14.73
	35	44.2	7.57	52.8	9.57	61.4	11.83	65.5	13.05	69.7	14.19	76.9	15.22	78.2	15.57
	37	44.2	8.03	52.8	10.18	61.4	12.61	65.5	13.86	69.7	14.98	75.7	15.91	77.0	16.27
	39	44.2	8.50	52.8	10.83	61.4	13.35	65.5	14.75	69.7	15.75	74.4	16.77	75.7	16.97
	41	43.1	9.52	51.4	12.00	59.8	14.65	63.8	16.13	67.9	17.00	71.3	17.68	72.6	18.08
	43	42.0	10.27	50.2	12.97	58.3	16.01	62.3	17.37	66.2	18.23	68.4	18.93	69.6	19.16
46	39.4	11.56	47.0	14.77	54.6	18.24	58.4	19.70	60.2	20.25	62.4	20.60	63.6	20.78	
48	34.8	10.10	41.6	12.92	48.3	15.96	51.6	17.18	52.2	17.42	54.3	17.47	55.3	17.61	
80	10	39.3	4.41	46.8	5.30	54.3	6.22	58.2	6.71	62.1	7.20	69.7	8.21	77.2	8.92
	12	39.3	4.51	46.8	5.36	54.3	6.34	58.2	6.83	62.1	7.33	69.7	8.37	77.2	9.09
	14	39.3	4.57	46.8	5.49	54.3	6.44	58.2	6.96	62.1	7.45	69.7	8.52	77.2	9.27
	16	39.3	4.63	46.8	5.58	54.3	6.56	58.2	7.08	62.1	7.60	69.7	8.70	77.2	9.45
	18	39.3	4.72	46.8	5.67	54.3	6.68	58.2	7.20	62.1	7.75	69.7	8.86	77.2	9.65
	20	39.3	4.81	46.8	5.79	54.3	6.83	58.2	7.36	62.1	7.91	69.7	9.20	77.2	10.23
	21	39.3	4.84	46.8	5.85	54.3	6.90	58.2	7.45	62.1	8.09	69.7	9.49	77.2	10.50
	23	39.3	4.93	46.8	5.95	54.3	7.20	58.2	7.91	62.1	8.64	69.7	10.01	77.2	11.02
	25	39.3	5.12	46.8	6.34	54.3	7.72	58.2	8.46	62.1	9.26	69.7	10.72	77.2	11.78
	27	39.3	5.43	46.8	6.74	54.3	8.24	58.2	9.04	62.1	9.87	69.7	11.39	77.2	12.40
	29	39.3	5.76	46.8	7.20	54.3	8.77	58.2	9.62	62.1	10.54	69.7	12.20	77.2	12.99
	31	39.3	6.13	46.8	7.63	54.3	9.35	58.2	10.27	62.1	11.22	69.7	12.95	77.2	13.64
	33	39.3	6.50	46.8	8.15	54.3	9.96	58.2	10.94	62.1	11.95	69.7	13.64	77.2	14.29
	35	39.3	6.90	46.8	8.64	54.3	10.60	58.2	11.65	62.1	12.75	69.7	14.47	76.4	15.10
	37	39.3	7.29	46.8	9.19	54.3	11.25	58.2	12.38	62.1	13.55	69.7	15.27	75.2	15.83
	39	39.3	7.71	46.8	9.72	54.3	12.03	58.2	13.31	62.1	14.56	69.7	16.13	73.9	16.70
	41	38.3	8.53	45.6	10.77	52.9	13.21	56.7	14.59	60.5	16.00	67.9	17.32	70.8	17.72
	43	37.3	9.39	44.5	11.75	51.6	14.42	55.3	15.90	59.1	17.48	66.2	18.55	67.9	18.97
46	35.0	10.44	41.7	13.23	48.4	16.24	51.9	17.70	55.3	19.73	60.6	20.60	62.0	20.78	
48	30.9	9.12	36.9	11.57	42.8	14.21	45.9	15.46	49.0	17.27	52.6	17.47	53.9	17.61	

# 7. Capacity Tables

Cooling Capacity (26HP)

Combination (%)	Outdoor air temp. (DB, °C)	Indoor air temp. (DB/WB, °C)													
		20		23		26		27		28		30		32	
		14		16		18		19		20		22		24	
		TC	PI	TC	PI	TC	PI	TC	PI	TC	PI	TC	PI	TC	PI
70	10	34.3	3.91	41.1	4.65	47.6	5.39	51.0	5.82	54.3	6.22	60.8	7.08	67.6	7.92
	12	34.3	3.97	41.1	4.71	47.6	5.51	51.0	5.91	54.3	6.34	60.8	7.20	67.6	8.07
	14	34.3	4.03	41.1	4.77	47.6	5.60	51.0	6.00	54.3	6.43	60.8	7.36	67.6	8.21
	16	34.3	4.09	41.1	4.86	47.6	5.69	51.0	6.12	54.3	6.56	60.8	7.48	67.6	8.39
	18	34.3	4.16	41.1	4.96	47.6	5.82	51.0	6.25	54.3	6.68	60.8	7.60	67.6	8.54
	20	34.3	4.22	41.1	5.05	47.6	5.91	51.0	6.37	54.3	6.83	60.8	7.79	67.6	8.86
	21	34.3	4.28	41.1	5.08	47.6	5.97	51.0	6.43	54.3	6.89	60.8	7.91	67.6	9.05
	23	34.3	4.34	41.1	5.20	47.6	6.09	51.0	6.65	54.3	7.23	60.8	8.46	67.6	9.56
	25	34.3	4.40	41.1	5.39	47.6	6.49	51.0	7.11	54.3	7.73	60.8	9.05	67.6	10.02
	27	34.3	4.65	41.1	5.76	47.6	6.93	51.0	7.54	54.3	8.25	60.8	9.66	67.6	10.65
	29	34.3	4.96	41.1	6.09	47.6	7.36	51.0	8.03	54.3	8.77	60.8	10.31	67.6	11.41
	31	34.3	5.26	41.1	6.49	47.6	7.85	51.0	8.59	54.3	9.36	60.8	10.99	67.6	12.11
	33	34.3	5.57	41.1	6.86	47.6	8.34	51.0	9.11	54.3	9.94	60.8	11.70	67.6	12.89
	35	34.3	5.88	41.1	7.33	47.6	8.86	51.0	9.70	54.3	10.59	60.8	12.47	67.6	13.67
	37	34.3	6.25	41.1	7.76	47.6	9.42	51.0	10.31	54.3	11.26	60.8	13.27	67.6	14.42
	39	34.3	6.63	41.1	8.27	47.6	10.07	51.0	11.09	54.3	12.17	60.8	14.20	67.6	15.55
41	33.4	7.34	40.0	9.06	46.4	11.05	49.7	12.17	52.9	13.23	59.3	15.59	65.9	16.77	
43	32.6	7.98	39.0	9.88	45.2	12.05	48.4	13.27	51.6	14.45	57.8	17.03	64.2	18.14	
46	30.6	8.87	36.6	11.11	42.4	13.57	45.4	14.78	48.4	16.28	54.2	19.21	60.2	20.21	
48	27.0	7.74	32.4	9.70	37.5	11.87	40.1	12.91	42.8	14.25	47.9	16.81	53.3	17.50	
60	10	29.4	3.40	35.1	3.99	40.8	4.64	43.7	4.98	46.5	5.28	52.3	6.00	58.0	6.71
	12	29.4	3.46	35.1	4.05	40.8	4.70	43.7	5.04	46.5	5.38	52.3	6.09	58.0	6.83
	14	29.4	3.49	35.1	4.11	40.8	4.79	43.7	5.13	46.5	5.47	52.3	6.21	58.0	6.95
	16	29.4	3.55	35.1	4.20	40.8	4.85	43.7	5.22	46.5	5.59	52.3	6.34	58.0	7.08
	18	29.4	3.62	35.1	4.26	40.8	4.94	43.7	5.32	46.5	5.69	52.3	6.43	58.0	7.23
	20	29.4	3.68	35.1	4.33	40.8	5.04	43.7	5.41	46.5	5.78	52.3	6.55	58.0	7.39
	21	29.4	3.71	35.1	4.36	40.8	5.10	43.7	5.47	46.5	5.84	52.3	6.64	58.0	7.45
	23	29.4	3.77	35.1	4.45	40.8	5.16	43.7	5.56	46.5	5.96	52.3	6.89	58.0	7.91
	25	29.4	3.83	35.1	4.54	40.8	5.38	43.7	5.84	46.5	6.34	52.3	7.36	58.0	8.47
	27	29.4	3.96	35.1	4.79	40.8	5.72	43.7	6.21	46.5	6.74	52.3	7.82	58.0	9.02
	29	29.4	4.20	35.1	5.10	40.8	6.09	43.7	6.61	46.5	7.17	52.3	8.34	58.0	9.64
	31	29.4	4.45	35.1	5.41	40.8	6.46	43.7	7.05	46.5	7.63	52.3	8.90	58.0	10.26
	33	29.4	4.70	35.1	5.72	40.8	6.86	43.7	7.48	46.5	8.13	52.3	9.46	58.0	10.94
	35	29.4	4.98	35.1	6.09	40.8	7.29	43.7	7.94	46.5	8.62	52.3	10.08	58.0	11.62
	37	29.4	5.25	35.1	6.43	40.8	7.73	43.7	8.44	46.5	9.15	52.3	10.69	58.0	12.36
	39	29.4	5.59	35.1	6.84	40.8	8.34	43.7	9.05	46.5	9.84	52.3	11.47	58.0	13.25
41	28.6	6.06	34.2	7.49	39.8	9.06	42.6	9.89	45.3	10.69	50.9	12.58	56.5	14.40	
43	27.9	6.59	33.4	8.15	38.8	9.87	41.5	10.78	44.2	11.65	49.7	13.74	55.1	15.72	
46	26.2	7.37	31.3	9.15	36.4	11.10	38.9	12.11	41.4	13.11	46.5	15.48	51.6	17.91	
48	23.1	6.43	27.7	7.99	32.2	9.70	34.4	10.58	36.7	11.46	41.2	13.54	45.7	15.67	
50	10	24.6	2.95	29.4	3.41	34.1	3.88	36.4	4.16	38.7	4.41	43.4	4.97	48.4	5.52
	12	24.6	2.98	29.4	3.44	34.1	3.94	36.4	4.22	38.7	4.50	43.4	5.06	48.4	5.62
	14	24.6	3.01	29.4	3.51	34.1	4.00	36.4	4.28	38.7	4.56	43.4	5.12	48.4	5.71
	16	24.6	3.07	29.4	3.57	34.1	4.07	36.4	4.38	38.7	4.62	43.4	5.21	48.4	5.80
	18	24.6	3.10	29.4	3.60	34.1	4.13	36.4	4.44	38.7	4.72	43.4	5.31	48.4	5.93
	20	24.6	3.13	29.4	3.66	34.1	4.22	36.4	4.50	38.7	4.81	43.4	5.40	48.4	6.05
	21	24.6	3.17	29.4	3.69	34.1	4.25	36.4	4.56	38.7	4.84	43.4	5.46	48.4	6.11
	23	24.6	3.23	29.4	3.76	34.1	4.31	36.4	4.62	38.7	4.93	43.4	5.55	48.4	6.24
	25	24.6	3.26	29.4	3.82	34.1	4.41	36.4	4.72	38.7	5.09	43.4	5.83	48.4	6.67
	27	24.6	3.32	29.4	3.94	34.1	4.66	36.4	5.03	38.7	5.40	43.4	6.24	48.4	7.11
	29	24.6	3.51	29.4	4.19	34.1	4.93	36.4	5.34	38.7	5.74	43.4	6.61	48.4	7.54
	31	24.6	3.69	29.4	4.44	34.1	5.24	36.4	5.65	38.7	6.11	43.4	7.04	48.4	8.04
	33	24.6	3.91	29.4	4.69	34.1	5.55	36.4	5.99	38.7	6.49	43.4	7.48	48.4	8.57
	35	24.6	4.13	29.4	4.97	34.1	5.87	36.4	6.36	38.7	6.86	43.4	7.91	48.4	9.09
	37	24.6	4.38	29.4	5.24	34.1	6.21	36.4	6.73	38.7	7.26	43.4	8.44	48.4	9.65
	39	24.6	4.67	29.4	5.62	34.1	6.65	36.4	7.25	38.7	7.79	43.4	8.99	48.4	10.42
41	23.9	5.05	28.6	6.09	33.2	7.27	35.5	7.85	37.7	8.44	42.3	9.86	47.1	11.32	
43	23.3	5.48	27.9	6.62	32.4	7.91	34.6	8.55	36.8	9.19	41.3	10.75	46.0	12.35	
46	21.9	6.14	26.2	7.42	30.3	8.88	32.4	9.60	34.5	10.32	38.7	12.09	43.1	13.90	
48	19.4	5.35	23.1	6.47	26.8	7.74	28.7	8.38	30.5	9.01	34.2	10.57	38.1	12.15	

**Note**

1. TC: Total Capacity(kW), PI : Power Input(kW, Comp. + Outdoor fan motor)
2. Capacity tables show the average value of conditions which may occur.

# 7. Capacity Tables

◆ ARUM280LTE5

Cooling Capacity (28HP)

Combination (%)	Outdoor air temp. (DB, °C)	Indoor air temp. (DB/WB, °C)													
		20		23		26		27		28		30		32	
		14	16	18	19	20	22	24	TC	PI	TC	PI	TC	PI	
130	10	77.7	7.89	92.5	9.65	99.1	11.19	102.0	11.42	104.8	11.51	109.8	11.60	112.7	11.65
	12	77.7	8.09	92.5	9.99	99.1	11.65	102.0	11.73	104.8	11.82	109.8	11.92	112.7	12.02
	14	77.7	8.36	92.5	10.36	99.1	12.09	102.0	12.18	104.8	12.28	109.8	12.37	112.7	12.48
	16	77.7	8.67	92.5	10.72	99.1	12.63	102.0	12.75	104.8	12.85	109.8	12.97	112.7	13.07
	18	77.7	9.03	92.5	11.34	99.1	13.21	102.0	13.50	104.8	13.61	109.8	13.74	112.7	13.83
	20	77.7	9.43	92.5	12.08	99.1	13.86	102.0	14.85	104.8	14.97	108.3	15.11	111.1	15.22
	21	77.7	9.68	92.5	12.50	99.1	14.15	102.0	15.71	104.8	15.84	107.6	15.99	110.5	16.10
	23	77.7	10.38	92.5	13.15	99.1	14.89	102.0	17.34	103.5	17.48	106.1	17.65	108.9	17.77
	25	77.7	11.09	92.5	13.91	99.1	15.91	100.7	19.23	102.0	19.38	104.8	19.57	107.6	19.71
	27	77.7	11.87	92.5	14.87	97.9	16.95	99.1	21.17	100.7	21.34	103.5	21.55	106.1	21.70
	29	77.7	12.64	92.5	15.89	96.3	18.24	97.7	23.26	99.1	23.40	102.0	23.61	104.8	23.70
	31	77.7	13.49	92.2	16.74	94.7	19.40	96.3	23.17	97.7	23.30	100.4	23.51	103.2	23.61
	33	77.7	14.37	90.6	17.74	93.4	20.81	94.9	22.95	96.3	23.09	99.1	23.30	101.6	23.39
	35	77.7	15.33	89.0	18.58	91.8	22.54	93.4	22.65	94.9	22.79	97.5	22.99	100.4	23.08
	37	77.7	16.34	87.7	19.49	90.6	22.24	91.8	22.36	93.4	22.49	96.0	22.69	98.8	22.78
	39	77.7	17.40	86.2	20.52	89.0	21.95	90.6	22.06	91.8	22.19	94.7	22.39	97.5	22.47
	41	75.7	18.46	82.6	21.55	85.4	21.65	86.7	21.76	88.4	21.89	91.0	22.08	93.5	22.17
	43	73.8	19.47	79.2	21.24	81.9	21.35	83.2	21.46	84.8	21.59	87.4	21.78	89.8	21.87
46	69.2	20.84	72.2	20.80	74.8	20.90	76.0	21.01	77.6	21.13	80.0	21.32	82.2	21.41	
48	61.2	20.26	62.7	20.32	65.1	20.36	66.1	20.42	67.5	20.60	69.7	20.73	71.6	20.81	
120	10	70.3	7.10	83.5	8.71	91.3	10.35	94.1	11.18	96.9	11.36	102.1	11.41	104.6	11.50
	12	70.3	7.29	83.5	9.00	91.3	10.76	94.1	11.42	96.9	11.78	102.1	11.92	104.6	12.02
	14	70.3	7.55	83.5	9.31	91.3	11.20	94.1	11.85	96.9	12.21	102.1	12.39	104.6	12.49
	16	70.3	7.82	83.5	9.69	91.3	11.63	94.1	12.30	96.9	12.78	102.1	12.93	104.6	13.04
	18	70.3	8.12	83.5	10.13	91.3	12.10	94.1	12.94	96.9	13.43	102.1	13.59	104.6	13.69
	20	70.3	8.43	83.5	10.74	91.3	12.75	94.1	13.62	96.9	14.14	102.1	14.33	104.6	14.44
	21	70.3	8.69	83.5	11.12	91.3	13.11	94.1	14.02	96.9	14.61	102.1	14.79	104.6	14.91
	23	70.3	9.29	83.5	11.90	91.3	14.04	94.1	14.90	96.9	15.57	102.1	15.73	104.6	15.86
	25	70.3	9.92	83.5	12.75	91.3	14.81	94.1	15.88	96.9	16.70	100.9	16.84	103.4	16.98
	27	70.3	10.59	83.5	13.63	91.3	15.76	94.1	16.97	96.9	17.95	99.4	18.07	101.8	18.21
	29	70.3	11.30	83.5	14.55	91.3	16.59	94.1	18.16	95.3	19.13	97.8	19.42	100.6	19.57
	31	70.3	12.04	83.5	15.54	91.3	17.44	92.9	19.45	94.1	20.52	96.6	20.88	99.0	21.05
	33	70.3	12.82	83.5	16.56	90.1	18.45	91.3	21.12	92.5	22.03	95.0	22.28	97.5	22.46
	35	70.3	13.63	83.5	17.66	88.5	19.53	89.7	23.26	91.3	23.38	93.8	23.45	96.2	23.63
	37	70.3	14.66	83.5	18.63	87.3	20.82	88.5	22.77	89.7	22.89	92.2	22.96	94.7	23.14
	39	70.3	15.78	83.3	19.69	85.7	22.09	87.0	22.31	88.2	22.42	91.0	22.48	93.5	22.66
	41	68.5	16.91	79.6	20.75	82.3	21.65	83.5	21.84	84.7	21.95	87.1	22.01	89.6	22.19
	43	66.8	18.05	76.3	20.46	78.9	21.16	80.1	21.37	81.2	21.48	83.6	21.54	86.1	21.71
46	62.6	19.40	69.6	19.97	72.1	20.50	73.1	20.67	74.3	20.77	76.5	20.83	78.8	21.00	
48	55.4	19.01	60.4	19.61	62.6	20.10	63.6	20.22	64.6	20.29	66.6	20.37	68.6	20.45	
110	10	62.9	6.39	75.0	7.79	83.8	9.25	86.2	10.01	91.7	10.77	93.8	11.07	100.2	11.26
	12	62.9	6.59	75.0	8.05	83.8	9.63	86.2	10.29	91.7	11.18	93.8	11.54	100.2	11.81
	14	62.9	6.79	75.0	8.41	83.8	10.07	86.2	10.80	91.7	11.74	93.8	12.08	100.2	12.33
	16	62.9	7.03	75.0	8.72	83.8	10.49	86.2	11.28	91.7	12.28	93.8	12.62	100.2	12.84
	18	62.9	7.30	75.0	9.08	83.8	11.09	86.2	11.87	91.7	12.96	93.8	13.21	100.2	13.46
	20	62.9	7.56	75.0	9.53	83.8	11.76	86.2	12.42	91.7	13.59	93.8	13.92	100.2	14.14
	21	62.9	7.72	75.0	9.82	83.8	12.06	86.2	12.75	91.7	13.96	93.8	14.32	100.2	14.54
	23	62.9	8.23	75.0	10.52	83.8	12.73	86.2	13.46	91.7	14.75	93.8	15.07	100.2	15.32
	25	62.9	8.79	75.0	11.23	83.8	13.45	86.2	14.23	91.7	15.59	93.8	15.81	98.9	16.13
	27	62.9	9.39	75.0	12.01	83.8	14.22	86.2	15.06	91.7	16.28	93.8	16.65	97.5	16.93
	29	62.9	10.03	75.0	12.82	83.8	15.02	86.2	15.95	91.7	17.20	93.8	17.50	96.2	17.76
	31	62.9	10.66	75.0	13.67	83.8	15.88	86.2	16.90	90.2	18.08	92.6	18.43	94.7	18.62
	33	62.9	11.37	75.0	14.55	83.8	16.77	86.2	17.91	88.9	19.09	91.1	19.40	93.5	19.51
	35	62.9	12.08	75.0	15.54	83.8	17.71	86.2	18.98	87.5	20.15	89.6	20.33	92.0	20.43
	37	62.9	12.80	75.0	16.49	83.8	18.70	85.0	20.11	85.9	21.25	88.4	21.32	90.5	21.38
	39	62.9	13.80	75.0	17.52	82.3	19.73	83.5	21.51	84.7	22.30	86.8	22.34	89.3	22.36
	41	61.3	14.80	73.1	18.56	78.8	20.81	80.0	23.26	81.1	23.26	83.4	23.45	85.5	23.63
	43	59.8	15.54	71.3	19.33	75.5	22.07	76.7	22.31	77.7	22.27	80.0	22.39	82.1	22.45
46	56.1	15.17	66.8	18.66	68.9	20.94	70.1	20.94	71.0	21.12	73.2	21.24	75.1	21.30	
48	49.6	14.73	58.1	17.98	59.8	19.92	60.9	20.06	61.7	20.15	63.6	20.21	65.3	20.29	

# 7. Capacity Tables

Cooling Capacity (28HP)

Combination (%)	Outdoor air temp. (DB, °C)	Indoor air temp. (DB/WB, °C)													
		20		23		26		27		28		30		32	
		14		16		18		19		20		22		24	
		TC	PI	TC	PI	TC	PI	TC	PI	TC	PI	TC	PI	TC	PI
100	10	52.9	5.75	63.0	6.99	73.4	8.30	78.4	8.96	83.4	9.63	92.5	10.72	94.5	10.81
	12	52.9	5.94	63.0	7.28	73.4	8.57	78.4	9.20	83.4	9.94	92.5	11.30	94.5	11.41
	14	52.9	6.12	63.0	7.57	73.4	8.94	78.4	9.60	83.4	10.37	92.5	11.93	94.5	12.04
	16	52.9	6.31	63.0	7.82	73.4	9.32	78.4	10.06	83.4	10.92	92.5	12.50	94.5	12.68
	18	52.9	6.49	63.0	8.11	73.4	9.68	78.4	10.55	83.4	11.58	92.5	13.21	94.5	13.32
	20	52.9	6.73	63.0	8.42	73.4	10.24	78.4	11.30	83.4	12.39	92.5	13.84	94.5	13.95
	21	52.9	6.87	63.0	8.62	73.4	10.59	78.4	11.69	83.4	12.85	92.5	14.16	94.5	14.27
	23	52.9	7.27	63.0	9.22	73.4	11.37	78.4	12.54	83.4	13.77	92.5	14.83	94.5	14.95
	25	52.9	7.73	63.0	9.82	73.4	12.15	78.4	13.42	83.4	14.73	92.5	15.46	93.7	15.58
	27	52.9	8.26	63.0	10.49	73.4	13.00	78.4	14.34	83.4	15.66	90.7	16.19	92.6	16.32
	29	52.9	8.79	63.0	11.19	73.4	13.88	78.4	15.33	83.4	16.57	89.0	16.84	91.2	16.97
	31	52.9	9.39	63.0	11.94	73.4	14.80	78.4	16.35	83.4	17.41	87.7	17.49	89.8	17.63
	33	52.9	9.96	63.0	12.71	73.4	15.78	78.4	17.44	83.4	18.07	86.3	18.14	88.4	18.29
	35	52.9	10.59	63.0	13.52	73.4	16.81	78.4	18.61	82.2	18.72	84.7	18.79	86.9	18.95
	37	52.9	11.35	63.0	14.51	73.4	17.81	78.4	19.50	80.8	19.59	83.1	19.67	85.1	19.85
	39	52.9	12.16	63.0	15.58	73.4	18.87	78.4	20.45	79.5	20.54	81.8	20.62	83.7	20.81
	41	52.1	12.98	62.0	16.66	72.2	19.93	75.2	21.40	76.9	21.49	78.7	21.56	81.2	21.76
	43	50.3	13.74	59.9	17.66	69.7	20.88	72.1	22.22	73.0	22.30	75.2	22.37	77.2	22.58
46	47.1	14.78	56.1	19.04	65.3	22.15	65.9	23.26	66.6	23.33	68.7	23.40	70.5	23.62	
48	41.7	12.76	49.6	16.47	56.4	18.94	57.2	19.74	57.8	19.80	59.7	19.85	61.4	20.01	
90	10	47.6	5.40	56.8	6.50	66.1	7.66	70.6	8.25	75.0	8.88	84.3	9.94	93.5	10.81
	12	47.6	5.47	56.8	6.60	66.1	7.79	70.6	8.42	75.0	9.08	84.3	10.14	93.5	11.25
	14	47.6	5.57	56.8	6.73	66.1	7.95	70.6	8.58	75.0	9.25	84.3	10.34	93.5	11.48
	16	47.6	5.67	56.8	6.86	66.1	8.12	70.6	8.75	75.0	9.41	84.3	10.53	93.5	11.68
	18	47.6	5.77	56.8	6.99	66.1	8.25	70.6	8.95	75.0	9.61	84.3	10.76	93.5	12.26
	20	47.6	5.87	56.8	7.13	66.1	8.42	70.6	9.11	75.0	9.98	84.3	11.52	93.5	12.85
	21	47.6	5.93	56.8	7.19	66.1	8.58	70.6	9.41	75.0	10.34	84.3	11.70	93.5	13.14
	23	47.6	6.07	56.8	7.49	66.1	9.18	70.6	10.11	75.0	11.07	84.3	12.41	92.2	13.76
	25	47.6	6.36	56.8	7.99	66.1	9.81	70.6	10.80	75.0	11.83	84.3	13.27	90.9	14.35
	27	47.6	6.79	56.8	8.52	66.1	10.47	70.6	11.53	75.0	12.66	84.3	14.11	89.6	15.03
	29	47.6	7.19	56.8	9.08	66.1	11.20	70.6	12.33	75.0	13.52	84.3	14.95	88.2	15.63
	31	47.6	7.66	56.8	9.68	66.1	11.93	70.6	13.12	75.0	14.42	84.3	15.69	86.9	16.24
	33	47.6	8.15	56.8	10.31	66.1	12.73	70.6	13.99	75.0	15.29	84.3	16.45	85.6	16.84
	35	47.6	8.65	56.8	10.94	66.1	13.52	70.6	14.91	75.0	16.22	82.8	17.40	84.2	17.79
	37	47.6	9.18	56.8	11.63	66.1	14.42	70.6	15.84	75.0	17.12	81.5	18.18	82.9	18.59
	39	47.6	9.72	56.8	12.37	66.1	15.26	70.6	16.86	75.0	18.00	80.2	19.17	81.6	19.40
	41	46.4	10.88	55.4	13.72	64.4	16.75	68.8	18.44	73.1	19.43	76.8	20.20	78.2	20.67
	43	45.2	11.74	54.0	14.82	62.8	18.30	67.1	19.86	71.3	20.84	73.6	21.60	75.0	21.90
46	42.4	13.21	50.6	16.88	58.8	20.85	62.8	22.51	64.8	23.15	67.2	23.40	68.5	23.61	
48	37.5	11.55	44.8	14.77	52.1	18.24	55.6	19.63	56.3	19.80	58.4	19.85	59.5	20.01	
80	10	42.3	5.05	50.4	6.06	58.5	7.11	62.7	7.67	66.9	8.23	75.0	9.39	83.2	10.20
	12	42.3	5.15	50.4	6.13	58.5	7.25	62.7	7.81	66.9	8.37	75.0	9.57	83.2	10.40
	14	42.3	5.22	50.4	6.27	58.5	7.36	62.7	7.95	66.9	8.52	75.0	9.74	83.2	10.60
	16	42.3	5.29	50.4	6.38	58.5	7.50	62.7	8.09	66.9	8.69	75.0	9.95	83.2	10.80
	18	42.3	5.40	50.4	6.48	58.5	7.64	62.7	8.23	66.9	8.87	75.0	10.13	83.2	11.04
	20	42.3	5.50	50.4	6.62	58.5	7.81	62.7	8.41	66.9	9.04	75.0	10.51	83.2	11.69
	21	42.3	5.54	50.4	6.69	58.5	7.88	62.7	8.52	66.9	9.25	75.0	10.84	83.2	12.00
	23	42.3	5.64	50.4	6.80	58.5	8.23	62.7	9.04	66.9	9.88	75.0	11.45	83.2	12.60
	25	42.3	5.85	50.4	7.25	58.5	8.83	62.7	9.67	66.9	10.58	75.0	12.25	83.2	13.47
	27	42.3	6.20	50.4	7.71	58.5	9.43	62.7	10.34	66.9	11.28	75.0	13.02	83.2	14.17
	29	42.3	6.59	50.4	8.23	58.5	10.02	62.7	11.00	66.9	12.05	75.0	13.95	83.2	14.85
	31	42.3	7.01	50.4	8.73	58.5	10.69	62.7	11.74	66.9	12.83	75.0	14.80	83.2	15.59
	33	42.3	7.43	50.4	9.32	58.5	11.39	62.7	12.51	66.9	13.67	75.0	15.60	83.2	16.34
	35	42.3	7.88	50.4	9.88	58.5	12.12	62.7	13.32	66.9	14.58	75.0	16.54	82.3	17.26
	37	42.3	8.34	50.4	10.51	58.5	12.86	62.7	14.16	66.9	15.49	75.0	17.45	80.9	18.10
	39	42.3	8.81	50.4	11.11	58.5	13.76	62.7	15.22	66.9	16.64	75.0	18.44	79.6	19.09
	41	41.2	9.75	49.1	12.31	57.0	15.10	61.1	16.68	65.2	18.29	73.1	19.80	76.3	20.25
	43	40.2	10.73	47.9	13.43	55.6	16.48	59.6	18.18	63.6	19.99	71.3	21.17	73.1	21.68
46	37.7	11.94	44.9	15.13	52.1	18.57	55.9	20.24	59.6	22.55	65.2	23.40	66.7	23.61	
48	33.3	10.43	39.7	13.23	46.1	16.24	49.4	17.68	52.7	19.69	56.6	19.85	58.0	20.01	

## 7. Capacity Tables

Cooling Capacity (28HP)

Combination (%)	Outdoor air temp. (DB, °C)	Indoor air temp. (DB/WB, °C)													
		20		23		26		27		28		30		32	
		14		16		18		19		20		22		24	
		TC	PI	TC	PI	TC	PI	TC	PI	TC	PI	TC	PI	TC	PI
70	10	37.0	4.47	44.2	5.31	51.2	6.16	54.9	6.65	58.5	7.11	65.5	8.09	72.8	9.05
	12	37.0	4.54	44.2	5.38	51.2	6.30	54.9	6.76	58.5	7.25	65.5	8.24	72.8	9.22
	14	37.0	4.61	44.2	5.46	51.2	6.41	54.9	6.86	58.5	7.36	65.5	8.41	72.8	9.39
	16	37.0	4.68	44.2	5.56	51.2	6.51	54.9	7.00	58.5	7.50	65.5	8.55	72.8	9.60
	18	37.0	4.75	44.2	5.67	51.2	6.65	54.9	7.14	58.5	7.64	65.5	8.69	72.8	9.76
	20	37.0	4.82	44.2	5.77	51.2	6.76	54.9	7.29	58.5	7.81	65.5	8.90	72.8	10.14
	21	37.0	4.89	44.2	5.81	51.2	6.83	54.9	7.36	58.5	7.88	65.5	9.05	72.8	10.35
	23	37.0	4.96	44.2	5.95	51.2	6.97	54.9	7.60	58.5	8.27	65.5	9.68	72.8	10.93
	25	37.0	5.03	44.2	6.16	51.2	7.43	54.9	8.13	58.5	8.83	65.5	10.35	72.8	11.46
	27	37.0	5.31	44.2	6.58	51.2	7.92	54.9	8.62	58.5	9.43	65.5	11.05	72.8	12.18
	29	37.0	5.67	44.2	6.97	51.2	8.41	54.9	9.19	58.5	10.03	65.5	11.79	72.8	13.05
	31	37.0	6.02	44.2	7.43	51.2	8.97	54.9	9.82	58.5	10.70	65.5	12.56	72.8	13.85
	33	37.0	6.37	44.2	7.85	51.2	9.54	54.9	10.42	58.5	11.37	65.5	13.37	72.8	14.74
	35	37.0	6.72	44.2	8.38	51.2	10.14	54.9	11.09	58.5	12.11	65.5	14.25	72.8	15.63
	37	37.0	7.14	44.2	8.87	51.2	10.77	54.9	11.79	58.5	12.88	65.5	15.17	72.8	16.49
	39	37.0	7.59	44.2	9.46	51.2	11.52	54.9	12.69	58.5	13.91	65.5	16.23	72.8	17.78
	41	36.0	8.39	43.1	10.36	49.9	12.63	53.5	13.91	57.0	15.13	63.8	17.83	70.9	19.18
43	35.1	9.13	42.0	11.30	48.7	13.78	52.2	15.17	55.6	16.52	62.3	19.48	69.2	20.74	
46	32.9	10.15	39.4	12.70	45.6	15.52	48.9	16.90	52.1	18.62	58.4	21.97	64.8	23.12	
48	29.1	8.85	34.9	11.09	40.4	13.57	43.2	14.77	46.1	16.29	51.6	19.23	57.4	19.90	
60	10	31.6	3.89	37.8	4.56	44.0	5.30	47.0	5.69	50.1	6.04	56.3	6.86	62.4	7.67
	12	31.6	3.96	37.8	4.63	44.0	5.37	47.0	5.76	50.1	6.15	56.3	6.96	62.4	7.81
	14	31.6	3.99	37.8	4.70	44.0	5.48	47.0	5.87	50.1	6.26	56.3	7.11	62.4	7.95
	16	31.6	4.07	37.8	4.81	44.0	5.55	47.0	5.97	50.1	6.40	56.3	7.25	62.4	8.09
	18	31.6	4.14	37.8	4.88	44.0	5.66	47.0	6.08	50.1	6.50	56.3	7.35	62.4	8.27
	20	31.6	4.21	37.8	4.95	44.0	5.76	47.0	6.19	50.1	6.61	56.3	7.49	62.4	8.45
	21	31.6	4.24	37.8	4.98	44.0	5.83	47.0	6.26	50.1	6.68	56.3	7.60	62.4	8.52
	23	31.6	4.31	37.8	5.09	44.0	5.90	47.0	6.36	50.1	6.82	56.3	7.88	62.4	9.05
	25	31.6	4.38	37.8	5.20	44.0	6.15	47.0	6.68	50.1	7.25	56.3	8.41	62.4	9.69
	27	31.6	4.52	37.8	5.48	44.0	6.54	47.0	7.11	50.1	7.71	56.3	8.94	62.4	10.32
	29	31.6	4.81	37.8	5.83	44.0	6.96	47.0	7.56	50.1	8.20	56.3	9.54	62.4	11.03
	31	31.6	5.09	37.8	6.19	44.0	7.39	47.0	8.06	50.1	8.73	56.3	10.18	62.4	11.74
	33	31.6	5.37	37.8	6.54	44.0	7.85	47.0	8.55	50.1	9.30	56.3	10.82	62.4	12.51
	35	31.6	5.69	37.8	6.96	44.0	8.34	47.0	9.08	50.1	9.86	56.3	11.52	62.4	13.29
	37	31.6	6.01	37.8	7.35	44.0	8.84	47.0	9.65	50.1	10.46	56.3	12.23	62.4	14.14
	39	31.6	6.39	37.8	7.83	44.0	9.54	47.0	10.35	50.1	11.26	56.3	13.11	62.4	15.15
	41	30.8	6.93	36.8	8.56	42.8	10.36	45.8	11.31	48.8	12.22	54.8	14.39	60.8	16.46
43	30.1	7.53	35.9	9.32	41.8	11.29	44.7	12.32	47.6	13.33	53.5	15.71	59.3	17.98	
46	28.2	8.44	33.7	10.47	39.2	12.70	41.9	13.85	44.6	15.00	50.1	17.70	55.6	20.49	
48	24.9	7.35	29.8	9.14	34.6	11.10	37.1	12.10	39.5	13.11	44.3	15.48	49.2	17.93	
50	10	26.5	3.37	31.6	3.91	36.7	4.44	39.2	4.76	41.7	5.04	46.8	5.68	52.1	6.32
	12	26.5	3.41	31.6	3.94	36.7	4.51	39.2	4.83	41.7	5.15	46.8	5.79	52.1	6.43
	14	26.5	3.44	31.6	4.01	36.7	4.58	39.2	4.90	41.7	5.22	46.8	5.86	52.1	6.53
	16	26.5	3.51	31.6	4.08	36.7	4.65	39.2	5.01	41.7	5.29	46.8	5.96	52.1	6.64
	18	26.5	3.55	31.6	4.12	36.7	4.72	39.2	5.08	41.7	5.40	46.8	6.07	52.1	6.78
	20	26.5	3.59	31.6	4.19	36.7	4.83	39.2	5.15	41.7	5.50	46.8	6.18	52.1	6.92
	21	26.5	3.62	31.6	4.22	36.7	4.86	39.2	5.22	41.7	5.54	46.8	6.25	52.1	6.99
	23	26.5	3.69	31.6	4.30	36.7	4.93	39.2	5.29	41.7	5.64	46.8	6.35	52.1	7.14
	25	26.5	3.73	31.6	4.37	36.7	5.04	39.2	5.40	41.7	5.82	46.8	6.67	52.1	7.63
	27	26.5	3.80	31.6	4.51	36.7	5.33	39.2	5.75	41.7	6.18	46.8	7.14	52.1	8.13
	29	26.5	4.01	31.6	4.79	36.7	5.64	39.2	6.11	41.7	6.57	46.8	7.56	52.1	8.63
	31	26.5	4.22	31.6	5.08	36.7	6.00	39.2	6.46	41.7	6.99	46.8	8.06	52.1	9.20
	33	26.5	4.47	31.6	5.36	36.7	6.35	39.2	6.85	41.7	7.42	46.8	8.56	52.1	9.80
	35	26.5	4.72	31.6	5.68	36.7	6.71	39.2	7.28	41.7	7.85	46.8	9.05	52.1	10.40
	37	26.5	5.01	31.6	6.00	36.7	7.10	39.2	7.70	41.7	8.31	46.8	9.66	52.1	11.04
	39	26.5	5.34	31.6	6.43	36.7	7.61	39.2	8.29	41.7	8.91	46.8	10.29	52.1	11.93
	41	25.8	5.77	30.8	6.96	35.7	8.32	38.2	8.98	40.7	9.66	45.6	11.27	50.7	12.95
43	25.1	6.27	30.1	7.57	34.9	9.05	37.3	9.78	39.6	10.51	44.4	12.29	49.5	14.13	
46	23.6	7.03	28.2	8.49	32.7	10.15	34.9	10.98	37.2	11.80	41.6	13.83	46.4	15.90	
48	20.8	6.12	24.9	7.41	28.9	8.86	30.9	9.59	32.9	10.30	36.8	12.09	41.0	13.90	

**Note**

1. TC: Total Capacity(kW), PI : Power Input(kW, Comp. + Outdoor fan motor)
2. Capacity tables show the average value of conditions which may occur.

# 7. Capacity Tables

◆ ARUM300LTE5

Cooling Capacity (30HP)

Combination (%)	Outdoor air temp. (DB, °C)	Indoor air temp. (DB/WB, °C)													
		20		23		26		27		28		30		32	
		14	16	18	19	20	22	24	TC	PI	TC	PI	TC	PI	
130	10	83.2	7.95	99.1	9.72	106.2	11.27	109.2	11.50	112.3	11.59	117.7	11.68	120.7	11.73
	12	83.2	8.15	99.1	10.06	106.2	11.73	109.2	11.81	112.3	11.90	117.7	12.00	120.7	12.11
	14	83.2	8.42	99.1	10.43	106.2	12.18	109.2	12.26	112.3	12.36	117.7	12.46	120.7	12.57
	16	83.2	8.73	99.1	10.79	106.2	12.72	109.2	12.84	112.3	12.94	117.7	13.06	120.7	13.16
	18	83.2	9.09	99.1	11.41	106.2	13.31	109.2	13.59	112.3	13.70	117.7	13.84	120.7	13.93
	20	83.2	9.49	99.1	12.16	106.2	13.96	109.2	14.95	112.3	15.07	116.0	15.22	119.0	15.32
	21	83.2	9.74	99.1	12.59	106.2	14.25	109.2	15.82	112.3	15.95	115.3	16.11	118.4	16.22
	23	83.2	10.45	99.1	13.24	106.2	15.00	109.2	17.46	110.9	17.60	113.6	17.77	116.7	17.89
	25	83.2	11.17	99.1	14.00	106.2	16.02	107.9	19.36	109.2	19.52	112.3	19.71	115.3	19.85
	27	83.2	11.95	99.1	14.97	104.9	17.07	106.2	21.31	107.9	21.49	110.9	21.70	113.6	21.85
	29	83.2	12.73	99.1	16.00	103.1	18.37	104.6	23.43	106.2	23.57	109.2	23.78	112.3	23.87
	31	83.2	13.58	98.8	16.86	101.4	19.54	103.1	23.33	104.6	23.47	107.5	23.68	110.6	23.77
	33	83.2	14.47	97.1	17.86	100.1	20.96	101.7	23.11	103.1	23.25	106.2	23.46	108.9	23.55
	35	83.2	15.43	95.3	18.71	98.4	22.70	100.1	22.81	101.7	22.95	104.5	23.15	107.5	23.25
	37	83.2	16.46	94.0	19.63	97.1	22.40	98.4	22.51	100.1	22.65	102.8	22.85	105.9	22.94
	39	83.2	17.52	92.3	20.66	95.3	22.10	97.1	22.21	98.4	22.34	101.4	22.54	104.5	22.63
41	81.1	18.59	88.5	21.70	91.5	21.80	92.9	21.91	94.7	22.04	97.5	22.24	100.2	22.32	
43	79.1	19.61	84.8	21.39	87.8	21.50	89.1	21.61	90.9	21.74	93.7	21.93	96.2	22.02	
46	74.1	20.99	77.4	20.94	80.2	21.05	81.4	21.16	83.1	21.28	85.7	21.47	88.1	21.56	
48	65.5	20.40	67.2	20.46	69.7	20.51	70.8	20.56	72.3	20.74	74.6	20.87	76.7	20.95	
120	10	75.3	7.15	89.5	8.77	97.8	10.42	100.8	11.26	103.8	11.44	109.4	11.49	112.1	11.58
	12	75.3	7.35	89.5	9.06	97.8	10.84	100.8	11.50	103.8	11.86	109.4	12.01	112.1	12.10
	14	75.3	7.60	89.5	9.37	97.8	11.28	100.8	11.94	103.8	12.30	109.4	12.48	112.1	12.58
	16	75.3	7.87	89.5	9.76	97.8	11.71	100.8	12.38	103.8	12.87	109.4	13.02	112.1	13.13
	18	75.3	8.18	89.5	10.20	97.8	12.18	100.8	13.03	103.8	13.53	109.4	13.68	112.1	13.79
	20	75.3	8.49	89.5	10.81	97.8	12.84	100.8	13.72	103.8	14.24	109.4	14.43	112.1	14.55
	21	75.3	8.75	89.5	11.20	97.8	13.20	100.8	14.12	103.8	14.71	109.4	14.90	112.1	15.02
	23	75.3	9.35	89.5	11.98	97.8	14.14	100.8	15.00	103.8	15.68	109.4	15.84	112.1	15.97
	25	75.3	9.99	89.5	12.84	97.8	14.91	100.8	15.99	103.8	16.82	108.1	16.96	110.7	17.10
	27	75.3	10.67	89.5	13.73	97.8	15.87	100.8	17.09	103.8	18.07	106.5	18.20	109.1	18.34
	29	75.3	11.38	89.5	14.65	97.8	16.70	100.8	18.29	102.1	19.26	104.8	19.55	107.8	19.71
	31	75.3	12.13	89.5	15.65	97.8	17.57	99.5	19.59	100.8	20.66	103.5	21.03	106.1	21.20
	33	75.3	12.91	89.5	16.68	96.5	18.58	97.8	21.26	99.1	22.19	101.8	22.44	104.5	22.62
	35	75.3	13.73	89.5	17.78	94.8	19.67	96.2	23.43	97.8	23.54	100.5	23.61	103.1	23.80
	37	75.3	14.76	89.5	18.76	93.5	20.97	94.8	22.93	96.2	23.05	98.8	23.12	101.5	23.30
	39	75.3	15.89	89.2	19.83	91.9	22.24	93.2	22.46	94.5	22.57	97.5	22.64	100.1	22.82
41	73.4	17.02	85.3	20.90	88.2	21.80	89.4	21.99	90.7	22.10	93.4	22.17	96.0	22.34	
43	71.5	18.17	81.7	20.60	84.6	21.31	85.8	21.52	87.1	21.63	89.6	21.69	92.2	21.86	
46	67.0	19.54	74.5	20.11	77.2	20.64	78.4	20.81	79.6	20.92	82.0	20.98	84.4	21.15	
48	59.3	19.14	64.7	19.75	67.1	20.24	68.1	20.36	69.2	20.43	71.3	20.51	73.5	20.59	
110	10	67.4	6.43	80.4	7.84	89.8	9.31	92.4	10.08	98.2	10.85	100.5	11.15	107.3	11.34
	12	67.4	6.63	80.4	8.10	89.8	9.70	92.4	10.37	98.2	11.26	100.5	11.62	107.3	11.89
	14	67.4	6.84	80.4	8.47	89.8	10.14	92.4	10.88	98.2	11.82	100.5	12.16	107.3	12.42
	16	67.4	7.08	80.4	8.78	89.8	10.56	92.4	11.35	98.2	12.37	100.5	12.71	107.3	12.93
	18	67.4	7.35	80.4	9.14	89.8	11.17	92.4	11.96	98.2	13.05	100.5	13.31	107.3	13.55
	20	67.4	7.61	80.4	9.60	89.8	11.84	92.4	12.51	98.2	13.68	100.5	14.02	107.3	14.24
	21	67.4	7.78	80.4	9.89	89.8	12.15	92.4	12.84	98.2	14.06	100.5	14.42	107.3	14.64
	23	67.4	8.29	80.4	10.60	89.8	12.82	92.4	13.56	98.2	14.86	100.5	15.17	107.3	15.42
	25	67.4	8.85	80.4	11.31	89.8	13.55	92.4	14.33	98.2	15.69	100.5	15.92	106.0	16.25
	27	67.4	9.46	80.4	12.09	89.8	14.32	92.4	15.17	98.2	16.39	100.5	16.77	104.4	17.05
	29	67.4	10.10	80.4	12.91	89.8	15.13	92.4	16.06	98.2	17.32	100.5	17.62	103.1	17.89
	31	67.4	10.74	80.4	13.76	89.8	15.99	92.4	17.02	96.6	18.20	99.2	18.56	101.5	18.75
	33	67.4	11.45	80.4	14.65	89.8	16.89	92.4	18.04	95.3	19.22	97.6	19.54	100.2	19.65
	35	67.4	12.16	80.4	15.65	89.8	17.84	92.4	19.11	93.7	20.29	96.0	20.47	98.6	20.57
	37	67.4	12.89	80.4	16.61	89.8	18.83	91.1	20.25	92.1	21.40	94.7	21.47	96.9	21.53
	39	67.4	13.90	80.4	17.65	88.2	19.87	89.5	21.66	90.8	22.46	93.0	22.49	95.7	22.52
41	65.7	14.90	78.3	18.69	84.4	20.95	85.7	23.43	86.8	23.43	89.4	23.61	91.6	23.80	
43	64.1	15.65	76.4	19.47	80.9	22.22	82.2	22.47	83.3	22.42	85.8	22.55	87.9	22.61	
46	60.1	15.27	71.6	18.79	73.8	21.09	75.1	21.09	76.1	21.27	78.4	21.39	80.4	21.44	
48	53.1	14.83	62.2	18.11	64.1	20.06	65.3	20.20	66.1	20.30	68.2	20.35	70.0	20.43	

# 7. Capacity Tables

Cooling Capacity (30HP)

Combination (%)	Outdoor air temp. (DB, °C)	Indoor air temp. (DB/WB, °C)													
		20		23		26		27		28		30		32	
		14		16		18		19		20		22		24	
		TC	PI	TC	PI	TC	PI	TC	PI	TC	PI	TC	PI	TC	PI
100	10	56.7	5.79	67.5	7.04	78.6	8.35	84.0	9.03	89.4	9.70	99.1	10.80	101.3	10.88
	12	56.7	5.98	67.5	7.33	78.6	8.63	84.0	9.27	89.4	10.01	99.1	11.38	101.3	11.49
	14	56.7	6.17	67.5	7.62	78.6	9.00	84.0	9.67	89.4	10.44	99.1	12.01	101.3	12.12
	16	56.7	6.35	67.5	7.87	78.6	9.38	84.0	10.13	89.4	11.00	99.1	12.59	101.3	12.77
	18	56.7	6.54	67.5	8.17	78.6	9.75	84.0	10.62	89.4	11.66	99.1	13.30	101.3	13.41
	20	56.7	6.77	67.5	8.47	78.6	10.31	84.0	11.38	89.4	12.48	99.1	13.94	101.3	14.05
	21	56.7	6.92	67.5	8.68	78.6	10.67	84.0	11.77	89.4	12.94	99.1	14.26	101.3	14.37
	23	56.7	7.33	67.5	9.28	78.6	11.45	84.0	12.62	89.4	13.87	99.1	14.93	101.3	15.05
	25	56.7	7.79	67.5	9.89	78.6	12.23	84.0	13.51	89.4	14.83	99.1	15.57	100.4	15.69
	27	56.7	8.32	67.5	10.56	78.6	13.09	84.0	14.44	89.4	15.77	97.2	16.30	99.2	16.43
	29	56.7	8.85	67.5	11.27	78.6	13.97	84.0	15.43	89.4	16.69	95.4	16.96	97.7	17.09
	31	56.7	9.46	67.5	12.02	78.6	14.90	84.0	16.46	89.4	17.53	94.0	17.61	96.2	17.75
	33	56.7	10.03	67.5	12.80	78.6	15.90	84.0	17.57	89.4	18.19	92.4	18.27	94.7	18.42
	35	56.7	10.67	67.5	13.62	78.6	16.93	84.0	18.74	88.0	18.85	90.8	18.93	93.1	19.08
	37	56.7	11.42	67.5	14.61	78.6	17.93	84.0	19.63	86.6	19.73	89.1	19.81	91.2	19.99
	39	56.7	12.25	67.5	15.69	78.6	19.00	84.0	20.59	85.1	20.68	87.7	20.76	89.7	20.95
	41	55.8	13.07	66.4	16.78	77.4	20.07	80.6	21.55	82.4	21.64	84.3	21.71	87.0	21.92
	43	53.9	13.84	64.1	17.78	74.7	21.03	77.3	22.38	78.2	22.46	80.6	22.53	82.7	22.74
46	50.5	14.88	60.1	19.17	70.0	22.31	70.6	23.43	71.3	23.49	73.6	23.56	75.6	23.79	
48	44.7	12.85	53.2	16.59	60.4	19.07	61.3	19.88	62.0	19.94	64.0	19.99	65.7	20.15	
90	10	51.0	5.44	60.9	6.54	70.8	7.71	75.6	8.31	80.4	8.94	90.3	10.01	100.2	10.88
	12	51.0	5.51	60.9	6.64	70.8	7.84	75.6	8.48	80.4	9.15	90.3	10.21	100.2	11.33
	14	51.0	5.61	60.9	6.78	70.8	8.01	75.6	8.64	80.4	9.31	90.3	10.41	100.2	11.56
	16	51.0	5.71	60.9	6.91	70.8	8.18	75.6	8.81	80.4	9.48	90.3	10.61	100.2	11.76
	18	51.0	5.81	60.9	7.04	70.8	8.31	75.6	9.01	80.4	9.68	90.3	10.84	100.2	12.35
	20	51.0	5.91	60.9	7.18	70.8	8.48	75.6	9.18	80.4	10.05	90.3	11.60	100.2	12.94
	21	51.0	5.97	60.9	7.24	70.8	8.64	75.6	9.48	80.4	10.41	90.3	11.79	100.2	13.24
	23	51.0	6.11	60.9	7.54	70.8	9.25	75.6	10.18	80.4	11.15	90.3	12.50	98.8	13.86
	25	51.0	6.41	60.9	8.04	70.8	9.88	75.6	10.88	80.4	11.92	90.3	13.37	97.4	14.45
	27	51.0	6.84	60.9	8.58	70.8	10.55	75.6	11.62	80.4	12.75	90.3	14.21	96.0	15.13
	29	51.0	7.24	60.9	9.15	70.8	11.28	75.6	12.42	80.4	13.62	90.3	15.05	94.5	15.74
	31	51.0	7.71	60.9	9.75	70.8	12.02	75.6	13.22	80.4	14.52	90.3	15.80	93.1	16.35
	33	51.0	8.21	60.9	10.38	70.8	12.82	75.6	14.08	80.4	15.40	90.3	16.57	91.7	16.96
	35	51.0	8.71	60.9	11.01	70.8	13.62	75.6	15.02	80.4	16.33	88.7	17.52	90.3	17.92
	37	51.0	9.25	60.9	11.72	70.8	14.52	75.6	15.96	80.4	17.24	87.3	18.31	88.8	18.72
	39	51.0	9.79	60.9	12.46	70.8	15.37	75.6	16.98	80.4	18.13	85.9	19.31	87.4	19.54
	41	49.7	10.95	59.3	13.81	69.0	16.87	73.7	18.57	78.3	19.57	82.3	20.35	83.8	20.81
	43	48.5	11.82	57.9	14.93	67.3	18.42	71.8	20.00	76.4	20.98	78.9	21.75	80.3	22.05
46	45.4	13.31	54.2	17.00	63.1	20.99	67.3	22.67	69.4	23.31	72.0	23.56	73.4	23.77	
48	40.2	11.63	48.0	14.87	55.8	18.37	59.6	19.77	60.3	19.93	62.6	19.99	63.8	20.15	
80	10	45.3	5.08	54.0	6.10	62.7	7.16	67.2	7.73	71.7	8.29	80.4	9.46	89.1	10.27
	12	45.3	5.19	54.0	6.18	62.7	7.30	67.2	7.87	71.7	8.43	80.4	9.63	89.1	10.47
	14	45.3	5.26	54.0	6.32	62.7	7.41	67.2	8.01	71.7	8.58	80.4	9.81	89.1	10.67
	16	45.3	5.33	54.0	6.42	62.7	7.55	67.2	8.15	71.7	8.75	80.4	10.02	89.1	10.88
	18	45.3	5.43	54.0	6.53	62.7	7.69	67.2	8.29	71.7	8.93	80.4	10.20	89.1	11.11
	20	45.3	5.54	54.0	6.67	62.7	7.87	67.2	8.47	71.7	9.10	80.4	10.59	89.1	11.78
	21	45.3	5.58	54.0	6.74	62.7	7.94	67.2	8.58	71.7	9.32	80.4	10.92	89.1	12.09
	23	45.3	5.68	54.0	6.85	62.7	8.29	67.2	9.10	71.7	9.95	80.4	11.53	89.1	12.69
	25	45.3	5.89	54.0	7.30	62.7	8.89	67.2	9.74	71.7	10.66	80.4	12.34	89.1	13.57
	27	45.3	6.25	54.0	7.76	62.7	9.49	67.2	10.41	71.7	11.36	80.4	13.11	89.1	14.27
	29	45.3	6.63	54.0	8.29	62.7	10.09	67.2	11.08	71.7	12.14	80.4	14.05	89.1	14.95
	31	45.3	7.06	54.0	8.79	62.7	10.76	67.2	11.82	71.7	12.92	80.4	14.91	89.1	15.70
	33	45.3	7.48	54.0	9.39	62.7	11.47	67.2	12.60	71.7	13.76	80.4	15.71	89.1	16.45
	35	45.3	7.94	54.0	9.95	62.7	12.21	67.2	13.41	71.7	14.68	80.4	16.66	88.2	17.38
	37	45.3	8.40	54.0	10.58	62.7	12.95	67.2	14.26	71.7	15.60	80.4	17.58	86.7	18.22
	39	45.3	8.88	54.0	11.19	62.7	13.85	67.2	15.33	71.7	16.76	80.4	18.57	85.3	19.22
	41	44.1	9.82	52.6	12.40	61.1	15.20	65.5	16.80	69.9	18.42	78.3	19.94	81.7	20.40
	43	43.0	10.81	51.3	13.53	59.6	16.60	63.9	18.31	68.1	20.13	76.4	21.32	78.3	21.83
46	40.3	12.03	48.1	15.24	55.8	18.70	59.8	20.38	63.9	22.71	69.9	23.56	71.5	23.77	
48	35.7	10.50	42.5	13.32	49.4	16.35	52.9	17.80	56.5	19.83	60.7	19.99	62.1	20.15	

# 7. Capacity Tables

Cooling Capacity (30HP)

Combination (%)	Outdoor air temp. (DB, °C)	Indoor air temp. (DB/WB, °C)													
		20		23		26		27		28		30		32	
		14		16		18		19		20		22		24	
		TC	PI	TC	PI	TC	PI	TC	PI	TC	PI	TC	PI	TC	PI
70	10	39.6	4.50	47.4	5.35	54.9	6.20	58.8	6.70	62.7	7.16	70.2	8.15	78.0	9.12
	12	39.6	4.57	47.4	5.42	54.9	6.34	58.8	6.81	62.7	7.30	70.2	8.29	78.0	9.29
	14	39.6	4.64	47.4	5.49	54.9	6.45	58.8	6.91	62.7	7.41	70.2	8.47	78.0	9.46
	16	39.6	4.71	47.4	5.60	54.9	6.56	58.8	7.05	62.7	7.55	70.2	8.61	78.0	9.66
	18	39.6	4.78	47.4	5.71	54.9	6.70	58.8	7.19	62.7	7.69	70.2	8.75	78.0	9.83
	20	39.6	4.86	47.4	5.81	54.9	6.81	58.8	7.34	62.7	7.87	70.2	8.97	78.0	10.21
	21	39.6	4.93	47.4	5.85	54.9	6.88	58.8	7.41	62.7	7.94	70.2	9.11	78.0	10.42
	23	39.6	5.00	47.4	5.99	54.9	7.02	58.8	7.66	62.7	8.33	70.2	9.75	78.0	11.01
	25	39.6	5.07	47.4	6.20	54.9	7.48	58.8	8.19	62.7	8.90	70.2	10.42	78.0	11.54
	27	39.6	5.35	47.4	6.63	54.9	7.97	58.8	8.68	62.7	9.50	70.2	11.13	78.0	12.26
	29	39.6	5.71	47.4	7.02	54.9	8.47	58.8	9.25	62.7	10.10	70.2	11.87	78.0	13.14
	31	39.6	6.06	47.4	7.48	54.9	9.04	58.8	9.89	62.7	10.77	70.2	12.65	78.0	13.94
	33	39.6	6.42	47.4	7.90	54.9	9.61	58.8	10.49	62.7	11.45	70.2	13.47	78.0	14.84
	35	39.6	6.77	47.4	8.44	54.9	10.21	58.8	11.16	62.7	12.19	70.2	14.35	78.0	15.74
	37	39.6	7.19	47.4	8.94	54.9	10.85	58.8	11.87	62.7	12.97	70.2	15.28	78.0	16.61
	39	39.6	7.64	47.4	9.53	54.9	11.60	58.8	12.77	62.7	14.01	70.2	16.35	78.0	17.91
	41	38.6	8.45	46.2	10.44	53.5	12.72	57.3	14.01	61.1	15.23	68.4	17.96	76.0	19.32
	43	37.6	9.19	45.0	11.38	52.2	13.88	55.9	15.28	59.6	16.63	66.7	19.62	74.1	20.89
46	35.3	10.22	42.2	12.79	48.9	15.63	52.4	17.02	55.8	18.75	62.5	22.12	69.5	23.28	
48	31.2	8.92	37.3	11.17	43.3	13.67	46.3	14.87	49.4	16.41	55.3	19.36	61.5	20.04	
60	10	33.9	3.92	40.5	4.59	47.1	5.34	50.4	5.73	53.7	6.09	60.3	6.91	66.9	7.72
	12	33.9	3.99	40.5	4.66	47.1	5.41	50.4	5.80	53.7	6.19	60.3	7.01	66.9	7.87
	14	33.9	4.02	40.5	4.73	47.1	5.52	50.4	5.91	53.7	6.30	60.3	7.16	66.9	8.01
	16	33.9	4.09	40.5	4.84	47.1	5.59	50.4	6.02	53.7	6.44	60.3	7.30	66.9	8.15
	18	33.9	4.16	40.5	4.91	47.1	5.70	50.4	6.12	53.7	6.55	60.3	7.40	66.9	8.33
	20	33.9	4.24	40.5	4.98	47.1	5.80	50.4	6.23	53.7	6.66	60.3	7.55	66.9	8.51
	21	33.9	4.27	40.5	5.02	47.1	5.87	50.4	6.30	53.7	6.73	60.3	7.65	66.9	8.58
	23	33.9	4.34	40.5	5.13	47.1	5.94	50.4	6.41	53.7	6.87	60.3	7.94	66.9	9.11
	25	33.9	4.41	40.5	5.23	47.1	6.19	50.4	6.73	53.7	7.30	60.3	8.47	66.9	9.75
	27	33.9	4.56	40.5	5.52	47.1	6.59	50.4	7.16	53.7	7.76	60.3	9.01	66.9	10.39
	29	33.9	4.84	40.5	5.87	47.1	7.01	50.4	7.62	53.7	8.26	60.3	9.61	66.9	11.11
	31	33.9	5.13	40.5	6.23	47.1	7.44	50.4	8.12	53.7	8.79	60.3	10.25	66.9	11.82
	33	33.9	5.41	40.5	6.59	47.1	7.90	50.4	8.61	53.7	9.36	60.3	10.89	66.9	12.60
	35	33.9	5.73	40.5	7.01	47.1	8.40	50.4	9.15	53.7	9.93	60.3	11.60	66.9	13.38
	37	33.9	6.05	40.5	7.40	47.1	8.90	50.4	9.72	53.7	10.54	60.3	12.32	66.9	14.24
	39	33.9	6.44	40.5	7.88	47.1	9.61	50.4	10.43	53.7	11.34	60.3	13.21	66.9	15.26
	41	33.0	6.98	39.5	8.62	45.9	10.43	49.1	11.39	52.3	12.31	58.8	14.49	65.2	16.58
	43	32.2	7.59	38.5	9.39	44.8	11.37	47.9	12.41	51.0	13.42	57.3	15.82	63.6	18.11
46	30.2	8.49	36.1	10.54	41.9	12.79	44.9	13.95	47.8	15.10	53.7	17.83	59.6	20.63	
48	26.7	7.40	31.9	9.20	37.1	11.17	39.7	12.19	42.3	13.20	47.5	15.59	52.7	18.05	
50	10	28.4	3.40	33.9	3.93	39.3	4.47	42.0	4.79	44.7	5.08	50.1	5.72	55.8	6.36
	12	28.4	3.43	33.9	3.97	39.3	4.54	42.0	4.86	44.7	5.18	50.1	5.83	55.8	6.47
	14	28.4	3.47	33.9	4.04	39.3	4.61	42.0	4.93	44.7	5.26	50.1	5.90	55.8	6.58
	16	28.4	3.54	33.9	4.11	39.3	4.68	42.0	5.04	44.7	5.33	50.1	6.01	55.8	6.69
	18	28.4	3.58	33.9	4.15	39.3	4.76	42.0	5.11	44.7	5.43	50.1	6.11	55.8	6.83
	20	28.4	3.61	33.9	4.22	39.3	4.86	42.0	5.18	44.7	5.54	50.1	6.22	55.8	6.97
	21	28.4	3.65	33.9	4.25	39.3	4.90	42.0	5.26	44.7	5.58	50.1	6.29	55.8	7.04
	23	28.4	3.72	33.9	4.33	39.3	4.97	42.0	5.33	44.7	5.68	50.1	6.40	55.8	7.19
	25	28.4	3.75	33.9	4.40	39.3	5.08	42.0	5.43	44.7	5.86	50.1	6.72	55.8	7.69
	27	28.4	3.83	33.9	4.54	39.3	5.36	42.0	5.79	44.7	6.22	50.1	7.19	55.8	8.19
	29	28.4	4.04	33.9	4.83	39.3	5.68	42.0	6.15	44.7	6.61	50.1	7.62	55.8	8.69
	31	28.4	4.25	33.9	5.11	39.3	6.04	42.0	6.51	44.7	7.04	50.1	8.12	55.8	9.26
	33	28.4	4.50	33.9	5.40	39.3	6.40	42.0	6.90	44.7	7.47	50.1	8.62	55.8	9.87
	35	28.4	4.76	33.9	5.72	39.3	6.76	42.0	7.33	44.7	7.90	50.1	9.12	55.8	10.48
	37	28.4	5.04	33.9	6.04	39.3	7.15	42.0	7.76	44.7	8.37	50.1	9.72	55.8	11.12
	39	28.4	5.38	33.9	6.48	39.3	7.66	42.0	8.35	44.7	8.98	50.1	10.36	55.8	12.01
	41	27.6	5.81	33.0	7.01	38.3	8.38	40.9	9.05	43.6	9.73	48.8	11.35	54.4	13.04
	43	26.9	6.32	32.2	7.63	37.3	9.11	39.9	9.85	42.5	10.59	47.6	12.38	53.0	14.23
46	25.2	7.08	30.2	8.55	35.0	10.23	37.4	11.06	39.8	11.89	44.6	13.93	49.7	16.02	
48	22.3	6.17	26.7	7.46	31.0	8.92	33.1	9.65	35.2	10.38	39.5	12.17	44.0	14.00	

**Note**

1. TC: Total Capacity(kW), PI : Power Input(kW, Comp. + Outdoor fan motor)
2. Capacity tables show the average value of conditions which may occur.



# 7. Capacity Tables

◆ ARUM320LTE5

Cooling Capacity (32HP)

Combination (%)	Outdoor air temp. (DB, °C)	Indoor air temp. (DB/WB, °C)													
		20		23		26		27		28		30		32	
		14	16	16	18	19	20	22	24						
130	10	88.7	8.68	105.7	10.61	113.3	12.31	116.5	12.56	119.8	12.66	125.5	12.76	128.8	12.81
	12	88.7	8.90	105.7	10.99	113.3	12.82	116.5	12.90	119.8	13.00	125.5	13.11	128.8	13.22
	14	88.7	9.20	105.7	11.39	113.3	13.30	116.5	13.40	119.8	13.50	125.5	13.61	128.8	13.73
	16	88.7	9.53	105.7	11.79	113.3	13.90	116.5	14.02	119.8	14.14	125.5	14.26	128.8	14.37
	18	88.7	9.93	105.7	12.47	113.3	14.53	116.5	14.85	119.8	14.96	125.5	15.11	128.8	15.22
	20	88.7	10.37	105.7	13.28	113.3	15.25	116.5	16.33	119.8	16.46	123.7	16.63	127.0	16.74
	21	88.7	10.64	105.7	13.75	113.3	15.57	116.5	17.28	119.8	17.42	123.0	17.59	126.3	17.71
	23	88.7	11.42	105.7	14.46	113.3	16.38	116.5	19.07	118.3	19.22	121.2	19.41	124.5	19.55
	25	88.7	12.20	105.7	15.30	113.3	17.50	115.1	21.15	116.5	21.32	119.8	21.53	123.0	21.68
	27	88.7	13.05	105.7	16.35	111.8	18.65	113.3	23.28	115.1	23.47	118.3	23.70	121.2	23.86
	29	88.7	13.91	105.7	17.48	110.0	20.06	111.6	25.59	113.3	25.74	116.5	25.97	119.8	26.07
	31	88.7	14.84	105.3	18.41	108.2	21.34	110.0	25.48	111.6	25.63	114.7	25.86	118.0	25.96
	33	88.7	15.81	103.5	19.51	106.8	22.89	108.5	25.25	110.0	25.40	113.3	25.63	116.1	25.73
	35	88.7	16.86	101.7	20.43	105.0	24.79	106.8	24.92	108.5	25.07	111.5	25.29	114.7	25.39
	37	88.7	17.98	100.3	21.44	103.5	24.47	105.0	24.59	106.8	24.74	109.7	24.96	112.9	25.06
	39	88.7	19.14	98.5	22.57	101.7	24.14	103.5	24.26	105.0	24.41	108.2	24.62	111.5	24.72
	41	86.5	20.31	94.4	23.70	97.6	23.81	99.1	23.93	101.0	24.07	104.0	24.29	106.8	24.39
	43	84.3	21.42	90.5	23.37	93.6	23.48	95.0	23.60	96.9	23.74	99.9	23.96	102.6	24.05
46	79.0	22.92	82.5	22.88	85.5	22.99	86.9	23.11	88.7	23.25	91.5	23.46	94.0	23.55	
48	69.9	22.29	71.7	22.35	74.4	22.40	75.5	22.46	77.2	22.65	79.6	22.80	81.8	22.89	
120	10	80.3	7.81	95.5	9.58	104.3	11.38	107.5	12.30	110.7	12.50	116.7	12.55	119.6	12.65
	12	80.3	8.02	95.5	9.90	104.3	11.84	107.5	12.56	110.7	12.96	116.7	13.12	119.6	13.22
	14	80.3	8.30	95.5	10.24	104.3	12.32	107.5	13.04	110.7	13.43	116.7	13.63	119.6	13.74
	16	80.3	8.60	95.5	10.66	104.3	12.79	107.5	13.52	110.7	14.05	116.7	14.23	119.6	14.34
	18	80.3	8.94	95.5	11.14	104.3	13.31	107.5	14.24	110.7	14.78	116.7	14.94	119.6	15.06
	20	80.3	9.27	95.5	11.81	104.3	14.02	107.5	14.98	110.7	15.56	116.7	15.76	119.6	15.89
	21	80.3	9.56	95.5	12.24	104.3	14.42	107.5	15.42	110.7	16.07	116.7	16.27	119.6	16.40
	23	80.3	10.22	95.5	13.09	104.3	15.45	107.5	16.39	110.7	17.13	116.7	17.31	119.6	17.44
	25	80.3	10.91	95.5	14.02	104.3	16.29	107.5	17.47	110.7	18.37	115.3	18.53	118.1	18.67
	27	80.3	11.65	95.5	14.99	104.3	17.34	107.5	18.66	110.7	19.74	113.5	19.88	116.4	20.04
	29	80.3	12.43	95.5	16.00	104.3	18.24	107.5	19.97	108.9	21.04	111.8	21.36	114.9	21.53
	31	80.3	13.25	95.5	17.09	104.3	19.19	106.1	21.40	107.5	22.57	110.4	22.97	113.2	23.16
	33	80.3	14.10	95.5	18.22	102.9	20.30	104.3	23.23	105.7	24.23	108.6	24.51	111.4	24.71
	35	80.3	14.99	95.5	19.42	101.2	21.48	102.6	25.59	104.3	25.72	107.2	25.79	110.0	26.00
	37	80.3	16.13	95.5	20.49	99.7	22.90	101.2	25.05	102.6	25.17	105.4	25.25	108.2	25.45
	39	80.3	17.36	95.1	21.66	98.0	24.29	99.4	24.53	100.8	24.66	104.0	24.73	106.8	24.93
	41	78.3	18.60	91.0	22.83	94.1	23.81	95.4	24.02	96.8	24.14	99.6	24.21	102.4	24.40
	43	76.3	19.85	87.2	22.50	90.2	23.28	91.5	23.51	92.9	23.62	95.6	23.69	98.4	23.88
46	71.5	21.34	79.5	21.96	82.4	22.55	83.6	22.73	84.9	22.85	87.4	22.92	90.0	23.10	
48	63.3	20.91	69.0	21.57	71.6	22.11	72.7	22.24	73.8	22.31	76.1	22.40	78.4	22.49	
110	10	71.9	7.03	85.8	8.56	95.8	10.17	98.5	11.01	104.8	11.85	107.2	12.18	114.5	12.38
	12	71.9	7.25	85.8	8.85	95.8	10.59	98.5	11.32	104.8	12.30	107.2	12.69	114.5	12.99
	14	71.9	7.47	85.8	9.25	95.8	11.08	98.5	11.88	104.8	12.92	107.2	13.28	114.5	13.56
	16	71.9	7.74	85.8	9.59	95.8	11.53	98.5	12.40	104.8	13.51	107.2	13.88	114.5	14.12
	18	71.9	8.02	85.8	9.99	95.8	12.20	98.5	13.06	104.8	14.25	107.2	14.53	114.5	14.80
	20	71.9	8.31	85.8	10.49	95.8	12.93	98.5	13.66	104.8	14.94	107.2	15.31	114.5	15.56
	21	71.9	8.50	85.8	10.80	95.8	13.27	98.5	14.03	104.8	15.36	107.2	15.75	114.5	15.99
	23	71.9	9.05	85.8	11.58	95.8	14.01	98.5	14.81	104.8	16.23	107.2	16.57	114.5	16.85
	25	71.9	9.67	85.8	12.35	95.8	14.80	98.5	15.66	104.8	17.14	107.2	17.39	113.1	17.75
	27	71.9	10.33	85.8	13.21	95.8	15.64	98.5	16.57	104.8	17.91	107.2	18.31	111.4	18.63
	29	71.9	11.03	85.8	14.10	95.8	16.53	98.5	17.55	104.8	18.92	107.2	19.25	110.0	19.54
	31	71.9	11.73	85.8	15.03	95.8	17.46	98.5	18.59	103.1	19.88	105.8	20.27	108.3	20.48
	33	71.9	12.51	85.8	16.00	95.8	18.45	98.5	19.70	101.7	21.00	104.1	21.34	106.8	21.46
	35	71.9	13.28	85.8	17.09	95.8	19.49	98.5	20.88	100.0	22.16	102.4	22.36	105.1	22.47
	37	71.9	14.08	85.8	18.14	95.8	20.57	97.2	22.12	98.2	23.37	101.0	23.45	103.4	23.52
	39	71.9	15.18	85.8	19.28	94.1	21.70	95.4	23.66	96.8	24.53	99.2	24.57	102.0	24.59
	41	70.1	16.28	83.6	20.41	90.0	22.89	91.4	25.59	92.6	25.59	95.3	25.79	97.7	26.00
	43	68.4	17.09	81.5	21.27	86.3	24.27	87.7	24.54	88.8	24.49	91.5	24.63	93.8	24.70
46	64.1	16.68	76.4	20.53	78.7	23.03	80.1	23.03	81.1	23.23	83.6	23.36	85.8	23.42	
48	56.7	16.20	66.4	19.78	68.4	21.92	69.6	22.06	70.5	22.17	72.7	22.23	74.6	22.32	

# 7. Capacity Tables

Cooling Capacity (32HP)

Combination (%)	Outdoor air temp. (DB, °C)	Indoor air temp. (DB/WB, °C)													
		20		23		26		27		28		30		32	
		14		16		18		19		20		22		24	
		TC	PI	TC	PI	TC	PI	TC	PI	TC	PI	TC	PI	TC	PI
100	10	60.5	6.33	72.0	7.69	83.8	9.12	89.6	9.86	95.4	10.59	105.7	11.79	108.0	11.89
	12	60.5	6.53	72.0	8.00	83.8	9.43	89.6	10.12	95.4	10.93	105.7	12.43	108.0	12.55
	14	60.5	6.73	72.0	8.32	83.8	9.83	89.6	10.56	95.4	11.40	105.7	13.12	108.0	13.24
	16	60.5	6.94	72.0	8.60	83.8	10.25	89.6	11.06	95.4	12.02	105.7	13.75	108.0	13.95
	18	60.5	7.14	72.0	8.92	83.8	10.65	89.6	11.60	95.4	12.74	105.7	14.53	108.0	14.65
	20	60.5	7.40	72.0	9.26	83.8	11.26	89.6	12.43	95.4	13.63	105.7	15.23	108.0	15.35
	21	60.5	7.55	72.0	9.48	83.8	11.65	89.6	12.86	95.4	14.14	105.7	15.58	108.0	15.70
	23	60.5	8.00	72.0	10.14	83.8	12.51	89.6	13.79	95.4	15.15	105.7	16.31	108.0	16.44
	25	60.5	8.51	72.0	10.80	83.8	13.36	89.6	14.76	95.4	16.20	105.7	17.01	107.1	17.14
	27	60.5	9.09	72.0	11.54	83.8	14.29	89.6	15.77	95.4	17.22	103.7	17.81	105.9	17.95
	29	60.5	9.67	72.0	12.31	83.8	15.27	89.6	16.86	95.4	18.23	101.7	18.52	104.3	18.67
	31	60.5	10.33	72.0	13.13	83.8	16.28	89.6	17.98	95.4	19.15	100.2	19.24	102.7	19.39
	33	60.5	10.95	72.0	13.98	83.8	17.36	89.6	19.19	95.4	19.87	98.6	19.96	101.1	20.12
	35	60.5	11.65	72.0	14.88	83.8	18.49	89.6	20.47	93.9	20.59	96.8	20.67	99.3	20.84
	37	60.5	12.48	72.0	15.96	83.8	19.59	89.6	21.44	92.4	21.55	95.0	21.64	97.3	21.84
	39	60.5	13.38	72.0	17.14	83.8	20.75	89.6	22.49	90.8	22.59	93.5	22.68	95.7	22.89
	41	59.5	14.28	70.9	18.32	82.5	21.92	86.0	23.54	87.9	23.63	89.9	23.72	92.8	23.94
	43	57.5	15.11	68.4	19.43	79.7	22.97	82.4	24.44	83.4	24.53	86.0	24.61	88.2	24.84
46	53.9	16.26	64.1	20.94	74.7	24.36	75.3	25.59	76.1	25.66	78.5	25.74	80.6	25.98	
48	47.6	14.04	56.7	18.12	64.5	20.83	65.4	21.71	66.1	21.78	68.3	21.83	70.1	22.00	
90	10	54.4	5.95	65.0	7.15	75.5	8.43	80.6	9.08	85.8	9.78	96.3	10.94	106.9	11.89
	12	54.4	6.02	65.0	7.26	75.5	8.57	80.6	9.26	85.8	9.99	96.3	11.16	106.9	12.38
	14	54.4	6.13	65.0	7.40	75.5	8.75	80.6	9.45	85.8	10.18	96.3	11.37	106.9	12.63
	16	54.4	6.24	65.0	7.55	75.5	8.94	80.6	9.63	85.8	10.36	96.3	11.59	106.9	12.85
	18	54.4	6.35	65.0	7.70	75.5	9.08	80.6	9.85	85.8	10.58	96.3	11.84	106.9	13.50
	20	54.4	6.46	65.0	7.84	75.5	9.26	80.6	10.03	85.8	10.98	96.3	12.67	106.9	14.14
	21	54.4	6.53	65.0	7.92	75.5	9.45	80.6	10.36	85.8	11.38	96.3	12.88	106.9	14.47
	23	54.4	6.67	65.0	8.24	75.5	10.10	80.6	11.12	85.8	12.18	96.3	13.66	105.4	15.15
	25	54.4	7.00	65.0	8.79	75.5	10.80	80.6	11.89	85.8	13.02	96.3	14.61	103.9	15.79
	27	54.4	7.48	65.0	9.37	75.5	11.53	80.6	12.69	85.8	13.93	96.3	15.53	102.4	16.54
	29	54.4	7.92	65.0	9.99	75.5	12.33	80.6	13.57	85.8	14.88	96.3	16.45	100.8	17.20
	31	54.4	8.43	65.0	10.65	75.5	13.13	80.6	14.44	85.8	15.87	96.3	17.27	99.3	17.87
	33	54.4	8.97	65.0	11.34	75.5	14.01	80.6	15.39	85.8	16.83	96.3	18.11	97.8	18.53
	35	54.4	9.52	65.0	12.04	75.5	14.88	80.6	16.41	85.8	17.85	94.7	19.14	96.3	19.58
	37	54.4	10.10	65.0	12.80	75.5	15.87	80.6	17.44	85.8	18.84	93.1	20.01	94.8	20.46
	39	54.4	10.70	65.0	13.62	75.5	16.79	80.6	18.55	85.8	19.81	91.6	21.10	93.2	21.35
	41	53.0	11.97	63.3	15.10	73.6	18.43	78.6	20.29	83.6	21.39	87.8	22.24	89.4	22.75
	43	51.7	12.92	61.7	16.31	71.8	20.14	76.6	21.85	81.5	22.93	84.2	23.77	85.7	24.10
46	48.4	14.54	57.9	18.58	67.3	22.94	71.8	24.78	74.1	25.48	76.8	25.74	78.3	25.97	
48	42.9	12.71	51.2	16.25	59.5	20.07	63.5	21.60	64.3	21.77	66.8	21.83	68.0	22.00	
80	10	48.3	5.55	57.6	6.67	66.9	7.83	71.7	8.45	76.5	9.06	85.8	10.34	95.0	11.22
	12	48.3	5.67	57.6	6.75	66.9	7.98	71.7	8.60	76.5	9.22	85.8	10.53	95.0	11.44
	14	48.3	5.75	57.6	6.90	66.9	8.10	71.7	8.76	76.5	9.37	85.8	10.72	95.0	11.67
	16	48.3	5.82	57.6	7.02	66.9	8.25	71.7	8.91	76.5	9.57	85.8	10.95	95.0	11.89
	18	48.3	5.94	57.6	7.14	66.9	8.41	71.7	9.06	76.5	9.76	85.8	11.15	95.0	12.15
	20	48.3	6.06	57.6	7.29	66.9	8.60	71.7	9.26	76.5	9.95	85.8	11.57	95.0	12.87
	21	48.3	6.09	57.6	7.37	66.9	8.68	71.7	9.37	76.5	10.18	85.8	11.94	95.0	13.21
	23	48.3	6.21	57.6	7.48	66.9	9.06	71.7	9.95	76.5	10.88	85.8	12.60	95.0	13.87
	25	48.3	6.44	57.6	7.98	66.9	9.72	71.7	10.65	76.5	11.65	85.8	13.49	95.0	14.83
	27	48.3	6.83	57.6	8.49	66.9	10.38	71.7	11.38	76.5	12.42	85.8	14.33	95.0	15.60
	29	48.3	7.25	57.6	9.06	66.9	11.03	71.7	12.11	76.5	13.27	85.8	15.35	95.0	16.34
	31	48.3	7.71	57.6	9.60	66.9	11.76	71.7	12.92	76.5	14.12	85.8	16.29	95.0	17.15
	33	48.3	8.18	57.6	10.26	66.9	12.54	71.7	13.77	76.5	15.04	85.8	17.17	95.0	17.98
	35	48.3	8.68	57.6	10.88	66.9	13.35	71.7	14.66	76.5	16.04	85.8	18.20	94.0	19.00
	37	48.3	9.18	57.6	11.56	66.9	14.16	71.7	15.58	76.5	17.05	85.8	19.21	92.5	19.92
	39	48.3	9.70	57.6	12.23	66.9	15.14	71.7	16.75	76.5	18.32	85.8	20.30	91.0	21.01
	41	47.1	10.73	56.1	13.55	65.2	16.62	69.8	18.36	74.5	20.13	83.6	21.79	87.2	22.29
	43	45.9	11.81	54.7	14.78	63.6	18.14	68.1	20.01	72.7	22.00	81.5	23.29	83.6	23.86
46	43.0	13.14	51.3	16.65	59.6	20.44	63.8	22.27	68.1	24.82	74.5	25.74	76.3	25.97	
48	38.1	11.48	45.4	14.56	52.7	17.88	56.5	19.46	60.3	21.67	64.7	21.83	66.3	22.00	

# 7. Capacity Tables

Cooling Capacity (32HP)

Combination (%)	Outdoor air temp. (DB, °C)	Indoor air temp. (DB/WB, °C)													
		20		23		26		27		28		30		32	
		14		16		18		19		20		22		24	
		TC	PI	TC	PI	TC	PI	TC	PI	TC	PI	TC	PI	TC	PI
70	10	42.2	4.92	50.6	5.85	58.6	6.78	62.7	7.32	66.9	7.83	74.9	8.91	83.2	9.97
	12	42.2	5.00	50.6	5.93	58.6	6.94	62.7	7.44	66.9	7.98	74.9	9.07	83.2	10.15
	14	42.2	5.08	50.6	6.01	58.6	7.05	62.7	7.56	66.9	8.10	74.9	9.26	83.2	10.34
	16	42.2	5.15	50.6	6.12	58.6	7.17	62.7	7.71	66.9	8.25	74.9	9.41	83.2	10.56
	18	42.2	5.23	50.6	6.24	58.6	7.32	62.7	7.87	66.9	8.41	74.9	9.57	83.2	10.75
	20	42.2	5.31	50.6	6.35	58.6	7.44	62.7	8.02	66.9	8.60	74.9	9.80	83.2	11.16
	21	42.2	5.39	50.6	6.39	58.6	7.52	62.7	8.10	66.9	8.68	74.9	9.96	83.2	11.40
	23	42.2	5.46	50.6	6.55	58.6	7.67	62.7	8.37	66.9	9.10	74.9	10.65	83.2	12.03
	25	42.2	5.54	50.6	6.78	58.6	8.18	62.7	8.95	66.9	9.72	74.9	11.39	83.2	12.62
	27	42.2	5.85	50.6	7.25	58.6	8.72	62.7	9.49	66.9	10.38	74.9	12.17	83.2	13.41
	29	42.2	6.24	50.6	7.67	58.6	9.26	62.7	10.11	66.9	11.04	74.9	12.98	83.2	14.36
	31	42.2	6.63	50.6	8.18	58.6	9.88	62.7	10.81	66.9	11.78	74.9	13.83	83.2	15.24
	33	42.2	7.01	50.6	8.64	58.6	10.50	62.7	11.47	66.9	12.51	74.9	14.72	83.2	16.23
	35	42.2	7.40	50.6	9.22	58.6	11.16	62.7	12.20	66.9	13.33	74.9	15.69	83.2	17.20
	37	42.2	7.87	50.6	9.77	58.6	11.86	62.7	12.98	66.9	14.18	74.9	16.70	83.2	18.16
	39	42.2	8.35	50.6	10.41	58.6	12.68	62.7	13.96	66.9	15.32	74.9	17.87	83.2	19.57
	41	41.2	9.23	49.3	11.41	57.1	13.91	61.1	15.32	65.2	16.65	73.0	19.63	81.1	21.11
	43	40.1	10.05	48.0	12.43	55.7	15.17	59.6	16.70	63.6	18.18	71.2	21.44	79.1	22.83
46	37.6	11.17	45.0	13.98	52.2	17.09	55.9	18.60	59.6	20.50	66.7	24.19	74.1	25.45	
48	33.3	9.75	39.8	12.21	46.1	14.94	49.4	16.26	52.7	17.93	59.0	21.16	65.5	21.90	
60	10	36.2	4.28	43.2	5.02	50.2	5.84	53.8	6.27	57.3	6.66	64.3	7.55	71.4	8.45
	12	36.2	4.36	43.2	5.10	50.2	5.92	53.8	6.34	57.3	6.77	64.3	7.67	71.4	8.60
	14	36.2	4.40	43.2	5.18	50.2	6.03	53.8	6.46	57.3	6.89	64.3	7.82	71.4	8.76
	16	36.2	4.48	43.2	5.29	50.2	6.11	53.8	6.58	57.3	7.04	64.3	7.98	71.4	8.91
	18	36.2	4.55	43.2	5.37	50.2	6.23	53.8	6.69	57.3	7.16	64.3	8.10	71.4	9.11
	20	36.2	4.63	43.2	5.45	50.2	6.34	53.8	6.81	57.3	7.28	64.3	8.25	71.4	9.30
	21	36.2	4.67	43.2	5.49	50.2	6.42	53.8	6.89	57.3	7.36	64.3	8.37	71.4	9.38
	23	36.2	4.75	43.2	5.60	50.2	6.50	53.8	7.01	57.3	7.51	64.3	8.68	71.4	9.96
	25	36.2	4.83	43.2	5.72	50.2	6.77	53.8	7.36	57.3	7.98	64.3	9.26	71.4	10.66
	27	36.2	4.98	43.2	6.03	50.2	7.20	53.8	7.82	57.3	8.48	64.3	9.85	71.4	11.36
	29	36.2	5.29	43.2	6.42	50.2	7.67	53.8	8.33	57.3	9.03	64.3	10.51	71.4	12.14
	31	36.2	5.60	43.2	6.81	50.2	8.13	53.8	8.87	57.3	9.61	64.3	11.21	71.4	12.92
	33	36.2	5.92	43.2	7.20	50.2	8.64	53.8	9.42	57.3	10.24	64.3	11.91	71.4	13.78
	35	36.2	6.27	43.2	7.67	50.2	9.18	53.8	10.00	57.3	10.86	64.3	12.69	71.4	14.63
	37	36.2	6.62	43.2	8.09	50.2	9.73	53.8	10.62	57.3	11.52	64.3	13.47	71.4	15.57
	39	36.2	7.04	43.2	8.62	50.2	10.50	53.8	11.40	57.3	12.40	64.3	14.44	71.4	16.68
	41	35.2	7.63	42.1	9.43	49.0	11.40	52.4	12.45	55.8	13.46	62.7	15.85	69.5	18.13
	43	34.4	8.29	41.1	10.26	47.7	12.43	51.1	13.57	54.4	14.67	61.1	17.30	67.8	19.80
46	32.2	9.29	38.5	11.53	44.7	13.98	47.9	15.25	51.0	16.51	57.3	19.49	63.6	22.56	
48	28.5	8.09	34.0	10.06	39.6	12.22	42.4	13.32	45.1	14.43	50.7	17.05	56.2	19.74	
50	10	30.2	3.71	36.2	4.30	41.9	4.89	44.8	5.24	47.7	5.55	53.4	6.25	59.5	6.96
	12	30.2	3.75	36.2	4.34	41.9	4.96	44.8	5.32	47.7	5.67	53.4	6.37	59.5	7.08
	14	30.2	3.79	36.2	4.42	41.9	5.04	44.8	5.39	47.7	5.75	53.4	6.45	59.5	7.19
	16	30.2	3.87	36.2	4.50	41.9	5.12	44.8	5.51	47.7	5.82	53.4	6.57	59.5	7.31
	18	30.2	3.91	36.2	4.53	41.9	5.20	44.8	5.59	47.7	5.94	53.4	6.69	59.5	7.47
	20	30.2	3.95	36.2	4.61	41.9	5.32	44.8	5.67	47.7	6.06	53.4	6.80	59.5	7.62
	21	30.2	3.99	36.2	4.65	41.9	5.36	44.8	5.75	47.7	6.10	53.4	6.88	59.5	7.70
	23	30.2	4.07	36.2	4.73	41.9	5.43	44.8	5.82	47.7	6.22	53.4	7.00	59.5	7.86
	25	30.2	4.10	36.2	4.81	41.9	5.55	44.8	5.94	47.7	6.41	53.4	7.35	59.5	8.41
	27	30.2	4.18	36.2	4.96	41.9	5.86	44.8	6.33	47.7	6.80	53.4	7.86	59.5	8.95
	29	30.2	4.42	36.2	5.28	41.9	6.22	44.8	6.72	47.7	7.23	53.4	8.33	59.5	9.50
	31	30.2	4.65	36.2	5.59	41.9	6.61	44.8	7.12	47.7	7.70	53.4	8.87	59.5	10.13
	33	30.2	4.93	36.2	5.90	41.9	7.00	44.8	7.55	47.7	8.17	53.4	9.42	59.5	10.79
	35	30.2	5.20	36.2	6.25	41.9	7.39	44.8	8.01	47.7	8.64	53.4	9.97	59.5	11.45
	37	30.2	5.51	36.2	6.61	41.9	7.82	44.8	8.48	47.7	9.15	53.4	10.63	59.5	12.16
	39	30.2	5.88	36.2	7.08	41.9	8.38	44.8	9.13	47.7	9.82	53.4	11.33	59.5	13.13
	41	29.5	6.36	35.2	7.67	40.8	9.16	43.7	9.89	46.5	10.64	52.1	12.42	58.0	14.26
	43	28.7	6.91	34.4	8.34	39.8	9.97	42.6	10.77	45.3	11.58	50.8	13.54	56.6	15.56
46	26.9	7.74	32.2	9.35	37.3	11.18	39.9	12.09	42.5	13.00	47.6	15.23	53.0	17.51	
48	23.8	6.74	28.5	8.16	33.0	9.75	35.3	10.56	37.6	11.34	42.1	13.31	46.9	15.31	

**Note**

1. TC: Total Capacity(kW), PI : Power Input(kW, Comp. + Outdoor fan motor)
2. Capacity tables show the average value of conditions which may occur.

# 7. Capacity Tables

◆ ARUM340LTE5

Cooling Capacity (34HP)

Combination (%)	Outdoor air temp. (DB, °C)	Indoor air temp. (DB/WB, °C)													
		20		23		26		27		28		30		32	
		14	16	16	18	18	19	20	20	22	22	24	24		
		TC	PI	TC	PI	TC	PI	TC	PI	TC	PI	TC	PI	TC	PI
130	10	94.3	10.02	112.3	12.25	120.4	14.21	123.8	14.50	127.3	14.62	133.4	14.73	136.8	14.79
	12	94.3	10.27	112.3	12.69	120.4	14.80	123.8	14.89	127.3	15.01	133.4	15.13	136.8	15.26
	14	94.3	10.62	112.3	13.15	120.4	15.35	123.8	15.46	127.3	15.59	133.4	15.71	136.8	15.85
	16	94.3	11.00	112.3	13.61	120.4	16.04	123.8	16.19	127.3	16.32	133.4	16.46	136.8	16.59
	18	94.3	11.47	112.3	14.39	120.4	16.78	123.8	17.14	127.3	17.28	133.4	17.45	136.8	17.57
	20	94.3	11.97	112.3	15.33	120.4	17.60	123.8	18.85	127.3	19.00	131.4	19.19	134.9	19.32
	21	94.3	12.29	112.3	15.87	120.4	17.97	123.8	19.95	127.3	20.11	130.7	20.31	134.2	20.45
	23	94.3	13.18	112.3	16.70	120.4	18.91	123.8	22.01	125.6	22.19	128.8	22.41	132.2	22.56
	25	94.3	14.08	112.3	17.66	120.4	20.20	122.3	24.41	123.8	24.61	127.3	24.85	130.7	25.02
	27	94.3	15.07	112.3	18.88	118.8	21.53	120.4	26.88	122.3	27.09	125.6	27.36	128.8	27.55
	29	94.3	16.05	112.3	20.18	116.9	23.16	118.6	29.54	120.4	29.71	123.8	29.98	127.3	30.10
	31	94.3	17.13	111.9	21.26	115.0	24.64	116.9	29.41	118.6	29.59	121.9	29.86	125.3	29.97
	33	94.3	18.25	110.0	22.52	113.4	26.42	115.3	29.15	116.9	29.32	120.4	29.58	123.4	29.70
	35	94.3	19.46	108.1	23.59	111.5	28.62	113.4	28.77	115.3	28.94	118.4	29.20	121.9	29.31
	37	94.3	20.75	106.5	24.75	110.0	28.24	111.5	28.39	113.4	28.56	116.5	28.81	120.0	28.92
	39	94.3	22.10	104.7	26.06	108.1	27.87	110.0	28.01	111.5	28.17	115.0	28.43	118.4	28.54
	41	91.9	23.44	100.3	27.36	103.7	27.49	105.2	27.63	107.3	27.79	110.5	28.04	113.5	28.15
	43	89.6	24.72	96.1	26.97	99.5	27.11	101.0	27.25	103.0	27.41	106.2	27.65	109.1	27.76
46	84.0	26.46	87.7	26.41	90.9	26.54	92.3	26.68	94.2	26.84	97.2	27.08	99.9	27.18	
48	74.3	25.73	76.2	25.80	79.0	25.86	80.3	25.93	82.0	26.15	84.6	26.32	87.0	26.42	
120	10	85.3	9.02	101.5	11.06	110.9	13.14	114.2	14.20	117.6	14.42	124.0	14.48	127.0	14.60
	12	85.3	9.26	101.5	11.43	110.9	13.67	114.2	14.50	117.6	14.96	124.0	15.14	127.0	15.26
	14	85.3	9.58	101.5	11.82	110.9	14.22	114.2	15.05	117.6	15.51	124.0	15.74	127.0	15.86
	16	85.3	9.93	101.5	12.30	110.9	14.77	114.2	15.61	117.6	16.22	124.0	16.42	127.0	16.55
	18	85.3	10.31	101.5	12.86	110.9	15.36	114.2	16.43	117.6	17.06	124.0	17.25	127.0	17.39
	20	85.3	10.71	101.5	13.63	110.9	16.19	114.2	17.29	117.6	17.96	124.0	18.20	127.0	18.34
	21	85.3	11.03	101.5	14.12	110.9	16.64	114.2	17.80	117.6	18.55	124.0	18.79	127.0	18.94
	23	85.3	11.79	101.5	15.11	110.9	17.83	114.2	18.92	117.6	19.78	124.0	19.98	127.0	20.14
	25	85.3	12.60	101.5	16.19	110.9	18.81	114.2	20.17	117.6	21.21	122.5	21.39	125.5	21.56
	27	85.3	13.45	101.5	17.31	110.9	20.01	114.2	21.55	117.6	22.79	120.6	22.94	123.7	23.13
	29	85.3	14.35	101.5	18.47	110.9	21.06	114.2	23.06	115.7	24.29	118.8	24.66	122.1	24.85
	31	85.3	15.29	101.5	19.73	110.9	22.15	112.8	24.70	114.2	26.06	117.3	26.52	120.2	26.73
	33	85.3	16.28	101.5	21.03	109.4	23.43	110.9	26.81	112.4	27.98	115.4	28.29	118.4	28.52
	35	85.3	17.31	101.5	22.42	107.5	24.80	109.0	29.54	110.9	29.69	113.9	29.77	116.9	30.01
	37	85.3	18.62	101.5	23.66	106.0	26.44	107.5	28.92	109.0	29.06	112.0	29.15	115.0	29.38
	39	85.3	20.04	101.1	25.00	104.1	28.04	105.6	28.32	107.1	28.46	110.5	28.55	113.5	28.78
	41	83.1	21.47	96.7	26.35	99.9	27.49	101.4	27.73	102.8	27.87	105.8	27.95	108.8	28.17
	43	81.1	22.91	92.6	25.97	95.8	26.87	97.2	27.13	98.7	27.27	101.6	27.35	104.5	27.57
46	76.0	24.64	84.5	25.35	87.5	26.03	88.8	26.24	90.2	26.37	92.9	26.45	95.6	26.66	
48	67.2	24.13	73.3	24.90	76.1	25.52	77.2	25.68	78.4	25.76	80.8	25.86	83.3	25.96	
110	10	76.4	8.11	91.1	9.89	101.8	11.74	104.7	12.71	111.3	13.68	113.9	14.06	121.6	14.29
	12	76.4	8.37	91.1	10.22	101.8	12.23	104.7	13.07	111.3	14.19	113.9	14.65	121.6	14.99
	14	76.4	8.62	91.1	10.68	101.8	12.79	104.7	13.72	111.3	14.91	113.9	15.33	121.6	15.66
	16	76.4	8.93	91.1	11.07	101.8	13.31	104.7	14.32	111.3	15.60	113.9	16.02	121.6	16.30
	18	76.4	9.26	91.1	11.53	101.8	14.08	104.7	15.07	111.3	16.45	113.9	16.78	121.6	17.09
	20	76.4	9.59	91.1	12.11	101.8	14.93	104.7	15.77	111.3	17.25	113.9	17.68	121.6	17.96
	21	76.4	9.81	91.1	12.47	101.8	15.31	104.7	16.19	111.3	17.73	113.9	18.18	121.6	18.46
	23	76.4	10.45	91.1	13.36	101.8	16.17	104.7	17.09	111.3	18.73	113.9	19.13	121.6	19.45
	25	76.4	11.16	91.1	14.26	101.8	17.08	104.7	18.07	111.3	19.79	113.9	20.07	120.1	20.48
	27	76.4	11.93	91.1	15.25	101.8	18.05	104.7	19.13	111.3	20.67	113.9	21.14	118.4	21.50
	29	76.4	12.73	91.1	16.28	101.8	19.08	104.7	20.26	111.3	21.84	113.9	22.22	116.9	22.55
	31	76.4	13.54	91.1	17.35	101.8	20.16	104.7	21.46	109.5	22.95	112.4	23.40	115.0	23.65
	33	76.4	14.44	91.1	18.47	101.8	21.30	104.7	22.74	108.0	24.24	110.6	24.64	113.5	24.78
	35	76.4	15.33	91.1	19.73	101.8	22.49	104.7	24.10	106.2	25.58	108.8	25.82	111.7	25.94
	37	76.4	16.25	91.1	20.94	101.8	23.75	103.2	25.53	104.3	26.98	107.3	27.07	109.9	27.15
	39	76.4	17.52	91.1	22.25	99.9	25.05	101.4	27.31	102.9	28.32	105.5	28.36	108.4	28.39
	41	74.5	18.79	88.8	23.56	95.7	26.42	97.2	29.54	98.4	29.54	101.3	29.77	103.8	30.01
	43	72.6	19.73	86.6	24.55	91.7	28.02	93.2	28.33	94.4	28.27	97.2	28.43	99.7	28.51
46	68.1	19.26	81.1	23.70	83.6	26.59	85.1	26.59	86.2	26.82	88.8	26.97	91.2	27.04	
48	60.2	18.70	70.5	22.83	72.7	25.30	74.0	25.47	74.9	25.59	77.3	25.66	79.3	25.77	

# 7. Capacity Tables

Cooling Capacity (34HP)

Combination (%)	Outdoor air temp. (DB, °C)	Indoor air temp. (DB/WB, °C)													
		20		23		26		27		28		30		32	
		14		16		18		19		20		22		24	
		TC	PI	TC	PI	TC	PI	TC	PI	TC	PI	TC	PI	TC	PI
100	10	64.3	7.30	76.5	8.88	89.1	10.53	95.2	11.38	101.3	12.23	112.3	13.61	114.8	13.72
	12	64.3	7.54	76.5	9.24	89.1	10.89	95.2	11.69	101.3	12.62	112.3	14.34	114.8	14.49
	14	64.3	7.77	76.5	9.61	89.1	11.35	95.2	12.19	101.3	13.16	112.3	15.15	114.8	15.29
	16	64.3	8.01	76.5	9.93	89.1	11.83	95.2	12.77	101.3	13.87	112.3	15.88	114.8	16.10
	18	64.3	8.25	76.5	10.30	89.1	12.29	95.2	13.39	101.3	14.71	112.3	16.78	114.8	16.91
	20	64.3	8.54	76.5	10.69	89.1	13.00	95.2	14.35	101.3	15.74	112.3	17.58	114.8	17.72
	21	64.3	8.72	76.5	10.94	89.1	13.45	95.2	14.84	101.3	16.32	112.3	17.98	114.8	18.12
	23	64.3	9.24	76.5	11.70	89.1	14.44	95.2	15.92	101.3	17.49	112.3	18.83	114.8	18.98
	25	64.3	9.82	76.5	12.47	89.1	15.42	95.2	17.04	101.3	18.70	112.3	19.63	113.8	19.79
	27	64.3	10.49	76.5	13.32	89.1	16.50	95.2	18.20	101.3	19.88	110.1	20.55	112.5	20.72
	29	64.3	11.16	76.5	14.21	89.1	17.62	95.2	19.46	101.3	21.04	108.1	21.38	110.8	21.55
	31	64.3	11.93	76.5	15.16	89.1	18.79	95.2	20.76	101.3	22.11	106.5	22.21	109.1	22.39
	33	64.3	12.64	76.5	16.14	89.1	20.04	95.2	22.15	101.3	22.94	104.8	23.04	107.4	23.22
	35	64.3	13.45	76.5	17.17	89.1	21.34	95.2	23.63	99.8	23.77	102.9	23.86	105.5	24.06
	37	64.3	14.41	76.5	18.42	89.1	22.61	95.2	24.76	98.1	24.88	101.0	24.98	103.4	25.21
	39	64.3	15.44	76.5	19.79	89.1	23.96	95.2	25.96	96.5	26.08	99.3	26.18	101.7	26.42
	41	63.2	16.48	75.3	21.15	87.7	25.31	91.3	27.17	93.4	27.28	95.5	27.38	98.6	27.64
43	61.1	17.45	72.7	22.43	84.7	26.52	87.6	28.21	88.6	28.31	91.3	28.41	93.7	28.67	
46	57.2	18.76	68.1	24.18	79.3	28.13	80.0	29.54	80.8	29.62	83.4	29.71	85.7	29.99	
48	50.6	16.20	60.3	20.92	68.5	24.04	69.5	25.06	70.2	25.14	72.5	25.20	74.5	25.40	
90	10	57.8	6.76	69.0	8.13	80.2	9.58	85.7	10.32	91.1	11.11	102.3	12.44	113.6	13.72
	12	57.8	6.84	69.0	8.25	80.2	9.74	85.7	10.53	91.1	11.36	102.3	12.68	113.6	14.08
	14	57.8	6.97	69.0	8.42	80.2	9.95	85.7	10.74	91.1	11.57	102.3	12.93	113.6	14.36
	16	57.8	7.09	69.0	8.58	80.2	10.16	85.7	10.95	91.1	11.78	102.3	13.18	113.6	14.61
	18	57.8	7.21	69.0	8.75	80.2	10.32	85.7	11.19	91.1	12.02	102.3	13.46	113.6	15.34
	20	57.8	7.34	69.0	8.91	80.2	10.53	85.7	11.40	91.1	12.48	102.3	14.41	113.6	16.08
	21	57.8	7.42	69.0	9.00	80.2	10.74	85.7	11.78	91.1	12.94	102.3	14.64	113.6	16.44
	23	57.8	7.59	69.0	9.37	80.2	11.48	85.7	12.65	91.1	13.85	102.3	15.53	112.0	17.22
	25	57.8	7.96	69.0	9.99	80.2	12.27	85.7	13.52	91.1	14.80	102.3	16.60	110.4	17.95
	27	57.8	8.50	69.0	10.66	80.2	13.10	85.7	14.43	91.1	15.84	102.3	17.65	108.8	18.80
	29	57.8	9.00	69.0	11.36	80.2	14.01	85.7	15.42	91.1	16.92	102.3	18.70	107.1	19.55
	31	57.8	9.58	69.0	12.11	80.2	14.93	85.7	16.42	91.1	18.04	102.3	19.63	105.5	20.31
	33	57.8	10.20	69.0	12.89	80.2	15.92	85.7	17.50	91.1	19.13	102.3	20.58	103.9	21.07
	35	57.8	10.82	69.0	13.68	80.2	16.92	85.7	18.66	91.1	20.29	100.6	21.76	102.3	22.26
	37	57.8	11.48	69.0	14.55	80.2	18.04	85.7	19.82	91.1	21.41	99.0	22.75	100.7	23.26
	39	57.8	12.16	69.0	15.48	80.2	19.09	85.7	21.09	91.1	22.52	97.3	23.98	99.1	24.27
	41	56.3	13.61	67.3	17.16	78.2	20.95	83.5	23.07	88.8	24.31	93.3	25.28	94.9	25.85
43	54.9	14.69	65.6	18.54	76.3	22.89	81.4	24.84	86.6	26.07	89.4	27.07	91.1	27.39	
46	51.5	16.53	61.5	21.12	71.5	26.08	76.3	28.16	78.7	28.96	81.6	29.64	83.2	29.75	
48	45.5	14.45	54.4	18.47	63.2	22.82	67.5	24.57	68.3	24.95	71.0	25.20	72.3	25.40	
80	10	51.3	6.30	61.2	7.57	71.1	8.88	76.2	9.58	81.3	10.28	91.1	11.72	101.0	12.73
	12	51.3	6.43	61.2	7.65	71.1	9.05	76.2	9.75	81.3	10.45	91.1	11.94	101.0	12.98
	14	51.3	6.52	61.2	7.83	71.1	9.18	76.2	9.93	81.3	10.63	91.1	12.16	101.0	13.23
	16	51.3	6.60	61.2	7.96	71.1	9.36	76.2	10.10	81.3	10.85	91.1	12.42	101.0	13.48
	18	51.3	6.73	61.2	8.09	71.1	9.53	76.2	10.28	81.3	11.06	91.1	12.64	101.0	13.78
	20	51.3	6.87	61.2	8.27	71.1	9.75	76.2	10.50	81.3	11.28	91.1	13.12	101.0	14.59
	21	51.3	6.91	61.2	8.35	71.1	9.84	76.2	10.63	81.3	11.55	91.1	13.53	101.0	14.98
	23	51.3	7.04	61.2	8.48	71.1	10.28	76.2	11.28	81.3	12.33	91.1	14.29	101.0	15.72
	25	51.3	7.30	61.2	9.05	71.1	11.02	76.2	12.07	81.3	13.21	91.1	15.29	101.0	16.81
	27	51.3	7.74	61.2	9.62	71.1	11.76	76.2	12.90	81.3	14.08	91.1	16.25	101.0	17.69
	29	51.3	8.22	61.2	10.28	71.1	12.51	76.2	13.73	81.3	15.04	91.1	17.41	101.0	18.58
	31	51.3	8.75	61.2	10.89	71.1	13.34	76.2	14.65	81.3	16.01	91.1	18.48	101.0	19.50
	33	51.3	9.27	61.2	11.63	71.1	14.21	76.2	15.61	81.3	17.06	91.1	19.47	101.0	20.44
	35	51.3	9.84	61.2	12.33	71.1	15.13	76.2	16.62	81.3	18.19	91.1	20.64	99.9	21.59
	37	51.3	10.41	61.2	13.11	71.1	16.05	76.2	17.67	81.3	19.33	91.1	21.78	98.3	22.58
	39	51.3	11.00	61.2	13.86	71.1	17.17	76.2	18.99	81.3	20.77	91.1	23.02	96.7	23.82
	41	50.0	12.17	59.6	15.36	69.2	18.84	74.2	20.82	79.2	22.83	88.8	24.77	92.6	25.34
43	48.8	13.40	58.2	16.76	67.5	20.57	72.4	22.69	77.2	24.94	86.6	26.52	88.8	27.12	
46	45.7	14.90	54.5	18.88	63.3	23.18	67.8	25.26	72.4	28.15	79.2	29.64	81.1	29.75	
48	40.4	13.02	48.2	16.51	56.0	20.27	60.0	22.06	64.0	24.64	68.8	25.20	70.4	25.40	

# 7. Capacity Tables

Cooling Capacity (34HP)

Combination (%)	Outdoor air temp. (DB, °C)	Indoor air temp. (DB/WB, °C)													
		20		23		26		27		28		30		32	
		14	16	18	19	20	22	24	TC	PI	TC	PI	TC	PI	
70	10	44.9	5.57	53.7	6.62	62.2	7.67	66.6	8.28	71.1	8.85	79.6	10.08	88.4	11.27
	12	44.9	5.65	53.7	6.70	62.2	7.84	66.6	8.41	71.1	9.03	79.6	10.25	88.4	11.49
	14	44.9	5.74	53.7	6.79	62.2	7.98	66.6	8.55	71.1	9.16	79.6	10.47	88.4	11.70
	16	44.9	5.83	53.7	6.92	62.2	8.11	66.6	8.72	71.1	9.33	79.6	10.65	88.4	11.95
	18	44.9	5.92	53.7	7.06	62.2	8.28	66.6	8.90	71.1	9.51	79.6	10.82	88.4	12.16
	20	44.9	6.00	53.7	7.19	62.2	8.41	66.6	9.07	71.1	9.73	79.6	11.09	88.4	12.62
	21	44.9	6.09	53.7	7.23	62.2	8.50	66.6	9.16	71.1	9.82	79.6	11.26	88.4	12.89
	23	44.9	6.18	53.7	7.41	62.2	8.68	66.6	9.47	71.1	10.30	79.6	12.05	88.4	13.61
	25	44.9	6.27	53.7	7.67	62.2	9.25	66.6	10.12	71.1	11.00	79.6	12.88	88.4	14.27
	27	44.9	6.62	53.7	8.19	62.2	9.86	66.6	10.74	71.1	11.74	79.6	13.76	88.4	15.16
	29	44.9	7.06	53.7	8.68	62.2	10.47	66.6	11.44	71.1	12.49	79.6	14.68	88.4	16.25
	31	44.9	7.49	53.7	9.25	62.2	11.17	66.6	12.23	71.1	13.32	79.6	15.64	88.4	17.24
	33	44.9	7.93	53.7	9.77	62.2	11.88	66.6	12.97	71.1	14.15	79.6	16.65	88.4	18.35
	35	44.9	8.37	53.7	10.43	62.2	12.62	66.6	13.80	71.1	15.08	79.6	17.75	88.4	19.46
	37	44.9	8.90	53.7	11.05	62.2	13.41	66.6	14.68	71.1	16.04	79.6	18.89	88.4	20.54
	39	44.9	9.45	53.7	11.78	62.2	14.34	66.6	15.79	71.1	17.33	79.6	20.21	88.4	22.14
41	43.7	10.44	52.3	12.90	60.6	15.73	64.9	17.32	69.2	18.84	77.5	22.20	86.1	23.89	
43	42.7	11.37	51.1	14.06	59.1	17.16	63.3	18.89	67.5	20.57	75.6	24.25	84.0	25.82	
46	40.0	12.63	47.8	15.81	55.4	19.33	59.3	21.04	63.3	23.19	70.9	27.36	78.7	28.78	
48	35.4	11.03	42.3	13.81	49.0	16.90	52.5	18.39	56.0	20.28	62.7	23.94	69.6	24.91	
60	10	38.4	4.83	45.9	5.66	53.4	6.59	57.1	7.07	60.9	7.51	68.3	8.52	75.8	9.53
	12	38.4	4.92	45.9	5.75	53.4	6.67	57.1	7.16	60.9	7.64	68.3	8.65	75.8	9.70
	14	38.4	4.96	45.9	5.84	53.4	6.81	57.1	7.29	60.9	7.77	68.3	8.83	75.8	9.88
	16	38.4	5.05	45.9	5.97	53.4	6.89	57.1	7.42	60.9	7.95	68.3	9.00	75.8	10.06
	18	38.4	5.14	45.9	6.06	53.4	7.03	57.1	7.55	60.9	8.08	68.3	9.13	75.8	10.28
	20	38.4	5.23	45.9	6.15	53.4	7.16	57.1	7.68	60.9	8.21	68.3	9.31	75.8	10.50
	21	38.4	5.27	45.9	6.19	53.4	7.25	57.1	7.77	60.9	8.30	68.3	9.44	75.8	10.58
	23	38.4	5.36	45.9	6.32	53.4	7.33	57.1	7.90	60.9	8.48	68.3	9.79	75.8	11.24
	25	38.4	5.45	45.9	6.46	53.4	7.64	57.1	8.30	60.9	9.00	68.3	10.45	75.8	12.03
	27	38.4	5.62	45.9	6.81	53.4	8.12	57.1	8.83	60.9	9.57	68.3	11.11	75.8	12.82
	29	38.4	5.97	45.9	7.25	53.4	8.65	57.1	9.40	60.9	10.19	68.3	11.86	75.8	13.70
	31	38.4	6.32	45.9	7.68	53.4	9.18	57.1	10.01	60.9	10.85	68.3	12.65	75.8	14.58
	33	38.4	6.67	45.9	8.12	53.4	9.75	57.1	10.63	60.9	11.55	68.3	13.44	75.8	15.54
	35	38.4	7.07	45.9	8.65	53.4	10.36	57.1	11.29	60.9	12.25	68.3	14.32	75.8	16.51
	37	38.4	7.47	45.9	9.13	53.4	10.98	57.1	11.99	60.9	13.00	68.3	15.19	75.8	17.56
	39	38.4	7.94	45.9	9.72	53.4	11.85	57.1	12.86	60.9	13.99	68.3	16.29	75.8	18.82
41	37.4	8.61	44.7	10.64	52.0	12.87	55.7	14.05	59.3	15.18	66.6	17.88	73.9	20.45	
43	36.5	9.36	43.6	11.58	50.7	14.03	54.3	15.31	57.8	16.56	64.9	19.52	72.1	22.34	
46	34.2	10.48	40.9	13.00	47.5	15.78	50.9	17.21	54.2	18.63	60.9	21.99	67.5	25.45	
48	30.3	9.13	36.2	11.35	42.1	13.78	45.0	15.03	47.9	16.28	53.8	19.23	59.7	22.27	
50	10	32.1	4.18	38.4	4.84	44.5	5.50	47.6	5.90	50.7	6.25	56.8	7.04	63.2	7.83
	12	32.1	4.22	38.4	4.88	44.5	5.59	47.6	5.98	50.7	6.38	56.8	7.17	63.2	7.96
	14	32.1	4.27	38.4	4.97	44.5	5.68	47.6	6.07	50.7	6.47	56.8	7.26	63.2	8.10
	16	32.1	4.36	38.4	5.06	44.5	5.76	47.6	6.20	50.7	6.56	56.8	7.39	63.2	8.23
	18	32.1	4.40	38.4	5.10	44.5	5.85	47.6	6.29	50.7	6.69	56.8	7.52	63.2	8.40
	20	32.1	4.44	38.4	5.19	44.5	5.98	47.6	6.38	50.7	6.82	56.8	7.66	63.2	8.58
	21	32.1	4.49	38.4	5.24	44.5	6.03	47.6	6.47	50.7	6.86	56.8	7.74	63.2	8.67
	23	32.1	4.58	38.4	5.32	44.5	6.12	47.6	6.56	50.7	7.00	56.8	7.88	63.2	8.84
	25	32.1	4.62	38.4	5.41	44.5	6.25	47.6	6.69	50.7	7.22	56.8	8.27	63.2	9.46
	27	32.1	4.71	38.4	5.59	44.5	6.60	47.6	7.13	50.7	7.66	56.8	8.84	63.2	10.08
	29	32.1	4.97	38.4	5.94	44.5	7.00	47.6	7.57	50.7	8.14	56.8	9.37	63.2	10.69
	31	32.1	5.24	38.4	6.29	44.5	7.44	47.6	8.01	50.7	8.67	56.8	9.99	63.2	11.40
	33	32.1	5.54	38.4	6.64	44.5	7.88	47.6	8.49	50.7	9.20	56.8	10.60	63.2	12.14
	35	32.1	5.85	38.4	7.04	44.5	8.32	47.6	9.02	50.7	9.72	56.8	11.22	63.2	12.89
	37	32.1	6.20	38.4	7.44	44.5	8.80	47.6	9.55	50.7	10.30	56.8	11.97	63.2	13.68
	39	32.1	6.62	38.4	7.97	44.5	9.43	47.6	10.28	50.7	11.05	56.8	12.75	63.2	14.78
41	31.3	7.16	37.4	8.63	43.4	10.31	46.4	11.13	49.4	11.97	55.3	13.97	61.6	16.05	
43	30.5	7.78	36.5	9.39	42.3	11.22	45.2	12.12	48.1	13.03	54.0	15.24	60.1	17.51	
46	28.6	8.71	34.2	10.53	39.7	12.58	42.4	13.61	45.1	14.63	50.6	17.15	56.3	19.71	
48	25.3	7.59	30.3	9.18	35.1	10.98	37.5	11.88	39.9	12.77	44.7	14.98	49.8	17.23	

**Note**

1. TC: Total Capacity(kW), PI : Power Input(kW, Comp. + Outdoor fan motor)
2. Capacity tables show the average value of conditions which may occur.

# 7. Capacity Tables

◆ ARUM360LTE5

Cooling Capacity (36HP)

Combination (%)	Outdoor air temp. (DB, °C)	Indoor air temp. (DB/WB, °C)													
		20		23		26		27		28		30		32	
		14	16	16	18	18	19	20	20	22	22	24	24		
		TC	PI	TC	PI	TC	PI	TC	PI	TC	PI	TC	PI	TC	PI
130	10	99.8	10.66	118.9	13.02	127.4	15.11	131.1	15.41	134.7	15.54	141.2	15.66	144.9	15.72
	12	99.8	10.92	118.9	13.49	127.4	15.73	131.1	15.83	134.7	15.96	141.2	16.08	144.9	16.23
	14	99.8	11.29	118.9	13.98	127.4	16.32	131.1	16.44	134.7	16.57	141.2	16.70	144.9	16.85
	16	99.8	11.70	118.9	14.46	127.4	17.05	131.1	17.21	134.7	17.35	141.2	17.50	144.9	17.64
	18	99.8	12.19	118.9	15.30	127.4	17.84	131.1	18.22	134.7	18.36	141.2	18.55	144.9	18.67
	20	99.8	12.73	118.9	16.30	127.4	18.71	131.1	20.04	134.7	20.20	139.2	20.40	142.8	20.54
	21	99.8	13.06	118.9	16.87	127.4	19.11	131.1	21.21	134.7	21.38	138.4	21.59	142.1	21.74
	23	99.8	14.01	118.9	17.75	127.4	20.10	131.1	23.40	133.0	23.59	136.4	23.82	140.0	23.99
	25	99.8	14.97	118.9	18.77	127.4	21.48	129.5	25.95	131.1	26.16	134.7	26.42	138.4	26.60
	27	99.8	16.02	118.9	20.07	125.8	22.88	127.4	28.57	129.5	28.80	133.0	29.09	136.4	29.29
	29	99.8	17.06	118.9	21.45	123.8	24.62	125.6	31.40	127.4	31.59	131.1	31.87	134.7	32.00
	31	99.8	18.21	118.5	22.60	121.7	26.19	123.8	31.27	125.6	31.46	129.0	31.74	132.7	31.86
	33	99.8	19.40	116.5	23.94	120.1	28.09	122.1	30.98	123.8	31.17	127.4	31.45	130.6	31.57
	35	99.8	20.69	114.4	25.07	118.1	30.43	120.1	30.58	122.1	30.76	125.4	31.04	129.0	31.16
	37	99.8	22.06	112.8	26.31	116.5	30.02	118.1	30.18	120.1	30.36	123.4	30.63	127.0	30.75
	39	99.8	23.49	110.8	27.70	114.4	29.62	116.5	29.77	118.1	29.95	121.7	30.22	125.4	30.34
	41	97.3	24.92	106.2	29.08	109.8	29.22	111.4	29.37	113.6	29.54	117.0	29.81	120.2	29.93
	43	94.9	26.28	101.8	28.67	105.3	28.82	106.9	28.96	109.1	29.14	112.4	29.40	115.5	29.51
46	88.9	28.13	92.8	28.07	96.2	28.22	97.7	28.36	99.8	28.53	102.9	28.78	105.7	28.90	
48	78.7	27.35	80.6	27.43	83.6	27.49	85.0	27.56	86.8	27.80	89.6	27.98	92.1	28.09	
120	10	90.3	9.59	107.4	11.75	117.4	13.97	121.0	15.09	124.5	15.33	131.3	15.40	134.5	15.52
	12	90.3	9.85	107.4	12.15	117.4	14.53	121.0	15.41	124.5	15.90	131.3	16.09	134.5	16.22
	14	90.3	10.18	107.4	12.57	117.4	15.12	121.0	16.00	124.5	16.48	131.3	16.73	134.5	16.86
	16	90.3	10.55	107.4	13.08	117.4	15.70	121.0	16.60	124.5	17.25	131.3	17.46	134.5	17.60
	18	90.3	10.97	107.4	13.67	117.4	16.33	121.0	17.47	124.5	18.13	131.3	18.34	134.5	18.48
	20	90.3	11.38	107.4	14.49	117.4	17.21	121.0	18.39	124.5	19.09	131.3	19.34	134.5	19.50
	21	90.3	11.73	107.4	15.01	117.4	17.69	121.0	18.93	124.5	19.72	131.3	19.97	134.5	20.13
	23	90.3	12.54	107.4	16.06	117.4	18.95	121.0	20.11	124.5	21.02	131.3	21.24	134.5	21.41
	25	90.3	13.39	107.4	17.21	117.4	19.99	121.0	21.44	124.5	22.55	129.7	22.73	132.9	22.92
	27	90.3	14.30	107.4	18.40	117.4	21.27	121.0	22.90	124.5	24.23	127.7	24.39	130.9	24.59
	29	90.3	15.25	107.4	19.64	117.4	22.39	121.0	24.51	122.5	25.82	125.7	26.21	129.3	26.42
	31	90.3	16.25	107.4	20.97	117.4	23.55	119.4	26.26	121.0	27.70	124.2	28.19	127.3	28.42
	33	90.3	17.30	107.4	22.36	115.8	24.91	117.4	28.50	119.0	29.74	122.2	30.08	125.4	30.32
	35	90.3	18.40	107.4	23.83	113.8	26.36	115.4	31.40	117.4	31.56	120.6	31.65	123.7	31.90
	37	90.3	19.79	107.4	25.15	112.2	28.11	113.8	30.74	115.4	30.89	118.6	30.99	121.8	31.23
	39	90.3	21.31	107.0	26.58	110.2	29.81	111.8	30.11	113.4	30.26	117.0	30.35	120.2	30.59
	41	88.0	22.82	102.4	28.01	105.8	29.22	107.3	29.48	108.9	29.62	112.0	29.71	115.2	29.95
	43	85.9	24.36	98.1	27.61	101.5	28.57	102.9	28.85	104.5	28.99	107.5	29.08	110.6	29.31
46	80.5	26.19	89.4	26.95	92.7	27.67	94.0	27.90	95.5	28.04	98.4	28.12	101.3	28.34	
48	71.2	25.66	77.6	26.47	80.5	27.13	81.8	27.30	83.0	27.38	85.6	27.49	88.2	27.60	
110	10	80.9	8.62	96.5	10.51	107.8	12.48	110.9	13.51	117.9	14.54	120.6	14.95	128.8	15.20
	12	80.9	8.89	96.5	10.86	107.8	13.00	110.9	13.89	117.9	15.09	120.6	15.57	128.8	15.93
	14	80.9	9.17	96.5	11.35	107.8	13.59	110.9	14.58	117.9	15.85	120.6	16.30	128.8	16.64
	16	80.9	9.50	96.5	11.77	107.8	14.15	110.9	15.22	117.9	16.58	120.6	17.03	128.8	17.33
	18	80.9	9.85	96.5	12.26	107.8	14.97	110.9	16.03	117.9	17.49	120.6	17.84	128.8	18.17
	20	80.9	10.20	96.5	12.87	107.8	15.87	110.9	16.76	117.9	18.34	120.6	18.79	128.8	19.09
	21	80.9	10.42	96.5	13.25	107.8	16.28	110.9	17.21	117.9	18.85	120.6	19.32	128.8	19.63
	23	80.9	11.11	96.5	14.20	107.8	17.19	110.9	18.17	117.9	19.91	120.6	20.34	128.8	20.68
	25	80.9	11.87	96.5	15.16	107.8	18.16	110.9	19.21	117.9	21.04	120.6	21.34	127.2	21.78
	27	80.9	12.68	96.5	16.21	107.8	19.19	110.9	20.33	117.9	21.97	120.6	22.47	125.3	22.86
	29	80.9	13.54	96.5	17.30	107.8	20.28	110.9	21.53	117.9	23.22	120.6	23.62	123.7	23.98
	31	80.9	14.40	96.5	18.45	107.8	21.43	110.9	22.81	116.0	24.40	119.0	24.88	121.8	25.14
	33	80.9	15.35	96.5	19.64	107.8	22.64	110.9	24.18	114.4	25.77	117.1	26.19	120.2	26.34
	35	80.9	16.30	96.5	20.97	107.8	23.91	110.9	25.62	112.4	27.19	115.2	27.44	118.3	27.58
	37	80.9	17.28	96.5	22.26	107.8	25.24	109.3	27.14	110.5	28.68	113.6	28.78	116.3	28.86
	39	80.9	18.63	96.5	23.65	105.8	26.63	107.4	29.03	108.9	30.10	111.7	30.15	114.8	30.18
	41	78.9	19.98	94.0	25.05	101.3	28.09	102.9	31.40	104.2	31.40	107.3	31.65	109.9	31.90
	43	76.9	20.98	91.7	26.10	97.1	29.78	98.7	30.12	99.9	30.06	102.9	30.23	105.5	30.31
46	72.1	20.47	85.9	25.19	88.6	28.27	90.1	28.27	91.3	28.51	94.1	28.67	96.5	28.75	
48	63.8	19.88	74.7	24.27	76.9	26.89	78.3	27.07	79.4	27.21	81.8	27.28	84.0	27.39	

# 7. Capacity Tables

Cooling Capacity (36HP)

Combination (%)	Outdoor air temp. (DB, °C)	Indoor air temp. (DB/WB, °C)													
		20		23		26		27		28		30		32	
		14		16		18		19		20		22		24	
		TC	PI	TC	PI	TC	PI	TC	PI	TC	PI	TC	PI	TC	PI
100	10	68.0	7.76	81.0	9.44	94.3	11.20	100.8	12.10	107.3	13.00	118.9	14.47	121.6	14.59
	12	68.0	8.01	81.0	9.82	94.3	11.57	100.8	12.42	107.3	13.41	118.9	15.25	121.6	15.40
	14	68.0	8.26	81.0	10.21	94.3	12.06	100.8	12.96	107.3	13.99	118.9	16.10	121.6	16.25
	16	68.0	8.52	81.0	10.55	94.3	12.58	100.8	13.58	107.3	14.75	118.9	16.88	121.6	17.11
	18	68.0	8.77	81.0	10.95	94.3	13.07	100.8	14.24	107.3	15.63	118.9	17.83	121.6	17.98
	20	68.0	9.08	81.0	11.36	94.3	13.82	100.8	15.25	107.3	16.73	118.9	18.69	121.6	18.84
	21	68.0	9.27	81.0	11.63	94.3	14.30	100.8	15.78	107.3	17.35	118.9	19.11	121.6	19.27
	23	68.0	9.82	81.0	12.44	94.3	15.35	100.8	16.92	107.3	18.59	118.9	20.01	121.6	20.17
	25	68.0	10.44	81.0	13.25	94.3	16.40	100.8	18.11	107.3	19.88	118.9	20.87	120.5	21.04
	27	68.0	11.15	81.0	14.16	94.3	17.54	100.8	19.35	107.3	21.13	116.6	21.85	119.1	22.02
	29	68.0	11.87	81.0	15.11	94.3	18.73	100.8	20.69	107.3	22.37	114.5	22.73	117.3	22.91
	31	68.0	12.68	81.0	16.11	94.3	19.97	100.8	22.07	107.3	23.50	112.7	23.61	115.5	23.80
	33	68.0	13.44	81.0	17.16	94.3	21.31	100.8	23.55	107.3	24.39	110.9	24.49	113.7	24.69
	35	68.0	14.30	81.0	18.26	94.3	22.69	100.8	25.12	105.6	25.27	108.9	25.37	111.7	25.57
	37	68.0	15.31	81.0	19.58	94.3	24.03	100.8	26.32	103.9	26.45	106.9	26.55	109.4	26.80
	39	68.0	16.42	81.0	21.03	94.3	25.47	100.8	27.60	102.2	27.72	105.2	27.83	107.6	28.09
	41	67.0	17.52	79.7	22.49	92.8	26.90	96.7	28.89	98.8	29.00	101.2	29.11	104.5	29.38
43	64.7	18.55	77.0	23.84	89.6	28.19	92.7	29.99	93.8	30.10	96.7	30.20	99.2	30.48	
46	60.6	19.95	72.1	25.70	84.0	29.90	84.7	31.40	85.6	31.49	88.3	31.58	90.7	31.88	
48	53.6	17.22	63.8	22.24	72.5	25.56	73.6	26.64	74.3	26.73	76.8	26.79	78.9	27.00	
90	10	61.2	7.18	73.1	8.64	85.0	10.18	90.7	10.97	96.5	11.81	108.4	13.22	120.2	14.59
	12	61.2	7.27	73.1	8.77	85.0	10.36	90.7	11.19	96.5	12.07	108.4	13.48	120.2	14.96
	14	61.2	7.40	73.1	8.95	85.0	10.58	90.7	11.41	96.5	12.29	108.4	13.74	120.2	15.26
	16	61.2	7.54	73.1	9.12	85.0	10.80	90.7	11.63	96.5	12.52	108.4	14.00	120.2	15.52
	18	61.2	7.67	73.1	9.30	85.0	10.97	90.7	11.90	96.5	12.78	108.4	14.31	120.2	16.31
	20	61.2	7.80	73.1	9.47	85.0	11.19	90.7	12.12	96.5	13.26	108.4	15.31	120.2	17.09
	21	61.2	7.89	73.1	9.56	85.0	11.41	90.7	12.52	96.5	13.75	108.4	15.56	120.2	17.48
	23	61.2	8.06	73.1	9.96	85.0	12.21	90.7	13.44	96.5	14.72	108.4	16.50	118.6	18.30
	25	61.2	8.46	73.1	10.62	85.0	13.04	90.7	14.37	96.5	15.73	108.4	17.65	116.9	19.08
	27	61.2	9.03	73.1	11.33	85.0	13.93	90.7	15.34	96.5	16.83	108.4	18.76	115.2	19.98
	29	61.2	9.56	73.1	12.07	85.0	14.89	90.7	16.39	96.5	17.98	108.4	19.87	113.5	20.78
	31	61.2	10.18	73.1	12.87	85.0	15.86	90.7	17.45	96.5	19.17	108.4	20.87	111.7	21.59
	33	61.2	10.84	73.1	13.70	85.0	16.92	90.7	18.60	96.5	20.33	108.4	21.87	110.0	22.39
	35	61.2	11.50	73.1	14.54	85.0	17.98	90.7	19.83	96.5	21.56	106.5	23.13	108.3	23.66
	37	61.2	12.21	73.1	15.47	85.0	19.17	90.7	21.07	96.5	22.76	104.8	24.18	106.6	24.72
	39	61.2	12.92	73.1	16.45	85.0	20.29	90.7	22.42	96.5	23.93	103.1	25.49	104.9	25.80
	41	59.6	14.46	71.2	18.24	82.8	22.27	88.4	24.52	94.0	25.84	98.8	26.86	100.5	27.48
43	58.2	15.61	69.4	19.71	80.7	24.33	86.2	26.40	91.7	27.70	94.7	28.77	96.4	29.11	
46	54.5	17.57	65.1	22.45	75.7	27.72	80.8	29.93	83.3	30.78	86.4	31.51	88.1	31.62	
48	48.2	15.36	57.6	19.63	66.9	24.25	71.5	26.11	72.3	26.52	75.1	26.79	76.6	27.00	
80	10	54.4	6.69	64.8	8.04	75.2	9.44	80.6	10.18	86.0	10.92	96.5	12.46	106.9	13.52
	12	54.4	6.83	64.8	8.13	75.2	9.62	80.6	10.37	86.0	11.11	96.5	12.69	106.9	13.79
	14	54.4	6.93	64.8	8.32	75.2	9.76	80.6	10.55	86.0	11.30	96.5	12.92	106.9	14.06
	16	54.4	7.02	64.8	8.46	75.2	9.95	80.6	10.74	86.0	11.53	96.5	13.20	106.9	14.33
	18	54.4	7.16	64.8	8.60	75.2	10.13	80.6	10.92	86.0	11.76	96.5	13.43	106.9	14.64
	20	54.4	7.30	64.8	8.79	75.2	10.37	80.6	11.16	86.0	11.99	96.5	13.94	106.9	15.51
	21	54.4	7.34	64.8	8.88	75.2	10.46	80.6	11.30	86.0	12.27	96.5	14.38	106.9	15.92
	23	54.4	7.48	64.8	9.02	75.2	10.92	80.6	11.99	86.0	13.11	96.5	15.19	106.9	16.71
	25	54.4	7.76	64.8	9.62	75.2	11.71	80.6	12.83	86.0	14.04	96.5	16.25	106.9	17.87
	27	54.4	8.23	64.8	10.23	75.2	12.50	80.6	13.71	86.0	14.97	96.5	17.27	106.9	18.80
	29	54.4	8.74	64.8	10.92	75.2	13.29	80.6	14.60	86.0	15.99	96.5	18.50	106.9	19.74
	31	54.4	9.30	64.8	11.57	75.2	14.18	80.6	15.57	86.0	17.01	96.5	19.64	106.9	20.72
	33	54.4	9.85	64.8	12.36	75.2	15.11	80.6	16.59	86.0	18.13	96.5	20.69	106.9	21.72
	35	54.4	10.46	64.8	13.11	75.2	16.08	80.6	17.66	86.0	19.34	96.5	21.94	105.8	22.95
	37	54.4	11.06	64.8	13.94	75.2	17.06	80.6	18.78	86.0	20.55	96.5	23.15	104.1	24.00
	39	54.4	11.69	64.8	14.73	75.2	18.25	80.6	20.19	86.0	22.08	96.5	24.46	102.4	25.32
	41	53.0	12.93	63.1	16.33	73.3	20.03	78.6	22.13	83.8	24.26	94.0	26.33	98.1	26.93
43	51.7	14.24	61.6	17.82	71.5	21.86	76.6	24.12	81.8	26.51	91.7	28.19	94.0	28.82	
46	48.4	15.84	57.7	20.07	67.0	24.63	71.8	26.84	76.6	29.92	83.8	31.51	85.8	31.62	
48	42.8	13.83	51.1	17.55	59.3	21.54	63.5	23.45	67.8	26.19	72.8	26.79	74.6	27.00	



# 7. Capacity Tables

Cooling Capacity (36HP)

Combination (%)	Outdoor air temp. (DB, °C)	Indoor air temp. (DB/WB, °C)													
		20		23		26		27		28		30		32	
		14		16		18		19		20		22		24	
		TC	PI	TC	PI	TC	PI	TC	PI	TC	PI	TC	PI	TC	PI
70	10	47.5	5.92	56.9	7.03	65.9	8.15	70.6	8.80	75.2	9.41	84.2	10.71	93.6	11.98
	12	47.5	6.01	56.9	7.13	65.9	8.34	70.6	8.94	75.2	9.59	84.2	10.90	93.6	12.21
	14	47.5	6.10	56.9	7.22	65.9	8.48	70.6	9.08	75.2	9.73	84.2	11.13	93.6	12.43
	16	47.5	6.19	56.9	7.36	65.9	8.62	70.6	9.27	75.2	9.92	84.2	11.32	93.6	12.70
	18	47.5	6.29	56.9	7.50	65.9	8.80	70.6	9.46	75.2	10.11	84.2	11.50	93.6	12.92
	20	47.5	6.38	56.9	7.64	65.9	8.94	70.6	9.64	75.2	10.34	84.2	11.78	93.6	13.41
	21	47.5	6.47	56.9	7.69	65.9	9.04	70.6	9.73	75.2	10.43	84.2	11.97	93.6	13.70
	23	47.5	6.57	56.9	7.87	65.9	9.22	70.6	10.06	75.2	10.95	84.2	12.81	93.6	14.46
	25	47.5	6.66	56.9	8.15	65.9	9.83	70.6	10.76	75.2	11.69	84.2	13.69	93.6	15.17
	27	47.5	7.03	56.9	8.71	65.9	10.48	70.6	11.41	75.2	12.48	84.2	14.63	93.6	16.12
	29	47.5	7.50	56.9	9.22	65.9	11.13	70.6	12.16	75.2	13.27	84.2	15.60	93.6	17.27
	31	47.5	7.96	56.9	9.83	65.9	11.88	70.6	12.99	75.2	14.16	84.2	16.63	93.6	18.32
	33	47.5	8.43	56.9	10.39	65.9	12.62	70.6	13.79	75.2	15.04	84.2	17.70	93.6	19.51
	35	47.5	8.90	56.9	11.09	65.9	13.41	70.6	14.67	75.2	16.02	84.2	18.86	93.6	20.68
	37	47.5	9.46	56.9	11.74	65.9	14.25	70.6	15.60	75.2	17.05	84.2	20.07	93.6	21.83
	39	47.5	10.04	56.9	12.52	65.9	15.24	70.6	16.79	75.2	18.41	84.2	21.48	93.6	23.53
	41	46.3	11.10	55.4	13.72	64.2	16.72	68.8	18.41	73.3	20.02	82.1	23.60	91.2	25.39
	43	45.2	12.08	54.1	14.95	62.6	18.24	67.1	20.08	71.5	21.86	80.1	25.78	88.9	27.45
46	42.3	13.43	50.7	16.81	58.7	20.54	62.8	22.36	67.0	24.64	75.0	29.08	83.4	30.59	
48	37.4	11.72	44.8	14.68	51.9	17.96	55.6	19.54	59.3	21.56	66.4	25.44	73.7	26.48	
60	10	40.7	5.13	48.6	6.02	56.5	7.00	60.5	7.51	64.4	7.98	72.4	9.05	80.3	10.13
	12	40.7	5.23	48.6	6.11	56.5	7.09	60.5	7.61	64.4	8.12	72.4	9.19	80.3	10.31
	14	40.7	5.27	48.6	6.21	56.5	7.23	60.5	7.75	64.4	8.26	72.4	9.38	80.3	10.50
	16	40.7	5.37	48.6	6.35	56.5	7.33	60.5	7.89	64.4	8.45	72.4	9.57	80.3	10.69
	18	40.7	5.46	48.6	6.44	56.5	7.47	60.5	8.03	64.4	8.59	72.4	9.71	80.3	10.92
	20	40.7	5.55	48.6	6.53	56.5	7.61	60.5	8.17	64.4	8.73	72.4	9.89	80.3	11.15
	21	40.7	5.60	48.6	6.58	56.5	7.70	60.5	8.26	64.4	8.82	72.4	10.03	80.3	11.25
	23	40.7	5.69	48.6	6.72	56.5	7.79	60.5	8.40	64.4	9.01	72.4	10.41	80.3	11.95
	25	40.7	5.79	48.6	6.86	56.5	8.12	60.5	8.82	64.4	9.57	72.4	11.11	80.3	12.79
	27	40.7	5.97	48.6	7.23	56.5	8.63	60.5	9.38	64.4	10.17	72.4	11.81	80.3	13.63
	29	40.7	6.35	48.6	7.70	56.5	9.19	60.5	9.99	64.4	10.83	72.4	12.60	80.3	14.56
	31	40.7	6.72	48.6	8.17	56.5	9.75	60.5	10.64	64.4	11.53	72.4	13.44	80.3	15.50
	33	40.7	7.09	48.6	8.63	56.5	10.36	60.5	11.29	64.4	12.27	72.4	14.28	80.3	16.52
	35	40.7	7.51	48.6	9.19	56.5	11.01	60.5	11.99	64.4	13.02	72.4	15.22	80.3	17.55
	37	40.7	7.93	48.6	9.70	56.5	11.67	60.5	12.74	64.4	13.81	72.4	16.15	80.3	18.67
	39	40.7	8.44	48.6	10.33	56.5	12.59	60.5	13.67	64.4	14.87	72.4	17.31	80.3	20.01
	41	39.6	9.15	47.4	11.31	55.1	13.68	58.9	14.93	62.8	16.14	70.5	19.00	78.2	21.74
	43	38.7	9.94	46.2	12.31	53.7	14.91	57.5	16.27	61.2	17.60	68.8	20.74	76.3	23.75
46	36.2	11.14	43.3	13.82	50.3	16.77	53.9	18.29	57.4	19.80	64.4	23.37	71.5	27.05	
48	32.0	9.70	38.3	12.06	44.5	14.65	47.6	15.98	50.8	17.30	57.0	20.44	63.2	23.67	
50	10	34.0	4.44	40.7	5.14	47.2	5.85	50.4	6.27	53.6	6.64	60.1	7.48	67.0	8.32
	12	34.0	4.49	40.7	5.19	47.2	5.94	50.4	6.36	53.6	6.78	60.1	7.62	67.0	8.46
	14	34.0	4.54	40.7	5.28	47.2	6.03	50.4	6.45	53.6	6.87	60.1	7.72	67.0	8.61
	16	34.0	4.63	40.7	5.38	47.2	6.13	50.4	6.59	53.6	6.97	60.1	7.86	67.0	8.75
	18	34.0	4.68	40.7	5.42	47.2	6.22	50.4	6.69	53.6	7.11	60.1	8.00	67.0	8.93
	20	34.0	4.72	40.7	5.52	47.2	6.36	50.4	6.78	53.6	7.25	60.1	8.14	67.0	9.12
	21	34.0	4.77	40.7	5.57	47.2	6.41	50.4	6.87	53.6	7.30	60.1	8.23	67.0	9.21
	23	34.0	4.86	40.7	5.66	47.2	6.50	50.4	6.97	53.6	7.44	60.1	8.37	67.0	9.40
	25	34.0	4.91	40.7	5.75	47.2	6.64	50.4	7.11	53.6	7.67	60.1	8.79	67.0	10.05
	27	34.0	5.00	40.7	5.94	47.2	7.02	50.4	7.58	53.6	8.14	60.1	9.40	67.0	10.71
	29	34.0	5.28	40.7	6.31	47.2	7.44	50.4	8.04	53.6	8.65	60.1	9.96	67.0	11.36
	31	34.0	5.57	40.7	6.69	47.2	7.90	50.4	8.51	53.6	9.21	60.1	10.62	67.0	12.11
	33	34.0	5.89	40.7	7.06	47.2	8.37	50.4	9.03	53.6	9.77	60.1	11.27	67.0	12.91
	35	34.0	6.22	40.7	7.48	47.2	8.84	50.4	9.59	53.6	10.34	60.1	11.93	67.0	13.70
	37	34.0	6.59	40.7	7.90	47.2	9.35	50.4	10.15	53.6	10.94	60.1	12.72	67.0	14.54
	39	34.0	7.03	40.7	8.47	47.2	10.02	50.4	10.92	53.6	11.74	60.1	13.55	67.0	15.71
	41	33.1	7.61	39.6	9.17	46.0	10.96	49.1	11.83	52.3	12.72	58.6	14.85	65.2	17.06
	43	32.3	8.27	38.7	9.98	44.8	11.92	47.9	12.88	51.0	13.85	57.1	16.20	63.6	18.61
46	30.3	9.26	36.2	11.19	42.0	13.38	44.9	14.47	47.8	15.55	53.5	18.22	59.6	20.95	
48	26.8	8.07	32.0	9.76	37.2	11.67	39.7	12.63	42.3	13.57	47.4	15.92	52.8	18.31	

**Note**

1. TC: Total Capacity(kW), PI : Power Input(kW, Comp. + Outdoor fan motor)
2. Capacity tables show the average value of conditions which may occur.

# 7. Capacity Tables

◆ ARUM380LTE5

Cooling Capacity (38HP)

Combination (%)	Outdoor air temp. (DB, °C)	Indoor air temp. (DB/WB, °C)													
		20		23		26		27		28		30		32	
		14	16	16	18	18	19	20	20	22	22	24	24		
		TC	PI	TC	PI	TC	PI	TC	PI	TC	PI	TC	PI	TC	PI
130	10	105.4	11.06	125.5	13.52	134.5	15.69	138.4	16.00	142.2	16.13	149.1	16.26	152.9	16.32
	12	105.4	11.34	125.5	14.00	134.5	16.33	138.4	16.44	142.2	16.57	149.1	16.70	152.9	16.85
	14	105.4	11.72	125.5	14.51	134.5	16.94	138.4	17.07	142.2	17.20	149.1	17.34	152.9	17.49
	16	105.4	12.14	125.5	15.02	134.5	17.70	138.4	17.87	142.2	18.01	149.1	18.17	152.9	18.31
	18	105.4	12.66	125.5	15.89	134.5	18.52	138.4	18.91	142.2	19.07	149.1	19.26	152.9	19.39
	20	105.4	13.21	125.5	16.92	134.5	19.43	138.4	20.81	142.2	20.97	146.9	21.18	150.8	21.33
	21	105.4	13.56	125.5	17.52	134.5	19.84	138.4	22.02	142.2	22.19	146.1	22.41	149.9	22.57
	23	105.4	14.55	125.5	18.43	134.5	20.87	138.4	24.30	140.4	24.49	143.9	24.73	147.8	24.90
	25	105.4	15.54	125.5	19.49	134.5	22.30	136.7	26.94	138.4	27.16	142.2	27.43	146.1	27.62
	27	105.4	16.63	125.5	20.83	132.8	23.76	134.5	29.66	136.7	29.90	140.4	30.20	143.9	30.40
	29	105.4	17.72	125.5	22.27	130.7	25.56	132.6	32.60	134.5	32.80	138.4	33.09	142.2	33.22
	31	105.4	18.90	125.1	23.46	128.5	27.19	130.7	32.46	132.6	32.66	136.2	32.95	140.1	33.08
	33	105.4	20.14	122.9	24.86	126.8	29.16	128.9	32.17	130.7	32.36	134.5	32.65	137.9	32.78
	35	105.4	21.48	120.8	26.03	124.6	31.59	126.8	31.75	128.9	31.94	132.4	32.22	136.2	32.35
	37	105.4	22.90	119.1	27.32	122.9	31.17	124.6	31.33	126.8	31.52	130.2	31.80	134.1	31.92
	39	105.4	24.39	117.0	28.76	120.8	30.75	122.9	30.91	124.6	31.09	128.5	31.37	132.4	31.50
41	102.7	25.87	112.1	30.19	115.9	30.34	117.6	30.49	119.9	30.67	123.5	30.95	126.9	31.07	
43	100.2	27.29	107.4	29.77	111.2	29.92	112.9	30.07	115.1	30.25	118.7	30.52	121.9	30.64	
46	93.9	29.21	98.0	29.15	101.6	29.29	103.1	29.44	105.3	29.62	108.6	29.88	111.6	30.00	
48	83.0	28.39	85.1	28.48	88.3	28.54	89.7	28.62	91.6	28.86	94.6	29.05	97.2	29.16	
120	10	95.4	9.95	113.4	12.20	123.9	14.50	127.7	15.67	131.5	15.92	138.6	15.98	142.0	16.11
	12	95.4	10.22	113.4	12.62	123.9	15.08	127.7	16.00	131.5	16.51	138.6	16.71	142.0	16.84
	14	95.4	10.57	113.4	13.05	123.9	15.69	127.7	16.61	131.5	17.11	138.6	17.37	142.0	17.51
	16	95.4	10.95	113.4	13.58	123.9	16.30	127.7	17.23	131.5	17.91	138.6	18.13	142.0	18.27
	18	95.4	11.38	113.4	14.19	123.9	16.95	127.7	18.14	131.5	18.82	138.6	19.04	142.0	19.19
	20	95.4	11.82	113.4	15.04	123.9	17.86	127.7	19.09	131.5	19.82	138.6	20.08	142.0	20.24
	21	95.4	12.17	113.4	15.59	123.9	18.37	127.7	19.65	131.5	20.47	138.6	20.73	142.0	20.90
	23	95.4	13.02	113.4	16.68	123.9	19.68	127.7	20.88	131.5	21.83	138.6	22.05	142.0	22.22
	25	95.4	13.91	113.4	17.87	123.9	20.76	127.7	22.26	131.5	23.41	137.0	23.60	140.3	23.79
	27	95.4	14.85	113.4	19.10	123.9	22.09	127.7	23.78	131.5	25.15	134.8	25.32	138.2	25.53
	29	95.4	15.84	113.4	20.39	123.9	23.24	127.7	25.45	129.3	26.81	132.7	27.21	136.5	27.43
	31	95.4	16.88	113.4	21.77	123.9	24.45	126.0	27.26	127.7	28.76	131.1	29.27	134.4	29.50
	33	95.4	17.96	113.4	23.21	122.2	25.86	123.9	29.59	125.6	30.88	128.9	31.23	132.3	31.48
	35	95.4	19.10	113.4	24.74	120.1	27.37	121.8	32.60	123.9	32.76	127.3	32.86	130.6	33.12
	37	95.4	20.55	113.4	26.11	118.4	29.18	120.1	31.91	121.8	32.07	125.2	32.17	128.5	32.43
	39	95.4	22.12	113.0	27.60	116.4	30.95	118.0	31.26	119.7	31.42	123.5	31.51	126.8	31.76
41	92.9	23.69	108.1	29.08	111.7	30.34	113.3	30.60	114.9	30.76	118.3	30.85	121.6	31.09	
43	90.6	25.29	103.5	28.67	107.1	29.66	108.7	29.95	110.3	30.10	113.5	30.19	116.8	30.43	
46	84.9	27.19	94.4	27.98	97.8	28.73	99.3	28.96	100.8	29.11	103.8	29.20	106.9	29.43	
48	75.1	26.64	82.0	27.49	85.0	28.17	86.3	28.34	87.6	28.43	90.3	28.54	93.0	28.66	
110	10	85.4	8.95	101.8	10.91	113.8	12.96	117.0	14.03	124.4	15.10	127.3	15.52	135.9	15.78
	12	85.4	9.23	101.8	11.28	113.8	13.50	117.0	14.43	124.4	15.66	127.3	16.17	135.9	16.54
	14	85.4	9.52	101.8	11.79	113.8	14.11	117.0	15.14	124.4	16.45	127.3	16.92	135.9	17.28
	16	85.4	9.86	101.8	12.22	113.8	14.69	117.0	15.80	124.4	17.21	127.3	17.68	135.9	17.99
	18	85.4	10.22	101.8	12.73	113.8	15.54	117.0	16.64	124.4	18.16	127.3	18.52	135.9	18.86
	20	85.4	10.59	101.8	13.36	113.8	16.48	117.0	17.40	124.4	19.04	127.3	19.51	135.9	19.82
	21	85.4	10.82	101.8	13.76	113.8	16.90	117.0	17.87	124.4	19.57	127.3	20.06	135.9	20.38
	23	85.4	11.53	101.8	14.75	113.8	17.85	117.0	18.87	124.4	20.67	127.3	21.12	135.9	21.47
	25	85.4	12.32	101.8	15.74	113.8	18.85	117.0	19.95	124.4	21.84	127.3	22.15	134.3	22.61
	27	85.4	13.16	101.8	16.83	113.8	19.92	117.0	21.11	124.4	22.81	127.3	23.33	132.3	23.73
	29	85.4	14.05	101.8	17.96	113.8	21.05	117.0	22.36	124.4	24.11	127.3	24.52	130.6	24.89
	31	85.4	14.95	101.8	19.15	113.8	22.25	117.0	23.69	122.4	25.33	125.6	25.83	128.6	26.10
	33	85.4	15.94	101.8	20.39	113.8	23.51	117.0	25.10	120.7	26.75	123.6	27.19	126.9	27.34
	35	85.4	16.92	101.8	21.77	113.8	24.83	117.0	26.60	118.7	28.23	121.6	28.49	124.9	28.63
	37	85.4	17.94	101.8	23.11	113.8	26.21	115.4	28.18	116.6	29.78	119.9	29.88	122.8	29.96
	39	85.4	19.34	101.8	24.56	111.7	27.65	113.3	30.14	115.0	31.25	117.9	31.30	121.2	31.34
41	83.2	20.74	99.2	26.01	106.9	29.16	108.6	32.60	110.0	32.60	113.2	32.86	116.0	33.12	
43	81.2	21.78	96.8	27.09	102.5	30.92	104.1	31.27	105.5	31.20	108.6	31.38	111.4	31.47	
46	76.1	21.26	90.7	26.16	93.5	29.35	95.1	29.35	96.4	29.60	99.3	29.76	101.9	29.84	
48	67.3	20.64	78.8	25.20	81.2	27.92	82.7	28.11	83.8	28.24	86.4	28.32	88.6	28.44	

# 7. Capacity Tables

Cooling Capacity (38HP)

Combination (%)	Outdoor air temp. (DB, °C)	Indoor air temp. (DB/WB, °C)													
		20		23		26		27		28		30		32	
		14		16		18		19		20		22		24	
		TC	PI	TC	PI	TC	PI	TC	PI	TC	PI	TC	PI	TC	PI
100	10	71.8	8.06	85.5	9.80	99.6	11.62	106.4	12.56	113.2	13.50	125.6	15.02	128.3	15.14
	12	71.8	8.32	85.5	10.20	99.6	12.02	106.4	12.90	113.2	13.93	125.6	15.83	128.3	15.99
	14	71.8	8.58	85.5	10.61	99.6	12.52	106.4	13.46	113.2	14.53	125.6	16.72	128.3	16.87
	16	71.8	8.84	85.5	10.96	99.6	13.06	106.4	14.10	113.2	15.31	125.6	17.52	128.3	17.77
	18	71.8	9.10	85.5	11.36	99.6	13.56	106.4	14.78	113.2	16.23	125.6	18.51	128.3	18.66
	20	71.8	9.43	85.5	11.79	99.6	14.35	106.4	15.84	113.2	17.37	125.6	19.40	128.3	19.56
	21	71.8	9.62	85.5	12.07	99.6	14.85	106.4	16.38	113.2	18.01	125.6	19.84	128.3	20.00
	23	71.8	10.19	85.5	12.92	99.6	15.94	106.4	17.57	113.2	19.30	125.6	20.78	128.3	20.95
	25	71.8	10.84	85.5	13.76	99.6	17.02	106.4	18.81	113.2	20.64	125.6	21.67	127.2	21.84
	27	71.8	11.58	85.5	14.70	99.6	18.21	106.4	20.09	113.2	21.94	123.1	22.69	125.7	22.87
	29	71.8	12.32	85.5	15.69	99.6	19.45	106.4	21.48	113.2	23.22	120.8	23.60	123.8	23.79
	31	71.8	13.16	85.5	16.73	99.6	20.74	106.4	22.91	113.2	24.40	119.0	24.51	121.9	24.71
	33	71.8	13.96	85.5	17.82	99.6	22.12	106.4	24.45	113.2	25.32	117.1	25.43	120.0	25.63
	35	71.8	14.85	85.5	18.95	99.6	23.56	106.4	26.08	111.5	26.24	115.0	26.34	117.9	26.55
	37	71.8	15.90	85.5	20.33	99.6	24.95	106.4	27.32	109.7	27.46	112.8	27.57	115.5	27.82
	39	71.8	17.05	85.5	21.84	99.6	26.44	106.4	28.66	107.8	28.78	111.0	28.89	113.6	29.16
	41	70.7	18.19	84.1	23.35	98.0	27.93	102.1	29.99	104.3	30.11	106.8	30.22	110.3	30.50
	43	68.3	19.25	81.3	24.75	94.6	29.27	97.9	31.14	99.0	31.25	102.1	31.35	104.7	31.65
46	64.0	20.71	76.1	26.68	88.7	31.04	89.4	32.60	90.3	32.70	93.2	32.79	95.7	33.10	
48	56.6	17.88	67.4	23.08	76.5	26.54	77.7	27.66	78.5	27.75	81.1	27.81	83.3	28.04	
90	10	64.6	7.47	77.1	8.98	89.7	10.59	95.8	11.41	101.8	12.28	114.4	13.75	126.9	15.14
	12	64.6	7.56	77.1	9.12	89.7	10.77	95.8	11.64	101.8	12.56	114.4	14.02	126.9	15.56
	14	64.6	7.70	77.1	9.30	89.7	11.00	95.8	11.87	101.8	12.78	114.4	14.29	126.9	15.87
	16	64.6	7.84	77.1	9.49	89.7	11.23	95.8	12.10	101.8	13.01	114.4	14.56	126.9	16.14
	18	64.6	7.97	77.1	9.67	89.7	11.41	95.8	12.37	101.8	13.29	114.4	14.88	126.9	16.96
	20	64.6	8.11	77.1	9.85	89.7	11.64	95.8	12.60	101.8	13.79	114.4	15.92	126.9	17.77
	21	64.6	8.20	77.1	9.94	89.7	11.87	95.8	13.01	101.8	14.30	114.4	16.18	126.9	18.17
	23	64.6	8.39	77.1	10.36	89.7	12.69	95.8	13.98	101.8	15.31	114.4	17.16	125.2	19.03
	25	64.6	8.80	77.1	11.04	89.7	13.56	95.8	14.94	101.8	16.36	114.4	18.35	123.4	19.84
	27	64.6	9.39	77.1	11.78	89.7	14.48	95.8	15.95	101.8	17.50	114.4	19.51	121.6	20.77
	29	64.6	9.94	77.1	12.56	89.7	15.49	95.8	17.05	101.8	18.70	114.4	20.67	119.8	21.61
	31	64.6	10.59	77.1	13.38	89.7	16.50	95.8	18.15	101.8	19.93	114.4	21.70	117.9	22.45
	33	64.6	11.27	77.1	14.25	89.7	17.60	95.8	19.34	101.8	21.14	114.4	22.75	116.1	23.28
	35	64.6	11.96	77.1	15.12	89.7	18.70	95.8	20.62	101.8	22.42	112.4	24.05	114.3	24.60
	37	64.6	12.69	77.1	16.08	89.7	19.94	95.8	21.91	101.8	23.67	110.6	25.14	112.5	25.71
	39	64.6	13.44	77.1	17.11	89.7	21.10	95.8	23.31	101.8	24.89	108.8	26.51	110.7	26.83
	41	62.9	15.04	75.2	18.97	87.4	23.16	93.3	25.49	99.2	26.87	104.2	27.93	106.1	28.57
	43	61.4	16.23	73.3	20.50	85.2	25.30	91.0	27.45	96.8	28.81	100.0	29.91	101.8	30.28
46	57.5	18.27	68.7	23.34	79.9	28.82	85.3	31.13	87.9	32.01	91.3	32.72	93.0	32.85	
48	50.9	15.97	60.8	20.42	70.7	25.22	75.4	27.15	76.4	27.55	79.3	27.81	80.8	28.04	
80	10	57.4	6.97	68.4	8.37	79.4	9.83	85.1	10.60	90.8	11.37	101.8	12.97	112.9	14.08
	12	57.4	7.11	68.4	8.47	79.4	10.02	85.1	10.79	90.8	11.57	101.8	13.21	112.9	14.36
	14	57.4	7.21	68.4	8.66	79.4	10.16	85.1	10.99	90.8	11.76	101.8	13.46	112.9	14.64
	16	57.4	7.31	68.4	8.81	79.4	10.36	85.1	11.18	90.8	12.00	101.8	13.75	112.9	14.92
	18	57.4	7.45	68.4	8.95	79.4	10.55	85.1	11.37	90.8	12.25	101.8	13.99	112.9	15.24
	20	57.4	7.60	68.4	9.15	79.4	10.79	85.1	11.62	90.8	12.49	101.8	14.52	112.9	16.15
	21	57.4	7.65	68.4	9.24	79.4	10.89	85.1	11.76	90.8	12.78	101.8	14.98	112.9	16.58
	23	57.4	7.79	68.4	9.39	79.4	11.37	85.1	12.49	90.8	13.65	101.8	15.81	112.9	17.40
	25	57.4	8.08	68.4	10.02	79.4	12.20	85.1	13.36	90.8	14.62	101.8	16.92	112.9	18.61
	27	57.4	8.57	68.4	10.65	79.4	13.02	85.1	14.28	90.8	15.58	101.8	17.98	112.9	19.58
	29	57.4	9.10	68.4	11.37	79.4	13.84	85.1	15.20	90.8	16.65	101.8	19.27	112.9	20.53
	31	57.4	9.68	68.4	12.05	79.4	14.76	85.1	16.21	90.8	17.71	101.8	20.45	112.9	21.55
	33	57.4	10.26	68.4	12.87	79.4	15.73	85.1	17.28	90.8	18.88	101.8	21.54	112.9	22.59
	35	57.4	10.89	68.4	13.65	79.4	16.75	85.1	18.39	90.8	20.13	101.8	22.84	111.7	23.86
	37	57.4	11.52	68.4	14.51	79.4	17.76	85.1	19.55	90.8	21.39	101.8	24.11	109.9	24.99
	39	57.4	12.17	68.4	15.34	79.4	19.00	85.1	21.02	90.8	22.99	101.8	25.47	108.0	26.37
	41	55.9	13.47	66.6	17.00	77.4	20.85	82.9	23.04	88.5	25.26	99.2	27.38	103.5	28.00
	43	54.5	14.83	65.0	18.55	75.5	22.76	80.9	25.11	86.3	27.61	96.8	29.31	99.2	29.97
46	51.1	16.49	60.9	20.90	70.7	25.65	75.8	27.95	80.9	31.15	88.5	32.72	90.6	32.85	
48	45.2	14.40	53.9	18.27	62.6	22.43	67.1	24.41	71.6	27.27	76.9	27.81	78.7	28.04	

# 7. Capacity Tables

Cooling Capacity (38HP)

Combination (%)	Outdoor air temp. (DB, °C)	Indoor air temp. (DB/WB, °C)													
		20		23		26		27		28		30		32	
		14		16		18		19		20		22		24	
		TC	PI	TC	PI	TC	PI	TC	PI	TC	PI	TC	PI	TC	PI
70	10	50.2	6.17	60.0	7.33	69.5	8.50	74.5	9.18	79.4	9.81	88.9	11.17	98.8	12.49
	12	50.2	6.26	60.0	7.43	69.5	8.69	74.5	9.32	79.4	10.00	88.9	11.36	98.8	12.73
	14	50.2	6.36	60.0	7.53	69.5	8.84	74.5	9.47	79.4	10.15	88.9	11.61	98.8	12.96
	16	50.2	6.46	60.0	7.67	69.5	8.98	74.5	9.66	79.4	10.34	88.9	11.80	98.8	13.24
	18	50.2	6.56	60.0	7.82	69.5	9.18	74.5	9.86	79.4	10.54	88.9	12.00	98.8	13.47
	20	50.2	6.65	60.0	7.96	69.5	9.32	74.5	10.05	79.4	10.78	88.9	12.29	98.8	13.99
	21	50.2	6.75	60.0	8.01	69.5	9.42	74.5	10.15	79.4	10.88	88.9	12.48	98.8	14.28
	23	50.2	6.85	60.0	8.21	69.5	9.62	74.5	10.49	79.4	11.41	88.9	13.36	98.8	15.08
	25	50.2	6.94	60.0	8.50	69.5	10.25	74.5	11.22	79.4	12.19	88.9	14.28	98.8	15.81
	27	50.2	7.33	60.0	9.08	69.5	10.93	74.5	11.90	79.4	13.02	88.9	15.25	98.8	16.80
	29	50.2	7.82	60.0	9.62	69.5	11.61	74.5	12.68	79.4	13.84	88.9	16.27	98.8	18.00
	31	50.2	8.30	60.0	10.25	69.5	12.38	74.5	13.55	79.4	14.76	88.9	17.34	98.8	19.10
	33	50.2	8.79	60.0	10.83	69.5	13.16	74.5	14.37	79.4	15.69	88.9	18.45	98.8	20.34
	35	50.2	9.28	60.0	11.56	69.5	13.99	74.5	15.30	79.4	16.71	88.9	19.67	98.8	21.56
	37	50.2	9.86	60.0	12.24	69.5	14.86	74.5	16.27	79.4	17.77	88.9	20.93	98.8	22.76
	39	50.2	10.47	60.0	13.05	69.5	15.89	74.5	17.50	79.4	19.20	88.9	22.40	98.8	24.54
	41	48.9	11.57	58.5	14.30	67.8	17.43	72.6	19.20	77.4	20.87	86.6	24.60	96.3	26.47
	43	47.7	12.60	57.1	15.59	66.1	19.02	70.8	20.93	75.5	22.79	84.5	26.88	93.9	28.62
46	44.7	14.00	53.5	17.53	61.9	21.42	66.3	23.32	70.7	25.69	79.2	30.32	88.0	31.90	
48	39.5	12.22	47.3	15.31	54.8	18.72	58.7	20.38	62.6	22.48	70.1	26.53	77.8	27.61	
60	10	42.9	5.36	51.3	6.29	59.7	7.31	63.8	7.85	68.0	8.33	76.4	9.45	84.7	10.57
	12	42.9	5.46	51.3	6.38	59.7	7.41	63.8	7.94	68.0	8.48	76.4	9.60	84.7	10.77
	14	42.9	5.51	51.3	6.48	59.7	7.55	63.8	8.09	68.0	8.62	76.4	9.79	84.7	10.96
	16	42.9	5.60	51.3	6.63	59.7	7.65	63.8	8.24	68.0	8.82	76.4	9.99	84.7	11.16
	18	42.9	5.70	51.3	6.72	59.7	7.80	63.8	8.38	68.0	8.97	76.4	10.14	84.7	11.40
	20	42.9	5.80	51.3	6.82	59.7	7.94	63.8	8.53	68.0	9.11	76.4	10.33	84.7	11.65
	21	42.9	5.85	51.3	6.87	59.7	8.04	63.8	8.62	68.0	9.21	76.4	10.48	84.7	11.74
	23	42.9	5.94	51.3	7.02	59.7	8.14	63.8	8.77	68.0	9.40	76.4	10.87	84.7	12.47
	25	42.9	6.04	51.3	7.16	59.7	8.48	63.8	9.21	68.0	9.99	76.4	11.60	84.7	13.35
	27	42.9	6.24	51.3	7.55	59.7	9.01	63.8	9.79	68.0	10.62	76.4	12.33	84.7	14.23
	29	42.9	6.63	51.3	8.04	59.7	9.60	63.8	10.43	68.0	11.30	76.4	13.16	84.7	15.20
	31	42.9	7.02	51.3	8.53	59.7	10.18	63.8	11.11	68.0	12.04	76.4	14.03	84.7	16.18
	33	42.9	7.41	51.3	9.01	59.7	10.82	63.8	11.79	68.0	12.82	76.4	14.91	84.7	17.25
	35	42.9	7.85	51.3	9.60	59.7	11.50	63.8	12.52	68.0	13.60	76.4	15.89	84.7	18.32
	37	42.9	8.28	51.3	10.13	59.7	12.18	63.8	13.30	68.0	14.42	76.4	16.86	84.7	19.49
	39	42.9	8.81	51.3	10.79	59.7	13.15	63.8	14.27	68.0	15.52	76.4	18.08	84.7	20.89
	41	41.8	9.56	50.0	11.80	58.1	14.28	62.2	15.59	66.3	16.85	74.4	19.84	82.6	22.70
	43	40.8	10.38	48.8	12.85	56.7	15.57	60.7	16.99	64.6	18.37	72.6	21.66	80.5	24.79
46	38.2	11.63	45.7	14.43	53.1	17.51	56.9	19.10	60.6	20.67	68.0	24.40	75.5	28.25	
48	33.8	10.13	40.4	12.59	47.0	15.30	50.3	16.68	53.6	18.07	60.2	21.34	66.8	24.71	
50	10	35.9	4.64	42.9	5.38	49.8	6.11	53.2	6.55	56.6	6.94	63.5	7.82	70.7	8.70
	12	35.9	4.69	42.9	5.43	49.8	6.21	53.2	6.65	56.6	7.09	63.5	7.97	70.7	8.85
	14	35.9	4.74	42.9	5.52	49.8	6.31	53.2	6.75	56.6	7.19	63.5	8.07	70.7	9.00
	16	35.9	4.84	42.9	5.62	49.8	6.40	53.2	6.89	56.6	7.28	63.5	8.21	70.7	9.14
	18	35.9	4.89	42.9	5.67	49.8	6.50	53.2	6.99	56.6	7.43	63.5	8.36	70.7	9.34
	20	35.9	4.94	42.9	5.77	49.8	6.65	53.2	7.09	56.6	7.58	63.5	8.51	70.7	9.53
	21	35.9	4.99	42.9	5.82	49.8	6.70	53.2	7.19	56.6	7.63	63.5	8.60	70.7	9.63
	23	35.9	5.08	42.9	5.92	49.8	6.80	53.2	7.28	56.6	7.77	63.5	8.75	70.7	9.83
	25	35.9	5.13	42.9	6.01	49.8	6.94	53.2	7.43	56.6	8.02	63.5	9.19	70.7	10.51
	27	35.9	5.23	42.9	6.21	49.8	7.33	53.2	7.92	56.6	8.51	63.5	9.83	70.7	11.20
	29	35.9	5.52	42.9	6.60	49.8	7.77	53.2	8.41	56.6	9.05	63.5	10.41	70.7	11.88
	31	35.9	5.82	42.9	6.99	49.8	8.26	53.2	8.90	56.6	9.63	63.5	11.10	70.7	12.66
	33	35.9	6.16	42.9	7.38	49.8	8.75	53.2	9.44	56.6	10.22	63.5	11.78	70.7	13.49
	35	35.9	6.50	42.9	7.82	49.8	9.24	53.2	10.02	56.6	10.81	63.5	12.47	70.7	14.33
	37	35.9	6.89	42.9	8.26	49.8	9.78	53.2	10.61	56.6	11.44	63.5	13.30	70.7	15.21
	39	35.9	7.35	42.9	8.86	49.8	10.48	53.2	11.42	56.6	12.28	63.5	14.16	70.7	16.42
	41	35.0	7.95	41.8	9.59	48.5	11.46	51.8	12.37	55.2	13.30	61.8	15.53	68.9	17.83
	43	34.1	8.64	40.8	10.43	47.3	12.46	50.6	13.47	53.8	14.48	60.3	16.93	67.2	19.46
46	32.0	9.68	38.2	11.70	44.3	13.98	47.4	15.12	50.4	16.26	56.5	19.05	62.9	21.90	
48	28.3	8.43	33.8	10.20	39.2	12.20	41.9	13.20	44.6	14.19	50.0	16.65	55.7	19.15	

**Note**

1. TC: Total Capacity(kW), PI : Power Input(kW, Comp. + Outdoor fan motor)
2. Capacity tables show the average value of conditions which may occur.

# 7. Capacity Tables

◆ ARUM400LTE5

Cooling Capacity (40HP)

Combination (%)	Outdoor air temp. (DB, °C)	Indoor air temp. (DB/WB, °C)													
		20		23		26		27		28		30		32	
		14	16	16	18	18	19	20	20	22	22	24	24		
		TC	PI	TC	PI	TC	PI	TC	PI	TC	PI	TC	PI	TC	PI
130	10	110.9	12.01	132.1	14.68	141.6	17.03	145.7	17.37	149.7	17.51	156.9	17.65	161.0	17.72
	12	110.9	12.31	132.1	15.20	141.6	17.73	145.7	17.84	149.7	17.98	156.9	18.13	161.0	18.29
	14	110.9	12.72	132.1	15.75	141.6	18.39	145.7	18.53	149.7	18.67	156.9	18.82	161.0	18.99
	16	110.9	13.18	132.1	16.30	141.6	19.22	145.7	19.40	149.7	19.55	156.9	19.73	161.0	19.88
	18	110.9	13.74	132.1	17.24	141.6	20.10	145.7	20.53	149.7	20.70	156.9	20.90	161.0	21.05
	20	110.9	14.34	132.1	18.37	141.6	21.09	145.7	22.59	149.7	22.77	154.6	22.99	158.7	23.15
	21	110.9	14.72	132.1	19.02	141.6	21.53	145.7	23.90	149.7	24.09	153.8	24.33	157.8	24.50
	23	110.9	15.79	132.1	20.01	141.6	22.65	145.7	26.37	147.8	26.58	151.5	26.85	155.6	27.03
	25	110.9	16.87	132.1	21.16	141.6	24.21	143.9	29.25	145.7	29.48	149.7	29.78	153.8	29.98
	27	110.9	18.05	132.1	22.61	139.8	25.79	141.6	32.20	143.9	32.46	147.8	32.78	151.5	33.00
	29	110.9	19.23	132.1	24.18	137.5	27.75	139.5	35.39	141.6	35.60	145.7	35.92	149.7	36.06
	31	110.9	20.52	131.7	25.47	135.3	29.52	137.5	35.24	139.5	35.45	143.4	35.77	147.4	35.91
	33	110.9	21.86	129.4	26.98	133.5	31.66	135.6	34.92	137.5	35.13	141.6	35.44	145.2	35.58
	35	110.9	23.31	127.1	28.26	131.2	34.29	133.5	34.46	135.6	34.67	139.3	34.98	143.4	35.12
	37	110.9	24.86	125.3	29.66	129.4	33.84	131.2	34.01	133.5	34.21	137.1	34.52	141.2	34.65
	39	110.9	26.47	123.1	31.22	127.1	33.38	129.4	33.55	131.2	33.75	135.3	34.06	139.3	34.19
	41	108.1	28.09	118.0	32.78	122.0	32.93	123.8	33.10	126.2	33.30	130.1	33.59	133.6	33.73
	43	105.4	29.62	113.1	32.32	117.0	32.48	118.8	32.64	121.2	32.84	124.9	33.13	128.3	33.26
46	98.8	31.70	103.2	31.64	106.9	31.80	108.6	31.96	110.8	32.15	114.3	32.44	117.5	32.57	
48	87.4	30.82	89.6	30.91	92.9	30.98	94.4	31.06	96.4	31.33	99.5	31.53	102.3	31.65	
120	10	100.4	10.80	119.4	13.25	130.4	15.74	134.4	17.01	138.4	17.28	145.9	17.35	149.5	17.49
	12	100.4	11.10	119.4	13.69	130.4	16.37	134.4	17.37	138.4	17.92	145.9	18.14	149.5	18.28
	14	100.4	11.48	119.4	14.16	130.4	17.04	134.4	18.03	138.4	18.58	145.9	18.85	149.5	19.00
	16	100.4	11.89	119.4	14.74	130.4	17.70	134.4	18.70	138.4	19.44	145.9	19.68	149.5	19.83
	18	100.4	12.36	119.4	15.40	130.4	18.40	134.4	19.69	138.4	20.43	145.9	20.67	149.5	20.83
	20	100.4	12.83	119.4	16.33	130.4	19.39	134.4	20.72	138.4	21.52	145.9	21.80	149.5	21.97
	21	100.4	13.21	119.4	16.92	130.4	19.94	134.4	21.33	138.4	22.22	145.9	22.51	149.5	22.69
	23	100.4	14.13	119.4	18.10	130.4	21.36	134.4	22.66	138.4	23.69	145.9	23.93	149.5	24.12
	25	100.4	15.10	119.4	19.39	130.4	22.53	134.4	24.16	138.4	25.41	144.2	25.62	147.7	25.83
	27	100.4	16.12	119.4	20.74	130.4	23.98	134.4	25.81	138.4	27.30	141.9	27.49	145.5	27.71
	29	100.4	17.19	119.4	22.13	130.4	25.23	134.4	27.62	136.2	29.10	139.7	29.54	143.7	29.77
	31	100.4	18.32	119.4	23.64	130.4	26.54	132.7	29.60	134.4	31.22	138.0	31.77	141.5	32.02
	33	100.4	19.50	119.4	25.19	128.7	28.07	130.4	32.12	132.2	33.52	135.7	33.90	139.3	34.17
	35	100.4	20.74	119.4	26.86	126.5	29.71	128.2	35.39	130.4	35.56	134.0	35.67	137.5	35.95
	37	100.4	22.30	119.4	28.34	124.7	31.68	126.5	34.64	128.2	34.82	131.8	34.92	135.3	35.20
	39	100.4	24.01	118.9	29.96	122.5	33.60	124.2	33.93	126.0	34.10	130.0	34.20	133.5	34.47
	41	97.8	25.72	113.7	31.57	117.6	32.93	119.2	33.22	121.0	33.39	124.5	33.49	128.0	33.75
	43	95.4	27.45	109.0	31.12	112.8	32.20	114.4	32.51	116.1	32.67	119.5	32.77	122.9	33.03
46	89.4	29.52	99.4	30.37	103.0	31.19	104.5	31.44	106.1	31.60	109.3	31.69	112.5	31.94	
48	79.1	28.91	86.3	29.84	89.5	30.58	90.8	30.76	92.2	30.86	95.1	30.98	97.9	31.11	
110	10	89.9	9.72	107.2	11.85	119.8	14.07	123.2	15.23	131.0	16.39	134.0	16.84	143.1	17.13
	12	89.9	10.02	107.2	12.24	119.8	14.65	123.2	15.66	131.0	17.00	134.0	17.55	143.1	17.96
	14	89.9	10.33	107.2	12.80	119.8	15.32	123.2	16.43	131.0	17.86	134.0	18.37	143.1	18.76
	16	89.9	10.70	107.2	13.26	119.8	15.95	123.2	17.15	131.0	18.68	134.0	19.19	143.1	19.53
	18	89.9	11.10	107.2	13.81	119.8	16.87	123.2	18.06	131.0	19.71	134.0	20.10	143.1	20.47
	20	89.9	11.49	107.2	14.50	119.8	17.89	123.2	18.89	131.0	20.67	134.0	21.18	143.1	21.52
	21	89.9	11.75	107.2	14.93	119.8	18.35	123.2	19.40	131.0	21.24	134.0	21.78	143.1	22.12
	23	89.9	12.52	107.2	16.01	119.8	19.37	123.2	20.48	131.0	22.44	134.0	22.92	143.1	23.30
	25	89.9	13.38	107.2	17.08	119.8	20.47	123.2	21.65	131.0	23.71	134.0	24.05	141.3	24.54
	27	89.9	14.29	107.2	18.26	119.8	21.63	123.2	22.91	131.0	24.76	134.0	25.33	139.2	25.76
	29	89.9	15.26	107.2	19.50	119.8	22.85	123.2	24.27	131.0	26.17	134.0	26.62	137.5	27.02
	31	89.9	16.22	107.2	20.79	119.8	24.15	123.2	25.71	128.8	27.50	132.3	28.04	135.3	28.33
	33	89.9	17.30	107.2	22.13	119.8	25.52	123.2	27.25	127.1	29.04	130.1	29.52	133.6	29.68
	35	89.9	18.37	107.2	23.64	119.8	26.95	123.2	28.87	124.9	30.65	128.0	30.93	131.4	31.08
	37	89.9	19.47	107.2	25.09	119.8	28.45	121.5	30.59	122.8	32.32	126.2	32.43	129.3	32.53
	39	89.9	20.99	107.2	26.66	117.6	30.02	119.3	32.72	121.1	33.92	124.1	33.98	127.5	34.01
	41	87.6	22.51	104.5	28.23	112.5	31.65	114.3	35.39	115.8	35.39	119.2	35.67	122.1	35.95
	43	85.5	23.64	101.9	29.41	107.9	33.57	109.6	33.95	111.0	33.87	114.4	34.06	117.2	34.16
46	80.1	23.07	95.5	28.39	98.4	31.86	100.1	31.86	101.4	32.13	104.5	32.31	107.2	32.40	
48	70.8	22.41	83.0	27.35	85.5	30.31	87.0	30.51	88.2	30.66	90.9	30.75	93.3	30.87	

# 7. Capacity Tables

Cooling Capacity (40HP)

Combination (%)	Outdoor air temp. (DB, °C)	Indoor air temp. (DB/WB, °C)													
		20		23		26		27		28		30		32	
		14		16		18		19		20		22		24	
		TC	PI	TC	PI	TC	PI	TC	PI	TC	PI	TC	PI	TC	PI
100	10	75.6	8.75	90.0	10.64	104.8	12.62	112.0	13.63	119.2	14.65	132.2	16.31	135.1	16.44
	12	75.6	9.03	90.0	11.07	104.8	13.04	112.0	14.00	119.2	15.12	132.2	17.18	135.1	17.35
	14	75.6	9.31	90.0	11.51	104.8	13.60	112.0	14.61	119.2	15.77	132.2	18.15	135.1	18.32
	16	75.6	9.60	90.0	11.89	104.8	14.18	112.0	15.30	119.2	16.62	132.2	19.02	135.1	19.29
	18	75.6	9.88	90.0	12.34	104.8	14.72	112.0	16.05	119.2	17.62	132.2	20.10	135.1	20.26
	20	75.6	10.23	90.0	12.80	104.8	15.58	112.0	17.19	119.2	18.86	132.2	21.06	135.1	21.23
	21	75.6	10.45	90.0	13.11	104.8	16.12	112.0	17.78	119.2	19.55	132.2	21.54	135.1	21.71
	23	75.6	11.07	90.0	14.02	104.8	17.30	112.0	19.07	119.2	20.95	132.2	22.56	135.1	22.74
	25	75.6	11.76	90.0	14.93	104.8	18.48	112.0	20.41	119.2	22.40	132.2	23.52	133.9	23.71
	27	75.6	12.57	90.0	15.95	104.8	19.77	112.0	21.81	119.2	23.82	129.6	24.62	132.3	24.82
	29	75.6	13.38	90.0	17.03	104.8	21.11	112.0	23.31	119.2	25.21	127.2	25.62	130.3	25.82
	31	75.6	14.29	90.0	18.16	104.8	22.51	112.0	24.87	119.2	26.49	125.3	26.61	128.3	26.82
	33	75.6	15.15	90.0	19.34	104.8	24.01	112.0	26.54	119.2	27.48	123.3	27.60	126.3	27.82
	35	75.6	16.12	90.0	20.57	104.8	25.57	112.0	28.31	117.4	28.48	121.0	28.59	124.1	28.82
	37	75.6	17.26	90.0	22.07	104.8	27.09	112.0	29.66	115.4	29.80	118.8	29.92	121.6	30.20
	39	75.6	18.50	90.0	23.71	104.8	28.70	112.0	31.11	113.5	31.25	116.9	31.36	119.6	31.65
	41	74.4	19.75	88.6	25.34	103.1	30.32	107.5	32.56	109.8	32.69	112.4	32.80	116.1	33.11
	43	71.8	20.90	85.5	26.87	99.6	31.77	103.0	33.80	104.2	33.92	107.4	34.03	110.3	34.35
46	67.3	22.48	80.2	28.96	93.3	33.70	94.1	35.39	95.1	35.49	98.1	35.59	100.8	35.93	
48	59.6	19.41	70.9	25.06	80.6	28.81	81.8	30.03	82.6	30.12	85.3	30.19	87.7	30.43	
90	10	68.0	8.15	81.2	9.79	94.4	11.54	100.8	12.44	107.2	13.39	120.4	14.99	133.6	16.44
	12	68.0	8.25	81.2	9.94	94.4	11.74	100.8	12.69	107.2	13.69	120.4	15.29	133.6	16.97
	14	68.0	8.40	81.2	10.14	94.4	11.99	100.8	12.94	107.2	13.94	120.4	15.58	133.6	17.31
	16	68.0	8.55	81.2	10.34	94.4	12.24	100.8	13.19	107.2	14.19	120.4	15.88	133.6	17.60
	18	68.0	8.70	81.2	10.54	94.4	12.44	100.8	13.49	107.2	14.49	120.4	16.23	133.6	18.49
	20	68.0	8.84	81.2	10.74	94.4	12.69	100.8	13.74	107.2	15.04	120.4	17.36	133.6	19.37
	21	68.0	8.94	81.2	10.84	94.4	12.94	100.8	14.19	107.2	15.59	120.4	17.65	133.6	19.82
	23	68.0	9.14	81.2	11.29	94.4	13.84	100.8	15.24	107.2	16.69	120.4	18.72	131.8	20.75
	25	68.0	9.59	81.2	12.04	94.4	14.79	100.8	16.29	107.2	17.84	120.4	20.01	129.9	21.64
	27	68.0	10.24	81.2	12.84	94.4	15.79	100.8	17.39	107.2	19.09	120.4	21.28	128.0	22.65
	29	68.0	10.84	81.2	13.69	94.4	16.89	100.8	18.59	107.2	20.39	120.4	22.54	126.1	23.57
	31	68.0	11.54	81.2	14.59	94.4	17.99	100.8	19.79	107.2	21.74	120.4	23.66	124.2	24.48
	33	68.0	12.29	81.2	15.54	94.4	19.19	100.8	21.09	107.2	23.06	120.4	24.80	122.2	25.39
	35	68.0	13.04	81.2	16.49	94.4	20.39	100.8	22.49	107.2	24.45	118.3	26.23	120.3	26.83
	37	68.0	13.84	81.2	17.54	94.4	21.74	100.8	23.89	107.2	25.81	116.4	27.42	118.4	28.03
	39	68.0	14.66	81.2	18.66	94.4	23.01	100.8	25.42	107.2	27.14	114.5	28.91	116.5	29.25
	41	66.3	16.40	79.1	20.68	92.0	25.25	98.2	27.80	104.5	29.30	109.7	30.46	111.7	31.16
	43	64.6	17.70	77.2	22.35	89.7	27.59	95.8	29.94	101.9	31.42	105.2	32.59	107.1	33.02
46	60.6	19.92	72.3	25.45	84.1	31.43	89.8	33.94	92.6	34.90	96.1	35.52	97.9	35.68	
48	53.6	17.41	64.0	22.26	74.4	27.50	79.4	29.60	80.4	29.92	83.5	30.19	85.1	30.43	
80	10	60.4	7.60	72.0	9.13	83.6	10.72	89.6	11.56	95.6	12.41	107.2	14.15	118.8	15.36
	12	60.4	7.76	72.0	9.24	83.6	10.93	89.6	11.77	95.6	12.62	107.2	14.41	118.8	15.66
	14	60.4	7.87	72.0	9.45	83.6	11.09	89.6	11.98	95.6	12.83	107.2	14.68	118.8	15.97
	16	60.4	7.97	72.0	9.61	83.6	11.30	89.6	12.19	95.6	13.09	107.2	14.99	118.8	16.27
	18	60.4	8.13	72.0	9.77	83.6	11.51	89.6	12.41	95.6	13.36	107.2	15.26	118.8	16.63
	20	60.4	8.29	72.0	9.98	83.6	11.77	89.6	12.67	95.6	13.62	107.2	15.84	118.8	17.62
	21	60.4	8.34	72.0	10.08	83.6	11.88	89.6	12.83	95.6	13.94	107.2	16.34	118.8	18.08
	23	60.4	8.50	72.0	10.24	83.6	12.41	89.6	13.62	95.6	14.89	107.2	17.25	118.8	18.98
	25	60.4	8.82	72.0	10.93	83.6	13.30	89.6	14.57	95.6	15.94	107.2	18.46	118.8	20.29
	27	60.4	9.34	72.0	11.61	83.6	14.20	89.6	15.57	95.6	17.00	107.2	19.62	118.8	21.35
	29	60.4	9.92	72.0	12.41	83.6	15.10	89.6	16.58	95.6	18.16	107.2	21.02	118.8	22.39
	31	60.4	10.56	72.0	13.15	83.6	16.10	89.6	17.69	95.6	19.32	107.2	22.30	118.8	23.50
	33	60.4	11.19	72.0	14.04	83.6	17.16	89.6	18.85	95.6	20.59	107.2	23.50	118.8	24.63
	35	60.4	11.88	72.0	14.89	83.6	18.27	89.6	20.06	95.6	21.96	107.2	24.92	117.5	26.02
	37	60.4	12.56	72.0	15.83	83.6	19.37	89.6	21.33	95.6	23.33	107.2	26.30	115.6	27.26
	39	60.4	13.28	72.0	16.73	83.6	20.73	89.6	22.93	95.6	25.08	107.2	27.78	113.7	28.76
	41	58.9	14.69	70.2	18.54	81.5	22.75	87.3	25.13	93.2	27.55	104.5	29.85	109.0	30.54
	43	57.4	16.17	68.4	20.24	79.4	24.83	85.1	27.39	90.9	30.11	101.9	31.93	104.5	32.69
46	53.8	17.99	64.1	22.79	74.5	27.98	79.8	30.49	85.1	33.98	93.2	35.52	95.4	35.68	
48	47.6	15.71	56.7	19.93	65.9	24.47	70.6	26.63	75.3	29.69	80.9	30.19	82.9	30.43	

# 7. Capacity Tables

Cooling Capacity (40HP)

Combination (%)	Outdoor air temp. (DB, °C)	Indoor air temp. (DB/WB, °C)													
		20		23		26		27		28		30		32	
		14	16	18	19	20	22	24	TC	PI	TC	PI	TC	PI	
70	10	52.8	6.73	63.2	8.00	73.2	9.27	78.4	10.01	83.6	10.70	93.6	12.19	104.0	13.63
	12	52.8	6.83	63.2	8.11	73.2	9.48	78.4	10.17	83.6	10.91	93.6	12.40	104.0	13.89
	14	52.8	6.94	63.2	8.21	73.2	9.64	78.4	10.33	83.6	11.07	93.6	12.66	104.0	14.14
	16	52.8	7.05	63.2	8.37	73.2	9.80	78.4	10.54	83.6	11.28	93.6	12.87	104.0	14.44
	18	52.8	7.15	63.2	8.53	73.2	10.01	78.4	10.76	83.6	11.50	93.6	13.09	104.0	14.70
	20	52.8	7.26	63.2	8.69	73.2	10.17	78.4	10.97	83.6	11.76	93.6	13.40	104.0	15.26
	21	52.8	7.36	63.2	8.74	73.2	10.28	78.4	11.07	83.6	11.87	93.6	13.62	104.0	15.58
	23	52.8	7.47	63.2	8.95	73.2	10.49	78.4	11.44	83.6	12.45	93.6	14.57	104.0	16.45
	25	52.8	7.58	63.2	9.27	73.2	11.18	78.4	12.24	83.6	13.30	93.6	15.58	104.0	17.25
	27	52.8	8.00	63.2	9.91	73.2	11.92	78.4	12.98	83.6	14.20	93.6	16.64	104.0	18.33
	29	52.8	8.53	63.2	10.49	73.2	12.66	78.4	13.83	83.6	15.10	93.6	17.75	104.0	19.64
	31	52.8	9.06	63.2	11.18	73.2	13.51	78.4	14.78	83.6	16.11	93.6	18.91	104.0	20.84
	33	52.8	9.59	63.2	11.81	73.2	14.36	78.4	15.68	83.6	17.11	93.6	20.13	104.0	22.19
	35	52.8	10.12	63.2	12.61	73.2	15.26	78.4	16.69	83.6	18.23	93.6	21.46	104.0	23.53
	37	52.8	10.76	63.2	13.36	73.2	16.21	78.4	17.75	83.6	19.39	93.6	22.83	104.0	24.83
	39	52.8	11.42	63.2	14.24	73.2	17.33	78.4	19.10	83.6	20.95	93.6	24.44	104.0	26.77
	41	51.4	12.63	61.6	15.60	71.3	19.01	76.4	20.94	81.5	22.77	91.2	26.84	101.3	28.87
	43	50.2	13.74	60.1	17.00	69.6	20.75	74.5	22.84	79.4	24.87	88.9	29.32	98.8	31.22
46	47.0	15.27	56.3	19.12	65.2	23.36	69.8	25.44	74.5	28.03	83.4	33.07	92.6	34.80	
48	41.6	13.33	49.8	16.70	57.7	20.43	61.8	22.23	65.9	24.52	73.7	28.94	81.9	30.01	
60	10	45.2	5.85	54.0	6.86	62.8	7.98	67.2	8.56	71.6	9.09	80.4	10.32	89.2	11.54
	12	45.2	5.96	54.0	6.97	62.8	8.08	67.2	8.67	71.6	9.25	80.4	10.47	89.2	11.75
	14	45.2	6.01	54.0	7.07	62.8	8.24	67.2	8.83	71.6	9.41	80.4	10.69	89.2	11.96
	16	45.2	6.11	54.0	7.23	62.8	8.35	67.2	8.99	71.6	9.62	80.4	10.90	89.2	12.18
	18	45.2	6.22	54.0	7.34	62.8	8.51	67.2	9.15	71.6	9.78	80.4	11.06	89.2	12.44
	20	45.2	6.33	54.0	7.44	62.8	8.67	67.2	9.30	71.6	9.94	80.4	11.27	89.2	12.71
	21	45.2	6.38	54.0	7.50	62.8	8.77	67.2	9.41	71.6	10.05	80.4	11.43	89.2	12.81
	23	45.2	6.49	54.0	7.66	62.8	8.88	67.2	9.57	71.6	10.26	80.4	11.86	89.2	13.61
	25	45.2	6.59	54.0	7.82	62.8	9.25	67.2	10.05	71.6	10.90	80.4	12.65	89.2	14.57
	27	45.2	6.81	54.0	8.24	62.8	9.84	67.2	10.69	71.6	11.59	80.4	13.45	89.2	15.53
	29	45.2	7.23	54.0	8.77	62.8	10.47	67.2	11.38	71.6	12.34	80.4	14.36	89.2	16.59
	31	45.2	7.66	54.0	9.30	62.8	11.11	67.2	12.12	71.6	13.13	80.4	15.31	89.2	17.65
	33	45.2	8.08	54.0	9.84	62.8	11.80	67.2	12.87	71.6	13.98	80.4	16.27	89.2	18.82
	35	45.2	8.56	54.0	10.47	62.8	12.55	67.2	13.66	71.6	14.83	80.4	17.33	89.2	19.99
	37	45.2	9.04	54.0	11.05	62.8	13.29	67.2	14.52	71.6	15.74	80.4	18.40	89.2	21.27
	39	45.2	9.61	54.0	11.77	62.8	14.35	67.2	15.57	71.6	16.94	80.4	19.73	89.2	22.79
	41	44.0	10.43	52.6	12.88	61.2	15.58	65.5	17.01	69.8	18.38	78.3	21.65	86.9	24.77
	43	43.0	11.33	51.3	14.02	59.7	16.99	63.9	18.54	68.0	20.05	76.4	23.63	84.8	27.05
46	40.3	12.69	48.1	15.75	55.9	19.10	59.8	20.84	63.8	22.56	71.6	26.63	79.4	30.82	
48	35.6	11.06	42.5	13.74	49.5	16.69	52.9	18.20	56.4	19.71	63.3	23.29	70.3	26.97	
50	10	37.8	5.07	45.2	5.87	52.4	6.67	56.0	7.15	59.6	7.58	66.8	8.54	74.4	9.50
	12	37.8	5.12	45.2	5.92	52.4	6.78	56.0	7.26	59.6	7.74	66.8	8.70	74.4	9.66
	14	37.8	5.18	45.2	6.03	52.4	6.88	56.0	7.36	59.6	7.84	66.8	8.80	74.4	9.82
	16	37.8	5.28	45.2	6.14	52.4	6.99	56.0	7.52	59.6	7.95	66.8	8.96	74.4	9.98
	18	37.8	5.34	45.2	6.19	52.4	7.10	56.0	7.63	59.6	8.11	66.8	9.12	74.4	10.19
	20	37.8	5.39	45.2	6.30	52.4	7.26	56.0	7.74	59.6	8.27	66.8	9.28	74.4	10.41
	21	37.8	5.44	45.2	6.35	52.4	7.31	56.0	7.84	59.6	8.32	66.8	9.39	74.4	10.51
	23	37.8	5.55	45.2	6.46	52.4	7.42	56.0	7.95	59.6	8.48	66.8	9.55	74.4	10.73
	25	37.8	5.60	45.2	6.56	52.4	7.58	56.0	8.11	59.6	8.75	66.8	10.03	74.4	11.47
	27	37.8	5.71	45.2	6.78	52.4	8.00	56.0	8.64	59.6	9.28	66.8	10.73	74.4	12.22
	29	37.8	6.03	45.2	7.20	52.4	8.48	56.0	9.18	59.6	9.87	66.8	11.37	74.4	12.97
	31	37.8	6.35	45.2	7.63	52.4	9.02	56.0	9.71	59.6	10.51	66.8	12.11	74.4	13.82
	33	37.8	6.72	45.2	8.06	52.4	9.55	56.0	10.30	59.6	11.15	66.8	12.86	74.4	14.73
	35	37.8	7.10	45.2	8.54	52.4	10.09	56.0	10.94	59.6	11.79	66.8	13.61	74.4	15.63
	37	37.8	7.52	45.2	9.02	52.4	10.67	56.0	11.58	59.6	12.49	66.8	14.51	74.4	16.60
	39	37.8	8.03	45.2	9.67	52.4	11.43	56.0	12.46	59.6	13.40	66.8	15.46	74.4	17.92
	41	36.8	8.68	44.0	10.46	51.1	12.50	54.6	13.50	58.1	14.52	65.1	16.95	72.5	19.46
	43	35.9	9.43	43.0	11.38	49.8	13.60	53.2	14.70	56.6	15.80	63.5	18.48	70.7	21.23
46	33.7	10.56	40.3	12.77	46.7	15.26	49.9	16.51	53.1	17.74	59.5	20.79	66.3	23.91	
48	29.8	9.21	35.6	11.13	41.3	13.31	44.1	14.41	47.0	15.48	52.6	18.17	58.6	20.90	

**Note**

1. TC: Total Capacity(kW), PI : Power Input(kW, Comp. + Outdoor fan motor)
2. Capacity tables show the average value of conditions which may occur.

# 7. Capacity Tables

◆ ARUM420LTE5

Cooling Capacity (42HP)

Combination (%)	Outdoor air temp. (DB, °C)	Indoor air temp. (DB/WB, °C)													
		20		23		26		27		28		30		32	
		14	16	16	18	18	19	20	20	22	22	24	24		
		TC	PI	TC	PI	TC	PI	TC	PI	TC	PI	TC	PI	TC	PI
130	10	116.5	12.06	138.7	14.75	148.7	17.10	152.9	17.45	157.2	17.59	164.8	17.73	169.0	17.80
	12	116.5	12.36	138.7	15.27	148.7	17.81	152.9	17.92	157.2	18.07	164.8	18.21	169.0	18.37
	14	116.5	12.78	138.7	15.83	148.7	18.48	152.9	18.61	157.2	18.76	164.8	18.91	169.0	19.08
	16	116.5	13.24	138.7	16.38	148.7	19.31	152.9	19.48	157.2	19.64	164.8	19.82	169.0	19.97
	18	116.5	13.80	138.7	17.32	148.7	20.19	152.9	20.63	157.2	20.79	164.8	21.00	169.0	21.14
	20	116.5	14.41	138.7	18.46	148.7	21.19	152.9	22.69	157.2	22.87	162.4	23.10	166.6	23.26
	21	116.5	14.79	138.7	19.10	148.7	21.63	152.9	24.01	157.2	24.20	161.5	24.44	165.7	24.61
	23	116.5	15.87	138.7	20.10	148.7	22.76	152.9	26.49	155.2	26.71	159.1	26.97	163.3	27.16
	25	116.5	16.95	138.7	21.25	148.7	24.32	151.1	29.38	152.9	29.62	157.2	29.91	161.5	30.12
	27	116.5	18.13	138.7	22.72	146.8	25.91	148.7	32.35	151.1	32.61	155.2	32.93	159.1	33.16
	29	116.5	19.32	138.7	24.29	144.4	27.88	146.5	35.55	148.7	35.76	152.9	36.08	157.2	36.23
	31	116.5	20.61	138.3	25.58	142.0	29.65	144.4	35.40	146.5	35.61	150.5	35.93	154.8	36.07
	33	116.5	21.96	135.9	27.11	140.1	31.80	142.4	35.08	144.4	35.29	148.7	35.60	152.4	35.74
	35	116.5	23.42	133.5	28.39	137.8	34.45	140.1	34.62	142.4	34.83	146.3	35.14	150.5	35.28
	37	116.5	24.98	131.6	29.79	135.9	33.99	137.8	34.16	140.1	34.37	144.0	34.68	148.2	34.81
	39	116.5	26.59	129.3	31.36	133.5	33.54	135.9	33.71	137.8	33.91	142.0	34.21	146.3	34.35
41	113.5	28.21	123.9	32.93	128.1	33.08	130.0	33.25	132.5	33.45	136.6	33.75	140.2	33.88	
43	110.7	29.76	118.7	32.46	122.9	32.63	124.7	32.79	127.2	32.99	131.1	33.28	134.7	33.41	
46	103.7	31.85	108.3	31.78	112.2	31.95	114.0	32.11	116.4	32.30	120.0	32.59	123.4	32.72	
48	91.8	30.96	94.1	31.05	97.6	31.12	99.1	31.21	101.3	31.47	104.5	31.67	107.4	31.80	
120	10	105.4	10.85	125.3	13.31	137.0	15.81	141.1	17.09	145.3	17.36	153.2	17.43	156.9	17.57
	12	105.4	11.15	125.3	13.76	137.0	16.45	141.1	17.45	145.3	18.00	153.2	18.22	156.9	18.37
	14	105.4	11.53	125.3	14.23	137.0	17.11	141.1	18.11	145.3	18.66	153.2	18.94	156.9	19.09
	16	105.4	11.95	125.3	14.81	137.0	17.78	141.1	18.79	145.3	19.53	153.2	19.77	156.9	19.92
	18	105.4	12.41	125.3	15.47	137.0	18.49	141.1	19.78	145.3	20.53	153.2	20.76	156.9	20.93
	20	105.4	12.89	125.3	16.41	137.0	19.48	141.1	20.82	145.3	21.61	153.2	21.90	156.9	22.07
	21	105.4	13.28	125.3	17.00	137.0	20.03	141.1	21.43	145.3	22.33	153.2	22.61	156.9	22.79
	23	105.4	14.19	125.3	18.19	137.0	21.46	141.1	22.77	145.3	23.80	153.2	24.04	156.9	24.24
	25	105.4	15.16	125.3	19.48	137.0	22.63	141.1	24.27	145.3	25.52	151.4	25.74	155.0	25.94
	27	105.4	16.19	125.3	20.83	137.0	24.09	141.1	25.93	145.3	27.43	149.0	27.62	152.8	27.84
	29	105.4	17.27	125.3	22.23	137.0	25.35	141.1	27.75	143.0	29.23	146.7	29.67	150.9	29.91
	31	105.4	18.40	125.3	23.74	137.0	26.66	139.3	29.73	141.1	31.36	144.9	31.92	148.5	32.17
	33	105.4	19.59	125.3	25.31	135.1	28.20	137.0	32.27	138.8	33.67	142.5	34.05	146.2	34.33
	35	105.4	20.83	125.3	26.98	132.8	29.85	134.6	35.55	137.0	35.73	140.7	35.83	144.4	36.12
	37	105.4	22.41	125.3	28.47	130.9	31.82	132.8	34.80	134.6	34.98	138.3	35.08	142.1	35.36
	39	105.4	24.12	124.9	30.09	128.6	33.75	130.4	34.09	132.3	34.26	136.5	34.36	140.2	34.63
41	102.7	25.84	119.4	31.71	123.5	33.09	125.2	33.37	127.0	33.54	130.7	33.64	134.4	33.91	
43	100.2	27.58	114.4	31.26	118.4	32.34	120.1	32.66	121.9	32.82	125.5	32.92	129.1	33.18	
46	93.9	29.65	104.3	30.51	108.1	31.33	109.7	31.59	111.4	31.74	114.7	31.84	118.1	32.09	
48	83.0	29.05	90.6	29.97	94.0	30.72	95.4	30.90	96.9	31.00	99.8	31.13	102.8	31.25	
110	10	94.4	9.76	112.6	11.90	125.7	14.13	129.3	15.30	137.5	16.46	140.7	16.92	150.2	17.20
	12	94.4	10.07	112.6	12.30	125.7	14.72	129.3	15.73	137.5	17.08	140.7	17.63	150.2	18.04
	14	94.4	10.38	112.6	12.85	125.7	15.39	129.3	16.51	137.5	17.94	140.7	18.45	150.2	18.84
	16	94.4	10.75	112.6	13.32	125.7	16.02	129.3	17.23	137.5	18.77	140.7	19.28	150.2	19.62
	18	94.4	11.15	112.6	13.88	125.7	16.95	129.3	18.14	137.5	19.80	140.7	20.19	150.2	20.57
	20	94.4	11.55	112.6	14.57	125.7	17.97	129.3	18.98	137.5	20.76	140.7	21.27	150.2	21.61
	21	94.4	11.80	112.6	15.00	125.7	18.43	129.3	19.49	137.5	21.34	140.7	21.88	150.2	22.22
	23	94.4	12.57	112.6	16.08	125.7	19.46	129.3	20.57	137.5	22.54	140.7	23.03	150.2	23.41
	25	94.4	13.44	112.6	17.16	125.7	20.56	129.3	21.75	137.5	23.82	140.7	24.16	148.4	24.65
	27	94.4	14.35	112.6	18.35	125.7	21.73	129.3	23.02	137.5	24.88	140.7	25.45	146.2	25.88
	29	94.4	15.33	112.6	19.59	125.7	22.96	129.3	24.38	137.5	26.29	140.7	26.74	144.4	27.15
	31	94.4	16.30	112.6	20.88	125.7	24.26	129.3	25.83	135.3	27.62	138.9	28.16	142.1	28.46
	33	94.4	17.38	112.6	22.23	125.7	25.63	129.3	27.37	133.4	29.17	136.6	29.65	140.2	29.82
	35	94.4	18.46	112.6	23.74	125.7	27.07	129.3	29.00	131.2	30.79	134.4	31.07	138.0	31.22
	37	94.4	19.56	112.6	25.20	125.7	28.58	127.5	30.73	128.9	32.47	132.6	32.58	135.7	32.67
	39	94.4	21.09	112.6	26.78	123.5	30.15	125.3	32.87	127.1	34.08	130.3	34.14	133.9	34.17
41	92.0	22.62	109.7	28.36	118.2	31.80	120.0	35.55	121.6	35.55	125.1	35.83	128.2	36.12	
43	89.7	23.75	107.0	29.54	113.2	33.72	115.1	34.10	116.6	34.03	120.1	34.22	123.1	34.31	
46	84.1	23.18	100.2	28.52	103.3	32.00	105.1	32.00	106.5	32.28	109.8	32.46	112.6	32.54	
48	74.4	22.51	87.1	27.48	89.8	30.45	91.4	30.65	92.6	30.80	95.5	30.89	98.0	31.01	



# 7. Capacity Tables

Cooling Capacity (42HP)

Combination (%)	Outdoor air temp. (DB, °C)	Indoor air temp. (DB/WB, °C)													
		20		23		26		27		28		30		32	
		14		16		18		19		20		22		24	
		TC	PI	TC	PI	TC	PI	TC	PI	TC	PI	TC	PI	TC	PI
100	10	79.4	8.79	94.5	10.69	110.0	12.68	117.6	13.70	125.2	14.72	138.8	16.38	141.8	16.51
	12	79.4	9.07	94.5	11.12	110.0	13.10	117.6	14.07	125.2	15.19	138.8	17.26	141.8	17.43
	14	79.4	9.36	94.5	11.56	110.0	13.66	117.6	14.67	125.2	15.84	138.8	18.23	141.8	18.40
	16	79.4	9.64	94.5	11.95	110.0	14.24	117.6	15.37	125.2	16.69	138.8	19.11	141.8	19.38
	18	79.4	9.93	94.5	12.39	110.0	14.79	117.6	16.12	125.2	17.70	138.8	20.19	141.8	20.35
	20	79.4	10.28	94.5	12.86	110.0	15.65	117.6	17.27	125.2	18.94	138.8	21.16	141.8	21.33
	21	79.4	10.49	94.5	13.17	110.0	16.19	117.6	17.86	125.2	19.64	138.8	21.64	141.8	21.81
	23	79.4	11.12	94.5	14.09	110.0	17.38	117.6	19.16	125.2	21.05	138.8	22.66	141.8	22.84
	25	79.4	11.82	94.5	15.00	110.0	18.56	117.6	20.51	125.2	22.50	138.8	23.63	140.6	23.82
	27	79.4	12.63	94.5	16.03	110.0	19.86	117.6	21.91	125.2	23.93	136.1	24.74	138.9	24.94
	29	79.4	13.44	94.5	17.11	110.0	21.21	117.6	23.42	125.2	25.32	133.5	25.73	136.8	25.94
	31	79.4	14.35	94.5	18.24	110.0	22.61	117.6	24.99	125.2	26.61	131.5	26.73	134.7	26.94
	33	79.4	15.22	94.5	19.43	110.0	24.12	117.6	26.66	125.2	27.61	129.4	27.73	132.6	27.95
	35	79.4	16.19	94.5	20.67	110.0	25.69	117.6	28.44	123.2	28.61	127.1	28.72	130.3	28.95
	37	79.4	17.34	94.5	22.17	110.0	27.21	117.6	29.79	121.2	29.94	124.7	30.06	127.7	30.34
	39	79.4	18.59	94.5	23.81	110.0	28.83	117.6	31.25	119.2	31.39	122.7	31.51	125.6	31.80
	41	78.1	19.84	93.0	25.46	108.3	30.46	112.8	32.71	115.3	32.84	118.0	32.95	121.9	33.26
43	75.4	21.00	89.8	26.99	104.6	31.91	108.2	33.96	109.4	34.08	112.8	34.19	115.8	34.51	
46	70.7	22.58	84.2	29.10	98.0	33.85	98.8	35.55	99.9	35.65	103.1	35.76	105.8	36.10	
48	62.5	19.50	74.4	25.17	84.6	28.94	85.8	30.16	86.7	30.26	89.6	30.33	92.0	30.57	
90	10	71.4	8.18	85.3	9.84	99.1	11.60	105.8	12.50	112.6	13.45	126.4	15.06	140.3	16.51
	12	71.4	8.28	85.3	9.99	99.1	11.80	105.8	12.75	112.6	13.76	126.4	15.36	140.3	17.04
	14	71.4	8.43	85.3	10.19	99.1	12.05	105.8	13.00	112.6	14.01	126.4	15.66	140.3	17.39
	16	71.4	8.58	85.3	10.39	99.1	12.30	105.8	13.25	112.6	14.26	126.4	15.95	140.3	17.69
	18	71.4	8.74	85.3	10.59	99.1	12.50	105.8	13.56	112.6	14.56	126.4	16.30	140.3	18.58
	20	71.4	8.89	85.3	10.79	99.1	12.75	105.8	13.81	112.6	15.11	126.4	17.45	140.3	19.47
	21	71.4	8.99	85.3	10.89	99.1	13.00	105.8	14.26	112.6	15.66	126.4	17.73	140.3	19.91
	23	71.4	9.19	85.3	11.35	99.1	13.91	105.8	15.31	112.6	16.77	126.4	18.80	138.4	20.85
	25	71.4	9.64	85.3	12.10	99.1	14.86	105.8	16.37	112.6	17.92	126.4	20.10	136.4	21.74
	27	71.4	10.29	85.3	12.90	99.1	15.86	105.8	17.47	112.6	19.18	126.4	21.38	134.4	22.76
	29	71.4	10.89	85.3	13.76	99.1	16.97	105.8	18.68	112.6	20.48	126.4	22.64	132.4	23.68
	31	71.4	11.60	85.3	14.66	99.1	18.07	105.8	19.88	112.6	21.84	126.4	23.77	130.4	24.59
	33	71.4	12.35	85.3	15.61	99.1	19.28	105.8	21.19	112.6	23.16	126.4	24.92	128.4	25.51
	35	71.4	13.10	85.3	16.57	99.1	20.48	105.8	22.59	112.6	24.56	124.2	26.35	126.4	26.95
	37	71.4	13.91	85.3	17.62	99.1	21.84	105.8	24.00	112.6	25.93	122.2	27.54	124.4	28.16
	39	71.4	14.72	85.3	18.74	99.1	23.12	105.8	25.54	112.6	27.26	120.2	29.04	122.4	29.39
	41	69.6	16.48	83.1	20.78	96.6	25.37	103.1	27.93	109.7	29.44	115.2	30.60	117.3	31.31
43	67.9	17.78	81.0	22.45	94.2	27.71	100.6	30.08	107.0	31.56	110.5	32.74	112.5	33.17	
46	63.6	20.02	75.9	25.57	88.3	31.58	94.3	34.10	97.2	35.07	100.9	35.69	102.7	35.85	
48	56.3	17.49	67.2	22.37	78.1	27.63	83.4	29.74	84.4	30.06	87.6	30.33	89.3	30.57	
80	10	63.4	7.64	75.6	9.18	87.8	10.77	94.1	11.62	100.4	12.46	112.6	14.21	124.7	15.43
	12	63.4	7.80	75.6	9.28	87.8	10.98	94.1	11.83	100.4	12.68	112.6	14.48	124.7	15.74
	14	63.4	7.90	75.6	9.49	87.8	11.14	94.1	12.04	100.4	12.89	112.6	14.74	124.7	16.04
	16	63.4	8.01	75.6	9.65	87.8	11.35	94.1	12.25	100.4	13.15	112.6	15.06	124.7	16.35
	18	63.4	8.17	75.6	9.81	87.8	11.56	94.1	12.46	100.4	13.42	112.6	15.33	124.7	16.71
	20	63.4	8.33	75.6	10.02	87.8	11.83	94.1	12.73	100.4	13.68	112.6	15.91	124.7	17.70
	21	63.4	8.38	75.6	10.13	87.8	11.93	94.1	12.89	100.4	14.00	112.6	16.41	124.7	18.17
	23	63.4	8.54	75.6	10.29	87.8	12.46	94.1	13.68	100.4	14.96	112.6	17.33	124.7	19.07
	25	63.4	8.86	75.6	10.98	87.8	13.37	94.1	14.64	100.4	16.02	112.6	18.55	124.7	20.39
	27	63.4	9.39	75.6	11.67	87.8	14.27	94.1	15.65	100.4	17.08	112.6	19.71	124.7	21.45
	29	63.4	9.97	75.6	12.46	87.8	15.17	94.1	16.65	100.4	18.24	112.6	21.11	124.7	22.49
	31	63.4	10.61	75.6	13.21	87.8	16.18	94.1	17.77	100.4	19.41	112.6	22.41	124.7	23.61
	33	63.4	11.24	75.6	14.11	87.8	17.24	94.1	18.93	100.4	20.68	112.6	23.61	124.7	24.74
	35	63.4	11.93	75.6	14.96	87.8	18.35	94.1	20.15	100.4	22.06	112.6	25.03	123.4	26.15
	37	63.4	12.62	75.6	15.90	87.8	19.46	94.1	21.43	100.4	23.44	112.6	26.42	121.4	27.39
	39	63.4	13.34	75.6	16.81	87.8	20.82	94.1	23.04	100.4	25.19	112.6	27.91	119.4	28.89
	41	61.8	14.76	73.7	18.63	85.5	22.85	91.7	25.25	97.8	27.68	109.7	29.99	114.4	30.68
43	60.3	16.25	71.8	20.33	83.4	24.94	89.4	27.52	95.4	30.25	107.0	32.08	109.7	32.84	
46	56.5	18.07	67.3	22.90	78.2	28.11	83.8	30.63	89.4	34.14	97.8	35.69	100.1	35.85	
48	50.0	15.78	59.6	20.02	69.2	24.58	74.1	26.75	79.1	29.83	85.0	30.33	87.0	30.57	

# 7. Capacity Tables

Cooling Capacity (42HP)

Combination (%)	Outdoor air temp. (DB, °C)	Indoor air temp. (DB/WB, °C)													
		20		23		26		27		28		30		32	
		14	16	18	19	20	22	24	TC	PI	TC	PI	TC	PI	
70	10	55.4	6.76	66.4	8.04	76.9	9.32	82.3	10.06	87.8	10.75	98.3	12.24	109.2	13.69
	12	55.4	6.87	66.4	8.14	76.9	9.53	82.3	10.22	87.8	10.97	98.3	12.46	109.2	13.95
	14	55.4	6.97	66.4	8.25	76.9	9.69	82.3	10.38	87.8	11.12	98.3	12.72	109.2	14.21
	16	55.4	7.08	66.4	8.41	76.9	9.85	82.3	10.59	87.8	11.34	98.3	12.93	109.2	14.51
	18	55.4	7.19	66.4	8.57	76.9	10.06	82.3	10.81	87.8	11.55	98.3	13.15	109.2	14.77
	20	55.4	7.29	66.4	8.73	76.9	10.22	82.3	11.02	87.8	11.82	98.3	13.47	109.2	15.33
	21	55.4	7.40	66.4	8.78	76.9	10.33	82.3	11.12	87.8	11.92	98.3	13.68	109.2	15.66
	23	55.4	7.51	66.4	9.00	76.9	10.54	82.3	11.50	87.8	12.51	98.3	14.64	109.2	16.53
	25	55.4	7.61	66.4	9.32	76.9	11.23	82.3	12.30	87.8	13.36	98.3	15.65	109.2	17.33
	27	55.4	8.04	66.4	9.95	76.9	11.98	82.3	13.04	87.8	14.27	98.3	16.71	109.2	18.42
	29	55.4	8.57	66.4	10.54	76.9	12.72	82.3	13.89	87.8	15.17	98.3	17.83	109.2	19.73
	31	55.4	9.10	66.4	11.23	76.9	13.57	82.3	14.85	87.8	16.18	98.3	19.00	109.2	20.94
	33	55.4	9.63	66.4	11.87	76.9	14.43	82.3	15.76	87.8	17.19	98.3	20.23	109.2	22.29
	35	55.4	10.17	66.4	12.67	76.9	15.33	82.3	16.77	87.8	18.31	98.3	21.56	109.2	23.64
	37	55.4	10.81	66.4	13.42	76.9	16.29	82.3	17.83	87.8	19.48	98.3	22.94	109.2	24.94
	39	55.4	11.47	66.4	14.31	76.9	17.42	82.3	19.18	87.8	21.04	98.3	24.55	109.2	26.89
	41	54.0	12.69	64.7	15.67	74.9	19.10	80.2	21.04	85.5	22.88	95.8	26.97	106.4	29.01
43	52.7	13.81	63.1	17.08	73.0	20.84	78.2	22.95	83.4	24.98	93.4	29.46	103.8	31.37	
46	49.4	15.35	59.1	19.21	68.5	23.47	73.3	25.56	78.2	28.16	87.5	33.23	97.3	34.96	
48	43.7	13.39	52.3	16.78	60.6	20.52	64.9	22.34	69.2	24.64	77.4	29.08	86.0	30.15	
60	10	47.5	5.88	56.7	6.89	65.9	8.01	70.6	8.60	75.2	9.13	84.4	10.36	93.7	11.59
	12	47.5	5.98	56.7	7.00	65.9	8.12	70.6	8.71	75.2	9.30	84.4	10.52	93.7	11.81
	14	47.5	6.04	56.7	7.10	65.9	8.28	70.6	8.87	75.2	9.46	84.4	10.74	93.7	12.02
	16	47.5	6.14	56.7	7.27	65.9	8.39	70.6	9.03	75.2	9.67	84.4	10.95	93.7	12.23
	18	47.5	6.25	56.7	7.37	65.9	8.55	70.6	9.19	75.2	9.83	84.4	11.11	93.7	12.50
	20	47.5	6.36	56.7	7.48	65.9	8.71	70.6	9.35	75.2	9.99	84.4	11.33	93.7	12.77
	21	47.5	6.41	56.7	7.53	65.9	8.81	70.6	9.46	75.2	10.10	84.4	11.49	93.7	12.87
	23	47.5	6.52	56.7	7.69	65.9	8.92	70.6	9.62	75.2	10.31	84.4	11.91	93.7	13.68
	25	47.5	6.62	56.7	7.85	65.9	9.30	70.6	10.10	75.2	10.95	84.4	12.71	93.7	14.64
	27	47.5	6.84	56.7	8.28	65.9	9.88	70.6	10.74	75.2	11.65	84.4	13.52	93.7	15.60
	29	47.5	7.27	56.7	8.81	65.9	10.52	70.6	11.43	75.2	12.39	84.4	14.42	93.7	16.67
	31	47.5	7.69	56.7	9.35	65.9	11.16	70.6	12.18	75.2	13.19	84.4	15.39	93.7	17.74
	33	47.5	8.12	56.7	9.88	65.9	11.86	70.6	12.93	75.2	14.05	84.4	16.35	93.7	18.91
	35	47.5	8.60	56.7	10.52	65.9	12.61	70.6	13.73	75.2	14.90	84.4	17.42	93.7	20.09
	37	47.5	9.08	56.7	11.11	65.9	13.36	70.6	14.58	75.2	15.81	84.4	18.48	93.7	21.37
	39	47.5	9.66	56.7	11.83	65.9	14.42	70.6	15.65	75.2	17.02	84.4	19.82	93.7	22.90
	41	46.2	10.48	55.2	12.94	64.3	15.65	68.8	17.09	73.3	18.47	82.3	21.75	91.3	24.88
43	45.1	11.38	53.9	14.09	62.7	17.07	67.1	18.63	71.4	20.14	80.2	23.74	89.0	27.18	
46	42.3	12.75	50.5	15.82	58.7	19.19	62.8	20.94	67.0	22.67	75.2	26.75	83.4	30.97	
48	37.4	11.11	44.7	13.81	51.9	16.77	55.6	18.29	59.2	19.81	66.5	23.40	73.8	27.09	
50	10	39.7	5.09	47.5	5.90	55.0	6.70	58.8	7.18	62.6	7.61	70.1	8.58	78.1	9.54
	12	39.7	5.15	47.5	5.95	55.0	6.81	58.8	7.29	62.6	7.77	70.1	8.74	78.1	9.70
	14	39.7	5.20	47.5	6.06	55.0	6.92	58.8	7.40	62.6	7.88	70.1	8.85	78.1	9.86
	16	39.7	5.31	47.5	6.17	55.0	7.02	58.8	7.56	62.6	7.99	70.1	9.01	78.1	10.03
	18	39.7	5.36	47.5	6.22	55.0	7.13	58.8	7.67	62.6	8.15	70.1	9.17	78.1	10.24
	20	39.7	5.41	47.5	6.33	55.0	7.29	58.8	7.77	62.6	8.31	70.1	9.33	78.1	10.45
	21	39.7	5.47	47.5	6.38	55.0	7.34	58.8	7.88	62.6	8.36	70.1	9.44	78.1	10.56
	23	39.7	5.58	47.5	6.49	55.0	7.45	58.8	7.99	62.6	8.52	70.1	9.60	78.1	10.78
	25	39.7	5.63	47.5	6.59	55.0	7.61	58.8	8.15	62.6	8.79	70.1	10.08	78.1	11.53
	27	39.7	5.74	47.5	6.81	55.0	8.04	58.8	8.69	62.6	9.33	70.1	10.78	78.1	12.28
	29	39.7	6.06	47.5	7.24	55.0	8.52	58.8	9.22	62.6	9.92	70.1	11.42	78.1	13.03
	31	39.7	6.38	47.5	7.67	55.0	9.06	58.8	9.76	62.6	10.56	70.1	12.17	78.1	13.89
	33	39.7	6.76	47.5	8.10	55.0	9.60	58.8	10.35	62.6	11.20	70.1	12.92	78.1	14.80
	35	39.7	7.13	47.5	8.58	55.0	10.13	58.8	10.99	62.6	11.85	70.1	13.67	78.1	15.71
	37	39.7	7.56	47.5	9.06	55.0	10.72	58.8	11.63	62.6	12.55	70.1	14.58	78.1	16.67
	39	39.7	8.06	47.5	9.71	55.0	11.49	58.8	12.52	62.6	13.46	70.1	15.53	78.1	18.01
	41	38.7	8.72	46.2	10.51	53.6	12.56	57.3	13.56	61.0	14.58	68.3	17.03	76.1	19.56
43	37.7	9.48	45.1	11.44	52.3	13.67	55.9	14.77	59.5	15.88	66.7	18.57	74.2	21.33	
46	35.3	10.61	42.3	12.83	49.0	15.33	52.4	16.58	55.7	17.83	62.5	20.89	69.6	24.02	
48	31.3	9.25	37.4	11.19	43.3	13.37	46.3	14.48	49.3	15.56	55.3	18.25	61.5	20.99	

**Note**

1. TC: Total Capacity(kW), PI : Power Input(kW, Comp. + Outdoor fan motor)
2. Capacity tables show the average value of conditions which may occur.

# 7. Capacity Tables

◆ ARUM440LTE5

Cooling Capacity (44HP)

Combination (%)	Outdoor air temp. (DB, °C)	Indoor air temp. (DB/WB, °C)													
		20		23		26		27		28		30		32	
		14	16	18	19	20	22	24	TC	PI	TC	PI	TC	PI	
130	10	122.0	12.80	145.3	15.64	155.8	18.15	160.2	18.51	164.7	18.66	172.6	18.81	177.1	18.88
	12	122.0	13.11	145.3	16.20	155.8	18.89	160.2	19.01	164.7	19.17	172.6	19.32	177.1	19.49
	14	122.0	13.55	145.3	16.79	155.8	19.60	160.2	19.74	164.7	19.90	172.6	20.06	177.1	20.24
	16	122.0	14.05	145.3	17.37	155.8	20.48	160.2	20.67	164.7	20.84	172.6	21.02	177.1	21.19
	18	122.0	14.64	145.3	18.38	155.8	21.42	160.2	21.88	164.7	22.06	172.6	22.28	177.1	22.43
	20	122.0	15.29	145.3	19.58	155.8	22.48	160.2	24.07	164.7	24.26	170.1	24.50	174.6	24.67
	21	122.0	15.69	145.3	20.27	155.8	22.95	160.2	25.47	164.7	25.68	169.2	25.93	173.6	26.11
	23	122.0	16.83	145.3	21.32	155.8	24.14	160.2	28.11	162.6	28.33	166.7	28.61	171.1	28.81
	25	122.0	17.98	145.3	22.55	155.8	25.80	158.3	31.17	160.2	31.42	164.7	31.73	169.2	31.95
	27	122.0	19.24	145.3	24.10	153.8	27.48	155.8	34.31	158.3	34.59	162.6	34.93	166.7	35.17
	29	122.0	20.49	145.3	25.77	151.3	29.57	153.5	37.71	155.8	37.94	160.2	38.28	164.7	38.43
	31	122.0	21.87	144.8	27.14	148.8	31.46	151.3	37.56	153.5	37.78	157.7	38.12	162.2	38.27
	33	122.0	23.30	142.3	28.76	146.8	33.74	149.2	37.21	151.3	37.43	155.8	37.77	159.7	37.92
	35	122.0	24.85	139.8	30.12	144.3	36.54	146.8	36.73	149.2	36.95	153.2	37.28	157.7	37.42
	37	122.0	26.49	137.9	31.60	142.3	36.06	144.3	36.24	146.8	36.46	150.8	36.79	155.3	36.93
	39	122.0	28.21	135.4	33.27	139.8	35.58	142.3	35.76	144.3	35.97	148.8	36.29	153.2	36.44
41	118.9	29.93	129.8	34.93	134.2	35.09	136.2	35.27	138.9	35.48	143.1	35.80	146.9	35.94	
43	116.0	31.57	124.4	34.44	128.7	34.61	130.7	34.79	133.3	34.99	137.4	35.31	141.1	35.45	
46	108.7	33.79	113.5	33.72	117.6	33.89	119.4	34.06	121.9	34.26	125.8	34.57	129.2	34.71	
48	96.1	32.85	98.6	32.94	102.2	33.01	103.9	33.10	106.1	33.39	109.5	33.60	112.5	33.73	
120	10	110.4	11.51	131.3	14.12	143.5	16.77	147.8	18.13	152.2	18.42	160.5	18.49	164.4	18.64
	12	110.4	11.82	131.3	14.59	143.5	17.45	147.8	18.51	152.2	19.10	160.5	19.33	164.4	19.48
	14	110.4	12.23	131.3	15.09	143.5	18.16	147.8	19.22	152.2	19.80	160.5	20.09	164.4	20.25
	16	110.4	12.67	131.3	15.71	143.5	18.86	147.8	19.93	152.2	20.71	160.5	20.97	164.4	21.14
	18	110.4	13.17	131.3	16.41	143.5	19.61	147.8	20.98	152.2	21.78	160.5	22.02	164.4	22.20
	20	110.4	13.67	131.3	17.40	143.5	20.67	147.8	22.08	152.2	22.93	160.5	23.23	164.4	23.42
	21	110.4	14.08	131.3	18.03	143.5	21.25	147.8	22.73	152.2	23.68	160.5	23.99	164.4	24.18
	23	110.4	15.06	131.3	19.29	143.5	22.77	147.8	24.15	152.2	25.25	160.5	25.51	164.4	25.71
	25	110.4	16.09	131.3	20.67	143.5	24.01	147.8	25.75	152.2	27.08	158.6	27.30	162.4	27.52
	27	110.4	17.17	131.3	22.10	143.5	25.55	147.8	27.51	152.2	29.10	156.1	29.30	160.0	29.53
	29	110.4	18.32	131.3	23.59	143.5	26.89	147.8	29.44	149.8	31.01	153.7	31.48	158.1	31.73
	31	110.4	19.52	131.3	25.19	143.5	28.28	145.9	31.54	147.8	33.27	151.8	33.86	155.6	34.13
	33	110.4	20.78	131.3	26.85	141.6	29.91	143.5	34.23	145.4	35.72	149.3	36.13	153.2	36.41
	35	110.4	22.10	131.3	28.62	139.1	31.66	141.0	37.71	143.5	37.90	147.4	38.01	151.2	38.32
	37	110.4	23.77	131.3	30.20	137.1	33.76	139.1	36.92	141.0	37.10	144.9	37.22	148.8	37.51
	39	110.4	25.59	130.8	31.92	134.7	35.80	136.7	36.16	138.6	36.34	143.0	36.45	146.9	36.74
41	107.6	27.41	125.1	33.64	129.3	35.10	131.2	35.40	133.1	35.58	136.9	35.69	140.8	35.97	
43	104.9	29.25	119.9	33.16	124.0	34.31	125.8	34.64	127.7	34.82	131.4	34.92	135.2	35.20	
46	98.3	31.46	109.3	32.37	113.3	33.23	114.9	33.51	116.7	33.67	120.2	33.77	123.8	34.04	
48	87.0	30.81	94.9	31.80	98.4	32.59	99.9	32.78	101.5	32.89	104.6	33.02	107.7	33.15	
110	10	98.9	10.36	117.9	12.62	131.7	14.99	135.5	16.23	144.1	17.47	147.4	17.95	157.4	18.25
	12	98.9	10.68	117.9	13.05	131.7	15.62	135.5	16.69	144.1	18.12	147.4	18.71	157.4	19.14
	14	98.9	11.01	117.9	13.64	131.7	16.32	135.5	17.51	144.1	19.04	147.4	19.58	157.4	19.99
	16	98.9	11.40	117.9	14.13	131.7	17.00	135.5	18.28	144.1	19.91	147.4	20.46	157.4	20.82
	18	98.9	11.83	117.9	14.72	131.7	17.98	135.5	19.25	144.1	21.00	147.4	21.42	157.4	21.82
	20	98.9	12.25	117.9	15.46	131.7	19.06	135.5	20.13	144.1	22.02	147.4	22.57	157.4	22.93
	21	98.9	12.52	117.9	15.92	131.7	19.55	135.5	20.67	144.1	22.64	147.4	23.21	157.4	23.57
	23	98.9	13.34	117.9	17.06	131.7	20.65	135.5	21.82	144.1	23.92	147.4	24.43	157.4	24.83
	25	98.9	14.25	117.9	18.21	131.7	21.81	135.5	23.07	144.1	25.27	147.4	25.63	155.5	26.15
	27	98.9	15.23	117.9	19.46	131.7	23.05	135.5	24.42	144.1	26.39	147.4	26.99	153.2	27.45
	29	98.9	16.26	117.9	20.78	131.7	24.36	135.5	25.86	144.1	27.89	147.4	28.37	151.2	28.80
	31	98.9	17.29	117.9	22.16	131.7	25.74	135.5	27.40	141.7	29.30	145.5	29.88	148.9	30.19
	33	98.9	18.43	117.9	23.59	131.7	27.19	135.5	29.04	139.8	30.95	143.1	31.46	146.9	31.63
	35	98.9	19.58	117.9	25.19	131.7	28.72	135.5	30.77	137.4	32.66	140.7	32.96	144.6	33.12
	37	98.9	20.75	117.9	26.73	131.7	30.32	133.6	32.60	135.0	34.45	138.9	34.57	142.2	34.66
	39	98.9	22.37	117.9	28.41	129.3	31.99	131.2	34.87	133.2	36.15	136.5	36.21	140.3	36.25
41	96.4	23.99	114.9	30.08	123.8	33.73	125.7	37.71	127.4	37.71	131.1	38.01	134.4	38.32	
43	94.0	25.19	112.1	31.34	118.6	35.77	120.6	36.18	122.2	36.10	125.8	36.30	129.0	36.40	
46	88.1	24.59	105.0	30.26	108.2	33.95	110.1	33.95	111.6	34.24	115.0	34.43	118.0	34.52	
48	77.9	23.88	91.3	29.15	94.0	32.30	95.7	32.52	97.0	32.67	100.0	32.77	102.6	32.90	

# 7. Capacity Tables

Cooling Capacity (44HP)

Combination (%)	Outdoor air temp. (DB, °C)	Indoor air temp. (DB/WB, °C)													
		20		23		26		27		28		30		32	
		14		16		18		19		20		22		24	
		TC	PI	TC	PI	TC	PI	TC	PI	TC	PI	TC	PI	TC	PI
100	10	83.2	9.33	99.0	11.34	115.3	13.45	123.2	14.53	131.1	15.61	145.4	17.38	148.6	17.52
	12	83.2	9.62	99.0	11.80	115.3	13.90	123.2	14.92	131.1	16.11	145.4	18.31	148.6	18.49
	14	83.2	9.93	99.0	12.27	115.3	14.49	123.2	15.57	131.1	16.80	145.4	19.34	148.6	19.52
	16	83.2	10.23	99.0	12.68	115.3	15.11	123.2	16.31	131.1	17.71	145.4	20.27	148.6	20.56
	18	83.2	10.53	99.0	13.15	115.3	15.69	123.2	17.10	131.1	18.78	145.4	21.42	148.6	21.59
	20	83.2	10.91	99.0	13.64	115.3	16.60	123.2	18.32	131.1	20.09	145.4	22.44	148.6	22.62
	21	83.2	11.13	99.0	13.97	115.3	17.17	123.2	18.95	131.1	20.84	145.4	22.96	148.6	23.14
	23	83.2	11.79	99.0	14.94	115.3	18.43	123.2	20.32	131.1	22.33	145.4	24.04	148.6	24.23
	25	83.2	12.54	99.0	15.92	115.3	19.69	123.2	21.75	131.1	23.87	145.4	25.06	147.3	25.26
	27	83.2	13.40	99.0	17.00	115.3	21.07	123.2	23.24	131.1	25.38	142.5	26.24	145.6	26.45
	29	83.2	14.25	99.0	18.15	115.3	22.50	123.2	24.85	131.1	26.86	139.9	27.30	143.4	27.52
	31	83.2	15.23	99.0	19.35	115.3	23.99	123.2	26.51	131.1	28.23	137.8	28.36	141.2	28.58
	33	83.2	16.14	99.0	20.61	115.3	25.59	123.2	28.28	131.1	29.29	135.6	29.41	139.0	29.65
	35	83.2	17.17	99.0	21.93	115.3	27.25	123.2	30.17	129.1	30.35	133.1	30.47	136.5	30.71
	37	83.2	18.39	99.0	23.52	115.3	28.87	123.2	31.61	127.0	31.76	130.7	31.89	133.8	32.18
	39	83.2	19.72	99.0	25.26	115.3	30.59	123.2	33.15	124.9	33.30	128.6	33.42	131.6	33.73
	41	81.8	21.05	97.4	27.01	113.5	32.31	118.2	34.70	120.8	34.83	123.6	34.96	127.7	35.28
	43	79.0	22.27	94.1	28.63	109.6	33.86	113.3	36.02	114.6	36.15	118.2	36.27	121.3	36.61
46	74.1	23.96	88.2	30.87	102.7	35.91	103.5	37.71	104.6	37.82	108.0	37.93	110.9	38.29	
48	65.5	20.69	78.0	26.71	88.6	30.70	89.9	32.00	90.9	32.10	93.9	32.17	96.4	32.43	
90	10	74.8	8.69	89.3	10.45	103.8	12.31	110.9	13.27	117.9	14.29	132.4	15.99	147.0	17.52
	12	74.8	8.79	89.3	10.61	103.8	12.53	110.9	13.54	117.9	14.60	132.4	16.31	147.0	18.10
	14	74.8	8.95	89.3	10.82	103.8	12.79	110.9	13.81	117.9	14.87	132.4	16.62	147.0	18.46
	16	74.8	9.11	89.3	11.03	103.8	13.06	110.9	14.07	117.9	15.14	132.4	16.94	147.0	18.78
	18	74.8	9.27	89.3	11.25	103.8	13.27	110.9	14.39	117.9	15.46	132.4	17.31	147.0	19.72
	20	74.8	9.43	89.3	11.46	103.8	13.54	110.9	14.66	117.9	16.04	132.4	18.52	147.0	20.67
	21	74.8	9.54	89.3	11.57	103.8	13.81	110.9	15.14	117.9	16.63	132.4	18.82	147.0	21.14
	23	74.8	9.75	89.3	12.05	103.8	14.76	110.9	16.26	117.9	17.80	132.4	19.96	144.9	22.14
	25	74.8	10.23	89.3	12.85	103.8	15.78	110.9	17.38	117.9	19.03	132.4	21.34	142.9	23.08
	27	74.8	10.93	89.3	13.70	103.8	16.84	110.9	18.55	117.9	20.36	132.4	22.69	140.8	24.17
	29	74.8	11.57	89.3	14.60	103.8	18.02	110.9	19.83	117.9	21.75	132.4	24.04	138.7	25.14
	31	74.8	12.31	89.3	15.56	103.8	19.19	110.9	21.11	117.9	23.19	132.4	25.24	136.6	26.11
	33	74.8	13.11	89.3	16.58	103.8	20.47	110.9	22.49	117.9	24.59	132.4	26.46	134.5	27.08
	35	74.8	13.91	89.3	17.59	103.8	21.75	110.9	23.99	117.9	26.08	130.2	27.98	132.4	28.62
	37	74.8	14.76	89.3	18.71	103.8	23.19	110.9	25.48	117.9	27.53	128.1	29.25	130.3	29.90
	39	74.8	15.63	89.3	19.90	103.8	24.54	110.9	27.11	117.9	28.95	126.0	30.83	128.2	31.20
	41	72.9	17.49	87.0	22.06	101.2	26.94	108.0	29.65	114.9	31.25	120.7	32.49	122.9	33.24
	43	71.1	18.88	84.9	23.84	98.7	29.42	105.4	31.94	112.1	33.51	115.7	34.75	117.8	35.22
46	66.6	21.25	79.5	27.15	92.5	33.52	98.7	36.21	101.8	37.23	105.7	37.86	107.6	38.04	
48	58.9	18.57	70.4	23.75	81.8	29.33	87.4	31.58	88.4	31.90	91.8	32.17	93.6	32.43	
80	10	66.4	8.11	79.2	9.74	92.0	11.43	98.6	12.33	105.2	13.24	117.9	15.09	130.7	16.39
	12	66.4	8.28	79.2	9.86	92.0	11.66	98.6	12.56	105.2	13.46	117.9	15.38	130.7	16.71
	14	66.4	8.39	79.2	10.08	92.0	11.83	98.6	12.78	105.2	13.69	117.9	15.66	130.7	17.04
	16	66.4	8.50	79.2	10.25	92.0	12.05	98.6	13.01	105.2	13.97	117.9	15.99	130.7	17.36
	18	66.4	8.67	79.2	10.42	92.0	12.28	98.6	13.24	105.2	14.25	117.9	16.28	130.7	17.74
	20	66.4	8.84	79.2	10.64	92.0	12.56	98.6	13.52	105.2	14.53	117.9	16.90	130.7	18.79
	21	66.4	8.90	79.2	10.76	92.0	12.67	98.6	13.69	105.2	14.87	117.9	17.43	130.7	19.29
	23	66.4	9.07	79.2	10.93	92.0	13.24	98.6	14.53	105.2	15.88	117.9	18.40	130.7	20.25
	25	66.4	9.41	79.2	11.66	92.0	14.19	98.6	15.54	105.2	17.01	117.9	19.69	130.7	21.65
	27	66.4	9.97	79.2	12.39	92.0	15.15	98.6	16.61	105.2	18.13	117.9	20.93	130.7	22.78
	29	66.4	10.59	79.2	13.24	92.0	16.11	98.6	17.68	105.2	19.37	117.9	22.42	130.7	23.88
	31	66.4	11.26	79.2	14.02	92.0	17.18	98.6	18.87	105.2	20.61	117.9	23.79	130.7	25.07
	33	66.4	11.94	79.2	14.98	92.0	18.30	98.6	20.11	105.2	21.96	117.9	25.07	130.7	26.27
	35	66.4	12.67	79.2	15.88	92.0	19.49	98.6	21.40	105.2	23.43	117.9	26.58	129.3	27.76
	37	66.4	13.40	79.2	16.89	92.0	20.67	98.6	22.75	105.2	24.89	117.9	28.05	127.2	29.08
	39	66.4	14.17	79.2	17.85	92.0	22.11	98.6	24.46	105.2	26.75	117.9	29.64	125.1	30.68
	41	64.7	15.67	77.2	19.78	89.6	24.27	96.0	26.81	102.5	29.39	114.9	31.84	119.9	32.57
	43	63.1	17.25	75.3	21.59	87.4	26.49	93.7	29.22	99.9	32.12	112.1	34.06	114.9	34.86
46	59.2	19.19	70.5	24.32	81.9	29.85	87.8	32.52	93.7	36.25	102.5	37.86	104.9	38.04	
48	52.3	16.76	62.4	21.26	72.4	26.10	77.6	28.41	82.8	31.67	89.0	32.17	91.1	32.43	

# 7. Capacity Tables

Cooling Capacity (44HP)

Combination (%)	Outdoor air temp. (DB, °C)	Indoor air temp. (DB/WB, °C)													
		20		23		26		27		28		30		32	
		14		16		18		19		20		22		24	
		TC	PI	TC	PI	TC	PI	TC	PI	TC	PI	TC	PI	TC	PI
70	10	58.1	7.18	69.5	8.54	80.5	9.89	86.2	10.68	92.0	11.42	103.0	13.00	114.4	14.54
	12	58.1	7.29	69.5	8.65	80.5	10.12	86.2	10.85	92.0	11.65	103.0	13.23	114.4	14.82
	14	58.1	7.41	69.5	8.76	80.5	10.29	86.2	11.02	92.0	11.81	103.0	13.51	114.4	15.09
	16	58.1	7.52	69.5	8.93	80.5	10.46	86.2	11.25	92.0	12.04	103.0	13.74	114.4	15.41
	18	58.1	7.63	69.5	9.10	80.5	10.68	86.2	11.48	92.0	12.27	103.0	13.96	114.4	15.68
	20	58.1	7.74	69.5	9.27	80.5	10.85	86.2	11.70	92.0	12.55	103.0	14.30	114.4	16.28
	21	58.1	7.86	69.5	9.33	80.5	10.97	86.2	11.81	92.0	12.66	103.0	14.53	114.4	16.63
	23	58.1	7.97	69.5	9.55	80.5	11.19	86.2	12.21	92.0	13.28	103.0	15.55	114.4	17.55
	25	58.1	8.08	69.5	9.89	80.5	11.93	86.2	13.06	92.0	14.19	103.0	16.62	114.4	18.41
	27	58.1	8.54	69.5	10.57	80.5	12.72	86.2	13.85	92.0	15.15	103.0	17.75	114.4	19.56
	29	58.1	9.10	69.5	11.19	80.5	13.51	86.2	14.75	92.0	16.11	103.0	18.94	114.4	20.96
	31	58.1	9.67	69.5	11.93	80.5	14.42	86.2	15.77	92.0	17.19	103.0	20.18	114.4	22.24
	33	58.1	10.23	69.5	12.61	80.5	15.32	86.2	16.73	92.0	18.26	103.0	21.48	114.4	23.67
	35	58.1	10.80	69.5	13.46	80.5	16.28	86.2	17.81	92.0	19.45	103.0	22.89	114.4	25.10
	37	58.1	11.48	69.5	14.25	80.5	17.30	86.2	18.94	92.0	20.69	103.0	24.36	114.4	26.49
	39	58.1	12.19	69.5	15.20	80.5	18.50	86.2	20.37	92.0	22.35	103.0	26.08	114.4	28.56
	41	56.6	13.47	67.7	16.65	78.5	20.29	84.0	22.35	89.6	24.30	100.3	28.64	111.5	30.81
	43	55.2	14.67	66.1	18.14	76.5	22.14	82.0	24.37	87.4	26.53	97.8	31.29	108.7	33.31
46	51.7	16.30	61.9	20.40	71.7	24.93	76.8	27.14	81.9	29.91	91.7	35.29	101.9	37.13	
48	45.8	14.22	54.8	17.82	63.4	21.80	67.9	23.72	72.4	26.17	81.1	30.88	90.1	32.01	
60	10	49.7	6.24	59.4	7.32	69.1	8.51	73.9	9.14	78.8	9.70	88.4	11.01	98.1	12.31
	12	49.7	6.36	59.4	7.43	69.1	8.62	73.9	9.25	78.8	9.87	88.4	11.18	98.1	12.54
	14	49.7	6.41	59.4	7.55	69.1	8.79	73.9	9.42	78.8	10.04	88.4	11.40	98.1	12.77
	16	49.7	6.53	59.4	7.72	69.1	8.91	73.9	9.59	78.8	10.27	88.4	11.63	98.1	12.99
	18	49.7	6.64	59.4	7.83	69.1	9.08	73.9	9.76	78.8	10.44	88.4	11.80	98.1	13.28
	20	49.7	6.75	59.4	7.94	69.1	9.25	73.9	9.93	78.8	10.61	88.4	12.03	98.1	13.56
	21	49.7	6.81	59.4	8.00	69.1	9.36	73.9	10.04	78.8	10.72	88.4	12.20	98.1	13.67
	23	49.7	6.92	59.4	8.17	69.1	9.48	73.9	10.21	78.8	10.95	88.4	12.65	98.1	14.53
	25	49.7	7.04	59.4	8.34	69.1	9.87	73.9	10.72	78.8	11.63	88.4	13.50	98.1	15.55
	27	49.7	7.26	59.4	8.79	69.1	10.50	73.9	11.40	78.8	12.37	88.4	14.36	98.1	16.57
	29	49.7	7.72	59.4	9.36	69.1	11.18	73.9	12.14	78.8	13.16	88.4	15.32	98.1	17.70
	31	49.7	8.17	59.4	9.93	69.1	11.86	73.9	12.94	78.8	14.02	88.4	16.34	98.1	18.84
	33	49.7	8.62	59.4	10.50	69.1	12.60	73.9	13.73	78.8	14.92	88.4	17.36	98.1	20.09
	35	49.7	9.14	59.4	11.18	69.1	13.39	73.9	14.58	78.8	15.83	88.4	18.50	98.1	21.33
	37	49.7	9.65	59.4	11.80	69.1	14.19	73.9	15.49	78.8	16.80	88.4	19.63	98.1	22.70
	39	49.7	10.26	59.4	12.56	69.1	15.31	73.9	16.62	78.8	18.07	88.4	21.05	98.1	24.32
	41	48.4	11.13	57.9	13.74	67.3	16.63	72.0	18.15	76.7	19.62	86.2	23.10	95.6	26.43
	43	47.2	12.09	56.4	14.96	65.6	18.13	70.2	19.78	74.8	21.39	84.0	25.22	93.2	28.87
46	44.3	13.54	52.9	16.80	61.5	20.39	65.8	22.24	70.1	24.07	78.8	28.42	87.4	32.89	
48	39.2	11.80	46.8	14.66	54.4	17.81	58.2	19.42	62.0	21.04	69.7	24.85	77.3	28.78	
50	10	41.6	5.41	49.7	6.26	57.6	7.12	61.6	7.63	65.6	8.09	73.5	9.11	81.8	10.14
	12	41.6	5.47	49.7	6.32	57.6	7.23	61.6	7.75	65.6	8.26	73.5	9.28	81.8	10.31
	14	41.6	5.52	49.7	6.44	57.6	7.35	61.6	7.86	65.6	8.37	73.5	9.40	81.8	10.48
	16	41.6	5.64	49.7	6.55	57.6	7.46	61.6	8.03	65.6	8.49	73.5	9.57	81.8	10.65
	18	41.6	5.70	49.7	6.61	57.6	7.57	61.6	8.14	65.6	8.66	73.5	9.74	81.8	10.88
	20	41.6	5.75	49.7	6.72	57.6	7.75	61.6	8.26	65.6	8.83	73.5	9.91	81.8	11.11
	21	41.6	5.81	49.7	6.78	57.6	7.80	61.6	8.37	65.6	8.88	73.5	10.02	81.8	11.22
	23	41.6	5.92	49.7	6.89	57.6	7.92	61.6	8.49	65.6	9.06	73.5	10.19	81.8	11.45
	25	41.6	5.98	49.7	7.01	57.6	8.09	61.6	8.66	65.6	9.34	73.5	10.71	81.8	12.24
	27	41.6	6.09	49.7	7.23	57.6	8.54	61.6	9.23	65.6	9.91	73.5	11.45	81.8	13.04
	29	41.6	6.44	49.7	7.69	57.6	9.06	61.6	9.80	65.6	10.54	73.5	12.13	81.8	13.84
	31	41.6	6.78	49.7	8.14	57.6	9.62	61.6	10.37	65.6	11.22	73.5	12.93	81.8	14.75
	33	41.6	7.18	49.7	8.60	57.6	10.19	61.6	10.99	65.6	11.90	73.5	13.73	81.8	15.72
	35	41.6	7.57	49.7	9.11	57.6	10.76	61.6	11.68	65.6	12.59	73.5	14.52	81.8	16.69
	37	41.6	8.03	49.7	9.62	57.6	11.39	61.6	12.36	65.6	13.33	73.5	15.49	81.8	17.71
	39	41.6	8.57	49.7	10.32	57.6	12.20	61.6	13.30	65.6	14.30	73.5	16.50	81.8	19.13
	41	40.5	9.26	48.4	11.17	56.2	13.34	60.0	14.41	63.9	15.49	71.6	18.09	79.7	20.77
	43	39.5	10.07	47.2	12.15	54.8	14.52	58.5	15.69	62.3	16.87	69.8	19.72	77.8	22.66
46	37.0	11.27	44.3	13.62	51.3	16.29	54.9	17.62	58.4	18.94	65.4	22.19	72.9	25.51	
48	32.8	9.83	39.2	11.88	45.4	14.21	48.5	15.38	51.6	16.53	57.9	19.39	64.5	22.30	

**Note**

1. TC: Total Capacity(kW), PI : Power Input(kW, Comp. + Outdoor fan motor)
2. Capacity tables show the average value of conditions which may occur.

# 7. Capacity Tables

## ◆ ARUM460LTE5

Cooling Capacity (46HP)

Combination (%)	Outdoor air temp. (DB, °C)	Indoor air temp. (DB/WB, °C)													
		20		23		26		27		28		30		32	
		14	16	18	19	20	22	24	TC	PI	TC	PI	TC	PI	
130	10	127.6	14.14	151.9	17.28	162.8	20.05	167.5	20.45	172.2	20.62	180.5	20.78	185.1	20.86
	12	127.6	14.49	151.9	17.90	162.8	20.87	167.5	21.01	172.2	21.17	180.5	21.34	185.1	21.53
	14	127.6	14.97	151.9	18.55	162.8	21.65	167.5	21.81	172.2	21.99	180.5	22.16	185.1	22.36
	16	127.6	15.52	151.9	19.19	162.8	22.62	167.5	22.83	172.2	23.02	180.5	23.22	185.1	23.41
	18	127.6	16.17	151.9	20.30	162.8	23.66	167.5	24.17	172.2	24.37	180.5	24.61	185.1	24.78
	20	127.6	16.89	151.9	21.63	162.8	24.83	167.5	26.59	172.2	26.80	177.8	27.07	182.5	27.26
	21	127.6	17.33	151.9	22.39	162.8	25.35	167.5	28.14	172.2	28.36	176.8	28.65	181.5	28.84
	23	127.6	18.59	151.9	23.55	162.8	26.67	167.5	31.05	170.0	31.30	174.2	31.61	178.9	31.83
	25	127.6	19.86	151.9	24.91	162.8	28.50	165.5	34.44	167.5	34.71	172.2	35.06	176.8	35.30
	27	127.6	21.25	151.9	26.62	160.8	30.36	162.8	37.91	165.5	38.21	170.0	38.59	174.2	38.86
	29	127.6	22.64	151.9	28.47	158.2	32.67	160.5	41.66	162.8	41.91	167.5	42.29	172.2	42.45
	31	127.6	24.16	151.4	29.98	155.5	34.75	158.2	41.49	160.5	41.74	164.9	42.11	169.6	42.28
	33	127.6	25.74	148.8	31.77	153.5	37.27	156.0	41.11	158.2	41.36	162.8	41.73	166.9	41.89
	35	127.6	27.45	146.2	33.27	150.9	40.37	153.5	40.57	156.0	40.82	160.2	41.18	164.9	41.34
	37	127.6	29.27	144.1	34.91	148.8	39.84	150.9	40.04	153.5	40.28	157.7	40.64	162.3	40.80
	39	127.6	31.17	141.6	36.75	146.2	39.30	148.8	39.50	150.9	39.74	155.5	40.09	160.2	40.25
41	124.3	33.07	135.7	38.59	140.3	38.77	142.4	38.97	145.2	39.20	149.6	39.55	153.6	39.71	
43	121.2	34.87	130.1	38.05	134.6	38.24	136.6	38.43	139.3	38.66	143.6	39.01	147.5	39.16	
46	113.6	37.33	118.6	37.25	122.9	37.44	124.9	37.63	127.5	37.85	131.5	38.19	135.1	38.34	
48	100.5	36.29	103.0	36.39	106.9	36.47	108.6	36.57	110.9	36.89	114.5	37.12	117.6	37.27	
120	10	115.4	12.72	137.3	15.60	150.0	18.53	154.6	20.03	159.1	20.35	167.8	20.43	171.9	20.59
	12	115.4	13.06	137.3	16.12	150.0	19.28	154.6	20.45	159.1	21.10	167.8	21.35	171.9	21.53
	14	115.4	13.51	137.3	16.67	150.0	20.06	154.6	21.23	159.1	21.87	167.8	22.19	171.9	22.37
	16	115.4	14.00	137.3	17.35	150.0	20.83	154.6	22.02	159.1	22.88	167.8	23.16	171.9	23.35
	18	115.4	14.55	137.3	18.13	150.0	21.66	154.6	23.18	159.1	24.06	167.8	24.33	171.9	24.53
	20	115.4	15.10	137.3	19.23	150.0	22.83	154.6	24.39	159.1	25.33	167.8	25.66	171.9	25.87
	21	115.4	15.56	137.3	19.92	150.0	23.47	154.6	25.11	159.1	26.16	167.8	26.50	171.9	26.71
	23	115.4	16.63	137.3	21.31	150.0	25.15	154.6	26.68	159.1	27.89	167.8	28.18	171.9	28.40
	25	115.4	17.77	137.3	22.83	150.0	26.53	154.6	28.44	159.1	29.91	165.8	30.16	169.8	30.40
	27	115.4	18.97	137.3	24.41	150.0	28.23	154.6	30.39	159.1	32.15	163.2	32.36	167.3	32.62
	29	115.4	20.24	137.3	26.06	150.0	29.70	154.6	32.52	156.6	34.26	160.7	34.78	165.2	35.05
	31	115.4	21.57	137.3	27.83	150.0	31.24	152.6	34.84	154.6	36.75	158.7	37.40	162.7	37.70
	33	115.4	22.96	137.3	29.66	148.0	33.05	150.0	37.82	152.0	39.46	156.1	39.91	160.2	40.23
	35	115.4	24.41	137.3	31.62	145.4	34.98	147.4	41.66	150.0	41.87	154.1	42.00	158.1	42.33
	37	115.4	26.26	137.3	33.37	143.4	37.29	145.4	40.79	147.4	40.99	151.5	41.11	155.6	41.44
	39	115.4	28.27	136.8	35.27	140.9	39.55	142.9	39.95	144.9	40.15	149.5	40.27	153.5	40.59
41	112.5	30.28	130.8	37.17	135.2	38.77	137.1	39.11	139.1	39.31	143.2	39.42	147.2	39.74	
43	109.7	32.32	125.3	36.63	129.7	37.90	131.5	38.27	133.5	38.46	137.4	38.58	141.4	38.89	
46	102.8	34.75	114.3	35.76	118.4	36.72	120.2	37.02	122.0	37.20	125.7	37.31	129.4	37.61	
48	90.9	34.04	99.2	35.13	102.9	36.00	104.5	36.22	106.1	36.33	109.3	36.48	112.6	36.62	
110	10	103.4	11.44	123.3	13.95	137.7	16.56	141.7	17.93	150.6	19.30	154.1	19.83	164.5	20.16
	12	103.4	11.80	123.3	14.41	137.7	17.25	141.7	18.44	150.6	20.02	154.1	20.66	164.5	21.14
	14	103.4	12.17	123.3	15.06	137.7	18.03	141.7	19.35	150.6	21.03	154.1	21.63	164.5	22.08
	16	103.4	12.60	123.3	15.61	137.7	18.78	141.7	20.19	150.6	22.00	154.1	22.60	164.5	23.00
	18	103.4	13.07	123.3	16.26	137.7	19.86	141.7	21.26	150.6	23.20	154.1	23.66	164.5	24.11
	20	103.4	13.53	123.3	17.08	137.7	21.06	141.7	22.24	150.6	24.33	154.1	24.93	164.5	25.33
	21	103.4	13.83	123.3	17.58	137.7	21.60	141.7	22.84	150.6	25.01	154.1	25.64	164.5	26.04
	23	103.4	14.74	123.3	18.85	137.7	22.81	141.7	24.11	150.6	26.42	154.1	26.99	164.5	27.43
	25	103.4	15.75	123.3	20.11	137.7	24.09	141.7	25.49	150.6	27.91	154.1	28.31	162.5	28.89
	27	103.4	16.82	123.3	21.50	137.7	25.46	141.7	26.98	150.6	29.15	154.1	29.82	160.1	30.33
	29	103.4	17.96	123.3	22.96	137.7	26.91	141.7	28.57	150.6	30.81	154.1	31.34	158.1	31.81
	31	103.4	19.10	123.3	24.48	137.7	28.43	141.7	30.27	148.2	32.37	152.1	33.01	155.6	33.35
	33	103.4	20.36	123.3	26.06	137.7	30.04	141.7	32.08	146.1	34.19	149.7	34.75	153.6	34.95
	35	103.4	21.63	123.3	27.83	137.7	31.73	141.7	33.99	143.7	36.08	147.1	36.41	151.1	36.59
	37	103.4	22.92	123.3	29.53	137.7	33.49	139.7	36.01	141.2	38.05	145.2	38.19	148.6	38.29
	39	103.4	24.71	123.3	31.38	135.2	35.34	137.2	38.52	139.2	39.94	142.7	40.01	146.7	40.05
41	100.8	26.51	120.1	33.23	129.4	37.27	131.5	41.66	133.2	41.66	137.1	42.00	140.5	42.33	
43	98.3	27.83	117.2	34.62	124.0	39.52	126.1	39.96	127.7	39.88	131.5	40.10	134.8	40.21	
46	92.1	27.17	109.8	33.43	113.2	37.51	115.1	37.50	116.6	37.83	120.2	38.04	123.3	38.14	
48	81.5	26.38	95.4	32.20	98.3	35.68	100.1	35.92	101.4	36.10	104.5	36.20	107.3	36.34	

# 7. Capacity Tables

Cooling Capacity (46HP)

Combination (%)	Outdoor air temp. (DB, °C)	Indoor air temp. (DB/WB, °C)													
		20		23		26		27		28		30		32	
		14		16		18		19		20		22		24	
		TC	PI	TC	PI	TC	PI	TC	PI	TC	PI	TC	PI	TC	PI
100	10	86.9	10.30	103.5	12.52	120.5	14.86	128.8	16.05	137.1	17.25	152.0	19.20	155.3	19.35
	12	86.9	10.63	103.5	13.03	120.5	15.36	128.8	16.48	137.1	17.80	152.0	20.23	155.3	20.43
	14	86.9	10.97	103.5	13.55	120.5	16.01	128.8	17.20	137.1	18.56	152.0	21.36	155.3	21.56
	16	86.9	11.30	103.5	14.00	120.5	16.69	128.8	18.01	137.1	19.56	152.0	22.40	155.3	22.71
	18	86.9	11.63	103.5	14.52	120.5	17.34	128.8	18.89	137.1	20.74	152.0	23.66	155.3	23.85
	20	86.9	12.05	103.5	15.07	120.5	18.34	128.8	20.24	137.1	22.20	152.0	24.79	155.3	24.99
	21	86.9	12.30	103.5	15.43	120.5	18.97	128.8	20.93	137.1	23.02	152.0	25.36	155.3	25.56
	23	86.9	13.03	103.5	16.51	120.5	20.36	128.8	22.45	137.1	24.67	152.0	26.56	155.3	26.77
	25	86.9	13.85	103.5	17.58	120.5	21.76	128.8	24.03	137.1	26.37	152.0	27.69	154.0	27.91
	27	86.9	14.80	103.5	18.78	120.5	23.27	128.8	25.68	137.1	28.04	149.0	28.99	152.2	29.22
	29	86.9	15.75	103.5	20.05	120.5	24.86	128.8	27.45	137.1	29.68	146.3	30.16	149.9	30.40
	31	86.9	16.82	103.5	21.38	120.5	26.50	128.8	29.28	137.1	31.18	144.1	31.33	147.6	31.58
	33	86.9	17.84	103.5	22.77	120.5	28.27	128.8	31.24	137.1	32.36	141.7	32.49	145.3	32.75
	35	86.9	18.97	103.5	24.22	120.5	30.10	128.8	33.33	135.0	33.53	139.2	33.66	142.7	33.93
	37	86.9	20.32	103.5	25.98	120.5	31.89	128.8	34.92	132.8	35.09	136.6	35.23	139.8	35.56
	39	86.9	21.79	103.5	27.91	120.5	33.79	128.8	36.62	130.6	36.79	134.4	36.92	137.5	37.27
	41	85.6	23.25	101.9	29.84	118.6	35.69	123.6	38.33	126.3	38.48	129.3	38.62	133.5	38.98
43	82.6	24.61	98.4	31.63	114.5	37.40	118.5	39.80	119.9	39.94	123.6	40.07	126.8	40.45	
46	77.4	26.47	92.2	34.10	107.3	39.67	108.2	41.66	109.4	41.78	112.9	41.91	115.9	42.30	
48	68.5	22.85	81.5	29.50	92.7	33.91	94.0	35.35	95.0	35.46	98.1	35.54	100.8	35.83	
90	10	78.2	9.50	93.4	11.42	108.6	13.46	115.9	14.51	123.3	15.62	138.5	17.49	153.6	19.35
	12	78.2	9.62	93.4	11.60	108.6	13.70	115.9	14.81	123.3	15.97	138.5	17.83	153.6	19.79
	14	78.2	9.79	93.4	11.83	108.6	13.99	115.9	15.10	123.3	16.26	138.5	18.18	153.6	20.19
	16	78.2	9.97	93.4	12.07	108.6	14.28	115.9	15.39	123.3	16.55	138.5	18.52	153.6	20.53
	18	78.2	10.14	93.4	12.30	108.6	14.51	115.9	15.74	123.3	16.90	138.5	18.93	153.6	21.57
	20	78.2	10.32	93.4	12.53	108.6	14.81	115.9	16.03	123.3	17.55	138.5	20.25	153.6	22.60
	21	78.2	10.43	93.4	12.65	108.6	15.10	115.9	16.55	123.3	18.19	138.5	20.59	153.6	23.12
	23	78.2	10.67	93.4	13.17	108.6	16.15	115.9	17.78	123.3	19.47	138.5	21.83	151.5	24.21
	25	78.2	11.19	93.4	14.05	108.6	17.25	115.9	19.00	123.3	20.81	138.5	23.34	149.3	25.24
	27	78.2	11.95	93.4	14.98	108.6	18.42	115.9	20.28	123.3	22.27	138.5	24.82	147.2	26.43
	29	78.2	12.65	93.4	15.97	108.6	19.70	115.9	21.68	123.3	23.78	138.5	26.29	145.0	27.49
	31	78.2	13.46	93.4	17.02	108.6	20.98	115.9	23.08	123.3	25.36	138.5	27.60	142.8	28.55
	33	78.2	14.34	93.4	18.13	108.6	22.38	115.9	24.60	123.3	26.89	138.5	28.93	140.6	29.62
	35	78.2	15.21	93.4	19.24	108.6	23.78	115.9	26.23	123.3	28.52	136.1	30.59	138.4	31.30
	37	78.2	16.15	93.4	20.46	108.6	25.36	115.9	27.86	123.3	30.10	133.9	31.98	136.2	32.70
	39	78.2	17.09	93.4	21.76	108.6	26.84	115.9	29.65	123.3	31.66	131.7	33.72	134.0	34.12
	41	76.2	19.13	91.0	24.13	105.8	29.46	113.0	32.43	120.1	34.18	126.2	35.53	128.5	36.35
43	74.3	20.65	88.7	26.07	103.2	32.18	110.2	34.92	117.2	36.64	121.0	38.05	123.2	38.51	
46	69.6	23.24	83.2	29.69	96.7	36.66	103.2	39.59	106.4	40.71	110.5	41.77	112.5	41.83	
48	61.6	20.31	73.6	25.97	85.5	32.08	91.3	34.54	92.4	35.08	96.0	35.54	97.8	35.83	
80	10	69.5	8.85	82.8	10.64	96.1	12.48	103.0	13.46	109.9	14.45	123.3	16.48	136.6	17.89
	12	69.5	9.04	82.8	10.76	96.1	12.73	103.0	13.71	109.9	14.69	123.3	16.78	136.6	18.24
	14	69.5	9.16	82.8	11.01	96.1	12.91	103.0	13.96	109.9	14.94	123.3	17.09	136.6	18.60
	16	69.5	9.28	82.8	11.19	96.1	13.16	103.0	14.20	109.9	15.25	123.3	17.46	136.6	18.95
	18	69.5	9.47	82.8	11.37	96.1	13.40	103.0	14.45	109.9	15.56	123.3	17.77	136.6	19.37
	20	69.5	9.65	82.8	11.62	96.1	13.71	103.0	14.76	109.9	15.86	123.3	18.44	136.6	20.52
	21	69.5	9.71	82.8	11.74	96.1	13.83	103.0	14.94	109.9	16.23	123.3	19.03	136.6	21.06
	23	69.5	9.90	82.8	11.93	96.1	14.45	103.0	15.86	109.9	17.34	123.3	20.09	136.6	22.11
	25	69.5	10.27	82.8	12.73	96.1	15.49	103.0	16.97	109.9	18.57	123.3	21.50	136.6	23.64
	27	69.5	10.88	82.8	13.53	96.1	16.54	103.0	18.14	109.9	19.80	123.3	22.85	136.6	24.87
	29	69.5	11.56	82.8	14.45	96.1	17.58	103.0	19.31	109.9	21.15	123.3	24.48	136.6	26.12
	31	69.5	12.30	82.8	15.31	96.1	18.75	103.0	20.60	109.9	22.50	123.3	25.97	136.6	27.41
	33	69.5	13.03	82.8	16.35	96.1	19.98	103.0	21.95	109.9	23.98	123.3	27.37	136.6	28.73
	35	69.5	13.83	82.8	17.34	96.1	21.27	103.0	23.36	109.9	25.58	123.3	29.02	135.2	30.36
	37	69.5	14.63	82.8	18.43	96.1	22.56	103.0	24.84	109.9	27.18	123.3	30.63	133.0	31.75
	39	69.5	15.47	82.8	19.49	96.1	24.14	103.0	26.70	109.9	29.20	123.3	32.36	130.8	33.49
	41	67.7	17.11	80.7	21.60	93.7	26.49	100.4	29.27	107.1	32.09	120.1	34.82	125.3	35.62
43	66.0	18.83	78.7	23.57	91.4	28.92	97.9	31.90	104.5	35.07	117.2	37.29	120.1	38.13	
46	61.9	20.95	73.7	26.55	85.6	32.58	91.8	35.51	97.9	39.57	107.1	41.77	109.7	41.83	
48	54.7	18.30	65.2	23.21	75.7	28.50	81.2	31.01	86.6	34.64	93.0	35.54	95.3	35.83	

# 7. Capacity Tables

Cooling Capacity (46HP)

Combination (%)	Outdoor air temp. (DB, °C)	Indoor air temp. (DB/WB, °C)													
		20		23		26		27		28		30		32	
		14		16		18		19		20		22		24	
		TC	PI	TC	PI	TC	PI	TC	PI	TC	PI	TC	PI	TC	PI
70	10	60.7	7.82	72.7	9.30	84.2	10.78	90.2	11.64	96.1	12.44	107.6	14.17	119.6	15.85
	12	60.7	7.95	72.7	9.43	84.2	11.03	90.2	11.83	96.1	12.69	107.6	14.42	119.6	16.15
	14	60.7	8.07	72.7	9.55	84.2	11.21	90.2	12.01	96.1	12.88	107.6	14.72	119.6	16.44
	16	60.7	8.19	72.7	9.73	84.2	11.40	90.2	12.26	96.1	13.12	107.6	14.97	119.6	16.80
	18	60.7	8.32	72.7	9.92	84.2	11.64	90.2	12.51	96.1	13.37	107.6	15.22	119.6	17.09
	20	60.7	8.44	72.7	10.10	84.2	11.83	90.2	12.75	96.1	13.68	107.6	15.59	119.6	17.74
	21	60.7	8.56	72.7	10.17	84.2	11.95	90.2	12.88	96.1	13.80	107.6	15.83	119.6	18.12
	23	60.7	8.69	72.7	10.41	84.2	12.20	90.2	13.31	96.1	14.48	107.6	16.94	119.6	19.13
	25	60.7	8.81	72.7	10.78	84.2	13.00	90.2	14.23	96.1	15.46	107.6	18.11	119.6	20.06
	27	60.7	9.30	72.7	11.52	84.2	13.86	90.2	15.09	96.1	16.51	107.6	19.35	119.6	21.32
	29	60.7	9.92	72.7	12.20	84.2	14.72	90.2	16.08	96.1	17.56	107.6	20.64	119.6	22.84
	31	60.7	10.54	72.7	13.00	84.2	15.71	90.2	17.19	96.1	18.73	107.6	21.99	119.6	24.24
	33	60.7	11.15	72.7	13.74	84.2	16.70	90.2	18.24	96.1	19.90	107.6	23.41	119.6	25.80
	35	60.7	11.77	72.7	14.67	84.2	17.74	90.2	19.41	96.1	21.19	107.6	24.95	119.6	27.36
	37	60.7	12.51	72.7	15.53	84.2	18.85	90.2	20.64	96.1	22.55	107.6	26.55	119.6	28.87
	39	60.7	13.28	72.7	16.56	84.2	20.16	90.2	22.21	96.1	24.36	107.6	28.42	119.6	31.13
	41	59.2	14.68	70.8	18.14	82.0	22.11	87.9	24.36	93.7	26.48	104.9	31.21	116.5	33.58
	43	57.7	15.98	69.1	19.77	80.0	24.13	85.7	26.56	91.4	28.92	102.3	34.10	113.7	36.30
46	54.1	17.76	64.7	22.23	75.0	27.17	80.3	29.58	85.6	32.60	95.9	38.46	106.5	40.46	
48	47.8	15.50	57.3	19.42	66.3	23.75	71.0	25.85	75.7	28.52	84.8	33.65	94.2	35.02	
60	10	52.0	6.79	62.1	7.96	72.2	9.26	77.3	9.94	82.3	10.56	92.5	11.98	102.6	13.40
	12	52.0	6.91	62.1	8.09	72.2	9.38	77.3	10.06	82.3	10.74	92.5	12.16	102.6	13.64
	14	52.0	6.98	62.1	8.21	72.2	9.57	77.3	10.25	82.3	10.93	92.5	12.41	102.6	13.89
	16	52.0	7.10	62.1	8.40	72.2	9.69	77.3	10.43	82.3	11.17	92.5	12.66	102.6	14.14
	18	52.0	7.22	62.1	8.52	72.2	9.88	77.3	10.62	82.3	11.36	92.5	12.84	102.6	14.45
	20	52.0	7.35	62.1	8.64	72.2	10.06	77.3	10.80	82.3	11.54	92.5	13.09	102.6	14.75
	21	52.0	7.41	62.1	8.70	72.2	10.19	77.3	10.93	82.3	11.67	92.5	13.27	102.6	14.88
	23	52.0	7.53	62.1	8.89	72.2	10.31	77.3	11.11	82.3	11.91	92.5	13.77	102.6	15.80
	25	52.0	7.66	62.1	9.07	72.2	10.74	77.3	11.67	82.3	12.66	92.5	14.69	102.6	16.92
	27	52.0	7.90	62.1	9.57	72.2	11.42	77.3	12.41	82.3	13.46	92.5	15.62	102.6	18.03
	29	52.0	8.40	62.1	10.19	72.2	12.16	77.3	13.21	82.3	14.32	92.5	16.67	102.6	19.26
	31	52.0	8.89	62.1	10.80	72.2	12.90	77.3	14.08	82.3	15.25	92.5	17.78	102.6	20.50
	33	52.0	9.38	62.1	11.42	72.2	13.71	77.3	14.94	82.3	16.24	92.5	18.89	102.6	21.85
	35	52.0	9.94	62.1	12.16	72.2	14.57	77.3	15.87	82.3	17.22	92.5	20.13	102.6	23.21
	37	52.0	10.49	62.1	12.83	72.2	15.43	77.3	16.85	82.3	18.27	92.5	21.36	102.6	24.69
	39	52.0	11.16	62.1	13.67	72.2	16.66	77.3	18.08	82.3	19.67	92.5	22.90	102.6	26.46
	41	50.6	12.11	60.5	14.95	70.4	18.09	75.3	19.75	80.2	21.35	90.1	25.14	100.0	28.75
	43	49.4	13.15	59.0	16.28	68.6	19.72	73.4	21.52	78.2	23.28	87.9	27.44	97.5	31.41
46	46.3	14.73	55.3	18.28	64.3	22.18	68.8	24.20	73.3	26.19	82.3	30.92	91.4	35.78	
48	41.0	12.84	48.9	15.96	56.9	19.38	60.9	21.13	64.9	22.89	72.8	27.04	80.8	31.31	
50	10	43.5	5.88	52.0	6.80	60.3	7.73	64.4	8.29	68.5	8.78	76.8	9.90	85.6	11.01
	12	43.5	5.94	52.0	6.87	60.3	7.86	64.4	8.41	68.5	8.97	76.8	10.08	85.6	11.20
	14	43.5	6.00	52.0	6.99	60.3	7.98	64.4	8.54	68.5	9.09	76.8	10.21	85.6	11.38
	16	43.5	6.12	52.0	7.11	60.3	8.10	64.4	8.72	68.5	9.22	76.8	10.39	85.6	11.57
	18	43.5	6.19	52.0	7.18	60.3	8.23	64.4	8.85	68.5	9.40	76.8	10.58	85.6	11.82
	20	43.5	6.25	52.0	7.30	60.3	8.41	64.4	8.97	68.5	9.59	76.8	10.76	85.6	12.06
	21	43.5	6.31	52.0	7.36	60.3	8.47	64.4	9.09	68.5	9.65	76.8	10.89	85.6	12.19
	23	43.5	6.43	52.0	7.49	60.3	8.60	64.4	9.22	68.5	9.84	76.8	11.07	85.6	12.43
	25	43.5	6.50	52.0	7.61	60.3	8.78	64.4	9.40	68.5	10.15	76.8	11.63	85.6	13.30
	27	43.5	6.62	52.0	7.86	60.3	9.28	64.4	10.02	68.5	10.76	76.8	12.43	85.6	14.17
	29	43.5	6.99	52.0	8.35	60.3	9.84	64.4	10.64	68.5	11.44	76.8	13.18	85.6	15.03
	31	43.5	7.36	52.0	8.85	60.3	10.45	64.4	11.26	68.5	12.19	76.8	14.04	85.6	16.02
	33	43.5	7.79	52.0	9.34	60.3	11.07	64.4	11.94	68.5	12.93	76.8	14.91	85.6	17.07
	35	43.5	8.23	52.0	9.90	60.3	11.69	64.4	12.68	68.5	13.67	76.8	15.77	85.6	18.13
	37	43.5	8.72	52.0	10.45	60.3	12.37	64.4	13.42	68.5	14.48	76.8	16.83	85.6	19.24
	39	43.5	9.30	52.0	11.21	60.3	13.26	64.4	14.45	68.5	15.53	76.8	17.92	85.6	20.78
	41	42.4	10.06	50.6	12.13	58.7	14.50	62.8	15.65	66.8	16.83	74.9	19.65	83.4	22.56
	43	41.3	10.93	49.4	13.20	57.3	15.77	61.2	17.04	65.1	18.32	73.0	21.42	81.3	24.62
46	38.7	12.25	46.3	14.80	53.7	17.69	57.4	19.14	61.0	20.57	68.4	24.10	76.2	27.71	
48	34.2	10.67	41.0	12.91	47.5	15.43	50.7	16.70	54.0	17.95	60.5	21.06	67.4	24.23	

**Note**

1. TC: Total Capacity(kW), PI : Power Input(kW, Comp. + Outdoor fan motor)
2. Capacity tables show the average value of conditions which may occur.



# 7. Capacity Tables

◆ ARUM480LTE5

Cooling Capacity (48HP)

Combination (%)	Outdoor air temp. (DB, °C)	Indoor air temp. (DB/WB, °C)													
		20		23		26		27		28		30		32	
		14	16	16	18	18	19	20	20	22	22	24	24		
		TC	PI	TC	PI	TC	PI	TC	PI	TC	PI	TC	PI	TC	PI
130	10	133.1	14.77	158.5	18.05	169.9	20.94	174.8	21.37	179.7	21.54	188.3	21.71	193.2	21.79
	12	133.1	15.14	158.5	18.70	169.9	21.80	174.8	21.94	179.7	22.12	188.3	22.30	193.2	22.49
	14	133.1	15.64	158.5	19.38	169.9	22.62	174.8	22.79	179.7	22.97	188.3	23.15	193.2	23.36
	16	133.1	16.21	158.5	20.05	169.9	23.64	174.8	23.86	179.7	24.05	188.3	24.26	193.2	24.45
	18	133.1	16.90	158.5	21.21	169.9	24.72	174.8	25.25	179.7	25.46	188.3	25.71	193.2	25.89
	20	133.1	17.64	158.5	22.60	169.9	25.94	174.8	27.78	179.7	28.00	185.6	28.28	190.4	28.47
	21	133.1	18.10	158.5	23.39	169.9	26.48	174.8	29.40	179.7	29.63	184.5	29.93	189.4	30.13
	23	133.1	19.43	158.5	24.61	169.9	27.86	174.8	32.44	177.4	32.70	181.8	33.02	186.7	33.25
	25	133.1	20.75	158.5	26.02	169.9	29.77	172.7	35.97	174.8	36.26	179.7	36.62	184.5	36.87
	27	133.1	22.20	158.5	27.82	167.8	31.72	169.9	39.60	172.7	39.92	177.4	40.32	181.8	40.59
	29	133.1	23.65	158.5	29.74	165.0	34.13	167.4	43.53	169.9	43.79	174.8	44.18	179.7	44.35
	31	133.1	25.24	158.0	31.32	162.3	36.30	165.0	43.34	167.4	43.60	172.1	43.99	176.9	44.17
	33	133.1	26.89	155.3	33.19	160.2	38.94	162.8	42.95	165.0	43.20	169.9	43.59	174.2	43.76
	35	133.1	28.68	152.6	34.76	157.4	42.18	160.2	42.39	162.8	42.64	167.2	43.02	172.1	43.19
	37	133.1	30.58	150.4	36.47	155.3	41.62	157.4	41.83	160.2	42.08	164.5	42.45	169.4	42.62
	39	133.1	32.56	147.7	38.39	152.6	41.06	155.3	41.27	157.4	41.52	162.3	41.89	167.2	42.05
41	129.7	34.54	141.6	40.31	146.4	40.50	148.6	40.71	151.5	40.95	156.1	41.32	160.3	41.48	
43	126.5	36.43	135.7	39.75	140.4	39.95	142.6	40.15	145.4	40.39	149.9	40.75	154.0	40.91	
46	118.6	39.00	123.8	38.91	128.3	39.11	130.3	39.31	133.0	39.54	137.2	39.90	141.0	40.05	
48	104.9	37.91	107.5	38.02	111.5	38.10	113.3	38.21	115.7	38.54	119.4	38.78	122.8	38.93	
120	10	120.5	13.29	143.2	16.29	156.5	19.36	161.3	20.92	166.1	21.26	175.1	21.34	179.4	21.51
	12	120.5	13.65	143.2	16.84	156.5	20.14	161.3	21.37	166.1	22.04	175.1	22.31	179.4	22.49
	14	120.5	14.12	143.2	17.42	156.5	20.95	161.3	22.18	166.1	22.85	175.1	23.19	179.4	23.37
	16	120.5	14.63	143.2	18.13	156.5	21.76	161.3	23.01	166.1	23.91	175.1	24.20	179.4	24.39
	18	120.5	15.20	143.2	18.94	156.5	22.63	161.3	24.22	166.1	25.13	175.1	25.42	179.4	25.62
	20	120.5	15.78	143.2	20.09	156.5	23.85	161.3	25.48	166.1	26.46	175.1	26.81	179.4	27.03
	21	120.5	16.25	143.2	20.81	156.5	24.52	161.3	26.23	166.1	27.33	175.1	27.68	179.4	27.90
	23	120.5	17.38	143.2	22.27	156.5	26.27	161.3	27.88	166.1	29.14	175.1	29.44	179.4	29.67
	25	120.5	18.57	143.2	23.85	156.5	27.71	161.3	29.72	166.1	31.25	173.0	31.51	177.2	31.76
	27	120.5	19.82	143.2	25.50	156.5	29.49	161.3	31.75	166.1	33.58	170.3	33.81	174.6	34.08
	29	120.5	21.14	143.2	27.22	156.5	31.03	161.3	33.98	163.4	35.79	167.6	36.33	172.4	36.62
	31	120.5	22.53	143.2	29.07	156.5	32.64	159.2	36.40	161.3	38.40	165.6	39.08	169.7	39.39
	33	120.5	23.98	143.2	30.99	154.4	34.53	156.5	39.51	158.6	41.22	162.9	41.69	167.1	42.03
	35	120.5	25.50	143.2	33.04	151.7	36.54	153.8	43.53	156.5	43.74	160.8	43.87	165.0	44.22
	37	120.5	27.43	143.2	34.86	149.6	38.96	151.7	42.61	153.8	42.82	158.1	42.95	162.4	43.29
	39	120.5	29.53	142.7	36.84	147.0	41.32	149.1	41.73	151.2	41.94	156.0	42.07	160.2	42.40
41	117.4	31.63	136.5	38.83	141.1	40.51	143.1	40.86	145.2	41.06	149.4	41.19	153.6	41.51	
43	114.5	33.76	130.8	38.27	135.3	39.60	137.3	39.98	139.3	40.18	143.4	40.30	147.5	40.62	
46	107.3	36.31	119.2	37.36	123.6	38.36	125.4	38.67	127.3	38.86	131.1	38.98	135.0	39.29	
48	94.9	35.56	103.5	36.70	107.4	37.61	109.0	37.84	110.7	37.96	114.1	38.11	117.5	38.26	
110	10	107.9	11.95	128.6	14.57	143.7	17.30	147.8	18.73	157.2	20.16	160.8	20.72	171.7	21.06
	12	107.9	12.33	128.6	15.06	143.7	18.02	147.8	19.26	157.2	20.91	160.8	21.59	171.7	22.09
	14	107.9	12.71	128.6	15.74	143.7	18.84	147.8	20.21	157.2	21.97	160.8	22.59	171.7	23.07
	16	107.9	13.16	128.6	16.31	143.7	19.62	147.8	21.10	157.2	22.98	160.8	23.61	171.7	24.02
	18	107.9	13.65	128.6	16.99	143.7	20.75	147.8	22.21	157.2	24.24	160.8	24.72	171.7	25.18
	20	107.9	14.14	128.6	17.84	143.7	22.00	147.8	23.24	157.2	25.42	160.8	26.05	171.7	26.46
	21	107.9	14.45	128.6	18.37	143.7	22.57	147.8	23.86	157.2	26.13	160.8	26.79	171.7	27.20
	23	107.9	15.39	128.6	19.69	143.7	23.83	147.8	25.19	157.2	27.60	160.8	28.19	171.7	28.66
	25	107.9	16.45	128.6	21.01	143.7	25.17	147.8	26.63	157.2	29.16	160.8	29.58	169.6	30.19
	27	107.9	17.58	128.6	22.46	143.7	26.60	147.8	28.18	157.2	30.46	160.8	31.15	167.1	31.68
	29	107.9	18.76	128.6	23.98	143.7	28.11	147.8	29.85	157.2	32.18	160.8	32.74	165.0	33.24
	31	107.9	19.95	128.6	25.57	143.7	29.70	147.8	31.62	154.6	33.82	158.7	34.48	162.4	34.84
	33	107.9	21.28	128.6	27.22	143.7	31.38	147.8	33.51	152.5	35.71	156.2	36.31	160.3	36.51
	35	107.9	22.60	128.6	29.07	143.7	33.15	147.8	35.51	149.9	37.69	153.5	38.04	157.7	38.23
	37	107.9	23.95	128.6	30.85	143.7	34.99	145.8	37.62	147.3	39.75	151.5	39.89	155.1	40.00
	39	107.9	25.82	128.6	32.79	141.1	36.92	143.1	40.24	145.3	41.72	148.9	41.79	153.0	41.84
41	105.1	27.69	125.3	34.72	135.0	38.93	137.2	43.53	138.9	43.53	143.0	43.87	146.6	44.22	
43	102.5	29.08	122.2	36.17	129.4	41.29	131.5	41.75	133.3	41.66	137.2	41.90	140.7	42.01	
46	96.1	28.38	114.6	34.92	118.1	39.18	120.1	39.18	121.7	39.52	125.4	39.74	128.7	39.85	
48	85.0	27.56	99.6	33.64	102.6	37.28	104.4	37.53	105.8	37.71	109.1	37.82	112.0	37.97	

# 7. Capacity Tables

Cooling Capacity (48HP)

Combination (%)	Outdoor air temp. (DB, °C)	Indoor air temp. (DB/WB, °C)													
		20		23		26		27		28		30		32	
		14		16		18		19		20		22		24	
		TC	PI	TC	PI	TC	PI	TC	PI	TC	PI	TC	PI	TC	PI
100	10	90.7	10.76	108.0	13.08	125.8	15.52	134.4	16.77	143.0	18.02	158.6	20.06	162.1	20.22
	12	90.7	11.11	108.0	13.62	125.8	16.04	134.4	17.22	143.0	18.59	158.6	21.14	162.1	21.34
	14	90.7	11.46	108.0	14.16	125.8	16.72	134.4	17.97	143.0	19.39	158.6	22.32	162.1	22.53
	16	90.7	11.80	108.0	14.63	125.8	17.44	134.4	18.82	143.0	20.44	158.6	23.40	162.1	23.72
	18	90.7	12.15	108.0	15.17	125.8	18.11	134.4	19.74	143.0	21.67	158.6	24.72	162.1	24.92
	20	90.7	12.59	108.0	15.75	125.8	19.16	134.4	21.14	143.0	23.19	158.6	25.90	162.1	26.11
	21	90.7	12.85	108.0	16.12	125.8	19.82	134.4	21.87	143.0	24.05	158.6	26.49	162.1	26.71
	23	90.7	13.61	108.0	17.24	125.8	21.28	134.4	23.46	143.0	25.77	158.6	27.74	162.1	27.96
	25	90.7	14.47	108.0	18.37	125.8	22.73	134.4	25.11	143.0	27.55	158.6	28.93	160.7	29.16
	27	90.7	15.46	108.0	19.62	125.8	24.31	134.4	26.83	143.0	29.29	155.5	30.29	158.8	30.53
	29	90.7	16.45	108.0	20.94	125.8	25.97	134.4	28.68	143.0	31.00	152.6	31.51	156.4	31.76
	31	90.7	17.58	108.0	22.33	125.8	27.68	134.4	30.59	143.0	32.58	150.3	32.73	154.0	32.99
	33	90.7	18.63	108.0	23.79	125.8	29.53	134.4	32.64	143.0	33.80	147.9	33.95	151.6	34.22
	35	90.7	19.82	108.0	25.31	125.8	31.45	134.4	34.82	140.9	35.03	145.2	35.17	148.9	35.45
	37	90.7	21.23	108.0	27.14	125.8	33.31	134.4	36.48	138.5	36.66	142.5	36.80	145.9	37.14
	39	90.7	22.76	108.0	29.16	125.8	35.30	134.4	38.26	136.2	38.43	140.2	38.57	143.5	38.93
	41	89.3	24.29	106.3	31.17	123.8	37.29	129.0	40.04	131.8	40.20	134.9	40.34	139.3	40.72
	43	86.2	25.71	102.6	33.04	119.5	39.07	123.6	41.58	125.1	41.72	128.9	41.86	132.3	42.25
46	80.8	27.65	96.2	35.62	112.0	41.44	112.9	43.53	114.1	43.65	117.8	43.78	120.9	44.19	
48	71.5	23.88	85.1	30.82	96.7	35.43	98.1	36.93	99.1	37.05	102.4	37.13	105.2	37.43	
90	10	81.6	9.93	97.4	11.94	113.3	14.07	121.0	15.16	128.6	16.32	144.5	18.27	160.3	20.22
	12	81.6	10.05	97.4	12.12	113.3	14.31	121.0	15.47	128.6	16.69	144.5	18.63	160.3	20.67
	14	81.6	10.23	97.4	12.36	113.3	14.61	121.0	15.77	128.6	16.99	144.5	18.99	160.3	21.09
	16	81.6	10.41	97.4	12.61	113.3	14.92	121.0	16.08	128.6	17.29	144.5	19.35	160.3	21.45
	18	81.6	10.60	97.4	12.85	113.3	15.16	121.0	16.44	128.6	17.66	144.5	19.77	160.3	22.53
	20	81.6	10.78	97.4	13.09	113.3	15.47	121.0	16.75	128.6	18.33	144.5	21.16	160.3	23.61
	21	81.6	10.90	97.4	13.21	113.3	15.77	121.0	17.29	128.6	19.00	144.5	21.51	160.3	24.15
	23	81.6	11.14	97.4	13.76	113.3	16.87	121.0	18.57	128.6	20.34	144.5	22.81	158.1	25.29
	25	81.6	11.69	97.4	14.68	113.3	18.02	121.0	19.85	128.6	21.74	144.5	24.39	155.8	26.37
	27	81.6	12.48	97.4	15.65	113.3	19.24	121.0	21.19	128.6	23.26	144.5	25.93	153.6	27.61
	29	81.6	13.21	97.4	16.69	113.3	20.58	121.0	22.65	128.6	24.85	144.5	27.46	151.3	28.72
	31	81.6	14.07	97.4	17.78	113.3	21.92	121.0	24.11	128.6	26.49	144.5	28.83	149.0	29.83
	33	81.6	14.98	97.4	18.94	113.3	23.38	121.0	25.70	128.6	28.09	144.5	30.23	146.7	30.94
	35	81.6	15.89	97.4	20.10	113.3	24.85	121.0	27.40	128.6	29.79	142.0	31.96	144.4	32.69
	37	81.6	16.87	97.4	21.37	113.3	26.49	121.0	29.11	128.6	31.45	139.7	33.41	142.1	34.16
	39	81.6	17.86	97.4	22.73	113.3	28.04	121.0	30.98	128.6	33.07	137.4	35.22	139.8	35.65
	41	79.5	19.98	94.9	25.20	110.4	30.77	117.9	33.88	125.3	35.70	131.7	37.12	134.0	37.97
	43	77.5	21.57	92.6	27.24	107.7	33.62	115.0	36.48	122.2	38.28	126.3	39.75	128.6	40.23
46	72.7	24.28	86.8	31.02	100.9	38.30	107.7	41.36	111.1	42.53	115.3	43.63	117.4	43.70	
48	64.3	21.22	76.8	27.13	89.2	33.51	95.3	36.09	96.5	36.65	100.2	37.13	102.1	37.43	
80	10	72.5	9.25	86.4	11.11	100.3	13.04	107.5	14.07	114.7	15.09	128.6	17.21	142.6	18.69
	12	72.5	9.44	86.4	11.24	100.3	13.30	107.5	14.32	114.7	15.35	128.6	17.54	142.6	19.06
	14	72.5	9.57	86.4	11.50	100.3	13.49	107.5	14.58	114.7	15.61	128.6	17.86	142.6	19.43
	16	72.5	9.70	86.4	11.69	100.3	13.75	107.5	14.84	114.7	15.93	128.6	18.24	142.6	19.80
	18	72.5	9.89	86.4	11.88	100.3	14.00	107.5	15.09	114.7	16.25	128.6	18.56	142.6	20.23
	20	72.5	10.08	86.4	12.14	100.3	14.32	107.5	15.42	114.7	16.57	128.6	19.27	142.6	21.43
	21	72.5	10.15	86.4	12.27	100.3	14.45	107.5	15.61	114.7	16.96	128.6	19.88	142.6	22.00
	23	72.5	10.34	86.4	12.46	100.3	15.09	107.5	16.57	114.7	18.11	128.6	20.99	142.6	23.09
	25	72.5	10.73	86.4	13.30	100.3	16.19	107.5	17.73	114.7	19.40	128.6	22.46	142.6	24.69
	27	72.5	11.37	86.4	14.13	100.3	17.28	107.5	18.95	114.7	20.68	128.6	23.87	142.6	25.98
	29	72.5	12.08	86.4	15.09	100.3	18.37	107.5	20.17	114.7	22.10	128.6	25.57	142.6	27.28
	31	72.5	12.85	86.4	15.99	100.3	19.59	107.5	21.52	114.7	23.51	128.6	27.14	142.6	28.64
	33	72.5	13.62	86.4	17.09	100.3	20.88	107.5	22.93	114.7	25.05	128.6	28.59	142.6	30.01
	35	72.5	14.45	86.4	18.11	100.3	22.22	107.5	24.41	114.7	26.72	128.6	30.32	141.1	31.71
	37	72.5	15.29	86.4	19.26	100.3	23.57	107.5	25.95	114.7	28.39	128.6	32.00	138.8	33.17
	39	72.5	16.16	86.4	20.36	100.3	25.22	107.5	27.90	114.7	30.51	128.6	33.80	136.5	34.99
	41	70.6	17.87	84.2	22.56	97.8	27.67	104.8	30.58	111.8	33.52	125.3	36.38	130.8	37.21
	43	68.9	19.67	82.1	24.62	95.3	30.21	102.2	33.33	109.0	36.64	122.2	38.96	125.4	39.83
46	64.5	21.89	76.9	27.73	89.3	34.04	95.8	37.09	102.2	41.34	111.8	43.63	114.4	43.70	
48	57.1	19.12	68.1	24.25	79.0	29.77	84.7	32.40	90.4	36.19	97.1	37.13	99.4	37.43	

# 7. Capacity Tables

Cooling Capacity (48HP)

Combination (%)	Outdoor air temp. (DB, °C)	Indoor air temp. (DB/WB, °C)													
		20		23		26		27		28		30		32	
		14		16		18		19		20		22		24	
		TC	PI	TC	PI	TC	PI	TC	PI	TC	PI	TC	PI	TC	PI
70	10	63.4	8.17	75.8	9.72	87.8	11.26	94.1	12.16	100.3	13.00	112.3	14.80	124.8	16.56
	12	63.4	8.30	75.8	9.85	87.8	11.52	94.1	12.36	100.3	13.26	112.3	15.06	124.8	16.87
	14	63.4	8.43	75.8	9.98	87.8	11.71	94.1	12.55	100.3	13.45	112.3	15.38	124.8	17.18
	16	63.4	8.56	75.8	10.17	87.8	11.91	94.1	12.81	100.3	13.71	112.3	15.64	124.8	17.55
	18	63.4	8.69	75.8	10.36	87.8	12.16	94.1	13.07	100.3	13.97	112.3	15.90	124.8	17.86
	20	63.4	8.82	75.8	10.56	87.8	12.36	94.1	13.32	100.3	14.29	112.3	16.28	124.8	18.54
	21	63.4	8.95	75.8	10.62	87.8	12.49	94.1	13.45	100.3	14.42	112.3	16.54	124.8	18.93
	23	63.4	9.08	75.8	10.88	87.8	12.74	94.1	13.90	100.3	15.13	112.3	17.70	124.8	19.99
	25	63.4	9.20	75.8	11.26	87.8	13.58	94.1	14.87	100.3	16.16	112.3	18.92	124.8	20.96
	27	63.4	9.72	75.8	12.04	87.8	14.48	94.1	15.77	100.3	17.25	112.3	20.21	124.8	22.27
	29	63.4	10.36	75.8	12.74	87.8	15.38	94.1	16.80	100.3	18.34	112.3	21.56	124.8	23.86
	31	63.4	11.01	75.8	13.58	87.8	16.41	94.1	17.96	100.3	19.57	112.3	22.98	124.8	25.32
	33	63.4	11.65	75.8	14.35	87.8	17.44	94.1	19.05	100.3	20.79	112.3	24.46	124.8	26.95
	35	63.4	12.29	75.8	15.32	87.8	18.54	94.1	20.27	100.3	22.14	112.3	26.07	124.8	28.58
	37	63.4	13.07	75.8	16.23	87.8	19.70	94.1	21.56	100.3	23.56	112.3	27.74	124.8	30.16
	39	63.4	13.87	75.8	17.30	87.8	21.06	94.1	23.20	100.3	25.45	112.3	29.69	124.8	32.52
	41	61.7	15.34	73.9	18.95	85.6	23.10	91.7	25.44	97.8	27.66	109.4	32.61	121.6	35.08
43	60.2	16.70	72.1	20.66	83.5	25.21	89.4	27.75	95.3	30.21	106.7	35.62	118.6	37.93	
46	56.4	18.55	67.5	23.23	78.2	28.38	83.8	30.90	89.3	34.05	100.0	40.18	111.1	42.27	
48	49.9	16.19	59.7	20.29	69.2	24.82	74.1	27.01	79.0	29.79	88.5	35.16	98.3	36.59	
60	10	54.2	7.09	64.8	8.32	75.4	9.67	80.6	10.38	85.9	11.03	96.5	12.51	107.0	14.00
	12	54.2	7.22	64.8	8.45	75.4	9.80	80.6	10.51	85.9	11.22	96.5	12.71	107.0	14.25
	14	54.2	7.29	64.8	8.58	75.4	10.00	80.6	10.71	85.9	11.42	96.5	12.96	107.0	14.51
	16	54.2	7.42	64.8	8.77	75.4	10.13	80.6	10.90	85.9	11.67	96.5	13.22	107.0	14.77
	18	54.2	7.55	64.8	8.90	75.4	10.32	80.6	11.09	85.9	11.87	96.5	13.41	107.0	15.09
	20	54.2	7.67	64.8	9.03	75.4	10.51	80.6	11.29	85.9	12.06	96.5	13.67	107.0	15.41
	21	54.2	7.74	64.8	9.09	75.4	10.64	80.6	11.42	85.9	12.19	96.5	13.87	107.0	15.54
	23	54.2	7.87	64.8	9.29	75.4	10.77	80.6	11.61	85.9	12.45	96.5	14.38	107.0	16.51
	25	54.2	8.00	64.8	9.48	75.4	11.22	80.6	12.19	85.9	13.22	96.5	15.35	107.0	17.67
	27	54.2	8.26	64.8	10.00	75.4	11.93	80.6	12.96	85.9	14.06	96.5	16.32	107.0	18.83
	29	54.2	8.77	64.8	10.64	75.4	12.71	80.6	13.80	85.9	14.96	96.5	17.41	107.0	20.12
	31	54.2	9.29	64.8	11.29	75.4	13.48	80.6	14.70	85.9	15.93	96.5	18.57	107.0	21.41
	33	54.2	9.80	64.8	11.93	75.4	14.32	80.6	15.61	85.9	16.96	96.5	19.74	107.0	22.83
	35	54.2	10.38	64.8	12.71	75.4	15.22	80.6	16.58	85.9	17.99	96.5	21.03	107.0	24.25
	37	54.2	10.96	64.8	13.41	75.4	16.12	80.6	17.61	85.9	19.09	96.5	22.32	107.0	25.80
	39	54.2	11.66	64.8	14.28	75.4	17.40	80.6	18.89	85.9	20.54	96.5	23.93	107.0	27.64
	41	52.9	12.65	63.1	15.62	73.4	18.90	78.6	20.64	83.7	22.30	94.0	26.26	104.3	30.04
43	51.5	13.74	61.6	17.01	71.6	20.60	76.6	22.49	81.7	24.32	91.7	28.66	101.7	32.81	
46	48.3	15.39	57.7	19.10	67.1	23.17	71.8	25.28	76.5	27.36	85.9	32.30	95.3	37.38	
48	42.7	13.41	51.1	16.67	59.4	20.24	63.5	22.08	67.7	23.91	76.0	28.25	84.3	32.71	
50	10	45.4	6.14	54.2	7.11	62.9	8.08	67.2	8.66	71.5	9.18	80.2	10.34	89.3	11.50
	12	45.4	6.20	54.2	7.17	62.9	8.21	67.2	8.79	71.5	9.37	80.2	10.53	89.3	11.70
	14	45.4	6.27	54.2	7.30	62.9	8.34	67.2	8.92	71.5	9.50	80.2	10.66	89.3	11.89
	16	45.4	6.40	54.2	7.43	62.9	8.47	67.2	9.11	71.5	9.63	80.2	10.86	89.3	12.09
	18	45.4	6.46	54.2	7.50	62.9	8.60	67.2	9.24	71.5	9.82	80.2	11.05	89.3	12.34
	20	45.4	6.53	54.2	7.63	62.9	8.79	67.2	9.37	71.5	10.02	80.2	11.24	89.3	12.60
	21	45.4	6.59	54.2	7.69	62.9	8.85	67.2	9.50	71.5	10.08	80.2	11.37	89.3	12.73
	23	45.4	6.72	54.2	7.82	62.9	8.98	67.2	9.63	71.5	10.28	80.2	11.57	89.3	12.99
	25	45.4	6.79	54.2	7.95	62.9	9.18	67.2	9.82	71.5	10.60	80.2	12.15	89.3	13.89
	27	45.4	6.91	54.2	8.21	62.9	9.69	67.2	10.47	71.5	11.24	80.2	12.99	89.3	14.80
	29	45.4	7.30	54.2	8.72	62.9	10.28	67.2	11.12	71.5	11.96	80.2	13.77	89.3	15.70
	31	45.4	7.69	54.2	9.24	62.9	10.92	67.2	11.76	71.5	12.73	80.2	14.67	89.3	16.74
	33	45.4	8.14	54.2	9.76	62.9	11.57	67.2	12.47	71.5	13.51	80.2	15.57	89.3	17.84
	35	45.4	8.60	54.2	10.34	62.9	12.21	67.2	13.25	71.5	14.28	80.2	16.48	89.3	18.94
	37	45.4	9.11	54.2	10.92	62.9	12.93	67.2	14.02	71.5	15.12	80.2	17.58	89.3	20.10
	39	45.4	9.72	54.2	11.71	62.9	13.85	67.2	15.10	71.5	16.23	80.2	18.72	89.3	21.71
	41	44.2	10.51	52.9	12.67	61.3	15.14	65.5	16.35	69.7	17.58	78.1	20.52	87.0	23.57
43	43.1	11.42	51.5	13.79	59.8	16.48	63.9	17.80	68.0	19.14	76.2	22.38	84.8	25.72	
46	40.4	12.79	48.3	15.46	56.0	18.48	59.8	19.99	63.7	21.49	71.4	25.18	79.5	28.95	
48	35.7	11.15	42.7	13.48	49.5	16.12	52.9	17.45	56.3	18.75	63.2	22.00	70.3	25.31	

**Note**

1. TC: Total Capacity(kW), PI : Power Input(kW, Comp. + Outdoor fan motor)
2. Capacity tables show the average value of conditions which may occur.

# 7. Capacity Tables

◆ ARUM500LTE5

Cooling Capacity (50HP)

Combination (%)	Outdoor air temp. (DB, °C)	Indoor air temp. (DB/WB, °C)													
		20		23		26		27		28		30		32	
		14	16	16	18	18	19	20	20	22	22	24	24		
		TC	PI	TC	PI	TC	PI	TC	PI	TC	PI	TC	PI	TC	PI
130	10	138.7	14.33	165.1	17.52	177.0	20.32	182.1	20.74	187.1	20.90	196.2	21.07	201.2	21.15
	12	138.7	14.69	165.1	18.14	177.0	21.16	182.1	21.29	187.1	21.47	196.2	21.64	201.2	21.83
	14	138.7	15.18	165.1	18.80	177.0	21.95	182.1	22.11	187.1	22.29	196.2	22.47	201.2	22.67
	16	138.7	15.73	165.1	19.46	177.0	22.94	182.1	23.15	187.1	23.34	196.2	23.54	201.2	23.73
	18	138.7	16.40	165.1	20.58	177.0	23.99	182.1	24.51	187.1	24.70	196.2	24.95	201.2	25.12
	20	138.7	17.12	165.1	21.93	177.0	25.17	182.1	26.96	187.1	27.17	193.3	27.44	198.4	27.63
	21	138.7	17.57	165.1	22.70	177.0	25.70	182.1	28.53	187.1	28.76	192.2	29.04	197.3	29.24
	23	138.7	18.85	165.1	23.88	177.0	27.04	182.1	31.48	184.8	31.73	189.4	32.05	194.5	32.27
	25	138.7	20.13	165.1	25.25	177.0	28.89	179.9	34.91	182.1	35.19	187.1	35.54	192.2	35.78
	27	138.7	21.54	165.1	26.99	174.8	30.78	177.0	38.43	179.9	38.74	184.8	39.12	189.4	39.39
	29	138.7	22.95	165.1	28.86	171.9	33.12	174.4	42.24	177.0	42.49	182.1	42.87	187.1	43.04
	31	138.7	24.49	164.6	30.40	169.1	35.23	171.9	42.06	174.4	42.31	179.2	42.69	184.3	42.86
	33	138.7	26.10	161.8	32.21	166.8	37.78	169.5	41.68	171.9	41.93	177.0	42.30	181.5	42.47
	35	138.7	27.83	158.9	33.73	164.0	40.93	166.8	41.13	169.5	41.38	174.1	41.75	179.2	41.91
	37	138.7	29.67	156.7	35.40	161.8	40.39	164.0	40.59	166.8	40.83	171.4	41.20	176.4	41.36
	39	138.7	31.60	153.9	37.26	158.9	39.85	161.8	40.05	164.0	40.29	169.1	40.65	174.1	40.81
41	135.1	33.52	147.5	39.12	152.5	39.31	154.8	39.50	157.8	39.74	162.6	40.10	167.0	40.25	
43	131.8	35.35	141.4	38.57	146.3	38.77	148.5	38.96	151.5	39.19	156.1	39.54	160.4	39.70	
46	123.5	37.84	129.0	37.76	133.6	37.95	135.7	38.15	138.5	38.37	142.9	38.72	146.8	38.87	
48	109.2	36.79	112.0	36.90	116.2	36.98	118.0	37.08	120.6	37.40	124.4	37.63	127.9	37.78	
120	10	125.5	12.89	149.2	15.81	163.0	18.79	168.0	20.30	173.0	20.63	182.4	20.71	186.8	20.87
	12	125.5	13.24	149.2	16.34	163.0	19.54	168.0	20.73	173.0	21.39	182.4	21.65	186.8	21.82
	14	125.5	13.70	149.2	16.90	163.0	20.33	168.0	21.52	173.0	22.17	182.4	22.50	186.8	22.68
	16	125.5	14.19	149.2	17.59	163.0	21.12	168.0	22.33	173.0	23.20	182.4	23.48	186.8	23.67
	18	125.5	14.75	149.2	18.38	163.0	21.96	168.0	23.50	173.0	24.39	182.4	24.67	186.8	24.86
	20	125.5	15.31	149.2	19.49	163.0	23.15	168.0	24.73	173.0	25.68	182.4	26.02	186.8	26.23
	21	125.5	15.77	149.2	20.20	163.0	23.80	168.0	25.46	173.0	26.53	182.4	26.86	186.8	27.08
	23	125.5	16.86	149.2	21.61	163.0	25.50	168.0	27.05	173.0	28.28	182.4	28.57	186.8	28.79
	25	125.5	18.02	149.2	23.15	163.0	26.89	168.0	28.84	173.0	30.33	180.2	30.58	184.6	30.82
	27	125.5	19.24	149.2	24.75	163.0	28.62	168.0	30.81	173.0	32.59	177.4	32.81	181.9	33.07
	29	125.5	20.52	149.2	26.42	163.0	30.11	168.0	32.97	170.2	34.73	174.6	35.26	179.6	35.54
	31	125.5	21.86	149.2	28.21	163.0	31.67	165.8	35.32	168.0	37.26	172.4	37.92	176.8	38.22
	33	125.5	23.27	149.2	30.07	160.9	33.50	163.0	38.34	165.2	40.00	169.7	40.46	174.1	40.78
	35	125.5	24.75	149.2	32.06	158.1	35.46	160.3	42.24	163.0	42.45	167.5	42.58	171.9	42.91
	37	125.5	26.62	149.2	33.83	155.8	37.81	158.1	41.35	160.3	41.56	164.7	41.68	169.1	42.01
	39	125.5	28.66	148.7	35.75	153.1	40.10	155.3	40.50	157.5	40.70	162.5	40.82	166.9	41.15
41	122.3	30.70	142.2	37.68	147.0	39.31	149.1	39.65	151.2	39.85	155.6	39.97	160.0	40.29	
43	119.2	32.76	136.2	37.14	140.9	38.43	143.0	38.80	145.1	39.00	149.4	39.11	153.7	39.42	
46	111.7	35.23	124.2	36.25	128.7	37.22	130.6	37.53	132.6	37.71	136.6	37.83	140.6	38.13	
48	98.9	34.51	107.8	35.61	111.9	36.49	113.6	36.72	115.3	36.83	118.9	36.98	122.4	37.13	
110	10	112.4	11.60	134.0	14.14	149.7	16.79	154.0	18.18	163.7	19.56	167.5	20.11	178.8	20.44
	12	112.4	11.96	134.0	14.61	149.7	17.49	154.0	18.69	163.7	20.30	167.5	20.95	178.8	21.43
	14	112.4	12.33	134.0	15.27	149.7	18.28	154.0	19.61	163.7	21.32	167.5	21.93	178.8	22.39
	16	112.4	12.77	134.0	15.83	149.7	19.04	154.0	20.47	163.7	22.30	167.5	22.91	178.8	23.31
	18	112.4	13.25	134.0	16.49	149.7	20.13	154.0	21.56	163.7	23.52	167.5	23.99	178.8	24.44
	20	112.4	13.72	134.0	17.31	149.7	21.35	154.0	22.55	163.7	24.67	167.5	25.27	178.8	25.68
	21	112.4	14.02	134.0	17.82	149.7	21.90	154.0	23.15	163.7	25.35	167.5	25.99	178.8	26.40
	23	112.4	14.94	134.0	19.11	149.7	23.12	154.0	24.44	163.7	26.79	167.5	27.36	178.8	27.81
	25	112.4	15.97	134.0	20.39	149.7	24.43	154.0	25.84	163.7	28.30	167.5	28.70	176.7	29.29
	27	112.4	17.06	134.0	21.80	149.7	25.81	154.0	27.35	163.7	29.56	167.5	30.23	174.0	30.75
	29	112.4	18.21	134.0	23.27	149.7	27.28	154.0	28.96	163.7	31.23	167.5	31.77	171.9	32.25
	31	112.4	19.36	134.0	24.81	149.7	28.83	154.0	30.69	161.0	32.82	165.3	33.46	169.2	33.81
	33	112.4	20.65	134.0	26.42	149.7	30.45	154.0	32.52	158.8	34.66	162.7	35.23	166.9	35.43
	35	112.4	21.93	134.0	28.21	149.7	32.16	154.0	34.46	156.2	36.58	159.9	36.92	164.3	37.10
	37	112.4	23.24	134.0	29.94	149.7	33.96	151.8	36.51	153.5	38.58	157.8	38.71	161.6	38.82
	39	112.4	25.06	134.0	31.82	147.0	35.83	149.1	39.05	151.3	40.49	155.1	40.56	159.4	40.60
41	109.5	26.87	130.6	33.69	140.7	37.78	142.9	42.24	144.7	42.24	149.0	42.58	152.7	42.91	
43	106.8	28.22	127.3	35.10	134.8	40.06	137.0	40.52	138.8	40.43	142.9	40.66	146.6	40.77	
46	100.1	27.54	119.3	33.89	123.0	38.02	125.2	38.02	126.8	38.35	130.7	38.56	134.0	38.67	
48	88.6	26.75	103.7	32.65	106.8	36.18	108.8	36.42	110.2	36.59	113.6	36.70	116.6	36.84	

# 7. Capacity Tables

Cooling Capacity (50HP)

Combination (%)	Outdoor air temp. (DB, °C)	Indoor air temp. (DB/WB, °C)													
		20		23		26		27		28		30		32	
		14		16		18		19		20		22		24	
		TC	PI	TC	PI	TC	PI	TC	PI	TC	PI	TC	PI	TC	PI
100	10	94.5	10.44	112.5	12.70	131.0	15.06	140.0	16.27	149.0	17.48	165.2	19.46	168.8	19.62
	12	94.5	10.78	112.5	13.21	131.0	15.57	140.0	16.71	149.0	18.04	165.2	20.51	168.8	20.71
	14	94.5	11.12	112.5	13.74	131.0	16.23	140.0	17.43	149.0	18.82	165.2	21.66	168.8	21.86
	16	94.5	11.45	112.5	14.20	131.0	16.92	140.0	18.26	149.0	19.83	165.2	22.70	168.8	23.02
	18	94.5	11.79	112.5	14.72	131.0	17.57	140.0	19.15	149.0	21.03	165.2	23.99	168.8	24.18
	20	94.5	12.22	112.5	15.28	131.0	18.59	140.0	20.52	149.0	22.51	165.2	25.14	168.8	25.34
	21	94.5	12.47	112.5	15.64	131.0	19.24	140.0	21.22	149.0	23.34	165.2	25.71	168.8	25.92
	23	94.5	13.21	112.5	16.73	131.0	20.65	140.0	22.76	149.0	25.01	165.2	26.92	168.8	27.14
	25	94.5	14.04	112.5	17.82	131.0	22.06	140.0	24.36	149.0	26.74	165.2	28.07	167.4	28.30
	27	94.5	15.00	112.5	19.04	131.0	23.60	140.0	26.03	149.0	28.43	162.0	29.39	165.4	29.63
	29	94.5	15.97	112.5	20.33	131.0	25.20	140.0	27.83	149.0	30.09	159.0	30.57	162.9	30.82
	31	94.5	17.06	112.5	21.67	131.0	26.87	140.0	29.69	149.0	31.61	156.6	31.76	160.4	32.01
	33	94.5	18.08	112.5	23.08	131.0	28.66	140.0	31.67	149.0	32.80	154.1	32.94	157.9	33.21
	35	94.5	19.24	112.5	24.56	131.0	30.52	140.0	33.79	146.7	33.99	151.3	34.13	155.1	34.40
	37	94.5	20.60	112.5	26.34	131.0	32.33	140.0	35.40	144.3	35.57	148.5	35.72	152.0	36.05
	39	94.5	22.09	112.5	28.29	131.0	34.26	140.0	37.13	141.9	37.29	146.1	37.43	149.5	37.78
	41	93.0	23.57	110.7	30.25	128.9	36.19	134.3	38.86	137.3	39.01	140.5	39.15	145.1	39.52
	43	89.8	24.95	106.9	32.07	124.5	37.92	128.8	40.35	130.3	40.49	134.3	40.62	137.8	41.00
46	84.2	26.83	100.2	34.57	116.7	40.22	117.6	42.24	118.9	42.36	127.7	42.49	126.0	42.89	
48	74.4	23.17	88.6	29.91	100.7	34.38	102.2	35.84	103.3	35.95	106.7	36.04	109.6	36.32	
90	10	85.0	9.69	101.5	11.65	118.0	13.73	126.0	14.80	134.0	15.93	150.5	17.83	167.0	19.62
	12	85.0	9.81	101.5	11.83	118.0	13.97	126.0	15.10	134.0	16.29	150.5	18.18	167.0	20.18
	14	85.0	9.99	101.5	12.07	118.0	14.27	126.0	15.40	134.0	16.58	150.5	18.54	167.0	20.59
	16	85.0	10.16	101.5	12.30	118.0	14.56	126.0	15.69	134.0	16.88	150.5	18.89	167.0	20.94
	18	85.0	10.34	101.5	12.54	118.0	14.80	126.0	16.05	134.0	17.24	150.5	19.30	167.0	21.99
	20	85.0	10.52	101.5	12.78	118.0	15.10	126.0	16.35	134.0	17.89	150.5	20.66	167.0	23.05
	21	85.0	10.64	101.5	12.90	118.0	15.40	126.0	16.88	134.0	18.55	150.5	20.99	167.0	23.57
	23	85.0	10.88	101.5	13.43	118.0	16.47	126.0	18.13	134.0	19.85	150.5	22.26	164.7	24.69
	25	85.0	11.41	101.5	14.33	118.0	17.60	126.0	19.38	134.0	21.22	150.5	23.80	162.3	25.74
	27	85.0	12.19	101.5	15.28	118.0	18.78	126.0	20.69	134.0	22.71	150.5	25.31	160.0	26.95
	29	85.0	12.90	101.5	16.29	118.0	20.09	126.0	22.11	134.0	24.25	150.5	26.81	157.6	28.03
	31	85.0	13.73	101.5	17.36	118.0	21.40	126.0	23.54	134.0	25.86	150.5	28.15	155.2	29.12
	33	85.0	14.62	101.5	18.49	118.0	22.83	126.0	25.09	134.0	27.43	150.5	29.51	152.8	30.20
	35	85.0	15.51	101.5	19.62	118.0	24.25	126.0	26.75	134.0	29.08	147.9	31.20	150.4	31.92
	37	85.0	16.47	101.5	20.86	118.0	25.86	126.0	28.42	134.0	30.70	145.5	32.61	148.1	33.35
	39	85.0	17.43	101.5	22.19	118.0	27.37	126.0	30.24	134.0	32.28	143.2	34.38	145.7	34.80
	41	82.8	19.51	98.9	24.60	115.0	30.04	122.8	33.07	130.6	34.85	137.2	36.24	139.6	37.07
	43	80.8	21.06	96.5	26.59	112.1	32.81	119.7	35.61	127.3	37.37	131.5	38.80	133.9	39.27
46	75.7	23.70	90.4	30.28	105.1	37.39	112.2	40.38	115.7	41.52	120.1	42.41	122.3	42.63	
48	67.0	20.71	80.0	26.49	93.0	32.71	99.3	35.23	100.5	35.75	104.3	36.04	106.3	36.32	
80	10	75.5	9.04	90.0	10.86	104.5	12.74	112.0	13.75	119.5	14.75	134.0	16.82	148.5	18.26
	12	75.5	9.23	90.0	10.98	104.5	12.99	112.0	14.00	119.5	15.00	134.0	17.14	148.5	18.62
	14	75.5	9.35	90.0	11.24	104.5	13.18	112.0	14.25	119.5	15.25	134.0	17.45	148.5	18.99
	16	75.5	9.48	90.0	11.42	104.5	13.43	112.0	14.50	119.5	15.57	134.0	17.83	148.5	19.35
	18	75.5	9.67	90.0	11.61	104.5	13.68	112.0	14.75	119.5	15.88	134.0	18.14	148.5	19.77
	20	75.5	9.85	90.0	11.86	104.5	14.00	112.0	15.06	119.5	16.19	134.0	18.83	148.5	20.94
	21	75.5	9.92	90.0	11.99	104.5	14.12	112.0	15.25	119.5	16.57	134.0	19.42	148.5	21.50
	23	75.5	10.11	90.0	12.18	104.5	14.75	112.0	16.19	119.5	17.70	134.0	20.51	148.5	22.57
	25	75.5	10.48	90.0	12.99	104.5	15.82	112.0	17.32	119.5	18.96	134.0	21.95	148.5	24.13
	27	75.5	11.11	90.0	13.81	104.5	16.88	112.0	18.52	119.5	20.21	134.0	23.32	148.5	25.39
	29	75.5	11.80	90.0	14.75	104.5	17.95	112.0	19.71	119.5	21.59	134.0	24.99	148.5	26.63
	31	75.5	12.55	90.0	15.63	104.5	19.14	112.0	21.03	119.5	22.97	134.0	26.52	148.5	27.95
	33	75.5	13.31	90.0	16.70	104.5	20.40	112.0	22.41	119.5	24.48	134.0	27.94	148.5	29.30
	35	75.5	14.12	90.0	17.70	104.5	21.72	112.0	23.85	119.5	26.11	134.0	29.62	146.9	30.96
	37	75.5	14.94	90.0	18.82	104.5	23.04	112.0	25.36	119.5	27.74	134.0	31.27	144.6	32.41
	39	75.5	15.79	90.0	19.90	104.5	24.64	112.0	27.26	119.5	29.81	134.0	33.03	142.2	34.19
	41	73.6	17.46	87.7	22.05	101.8	27.04	109.1	29.88	116.4	32.76	130.6	35.51	136.2	36.33
	43	71.7	19.23	85.5	24.06	99.3	29.52	106.4	32.57	113.6	35.80	127.3	38.03	130.6	38.88
46	67.2	21.39	80.2	27.10	93.1	33.26	99.7	36.25	106.4	40.40	116.5	42.41	119.2	42.63	
48	59.5	18.68	70.9	23.70	82.3	29.09	88.2	31.66	94.1	35.36	101.1	36.04	103.6	36.32	

# 7. Capacity Tables

Cooling Capacity (50HP)

Combination (%)	Outdoor air temp. (DB, °C)	Indoor air temp. (DB/WB, °C)													
		20		23		26		27		28		30		32	
		14		16		18		19		20		22		24	
		TC	PI	TC	PI	TC	PI	TC	PI	TC	PI	TC	PI	TC	PI
70	10	66.0	8.00	79.0	9.51	91.5	11.02	98.0	11.90	104.5	12.72	117.0	14.48	130.0	16.20
	12	66.0	8.12	79.0	9.63	91.5	11.27	98.0	12.09	104.5	12.97	117.0	14.73	130.0	16.50
	14	66.0	8.25	79.0	9.76	91.5	11.46	98.0	12.28	104.5	13.16	117.0	15.05	130.0	16.80
	16	66.0	8.37	79.0	9.95	91.5	11.65	98.0	12.53	104.5	13.41	117.0	15.30	130.0	17.17
	18	66.0	8.50	79.0	10.14	91.5	11.90	98.0	12.78	104.5	13.66	117.0	15.55	130.0	17.47
	20	66.0	8.63	79.0	10.33	91.5	12.09	98.0	13.03	104.5	13.98	117.0	15.93	130.0	18.13
	21	66.0	8.75	79.0	10.39	91.5	12.21	98.0	13.16	104.5	14.10	117.0	16.18	130.0	18.52
	23	66.0	8.88	79.0	10.64	91.5	12.47	98.0	13.60	104.5	14.80	117.0	17.31	130.0	19.55
	25	66.0	9.00	79.0	11.02	91.5	13.28	98.0	14.54	104.5	15.80	117.0	18.51	130.0	20.50
	27	66.0	9.51	79.0	11.77	91.5	14.17	98.0	15.43	104.5	16.87	117.0	19.77	130.0	21.78
	29	66.0	10.14	79.0	12.47	91.5	15.05	98.0	16.43	104.5	17.94	117.0	21.09	130.0	23.34
	31	66.0	10.77	79.0	13.28	91.5	16.05	98.0	17.57	104.5	19.14	117.0	22.48	130.0	24.77
	33	66.0	11.40	79.0	14.04	91.5	17.06	98.0	18.64	104.5	20.34	117.0	23.92	130.0	26.37
	35	66.0	12.03	79.0	14.99	91.5	18.13	98.0	19.83	104.5	21.66	117.0	25.50	130.0	27.96
	37	66.0	12.78	79.0	15.87	91.5	19.27	98.0	21.09	104.5	23.04	117.0	27.14	130.0	29.50
	39	66.0	13.57	79.0	16.92	91.5	20.60	98.0	22.69	104.5	24.89	117.0	29.04	130.0	31.81
41	64.3	15.00	77.0	18.54	89.2	22.60	95.5	24.89	101.8	27.06	114.0	31.90	126.7	34.31	
43	62.7	16.33	75.1	20.21	87.0	24.66	93.1	27.14	99.3	29.55	111.2	34.85	123.5	37.10	
46	58.8	18.15	70.4	22.72	81.5	27.76	87.3	30.23	93.1	33.31	104.2	39.30	115.8	41.35	
48	52.0	15.84	62.2	19.85	72.1	24.27	77.2	26.42	82.3	29.14	92.2	34.39	102.4	35.79	
60	10	56.5	6.95	67.5	8.15	78.5	9.47	84.0	10.17	89.5	10.80	100.5	12.25	111.5	13.70
	12	56.5	7.07	67.5	8.27	78.5	9.60	84.0	10.29	89.5	10.99	100.5	12.44	111.5	13.96
	14	56.5	7.14	67.5	8.40	78.5	9.79	84.0	10.48	89.5	11.18	100.5	12.69	111.5	14.21
	16	56.5	7.26	67.5	8.59	78.5	9.91	84.0	10.67	89.5	11.43	100.5	12.95	111.5	14.46
	18	56.5	7.39	67.5	8.72	78.5	10.10	84.0	10.86	89.5	11.62	100.5	13.14	111.5	14.78
	20	56.5	7.52	67.5	8.84	78.5	10.29	84.0	11.05	89.5	11.81	100.5	13.39	111.5	15.09
	21	56.5	7.58	67.5	8.90	78.5	10.42	84.0	11.18	89.5	11.94	100.5	13.58	111.5	15.22
	23	56.5	7.70	67.5	9.09	78.5	10.55	84.0	11.37	89.5	12.19	100.5	14.08	111.5	16.17
	25	56.5	7.83	67.5	9.28	78.5	10.99	84.0	11.94	89.5	12.95	100.5	15.03	111.5	17.30
	27	56.5	8.08	67.5	9.79	78.5	11.68	84.0	12.69	89.5	13.77	100.5	15.98	111.5	18.44
	29	56.5	8.59	67.5	10.42	78.5	12.44	84.0	13.51	89.5	14.65	100.5	17.05	111.5	19.70
	31	56.5	9.09	67.5	11.05	78.5	13.20	84.0	14.40	89.5	15.60	100.5	18.19	111.5	20.97
	33	56.5	9.60	67.5	11.68	78.5	14.02	84.0	15.28	89.5	16.61	100.5	19.32	111.5	22.36
	35	56.5	10.17	67.5	12.44	78.5	14.90	84.0	16.23	89.5	17.62	100.5	20.59	111.5	23.75
	37	56.5	10.74	67.5	13.13	78.5	15.79	84.0	17.24	89.5	18.69	100.5	21.85	111.5	25.26
	39	56.5	11.42	67.5	13.98	78.5	17.04	84.0	18.50	89.5	20.12	100.5	23.43	111.5	27.07
41	55.1	12.38	65.8	15.30	76.5	18.51	81.9	20.21	87.2	21.84	97.9	25.71	108.6	29.42	
43	53.7	13.46	64.1	16.66	74.6	20.17	79.8	22.02	85.1	23.81	95.5	28.07	106.0	32.13	
46	50.3	15.07	60.1	18.70	69.9	22.69	74.8	24.75	79.7	26.79	89.5	31.63	99.3	36.61	
48	44.5	13.13	53.2	16.32	61.8	19.82	66.2	21.62	70.5	23.42	79.2	27.66	87.8	32.03	
50	10	47.3	6.02	56.5	6.97	65.5	7.92	70.0	8.49	74.5	9.00	83.5	10.14	93.0	11.28
	12	47.3	6.08	56.5	7.03	65.5	8.04	70.0	8.62	74.5	9.19	83.5	10.33	93.0	11.47
	14	47.3	6.14	56.5	7.16	65.5	8.17	70.0	8.74	74.5	9.31	83.5	10.45	93.0	11.66
	16	47.3	6.27	56.5	7.28	65.5	8.30	70.0	8.93	74.5	9.44	83.5	10.64	93.0	11.85
	18	47.3	6.33	56.5	7.35	65.5	8.43	70.0	9.06	74.5	9.63	83.5	10.83	93.0	12.10
	20	47.3	6.40	56.5	7.47	65.5	8.62	70.0	9.19	74.5	9.82	83.5	11.02	93.0	12.35
	21	47.3	6.46	56.5	7.54	65.5	8.68	70.0	9.31	74.5	9.88	83.5	11.15	93.0	12.48
	23	47.3	6.59	56.5	7.66	65.5	8.81	70.0	9.44	74.5	10.07	83.5	11.34	93.0	12.73
	25	47.3	6.65	56.5	7.79	65.5	9.00	70.0	9.63	74.5	10.39	83.5	11.91	93.0	13.62
	27	47.3	6.78	56.5	8.04	65.5	9.50	70.0	10.26	74.5	11.02	83.5	12.73	93.0	14.51
	29	47.3	7.16	56.5	8.55	65.5	10.07	70.0	10.90	74.5	11.72	83.5	13.49	93.0	15.39
	31	47.3	7.54	56.5	9.06	65.5	10.71	70.0	11.53	74.5	12.48	83.5	14.38	93.0	16.41
	33	47.3	7.98	56.5	9.57	65.5	11.34	70.0	12.23	74.5	13.24	83.5	15.27	93.0	17.48
	35	47.3	8.43	56.5	10.14	65.5	11.97	70.0	12.99	74.5	14.00	83.5	16.15	93.0	18.56
	37	47.3	8.93	56.5	10.71	65.5	12.67	70.0	13.75	74.5	14.82	83.5	17.23	93.0	19.70
	39	47.3	9.53	56.5	11.48	65.5	13.57	70.0	14.80	74.5	15.91	83.5	18.35	93.0	21.28
41	46.0	10.30	55.1	12.42	63.8	14.84	68.2	16.03	72.6	17.23	81.4	20.12	90.6	23.11	
43	44.9	11.20	53.7	13.51	62.2	16.15	66.5	17.45	70.8	18.76	79.4	21.94	88.4	25.21	
46	42.1	12.54	50.3	15.15	58.3	18.12	62.3	19.60	66.3	21.06	74.4	24.68	82.8	28.38	
48	37.2	10.93	44.5	13.22	51.6	15.80	55.1	17.10	58.7	18.38	65.8	21.57	73.3	24.81	

**Note**

1. TC: Total Capacity(kW), PI : Power Input(kW, Comp. + Outdoor fan motor)
2. Capacity tables show the average value of conditions which may occur.

# 7. Capacity Tables

◆ ARUM520LTE5

Cooling Capacity (52HP)

Combination (%)	Outdoor air temp. (DB, °C)	Indoor air temp. (DB/WB, °C)													
		20		23		26		27		28		30		32	
		14	16	16	18	19	20	22	24						
130	10	144.2	15.28	171.7	18.68	184.1	21.66	189.3	22.10	194.6	22.28	204.0	22.46	209.3	22.55
	12	144.2	15.66	171.7	19.34	184.1	22.55	189.3	22.70	194.6	22.88	204.0	23.06	209.3	23.27
	14	144.2	16.18	171.7	20.04	184.1	23.40	189.3	23.57	194.6	23.76	204.0	23.95	209.3	24.16
	16	144.2	16.77	171.7	20.74	184.1	24.45	189.3	24.68	194.6	24.88	204.0	25.10	209.3	25.29
	18	144.2	17.48	171.7	21.94	184.1	25.57	189.3	26.12	194.6	26.33	204.0	26.59	209.3	26.78
	20	144.2	18.25	171.7	23.38	184.1	26.83	189.3	28.74	194.6	28.97	201.0	29.25	206.3	29.46
	21	144.2	18.73	171.7	24.20	184.1	27.40	189.3	30.41	194.6	30.65	199.9	30.96	205.2	31.17
	23	144.2	20.09	171.7	25.45	184.1	28.82	189.3	33.56	192.2	33.82	197.0	34.16	202.2	34.39
	25	144.2	21.46	171.7	26.92	184.1	30.80	187.1	37.21	189.3	37.51	194.6	37.88	199.9	38.14
	27	144.2	22.97	171.7	28.77	181.7	32.81	184.1	40.97	187.1	41.30	192.2	41.71	197.0	41.99
	29	144.2	24.47	171.7	30.76	178.8	35.31	181.4	45.03	184.1	45.30	189.3	45.70	194.6	45.88
	31	144.2	26.11	171.2	32.40	175.8	37.55	178.8	44.84	181.4	45.11	186.4	45.51	191.7	45.69
	33	144.2	27.82	168.2	34.33	173.5	40.28	176.3	44.43	178.8	44.69	184.1	45.09	188.7	45.27
	35	144.2	29.66	165.3	35.96	170.5	43.63	173.5	43.85	176.3	44.11	181.1	44.51	186.4	44.68
	37	144.2	31.63	162.9	37.73	168.2	43.05	170.5	43.27	173.5	43.53	178.2	43.92	183.5	44.09
	39	144.2	33.68	160.1	39.72	165.3	42.48	168.2	42.69	170.5	42.95	175.8	43.33	181.1	43.50
41	140.5	35.73	153.4	41.70	158.6	41.90	161.0	42.11	164.1	42.36	169.1	42.74	173.6	42.91	
43	137.0	37.69	147.0	41.12	152.1	41.32	154.4	41.53	157.5	41.78	162.4	42.15	166.8	42.32	
46	128.4	40.34	134.1	40.26	139.0	40.46	141.1	40.66	144.1	40.91	148.6	41.27	152.7	41.44	
48	113.6	39.21	116.5	39.33	120.8	39.42	122.8	39.52	125.4	39.86	129.4	40.12	133.0	40.27	
120	10	130.5	13.75	155.2	16.86	169.6	20.03	174.7	21.64	179.9	21.99	189.7	22.08	194.3	22.25
	12	130.5	14.12	155.2	17.42	169.6	20.83	174.7	22.10	179.9	22.80	189.7	23.08	194.3	23.26
	14	130.5	14.60	155.2	18.02	169.6	21.68	174.7	22.94	179.9	23.64	189.7	23.99	194.3	24.18
	16	130.5	15.13	155.2	18.75	169.6	22.51	174.7	23.80	179.9	24.73	189.7	25.03	194.3	25.23
	18	130.5	15.72	155.2	19.60	169.6	23.41	174.7	25.05	179.9	26.00	189.7	26.29	194.3	26.50
	20	130.5	16.32	155.2	20.78	169.6	24.67	174.7	26.36	179.9	27.38	189.7	27.74	194.3	27.96
	21	130.5	16.81	155.2	21.53	169.6	25.37	174.7	27.14	179.9	28.28	189.7	28.64	194.3	28.86
	23	130.5	17.98	155.2	23.03	169.6	27.18	174.7	28.84	179.9	30.15	189.7	30.45	194.3	30.69
	25	130.5	19.21	155.2	24.67	169.6	28.67	174.7	30.74	179.9	32.33	187.4	32.60	192.0	32.86
	27	130.5	20.50	155.2	26.38	169.6	30.50	174.7	32.84	179.9	34.74	184.5	34.98	189.1	35.26
	29	130.5	21.87	155.2	28.16	169.6	32.10	174.7	35.15	177.0	37.02	181.6	37.58	186.8	37.88
	31	130.5	23.31	155.2	30.07	169.6	33.76	172.5	37.66	174.7	39.72	179.3	40.42	183.9	40.75
	33	130.5	24.81	155.2	32.06	167.3	35.72	169.6	40.87	171.8	42.64	176.5	43.13	181.1	43.48
	35	130.5	26.38	155.2	34.17	164.4	37.80	166.7	45.03	169.6	45.25	174.2	45.39	178.7	45.75
	37	130.5	28.38	155.2	36.06	162.1	40.30	164.4	44.08	166.7	44.30	171.3	44.43	175.9	44.78
	39	130.5	30.55	154.6	38.11	159.2	42.75	161.5	43.17	163.8	43.39	169.0	43.52	173.6	43.86
41	127.2	32.72	147.9	40.16	152.9	41.90	155.0	42.27	157.3	42.48	161.8	42.61	166.4	42.94	
43	124.0	34.93	141.7	39.59	146.6	40.96	148.7	41.36	150.9	41.57	155.3	41.69	159.8	42.02	
46	116.2	37.56	129.2	38.65	133.9	39.68	135.8	40.00	137.9	40.20	142.1	40.32	146.3	40.64	
48	102.8	36.79	112.2	37.96	116.3	38.90	118.1	39.14	119.9	39.26	123.6	39.42	127.3	39.58	
110	10	116.9	12.36	139.4	15.07	155.7	17.90	160.1	19.38	170.3	20.85	174.2	21.43	186.0	21.79
	12	116.9	12.75	139.4	15.58	155.7	18.64	160.1	19.92	170.3	21.64	174.2	22.33	186.0	22.85
	14	116.9	13.15	139.4	16.28	155.7	19.49	160.1	20.91	170.3	22.73	174.2	23.37	186.0	23.87
	16	116.9	13.62	139.4	16.87	155.7	20.30	160.1	21.82	170.3	23.77	174.2	24.42	186.0	24.85
	18	116.9	14.12	139.4	17.58	155.7	21.46	160.1	22.98	170.3	25.08	174.2	25.57	186.0	26.05
	20	116.9	14.62	139.4	18.45	155.7	22.76	160.1	24.04	170.3	26.29	174.2	26.94	186.0	27.38
	21	116.9	14.95	139.4	19.00	155.7	23.34	160.1	24.68	170.3	27.03	174.2	27.71	186.0	28.14
	23	116.9	15.93	139.4	20.37	155.7	24.65	160.1	26.06	170.3	28.55	174.2	29.17	186.0	29.65
	25	116.9	17.02	139.4	21.74	155.7	26.04	160.1	27.55	170.3	30.17	174.2	30.60	183.7	31.23
	27	116.9	18.18	139.4	23.24	155.7	27.52	160.1	29.15	170.3	31.51	174.2	32.23	181.0	32.77
	29	116.9	19.41	139.4	24.81	155.7	29.08	160.1	30.88	170.3	33.29	174.2	33.87	178.7	34.38
	31	116.9	20.64	139.4	26.45	155.7	30.73	160.1	32.71	167.5	34.99	171.9	35.67	175.9	36.05
	33	116.9	22.01	139.4	28.16	155.7	32.46	160.1	34.67	165.2	36.95	169.2	37.56	173.6	37.77
	35	116.9	23.38	139.4	30.07	155.7	34.29	160.1	36.73	162.4	38.99	166.3	39.35	170.9	39.55
	37	116.9	24.77	139.4	31.92	155.7	36.20	157.9	38.92	159.6	41.12	164.1	41.27	168.0	41.38
	39	116.9	26.71	139.4	33.92	152.8	38.19	155.1	41.63	157.4	43.16	161.3	43.23	165.8	43.28
41	113.9	28.64	135.8	35.92	146.3	40.27	148.6	45.03	150.5	45.03	154.9	45.39	158.8	45.75	
43	111.1	30.08	132.4	37.42	140.2	42.71	142.5	43.19	144.4	43.10	148.7	43.34	152.4	43.46	
46	104.1	29.36	124.1	36.12	127.9	40.53	130.2	40.53	131.9	40.88	135.9	41.11	139.4	41.22	
48	92.1	28.51	107.9	34.80	111.1	38.56	113.1	38.82	114.6	39.01	118.2	39.12	121.3	39.28	

# 7. Capacity Tables

Cooling Capacity (52HP)

Combination (%)	Outdoor air temp. (DB, °C)	Indoor air temp. (DB/WB, °C)													
		20		23		26		27		28		30		32	
		14		16		18		19		20		22		24	
		TC	PI	TC	PI	TC	PI	TC	PI	TC	PI	TC	PI	TC	PI
100	10	98.3	11.13	117.0	13.53	136.2	16.06	145.6	17.35	155.0	18.64	171.8	20.75	175.6	20.92
	12	98.3	11.49	117.0	14.09	136.2	16.60	145.6	17.82	155.0	19.23	171.8	21.86	175.6	22.08
	14	98.3	11.85	117.0	14.65	136.2	17.30	145.6	18.59	155.0	20.06	171.8	23.09	175.6	23.30
	16	98.3	12.21	117.0	15.13	136.2	18.04	145.6	19.47	155.0	21.14	171.8	24.20	175.6	24.54
	18	98.3	12.57	117.0	15.69	136.2	18.73	145.6	20.42	155.0	22.42	171.8	25.57	175.6	25.78
	20	98.3	13.02	117.0	16.29	136.2	19.82	145.6	21.87	155.0	23.99	171.8	26.79	175.6	27.01
	21	98.3	13.29	117.0	16.68	136.2	20.50	145.6	22.62	155.0	24.88	171.8	27.41	175.6	27.63
	23	98.3	14.08	117.0	17.84	136.2	22.01	145.6	24.26	155.0	26.66	171.8	28.70	175.6	28.93
	25	98.3	14.97	117.0	19.00	136.2	23.51	145.6	25.97	155.0	28.50	171.8	29.92	174.1	30.16
	27	98.3	15.99	117.0	20.30	136.2	25.15	145.6	27.75	155.0	30.30	168.5	31.33	172.0	31.58
	29	98.3	17.02	117.0	21.67	136.2	26.86	145.6	29.66	155.0	32.07	165.3	32.59	169.4	32.85
	31	98.3	18.18	117.0	23.10	136.2	28.64	145.6	31.65	155.0	33.70	162.9	33.85	166.8	34.13
	33	98.3	19.27	117.0	24.61	136.2	30.55	145.6	33.76	155.0	34.97	160.2	35.12	164.2	35.40
	35	98.3	20.50	117.0	26.18	136.2	32.53	145.6	36.02	152.6	36.24	157.3	36.38	161.3	36.67
	37	98.3	21.96	117.0	28.08	136.2	34.46	145.6	37.74	150.1	37.92	154.4	38.07	158.1	38.43
	39	98.3	23.54	117.0	30.16	136.2	36.52	145.6	39.58	147.6	39.75	151.9	39.90	155.5	40.28
	41	96.7	25.13	115.1	32.25	134.1	38.58	139.7	41.42	142.8	41.59	146.1	41.73	150.9	42.13
	43	93.4	26.59	111.2	34.18	129.5	40.42	134.0	43.01	135.5	43.16	139.7	43.30	143.3	43.71
46	87.5	28.60	104.2	36.85	121.3	42.87	122.3	45.03	123.6	45.16	127.6	45.29	131.0	45.72	
48	77.4	24.70	92.2	31.88	104.8	36.65	106.3	38.20	107.4	38.33	110.9	38.41	114.0	38.72	
90	10	88.4	10.37	105.6	12.46	122.7	14.69	131.0	15.83	139.4	17.04	156.5	19.08	173.7	20.92
	12	88.4	10.49	105.6	12.65	122.7	14.94	131.0	16.15	139.4	17.42	156.5	19.45	173.7	21.59
	14	88.4	10.68	105.6	12.91	122.7	15.26	131.0	16.47	139.4	17.74	156.5	19.83	173.7	22.03
	16	88.4	10.87	105.6	13.16	122.7	15.58	131.0	16.79	139.4	18.06	156.5	20.21	173.7	22.40
	18	88.4	11.06	105.6	13.42	122.7	15.83	131.0	17.17	139.4	18.44	156.5	20.65	173.7	23.53
	20	88.4	11.26	105.6	13.67	122.7	16.15	131.0	17.49	139.4	19.14	156.5	22.10	173.7	24.66
	21	88.4	11.38	105.6	13.80	122.7	16.47	131.0	18.06	139.4	19.84	156.5	22.46	173.7	25.22
	23	88.4	11.64	105.6	14.37	122.7	17.61	131.0	19.40	139.4	21.24	156.5	23.82	171.3	26.41
	25	88.4	12.21	105.6	15.33	122.7	18.82	131.0	20.73	139.4	22.70	156.5	25.46	168.8	27.53
	27	88.4	13.04	105.6	16.34	122.7	20.09	131.0	22.13	139.4	24.29	156.5	27.07	166.3	28.83
	29	88.4	13.80	105.6	17.42	122.7	21.49	131.0	23.66	139.4	25.95	156.5	28.68	163.9	29.99
	31	88.4	14.69	105.6	18.57	122.7	22.89	131.0	25.18	139.4	27.66	156.5	30.11	161.4	31.15
	33	88.4	15.64	105.6	19.78	122.7	24.42	131.0	26.84	139.4	29.34	156.5	31.56	158.9	32.31
	35	88.4	16.60	105.6	20.99	122.7	25.95	131.0	28.62	139.4	31.11	153.8	33.38	156.4	34.14
	37	88.4	17.61	105.6	22.32	122.7	27.66	131.0	30.40	139.4	32.84	151.4	34.89	154.0	35.67
	39	88.4	18.65	105.6	23.74	122.7	29.28	131.0	32.35	139.4	34.54	148.9	36.78	151.5	37.23
	41	86.1	20.87	102.9	26.32	119.6	32.14	127.7	35.38	135.8	37.29	142.7	38.77	145.2	39.65
	43	84.0	22.53	100.3	28.44	116.6	35.10	124.5	38.10	132.4	39.98	136.8	41.48	139.3	42.01
46	78.7	25.35	94.0	32.39	109.3	40.00	116.7	43.20	120.3	44.42	124.9	45.22	127.2	45.46	
48	69.6	22.16	83.2	28.33	96.7	34.99	103.2	37.67	104.5	38.12	108.5	38.41	110.6	38.72	
80	10	78.5	9.67	93.6	11.62	108.7	13.63	116.5	14.71	124.3	15.78	139.4	18.00	154.4	19.54
	12	78.5	9.87	93.6	11.75	108.7	13.90	116.5	14.98	124.3	16.05	139.4	18.33	154.4	19.93
	14	78.5	10.01	93.6	12.02	108.7	14.10	116.5	15.24	124.3	16.32	139.4	18.67	154.4	20.31
	16	78.5	10.14	93.6	12.22	108.7	14.37	116.5	15.51	124.3	16.66	139.4	19.07	154.4	20.70
	18	78.5	10.34	93.6	12.42	108.7	14.64	116.5	15.78	124.3	16.99	139.4	19.41	154.4	21.15
	20	78.5	10.54	93.6	12.69	108.7	14.98	116.5	16.12	124.3	17.33	139.4	20.15	154.4	22.41
	21	78.5	10.61	93.6	12.83	108.7	15.11	116.5	16.32	124.3	17.73	139.4	20.78	154.4	23.01
	23	78.5	10.81	93.6	13.03	108.7	15.78	116.5	17.33	124.3	18.94	139.4	21.94	154.4	24.15
	25	78.5	11.22	93.6	13.90	108.7	16.92	116.5	18.54	124.3	20.28	139.4	23.48	154.4	25.82
	27	78.5	11.89	93.6	14.77	108.7	18.07	116.5	19.81	124.3	21.62	139.4	24.95	154.4	27.16
	29	78.5	12.63	93.6	15.78	108.7	19.21	116.5	21.09	124.3	23.10	139.4	26.73	154.4	28.49
	31	78.5	13.43	93.6	16.72	108.7	20.48	116.5	22.50	124.3	24.58	139.4	28.37	154.4	29.91
	33	78.5	14.24	93.6	17.86	108.7	21.83	116.5	23.98	124.3	26.19	139.4	29.89	154.4	31.34
	35	78.5	15.11	93.6	18.94	108.7	23.24	116.5	25.52	124.3	27.94	139.4	31.70	152.8	33.12
	37	78.5	15.98	93.6	20.13	108.7	24.65	116.5	27.13	124.3	29.68	139.4	33.45	150.3	34.68
	39	78.5	16.89	93.6	21.29	108.7	26.37	116.5	29.17	124.3	31.90	139.4	35.34	147.9	36.58
	41	76.5	18.69	91.2	23.59	105.9	28.94	113.5	31.97	121.1	35.05	135.8	37.99	141.7	38.86
	43	74.6	20.57	88.9	25.74	103.3	31.59	110.7	34.84	118.1	38.30	132.4	40.65	135.8	41.59
46	69.9	22.89	83.4	29.00	96.8	35.59	103.7	38.78	110.7	43.22	121.1	45.22	124.0	45.46	
48	61.9	19.99	73.7	25.35	85.6	31.12	91.8	33.88	97.9	37.78	105.2	38.41	107.7	38.72	



# 7. Capacity Tables

Cooling Capacity (52HP)

Combination (%)	Outdoor air temp. (DB, °C)	Indoor air temp. (DB/WB, °C)													
		20		23		26		27		28		30		32	
		14	16	18	19	20	22	24	TC	PI	TC	PI	TC	PI	
70	10	68.6	8.56	82.2	10.17	95.2	11.79	101.9	12.73	108.7	13.61	121.7	15.50	135.2	17.33
	12	68.6	8.69	82.2	10.31	95.2	12.06	101.9	12.94	108.7	13.88	121.7	15.77	135.2	17.66
	14	68.6	8.83	82.2	10.44	95.2	12.26	101.9	13.14	108.7	14.08	121.7	16.10	135.2	17.98
	16	68.6	8.96	82.2	10.65	95.2	12.46	101.9	13.41	108.7	14.35	121.7	16.37	135.2	18.37
	18	68.6	9.10	82.2	10.85	95.2	12.73	101.9	13.68	108.7	14.62	121.7	16.64	135.2	18.69
	20	68.6	9.23	82.2	11.05	95.2	12.94	101.9	13.95	108.7	14.96	121.7	17.05	135.2	19.40
	21	68.6	9.37	82.2	11.12	95.2	13.07	101.9	14.08	108.7	15.09	121.7	17.32	135.2	19.82
	23	68.6	9.50	82.2	11.39	95.2	13.34	101.9	14.55	108.7	15.83	121.7	18.53	135.2	20.92
	25	68.6	9.63	82.2	11.79	95.2	14.22	101.9	15.56	108.7	16.91	121.7	19.81	135.2	21.94
	27	68.6	10.17	82.2	12.60	95.2	15.16	101.9	16.51	108.7	18.06	121.7	21.16	135.2	23.31
	29	68.6	10.85	82.2	13.34	95.2	16.10	101.9	17.59	108.7	19.20	121.7	22.57	135.2	24.98
	31	68.6	11.52	82.2	14.22	95.2	17.18	101.9	18.80	108.7	20.48	121.7	24.05	135.2	26.51
	33	68.6	12.20	82.2	15.02	95.2	18.26	101.9	19.94	108.7	21.76	121.7	25.60	135.2	28.22
	35	68.6	12.87	82.2	16.04	95.2	19.40	101.9	21.22	108.7	23.18	121.7	27.29	135.2	29.92
	37	68.6	13.68	82.2	16.99	95.2	20.62	101.9	22.57	108.7	24.66	121.7	29.04	135.2	31.57
	39	68.6	14.52	82.2	18.11	95.2	22.04	101.9	24.28	108.7	26.64	121.7	31.08	135.2	34.04
41	66.9	16.06	80.1	19.84	92.7	24.18	99.3	26.64	105.9	28.96	118.6	34.14	131.7	36.72	
43	65.2	17.48	78.1	21.62	90.4	26.39	96.9	29.04	103.3	31.62	115.6	37.29	128.5	39.70	
46	61.1	19.42	73.2	24.31	84.7	29.71	90.8	32.35	96.8	35.65	108.4	42.06	120.4	44.25	
48	54.1	16.95	64.7	21.24	75.0	25.98	80.3	28.27	85.6	31.19	95.9	36.81	106.5	38.19	
60	10	58.8	7.44	70.2	8.72	81.6	10.14	87.4	10.88	93.1	11.56	104.5	13.11	116.0	14.67
	12	58.8	7.57	70.2	8.86	81.6	10.27	87.4	11.02	93.1	11.76	104.5	13.32	116.0	14.94
	14	58.8	7.64	70.2	8.99	81.6	10.48	87.4	11.22	93.1	11.96	104.5	13.59	116.0	15.21
	16	58.8	7.77	70.2	9.19	81.6	10.61	87.4	11.42	93.1	12.23	104.5	13.86	116.0	15.48
	18	58.8	7.91	70.2	9.33	81.6	10.82	87.4	11.63	93.1	12.44	104.5	14.06	116.0	15.82
	20	58.8	8.04	70.2	9.46	81.6	11.02	87.4	11.83	93.1	12.64	104.5	14.33	116.0	16.16
	21	58.8	8.11	70.2	9.53	81.6	11.15	87.4	11.96	93.1	12.78	104.5	14.53	116.0	16.29
	23	58.8	8.25	70.2	9.73	81.6	11.29	87.4	12.17	93.1	13.05	104.5	15.07	116.0	17.30
	25	58.8	8.38	70.2	9.94	81.6	11.76	87.4	12.78	93.1	13.86	104.5	16.09	116.0	18.52
	27	58.8	8.65	70.2	10.48	81.6	12.51	87.4	13.59	93.1	14.74	104.5	17.10	116.0	19.74
	29	58.8	9.19	70.2	11.15	81.6	13.32	87.4	14.47	93.1	15.68	104.5	18.25	116.0	21.09
	31	58.8	9.73	70.2	11.83	81.6	14.13	87.4	15.41	93.1	16.70	104.5	19.47	116.0	22.44
	33	58.8	10.27	70.2	12.51	81.6	15.01	87.4	16.36	93.1	17.78	104.5	20.68	116.0	23.93
	35	58.8	10.88	70.2	13.32	81.6	15.95	87.4	17.37	93.1	18.86	104.5	22.04	116.0	25.42
	37	58.8	11.49	70.2	14.05	81.6	16.90	87.4	18.45	93.1	20.01	104.5	23.39	116.0	27.04
	39	58.8	12.22	70.2	14.96	81.6	18.24	87.4	19.80	93.1	21.53	104.5	25.08	116.0	28.97
41	57.3	13.26	68.4	16.37	79.6	19.81	85.1	21.63	90.7	23.37	101.8	27.52	113.0	31.48	
43	55.8	14.40	66.7	17.83	77.6	21.59	83.0	23.57	88.5	25.49	99.3	30.04	110.2	34.39	
46	52.3	16.13	62.5	20.02	72.7	24.29	77.8	26.49	82.9	28.68	93.1	33.85	103.3	39.18	
48	46.3	14.06	55.3	17.47	64.3	21.22	68.8	23.14	73.3	25.06	82.3	29.61	91.4	34.28	
50	10	49.1	6.44	58.8	7.46	68.1	8.48	72.8	9.09	77.5	9.63	86.8	10.85	96.7	12.07
	12	49.1	6.51	58.8	7.53	68.1	8.61	72.8	9.22	77.5	9.83	86.8	11.05	96.7	12.27
	14	49.1	6.58	58.8	7.66	68.1	8.75	72.8	9.36	77.5	9.97	86.8	11.19	96.7	12.48
	16	49.1	6.71	58.8	7.80	68.1	8.88	72.8	9.56	77.5	10.10	86.8	11.39	96.7	12.68
	18	49.1	6.78	58.8	7.87	68.1	9.02	72.8	9.70	77.5	10.31	86.8	11.60	96.7	12.95
	20	49.1	6.85	58.8	8.00	68.1	9.22	72.8	9.83	77.5	10.51	86.8	11.80	96.7	13.22
	21	49.1	6.92	58.8	8.07	68.1	9.29	72.8	9.97	77.5	10.58	86.8	11.94	96.7	13.36
	23	49.1	7.05	58.8	8.21	68.1	9.43	72.8	10.10	77.5	10.78	86.8	12.14	96.7	13.63
	25	49.1	7.12	58.8	8.34	68.1	9.63	72.8	10.31	77.5	11.12	86.8	12.75	96.7	14.58
	27	49.1	7.26	58.8	8.61	68.1	10.17	72.8	10.99	77.5	11.80	86.8	13.63	96.7	15.53
	29	49.1	7.66	58.8	9.16	68.1	10.78	72.8	11.66	77.5	12.55	86.8	14.44	96.7	16.48
	31	49.1	8.07	58.8	9.70	68.1	11.46	72.8	12.34	77.5	13.36	86.8	15.39	96.7	17.56
	33	49.1	8.54	58.8	10.24	68.1	12.14	72.8	13.09	77.5	14.17	86.8	16.34	96.7	18.72
	35	49.1	9.02	58.8	10.85	68.1	12.82	72.8	13.90	77.5	14.99	86.8	17.29	96.7	19.87
	37	49.1	9.56	58.8	11.46	68.1	13.56	72.8	14.72	77.5	15.87	86.8	18.45	96.7	21.09
	39	49.1	10.20	58.8	12.28	68.1	14.53	72.8	15.84	77.5	17.03	86.8	19.65	96.7	22.78
41	47.9	11.03	57.3	13.30	66.4	15.89	70.9	17.16	75.5	18.45	84.6	21.54	94.2	24.74	
43	46.7	11.99	55.8	14.47	64.7	17.29	69.2	18.68	73.6	20.08	82.5	23.48	91.9	26.99	
46	43.8	13.42	52.3	16.22	60.7	19.39	64.8	20.98	69.0	22.55	77.3	26.42	86.1	30.38	
48	38.7	11.70	46.3	14.15	53.7	16.92	57.4	18.31	61.0	19.68	68.4	23.09	76.2	26.56	

**Note**

1. TC: Total Capacity(kW), PI : Power Input(kW, Comp. + Outdoor fan motor)
2. Capacity tables show the average value of conditions which may occur.

# 7. Capacity Tables

◆ ARUM540LTE5

Cooling Capacity (54HP)

Combination (%)	Outdoor air temp. (DB, °C)	Indoor air temp. (DB/WB, °C)													
		20		23		26		27		28		30		32	
		14	16	16	18	18	19	20	20	22	22	24	24		
		TC	PI	TC	PI	TC	PI	TC	PI	TC	PI	TC	PI	TC	PI
130	10	149.8	15.34	178.4	18.74	191.1	21.74	196.6	22.18	202.1	22.36	211.8	22.54	217.3	22.63
	12	149.8	15.71	178.4	19.41	191.1	22.63	196.6	22.78	202.1	22.96	211.8	23.15	217.3	23.35
	14	149.8	16.24	178.4	20.12	191.1	23.49	196.6	23.66	202.1	23.85	211.8	24.04	217.3	24.25
	16	149.8	16.83	178.4	20.82	191.1	24.54	196.6	24.77	202.1	24.96	211.8	25.19	217.3	25.39
	18	149.8	17.54	178.4	22.02	191.1	25.67	196.6	26.22	202.1	26.43	211.8	26.69	217.3	26.87
	20	149.8	18.32	178.4	23.46	191.1	26.93	196.6	28.84	202.1	29.07	208.8	29.36	214.3	29.56
	21	149.8	18.80	178.4	24.28	191.1	27.50	196.6	30.52	202.1	30.76	207.6	31.07	213.1	31.28
	23	149.8	20.17	178.4	25.55	191.1	28.93	196.6	33.68	199.6	33.95	204.5	34.28	210.0	34.52
	25	149.8	21.54	178.4	27.01	191.1	30.91	194.3	37.35	196.6	37.65	202.1	38.02	207.6	38.28
	27	149.8	23.05	178.4	28.88	188.7	32.93	191.1	41.12	194.3	41.45	199.6	41.86	204.5	42.14
	29	149.8	24.56	178.4	30.87	185.7	35.43	188.4	45.19	191.1	45.46	196.6	45.87	202.1	46.05
	31	149.8	26.20	177.8	32.52	182.6	37.69	185.7	45.00	188.4	45.27	193.6	45.67	199.0	45.85
	33	149.8	27.92	174.7	34.46	180.2	40.42	183.1	44.59	185.7	44.85	191.1	45.26	196.0	45.43
	35	149.8	29.77	171.6	36.08	177.1	43.79	180.2	44.01	183.1	44.27	188.1	44.67	193.6	44.84
	37	149.8	31.75	169.2	37.87	174.7	43.21	177.1	43.42	180.2	43.69	185.1	44.08	190.6	44.25
	39	149.8	33.80	166.2	39.86	171.6	42.63	174.7	42.84	177.1	43.10	182.6	43.49	188.1	43.66
	41	145.9	35.86	159.3	41.85	164.7	42.05	167.2	42.26	170.4	42.52	175.6	42.90	180.3	43.07
	43	142.3	37.82	152.7	41.26	158.0	41.47	160.4	41.68	163.6	41.93	168.6	42.31	173.2	42.47
46	133.4	40.49	139.3	40.40	144.3	40.61	146.6	40.81	149.6	41.05	154.3	41.42	158.6	41.58	
48	118.0	39.36	121.0	39.47	125.5	39.56	127.5	39.67	130.2	40.01	134.4	40.26	138.1	40.42	
120	10	135.5	13.80	161.1	16.92	176.1	20.10	181.5	21.72	186.8	22.07	197.0	22.16	201.8	22.33
	12	135.5	14.17	161.1	17.49	176.1	20.91	181.5	22.18	186.8	22.88	197.0	23.16	201.8	23.35
	14	135.5	14.66	161.1	18.08	176.1	21.75	181.5	23.02	186.8	23.72	197.0	24.07	201.8	24.27
	16	135.5	15.18	161.1	18.82	176.1	22.60	181.5	23.88	186.8	24.82	197.0	25.12	201.8	25.33
	18	135.5	15.78	161.1	19.67	176.1	23.50	181.5	25.14	186.8	26.09	197.0	26.39	201.8	26.60
	20	135.5	16.38	161.1	20.85	176.1	24.76	181.5	26.46	186.8	27.47	197.0	27.84	201.8	28.06
	21	135.5	16.87	161.1	21.61	176.1	25.46	181.5	27.24	186.8	28.38	197.0	28.74	201.8	28.97
	23	135.5	18.04	161.1	23.12	176.1	27.28	181.5	28.94	186.8	30.25	197.0	30.56	201.8	30.81
	25	135.5	19.28	161.1	24.76	176.1	28.77	181.5	30.85	186.8	32.44	194.6	32.72	199.3	32.98
	27	135.5	20.58	161.1	26.48	176.1	30.62	181.5	32.96	186.8	34.87	191.6	35.10	196.4	35.38
	29	135.5	21.95	161.1	28.26	176.1	32.22	181.5	35.28	183.8	37.16	188.6	37.72	194.0	38.02
	31	135.5	23.39	161.1	30.18	176.1	33.89	179.1	37.79	181.5	39.86	186.2	40.57	191.0	40.89
	33	135.5	24.90	161.1	32.17	173.7	35.84	176.1	41.02	178.4	42.80	183.2	43.29	188.0	43.63
	35	135.5	26.48	161.1	34.30	170.7	37.94	173.1	45.19	176.1	45.41	180.9	45.55	185.6	45.91
	37	135.5	28.48	161.1	36.19	168.3	40.45	170.7	44.24	173.1	44.46	177.9	44.59	182.7	44.95
	39	135.5	30.66	160.6	38.25	165.4	42.90	167.7	43.33	170.1	43.55	175.5	43.68	180.2	44.02
	41	132.0	32.84	153.6	40.31	158.7	42.06	161.0	42.42	163.3	42.63	168.1	42.76	172.8	43.10
	43	128.8	35.05	147.1	39.73	152.2	41.11	154.4	41.51	156.7	41.72	161.3	41.84	166.0	42.18
46	120.7	37.69	134.1	38.79	139.0	39.82	141.1	40.15	143.2	40.35	147.5	40.47	151.9	40.79	
48	106.8	36.92	116.5	38.10	120.8	39.04	122.6	39.28	124.5	39.41	128.4	39.56	132.2	39.72	
110	10	121.4	12.41	144.7	15.13	161.7	17.97	166.3	19.45	176.8	20.93	180.9	21.51	193.2	21.87
	12	121.4	12.80	144.7	15.63	161.7	18.71	166.3	19.99	176.8	21.71	180.9	22.41	193.2	22.93
	14	121.4	13.19	144.7	16.34	161.7	19.56	166.3	20.98	176.8	22.81	180.9	23.46	193.2	23.95
	16	121.4	13.66	144.7	16.93	161.7	20.37	166.3	21.90	176.8	23.86	180.9	24.51	193.2	24.94
	18	121.4	14.17	144.7	17.64	161.7	21.54	166.3	23.06	176.8	25.17	180.9	25.67	193.2	26.14
	20	121.4	14.68	144.7	18.52	161.7	22.84	166.3	24.12	176.8	26.39	180.9	27.04	193.2	27.47
	21	121.4	15.00	144.7	19.07	161.7	23.43	166.3	24.77	176.8	27.12	180.9	27.81	193.2	28.24
	23	121.4	15.98	144.7	20.44	161.7	24.74	166.3	26.15	176.8	28.66	180.9	29.27	193.2	29.76
	25	121.4	17.08	144.7	21.81	161.7	26.13	166.3	27.65	176.8	30.28	180.9	30.71	190.8	31.34
	27	121.4	18.25	144.7	23.32	161.7	27.61	166.3	29.26	176.8	31.62	180.9	32.34	188.0	32.89
	29	121.4	19.48	144.7	24.90	161.7	29.18	166.3	30.99	176.8	33.41	180.9	33.99	185.6	34.51
	31	121.4	20.72	144.7	26.55	161.7	30.84	166.3	32.83	173.9	35.11	178.6	35.80	182.7	36.18
	33	121.4	22.09	144.7	28.26	161.7	32.58	166.3	34.79	171.5	37.08	175.7	37.69	180.3	37.90
	35	121.4	23.46	144.7	30.18	161.7	34.41	166.3	36.87	168.7	39.13	172.7	39.49	177.4	39.69
	37	121.4	24.86	144.7	32.03	161.7	36.33	164.0	39.06	165.7	41.27	170.4	41.42	174.5	41.53
	39	121.4	26.81	144.7	34.04	158.7	38.33	161.0	41.78	163.4	43.32	167.5	43.39	172.2	43.43
	41	118.3	28.75	141.0	36.05	151.9	40.42	154.3	45.19	156.3	45.19	160.9	45.55	164.9	45.91
	43	115.4	30.19	137.5	37.55	145.6	42.86	148.0	43.35	149.9	43.25	154.4	43.50	158.3	43.62
46	108.1	29.46	128.9	36.26	132.8	40.68	135.2	40.68	136.9	41.03	141.1	41.26	144.8	41.37	
48	95.6	28.62	112.0	34.93	115.4	38.70	117.5	38.96	119.0	39.15	122.7	39.26	126.0	39.42	

# 7. Capacity Tables

Cooling Capacity (54HP)

Combination (%)	Outdoor air temp. (DB, °C)	Indoor air temp. (DB/WB, °C)													
		20		23		26		27		28		30		32	
		14		16		18		19		20		22		24	
		TC	PI	TC	PI	TC	PI	TC	PI	TC	PI	TC	PI	TC	PI
100	10	102.1	11.17	121.5	13.58	141.5	16.11	151.2	17.41	160.9	18.71	178.4	20.82	182.3	20.99
	12	102.1	11.53	121.5	14.14	141.5	16.66	151.2	17.88	160.9	19.30	178.4	21.94	182.3	22.16
	14	102.1	11.89	121.5	14.70	141.5	17.36	151.2	18.65	160.9	20.14	178.4	23.17	182.3	23.39
	16	102.1	12.25	121.5	15.19	141.5	18.10	151.2	19.54	160.9	21.22	178.4	24.29	182.3	24.63
	18	102.1	12.62	121.5	15.75	141.5	18.80	151.2	20.49	160.9	22.50	178.4	25.66	182.3	25.87
	20	102.1	13.07	121.5	16.35	141.5	19.89	151.2	21.95	160.9	24.08	178.4	26.89	182.3	27.11
	21	102.1	13.34	121.5	16.74	141.5	20.58	151.2	22.71	160.9	24.97	178.4	27.51	182.3	27.73
	23	102.1	14.13	121.5	17.90	141.5	22.09	151.2	24.35	160.9	26.75	178.4	28.80	182.3	29.03
	25	102.1	15.02	121.5	19.07	141.5	23.60	151.2	26.07	160.9	28.60	178.4	30.03	180.8	30.27
	27	102.1	16.05	121.5	20.37	141.5	25.24	151.2	27.85	160.9	30.41	174.9	31.44	178.6	31.70
	29	102.1	17.08	121.5	21.74	141.5	26.96	151.2	29.77	160.9	32.19	171.7	32.71	175.9	32.97
	31	102.1	18.25	121.5	23.19	141.5	28.74	151.2	31.76	160.9	33.82	169.1	33.98	173.2	34.25
	33	102.1	19.34	121.5	24.69	141.5	30.66	151.2	33.89	160.9	35.09	166.4	35.24	170.5	35.52
	35	102.1	20.58	121.5	26.27	141.5	32.65	151.2	36.15	158.5	36.37	163.4	36.51	167.5	36.80
	37	102.1	22.04	121.5	28.18	141.5	34.59	151.2	37.87	155.9	38.06	160.3	38.21	164.2	38.56
	39	102.1	23.63	121.5	30.27	141.5	36.65	151.2	39.72	153.3	39.90	157.8	40.05	161.5	40.42
	41	100.4	25.22	119.6	32.36	139.2	38.71	145.1	41.57	148.3	41.74	151.8	41.89	156.7	42.28
	43	97.0	26.69	115.5	34.31	134.5	40.57	139.1	43.16	140.7	43.32	145.1	43.46	148.8	43.87
46	90.9	28.71	108.2	36.98	126.0	43.03	127.0	45.19	128.4	45.32	132.5	45.45	136.1	45.88	
48	80.4	24.79	95.7	32.00	108.8	36.78	110.4	38.34	111.5	38.47	115.2	38.55	118.3	38.86	
90	10	91.8	10.40	109.6	12.51	127.4	14.74	136.1	15.89	144.7	17.10	162.5	19.15	180.4	20.99
	12	91.8	10.53	109.6	12.70	127.4	15.00	136.1	16.21	144.7	17.49	162.5	19.52	180.4	21.67
	14	91.8	10.72	109.6	12.96	127.4	15.32	136.1	16.53	144.7	17.81	162.5	19.90	180.4	22.11
	16	91.8	10.91	109.6	13.21	127.4	15.64	136.1	16.85	144.7	18.13	162.5	20.28	180.4	22.48
	18	91.8	11.11	109.6	13.47	127.4	15.89	136.1	17.23	144.7	18.51	162.5	20.72	180.4	23.62
	20	91.8	11.30	109.6	13.72	127.4	16.21	136.1	17.55	144.7	19.21	162.5	22.18	180.4	24.75
	21	91.8	11.42	109.6	13.85	127.4	16.53	136.1	18.13	144.7	19.91	162.5	22.54	180.4	25.31
	23	91.8	11.68	109.6	14.42	127.4	17.68	136.1	19.47	144.7	21.32	162.5	23.90	177.9	26.50
	25	91.8	12.25	109.6	15.38	127.4	18.89	136.1	20.81	144.7	22.79	162.5	25.56	175.3	27.63
	27	91.8	13.08	109.6	16.40	127.4	20.17	136.1	22.21	144.7	24.38	162.5	27.17	172.7	28.94
	29	91.8	13.85	109.6	17.49	127.4	21.57	136.1	23.74	144.7	26.04	162.5	28.78	170.2	30.10
	31	91.8	14.74	109.6	18.64	127.4	22.98	136.1	25.27	144.7	27.76	162.5	30.22	167.6	31.27
	33	91.8	15.70	109.6	19.85	127.4	24.51	136.1	26.93	144.7	29.45	162.5	31.68	165.0	32.43
	35	91.8	16.66	109.6	21.06	127.4	26.04	136.1	28.72	144.7	31.23	159.7	33.50	162.5	34.27
	37	91.8	17.68	109.6	22.40	127.4	27.77	136.1	30.51	144.7	32.96	157.2	35.02	159.9	35.80
	39	91.8	18.72	109.6	23.83	127.4	29.39	136.1	32.47	144.7	34.66	154.6	36.92	157.3	37.36
	41	89.5	20.94	106.8	26.42	124.2	32.25	132.6	35.51	141.0	37.42	148.1	38.91	150.8	39.80
	43	87.2	22.61	104.2	28.55	121.1	35.23	129.3	38.24	137.5	40.12	142.0	41.63	144.6	42.17
46	81.8	25.45	97.6	32.51	113.5	40.14	121.2	43.35	125.0	44.58	129.7	45.38	132.1	45.62	
48	72.3	22.24	86.4	28.44	100.4	35.12	107.2	37.81	108.5	38.26	112.7	38.55	114.8	38.86	
80	10	81.5	9.71	97.2	11.66	112.9	13.68	121.0	14.76	129.1	15.84	144.7	18.06	160.4	19.61
	12	81.5	9.91	97.2	11.80	112.9	13.95	121.0	15.03	129.1	16.11	144.7	18.40	160.4	20.00
	14	81.5	10.04	97.2	12.07	112.9	14.15	121.0	15.30	129.1	16.38	144.7	18.74	160.4	20.39
	16	81.5	10.18	97.2	12.27	112.9	14.42	121.0	15.57	129.1	16.72	144.7	19.14	160.4	20.78
	18	81.5	10.38	97.2	12.47	112.9	14.69	121.0	15.84	129.1	17.05	144.7	19.48	160.4	21.23
	20	81.5	10.58	97.2	12.74	112.9	15.03	121.0	16.18	129.1	17.39	144.7	20.22	160.4	22.49
	21	81.5	10.65	97.2	12.87	112.9	15.17	121.0	16.38	129.1	17.79	144.7	20.86	160.4	23.09
	23	81.5	10.85	97.2	13.08	112.9	15.84	121.0	17.39	129.1	19.01	144.7	22.02	160.4	24.23
	25	81.5	11.26	97.2	13.95	112.9	16.99	121.0	18.60	129.1	20.36	144.7	23.57	160.4	25.91
	27	81.5	11.93	97.2	14.83	112.9	18.13	121.0	19.88	129.1	21.70	144.7	25.05	160.4	27.26
	29	81.5	12.67	97.2	15.84	112.9	19.28	121.0	21.16	129.1	23.19	144.7	26.83	160.4	28.60
	31	81.5	13.48	97.2	16.78	112.9	20.56	121.0	22.58	129.1	24.67	144.7	28.48	160.4	30.01
	33	81.5	14.29	97.2	17.93	112.9	21.91	121.0	24.06	129.1	26.29	144.7	30.00	160.4	31.46
	35	81.5	15.17	97.2	19.01	112.9	23.32	121.0	25.61	129.1	28.04	144.7	31.81	158.7	33.24
	37	81.5	16.04	97.2	20.21	112.9	24.74	121.0	27.23	129.1	29.79	144.7	33.58	156.1	34.81
	39	81.5	16.95	97.2	21.37	112.9	26.46	121.0	29.28	129.1	32.02	144.7	35.47	153.5	36.72
	41	79.5	18.75	94.7	23.68	110.0	29.04	117.9	32.09	125.8	35.18	141.0	38.13	147.1	39.00
	43	77.5	20.65	92.4	25.84	107.3	31.70	115.0	34.97	122.6	38.44	137.5	40.80	141.0	41.75
46	72.6	22.97	86.6	29.10	100.5	35.72	107.7	38.92	114.9	43.38	125.8	45.38	128.7	45.62	
48	64.2	20.06	76.6	25.45	88.9	31.24	95.3	34.00	101.7	37.92	109.2	38.55	111.9	38.86	

# 7. Capacity Tables

Cooling Capacity (54HP)

Combination (%)	Outdoor air temp. (DB, °C)	Indoor air temp. (DB/WB, °C)													
		20		23		26		27		28		30		32	
		14	16	18	19	20	22	24	TC	PI	TC	PI	TC	PI	
70	10	71.3	8.59	85.3	10.21	98.8	11.83	105.8	12.78	112.9	13.66	126.4	15.55	140.4	17.40
	12	71.3	8.72	85.3	10.35	98.8	12.10	105.8	12.98	112.9	13.93	126.4	15.82	140.4	17.72
	14	71.3	8.86	85.3	10.48	98.8	12.31	105.8	13.19	112.9	14.13	126.4	16.16	140.4	18.05
	16	71.3	8.99	85.3	10.68	98.8	12.51	105.8	13.46	112.9	14.40	126.4	16.43	140.4	18.44
	18	71.3	9.13	85.3	10.89	98.8	12.78	105.8	13.73	112.9	14.67	126.4	16.70	140.4	18.76
	20	71.3	9.26	85.3	11.09	98.8	12.98	105.8	14.00	112.9	15.01	126.4	17.11	140.4	19.48
	21	71.3	9.40	85.3	11.16	98.8	13.12	105.8	14.13	112.9	15.15	126.4	17.38	140.4	19.89
	23	71.3	9.54	85.3	11.43	98.8	13.39	105.8	14.61	112.9	15.89	126.4	18.60	140.4	21.00
	25	71.3	9.67	85.3	11.83	98.8	14.27	105.8	15.62	112.9	16.97	126.4	19.88	140.4	22.02
	27	71.3	10.21	85.3	12.65	98.8	15.22	105.8	16.57	112.9	18.12	126.4	21.23	140.4	23.40
	29	71.3	10.89	85.3	13.39	98.8	16.16	105.8	17.65	112.9	19.27	126.4	22.65	140.4	25.07
	31	71.3	11.56	85.3	14.27	98.8	17.24	105.8	18.87	112.9	20.56	126.4	24.14	140.4	26.60
	33	71.3	12.24	85.3	15.08	98.8	18.33	105.8	20.02	112.9	21.84	126.4	25.70	140.4	28.32
	35	71.3	12.92	85.3	16.10	98.8	19.48	105.8	21.30	112.9	23.26	126.4	27.39	140.4	30.03
	37	71.3	13.73	85.3	17.05	98.8	20.69	105.8	22.65	112.9	24.75	126.4	29.15	140.4	31.69
	39	71.3	14.58	85.3	18.18	98.8	22.13	105.8	24.37	112.9	26.74	126.4	31.19	140.4	34.16
	41	69.5	16.12	83.1	19.91	96.3	24.27	103.1	26.73	110.0	29.07	123.1	34.26	136.8	36.86
43	67.7	17.54	81.1	21.70	93.9	26.48	100.6	29.15	107.3	31.74	120.1	37.43	133.4	39.85	
46	63.5	19.50	76.0	24.40	88.0	29.82	94.3	32.47	100.5	35.78	112.5	42.21	125.0	44.42	
48	56.2	17.01	67.2	21.32	77.9	26.07	83.4	28.38	88.9	31.30	99.5	36.94	110.6	38.33	
60	10	61.0	7.46	72.9	8.75	84.8	10.18	90.7	10.92	96.7	11.60	108.5	13.16	120.4	14.72
	12	61.0	7.60	72.9	8.89	84.8	10.31	90.7	11.06	96.7	11.81	108.5	13.37	120.4	14.99
	14	61.0	7.67	72.9	9.02	84.8	10.52	90.7	11.26	96.7	12.01	108.5	13.64	120.4	15.27
	16	61.0	7.80	72.9	9.23	84.8	10.65	90.7	11.47	96.7	12.28	108.5	13.91	120.4	15.54
	18	61.0	7.94	72.9	9.36	84.8	10.86	90.7	11.67	96.7	12.48	108.5	14.11	120.4	15.88
	20	61.0	8.07	72.9	9.50	84.8	11.06	90.7	11.87	96.7	12.69	108.5	14.38	120.4	16.22
	21	61.0	8.14	72.9	9.57	84.8	11.19	90.7	12.01	96.7	12.82	108.5	14.59	120.4	16.35
	23	61.0	8.28	72.9	9.77	84.8	11.33	90.7	12.21	96.7	13.09	108.5	15.13	120.4	17.37
	25	61.0	8.41	72.9	9.97	84.8	11.81	90.7	12.82	96.7	13.91	108.5	16.15	120.4	18.59
	27	61.0	8.68	72.9	10.52	84.8	12.55	90.7	13.64	96.7	14.79	108.5	17.16	120.4	19.81
	29	61.0	9.23	72.9	11.19	84.8	13.37	90.7	14.52	96.7	15.74	108.5	18.32	120.4	21.17
	31	61.0	9.77	72.9	11.87	84.8	14.18	90.7	15.47	96.7	16.76	108.5	19.54	120.4	22.52
	33	61.0	10.31	72.9	12.55	84.8	15.06	90.7	16.42	96.7	17.84	108.5	20.76	120.4	24.02
	35	61.0	10.92	72.9	13.37	84.8	16.01	90.7	17.44	96.7	18.93	108.5	22.12	120.4	25.51
	37	61.0	11.53	72.9	14.11	84.8	16.96	90.7	18.52	96.7	20.08	108.5	23.47	120.4	27.14
	39	61.0	12.27	72.9	15.02	84.8	18.31	90.7	19.87	96.7	21.61	108.5	25.17	120.4	29.08
	41	59.5	13.30	71.0	16.43	82.6	19.88	88.4	21.71	94.2	23.46	105.8	27.62	117.3	31.60
43	58.0	14.46	69.3	17.89	80.6	21.67	86.2	23.65	91.9	25.58	103.1	30.15	114.4	34.52	
46	54.3	16.19	64.9	20.09	75.5	24.38	80.8	26.59	86.1	28.79	96.7	33.98	107.2	39.33	
48	48.1	14.11	57.4	17.53	66.8	21.30	71.5	23.22	76.2	25.15	85.5	29.71	94.9	34.41	
50	10	51.0	6.47	61.0	7.49	70.7	8.51	75.6	9.12	80.5	9.67	90.2	10.89	100.4	12.12
	12	51.0	6.53	61.0	7.56	70.7	8.64	75.6	9.26	80.5	9.87	90.2	11.09	100.4	12.32
	14	51.0	6.60	61.0	7.69	70.7	8.78	75.6	9.39	80.5	10.01	90.2	11.23	100.4	12.52
	16	51.0	6.74	61.0	7.83	70.7	8.92	75.6	9.60	80.5	10.14	90.2	11.44	100.4	12.73
	18	51.0	6.81	61.0	7.90	70.7	9.05	75.6	9.73	80.5	10.35	90.2	11.64	100.4	13.00
	20	51.0	6.87	61.0	8.03	70.7	9.26	75.6	9.87	80.5	10.55	90.2	11.84	100.4	13.27
	21	51.0	6.94	61.0	8.10	70.7	9.33	75.6	10.01	80.5	10.62	90.2	11.98	100.4	13.41
	23	51.0	7.08	61.0	8.24	70.7	9.46	75.6	10.14	80.5	10.82	90.2	12.18	100.4	13.68
	25	51.0	7.15	61.0	8.37	70.7	9.67	75.6	10.35	80.5	11.16	90.2	12.80	100.4	14.63
	27	51.0	7.28	61.0	8.64	70.7	10.21	75.6	11.03	80.5	11.84	90.2	13.68	100.4	15.59
	29	51.0	7.69	61.0	9.19	70.7	10.82	75.6	11.71	80.5	12.59	90.2	14.50	100.4	16.54
	31	51.0	8.10	61.0	9.73	70.7	11.50	75.6	12.39	80.5	13.41	90.2	15.45	100.4	17.63
	33	51.0	8.58	61.0	10.28	70.7	12.18	75.6	13.14	80.5	14.23	90.2	16.40	100.4	18.79
	35	51.0	9.05	61.0	10.89	70.7	12.86	75.6	13.95	80.5	15.04	90.2	17.36	100.4	19.94
	37	51.0	9.60	61.0	11.50	70.7	13.61	75.6	14.77	80.5	15.93	90.2	18.51	100.4	21.17
	39	51.0	10.24	61.0	12.33	70.7	14.59	75.6	15.90	80.5	17.09	90.2	19.72	100.4	22.86
	41	49.7	11.07	59.5	13.35	68.9	15.95	73.7	17.22	78.4	18.52	87.9	21.62	97.9	24.83
43	48.5	12.03	58.0	14.52	67.2	17.35	71.8	18.75	76.5	20.16	85.7	23.57	95.4	27.09	
46	45.4	13.47	54.3	16.28	63.0	19.47	67.3	21.06	71.7	22.63	80.3	26.52	89.5	30.49	
48	40.2	11.74	48.1	14.20	55.7	16.98	59.6	18.38	63.4	19.75	71.0	23.18	79.1	26.66	

**Note**

1. TC: Total Capacity(kW), PI : Power Input(kW, Comp. + Outdoor fan motor)
2. Capacity tables show the average value of conditions which may occur.

# 7. Capacity Tables

◆ ARUM560LTE5

Cooling Capacity (56HP)

Combination (%)	Outdoor air temp. (DB, °C)	Indoor air temp. (DB/WB, °C)													
		20		23		26		27		28		30		32	
		14	16	16	18	18	19	20	20	22	22	24	24		
		TC	PI	TC	PI	TC	PI	TC	PI	TC	PI	TC	PI	TC	PI
130	10	155.3	16.07	185.0	19.64	198.2	22.78	203.9	23.25	209.6	23.43	219.7	23.62	225.4	23.71
	12	155.3	16.47	185.0	20.34	198.2	23.72	203.9	23.87	209.6	24.06	219.7	24.25	225.4	24.47
	14	155.3	17.02	185.0	21.08	198.2	24.61	203.9	24.79	209.6	24.99	219.7	25.19	225.4	25.41
	16	155.3	17.64	185.0	21.81	198.2	25.71	203.9	25.95	209.6	26.16	219.7	26.39	225.4	26.60
	18	155.3	18.38	185.0	23.07	198.2	26.89	203.9	27.47	209.6	27.69	219.7	27.97	225.4	28.16
	20	155.3	19.19	185.0	24.58	198.2	28.22	203.9	30.22	209.6	30.46	216.5	30.77	222.2	30.98
	21	155.3	19.69	185.0	25.45	198.2	28.81	203.9	31.98	209.6	32.24	215.3	32.56	221.0	32.78
	23	155.3	21.13	185.0	26.77	198.2	30.31	203.9	35.29	206.9	35.57	212.1	35.92	217.8	36.17
	25	155.3	22.57	185.0	28.31	198.2	32.39	201.5	39.14	203.9	39.45	209.6	39.84	215.3	40.11
	27	155.3	24.15	185.0	30.26	195.7	34.51	198.2	43.08	201.5	43.43	206.9	43.86	212.1	44.16
	29	155.3	25.73	185.0	32.35	192.5	37.13	195.3	47.35	198.2	47.63	203.9	48.06	209.6	48.25
	31	155.3	27.46	184.4	34.08	189.4	39.49	192.5	47.15	195.3	47.44	200.7	47.86	206.4	48.05
	33	155.3	29.25	181.2	36.11	186.9	42.36	189.9	46.72	192.5	47.00	198.2	47.42	203.2	47.61
	35	155.3	31.20	178.0	37.81	183.7	45.88	186.9	46.11	189.9	46.39	195.0	46.80	200.7	46.99
	37	155.3	33.27	175.5	39.68	181.2	45.28	183.7	45.50	186.9	45.78	191.9	46.19	197.6	46.37
	39	155.3	35.42	172.4	41.77	178.0	44.67	181.2	44.89	183.7	45.16	189.4	45.57	195.0	45.75
41	151.3	37.58	165.2	43.86	170.8	44.06	173.3	44.29	176.7	44.55	182.1	44.95	187.0	45.13	
43	147.6	39.63	158.3	43.24	163.8	43.46	166.3	43.68	169.6	43.94	174.9	44.33	179.6	44.51	
46	138.3	42.42	144.4	42.33	149.7	42.55	152.0	42.76	155.2	43.02	160.1	43.40	164.5	43.57	
48	122.4	41.24	125.4	41.36	130.1	41.45	132.2	41.56	135.0	41.92	139.3	42.19	143.2	42.35	
120	10	140.5	14.46	167.1	17.73	182.6	21.06	188.2	22.76	193.7	23.12	204.3	23.22	209.2	23.40
	12	140.5	14.85	167.1	18.32	182.6	21.91	188.2	23.24	193.7	23.98	204.3	24.27	209.2	24.46
	14	140.5	15.36	167.1	18.95	182.6	22.80	188.2	24.13	193.7	24.86	204.3	25.22	209.2	25.43
	16	140.5	15.91	167.1	19.72	182.6	23.68	188.2	25.03	193.7	26.01	204.3	26.33	209.2	26.54
	18	140.5	16.54	167.1	20.61	182.6	24.62	188.2	26.34	193.7	27.34	204.3	27.65	209.2	27.87
	20	140.5	17.16	167.1	21.85	182.6	25.95	188.2	27.72	193.7	28.79	204.3	29.17	209.2	29.40
	21	140.5	17.68	167.1	22.64	182.6	26.68	188.2	28.54	193.7	29.74	204.3	30.11	209.2	30.36
	23	140.5	18.90	167.1	24.22	182.6	28.58	188.2	30.33	193.7	31.70	204.3	32.02	209.2	32.28
	25	140.5	20.20	167.1	25.95	182.6	30.15	188.2	32.33	193.7	34.00	201.8	34.28	206.7	34.56
	27	140.5	21.56	167.1	27.75	182.6	32.08	188.2	34.54	193.7	36.54	198.7	36.78	203.7	37.08
	29	140.5	23.00	167.1	29.61	182.6	33.76	188.2	36.96	190.6	38.94	195.6	39.52	201.2	39.84
	31	140.5	24.51	167.1	31.63	182.6	35.51	185.7	39.60	188.2	41.77	193.1	42.51	198.0	42.85
	33	140.5	26.09	167.1	33.71	180.2	37.56	182.6	42.98	185.1	44.85	190.0	45.36	195.0	45.72
	35	140.5	27.75	167.1	35.94	177.0	39.75	179.5	47.35	182.6	47.59	187.6	47.73	192.5	48.11
	37	140.5	29.84	167.1	37.92	174.5	42.38	177.0	46.35	179.5	46.59	184.5	46.73	189.4	47.10
	39	140.5	32.13	166.5	40.08	171.5	44.95	173.9	45.40	176.4	45.63	182.0	45.77	186.9	46.13
41	136.9	34.41	159.2	42.24	164.6	44.07	166.9	44.45	169.4	44.67	174.3	44.81	179.2	45.16	
43	133.6	36.73	152.6	41.64	157.9	43.08	160.1	43.50	162.5	43.72	167.3	43.85	172.1	44.19	
46	125.2	39.50	139.1	40.64	144.2	41.73	146.3	42.07	148.5	42.28	153.0	42.41	157.5	42.74	
48	110.7	38.69	120.8	39.92	125.3	40.91	127.2	41.16	129.1	41.29	133.1	41.46	137.1	41.62	
110	10	125.9	13.00	150.1	15.85	167.7	18.82	172.5	20.38	183.4	21.93	187.6	22.54	200.3	22.91
	12	125.9	13.41	150.1	16.38	167.7	19.61	172.5	20.95	183.4	22.75	187.6	23.49	200.3	24.03
	14	125.9	13.83	150.1	17.12	167.7	20.50	172.5	21.99	183.4	23.90	187.6	24.58	200.3	25.10
	16	125.9	14.32	150.1	17.75	167.7	21.34	172.5	22.95	183.4	25.00	187.6	25.68	200.3	26.14
	18	125.9	14.85	150.1	18.48	167.7	22.57	172.5	24.17	183.4	26.37	187.6	26.89	200.3	27.40
	20	125.9	15.38	150.1	19.41	167.7	23.94	172.5	25.28	183.4	27.65	187.6	28.33	200.3	28.79
	21	125.9	15.72	150.1	19.98	167.7	24.55	172.5	25.96	183.4	28.42	187.6	29.14	200.3	29.60
	23	125.9	16.75	150.1	21.42	167.7	25.92	172.5	27.40	183.4	30.03	187.6	30.67	200.3	31.18
	25	125.9	17.90	150.1	22.86	167.7	27.38	172.5	28.97	183.4	31.72	187.6	32.18	197.9	32.84
	27	125.9	19.12	150.1	24.44	167.7	28.94	172.5	30.66	183.4	33.13	187.6	33.89	194.9	34.47
	29	125.9	20.41	150.1	26.09	167.7	30.58	172.5	32.47	183.4	35.01	187.6	35.62	192.5	36.16
	31	125.9	21.71	150.1	27.82	167.7	32.32	172.5	34.40	180.4	36.79	185.2	37.51	189.4	37.91
	33	125.9	23.14	150.1	29.61	167.7	34.14	172.5	36.46	177.9	38.85	182.2	39.50	187.0	39.72
	35	125.9	24.58	150.1	31.63	167.7	36.06	172.5	38.63	174.9	41.01	179.1	41.38	184.0	41.59
	37	125.9	26.05	150.1	33.57	167.7	38.07	170.1	40.93	171.9	43.25	176.7	43.40	181.0	43.52
	39	125.9	28.09	150.1	35.67	164.6	40.16	167.0	43.78	169.5	45.39	173.7	45.47	178.6	45.51
41	122.7	30.12	146.2	37.77	157.6	42.35	160.0	47.35	162.1	47.35	166.8	47.73	171.0	48.11	
43	119.6	31.63	142.6	39.35	151.0	44.91	153.5	45.42	155.5	45.32	160.1	45.58	164.1	45.70	
46	112.1	30.87	133.7	37.99	137.8	42.63	140.2	42.62	142.0	42.99	146.3	43.23	150.1	43.35	
48	99.2	29.98	116.2	36.60	119.7	40.56	121.8	40.83	123.4	41.02	127.3	41.14	130.6	41.30	

# 7. Capacity Tables

Cooling Capacity (56HP)

Combination (%)	Outdoor air temp. (DB, °C)	Indoor air temp. (DB/WB, °C)													
		20		23		26		27		28		30		32	
		14		16		18		19		20		22		24	
		TC	PI	TC	PI	TC	PI	TC	PI	TC	PI	TC	PI	TC	PI
100	10	105.8	11.71	126.0	14.23	146.7	16.88	156.8	18.24	166.9	19.60	185.0	21.82	189.1	22.00
	12	105.8	12.08	126.0	14.81	146.7	17.45	156.8	18.74	166.9	20.23	185.0	22.99	189.1	23.22
	14	105.8	12.46	126.0	15.40	146.7	18.19	156.8	19.55	166.9	21.10	185.0	24.28	189.1	24.51
	16	105.8	12.84	126.0	15.91	146.7	18.97	156.8	20.47	166.9	22.24	185.0	25.45	189.1	25.81
	18	105.8	13.22	126.0	16.50	146.7	19.70	156.8	21.47	166.9	23.58	185.0	26.89	189.1	27.11
	20	105.8	13.69	126.0	17.13	146.7	20.84	156.8	23.00	166.9	25.23	185.0	28.18	189.1	28.40
	21	105.8	13.98	126.0	17.54	146.7	21.56	156.8	23.79	166.9	26.16	185.0	28.82	189.1	29.05
	23	105.8	14.81	126.0	18.76	146.7	23.14	156.8	25.52	166.9	28.03	185.0	30.18	189.1	30.42
	25	105.8	15.74	126.0	19.98	146.7	24.73	156.8	27.31	166.9	29.97	185.0	31.47	187.5	31.72
	27	105.8	16.82	126.0	21.35	146.7	26.45	156.8	29.18	166.9	31.87	181.4	32.95	185.2	33.21
	29	105.8	17.90	126.0	22.79	146.7	28.25	156.8	31.20	166.9	33.73	178.0	34.28	182.4	34.55
	31	105.8	19.12	126.0	24.29	146.7	30.12	156.8	33.28	166.9	35.44	175.4	35.60	179.6	35.89
	33	105.8	20.27	126.0	25.88	146.7	32.13	156.8	35.51	166.9	36.77	172.6	36.93	176.8	37.22
	35	105.8	21.56	126.0	27.53	146.7	34.21	156.8	37.88	164.3	38.11	169.4	38.26	173.7	38.56
	37	105.8	23.09	126.0	29.53	146.7	36.24	156.8	39.68	161.6	39.88	166.3	40.04	170.2	40.41
	39	105.8	24.76	126.0	31.72	146.7	38.40	156.8	41.62	158.9	41.81	163.6	41.96	167.4	42.35
41	104.2	26.42	124.0	33.91	144.4	40.57	150.4	43.56	153.8	43.74	157.4	43.89	162.5	44.30	
43	100.6	27.97	119.7	35.95	139.4	42.51	144.3	45.23	145.9	45.39	150.4	45.54	154.4	45.97	
46	94.3	30.08	112.2	38.75	130.7	45.09	131.7	47.35	133.1	47.49	137.4	47.63	141.1	48.08	
48	83.4	25.97	99.3	33.53	112.8	38.54	114.5	40.18	115.6	40.31	119.5	40.40	122.7	40.72	
90	10	95.2	10.91	113.7	13.12	132.2	15.46	141.1	16.66	150.1	17.94	168.6	20.07	187.0	22.00
	12	95.2	11.04	113.7	13.32	132.2	15.73	141.1	17.00	150.1	18.34	168.6	20.47	187.0	22.72
	14	95.2	11.24	113.7	13.59	132.2	16.06	141.1	17.33	150.1	18.67	168.6	20.87	187.0	23.18
	16	95.2	11.44	113.7	13.85	132.2	16.40	141.1	17.67	150.1	19.01	168.6	21.27	187.0	23.58
	18	95.2	11.64	113.7	14.12	132.2	16.66	141.1	18.07	150.1	19.41	168.6	21.73	187.0	24.76
	20	95.2	11.85	113.7	14.39	132.2	17.00	141.1	18.40	150.1	20.14	168.6	23.25	187.0	25.95
	21	95.2	11.98	113.7	14.52	132.2	17.33	141.1	19.01	150.1	20.88	168.6	23.63	187.0	26.54
	23	95.2	12.25	113.7	15.12	132.2	18.54	141.1	20.41	150.1	22.35	168.6	25.06	184.5	27.79
	25	95.2	12.85	113.7	16.13	132.2	19.81	141.1	21.82	150.1	23.89	168.6	26.80	181.8	28.98
	27	95.2	13.72	113.7	17.20	132.2	21.15	141.1	23.29	150.1	25.56	168.6	28.49	179.1	30.34
	29	95.2	14.52	113.7	18.34	132.2	22.62	141.1	24.90	150.1	27.30	168.6	30.18	176.5	31.56
	31	95.2	15.46	113.7	19.54	132.2	24.09	141.1	26.50	150.1	29.11	168.6	31.69	173.8	32.78
	33	95.2	16.46	113.7	20.81	132.2	25.70	141.1	28.24	150.1	30.88	168.6	33.22	171.1	34.00
	35	95.2	17.47	113.7	22.08	132.2	27.30	141.1	30.12	150.1	32.74	165.7	35.13	168.5	35.93
	37	95.2	18.54	113.7	23.49	132.2	29.11	141.1	31.99	150.1	34.56	163.0	36.72	165.8	37.54
	39	95.2	19.63	113.7	24.98	132.2	30.81	141.1	34.04	150.1	36.34	160.3	38.71	163.2	39.18
41	92.8	21.96	110.8	27.70	128.8	33.82	137.5	37.23	146.2	39.24	153.6	40.80	156.4	41.73	
43	90.5	23.71	108.0	29.93	125.6	36.94	134.1	40.10	142.6	42.07	147.3	43.65	150.0	44.22	
46	84.8	26.68	101.2	34.09	117.7	42.09	125.7	45.46	129.6	46.74	134.5	47.55	137.0	47.82	
48	75.0	23.32	89.6	29.82	104.1	36.83	111.2	39.65	112.5	40.10	116.9	40.40	119.1	40.72	
80	10	84.6	10.18	100.8	12.23	117.0	14.35	125.4	15.48	133.8	16.61	150.1	18.94	166.3	20.57
	12	84.6	10.39	100.8	12.37	117.0	14.63	125.4	15.76	133.8	16.89	150.1	19.30	166.3	20.97
	14	84.6	10.53	100.8	12.65	117.0	14.84	125.4	16.05	133.8	17.18	150.1	19.65	166.3	21.38
	16	84.6	10.67	100.8	12.86	117.0	15.13	125.4	16.33	133.8	17.53	150.1	20.07	166.3	21.79
	18	84.6	10.89	100.8	13.08	117.0	15.41	125.4	16.61	133.8	17.88	150.1	20.43	166.3	22.26
	20	84.6	11.10	100.8	13.36	117.0	15.76	125.4	16.96	133.8	18.24	150.1	21.21	166.3	23.59
	21	84.6	11.17	100.8	13.50	117.0	15.90	125.4	17.18	133.8	18.66	150.1	21.88	166.3	24.21
	23	84.6	11.38	100.8	13.71	117.0	16.61	125.4	18.24	133.8	19.93	150.1	23.10	166.3	25.41
	25	84.6	11.80	100.8	14.63	117.0	17.81	125.4	19.51	133.8	21.35	150.1	24.72	166.3	27.17
	27	84.6	12.51	100.8	15.55	117.0	19.01	125.4	20.85	133.8	22.76	150.1	26.26	166.3	28.59
	29	84.6	13.29	100.8	16.61	117.0	20.22	125.4	22.20	133.8	24.32	150.1	28.14	166.3	29.98
	31	84.6	14.14	100.8	17.60	117.0	21.56	125.4	23.68	133.8	25.87	150.1	29.86	166.3	31.47
	33	84.6	14.99	100.8	18.80	117.0	22.97	125.4	25.23	133.8	27.57	150.1	31.46	166.3	32.98
	35	84.6	15.90	100.8	19.93	117.0	24.46	125.4	26.86	133.8	29.41	150.1	33.36	164.6	34.85
	37	84.6	16.82	100.8	21.19	117.0	25.94	125.4	28.56	133.8	31.24	150.1	35.21	161.9	36.50
	39	84.6	17.78	100.8	22.41	117.0	27.75	125.4	30.70	133.8	33.58	150.1	37.20	159.2	38.51
41	82.4	19.67	98.2	24.83	114.0	30.46	122.2	33.65	130.4	36.89	146.2	39.98	152.6	40.90	
43	80.4	21.65	95.8	27.10	111.2	33.24	119.2	36.68	127.2	40.32	142.6	42.77	146.3	43.77	
46	75.3	24.09	89.8	30.52	104.2	37.46	111.7	40.82	119.2	45.49	130.4	47.55	133.5	47.82	
48	66.6	21.04	79.4	26.69	92.2	32.76	98.8	35.66	105.4	39.76	113.3	40.40	116.0	40.72	

# 7. Capacity Tables

Cooling Capacity (56HP)

Combination (%)	Outdoor air temp. (DB, °C)	Indoor air temp. (DB/WB, °C)													
		20		23		26		27		28		30		32	
		14	16	18	19	20	22	24	TC	PI	TC	PI	TC	PI	
70	10	73.9	9.01	88.5	10.71	102.5	12.41	109.8	13.40	117.0	14.33	131.0	16.31	145.6	18.25
	12	73.9	9.15	88.5	10.85	102.5	12.70	109.8	13.62	117.0	14.61	131.0	16.60	145.6	18.59
	14	73.9	9.29	88.5	10.99	102.5	12.91	109.8	13.83	117.0	14.82	131.0	16.95	145.6	18.93
	16	73.9	9.43	88.5	11.21	102.5	13.12	109.8	14.11	117.0	15.11	131.0	17.23	145.6	19.34
	18	73.9	9.57	88.5	11.42	102.5	13.40	109.8	14.40	117.0	15.39	131.0	17.52	145.6	19.68
	20	73.9	9.72	88.5	11.63	102.5	13.62	109.8	14.68	117.0	15.75	131.0	17.94	145.6	20.43
	21	73.9	9.86	88.5	11.70	102.5	13.76	109.8	14.82	117.0	15.89	131.0	18.23	145.6	20.86
	23	73.9	10.00	88.5	11.99	102.5	14.04	109.8	15.32	117.0	16.67	131.0	19.50	145.6	22.02
	25	73.9	10.14	88.5	12.41	102.5	14.97	109.8	16.38	117.0	17.80	131.0	20.85	145.6	23.09
	27	73.9	10.71	88.5	13.26	102.5	15.96	109.8	17.38	117.0	19.01	131.0	22.27	145.6	24.54
	29	73.9	11.42	88.5	14.04	102.5	16.95	109.8	18.51	117.0	20.21	131.0	23.76	145.6	26.29
	31	73.9	12.13	88.5	14.97	102.5	18.09	109.8	19.79	117.0	21.56	131.0	25.32	145.6	27.90
	33	73.9	12.84	88.5	15.82	102.5	19.22	109.8	20.99	117.0	22.91	131.0	26.95	145.6	29.70
	35	73.9	13.55	88.5	16.89	102.5	20.43	109.8	22.34	117.0	24.40	131.0	28.72	145.6	31.49
	37	73.9	14.40	88.5	17.88	102.5	21.70	109.8	23.76	117.0	25.96	131.0	30.57	145.6	33.24
	39	73.9	15.29	88.5	19.06	102.5	23.21	109.8	25.56	117.0	28.04	131.0	32.72	145.6	35.83
	41	72.0	16.90	86.2	20.89	99.9	25.46	107.0	28.04	114.0	30.48	127.7	35.93	141.9	38.66
43	70.2	18.40	84.1	22.76	97.4	27.78	104.3	30.57	111.2	33.29	124.5	39.25	138.4	41.79	
46	65.8	20.45	78.8	25.60	91.3	31.28	97.8	34.06	104.2	37.53	116.7	44.27	129.7	46.58	
48	58.2	17.84	69.7	22.36	80.7	27.35	86.5	29.76	92.2	32.83	103.2	38.74	114.7	40.19	
60	10	63.3	7.83	75.6	9.18	87.9	10.67	94.1	11.46	100.2	12.17	112.6	13.81	124.9	15.44
	12	63.3	7.97	75.6	9.32	87.9	10.82	94.1	11.60	100.2	12.38	112.6	14.02	124.9	15.73
	14	63.3	8.04	75.6	9.47	87.9	11.03	94.1	11.81	100.2	12.60	112.6	14.30	124.9	16.01
	16	63.3	8.18	75.6	9.68	87.9	11.17	94.1	12.03	100.2	12.88	112.6	14.59	124.9	16.30
	18	63.3	8.33	75.6	9.82	87.9	11.39	94.1	12.24	100.2	13.09	112.6	14.80	124.9	16.65
	20	63.3	8.47	75.6	9.96	87.9	11.60	94.1	12.45	100.2	13.31	112.6	15.09	124.9	17.01
	21	63.3	8.54	75.6	10.03	87.9	11.74	94.1	12.60	100.2	13.45	112.6	15.30	124.9	17.15
	23	63.3	8.68	75.6	10.25	87.9	11.88	94.1	12.81	100.2	13.74	112.6	15.87	124.9	18.22
	25	63.3	8.82	75.6	10.46	87.9	12.38	94.1	13.45	100.2	14.59	112.6	16.94	124.9	19.50
	27	63.3	9.11	75.6	11.03	87.9	13.17	94.1	14.30	100.2	15.51	112.6	18.01	124.9	20.78
	29	63.3	9.68	75.6	11.74	87.9	14.02	94.1	15.23	100.2	16.51	112.6	19.21	124.9	22.20
	31	63.3	10.25	75.6	12.45	87.9	14.87	94.1	16.23	100.2	17.58	112.6	20.50	124.9	23.63
	33	63.3	10.82	75.6	13.17	87.9	15.80	94.1	17.22	100.2	18.72	112.6	21.78	124.9	25.19
	35	63.3	11.46	75.6	14.02	87.9	16.80	94.1	18.29	100.2	19.86	112.6	23.20	124.9	26.76
	37	63.3	12.10	75.6	14.80	87.9	17.79	94.1	19.43	100.2	21.07	112.6	24.62	124.9	28.47
	39	63.3	12.87	75.6	15.75	87.9	19.20	94.1	20.84	100.2	22.67	112.6	26.40	124.9	30.50
	41	61.7	13.96	73.7	17.24	85.7	20.85	91.7	22.77	97.7	24.61	109.7	28.98	121.7	33.15
43	60.1	15.16	71.8	18.77	83.6	22.73	89.4	24.81	95.3	26.83	107.0	31.63	118.7	36.21	
46	56.4	16.98	67.3	21.07	78.3	25.57	83.8	27.89	89.3	30.19	100.2	35.64	111.2	41.25	
48	49.9	14.80	59.6	18.39	69.3	22.34	74.1	24.36	79.0	26.39	88.7	31.17	98.4	36.09	
50	10	52.9	6.78	63.3	7.85	73.4	8.93	78.4	9.57	83.4	10.14	93.5	11.43	104.2	12.71
	12	52.9	6.86	63.3	7.93	73.4	9.07	78.4	9.71	83.4	10.35	93.5	11.64	104.2	12.92
	14	52.9	6.93	63.3	8.07	73.4	9.21	78.4	9.85	83.4	10.50	93.5	11.78	104.2	13.14
	16	52.9	7.07	63.3	8.21	73.4	9.35	78.4	10.07	83.4	10.64	93.5	12.00	104.2	13.35
	18	52.9	7.14	63.3	8.28	73.4	9.50	78.4	10.21	83.4	10.85	93.5	12.21	104.2	13.64
	20	52.9	7.21	63.3	8.43	73.4	9.71	78.4	10.35	83.4	11.07	93.5	12.42	104.2	13.92
	21	52.9	7.28	63.3	8.50	73.4	9.78	78.4	10.50	83.4	11.14	93.5	12.57	104.2	14.07
	23	52.9	7.43	63.3	8.64	73.4	9.93	78.4	10.64	83.4	11.35	93.5	12.78	104.2	14.35
	25	52.9	7.50	63.3	8.78	73.4	10.14	78.4	10.85	83.4	11.71	93.5	13.42	104.2	15.35
	27	52.9	7.64	63.3	9.07	73.4	10.71	78.4	11.57	83.4	12.42	93.5	14.35	104.2	16.35
	29	52.9	8.07	63.3	9.64	73.4	11.35	78.4	12.28	83.4	13.21	93.5	15.21	104.2	17.35
	31	52.9	8.50	63.3	10.21	73.4	12.07	78.4	13.00	83.4	14.07	93.5	16.21	104.2	18.49
	33	52.9	9.00	63.3	10.78	73.4	12.78	78.4	13.78	83.4	14.92	93.5	17.21	104.2	19.71
	35	52.9	9.50	63.3	11.43	73.4	13.50	78.4	14.64	83.4	15.78	93.5	18.21	104.2	20.92
	37	52.9	10.07	63.3	12.07	73.4	14.28	78.4	15.50	83.4	16.71	93.5	19.42	104.2	22.21
	39	52.9	10.74	63.3	12.94	73.4	15.30	78.4	16.68	83.4	17.93	93.5	20.69	104.2	23.99
	41	51.6	11.61	61.7	14.00	71.5	16.73	76.4	18.06	81.3	19.43	91.1	22.68	101.5	26.05
43	50.3	12.62	60.1	15.23	69.7	18.20	74.5	19.67	79.3	21.15	88.9	24.73	99.0	28.41	
46	47.1	14.14	56.4	17.08	65.3	20.42	69.8	22.09	74.3	23.74	83.3	27.82	92.8	31.99	
48	41.7	12.32	49.9	14.90	57.8	17.81	61.8	19.28	65.7	20.72	73.7	24.31	82.1	27.96	

**Note**

1. TC: Total Capacity(kW), PI : Power Input(kW, Comp. + Outdoor fan motor)
2. Capacity tables show the average value of conditions which may occur.

# 7. Capacity Tables

◆ ARUM580LTE5

Cooling Capacity (58HP)

Combination (%)	Outdoor air temp. (DB, °C)	Indoor air temp. (DB/WB, °C)													
		20		23		26		27		28		30		32	
		14	16	16	18	18	19	20	20	22	22	24	24		
		TC	PI	TC	PI	TC	PI	TC	PI	TC	PI	TC	PI	TC	PI
130	10	160.9	17.41	191.6	21.28	205.3	24.68	211.2	25.18	217.1	25.39	227.5	25.59	233.4	25.69
	12	160.9	17.84	191.6	22.04	205.3	25.70	211.2	25.86	217.1	26.07	227.5	26.28	233.4	26.51
	14	160.9	18.44	191.6	22.84	205.3	26.66	211.2	26.86	217.1	27.07	227.5	27.29	233.4	27.53
	16	160.9	19.11	191.6	23.63	205.3	27.86	211.2	28.12	217.1	28.34	227.5	28.59	233.4	28.82
	18	160.9	19.91	191.6	25.00	205.3	29.14	211.2	29.76	217.1	30.00	227.5	30.30	233.4	30.51
	20	160.9	20.79	191.6	26.63	205.3	30.57	211.2	32.74	217.1	33.00	224.2	33.33	230.1	33.56
	21	160.9	21.34	191.6	27.57	205.3	31.22	211.2	34.65	217.1	34.93	223.0	35.27	228.9	35.52
	23	160.9	22.90	191.6	29.00	205.3	32.84	211.2	38.23	214.3	38.54	219.7	38.92	225.6	39.19
	25	160.9	24.45	191.6	30.67	205.3	35.09	208.7	42.40	211.2	42.74	217.1	43.16	223.0	43.46
	27	160.9	26.17	191.6	32.78	202.7	37.39	205.3	46.68	208.7	47.05	214.3	47.52	219.7	47.85
	29	160.9	27.88	191.6	35.05	199.4	40.23	202.3	51.30	205.3	51.61	211.2	52.07	217.1	52.27
	31	160.9	29.75	190.9	36.92	196.1	42.79	199.4	51.09	202.3	51.39	207.9	51.85	213.8	52.06
	33	160.9	31.70	187.6	39.12	193.5	45.89	196.7	50.62	199.4	50.92	205.3	51.38	210.5	51.58
	35	160.9	33.80	184.3	40.97	190.2	49.71	193.5	49.96	196.7	50.26	202.0	50.71	207.9	50.91
	37	160.9	36.04	181.7	42.99	187.6	49.05	190.2	49.30	193.5	49.59	198.8	50.04	204.7	50.24
	39	160.9	38.38	178.5	45.25	184.3	48.40	187.6	48.64	190.2	48.93	196.1	49.37	202.0	49.56
	41	156.7	40.71	171.1	47.52	176.9	47.74	179.5	47.98	183.0	48.27	188.6	48.70	193.7	48.89
	43	152.9	42.94	164.0	46.85	169.7	47.08	172.3	47.32	175.7	47.60	181.1	48.03	186.0	48.22
46	143.3	45.96	149.6	45.87	155.0	46.10	157.4	46.33	160.7	46.61	165.8	47.02	170.3	47.21	
48	126.7	44.68	129.9	44.81	134.8	44.91	136.9	45.03	139.8	45.42	144.3	45.71	148.3	45.89	
120	10	145.6	15.66	173.1	19.20	189.1	22.82	194.9	24.66	200.7	25.05	211.6	25.15	216.7	25.35
	12	145.6	16.09	173.1	19.85	189.1	23.74	194.9	25.18	200.7	25.98	211.6	26.29	216.7	26.50
	14	145.6	16.64	173.1	20.53	189.1	24.70	194.9	26.14	200.7	26.93	211.6	27.33	216.7	27.55
	16	145.6	17.24	173.1	21.37	189.1	25.65	194.9	27.12	200.7	28.18	211.6	28.52	216.7	28.75
	18	145.6	17.91	173.1	22.33	189.1	26.68	194.9	28.54	200.7	29.62	211.6	29.96	216.7	30.20
	20	145.6	18.60	173.1	23.67	189.1	28.11	194.9	30.04	200.7	31.19	211.6	31.60	216.7	31.85
	21	145.6	19.16	173.1	24.53	189.1	28.90	194.9	30.92	200.7	32.22	211.6	32.63	216.7	32.89
	23	145.6	20.48	173.1	26.24	189.1	30.97	194.9	32.86	200.7	34.35	211.6	34.70	216.7	34.97
	25	145.6	21.88	173.1	28.11	189.1	32.66	194.9	35.02	200.7	36.83	209.0	37.14	214.1	37.44
	27	145.6	23.36	173.1	30.06	189.1	34.76	194.9	37.42	200.7	39.58	205.8	39.85	211.0	40.17
	29	145.6	24.92	173.1	32.08	189.1	36.58	194.9	40.05	197.4	42.19	202.6	42.82	208.3	43.16
	31	145.6	26.56	173.1	34.26	189.1	38.47	192.4	42.90	194.9	45.25	200.0	46.06	205.1	46.42
	33	145.6	28.27	173.1	36.52	186.6	40.69	189.1	46.57	191.7	48.59	196.8	49.14	202.0	49.53
	35	145.6	30.06	173.1	38.94	183.4	43.07	185.9	51.30	189.1	51.56	194.3	51.71	199.3	52.12
	37	145.6	32.33	173.1	41.09	180.8	45.92	183.4	50.22	185.9	50.47	191.0	50.62	196.2	51.03
	39	145.6	34.81	172.5	43.43	177.6	48.70	180.1	49.19	182.7	49.44	188.5	49.58	193.6	49.98
	41	141.8	37.28	164.9	45.76	170.5	47.74	172.9	48.16	175.4	48.40	180.5	48.54	185.6	48.93
	43	138.3	39.79	158.0	45.11	163.5	46.67	165.8	47.13	168.3	47.36	173.3	47.50	178.3	47.88
46	129.6	42.79	144.1	44.03	149.3	45.21	151.5	45.58	153.8	45.81	158.5	45.94	163.2	46.31	
48	114.7	41.92	125.1	43.25	129.8	44.33	131.7	44.59	133.8	44.74	137.9	44.92	142.0	45.10	
110	10	130.4	14.09	155.4	17.17	173.6	20.40	178.6	22.08	189.9	23.76	194.3	24.42	207.5	24.83
	12	130.4	14.53	155.4	17.75	173.6	21.24	178.6	22.70	189.9	24.65	194.3	25.44	207.5	26.03
	14	130.4	14.98	155.4	18.55	173.6	22.20	178.6	23.82	189.9	25.89	194.3	26.63	207.5	27.19
	16	130.4	15.51	155.4	19.23	173.6	23.12	178.6	24.87	189.9	27.09	194.3	27.83	207.5	28.32
	18	130.4	16.09	155.4	20.03	173.6	24.45	178.6	26.18	189.9	28.57	194.3	29.14	207.5	29.68
	20	130.4	16.66	155.4	21.03	173.6	25.93	178.6	27.39	189.9	29.96	194.3	30.70	207.5	31.19
	21	130.4	17.03	155.4	21.65	173.6	26.60	178.6	28.12	189.9	30.79	194.3	31.57	207.5	32.06
	23	130.4	18.14	155.4	23.21	173.6	28.08	178.6	29.69	189.9	32.53	194.3	33.23	207.5	33.78
	25	130.4	19.39	155.4	24.76	173.6	29.67	178.6	31.39	189.9	34.37	194.3	34.86	204.9	35.58
	27	130.4	20.71	155.4	26.48	173.6	31.35	178.6	33.22	189.9	35.90	194.3	36.72	201.9	37.34
	29	130.4	22.12	155.4	28.27	173.6	33.13	178.6	35.18	189.9	37.93	194.3	38.59	199.4	39.17
	31	130.4	23.52	155.4	30.14	173.6	35.01	178.6	37.27	186.8	39.86	191.8	40.64	196.2	41.07
	33	130.4	25.08	155.4	32.08	173.6	36.99	178.6	39.50	184.3	42.09	188.7	42.79	193.7	43.03
	35	130.4	26.63	155.4	34.26	173.6	39.07	178.6	41.85	181.2	44.43	185.5	44.84	190.6	45.06
	37	130.4	28.23	155.4	36.37	173.6	41.24	176.1	44.34	178.0	46.86	183.0	47.02	187.4	47.15
	39	130.4	30.43	155.4	38.64	170.5	43.51	173.0	47.43	175.5	49.18	179.9	49.26	184.9	49.31
	41	127.0	32.64	151.5	40.92	163.2	45.89	165.7	51.30	167.9	51.30	172.8	51.71	177.1	52.12
	43	123.9	34.27	147.7	42.63	156.4	48.66	159.0	49.21	161.0	49.10	165.8	49.38	170.0	49.52
46	116.1	33.45	138.4	41.16	142.7	46.18	145.2	46.18	147.1	46.58	151.6	46.84	155.5	46.96	
48	102.7	32.49	120.3	39.65	123.9	43.94	126.2	44.23	127.8	44.45	131.8	44.57	135.3	44.75	



# 7. Capacity Tables

Cooling Capacity (58HP)

Combination (%)	Outdoor air temp. (DB, °C)	Indoor air temp. (DB/WB, °C)													
		20		23		26		27		28		30		32	
		14		16		18		19		20		22		24	
		TC	PI	TC	PI	TC	PI	TC	PI	TC	PI	TC	PI	TC	PI
100	10	109.6	12.69	130.5	15.42	152.0	18.29	162.4	19.76	172.8	21.24	191.6	23.64	195.8	23.83
	12	109.6	13.09	130.5	16.05	152.0	18.91	162.4	20.30	172.8	21.92	191.6	24.91	195.8	25.16
	14	109.6	13.50	130.5	16.69	152.0	19.71	162.4	21.18	172.8	22.86	191.6	26.31	195.8	26.55
	16	109.6	13.91	130.5	17.24	152.0	20.55	162.4	22.18	172.8	24.09	191.6	27.58	195.8	27.96
	18	109.6	14.32	130.5	17.88	152.0	21.35	162.4	23.26	172.8	25.54	191.6	29.13	195.8	29.37
	20	109.6	14.84	130.5	18.56	152.0	22.58	162.4	24.92	172.8	27.33	191.6	30.53	195.8	30.77
	21	109.6	15.14	130.5	19.00	152.0	23.36	162.4	25.78	172.8	28.35	191.6	31.23	195.8	31.48
	23	109.6	16.04	130.5	20.33	152.0	25.08	162.4	27.65	172.8	30.37	191.6	32.70	195.8	32.96
	25	109.6	17.05	130.5	21.65	152.0	26.79	162.4	29.59	172.8	32.47	191.6	34.09	194.2	34.37
	27	109.6	18.22	130.5	23.13	152.0	28.66	162.4	31.62	172.8	34.53	187.9	35.70	191.9	35.98
	29	109.6	19.39	130.5	24.69	152.0	30.60	162.4	33.80	172.8	36.54	184.4	37.14	189.0	37.43
	31	109.6	20.71	130.5	26.32	152.0	32.63	162.4	36.06	172.8	38.40	181.6	38.57	186.1	38.88
	33	109.6	21.96	130.5	28.03	152.0	34.81	162.4	38.47	172.8	39.84	178.7	40.01	183.2	40.33
	35	109.6	23.36	130.5	29.83	152.0	37.07	162.4	41.04	170.2	41.29	175.5	41.45	179.9	41.78
	37	109.6	25.02	130.5	31.99	152.0	39.27	162.4	42.99	167.4	43.21	172.2	43.38	176.3	43.78
	39	109.6	26.82	130.5	34.37	152.0	41.61	162.4	45.10	164.6	45.30	169.5	45.46	173.4	45.89
	41	107.9	28.63	128.4	36.74	149.6	43.95	155.8	47.20	159.3	47.38	163.0	47.55	168.3	48.00
	43	104.2	30.30	124.0	38.95	144.4	46.05	149.4	49.00	151.1	49.18	155.8	49.34	159.9	49.80
46	97.6	32.59	116.2	41.99	135.3	48.85	136.4	51.30	137.9	51.45	142.3	51.60	146.1	52.09	
48	86.4	28.14	102.8	36.33	116.8	41.76	118.6	43.53	119.8	43.67	123.7	43.77	127.1	44.12	
90	10	98.6	11.72	117.7	14.09	136.9	16.61	146.2	17.91	155.4	19.27	174.6	21.57	193.7	23.83
	12	98.6	11.87	117.7	14.31	136.9	16.90	146.2	18.26	155.4	19.70	174.6	22.00	193.7	24.41
	14	98.6	12.08	117.7	14.60	136.9	17.26	146.2	18.62	155.4	20.06	174.6	22.42	193.7	24.91
	16	98.6	12.30	117.7	14.89	136.9	17.62	146.2	18.98	155.4	20.42	174.6	22.85	193.7	25.33
	18	98.6	12.51	117.7	15.17	136.9	17.91	146.2	19.42	155.4	20.85	174.6	23.35	193.7	26.61
	20	98.6	12.73	117.7	15.46	136.9	18.26	146.2	19.78	155.4	21.64	174.6	24.99	193.7	27.88
	21	98.6	12.87	117.7	15.60	136.9	18.62	146.2	20.42	155.4	22.44	174.6	25.39	193.7	28.52
	23	98.6	13.16	117.7	16.25	136.9	19.92	146.2	21.93	155.4	24.02	174.6	26.93	191.1	29.86
	25	98.6	13.81	117.7	17.33	136.9	21.29	146.2	23.44	155.4	25.67	174.6	28.80	188.3	31.14
	27	98.6	14.74	117.7	18.48	136.9	22.72	146.2	25.02	155.4	27.47	174.6	30.62	185.5	32.60
	29	98.6	15.60	117.7	19.70	136.9	24.31	146.2	26.75	155.4	29.34	174.6	32.43	182.8	33.91
	31	98.6	16.61	117.7	21.00	136.9	25.89	146.2	28.48	155.4	31.28	174.6	34.05	180.0	35.23
	33	98.6	17.69	117.7	22.36	136.9	27.61	146.2	30.35	155.4	33.18	174.6	35.69	177.3	36.54
	35	98.6	18.77	117.7	23.73	136.9	29.34	146.2	32.36	155.4	35.18	171.6	37.74	174.5	38.61
	37	98.6	19.92	117.7	25.24	136.9	31.28	146.2	34.38	155.4	37.14	168.8	39.45	171.7	40.34
	39	98.6	21.09	117.7	26.85	136.9	33.11	146.2	36.58	155.4	39.05	166.1	41.60	169.0	42.10
	41	96.1	23.60	114.7	29.76	133.4	36.34	142.4	40.01	151.5	42.16	159.1	43.84	162.0	44.84
	43	93.7	25.47	111.9	32.16	130.1	39.70	138.9	43.08	147.7	45.21	152.6	46.94	155.3	47.51
46	87.8	28.67	104.9	36.63	121.9	45.23	130.2	48.85	134.2	50.23	139.3	51.46	141.9	51.60	
48	77.7	25.06	92.8	32.04	107.8	39.57	115.1	42.61	116.6	43.28	121.0	43.77	123.3	44.12	
80	10	87.6	10.92	104.4	13.12	121.2	15.40	129.9	16.61	138.6	17.82	155.4	20.33	172.3	22.07
	12	87.6	11.15	104.4	13.27	121.2	15.70	129.9	16.91	138.6	18.13	155.4	20.71	172.3	22.51
	14	87.6	11.30	104.4	13.58	121.2	15.93	129.9	17.22	138.6	18.43	155.4	21.09	172.3	22.94
	16	87.6	11.45	104.4	13.80	121.2	16.23	129.9	17.52	138.6	18.81	155.4	21.54	172.3	23.38
	18	87.6	11.68	104.4	14.03	121.2	16.54	129.9	17.82	138.6	19.19	155.4	21.92	172.3	23.89
	20	87.6	11.91	104.4	14.34	121.2	16.91	129.9	18.20	138.6	19.57	155.4	22.75	172.3	25.31
	21	87.6	11.98	104.4	14.49	121.2	17.07	129.9	18.43	138.6	20.02	155.4	23.47	172.3	25.98
	23	87.6	12.21	104.4	14.71	121.2	17.82	129.9	19.57	138.6	21.39	155.4	24.78	172.3	27.27
	25	87.6	12.67	104.4	15.70	121.2	19.11	129.9	20.93	138.6	22.91	155.4	26.52	172.3	29.16
	27	87.6	13.43	104.4	16.69	121.2	20.40	129.9	22.38	138.6	24.42	155.4	28.18	172.3	30.68
	29	87.6	14.26	104.4	17.82	121.2	21.69	129.9	23.82	138.6	26.09	155.4	30.20	172.3	32.22
	31	87.6	15.17	104.4	18.89	121.2	23.13	129.9	25.41	138.6	27.76	155.4	32.04	172.3	33.82
	33	87.6	16.08	104.4	20.18	121.2	24.65	129.9	27.08	138.6	29.58	155.4	33.76	172.3	35.44
	35	87.6	17.07	104.4	21.39	121.2	26.24	129.9	28.82	138.6	31.55	155.4	35.80	170.4	37.45
	37	87.6	18.05	104.4	22.74	121.2	27.84	129.9	30.64	138.6	33.53	155.4	37.78	167.7	39.17
	39	87.6	19.08	104.4	24.04	121.2	29.78	129.9	32.94	138.6	36.03	155.4	39.92	164.9	41.32
	41	85.3	21.10	101.7	26.64	118.1	32.68	126.6	36.11	135.1	39.59	151.5	42.96	158.0	43.94
	43	83.2	23.23	99.2	29.08	115.2	35.67	123.5	39.35	131.7	43.26	147.7	46.00	151.5	47.03
46	78.0	25.85	93.0	32.75	108.0	40.19	115.7	43.80	123.5	48.82	135.1	51.46	138.3	51.60	
48	69.0	22.57	82.2	28.64	95.5	35.15	102.4	38.26	109.2	42.73	117.3	43.77	120.1	44.12	

# 7. Capacity Tables

Cooling Capacity (58HP)

Combination (%)	Outdoor air temp. (DB, °C)	Indoor air temp. (DB/WB, °C)													
		20		23		26		27		28		30		32	
		14	16	18	19	20	22	24	TC	PI	TC	PI	TC	PI	
70	10	76.6	9.65	91.6	11.48	106.1	13.30	113.7	14.36	121.2	15.35	135.7	17.48	150.8	19.55
	12	76.6	9.80	91.6	11.63	106.1	13.60	113.7	14.59	121.2	15.66	135.7	17.78	150.8	19.92
	14	76.6	9.96	91.6	11.78	106.1	13.83	113.7	14.82	121.2	15.88	135.7	18.17	150.8	20.28
	16	76.6	10.11	91.6	12.01	106.1	14.06	113.7	15.12	121.2	16.19	135.7	18.47	150.8	20.72
	18	76.6	10.26	91.6	12.24	106.1	14.36	113.7	15.43	121.2	16.49	135.7	18.77	150.8	21.09
	20	76.6	10.41	91.6	12.46	106.1	14.59	113.7	15.73	121.2	16.87	135.7	19.23	150.8	21.89
	21	76.6	10.56	91.6	12.54	106.1	14.74	113.7	15.88	121.2	17.02	135.7	19.53	150.8	22.35
	23	76.6	10.72	91.6	12.84	106.1	15.05	113.7	16.42	121.2	17.86	135.7	20.90	150.8	23.60
	25	76.6	10.87	91.6	13.30	106.1	16.04	113.7	17.56	121.2	19.08	135.7	22.35	150.8	24.75
	27	76.6	11.48	91.6	14.21	106.1	17.10	113.7	18.62	121.2	20.37	135.7	23.87	150.8	26.30
	29	76.6	12.24	91.6	15.05	106.1	18.17	113.7	19.84	121.2	21.66	135.7	25.46	150.8	28.18
	31	76.6	13.00	91.6	16.04	106.1	19.38	113.7	21.21	121.2	23.11	135.7	27.13	150.8	29.90
	33	76.6	13.76	91.6	16.95	106.1	20.60	113.7	22.50	121.2	24.55	135.7	28.88	150.8	31.83
	35	76.6	14.52	91.6	18.10	106.1	21.89	113.7	23.94	121.2	26.15	135.7	30.78	150.8	33.75
	37	76.6	15.43	91.6	19.16	106.1	23.26	113.7	25.46	121.2	27.82	135.7	32.76	150.8	35.62
	39	76.6	16.38	91.6	20.43	106.1	24.87	113.7	27.39	121.2	30.05	135.7	35.06	150.8	38.40
41	74.6	18.11	89.3	22.38	103.4	27.28	110.8	30.05	118.1	32.67	132.2	38.51	146.9	41.43	
43	72.8	19.72	87.1	24.39	100.9	29.76	108.0	32.76	115.2	35.67	129.0	42.07	143.3	44.79	
46	68.2	21.91	81.6	27.43	94.5	33.52	101.2	36.49	108.0	40.21	120.9	47.44	134.3	49.92	
48	60.3	19.12	72.2	23.96	83.6	29.30	89.6	31.89	95.5	35.18	106.9	41.52	118.8	43.21	
60	10	65.5	8.38	78.3	9.82	91.1	11.42	97.4	12.26	103.8	13.02	116.6	14.77	129.3	16.53
	12	65.5	8.53	78.3	9.98	91.1	11.58	97.4	12.41	103.8	13.25	116.6	15.00	129.3	16.83
	14	65.5	8.61	78.3	10.13	91.1	11.80	97.4	12.64	103.8	13.48	116.6	15.31	129.3	17.14
	16	65.5	8.76	78.3	10.36	91.1	11.96	97.4	12.87	103.8	13.78	116.6	15.61	129.3	17.44
	18	65.5	8.91	78.3	10.51	91.1	12.19	97.4	13.10	103.8	14.01	116.6	15.84	129.3	17.82
	20	65.5	9.06	78.3	10.66	91.1	12.41	97.4	13.33	103.8	14.24	116.6	16.15	129.3	18.20
	21	65.5	9.14	78.3	10.74	91.1	12.57	97.4	13.48	103.8	14.39	116.6	16.37	129.3	18.35
	23	65.5	9.29	78.3	10.97	91.1	12.72	97.4	13.71	103.8	14.70	116.6	16.98	129.3	19.50
	25	65.5	9.44	78.3	11.20	91.1	13.25	97.4	14.39	103.8	15.61	116.6	18.13	129.3	20.87
	27	65.5	9.75	78.3	11.80	91.1	14.09	97.4	15.31	103.8	16.60	116.6	19.27	129.3	22.24
	29	65.5	10.36	78.3	12.57	91.1	15.00	97.4	16.30	103.8	17.67	116.6	20.56	129.3	23.76
	31	65.5	10.97	78.3	13.33	91.1	15.92	97.4	17.36	103.8	18.81	116.6	21.93	129.3	25.28
	33	65.5	11.58	78.3	14.09	91.1	16.91	97.4	18.43	103.8	20.03	116.6	23.30	129.3	26.96
	35	65.5	12.26	78.3	15.00	91.1	17.97	97.4	19.57	103.8	21.25	116.6	24.83	129.3	28.64
	37	65.5	12.95	78.3	15.83	91.1	19.04	97.4	20.79	103.8	22.54	116.6	26.35	129.3	30.46
	39	65.5	13.77	78.3	16.86	91.1	20.55	97.4	22.31	103.8	24.26	116.6	28.25	129.3	32.64
41	63.9	14.93	76.3	18.45	88.7	22.32	94.9	24.37	101.2	26.33	113.6	31.01	126.0	35.47	
43	62.3	16.23	74.4	20.09	86.5	24.33	92.6	26.55	98.7	28.72	110.8	33.85	122.9	38.75	
46	58.4	18.17	69.7	22.55	81.1	27.36	86.8	29.85	92.5	32.31	103.8	38.14	115.2	44.15	
48	51.6	15.84	61.7	19.68	71.7	23.91	76.8	26.07	81.8	28.24	91.8	33.36	101.9	38.62	
50	10	54.8	7.25	65.5	8.39	76.0	9.54	81.2	10.23	86.4	10.84	96.9	12.21	107.9	13.58
	12	54.8	7.33	65.5	8.47	76.0	9.69	81.2	10.38	86.4	11.07	96.9	12.44	107.9	13.81
	14	54.8	7.40	65.5	8.62	76.0	9.84	81.2	10.53	86.4	11.22	96.9	12.59	107.9	14.04
	16	54.8	7.56	65.5	8.78	76.0	10.00	81.2	10.76	86.4	11.37	96.9	12.82	107.9	14.27
	18	54.8	7.63	65.5	8.85	76.0	10.15	81.2	10.91	86.4	11.60	96.9	13.05	107.9	14.58
	20	54.8	7.71	65.5	9.01	76.0	10.38	81.2	11.07	86.4	11.83	96.9	13.28	107.9	14.88
	21	54.8	7.78	65.5	9.08	76.0	10.46	81.2	11.22	86.4	11.91	96.9	13.43	107.9	15.03
	23	54.8	7.94	65.5	9.23	76.0	10.61	81.2	11.37	86.4	12.13	96.9	13.66	107.9	15.34
	25	54.8	8.01	65.5	9.39	76.0	10.84	81.2	11.60	86.4	12.52	96.9	14.35	107.9	16.41
	27	54.8	8.17	65.5	9.69	76.0	11.45	81.2	12.36	86.4	13.28	96.9	15.34	107.9	17.48
	29	54.8	8.62	65.5	10.30	76.0	12.13	81.2	13.13	86.4	14.12	96.9	16.25	107.9	18.54
	31	54.8	9.08	65.5	10.91	76.0	12.90	81.2	13.89	86.4	15.03	96.9	17.32	107.9	19.77
	33	54.8	9.62	65.5	11.52	76.0	13.66	81.2	14.73	86.4	15.95	96.9	18.39	107.9	21.06
	35	54.8	10.15	65.5	12.21	76.0	14.42	81.2	15.64	86.4	16.87	96.9	19.46	107.9	22.36
	37	54.8	10.76	65.5	12.90	76.0	15.26	81.2	16.56	86.4	17.86	96.9	20.76	107.9	23.73
	39	54.8	11.48	65.5	13.82	76.0	16.35	81.2	17.83	86.4	19.16	96.9	22.11	107.9	25.63
41	53.4	12.41	63.9	14.97	74.0	17.88	79.1	19.31	84.2	20.76	94.4	24.24	105.1	27.84	
43	52.1	13.49	62.3	16.28	72.2	19.46	77.2	21.02	82.1	22.60	92.0	26.43	102.5	30.37	
46	48.8	15.11	58.4	18.26	67.7	21.83	72.3	23.61	77.0	25.38	86.3	29.74	96.1	34.19	
48	43.2	13.17	51.6	15.92	59.9	19.04	64.0	20.61	68.1	22.15	76.3	25.98	85.0	29.89	

**Note**

1. TC: Total Capacity(kW), PI : Power Input(kW, Comp. + Outdoor fan motor)
2. Capacity tables show the average value of conditions which may occur.

# 7. Capacity Tables

◆ ARUM600LTE5

Cooling Capacity (60HP)

Combination (%)	Outdoor air temp. (DB, °C)	Indoor air temp. (DB/WB, °C)													
		20		23		26		27		28		30		32	
		14	16	16	18	18	19	20	20	22	22	24	24		
		TC	PI	TC	PI	TC	PI	TC	PI	TC	PI	TC	PI	TC	PI
130	10	166.4	18.04	198.2	22.05	212.4	25.58	218.5	26.10	224.6	26.31	235.4	26.52	241.5	26.62
	12	166.4	18.49	198.2	22.84	212.4	26.63	218.5	26.80	224.6	27.02	235.4	27.23	241.5	27.47
	14	166.4	19.11	198.2	23.67	212.4	27.63	218.5	27.83	224.6	28.06	235.4	28.28	241.5	28.53
	16	166.4	19.80	198.2	24.49	212.4	28.87	218.5	29.14	224.6	29.37	235.4	29.63	241.5	29.87
	18	166.4	20.64	198.2	25.91	212.4	30.20	218.5	30.85	224.6	31.09	235.4	31.40	241.5	31.62
	20	166.4	21.55	198.2	27.60	212.4	31.68	218.5	33.93	224.6	34.20	232.0	34.54	238.1	34.78
	21	166.4	22.11	198.2	28.57	212.4	32.35	218.5	35.91	224.6	36.19	230.7	36.55	236.8	36.80
	23	166.4	23.73	198.2	30.05	212.4	34.03	218.5	39.62	221.7	39.94	227.3	40.33	233.3	40.61
	25	166.4	25.34	198.2	31.78	212.4	36.36	215.9	43.94	218.5	44.29	224.6	44.73	230.7	45.04
	27	166.4	27.12	198.2	33.97	209.7	38.74	212.4	48.37	215.9	48.76	221.7	49.24	227.3	49.58
	29	166.4	28.89	198.2	36.32	206.3	41.69	209.3	53.16	212.4	53.48	218.5	53.96	224.6	54.17
	31	166.4	30.83	197.5	38.26	202.9	44.34	206.3	52.94	209.3	53.26	215.1	53.73	221.2	53.95
	33	166.4	32.85	194.1	40.54	200.2	47.56	203.4	52.46	206.3	52.77	212.4	53.24	217.7	53.45
	35	166.4	35.02	190.7	42.45	196.8	51.51	200.2	51.77	203.4	52.08	209.0	52.55	215.1	52.76
	37	166.4	37.35	188.0	44.55	194.1	50.83	196.8	51.09	200.2	51.40	205.6	51.86	211.7	52.06
	39	166.4	39.77	184.7	46.90	190.7	50.15	194.1	50.41	196.8	50.71	202.9	51.16	209.0	51.36
	41	162.1	42.19	177.0	49.24	183.0	49.47	185.7	49.72	189.3	50.02	195.1	50.47	200.3	50.67
	43	158.1	44.50	169.6	48.55	175.5	48.79	178.2	49.04	181.8	49.33	187.3	49.77	192.4	49.97
46	148.2	47.63	154.7	47.53	160.4	47.77	162.9	48.01	166.3	48.30	171.5	48.73	176.2	48.92	
48	131.1	46.30	134.4	46.44	139.4	46.54	141.6	46.67	144.7	47.07	149.3	47.37	153.4	47.55	
120	10	150.6	16.23	179.0	19.90	195.6	23.65	201.6	25.56	207.6	25.96	218.9	26.07	224.2	26.27
	12	150.6	16.67	179.0	20.57	195.6	24.60	201.6	26.10	207.6	26.92	218.9	27.25	224.2	27.47
	14	150.6	17.24	179.0	21.27	195.6	25.59	201.6	27.09	207.6	27.91	218.9	28.32	224.2	28.55
	16	150.6	17.86	179.0	22.14	195.6	26.58	201.6	28.10	207.6	29.20	218.9	29.56	224.2	29.79
	18	150.6	18.56	179.0	23.14	195.6	27.64	201.6	29.58	207.6	30.70	218.9	31.05	224.2	31.30
	20	150.6	19.27	179.0	24.53	195.6	29.13	201.6	31.13	207.6	32.32	218.9	32.75	224.2	33.01
	21	150.6	19.85	179.0	25.42	195.6	29.95	201.6	32.04	207.6	33.39	218.9	33.81	224.2	34.08
	23	150.6	21.22	179.0	27.20	195.6	32.09	201.6	34.05	207.6	35.59	218.9	35.95	224.2	36.24
	25	150.6	22.68	179.0	29.13	195.6	33.85	201.6	36.30	207.6	38.17	216.2	38.49	221.5	38.80
	27	150.6	24.21	179.0	31.15	195.6	36.02	201.6	38.78	207.6	41.02	212.9	41.30	218.2	41.63
	29	150.6	25.82	179.0	33.25	195.6	37.90	201.6	41.50	204.2	43.72	209.6	44.38	215.5	44.73
	31	150.6	27.52	179.0	35.51	195.6	39.87	199.0	44.46	201.6	46.90	206.9	47.73	212.2	48.11
	33	150.6	29.29	179.0	37.85	193.0	42.17	195.6	48.26	198.3	50.35	203.6	50.93	208.9	51.33
	35	150.6	31.15	179.0	40.35	189.7	44.63	192.3	53.16	195.6	53.43	201.0	53.59	206.2	54.01
	37	150.6	33.51	179.0	42.58	187.0	47.59	189.7	52.04	192.3	52.31	197.6	52.46	203.0	52.88
	39	150.6	36.07	178.4	45.00	183.7	50.47	186.3	50.98	189.0	51.23	195.0	51.38	200.3	51.79
	41	146.7	38.64	170.6	47.42	176.4	49.48	178.9	49.91	181.5	50.16	186.7	50.31	192.0	50.70
	43	143.1	41.24	163.5	46.75	169.1	48.37	171.6	48.84	174.1	49.08	179.2	49.23	184.4	49.62
46	134.1	44.34	149.0	45.63	154.5	46.85	156.7	47.23	159.1	47.47	163.9	47.61	168.8	47.99	
48	118.6	43.44	129.4	44.82	134.2	45.93	136.3	46.21	138.4	46.36	142.6	46.55	146.9	46.73	
110	10	134.9	14.60	160.8	17.79	179.6	21.14	184.8	22.88	196.5	24.62	201.0	25.31	214.6	25.73
	12	134.9	15.06	160.8	18.39	179.6	22.01	184.8	23.52	196.5	25.55	201.0	26.37	214.6	26.98
	14	134.9	15.52	160.8	19.22	179.6	23.01	184.8	24.69	196.5	26.83	201.0	27.60	214.6	28.18
	16	134.9	16.08	160.8	19.92	179.6	23.96	184.8	25.77	196.5	28.07	201.0	28.84	214.6	29.34
	18	134.9	16.67	160.8	20.75	179.6	25.34	184.8	27.13	196.5	29.61	201.0	30.20	214.6	30.76
	20	134.9	17.27	160.8	21.79	179.6	26.87	184.8	28.38	196.5	31.05	201.0	31.81	214.6	32.32
	21	134.9	17.65	160.8	22.44	179.6	27.56	184.8	29.14	196.5	31.91	201.0	32.72	214.6	33.23
	23	134.9	18.80	160.8	24.05	179.6	29.10	184.8	30.77	196.5	33.71	201.0	34.44	214.6	35.01
	25	134.9	20.09	160.8	25.66	179.6	30.74	184.8	32.53	196.5	35.62	201.0	36.13	212.0	36.87
	27	134.9	21.47	160.8	27.44	179.6	32.49	184.8	34.42	196.5	37.20	201.0	38.05	208.9	38.70
	29	134.9	22.92	160.8	29.29	179.6	34.33	184.8	36.46	196.5	39.31	201.0	39.99	206.2	40.59
	31	134.9	24.37	160.8	31.23	179.6	36.28	184.8	38.63	193.3	41.31	198.4	42.12	203.0	42.56
	33	134.9	25.99	160.8	33.25	179.6	38.33	184.8	40.93	190.6	43.62	195.2	44.35	200.3	44.59
	35	134.9	27.60	160.8	35.51	179.6	40.48	184.8	43.37	187.4	46.04	191.9	46.46	197.1	46.69
	37	134.9	29.25	160.8	37.69	179.6	42.74	182.2	45.95	184.1	48.56	189.4	48.73	193.9	48.86
	39	134.9	31.54	160.8	40.05	176.4	45.09	178.9	49.15	181.6	50.96	186.1	51.05	191.3	51.10
	41	131.4	33.82	156.7	42.41	168.8	47.55	171.5	53.16	173.7	53.16	178.8	53.59	183.2	54.01
	43	128.2	35.51	152.8	44.18	161.8	50.43	164.4	51.00	166.6	50.89	171.5	51.17	175.9	51.32
46	120.1	34.66	143.2	42.65	147.6	47.86	150.2	47.86	152.1	48.27	156.8	48.54	160.9	48.67	
48	106.3	33.67	124.5	41.09	128.2	45.53	130.6	45.84	132.3	46.06	136.4	46.19	140.0	46.37	

# 7. Capacity Tables

Cooling Capacity (60HP)

Combination (%)	Outdoor air temp. (DB, °C)	Indoor air temp. (DB/WB, °C)													
		20		23		26		27		28		30		32	
		14		16		18		19		20		22		24	
		TC	PI	TC	PI	TC	PI	TC	PI	TC	PI	TC	PI	TC	PI
100	10	113.4	13.15	135.0	15.98	157.2	18.96	168.0	20.48	178.8	22.01	198.2	24.50	202.6	24.70
	12	113.4	13.57	135.0	16.63	157.2	19.60	168.0	21.03	178.8	22.71	198.2	25.82	202.6	26.07
	14	113.4	13.99	135.0	17.29	157.2	20.42	168.0	21.94	178.8	23.69	198.2	27.26	202.6	27.52
	16	113.4	14.42	135.0	17.87	157.2	21.30	168.0	22.99	178.8	24.97	198.2	28.58	202.6	28.98
	18	113.4	14.84	135.0	18.53	157.2	22.12	168.0	24.11	178.8	26.47	198.2	30.19	202.6	30.43
	20	113.4	15.37	135.0	19.23	157.2	23.40	168.0	25.82	178.8	28.33	198.2	31.64	202.6	31.89
	21	113.4	15.69	135.0	19.69	157.2	24.21	168.0	26.71	178.8	29.38	198.2	32.36	202.6	32.62
	23	113.4	16.62	135.0	21.06	157.2	25.99	168.0	28.65	178.8	31.47	198.2	33.89	202.6	34.16
	25	113.4	17.67	135.0	22.44	157.2	27.76	168.0	30.67	178.8	33.65	198.2	35.33	200.9	35.61
	27	113.4	18.88	135.0	23.97	157.2	29.70	168.0	32.77	178.8	35.78	194.4	36.99	198.5	37.29
	29	113.4	20.09	135.0	25.58	157.2	31.72	168.0	35.02	178.8	37.87	190.8	38.48	195.5	38.79
	31	113.4	21.47	135.0	27.28	157.2	33.81	168.0	37.37	178.8	39.79	187.9	39.97	192.5	40.29
	33	113.4	22.76	135.0	29.05	157.2	36.07	168.0	39.87	178.8	41.29	184.9	41.46	189.5	41.79
	35	113.4	24.21	135.0	30.91	157.2	38.41	168.0	42.53	176.1	42.79	181.5	42.95	186.1	43.30
	37	113.4	25.93	135.0	33.15	157.2	40.69	168.0	44.55	173.2	44.77	178.2	44.95	182.4	45.37
	39	113.4	27.80	135.0	35.61	157.2	43.12	168.0	46.73	170.3	46.94	175.3	47.12	179.4	47.55
	41	111.6	29.67	132.9	38.07	154.7	45.55	161.2	48.91	164.7	49.11	168.6	49.28	174.1	49.74
	43	107.8	31.40	128.3	40.36	149.4	47.73	154.6	50.78	156.3	50.96	161.2	51.13	165.4	51.61
46	101.0	33.77	120.2	43.51	140.0	50.62	141.1	53.16	142.6	53.32	147.2	53.47	151.2	53.98	
48	89.3	29.16	106.4	37.65	120.9	43.28	122.6	45.11	123.9	45.25	128.0	45.36	131.5	45.72	
90	10	102.0	12.15	121.8	14.60	141.6	17.21	151.2	18.55	160.8	19.97	180.6	22.35	200.4	24.70
	12	102.0	12.29	121.8	14.83	141.6	17.51	151.2	18.93	160.8	20.42	180.6	22.79	200.4	25.30
	14	102.0	12.52	121.8	15.13	141.6	17.88	151.2	19.30	160.8	20.79	180.6	23.24	200.4	25.81
	16	102.0	12.74	121.8	15.42	141.6	18.26	151.2	19.67	160.8	21.16	180.6	23.68	200.4	26.25
	18	102.0	12.97	121.8	15.72	141.6	18.55	151.2	20.12	160.8	21.61	180.6	24.20	200.4	27.57
	20	102.0	13.19	121.8	16.02	141.6	18.93	151.2	20.49	160.8	22.43	180.6	25.89	200.4	28.89
	21	102.0	13.34	121.8	16.17	141.6	19.30	151.2	21.16	160.8	23.25	180.6	26.32	200.4	29.55
	23	102.0	13.64	121.8	16.84	141.6	20.64	151.2	22.73	160.8	24.89	180.6	27.91	197.7	30.94
	25	102.0	14.31	121.8	17.96	141.6	22.06	151.2	24.29	160.8	26.60	180.6	29.84	194.8	32.26
	27	102.0	15.28	121.8	19.15	141.6	23.55	151.2	25.93	160.8	28.46	180.6	31.73	191.9	33.78
	29	102.0	16.17	121.8	20.42	141.6	25.19	151.2	27.72	160.8	30.40	180.6	33.60	189.1	35.14
	31	102.0	17.21	121.8	21.76	141.6	26.83	151.2	29.51	160.8	32.41	180.6	35.28	186.2	36.50
	33	102.0	18.33	121.8	23.17	141.6	28.61	151.2	31.45	160.8	34.38	180.6	36.99	183.4	37.86
	35	102.0	19.45	121.8	24.59	141.6	30.40	151.2	33.53	160.8	36.46	177.5	39.11	180.5	40.01
	37	102.0	20.64	121.8	26.15	141.6	32.42	151.2	35.62	160.8	38.48	174.6	40.88	177.7	41.80
	39	102.0	21.85	121.8	27.82	141.6	34.31	151.2	37.91	160.8	40.47	171.8	43.10	174.8	43.62
	41	99.4	24.45	118.7	30.84	138.0	37.66	147.3	41.45	156.7	43.69	164.6	45.42	167.5	46.47
	43	96.9	26.40	115.7	33.33	134.6	41.13	143.7	44.64	152.8	46.85	157.8	48.64	160.7	49.23
46	90.8	29.71	108.5	37.95	126.1	46.87	134.7	50.62	138.8	52.05	144.1	53.33	146.8	53.47	
48	80.4	25.97	96.0	33.20	111.6	41.01	119.1	44.16	120.6	44.85	125.2	45.36	127.6	45.72	
80	10	90.6	11.32	108.0	13.60	125.4	15.96	134.4	17.21	143.4	18.47	160.8	21.06	178.2	22.87
	12	90.6	11.55	108.0	13.75	125.4	16.27	134.4	17.53	143.4	18.78	160.8	21.46	178.2	23.32
	14	90.6	11.71	108.0	14.07	125.4	16.51	134.4	17.84	143.4	19.10	160.8	21.85	178.2	23.78
	16	90.6	11.87	108.0	14.30	125.4	16.82	134.4	18.16	143.4	19.49	160.8	22.32	178.2	24.23
	18	90.6	12.10	108.0	14.54	125.4	17.13	134.4	18.47	143.4	19.89	160.8	22.71	178.2	24.76
	20	90.6	12.34	108.0	14.85	125.4	17.53	134.4	18.86	143.4	20.28	160.8	23.58	178.2	26.23
	21	90.6	12.42	108.0	15.01	125.4	17.68	134.4	19.10	143.4	20.75	160.8	24.32	178.2	26.92
	23	90.6	12.65	108.0	15.25	125.4	18.47	134.4	20.28	143.4	22.16	160.8	25.68	178.2	28.26
	25	90.6	13.13	108.0	16.27	125.4	19.81	134.4	21.69	143.4	23.74	160.8	27.48	178.2	30.22
	27	90.6	13.91	108.0	17.29	125.4	21.14	134.4	23.19	143.4	25.31	160.8	29.20	178.2	31.79
	29	90.6	14.78	108.0	18.47	125.4	22.48	134.4	24.68	143.4	27.04	160.8	31.29	178.2	33.39
	31	90.6	15.72	108.0	19.57	125.4	23.97	134.4	26.33	143.4	28.77	160.8	33.20	178.2	35.04
	33	90.6	16.66	108.0	20.91	125.4	25.54	134.4	28.06	143.4	30.65	160.8	34.99	178.2	36.73
	35	90.6	17.68	108.0	22.16	125.4	27.19	134.4	29.87	143.4	32.70	160.8	37.10	176.3	38.81
	37	90.6	18.71	108.0	23.56	125.4	28.85	134.4	31.75	143.4	34.74	160.8	39.15	173.5	40.59
	39	90.6	19.77	108.0	24.91	125.4	30.86	134.4	34.14	143.4	37.33	160.8	41.36	170.6	42.82
	41	88.3	21.87	105.2	27.61	122.2	33.86	131.0	37.42	139.7	41.02	156.7	44.52	163.5	45.54
	43	86.1	24.07	102.6	30.13	119.2	36.97	127.7	40.78	136.3	44.83	152.8	47.67	156.7	48.74
46	80.7	26.78	96.2	33.94	111.7	41.65	119.7	45.39	127.7	50.59	139.7	53.33	143.0	53.47	
48	71.4	23.39	85.1	29.67	98.8	36.43	105.9	39.65	113.0	44.28	121.4	45.36	124.3	45.72	

# 7. Capacity Tables

Cooling Capacity (60HP)

Combination (%)	Outdoor air temp. (DB, °C)	Indoor air temp. (DB/WB, °C)													
		20		23		26		27		28		30		32	
		14	16	18	19	20	22	24	TC	PI	TC	PI	TC	PI	
70	10	79.2	10.00	94.8	11.89	109.8	13.78	117.6	14.89	125.4	15.91	140.4	18.11	156.0	20.26
	12	79.2	10.16	94.8	12.05	109.8	14.10	117.6	15.12	125.4	16.22	140.4	18.43	156.0	20.64
	14	79.2	10.32	94.8	12.21	109.8	14.33	117.6	15.36	125.4	16.46	140.4	18.82	156.0	21.02
	16	79.2	10.47	94.8	12.44	109.8	14.57	117.6	15.67	125.4	16.78	140.4	19.14	156.0	21.47
	18	79.2	10.63	94.8	12.68	109.8	14.89	117.6	15.99	125.4	17.09	140.4	19.45	156.0	21.85
	20	79.2	10.79	94.8	12.92	109.8	15.12	117.6	16.30	125.4	17.48	140.4	19.93	156.0	22.68
	21	79.2	10.95	94.8	13.00	109.8	15.28	117.6	16.46	125.4	17.64	140.4	20.24	156.0	23.16
	23	79.2	11.10	94.8	13.31	109.8	15.59	117.6	17.01	125.4	18.51	140.4	21.66	156.0	24.46
	25	79.2	11.26	94.8	13.78	109.8	16.62	117.6	18.19	125.4	19.77	140.4	23.15	156.0	25.65
	27	79.2	11.89	94.8	14.73	109.8	17.72	117.6	19.30	125.4	21.11	140.4	24.73	156.0	27.25
	29	79.2	12.68	94.8	15.59	109.8	18.82	117.6	20.56	125.4	22.45	140.4	26.38	156.0	29.20
	31	79.2	13.47	94.8	16.62	109.8	20.08	117.6	21.97	125.4	23.94	140.4	28.12	156.0	30.98
	33	79.2	14.26	94.8	17.56	109.8	21.34	117.6	23.31	125.4	25.44	140.4	29.93	156.0	32.98
	35	79.2	15.04	94.8	18.75	109.8	22.68	117.6	24.81	125.4	27.09	140.4	31.90	156.0	34.97
	37	79.2	15.99	94.8	19.86	109.8	24.10	117.6	26.38	125.4	28.83	140.4	33.94	156.0	36.91
	39	79.2	16.98	94.8	21.17	109.8	25.77	117.6	28.39	125.4	31.14	140.4	36.33	156.0	39.79
	41	77.2	18.77	92.4	23.19	107.0	28.27	114.6	31.14	122.2	33.85	136.8	39.90	152.0	42.93
43	75.3	20.43	90.1	25.28	104.3	30.84	111.8	33.95	119.2	36.96	133.4	43.59	148.2	46.41	
46	70.5	22.70	84.4	28.42	97.8	34.73	104.7	37.82	111.7	41.67	125.0	49.16	138.9	51.73	
48	62.4	19.81	74.7	24.83	86.5	30.37	92.6	33.05	98.8	36.45	110.6	43.02	122.9	44.77	
60	10	67.8	8.68	81.0	10.18	94.2	11.84	100.8	12.71	107.4	13.50	120.6	15.31	133.8	17.13
	12	67.8	8.84	81.0	10.34	94.2	12.00	100.8	12.86	107.4	13.73	120.6	15.55	133.8	17.44
	14	67.8	8.92	81.0	10.50	94.2	12.23	100.8	13.10	107.4	13.97	120.6	15.86	133.8	17.76
	16	67.8	9.08	81.0	10.73	94.2	12.39	100.8	13.34	107.4	14.28	120.6	16.18	133.8	18.07
	18	67.8	9.23	81.0	10.89	94.2	12.63	100.8	13.57	107.4	14.52	120.6	16.42	133.8	18.47
	20	67.8	9.39	81.0	11.05	94.2	12.86	100.8	13.81	107.4	14.76	120.6	16.73	133.8	18.86
	21	67.8	9.47	81.0	11.13	94.2	13.02	100.8	13.97	107.4	14.92	120.6	16.97	133.8	19.02
	23	67.8	9.63	81.0	11.36	94.2	13.18	100.8	14.21	107.4	15.23	120.6	17.60	133.8	20.20
	25	67.8	9.79	81.0	11.60	94.2	13.73	100.8	14.92	107.4	16.18	120.6	18.78	133.8	21.62
	27	67.8	10.10	81.0	12.23	94.2	14.60	100.8	15.86	107.4	17.20	120.6	19.97	133.8	23.04
	29	67.8	10.73	81.0	13.02	94.2	15.55	100.8	16.89	107.4	18.31	120.6	21.31	133.8	24.62
	31	67.8	11.36	81.0	13.81	94.2	16.49	100.8	17.99	107.4	19.49	120.6	22.73	133.8	26.20
	33	67.8	12.00	81.0	14.60	94.2	17.52	100.8	19.10	107.4	20.76	120.6	24.15	133.8	27.94
	35	67.8	12.71	81.0	15.55	94.2	18.62	100.8	20.28	107.4	22.02	120.6	25.73	133.8	29.67
	37	67.8	13.42	81.0	16.41	94.2	19.73	100.8	21.54	107.4	23.36	120.6	27.31	133.8	31.57
	39	67.8	14.27	81.0	17.47	94.2	21.30	100.8	23.12	107.4	25.14	120.6	29.28	133.8	33.83
	41	66.1	15.48	78.9	19.12	91.8	23.13	98.2	25.25	104.7	27.29	117.5	32.13	130.4	36.76
43	64.4	16.82	77.0	20.81	89.5	25.21	95.8	27.52	102.1	29.76	114.6	35.08	127.2	40.15	
46	60.4	18.83	72.1	23.37	83.9	28.36	89.8	30.93	95.6	33.48	107.4	39.52	119.2	45.75	
48	53.4	16.41	63.8	20.40	74.2	24.77	79.4	27.01	84.6	29.26	95.0	34.57	105.4	40.02	
50	10	56.7	7.51	67.8	8.70	78.6	9.88	84.0	10.60	89.4	11.23	100.2	12.65	111.6	14.08
	12	56.7	7.59	67.8	8.78	78.6	10.04	84.0	10.75	89.4	11.47	100.2	12.89	111.6	14.31
	14	56.7	7.67	67.8	8.94	78.6	10.20	84.0	10.91	89.4	11.62	100.2	13.05	111.6	14.55
	16	56.7	7.83	67.8	9.09	78.6	10.36	84.0	11.15	89.4	11.78	100.2	13.29	111.6	14.79
	18	56.7	7.91	67.8	9.17	78.6	10.52	84.0	11.31	89.4	12.02	100.2	13.52	111.6	15.10
	20	56.7	7.99	67.8	9.33	78.6	10.75	84.0	11.47	89.4	12.26	100.2	13.76	111.6	15.42
	21	56.7	8.07	67.8	9.41	78.6	10.83	84.0	11.62	89.4	12.34	100.2	13.92	111.6	15.58
	23	56.7	8.22	67.8	9.57	78.6	10.99	84.0	11.78	89.4	12.57	100.2	14.16	111.6	15.90
	25	56.7	8.30	67.8	9.73	78.6	11.23	84.0	12.02	89.4	12.97	100.2	14.87	111.6	17.00
	27	56.7	8.46	67.8	10.04	78.6	11.86	84.0	12.81	89.4	13.76	100.2	15.90	111.6	18.11
	29	56.7	8.94	67.8	10.68	78.6	12.57	84.0	13.60	89.4	14.63	100.2	16.84	111.6	19.22
	31	56.7	9.41	67.8	11.31	78.6	13.36	84.0	14.39	89.4	15.58	100.2	17.95	111.6	20.48
	33	56.7	9.96	67.8	11.94	78.6	14.16	84.0	15.26	89.4	16.53	100.2	19.06	111.6	21.83
	35	56.7	10.52	67.8	12.65	78.6	14.95	84.0	16.21	89.4	17.48	100.2	20.17	111.6	23.17
	37	56.7	11.15	67.8	13.36	78.6	15.82	84.0	17.16	89.4	18.50	100.2	21.51	111.6	24.59
	39	56.7	11.89	67.8	14.33	78.6	16.95	84.0	18.47	89.4	19.86	100.2	22.91	111.6	26.56
	41	55.2	12.86	66.1	15.51	76.6	18.53	81.9	20.01	87.1	21.51	97.6	25.11	108.7	28.85
43	53.9	13.98	64.4	16.87	74.7	20.16	79.8	21.78	85.0	23.42	95.2	27.39	106.1	31.47	
46	50.5	15.65	60.4	18.92	70.0	22.62	74.8	24.46	79.6	26.30	89.2	30.81	99.4	35.43	
48	44.7	13.64	53.4	16.50	61.9	19.73	66.2	21.35	70.4	22.95	78.9	26.93	87.9	30.97	

**Note**

1. TC: Total Capacity(kW), PI : Power Input(kW, Comp. + Outdoor fan motor)
2. Capacity tables show the average value of conditions which may occur.

# 7. Capacity Tables

◆ ARUM620LTE5

Cooling Capacity (62HP)

Combination (%)	Outdoor air temp. (DB, °C)	Indoor air temp. (DB/WB, °C)													
		20		23		26		27		28		30		32	
		14	16	16	18	18	19	19	20	20	22	22	24	24	
		TC	PI	TC	PI	TC	PI	TC	PI	TC	PI	TC	PI	TC	PI
130	10	171.9	18.45	204.8	22.55	219.5	26.16	225.8	26.69	232.1	26.90	243.2	27.11	249.5	27.22
	12	171.9	18.90	204.8	23.35	219.5	27.23	225.8	27.41	232.1	27.63	243.2	27.85	249.5	28.09
	14	171.9	19.54	204.8	24.20	219.5	28.26	225.8	28.46	232.1	28.69	243.2	28.92	249.5	29.17
	16	171.9	20.25	204.8	25.04	219.5	29.52	225.8	29.80	232.1	30.03	243.2	30.30	249.5	30.54
	18	171.9	21.10	204.8	26.49	219.5	30.88	225.8	31.54	232.1	31.79	243.2	32.11	249.5	32.33
	20	171.9	22.03	204.8	28.22	219.5	32.40	225.8	34.70	232.1	34.97	239.7	35.32	246.0	35.56
	21	171.9	22.61	204.8	29.21	219.5	33.08	225.8	36.72	232.1	37.01	238.4	37.38	244.7	37.64
	23	171.9	24.26	204.8	30.73	219.5	34.80	225.8	40.51	229.1	40.84	234.8	41.24	241.1	41.53
	25	171.9	25.91	204.8	32.50	219.5	37.18	223.1	44.93	225.8	45.29	232.1	45.74	238.4	46.06
	27	171.9	27.73	204.8	34.74	216.7	39.62	219.5	49.47	223.1	49.86	229.1	50.36	234.8	50.70
	29	171.9	29.54	204.8	37.14	213.2	42.63	216.3	54.36	219.5	54.69	225.8	55.18	232.1	55.40
	31	171.9	31.52	204.1	39.12	209.6	45.34	213.2	54.14	216.3	54.46	222.2	54.95	228.5	55.16
	33	171.9	33.59	200.6	41.45	206.9	48.63	210.2	53.64	213.2	53.96	219.5	54.45	225.0	54.66
	35	171.9	35.82	197.0	43.41	203.3	52.68	206.9	52.94	210.2	53.26	215.9	53.74	222.2	53.95
	37	171.9	38.19	194.3	45.56	200.6	51.98	203.3	52.24	206.9	52.56	212.5	53.03	218.8	53.23
	39	171.9	40.67	190.8	47.95	197.0	51.29	200.6	51.54	203.3	51.85	209.6	52.32	215.9	52.52
41	167.5	43.14	182.9	50.35	189.1	50.59	191.9	50.84	195.7	51.15	201.6	51.61	207.0	51.81	
43	163.4	45.50	175.3	49.64	181.4	49.89	184.1	50.14	187.8	50.45	193.6	50.90	198.9	51.10	
46	153.1	48.71	159.9	48.60	165.7	48.85	168.3	49.10	171.8	49.39	177.2	49.83	182.1	50.03	
48	135.5	47.35	138.9	47.49	144.1	47.59	146.4	47.72	149.5	48.13	154.3	48.44	158.6	48.63	
120	10	155.6	16.60	185.0	20.35	202.2	24.18	208.3	26.13	214.5	26.55	226.2	26.65	231.7	26.87
	12	155.6	17.05	185.0	21.04	202.2	25.15	208.3	26.69	214.5	27.53	226.2	27.86	231.7	28.09
	14	155.6	17.63	185.0	21.75	202.2	26.17	208.3	27.70	214.5	28.54	226.2	28.96	231.7	29.19
	16	155.6	18.27	185.0	22.64	202.2	27.18	208.3	28.73	214.5	29.86	226.2	30.23	231.7	30.47
	18	155.6	18.98	185.0	23.66	202.2	28.27	208.3	30.25	214.5	31.39	226.2	31.75	231.7	32.00
	20	155.6	19.71	185.0	25.09	202.2	29.79	208.3	31.83	214.5	33.05	226.2	33.49	231.7	33.76
	21	155.6	20.30	185.0	25.99	202.2	30.63	208.3	32.77	214.5	34.14	226.2	34.57	231.7	34.85
	23	155.6	21.70	185.0	27.81	202.2	32.82	208.3	34.82	214.5	36.40	226.2	36.77	231.7	37.06
	25	155.6	23.19	185.0	29.79	202.2	34.61	208.3	37.11	214.5	39.03	223.4	39.36	228.9	39.67
	27	155.6	24.76	185.0	31.85	202.2	36.83	208.3	39.65	214.5	41.95	220.0	42.23	225.5	42.57
	29	155.6	26.41	185.0	34.00	202.2	38.76	208.3	42.44	211.0	44.70	216.5	45.38	222.7	45.74
	31	155.6	28.14	185.0	36.31	202.2	40.77	205.6	45.46	208.3	47.96	213.8	48.80	219.3	49.19
	33	155.6	29.96	185.0	38.70	199.5	43.12	202.2	49.35	204.9	51.49	210.4	52.07	215.9	52.49
	35	155.6	31.85	185.0	41.26	196.0	45.64	198.7	54.36	202.2	54.63	207.7	54.80	213.1	55.23
	37	155.6	34.26	185.0	43.54	193.2	48.66	196.0	53.22	198.7	53.49	204.2	53.65	209.7	54.07
	39	155.6	36.89	184.3	46.02	189.8	51.61	192.6	52.13	195.3	52.39	201.5	52.54	206.9	52.96
41	151.6	39.51	176.3	48.49	182.2	50.59	184.8	51.03	187.5	51.29	193.0	51.44	198.4	51.85	
43	147.9	42.17	168.9	47.80	174.8	49.46	177.3	49.94	179.9	50.19	185.2	50.34	190.6	50.74	
46	138.6	45.35	154.0	46.66	159.6	47.91	162.0	48.30	164.4	48.54	169.4	48.69	174.4	49.07	
48	122.6	44.42	133.7	45.83	138.7	46.97	140.8	47.26	143.0	47.41	147.4	47.60	151.8	47.79	
110	10	139.4	14.93	166.2	18.20	185.6	21.61	190.9	23.40	203.0	25.18	207.7	25.88	221.8	26.31
	12	139.4	15.40	166.2	18.81	185.6	22.51	190.9	24.05	203.0	26.12	207.7	26.96	221.8	27.59
	14	139.4	15.87	166.2	19.66	185.6	23.53	190.9	25.25	203.0	27.44	207.7	28.22	221.8	28.81
	16	139.4	16.44	166.2	20.37	185.6	24.50	190.9	26.35	203.0	28.70	207.7	29.49	221.8	30.01
	18	139.4	17.05	166.2	21.22	185.6	25.91	190.9	27.74	203.0	30.28	207.7	30.88	221.8	31.45
	20	139.4	17.66	166.2	22.28	185.6	27.48	190.9	29.02	203.0	31.75	207.7	32.53	221.8	33.05
	21	139.4	18.05	166.2	22.94	185.6	28.19	190.9	29.80	203.0	32.63	207.7	33.46	221.8	33.98
	23	139.4	19.23	166.2	24.59	185.6	29.76	190.9	31.46	203.0	34.47	207.7	35.21	221.8	35.80
	25	139.4	20.55	166.2	26.24	185.6	31.44	190.9	33.26	203.0	36.42	207.7	36.94	219.1	37.70
	27	139.4	21.95	166.2	28.06	185.6	33.22	190.9	35.20	203.0	38.04	207.7	38.91	215.8	39.57
	29	139.4	23.44	166.2	29.96	185.6	35.11	190.9	37.28	203.0	40.20	207.7	40.89	213.1	41.51
	31	139.4	24.92	166.2	31.94	185.6	37.10	190.9	39.50	199.7	42.24	205.0	43.07	209.7	43.52
	33	139.4	26.57	166.2	34.00	185.6	39.20	190.9	41.85	197.0	44.61	201.7	45.35	207.0	45.60
	35	139.4	28.22	166.2	36.31	185.6	41.40	190.9	44.35	193.7	47.08	198.3	47.51	203.7	47.75
	37	139.4	29.91	166.2	38.54	185.6	43.70	188.3	46.99	190.3	49.65	195.7	49.83	200.3	49.97
	39	139.4	32.25	166.2	40.95	182.2	46.11	184.9	50.26	187.6	52.11	192.3	52.20	197.7	52.25
41	135.8	34.59	161.9	43.37	174.4	48.63	177.2	54.36	179.5	54.36	184.7	54.80	189.3	55.23	
43	132.5	36.32	157.9	45.18	167.2	51.57	169.9	52.15	172.1	52.03	177.2	52.33	181.7	52.47	
46	124.1	35.45	148.0	43.62	152.5	48.94	155.2	48.94	157.2	49.36	162.0	49.63	166.2	49.77	
48	109.8	34.43	128.6	42.02	132.5	46.56	134.9	46.87	136.7	47.10	140.9	47.23	144.6	47.42	

# 7. Capacity Tables

Cooling Capacity (62HP)

Combination (%)	Outdoor air temp. (DB, °C)	Indoor air temp. (DB/WB, °C)													
		20		23		26		27		28		30		32	
		14		16		18		19		20		22		24	
		TC	PI	TC	PI	TC	PI	TC	PI	TC	PI	TC	PI	TC	PI
100	10	117.2	13.44	139.5	16.34	162.4	19.38	173.6	20.94	184.8	22.50	204.8	25.05	209.3	25.25
	12	117.2	13.87	139.5	17.01	162.4	20.04	173.6	21.51	184.8	23.22	204.8	26.40	209.3	26.66
	14	117.2	14.31	139.5	17.68	162.4	20.89	173.6	22.44	184.8	24.22	204.8	27.88	209.3	28.14
	16	117.2	14.74	139.5	18.27	162.4	21.78	173.6	23.50	184.8	25.53	204.8	29.22	209.3	29.63
	18	117.2	15.18	139.5	18.95	162.4	22.62	173.6	24.65	184.8	27.07	204.8	30.87	209.3	31.12
	20	117.2	15.72	139.5	19.67	162.4	23.93	173.6	26.41	184.8	28.97	204.8	32.35	209.3	32.61
	21	117.2	16.05	139.5	20.14	162.4	24.76	173.6	27.32	184.8	30.04	204.8	33.09	209.3	33.36
	23	117.2	17.00	139.5	21.54	162.4	26.57	173.6	29.30	184.8	32.18	204.8	34.65	209.3	34.93
	25	117.2	18.07	139.5	22.94	162.4	28.39	173.6	31.36	184.8	34.41	204.8	36.13	207.6	36.42
	27	117.2	19.31	139.5	24.51	162.4	30.37	173.6	33.50	184.8	36.59	200.9	37.83	205.1	38.13
	29	117.2	20.55	139.5	26.16	162.4	32.43	173.6	35.82	184.8	38.72	197.1	39.35	202.0	39.67
	31	117.2	21.95	139.5	27.89	162.4	34.58	173.6	38.21	184.8	40.69	194.2	40.88	198.9	41.20
	33	117.2	23.27	139.5	29.71	162.4	36.89	173.6	40.77	184.8	42.22	191.0	42.40	195.8	42.74
	35	117.2	24.76	139.5	31.61	162.4	39.28	173.6	43.49	181.9	43.75	187.6	43.92	192.3	44.27
	37	117.2	26.51	139.5	33.90	162.4	41.61	173.6	45.56	178.9	45.78	184.1	45.97	188.5	46.39
	39	117.2	28.43	139.5	36.42	162.4	44.09	173.6	47.79	176.0	48.00	181.2	48.18	185.4	48.63
	41	115.3	30.34	137.3	38.93	159.9	46.58	166.6	50.01	170.2	50.21	174.2	50.39	179.9	50.86
	43	111.4	32.11	132.6	41.27	154.4	48.80	159.7	51.93	161.5	52.11	166.5	52.28	170.9	52.77
46	104.4	34.54	124.2	44.49	144.7	51.76	145.8	54.36	147.4	54.52	152.1	54.68	156.2	55.20	
48	92.3	29.82	109.9	38.50	124.9	44.25	126.7	46.13	128.0	46.28	132.3	46.38	135.9	46.75	
90	10	105.4	12.43	125.9	14.95	146.3	17.62	156.2	18.99	166.2	20.44	186.6	22.88	207.1	25.25
	12	105.4	12.58	125.9	15.18	146.3	17.92	156.2	19.37	166.2	20.90	186.6	23.33	207.1	25.89
	14	105.4	12.81	125.9	15.48	146.3	18.31	156.2	19.75	166.2	21.28	186.6	23.79	207.1	26.42
	16	105.4	13.04	125.9	15.79	146.3	18.69	156.2	20.14	166.2	21.66	186.6	24.24	207.1	26.87
	18	105.4	13.27	125.9	16.09	146.3	18.99	156.2	20.59	166.2	22.12	186.6	24.77	207.1	28.22
	20	105.4	13.50	125.9	16.40	146.3	19.37	156.2	20.97	166.2	22.96	186.6	26.50	207.1	29.57
	21	105.4	13.65	125.9	16.55	146.3	19.75	156.2	21.66	166.2	23.80	186.6	26.94	207.1	30.25
	23	105.4	13.96	125.9	17.24	146.3	21.13	156.2	23.26	166.2	25.47	186.6	28.56	204.2	31.67
	25	105.4	14.64	125.9	18.38	146.3	22.58	156.2	24.86	166.2	27.23	186.6	30.54	201.3	33.02
	27	105.4	15.64	125.9	19.60	146.3	24.10	156.2	26.54	166.2	29.14	186.6	32.47	198.3	34.58
	29	105.4	16.55	125.9	20.90	146.3	25.78	156.2	28.37	166.2	31.12	186.6	34.40	195.4	35.97
	31	105.4	17.62	125.9	22.27	146.3	27.46	156.2	30.20	166.2	33.18	186.6	36.11	192.4	37.36
	33	105.4	18.76	125.9	23.72	146.3	29.29	156.2	32.19	166.2	35.19	186.6	37.86	189.5	38.76
	35	105.4	19.91	125.9	25.17	146.3	31.12	156.2	34.32	166.2	37.32	183.4	40.03	186.5	40.95
	37	105.4	21.13	125.9	26.77	146.3	33.18	156.2	36.46	166.2	39.39	180.5	41.85	183.6	42.79
	39	105.4	22.37	125.9	28.47	146.3	35.12	156.2	38.80	166.2	41.42	177.5	44.12	180.6	44.65
	41	102.7	25.03	122.6	31.57	142.6	38.54	152.2	42.43	161.9	44.72	170.1	46.50	173.1	47.56
	43	100.2	27.02	119.6	34.11	139.1	42.10	148.5	45.70	157.9	47.95	163.1	49.79	166.0	50.39
46	93.9	30.41	112.1	38.85	130.3	47.97	139.1	51.81	143.5	53.27	148.9	54.54	151.7	54.70	
48	83.0	26.58	99.2	33.98	115.3	41.97	123.1	45.20	124.6	45.88	129.4	46.38	131.8	46.75	
80	10	93.6	11.59	111.6	13.93	129.6	16.34	138.9	17.63	148.2	18.92	166.2	21.58	184.1	23.43
	12	93.6	11.84	111.6	14.09	129.6	16.67	138.9	17.95	148.2	19.24	166.2	21.98	184.1	23.89
	14	93.6	12.00	111.6	14.41	129.6	16.91	138.9	18.28	148.2	19.57	166.2	22.38	184.1	24.36
	16	93.6	12.16	111.6	14.65	129.6	17.23	138.9	18.60	148.2	19.97	166.2	22.87	184.1	24.82
	18	93.6	12.40	111.6	14.90	129.6	17.55	138.9	18.92	148.2	20.37	166.2	23.27	184.1	25.36
	20	93.6	12.64	111.6	15.22	129.6	17.95	138.9	19.32	148.2	20.77	166.2	24.15	184.1	26.87
	21	93.6	12.72	111.6	15.38	129.6	18.12	138.9	19.57	148.2	21.26	166.2	24.92	184.1	27.58
	23	93.6	12.96	111.6	15.62	129.6	18.92	138.9	20.77	148.2	22.71	166.2	26.31	184.1	28.95
	25	93.6	13.45	111.6	16.67	129.6	20.29	138.9	22.22	148.2	24.32	166.2	28.15	184.1	30.95
	27	93.6	14.25	111.6	17.71	129.6	21.66	138.9	23.75	148.2	25.93	166.2	29.92	184.1	32.57
	29	93.6	15.14	111.6	18.92	129.6	23.03	138.9	25.28	148.2	27.70	166.2	32.05	184.1	34.17
	31	93.6	16.10	111.6	20.05	129.6	24.56	138.9	26.97	148.2	29.47	166.2	34.01	184.1	35.87
	33	93.6	17.07	111.6	21.42	129.6	26.17	138.9	28.74	148.2	31.40	166.2	35.84	184.1	37.59
	35	93.6	18.12	111.6	22.71	129.6	27.86	138.9	30.60	148.2	33.49	166.2	38.00	182.2	39.72
	37	93.6	19.16	111.6	24.14	129.6	29.55	138.9	32.53	148.2	35.59	166.2	40.11	179.2	41.58
	39	93.6	20.25	111.6	25.52	129.6	31.61	138.9	34.97	148.2	38.24	166.2	42.37	176.3	43.86
	41	91.2	22.40	108.7	28.28	126.3	34.69	135.3	38.33	144.4	42.02	161.9	45.57	168.9	46.61
	43	89.0	24.66	106.1	30.86	123.1	37.87	132.0	41.78	140.8	45.92	157.9	48.79	161.9	49.89
46	83.4	27.44	99.4	34.76	115.4	42.67	123.7	46.50	132.0	51.82	144.4	54.54	147.8	54.70	
48	73.8	23.96	87.9	30.40	102.1	37.32	109.4	40.61	116.7	45.36	125.4	46.38	128.4	46.75	

# 7. Capacity Tables

Cooling Capacity (62HP)

Combination (%)	Outdoor air temp. (DB, °C)	Indoor air temp. (DB/WB, °C)													
		20		23		26		27		28		30		32	
		14		16		18		19		20		22		24	
		TC	PI	TC	PI	TC	PI	TC	PI	TC	PI	TC	PI	TC	PI
70	10	81.8	10.25	98.0	12.19	113.5	14.13	121.5	15.26	129.6	16.31	145.1	18.57	161.2	20.77
	12	81.8	10.42	98.0	12.35	113.5	14.45	121.5	15.50	129.6	16.63	145.1	18.89	161.2	21.16
	14	81.8	10.58	98.0	12.52	113.5	14.70	121.5	15.75	129.6	16.88	145.1	19.30	161.2	21.55
	16	81.8	10.74	98.0	12.76	113.5	14.94	121.5	16.07	129.6	17.20	145.1	19.62	161.2	22.01
	18	81.8	10.90	98.0	13.00	113.5	15.26	121.5	16.39	129.6	17.52	145.1	19.94	161.2	22.40
	20	81.8	11.06	98.0	13.24	113.5	15.50	121.5	16.71	129.6	17.93	145.1	20.43	161.2	23.25
	21	81.8	11.22	98.0	13.32	113.5	15.66	121.5	16.88	129.6	18.09	145.1	20.75	161.2	23.75
	23	81.8	11.39	98.0	13.65	113.5	15.99	121.5	17.44	129.6	18.98	145.1	22.20	161.2	25.07
	25	81.8	11.55	98.0	14.13	113.5	17.04	121.5	18.65	129.6	20.27	145.1	23.74	161.2	26.29
	27	81.8	12.19	98.0	15.10	113.5	18.17	121.5	19.78	129.6	21.64	145.1	25.35	161.2	27.94
	29	81.8	13.00	98.0	15.99	113.5	19.30	121.5	21.07	129.6	23.01	145.1	27.05	161.2	29.93
	31	81.8	13.81	98.0	17.04	113.5	20.59	121.5	22.53	129.6	24.55	145.1	28.83	161.2	31.76
	33	81.8	14.61	98.0	18.01	113.5	21.88	121.5	23.90	129.6	26.08	145.1	30.68	161.2	33.81
	35	81.8	15.42	98.0	19.23	113.5	23.25	121.5	25.43	129.6	27.78	145.1	32.70	161.2	35.85
	37	81.8	16.39	98.0	20.36	113.5	24.71	121.5	27.05	129.6	29.55	145.1	34.80	161.2	37.84
	39	81.8	17.41	98.0	21.70	113.5	26.42	121.5	29.10	129.6	31.92	145.1	37.24	161.2	40.79
41	79.7	19.24	95.5	23.78	110.6	28.98	118.4	31.92	126.3	34.70	141.4	40.91	157.1	44.01	
43	77.8	20.95	93.1	25.91	107.8	31.62	115.5	34.81	123.1	37.90	137.9	44.69	153.2	47.58	
46	72.9	23.28	87.2	29.14	101.0	35.61	108.2	38.77	115.4	42.72	129.2	50.40	143.6	53.03	
48	64.5	20.31	77.2	25.45	89.4	31.13	95.7	33.88	102.1	37.37	114.3	44.11	127.0	45.90	
60	10	70.1	8.91	83.7	10.45	97.3	12.15	104.2	13.04	111.0	13.85	124.6	15.71	138.3	17.57
	12	70.1	9.07	83.7	10.61	97.3	12.31	104.2	13.20	111.0	14.09	124.6	15.95	138.3	17.90
	14	70.1	9.15	83.7	10.77	97.3	12.55	104.2	13.44	111.0	14.33	124.6	16.28	138.3	18.22
	16	70.1	9.31	83.7	11.01	97.3	12.71	104.2	13.68	111.0	14.66	124.6	16.60	138.3	18.54
	18	70.1	9.47	83.7	11.17	97.3	12.96	104.2	13.93	111.0	14.90	124.6	16.84	138.3	18.95
	20	70.1	9.64	83.7	11.34	97.3	13.20	104.2	14.17	111.0	15.14	124.6	17.17	138.3	19.35
	21	70.1	9.72	83.7	11.42	97.3	13.36	104.2	14.33	111.0	15.30	124.6	17.41	138.3	19.51
	23	70.1	9.88	83.7	11.66	97.3	13.52	104.2	14.58	111.0	15.63	124.6	18.06	138.3	20.73
	25	70.1	10.04	83.7	11.90	97.3	14.09	104.2	15.30	111.0	16.60	124.6	19.27	138.3	22.19
	27	70.1	10.36	83.7	12.55	97.3	14.98	104.2	16.28	111.0	17.65	124.6	20.49	138.3	23.64
	29	70.1	11.01	83.7	13.36	97.3	15.95	104.2	17.33	111.0	18.79	124.6	21.86	138.3	25.26
	31	70.1	11.66	83.7	14.17	97.3	16.92	104.2	18.46	111.0	20.00	124.6	23.32	138.3	26.88
	33	70.1	12.31	83.7	14.98	97.3	17.98	104.2	19.60	111.0	21.30	124.6	24.78	138.3	28.67
	35	70.1	13.04	83.7	15.95	97.3	19.11	104.2	20.81	111.0	22.59	124.6	26.40	138.3	30.45
	37	70.1	13.77	83.7	16.83	97.3	20.24	104.2	22.11	111.0	23.97	124.6	28.02	138.3	32.39
	39	70.1	14.64	83.7	17.93	97.3	21.85	104.2	23.72	111.0	25.79	124.6	30.04	138.3	34.71
41	68.3	15.88	81.6	19.62	94.8	23.73	101.5	25.91	108.1	28.00	121.4	32.97	134.7	37.72	
43	66.6	17.25	79.5	21.36	92.5	25.87	99.0	28.23	105.5	30.53	118.4	35.99	131.4	41.20	
46	62.4	19.32	74.5	23.98	86.7	29.09	92.8	31.74	98.8	34.36	111.0	40.55	123.1	46.94	
48	55.2	16.84	65.9	20.93	76.7	25.42	82.1	27.72	87.4	30.02	98.2	35.47	108.9	41.07	
50	10	58.6	7.71	70.1	8.93	81.2	10.15	86.8	10.88	92.4	11.53	103.5	12.99	115.3	14.45
	12	58.6	7.80	70.1	9.01	81.2	10.31	86.8	11.04	92.4	11.77	103.5	13.24	115.3	14.70
	14	58.6	7.88	70.1	9.18	81.2	10.48	86.8	11.21	92.4	11.94	103.5	13.40	115.3	14.94
	16	58.6	8.04	70.1	9.34	81.2	10.64	86.8	11.45	92.4	12.10	103.5	13.64	115.3	15.19
	18	58.6	8.12	70.1	9.42	81.2	10.80	86.8	11.61	92.4	12.34	103.5	13.89	115.3	15.51
	20	58.6	8.20	70.1	9.58	81.2	11.04	86.8	11.77	92.4	12.59	103.5	14.13	115.3	15.83
	21	58.6	8.28	70.1	9.66	81.2	11.13	86.8	11.94	92.4	12.67	103.5	14.29	115.3	16.00
	23	58.6	8.45	70.1	9.83	81.2	11.29	86.8	12.10	92.4	12.91	103.5	14.54	115.3	16.32
	25	58.6	8.53	70.1	9.99	81.2	11.53	86.8	12.34	92.4	13.32	103.5	15.27	115.3	17.46
	27	58.6	8.69	70.1	10.31	81.2	12.18	86.8	13.16	92.4	14.13	103.5	16.32	115.3	18.60
	29	58.6	9.18	70.1	10.96	81.2	12.91	86.8	13.97	92.4	15.02	103.5	17.30	115.3	19.73
	31	58.6	9.66	70.1	11.61	81.2	13.72	86.8	14.78	92.4	16.00	103.5	18.43	115.3	21.03
	33	58.6	10.23	70.1	12.26	81.2	14.54	86.8	15.67	92.4	16.97	103.5	19.57	115.3	22.41
	35	58.6	10.80	70.1	12.99	81.2	15.35	86.8	16.65	92.4	17.95	103.5	20.71	115.3	23.79
	37	58.6	11.45	70.1	13.72	81.2	16.24	86.8	17.62	92.4	19.00	103.5	22.09	115.3	25.25
	39	58.6	12.21	70.1	14.71	81.2	17.40	86.8	18.97	92.4	20.39	103.5	23.53	115.3	27.28
41	57.1	13.21	68.3	15.92	79.1	19.03	84.6	20.54	90.0	22.09	100.9	25.79	112.4	29.62	
43	55.7	14.35	66.6	17.32	77.2	20.70	82.5	22.37	87.8	24.05	98.4	28.12	109.6	32.31	
46	52.2	16.08	62.4	19.43	72.3	23.22	77.3	25.12	82.3	27.00	92.2	31.64	102.7	36.38	
48	46.2	14.01	55.2	16.94	64.0	20.26	68.4	21.93	72.8	23.56	81.6	27.65	90.9	31.80	

**Note**

1. TC: Total Capacity(kW), PI : Power Input(kW, Comp. + Outdoor fan motor)
2. Capacity tables show the average value of conditions which may occur.



# 7. Capacity Tables

◆ ARUM640LTE5

Cooling Capacity (64HP)

Combination (%)	Outdoor air temp. (DB, °C)	Indoor air temp. (DB/WB, °C)													
		20		23		26		27		28		30		32	
		14	16	16	18	18	19	20	20	22	22	24	24		
		TC	PI	TC	PI	TC	PI	TC	PI	TC	PI	TC	PI	TC	PI
130	10	177.5	19.39	211.4	23.70	226.5	27.50	233.0	28.06	239.5	28.28	251.1	28.50	257.6	28.62
	12	177.5	19.87	211.4	24.55	226.5	28.63	233.0	28.81	239.5	29.04	251.1	29.27	257.6	29.53
	14	177.5	20.54	211.4	25.44	226.5	29.70	233.0	29.92	239.5	30.16	251.1	30.40	257.6	30.67
	16	177.5	21.29	211.4	26.33	226.5	31.03	233.0	31.32	239.5	31.57	251.1	31.86	257.6	32.11
	18	177.5	22.19	211.4	27.85	226.5	32.46	233.0	33.16	239.5	33.42	251.1	33.76	257.6	33.99
	20	177.5	23.16	211.4	29.67	226.5	34.06	233.0	36.48	239.5	36.77	247.4	37.13	253.9	37.39
	21	177.5	23.77	211.4	30.71	226.5	34.77	233.0	38.60	239.5	38.91	246.0	39.29	252.5	39.57
	23	177.5	25.51	211.4	32.31	226.5	36.59	233.0	42.59	236.5	42.93	242.4	43.36	248.9	43.66
	25	177.5	27.24	211.4	34.17	226.5	39.09	230.3	47.24	233.0	47.61	239.5	48.09	246.0	48.42
	27	177.5	29.15	211.4	36.52	223.7	41.65	226.5	52.00	230.3	52.42	236.5	52.94	242.4	53.30
	29	177.5	31.06	211.4	39.05	220.0	44.81	223.3	57.15	226.5	57.49	233.0	58.01	239.5	58.24
	31	177.5	33.14	210.7	41.13	216.4	47.67	220.0	56.91	223.3	57.25	229.4	57.77	235.9	57.99
	33	177.5	35.31	207.0	43.58	213.5	51.12	217.0	56.39	220.0	56.73	226.5	57.24	232.3	57.46
	35	177.5	37.65	203.4	45.64	209.9	55.38	213.5	55.66	217.0	55.99	222.9	56.49	229.4	56.71
	37	177.5	40.15	200.5	47.89	207.0	54.65	209.9	54.92	213.5	55.25	219.4	55.74	225.9	55.96
	39	177.5	42.75	197.0	50.41	203.4	53.91	207.0	54.19	209.9	54.51	216.4	55.00	222.9	55.22
41	173.0	45.36	188.8	52.93	195.2	53.18	198.1	53.45	202.0	53.77	208.1	54.25	213.7	54.47	
43	168.7	47.83	180.9	52.19	187.2	52.45	190.1	52.72	193.9	53.03	199.8	53.51	205.3	53.72	
46	158.1	51.20	165.1	51.10	171.0	51.35	173.7	51.61	177.3	51.92	182.9	52.39	188.0	52.59	
48	139.8	49.77	143.4	49.92	148.7	50.03	151.1	50.17	154.3	50.60	159.2	50.92	163.7	51.12	
120	10	160.6	17.45	191.0	21.39	208.7	25.42	215.1	27.47	221.4	27.91	233.5	28.02	239.1	28.24
	12	160.6	17.92	191.0	22.12	208.7	26.44	215.1	28.05	221.4	28.94	233.5	29.29	239.1	29.53
	14	160.6	18.54	191.0	22.87	208.7	27.51	215.1	29.12	221.4	30.00	233.5	30.45	239.1	30.69
	16	160.6	19.20	191.0	23.80	208.7	28.58	215.1	30.21	221.4	31.39	233.5	31.78	239.1	32.03
	18	160.6	19.96	191.0	24.88	208.7	29.72	215.1	31.80	221.4	33.00	233.5	33.38	239.1	33.64
	20	160.6	20.72	191.0	26.37	208.7	31.32	215.1	33.46	221.4	34.75	233.5	35.20	239.1	35.49
	21	160.6	21.34	191.0	27.33	208.7	32.20	215.1	34.45	221.4	35.89	233.5	36.35	239.1	36.64
	23	160.6	22.82	191.0	29.24	208.7	34.50	215.1	36.60	221.4	38.26	233.5	38.65	239.1	38.96
	25	160.6	24.38	191.0	31.32	208.7	36.39	215.1	39.02	221.4	41.03	230.7	41.38	236.3	41.71
	27	160.6	26.03	191.0	33.49	208.7	38.72	215.1	41.69	221.4	44.10	227.1	44.39	232.8	44.75
	29	160.6	27.76	191.0	35.74	208.7	40.75	215.1	44.61	217.9	47.00	223.5	47.70	229.9	48.09
	31	160.6	29.58	191.0	38.17	208.7	42.86	212.3	47.80	215.1	50.42	220.7	51.31	226.3	51.72
	33	160.6	31.49	191.0	40.69	205.9	45.33	208.7	51.88	211.5	54.13	217.2	54.75	222.9	55.18
	35	160.6	33.49	191.0	43.38	202.3	47.98	205.1	57.15	208.7	57.44	214.4	57.61	220.0	58.06
	37	160.6	36.02	191.0	45.77	199.4	51.16	202.3	55.95	205.1	56.23	210.8	56.40	216.5	56.84
	39	160.6	38.78	190.3	48.38	196.0	54.26	198.8	54.80	201.6	55.07	208.0	55.24	213.6	55.68
41	156.5	41.53	182.0	50.98	188.1	53.19	190.8	53.65	193.6	53.92	199.2	54.08	204.8	54.51	
43	152.6	44.33	174.4	50.25	180.4	52.00	183.0	52.50	185.7	52.76	191.2	52.92	196.7	53.34	
46	143.0	47.67	159.0	49.05	164.8	50.36	167.2	50.78	169.7	51.03	174.9	51.18	180.0	51.59	
48	126.5	46.70	138.0	48.18	143.2	49.38	145.4	49.68	147.6	49.84	152.1	50.04	156.7	50.24	
110	10	143.9	15.69	171.5	19.13	191.6	22.72	197.1	24.60	209.6	26.47	214.4	27.20	228.9	27.66
	12	143.9	16.18	171.5	19.77	191.6	23.66	197.1	25.29	209.6	27.46	214.4	28.35	228.9	29.00
	14	143.9	16.69	171.5	20.66	191.6	24.74	197.1	26.54	209.6	28.85	214.4	29.67	228.9	30.29
	16	143.9	17.28	171.5	21.42	191.6	25.76	197.1	27.70	209.6	30.18	214.4	31.00	228.9	31.55
	18	143.9	17.92	171.5	22.31	191.6	27.24	197.1	29.17	209.6	31.83	214.4	32.46	228.9	33.07
	20	143.9	18.56	171.5	23.42	191.6	28.89	197.1	30.51	209.6	33.38	214.4	34.20	228.9	34.75
	21	143.9	18.97	171.5	24.12	191.6	29.63	197.1	31.33	209.6	34.30	214.4	35.17	228.9	35.72
	23	143.9	20.21	171.5	25.85	191.6	31.29	197.1	33.07	209.6	36.24	214.4	37.02	228.9	37.63
	25	143.9	21.60	171.5	27.59	191.6	33.05	197.1	34.97	209.6	38.29	214.4	38.84	226.1	39.63
	27	143.9	23.08	171.5	29.50	191.6	34.93	197.1	37.01	209.6	39.99	214.4	40.91	222.8	41.60
	29	143.9	24.64	171.5	31.49	191.6	36.91	197.1	39.19	209.6	42.26	214.4	42.99	220.0	43.64
	31	143.9	26.20	171.5	33.57	191.6	39.00	197.1	41.52	206.1	44.41	211.6	45.28	216.5	45.75
	33	143.9	27.94	171.5	35.74	191.6	41.21	197.1	44.00	203.3	46.90	208.2	47.67	213.7	47.94
	35	143.9	29.67	171.5	38.17	191.6	43.52	197.1	46.63	199.9	49.49	204.7	49.95	210.3	50.20
	37	143.9	31.45	171.5	40.51	191.6	45.94	194.3	49.40	196.4	52.20	202.0	52.38	206.8	52.53
	39	143.9	33.90	171.5	43.05	188.1	48.48	190.9	52.84	193.7	54.79	198.5	54.88	204.1	54.93
41	140.2	36.36	167.1	45.59	180.1	51.12	182.9	57.15	185.3	57.15	190.7	57.61	195.4	58.06	
43	136.7	38.18	163.0	47.50	172.6	54.21	175.4	54.82	177.7	54.70	183.0	55.01	187.6	55.16	
46	128.1	37.26	152.8	45.85	157.5	51.45	160.2	51.45	162.3	51.89	167.2	52.18	171.6	52.32	
48	113.3	36.19	132.8	44.17	136.8	48.95	139.3	49.28	141.1	49.51	145.5	49.65	149.3	49.85	

# 7. Capacity Tables

Cooling Capacity (64HP)

Combination (%)	Outdoor air temp. (DB, °C)	Indoor air temp. (DB/WB, °C)													
		20		23		26		27		28		30		32	
		14		16		18		19		20		22		24	
		TC	PI	TC	PI	TC	PI	TC	PI	TC	PI	TC	PI	TC	PI
100	10	121.0	14.13	144.0	17.18	167.7	20.38	179.2	22.02	190.7	23.66	211.5	26.34	216.1	26.55
	12	121.0	14.58	144.0	17.88	167.7	21.07	179.2	22.61	190.7	24.41	211.5	27.75	216.1	28.03
	14	121.0	15.04	144.0	18.59	167.7	21.96	179.2	23.59	190.7	25.47	211.5	29.31	216.1	29.58
	16	121.0	15.50	144.0	19.21	167.7	22.89	179.2	24.71	190.7	26.84	211.5	30.72	216.1	31.15
	18	121.0	15.96	144.0	19.92	167.7	23.78	179.2	25.92	190.7	28.46	211.5	32.46	216.1	32.72
	20	121.0	16.53	144.0	20.67	167.7	25.16	179.2	27.76	190.7	30.45	211.5	34.01	216.1	34.28
	21	121.0	16.87	144.0	21.17	167.7	26.03	179.2	28.72	190.7	31.58	211.5	34.79	216.1	35.07
	23	121.0	17.87	144.0	22.64	167.7	27.94	179.2	30.80	190.7	33.83	211.5	36.43	216.1	36.72
	25	121.0	19.00	144.0	24.12	167.7	29.84	179.2	32.97	190.7	36.18	211.5	37.98	214.3	38.29
	27	121.0	20.30	144.0	25.77	167.7	31.93	179.2	35.22	190.7	38.46	207.3	39.77	211.7	40.09
	29	121.0	21.60	144.0	27.50	167.7	34.09	179.2	37.65	190.7	40.71	203.5	41.37	208.5	41.70
	31	121.0	23.08	144.0	29.32	167.7	36.35	179.2	40.17	190.7	42.78	200.4	42.97	205.3	43.31
	33	121.0	24.46	144.0	31.23	167.7	38.78	179.2	42.86	190.7	44.38	197.2	44.57	202.1	44.93
	35	121.0	26.03	144.0	33.23	167.7	41.30	179.2	45.72	187.8	45.99	193.6	46.17	198.6	46.54
	37	121.0	27.87	144.0	35.64	167.7	43.74	179.2	47.90	184.7	48.13	190.0	48.33	194.6	48.77
	39	121.0	29.88	144.0	38.28	167.7	46.35	179.2	50.24	181.6	50.46	187.0	50.65	191.4	51.12
	41	119.0	31.89	141.7	40.93	165.0	48.96	171.9	52.58	175.7	52.79	179.9	52.97	185.7	53.47
43	115.0	33.75	136.8	43.39	159.3	51.30	164.9	54.59	166.8	54.78	171.9	54.96	176.4	55.48	
46	107.7	36.31	128.2	46.78	149.3	54.42	150.5	57.15	152.2	57.32	157.0	57.49	161.3	58.03	
48	95.3	31.35	113.4	40.47	128.9	46.52	130.8	48.49	132.2	48.65	136.5	48.76	140.2	49.15	
90	10	108.8	13.11	129.9	15.76	151.0	18.58	161.3	20.02	171.5	21.55	192.6	24.12	213.8	26.55
	12	108.8	13.27	129.9	16.00	151.0	18.90	161.3	20.43	171.5	22.03	192.6	24.60	213.8	27.30
	14	108.8	13.51	129.9	16.33	151.0	19.30	161.3	20.83	171.5	22.44	192.6	25.08	213.8	27.86
	16	108.8	13.75	129.9	16.65	151.0	19.70	161.3	21.23	171.5	22.84	192.6	25.56	213.8	28.33
	18	108.8	13.99	129.9	16.97	151.0	20.02	161.3	21.71	171.5	23.32	192.6	26.11	213.8	29.76
	20	108.8	14.23	129.9	17.29	151.0	20.43	161.3	22.12	171.5	24.21	192.6	27.94	213.8	31.18
	21	108.8	14.39	129.9	17.45	151.0	20.83	161.3	22.84	171.5	25.09	192.6	28.40	213.8	31.89
	23	108.8	14.72	129.9	18.17	151.0	22.28	161.3	24.53	171.5	26.86	192.6	30.12	210.8	33.40
	25	108.8	15.44	129.9	19.38	151.0	23.80	161.3	26.22	171.5	28.71	192.6	32.20	207.8	34.82
	27	108.8	16.49	129.9	20.67	151.0	25.41	161.3	27.99	171.5	30.72	192.6	34.24	204.7	36.46
	29	108.8	17.45	129.9	22.03	151.0	27.18	161.3	29.92	171.5	32.81	192.6	36.27	201.7	37.93
	31	108.8	18.58	129.9	23.48	151.0	28.95	161.3	31.85	171.5	34.98	192.6	38.08	198.6	39.39
	33	108.8	19.78	129.9	25.01	151.0	30.88	161.3	33.94	171.5	37.10	192.6	39.92	195.6	40.86
	35	108.8	20.99	129.9	26.54	151.0	32.81	161.3	36.19	171.5	39.35	189.3	42.21	192.6	43.18
	37	108.8	22.28	129.9	28.23	151.0	34.99	161.3	38.44	171.5	41.53	186.3	44.12	189.5	45.11
	39	108.8	23.58	129.9	30.02	151.0	37.03	161.3	40.91	171.5	43.67	183.2	46.52	186.5	47.08
	41	106.0	26.39	126.6	33.29	147.2	40.64	157.2	44.74	167.1	47.15	175.6	49.02	178.7	50.15
43	103.4	28.49	123.5	35.97	143.5	44.39	153.3	48.18	163.0	50.56	168.3	52.46	171.4	53.13	
46	96.9	32.06	115.7	40.96	134.5	50.58	143.6	54.63	148.1	56.17	153.7	57.34	156.6	57.53	
48	85.7	28.02	102.4	35.83	119.0	44.25	127.1	47.65	128.6	48.25	133.6	48.76	136.1	49.15	
80	10	96.6	12.23	115.2	14.69	133.8	17.24	143.4	18.59	153.0	19.95	171.5	22.76	190.1	24.71
	12	96.6	12.48	115.2	14.86	133.8	17.58	143.4	18.93	153.0	20.29	171.5	23.18	190.1	25.19
	14	96.6	12.65	115.2	15.20	133.8	17.83	143.4	19.27	153.0	20.63	171.5	23.60	190.1	25.68
	16	96.6	12.82	115.2	15.45	133.8	18.17	143.4	19.61	153.0	21.06	171.5	24.11	190.1	26.17
	18	96.6	13.08	115.2	15.71	133.8	18.51	143.4	19.95	153.0	21.48	171.5	24.54	190.1	26.74
	20	96.6	13.33	115.2	16.05	133.8	18.93	143.4	20.38	153.0	21.91	171.5	25.47	190.1	28.33
	21	96.6	13.42	115.2	16.22	133.8	19.10	143.4	20.63	153.0	22.42	171.5	26.28	190.1	29.09
	23	96.6	13.67	115.2	16.47	133.8	19.95	143.4	21.91	153.0	23.94	171.5	27.74	190.1	30.53
	25	96.6	14.18	115.2	17.58	133.8	21.40	143.4	23.43	153.0	25.64	171.5	29.69	190.1	32.64
	27	96.6	15.03	115.2	18.68	133.8	22.84	143.4	25.05	153.0	27.34	171.5	31.55	190.1	34.34
	29	96.6	15.96	115.2	19.95	133.8	24.28	143.4	26.66	153.0	29.21	171.5	33.80	190.1	36.03
	31	96.6	16.98	115.2	21.14	133.8	25.90	143.4	28.44	153.0	31.08	171.5	35.87	190.1	37.82
	33	96.6	18.00	115.2	22.59	133.8	27.59	143.4	30.31	153.0	33.11	171.5	37.80	190.1	39.64
	35	96.6	19.10	115.2	23.94	133.8	29.38	143.4	32.26	153.0	35.32	171.5	40.07	188.1	41.88
	37	96.6	20.21	115.2	25.46	133.8	31.16	143.4	34.30	153.0	37.53	171.5	42.29	185.0	43.85
	39	96.6	21.36	115.2	26.91	133.8	33.33	143.4	36.88	153.0	40.33	171.5	44.68	182.0	46.25
	41	94.2	23.63	112.3	29.82	130.3	36.58	139.7	40.42	149.0	44.32	167.1	48.04	174.4	49.14
43	91.8	26.01	109.5	32.55	127.1	39.93	136.2	44.05	145.4	48.43	163.0	51.41	167.1	52.60	
46	86.1	28.93	102.6	36.66	119.1	44.99	127.7	49.03	136.2	54.65	149.1	57.34	152.6	57.53	
48	76.1	25.27	90.8	32.06	105.4	39.35	112.9	42.83	120.5	47.78	129.5	48.76	132.6	49.15	

# 7. Capacity Tables

Cooling Capacity (64HP)

Combination (%)	Outdoor air temp. (DB, °C)	Indoor air temp. (DB/WB, °C)													
		20		23		26		27		28		30		32	
		14		16		18		19		20		22		24	
		TC	PI	TC	PI	TC	PI	TC	PI	TC	PI	TC	PI	TC	PI
70	10	84.5	10.82	101.1	12.86	117.1	14.90	125.4	16.10	133.8	17.20	149.8	19.59	166.4	21.91
	12	84.5	10.99	101.1	13.03	117.1	15.24	125.4	16.35	133.8	17.54	149.8	19.93	166.4	22.32
	14	84.5	11.16	101.1	13.20	117.1	15.50	125.4	16.61	133.8	17.80	149.8	20.35	166.4	22.73
	16	84.5	11.33	101.1	13.46	117.1	15.76	125.4	16.95	133.8	18.14	149.8	20.69	166.4	23.22
	18	84.5	11.50	101.1	13.71	117.1	16.10	125.4	17.29	133.8	18.48	149.8	21.04	166.4	23.63
	20	84.5	11.67	101.1	13.97	117.1	16.35	125.4	17.63	133.8	18.91	149.8	21.55	166.4	24.53
	21	84.5	11.84	101.1	14.05	117.1	16.52	125.4	17.80	133.8	19.08	149.8	21.89	166.4	25.05
	23	84.5	12.01	101.1	14.39	117.1	16.86	125.4	18.40	133.8	20.01	149.8	23.42	166.4	26.45
	25	84.5	12.18	101.1	14.90	117.1	17.97	125.4	19.67	133.8	21.38	149.8	25.04	166.4	27.73
	27	84.5	12.86	101.1	15.93	117.1	19.16	125.4	20.86	133.8	22.82	149.8	26.74	166.4	29.47
	29	84.5	13.71	101.1	16.86	117.1	20.35	125.4	22.23	133.8	24.27	149.8	28.53	166.4	31.57
	31	84.5	14.56	101.1	17.97	117.1	21.72	125.4	23.76	133.8	25.89	149.8	30.40	166.4	33.50
	33	84.5	15.41	101.1	18.99	117.1	23.08	125.4	25.21	133.8	27.51	149.8	32.36	166.4	35.66
	35	84.5	16.27	101.1	20.28	117.1	24.53	125.4	26.83	133.8	29.30	149.8	34.49	166.4	37.81
	37	84.5	17.29	101.1	21.47	117.1	26.06	125.4	28.53	133.8	31.17	149.8	36.71	166.4	39.91
	39	84.5	18.36	101.1	22.89	117.1	27.86	125.4	30.69	133.8	33.67	149.8	39.28	166.4	43.03
	41	82.3	20.30	98.5	25.08	114.1	30.56	122.2	33.67	130.3	36.60	145.9	43.15	162.1	46.42
	43	80.3	22.09	96.1	27.33	111.3	33.35	119.2	36.71	127.1	39.97	142.3	47.13	158.1	50.18
46	75.2	24.55	90.1	30.73	104.3	37.56	111.7	40.89	119.1	45.06	133.4	53.16	148.2	55.93	
48	66.6	21.43	79.7	26.84	92.3	32.83	98.8	35.74	105.4	39.42	118.0	46.52	131.1	48.30	
60	10	72.3	9.40	86.4	11.02	100.5	12.81	107.5	13.75	114.6	14.61	128.6	16.57	142.7	18.54
	12	72.3	9.57	86.4	11.19	100.5	12.98	107.5	13.92	114.6	14.86	128.6	16.83	142.7	18.88
	14	72.3	9.65	86.4	11.36	100.5	13.24	107.5	14.18	114.6	15.12	128.6	17.17	142.7	19.22
	16	72.3	9.82	86.4	11.62	100.5	13.41	107.5	14.44	114.6	15.46	128.6	17.51	142.7	19.56
	18	72.3	9.99	86.4	11.79	100.5	13.67	107.5	14.69	114.6	15.72	128.6	17.77	142.7	19.99
	20	72.3	10.16	86.4	11.96	100.5	13.92	107.5	14.95	114.6	15.97	128.6	18.11	142.7	20.41
	21	72.3	10.25	86.4	12.04	100.5	14.09	107.5	15.12	114.6	16.14	128.6	18.36	142.7	20.59
	23	72.3	10.42	86.4	12.30	100.5	14.26	107.5	15.38	114.6	16.49	128.6	19.05	142.7	21.87
	25	72.3	10.59	86.4	12.56	100.5	14.86	107.5	16.14	114.6	17.51	128.6	20.33	142.7	23.40
	27	72.3	10.93	86.4	13.24	100.5	15.80	107.5	17.17	114.6	18.62	128.6	21.61	142.7	24.94
	29	72.3	11.62	86.4	14.09	100.5	16.83	107.5	18.28	114.6	19.82	128.6	23.06	142.7	26.65
	31	72.3	12.30	86.4	14.95	100.5	17.85	107.5	19.48	114.6	21.10	128.6	24.60	142.7	28.36
	33	72.3	12.98	86.4	15.80	100.5	18.96	107.5	20.67	114.6	22.46	128.6	26.14	142.7	30.24
	35	72.3	13.75	86.4	16.83	100.5	20.16	107.5	21.95	114.6	23.83	128.6	27.85	142.7	32.12
	37	72.3	14.52	86.4	17.76	100.5	21.35	107.5	23.32	114.6	25.28	128.6	29.55	142.7	34.17
	39	72.3	15.44	86.4	18.91	100.5	23.05	107.5	25.02	114.6	27.21	128.6	31.69	142.7	36.61
	41	70.5	16.75	84.2	20.69	97.9	25.03	104.8	27.33	111.6	29.54	125.3	34.78	139.1	39.79
	43	68.7	18.20	82.1	22.53	95.5	27.29	102.2	29.78	108.9	32.21	122.2	37.96	135.6	43.46
46	64.4	20.38	76.9	25.29	89.5	30.69	95.8	33.48	102.0	36.24	114.6	42.78	127.1	49.51	
48	57.0	17.76	68.1	22.08	79.2	26.81	84.7	29.24	90.3	31.67	101.3	37.41	112.4	43.32	
50	10	60.5	8.14	72.3	9.42	83.8	10.71	89.6	11.48	95.4	12.17	106.9	13.71	119.0	15.25
	12	60.5	8.22	72.3	9.51	83.8	10.88	89.6	11.65	95.4	12.42	106.9	13.96	119.0	15.51
	14	60.5	8.31	72.3	9.68	83.8	11.05	89.6	11.82	95.4	12.59	106.9	14.14	119.0	15.76
	16	60.5	8.48	72.3	9.85	83.8	11.22	89.6	12.08	95.4	12.77	106.9	14.39	119.0	16.02
	18	60.5	8.57	72.3	9.94	83.8	11.39	89.6	12.25	95.4	13.02	106.9	14.65	119.0	16.36
	20	60.5	8.65	72.3	10.11	83.8	11.65	89.6	12.42	95.4	13.28	106.9	14.91	119.0	16.71
	21	60.5	8.74	72.3	10.20	83.8	11.74	89.6	12.59	95.4	13.37	106.9	15.08	119.0	16.88
	23	60.5	8.91	72.3	10.37	83.8	11.91	89.6	12.77	95.4	13.62	106.9	15.34	119.0	17.22
	25	60.5	9.00	72.3	10.54	83.8	12.17	89.6	13.02	95.4	14.05	106.9	16.11	119.0	18.42
	27	60.5	9.17	72.3	10.88	83.8	12.85	89.6	13.88	95.4	14.91	106.9	17.22	119.0	19.62
	29	60.5	9.68	72.3	11.57	83.8	13.62	89.6	14.74	95.4	15.85	106.9	18.25	119.0	20.82
	31	60.5	10.20	72.3	12.25	83.8	14.48	89.6	15.59	95.4	16.88	106.9	19.45	119.0	22.19
	33	60.5	10.79	72.3	12.94	83.8	15.34	89.6	16.53	95.4	17.91	106.9	20.65	119.0	23.65
	35	60.5	11.39	72.3	13.71	83.8	16.19	89.6	17.56	95.4	18.93	106.9	21.85	119.0	25.10
	37	60.5	12.08	72.3	14.48	83.8	17.13	89.6	18.59	95.4	20.05	106.9	23.30	119.0	26.64
	39	60.5	12.89	72.3	15.52	83.8	18.36	89.6	20.01	95.4	21.51	106.9	24.82	119.0	28.78
	41	58.9	13.93	70.5	16.80	81.7	20.07	87.3	21.67	92.9	23.31	104.1	27.21	116.0	31.25
	43	57.5	15.14	68.7	18.28	79.7	21.84	85.1	23.60	90.6	25.37	101.6	29.67	113.1	34.09
46	53.9	16.96	64.4	20.50	74.7	24.50	79.8	26.50	84.9	28.49	95.2	33.38	106.0	38.38	
48	47.6	14.78	57.0	17.88	66.1	21.37	70.6	23.13	75.1	24.86	84.2	29.17	93.8	33.55	

**Note**

1. TC: Total Capacity(kW), PI : Power Input(kW, Comp. + Outdoor fan motor)
2. Capacity tables show the average value of conditions which may occur.

# 7. Capacity Tables

◆ ARUM660LTE5

Cooling Capacity (66HP)

Combination (%)	Outdoor air temp. (DB, °C)	Indoor air temp. (DB/WB, °C)													
		20		23		26		27		28		30		32	
		14	16	16	18	18	19	20	20	22	22	24	24		
		TC	PI	TC	PI	TC	PI	TC	PI	TC	PI	TC	PI	TC	PI
130	10	183.0	19.45	218.0	23.77	233.6	27.58	240.3	28.14	247.0	28.36	258.9	28.59	265.6	28.70
	12	183.0	19.93	218.0	24.62	233.6	28.71	240.3	28.90	247.0	29.13	258.9	29.36	265.6	29.62
	14	183.0	20.60	218.0	25.51	233.6	29.79	240.3	30.01	247.0	30.25	258.9	30.49	265.6	30.76
	16	183.0	21.35	218.0	26.40	233.6	31.12	240.3	31.41	247.0	31.66	258.9	31.95	265.6	32.20
	18	183.0	22.25	218.0	27.93	233.6	32.55	240.3	33.25	247.0	33.52	258.9	33.85	265.6	34.08
	20	183.0	23.23	218.0	29.75	233.6	34.16	240.3	36.58	247.0	36.87	255.2	37.24	261.9	37.49
	21	183.0	23.84	218.0	30.80	233.6	34.87	240.3	38.71	247.0	39.02	253.7	39.41	260.4	39.68
	23	183.0	25.58	218.0	32.40	233.6	36.69	240.3	42.71	243.9	43.06	250.0	43.48	256.7	43.78
	25	183.0	27.32	218.0	34.26	233.6	39.20	237.5	47.37	240.3	47.75	247.0	48.22	253.7	48.55
	27	183.0	29.23	218.0	36.63	230.7	41.77	233.6	52.15	237.5	52.57	243.9	53.09	250.0	53.45
	29	183.0	31.15	218.0	39.16	226.9	44.94	230.2	57.31	233.6	57.66	240.3	58.17	247.0	58.40
	31	183.0	33.23	217.3	41.25	223.2	47.80	226.9	57.07	230.2	57.42	236.6	57.93	243.3	58.16
	33	183.0	35.41	213.5	43.70	220.2	51.27	223.8	56.55	226.9	56.89	233.6	57.40	239.5	57.63
	35	183.0	37.76	209.8	45.77	216.5	55.54	220.2	55.81	223.8	56.15	229.9	56.65	236.6	56.87
	37	183.0	40.26	206.8	48.03	213.5	54.80	216.5	55.08	220.2	55.41	226.2	55.90	232.9	56.12
	39	183.0	42.88	203.1	50.56	209.8	54.07	213.5	54.34	216.5	54.67	223.2	55.15	229.9	55.37
	41	178.4	45.49	194.7	53.08	201.3	53.33	204.3	53.60	208.3	53.92	214.6	54.41	220.4	54.62
	43	173.9	47.97	186.6	52.34	193.1	52.60	196.0	52.87	199.9	53.18	206.1	53.66	211.7	53.87
46	163.0	51.35	170.2	51.24	176.4	51.50	179.2	51.76	182.9	52.07	188.6	52.54	193.8	52.74	
48	144.2	49.92	147.8	50.07	153.4	50.17	155.8	50.31	159.1	50.74	164.2	51.06	168.8	51.26	
120	10	165.6	17.50	196.9	21.46	215.2	25.49	221.8	27.55	228.3	27.99	240.7	28.10	246.6	28.32
	12	165.6	17.97	196.9	22.18	215.2	26.52	221.8	28.13	228.3	29.02	240.7	29.38	246.6	29.61
	14	165.6	18.59	196.9	22.93	215.2	27.59	221.8	29.20	228.3	30.09	240.7	30.53	246.6	30.78
	16	165.6	19.26	196.9	23.87	215.2	28.66	221.8	30.29	228.3	31.48	240.7	31.87	246.6	32.12
	18	165.6	20.01	196.9	24.95	215.2	29.80	221.8	31.89	228.3	33.09	240.7	33.47	246.6	33.74
	20	165.6	20.77	196.9	26.45	215.2	31.41	221.8	33.56	228.3	34.85	240.7	35.30	246.6	35.59
	21	165.6	21.40	196.9	27.41	215.2	32.29	221.8	34.54	228.3	35.99	240.7	36.45	246.6	36.74
	23	165.6	22.88	196.9	29.32	215.2	34.60	221.8	36.71	228.3	38.37	240.7	38.76	246.6	39.07
	25	165.6	24.45	196.9	31.41	215.2	36.49	221.8	39.13	228.3	41.15	237.9	41.49	243.6	41.83
	27	165.6	26.10	196.9	33.58	215.2	38.83	221.8	41.81	228.3	44.22	234.2	44.52	240.1	44.88
	29	165.6	27.84	196.9	35.84	215.2	40.86	221.8	44.74	224.7	47.13	230.5	47.84	237.1	48.22
	31	165.6	29.67	196.9	38.28	215.2	42.98	218.9	47.93	221.8	50.56	227.6	51.45	233.4	51.86
	33	165.6	31.58	196.9	40.80	212.3	45.46	215.2	52.03	218.1	54.28	224.0	54.90	229.8	55.34
	35	165.6	33.58	196.9	43.50	208.7	48.12	211.5	57.31	215.2	57.60	221.1	57.77	226.8	58.23
	37	165.6	36.12	196.9	45.90	205.7	51.30	208.7	56.11	211.5	56.39	217.4	56.56	223.3	57.01
	39	165.6	38.89	196.2	48.51	202.1	54.41	205.0	54.95	207.9	55.23	214.5	55.39	220.3	55.83
	41	161.4	41.65	187.7	51.13	194.0	53.34	196.8	53.80	199.6	54.07	205.4	54.23	211.2	54.66
	43	157.4	44.46	179.8	50.40	186.0	52.14	188.7	52.65	191.5	52.91	197.2	53.07	202.9	53.49
46	147.5	47.81	164.0	49.19	169.9	50.51	172.4	50.92	175.0	51.18	180.3	51.33	185.7	51.74	
48	130.5	46.83	142.4	48.32	147.7	49.52	149.9	49.82	152.2	49.98	156.9	50.18	161.6	50.38	
110	10	148.4	15.74	176.9	19.18	197.6	22.79	203.2	24.67	216.1	26.54	221.1	27.28	236.1	27.74
	12	148.4	16.23	176.9	19.83	197.6	23.73	203.2	25.36	216.1	27.54	221.1	28.43	236.1	29.08
	14	148.4	16.74	176.9	20.72	197.6	24.81	203.2	26.62	216.1	28.93	221.1	29.75	236.1	30.38
	16	148.4	17.33	176.9	21.48	197.6	25.83	203.2	27.78	216.1	30.26	221.1	31.09	236.1	31.63
	18	148.4	17.97	176.9	22.37	197.6	27.32	203.2	29.25	216.1	31.92	221.1	32.55	236.1	33.16
	20	148.4	18.62	176.9	23.49	197.6	28.97	203.2	30.60	216.1	33.47	221.1	34.30	236.1	34.85
	21	148.4	19.03	176.9	24.19	197.6	29.72	203.2	31.42	216.1	34.40	221.1	35.27	236.1	35.82
	23	148.4	20.27	176.9	25.93	197.6	31.38	203.2	33.17	216.1	36.35	221.1	37.12	236.1	37.74
	25	148.4	21.66	176.9	27.67	197.6	33.14	203.2	35.07	216.1	38.40	221.1	38.95	233.2	39.75
	27	148.4	23.14	176.9	29.58	197.6	35.02	203.2	37.11	216.1	40.10	221.1	41.02	229.7	41.72
	29	148.4	24.71	176.9	31.58	197.6	37.01	203.2	39.30	216.1	42.38	221.1	43.11	226.9	43.76
	31	148.4	26.27	176.9	33.67	197.6	39.11	203.2	41.64	212.6	44.53	218.2	45.41	223.3	45.88
	33	148.4	28.01	176.9	35.84	197.6	41.32	203.2	44.13	209.7	47.03	214.7	47.81	220.4	48.07
	35	148.4	29.75	176.9	38.28	197.6	43.64	203.2	46.76	206.2	49.63	211.1	50.09	216.9	50.34
	37	148.4	31.53	176.9	40.63	197.6	46.07	200.4	49.54	202.6	52.35	208.3	52.53	213.3	52.68
	39	148.4	34.00	176.9	43.17	194.0	48.61	196.8	52.99	199.7	54.94	204.7	55.03	210.4	55.09
	41	144.6	36.46	172.4	45.72	185.7	51.26	188.6	57.31	191.1	57.31	196.6	57.77	201.5	58.23
	43	141.0	38.29	168.1	47.63	178.0	54.36	180.9	54.98	183.2	54.86	188.7	55.17	193.5	55.32
46	132.1	37.37	157.5	45.98	162.4	51.59	165.2	51.59	167.4	52.04	172.5	52.33	176.9	52.47	
48	116.9	36.29	136.9	44.30	141.0	49.09	143.6	49.42	145.5	49.66	150.0	49.80	154.0	49.99	

# 7. Capacity Tables

Cooling Capacity (66HP)

Combination (%)	Outdoor air temp. (DB, °C)	Indoor air temp. (DB/WB, °C)													
		20		23		26		27		28		30		32	
		14		16		18		19		20		22		24	
		TC	PI	TC	PI	TC	PI	TC	PI	TC	PI	TC	PI	TC	PI
100	10	124.7	14.17	148.5	17.23	172.9	20.44	184.8	22.08	196.7	23.73	218.1	26.41	222.9	26.62
	12	124.7	14.63	148.5	17.93	172.9	21.13	184.8	22.68	196.7	24.48	218.1	27.83	222.9	28.11
	14	124.7	15.08	148.5	18.64	172.9	22.02	184.8	23.66	196.7	25.54	218.1	29.39	222.9	29.66
	16	124.7	15.54	148.5	19.26	172.9	22.96	184.8	24.78	196.7	26.91	218.1	30.81	222.9	31.24
	18	124.7	16.00	148.5	19.98	172.9	23.85	184.8	25.99	196.7	28.54	218.1	32.55	222.9	32.81
	20	124.7	16.57	148.5	20.73	172.9	25.23	184.8	27.84	196.7	30.54	218.1	34.11	222.9	34.38
	21	124.7	16.92	148.5	21.23	172.9	26.10	184.8	28.80	196.7	31.67	218.1	34.89	222.9	35.17
	23	124.7	17.92	148.5	22.71	172.9	28.01	184.8	30.89	196.7	33.93	218.1	36.53	222.9	36.82
	25	124.7	19.05	148.5	24.19	172.9	29.93	184.8	33.06	196.7	36.28	218.1	38.09	221.0	38.39
	27	124.7	20.36	148.5	25.84	172.9	32.02	184.8	35.32	196.7	38.57	213.8	39.88	218.3	40.20
	29	124.7	21.66	148.5	27.58	172.9	34.19	184.8	37.76	196.7	40.82	209.8	41.49	215.0	41.82
	31	124.7	23.14	148.5	29.41	172.9	36.45	184.8	40.28	196.7	42.90	206.7	43.09	211.7	43.44
	33	124.7	24.53	148.5	31.32	172.9	38.89	184.8	42.98	196.7	44.51	203.4	44.70	208.4	45.06
	35	124.7	26.10	148.5	33.32	172.9	41.41	184.8	45.85	193.7	46.13	199.7	46.31	204.8	46.68
	37	124.7	27.95	148.5	35.74	172.9	43.87	184.8	48.03	190.5	48.27	196.0	48.46	200.6	48.91
	39	124.7	29.97	148.5	38.39	172.9	46.49	184.8	50.38	187.3	50.60	192.8	50.79	197.3	51.27
	41	122.8	31.98	146.1	41.05	170.2	49.10	177.3	52.73	181.2	52.94	185.5	53.12	191.5	53.62
	43	118.5	33.85	141.1	43.51	164.3	51.45	170.0	54.74	172.0	54.94	177.3	55.12	181.9	55.64
	46	111.1	36.41	132.3	46.91	154.0	54.57	155.2	57.31	156.9	57.48	161.9	57.65	166.3	58.19
	48	98.3	31.44	117.0	40.58	133.0	46.65	134.9	48.63	136.3	48.79	140.8	48.90	144.6	49.29
90	10	112.2	13.15	134.0	15.81	155.8	18.63	166.3	20.08	176.9	21.61	198.7	24.19	220.4	26.62
	12	112.2	13.31	134.0	16.05	155.8	18.95	166.3	20.49	176.9	22.10	198.7	24.67	220.4	27.38
	14	112.2	13.55	134.0	16.37	155.8	19.36	166.3	20.89	176.9	22.50	198.7	25.15	220.4	27.94
	16	112.2	13.79	134.0	16.69	155.8	19.76	166.3	21.29	176.9	22.91	198.7	25.63	220.4	28.41
	18	112.2	14.03	134.0	17.02	155.8	20.08	166.3	21.78	176.9	23.39	198.7	26.19	220.4	29.84
	20	112.2	14.28	134.0	17.34	155.8	20.49	166.3	22.18	176.9	24.28	198.7	28.03	220.4	31.27
	21	112.2	14.44	134.0	17.50	155.8	20.89	166.3	22.91	176.9	25.16	198.7	28.48	220.4	31.98
	23	112.2	14.76	134.0	18.23	155.8	22.34	166.3	24.60	176.9	26.94	198.7	30.21	217.4	33.49
	25	112.2	15.49	134.0	19.44	155.8	23.87	166.3	26.29	176.9	28.79	198.7	32.30	214.3	34.92
	27	112.2	16.53	134.0	20.73	155.8	25.49	166.3	28.07	176.9	30.81	198.7	34.34	211.1	36.56
	29	112.2	17.50	134.0	22.10	155.8	27.26	166.3	30.00	176.9	32.91	198.7	36.37	208.0	38.04
	31	112.2	18.63	134.0	23.55	155.8	29.03	166.3	31.94	176.9	35.08	198.7	38.19	204.9	39.51
	33	112.2	19.84	134.0	25.08	155.8	30.97	166.3	34.04	176.9	37.21	198.7	40.03	201.7	40.98
	35	112.2	21.05	134.0	26.62	155.8	32.91	166.3	36.29	176.9	39.46	195.2	42.33	198.6	43.30
	37	112.2	22.34	134.0	28.31	155.8	35.09	166.3	38.55	176.9	41.65	192.1	44.25	195.4	45.24
	39	112.2	23.65	134.0	30.11	155.8	37.14	166.3	41.03	176.9	43.80	189.0	46.65	192.3	47.21
	41	109.3	26.47	130.6	33.38	151.8	40.76	162.1	44.87	172.4	47.29	181.1	49.17	184.3	50.29
	43	106.6	28.57	127.3	36.07	148.0	44.52	158.1	48.32	168.1	50.70	173.6	52.61	176.8	53.29
	46	99.9	32.16	119.3	41.08	138.7	50.73	148.1	54.78	152.7	56.33	158.5	57.50	161.5	57.70
	48	88.4	28.10	105.6	35.93	122.7	44.38	131.0	47.78	132.6	48.39	137.7	48.90	140.3	49.29
80	10	99.7	12.26	118.8	14.73	137.9	17.29	147.8	18.65	157.7	20.01	176.9	22.82	196.0	24.78
	12	99.7	12.52	118.8	14.90	137.9	17.63	147.8	18.99	157.7	20.35	176.9	23.25	196.0	25.27
	14	99.7	12.69	118.8	15.24	137.9	17.88	147.8	19.33	157.7	20.69	176.9	23.67	196.0	25.76
	16	99.7	12.86	118.8	15.50	137.9	18.22	147.8	19.67	157.7	21.12	176.9	24.18	196.0	26.25
	18	99.7	13.11	118.8	15.75	137.9	18.56	147.8	20.01	157.7	21.54	176.9	24.61	196.0	26.82
	20	99.7	13.37	118.8	16.09	137.9	18.99	147.8	20.44	157.7	21.97	176.9	25.55	196.0	28.42
	21	99.7	13.45	118.8	16.26	137.9	19.16	147.8	20.69	157.7	22.48	176.9	26.35	196.0	29.17
	23	99.7	13.71	118.8	16.52	137.9	20.01	147.8	21.97	157.7	24.01	176.9	27.82	196.0	30.62
	25	99.7	14.22	118.8	17.63	137.9	21.46	147.8	23.50	157.7	25.72	176.9	29.78	196.0	32.74
	27	99.7	15.07	118.8	18.73	137.9	22.91	147.8	25.12	157.7	27.42	176.9	31.64	196.0	34.44
	29	99.7	16.01	118.8	20.01	137.9	24.35	147.8	26.74	157.7	29.29	176.9	33.90	196.0	36.13
	31	99.7	17.03	118.8	21.20	137.9	25.97	147.8	28.53	157.7	31.17	176.9	35.97	196.0	37.93
	33	99.7	18.05	118.8	22.65	137.9	27.67	147.8	30.40	157.7	33.21	176.9	37.90	196.0	39.75
	35	99.7	19.16	118.8	24.01	137.9	29.46	147.8	32.36	157.7	35.42	176.9	40.19	193.9	42.00
	37	99.7	20.27	118.8	25.53	137.9	31.25	147.8	34.40	157.7	37.64	176.9	42.42	190.8	43.97
	39	99.7	21.42	118.8	26.99	137.9	33.43	147.8	36.98	157.7	40.45	176.9	44.81	187.7	46.39
	41	97.1	23.69	115.8	29.91	134.4	36.69	144.1	40.54	153.7	44.44	172.4	48.18	179.8	49.29
	43	94.7	26.08	112.9	32.64	131.1	40.05	140.5	44.18	149.9	48.57	168.1	51.56	172.4	52.75
	46	88.8	29.02	105.8	36.77	122.8	45.13	131.7	49.17	140.5	54.81	153.7	57.50	157.3	57.70
	48	78.5	25.34	93.6	32.15	108.7	39.47	116.5	42.95	124.3	47.92	133.5	48.90	136.7	49.29

# 7. Capacity Tables

Cooling Capacity (66HP)

Combination (%)	Outdoor air temp. (DB, °C)	Indoor air temp. (DB/WB, °C)													
		20		23		26		27		28		30		32	
		14	16	18	19	20	22	24	TC	PI	TC	PI	TC	PI	
70	10	87.1	10.85	104.3	12.90	120.8	14.95	129.4	16.14	137.9	17.25	154.4	19.64	171.6	21.97
	12	87.1	11.02	104.3	13.07	120.8	15.29	129.4	16.40	137.9	17.59	154.4	19.99	171.6	22.38
	14	87.1	11.19	104.3	13.24	120.8	15.54	129.4	16.66	137.9	17.85	154.4	20.41	171.6	22.79
	16	87.1	11.36	104.3	13.49	120.8	15.80	129.4	17.00	137.9	18.19	154.4	20.75	171.6	23.29
	18	87.1	11.53	104.3	13.75	120.8	16.14	129.4	17.34	137.9	18.53	154.4	21.10	171.6	23.70
	20	87.1	11.70	104.3	14.01	120.8	16.40	129.4	17.68	137.9	18.96	154.4	21.61	171.6	24.60
	21	87.1	11.87	104.3	14.09	120.8	16.57	129.4	17.85	137.9	19.13	154.4	21.95	171.6	25.12
	23	87.1	12.04	104.3	14.43	120.8	16.91	129.4	18.45	137.9	20.07	154.4	23.49	171.6	26.52
	25	87.1	12.21	104.3	14.95	120.8	18.02	129.4	19.73	137.9	21.44	154.4	25.11	171.6	27.81
	27	87.1	12.90	104.3	15.97	120.8	19.22	129.4	20.93	137.9	22.89	154.4	26.82	171.6	29.55
	29	87.1	13.75	104.3	16.91	120.8	20.41	129.4	22.29	137.9	24.34	154.4	28.61	171.6	31.66
	31	87.1	14.61	104.3	18.02	120.8	21.78	129.4	23.83	137.9	25.96	154.4	30.49	171.6	33.60
	33	87.1	15.46	104.3	19.05	120.8	23.15	129.4	25.28	137.9	27.59	154.4	32.46	171.6	35.77
	35	87.1	16.31	104.3	20.34	120.8	24.60	129.4	26.90	137.9	29.38	154.4	34.59	171.6	37.93
	37	87.1	17.34	104.3	21.53	120.8	26.14	129.4	28.61	137.9	31.26	154.4	36.81	171.6	40.03
	39	87.1	18.41	104.3	22.96	120.8	27.95	129.4	30.78	137.9	33.77	154.4	39.40	171.6	43.15
	41	84.9	20.36	101.6	25.15	117.7	30.65	126.0	33.77	134.4	36.71	150.5	43.27	167.2	46.55
43	82.8	22.16	99.1	27.41	114.8	33.45	122.9	36.82	131.1	40.09	146.8	47.27	163.1	50.33	
46	77.6	24.62	92.9	30.82	107.6	37.67	115.2	41.01	122.8	45.19	137.5	53.32	152.8	56.10	
48	68.6	21.49	82.2	26.92	95.2	32.93	101.9	35.84	108.7	39.53	121.7	46.66	135.2	48.44	
60	10	74.6	9.42	89.1	11.05	103.6	12.85	110.9	13.79	118.1	14.65	132.7	16.62	147.2	18.59
	12	74.6	9.59	89.1	11.22	103.6	13.02	110.9	13.96	118.1	14.91	132.7	16.88	147.2	18.93
	14	74.6	9.68	89.1	11.39	103.6	13.28	110.9	14.22	118.1	15.16	132.7	17.22	147.2	19.28
	16	74.6	9.85	89.1	11.65	103.6	13.45	110.9	14.48	118.1	15.51	132.7	17.56	147.2	19.62
	18	74.6	10.02	89.1	11.82	103.6	13.71	110.9	14.73	118.1	15.76	132.7	17.82	147.2	20.05
	20	74.6	10.19	89.1	11.99	103.6	13.96	110.9	14.99	118.1	16.02	132.7	18.16	147.2	20.47
	21	74.6	10.28	89.1	12.08	103.6	14.14	110.9	15.16	118.1	16.19	132.7	18.42	147.2	20.65
	23	74.6	10.45	89.1	12.34	103.6	14.31	110.9	15.42	118.1	16.53	132.7	19.10	147.2	21.93
	25	74.6	10.62	89.1	12.59	103.6	14.91	110.9	16.19	118.1	17.56	132.7	20.39	147.2	23.47
	27	74.6	10.97	89.1	13.28	103.6	15.85	110.9	17.22	118.1	18.68	132.7	21.67	147.2	25.01
	29	74.6	11.65	89.1	14.14	103.6	16.88	110.9	18.33	118.1	19.87	132.7	23.13	147.2	26.73
	31	74.6	12.34	89.1	14.99	103.6	17.90	110.9	19.53	118.1	21.16	132.7	24.67	147.2	28.44
	33	74.6	13.02	89.1	15.85	103.6	19.02	110.9	20.73	118.1	22.53	132.7	26.21	147.2	30.33
	35	74.6	13.79	89.1	16.88	103.6	20.22	110.9	22.02	118.1	23.90	132.7	27.93	147.2	32.21
	37	74.6	14.56	89.1	17.81	103.6	21.42	110.9	23.39	118.1	25.36	132.7	29.64	147.2	34.27
	39	74.6	15.49	89.1	18.96	103.6	23.12	110.9	25.09	118.1	27.29	132.7	31.78	147.2	36.72
	41	72.7	16.80	86.8	20.75	101.0	25.10	108.0	27.41	115.1	29.62	129.3	34.88	143.4	39.90
43	70.9	18.25	84.7	22.59	98.5	27.37	105.4	29.87	112.3	32.30	126.1	38.07	139.9	43.59	
46	66.4	20.44	79.4	25.37	92.3	30.78	98.7	33.58	105.2	36.35	118.1	42.90	131.1	49.66	
48	58.8	17.81	70.2	22.14	81.6	26.89	87.4	29.32	93.1	31.76	104.5	37.52	116.0	43.45	
50	10	62.4	8.16	74.6	9.45	86.5	10.74	92.4	11.51	98.3	12.20	110.2	13.75	122.8	15.29
	12	62.4	8.25	74.6	9.54	86.5	10.91	92.4	11.69	98.3	12.46	110.2	14.01	122.8	15.55
	14	62.4	8.33	74.6	9.71	86.5	11.08	92.4	11.86	98.3	12.63	110.2	14.18	122.8	15.81
	16	62.4	8.51	74.6	9.88	86.5	11.26	92.4	12.12	98.3	12.80	110.2	14.44	122.8	16.07
	18	62.4	8.59	74.6	9.97	86.5	11.43	92.4	12.29	98.3	13.06	110.2	14.69	122.8	16.41
	20	62.4	8.68	74.6	10.14	86.5	11.69	92.4	12.46	98.3	13.32	110.2	14.95	122.8	16.76
	21	62.4	8.76	74.6	10.23	86.5	11.77	92.4	12.63	98.3	13.40	110.2	15.12	122.8	16.93
	23	62.4	8.94	74.6	10.40	86.5	11.94	92.4	12.80	98.3	13.66	110.2	15.38	122.8	17.27
	25	62.4	9.02	74.6	10.57	86.5	12.20	92.4	13.06	98.3	14.09	110.2	16.15	122.8	18.47
	27	62.4	9.19	74.6	10.91	86.5	12.89	92.4	13.92	98.3	14.95	110.2	17.27	122.8	19.68
	29	62.4	9.71	74.6	11.60	86.5	13.66	92.4	14.78	98.3	15.90	110.2	18.30	122.8	20.88
	31	62.4	10.23	74.6	12.29	86.5	14.52	92.4	15.64	98.3	16.93	110.2	19.50	122.8	22.25
	33	62.4	10.83	74.6	12.97	86.5	15.38	92.4	16.58	98.3	17.96	110.2	20.71	122.8	23.72
	35	62.4	11.43	74.6	13.75	86.5	16.24	92.4	17.61	98.3	18.99	110.2	21.91	122.8	25.18
	37	62.4	12.12	74.6	14.52	86.5	17.18	92.4	18.65	98.3	20.11	110.2	23.37	122.8	26.72
	39	62.4	12.92	74.6	15.57	86.5	18.41	92.4	20.07	98.3	21.57	110.2	24.89	122.8	28.86
	41	60.8	13.97	72.7	16.85	84.2	20.13	90.0	21.74	95.8	23.38	107.4	27.29	119.6	31.34
43	59.3	15.19	70.9	18.33	82.2	21.91	87.8	23.67	93.5	25.45	104.7	29.76	116.7	34.19	
46	55.5	17.01	66.4	20.56	77.0	24.57	82.3	26.58	87.6	28.57	98.2	33.48	109.3	38.49	
48	49.1	14.82	58.8	17.93	68.1	21.44	72.8	23.20	77.5	24.93	86.8	29.26	96.7	33.65	

**Note**

1. TC: Total Capacity(kW), PI : Power Input(kW, Comp. + Outdoor fan motor)
2. Capacity tables show the average value of conditions which may occur.

# 7. Capacity Tables

## ◆ ARUM680LTE5

Cooling Capacity (68HP)

Combination (%)	Outdoor air temp. (DB, °C)	Indoor air temp. (DB/WB, °C)													
		20		23		26		27		28		30		32	
		14	16	16	18	18	19	19	20	20	22	22	24	24	
		TC	PI	TC	PI	TC	PI	TC	PI	TC	PI	TC	PI	TC	PI
130	10	188.6	20.18	224.6	24.67	240.7	28.62	247.6	29.20	254.5	29.43	266.8	29.66	273.7	29.78
	12	188.6	20.68	224.6	25.55	240.7	29.79	247.6	29.99	254.5	30.23	266.8	30.47	273.7	30.74
	14	188.6	21.38	224.6	26.48	240.7	30.91	247.6	31.14	254.5	31.39	266.8	31.64	273.7	31.92
	16	188.6	22.16	224.6	27.40	240.7	32.30	247.6	32.60	254.5	32.86	266.8	33.15	273.7	33.41
	18	188.6	23.09	224.6	28.98	240.7	33.78	247.6	34.51	254.5	34.78	266.8	35.13	273.7	35.37
	20	188.6	24.11	224.6	30.88	240.7	35.45	247.6	37.96	254.5	38.26	262.9	38.64	269.8	38.91
	21	188.6	24.74	224.6	31.96	240.7	36.19	247.6	40.17	254.5	40.49	261.4	40.89	268.3	41.17
	23	188.6	26.54	224.6	33.62	240.7	38.07	247.6	44.33	251.3	44.68	257.6	45.12	264.5	45.43
	25	188.6	28.35	224.6	35.56	240.7	40.68	244.7	49.16	247.6	49.55	254.5	50.04	261.4	50.39
	27	188.6	30.34	224.6	38.01	237.7	43.35	240.7	54.12	244.7	54.55	251.3	55.09	257.6	55.47
	29	188.6	32.32	224.6	40.64	233.8	46.64	237.2	59.48	240.7	59.83	247.6	60.37	254.5	60.61
	31	188.6	34.49	223.9	42.80	229.9	49.61	233.8	59.23	237.2	59.58	243.7	60.12	250.7	60.35
	33	188.6	36.75	220.0	45.35	226.9	53.20	230.6	58.69	233.8	59.04	240.7	59.57	246.8	59.80
	35	188.6	39.18	216.1	47.49	223.0	57.63	226.9	57.92	230.6	58.27	236.8	58.79	243.7	59.02
	37	188.6	41.78	213.1	49.84	220.0	56.87	223.0	57.16	226.9	57.50	233.1	58.01	240.0	58.24
	39	188.6	44.49	209.3	52.46	216.1	56.11	220.0	56.39	223.0	56.73	229.9	57.24	236.8	57.46
	41	183.8	47.20	200.6	55.09	207.4	55.35	210.5	55.63	214.6	55.96	221.1	56.46	227.1	56.68
	43	179.2	49.78	192.3	54.31	198.9	54.59	202.0	54.86	206.0	55.19	212.3	55.68	218.1	55.90
46	168.0	53.29	175.4	53.18	181.7	53.44	184.6	53.71	188.4	54.03	194.4	54.52	199.7	54.73	
48	148.6	51.80	152.3	51.95	158.0	52.07	160.5	52.21	163.9	52.66	169.2	52.99	173.9	53.20	
120	10	170.6	18.16	202.9	22.27	221.7	26.46	228.5	28.59	235.3	29.04	248.0	29.16	254.1	29.39
	12	170.6	18.65	202.9	23.02	221.7	27.52	228.5	29.20	235.3	30.12	248.0	30.48	254.1	30.73
	14	170.6	19.29	202.9	23.80	221.7	28.63	228.5	30.30	235.3	31.22	248.0	31.68	254.1	31.94
	16	170.6	19.98	202.9	24.77	221.7	29.74	228.5	31.44	235.3	32.67	248.0	33.07	254.1	33.33
	18	170.6	20.77	202.9	25.89	221.7	30.93	228.5	33.09	235.3	34.34	248.0	34.73	254.1	35.01
	20	170.6	21.56	202.9	27.45	221.7	32.59	228.5	34.82	235.3	36.16	248.0	36.64	254.1	36.93
	21	170.6	22.21	202.9	28.44	221.7	33.51	228.5	35.85	235.3	37.35	248.0	37.83	254.1	38.13
	23	170.6	23.74	202.9	30.43	221.7	35.90	228.5	38.09	235.3	39.82	248.0	40.22	254.1	40.55
	25	170.6	25.37	202.9	32.59	221.7	37.87	228.5	40.60	235.3	42.70	245.1	43.06	251.0	43.40
	27	170.6	27.09	202.9	34.85	221.7	40.29	228.5	43.38	235.3	45.89	241.3	46.20	247.3	46.57
	29	170.6	28.89	202.9	37.20	221.7	42.40	228.5	46.43	231.5	48.91	237.5	49.64	244.3	50.04
	31	170.6	30.79	202.9	39.73	221.7	44.60	225.5	49.74	228.5	52.47	234.5	53.39	240.5	53.82
	33	170.6	32.77	202.9	42.34	218.8	47.18	221.7	53.99	224.7	56.33	230.7	56.97	236.8	57.43
	35	170.6	34.85	202.9	45.14	215.0	49.93	218.0	59.48	221.7	59.77	227.8	59.95	233.7	60.43
	37	170.6	37.49	202.9	47.64	211.9	53.24	215.0	58.22	218.0	58.52	224.0	58.69	230.0	59.16
	39	170.6	40.36	202.2	50.35	208.2	56.47	211.2	57.03	214.2	57.31	221.0	57.48	227.0	57.94
	41	166.3	43.22	193.4	53.06	199.9	55.35	202.7	55.83	205.7	56.11	211.6	56.28	217.6	56.73
	43	162.2	46.14	185.3	52.30	191.7	54.11	194.4	54.64	197.3	54.91	203.1	55.07	209.0	55.51
46	152.0	49.61	168.9	51.05	175.1	52.41	177.6	52.84	180.3	53.11	185.8	53.26	191.3	53.69	
48	134.4	48.60	146.7	50.14	152.1	51.39	154.4	51.70	156.8	51.87	161.6	52.07	166.5	52.28	
110	10	152.9	16.33	182.2	19.91	203.6	23.65	209.4	25.60	222.7	27.55	227.8	28.31	243.2	28.78
	12	152.9	16.84	182.2	20.58	203.6	24.63	209.4	26.32	222.7	28.58	227.8	29.50	243.2	30.18
	14	152.9	17.37	182.2	21.50	203.6	25.74	209.4	27.62	222.7	30.02	227.8	30.87	243.2	31.52
	16	152.9	17.99	182.2	22.29	203.6	26.81	209.4	28.83	222.7	31.40	227.8	32.26	243.2	32.83
	18	152.9	18.65	182.2	23.22	203.6	28.35	209.4	30.35	222.7	33.13	227.8	33.78	243.2	34.41
	20	152.9	19.32	182.2	24.38	203.6	30.06	209.4	31.75	222.7	34.73	227.8	35.59	243.2	36.16
	21	152.9	19.75	182.2	25.10	203.6	30.84	209.4	32.60	222.7	35.70	227.8	36.60	243.2	37.17
	23	152.9	21.04	182.2	26.90	203.6	32.56	209.4	34.42	222.7	37.72	227.8	38.53	243.2	39.16
	25	152.9	22.48	182.2	28.71	203.6	34.40	209.4	36.39	222.7	39.85	227.8	40.42	240.3	41.25
	27	152.9	24.02	182.2	30.70	203.6	36.35	209.4	38.51	222.7	41.62	227.8	42.57	236.7	43.29
	29	152.9	25.64	182.2	32.77	203.6	38.41	209.4	40.79	222.7	43.98	227.8	44.74	233.7	45.42
	31	152.9	27.27	182.2	34.94	203.6	40.59	209.4	43.21	219.0	46.21	224.8	47.12	230.0	47.61
	33	152.9	29.07	182.2	37.20	203.6	42.88	209.4	45.79	216.0	48.80	221.2	49.61	227.0	49.89
	35	152.9	30.88	182.2	39.73	203.6	45.29	209.4	48.52	212.4	51.51	217.5	51.98	223.4	52.24
	37	152.9	32.72	182.2	42.16	203.6	47.81	206.5	51.41	208.7	54.32	214.6	54.51	219.7	54.66
	39	152.9	35.28	182.2	44.80	199.9	50.45	202.8	54.99	205.8	57.02	210.9	57.11	216.8	57.17
	41	149.0	37.84	177.6	47.44	191.3	53.20	194.3	59.48	196.8	59.48	202.6	59.95	207.6	60.43
	43	145.3	39.73	173.2	49.43	183.4	56.42	186.4	57.05	188.8	56.93	194.4	57.25	199.3	57.41
46	136.1	38.78	162.3	47.72	167.3	53.54	170.2	53.54	172.4	54.00	177.7	54.30	182.3	54.45	
48	120.4	37.66	141.1	45.97	145.3	50.94	148.0	51.28	149.9	51.53	154.5	51.67	158.6	51.88	

# 7. Capacity Tables

Cooling Capacity (68HP)

Combination (%)	Outdoor air temp. (DB, °C)	Indoor air temp. (DB/WB, °C)													
		20		23		26		27		28		30		32	
		14		16		18		19		20		22		24	
		TC	PI	TC	PI	TC	PI	TC	PI	TC	PI	TC	PI	TC	PI
100	10	128.5	14.71	153.0	17.88	178.2	21.21	190.4	22.91	202.6	24.62	224.7	27.41	229.6	27.63
	12	128.5	15.18	153.0	18.61	178.2	21.92	190.4	23.53	202.6	25.41	224.7	28.88	229.6	29.17
	14	128.5	15.65	153.0	19.35	178.2	22.85	190.4	24.55	202.6	26.50	224.7	30.50	229.6	30.78
	16	128.5	16.13	153.0	19.99	178.2	23.82	190.4	25.72	202.6	27.93	224.7	31.97	229.6	32.42
	18	128.5	16.61	153.0	20.73	178.2	24.75	190.4	26.97	202.6	29.61	224.7	33.78	229.6	34.05
	20	128.5	17.20	153.0	21.52	178.2	26.18	190.4	28.89	202.6	31.69	224.7	35.39	229.6	35.68
	21	128.5	17.56	153.0	22.03	178.2	27.09	190.4	29.88	202.6	32.86	224.7	36.20	229.6	36.49
	23	128.5	18.60	153.0	23.56	178.2	29.07	190.4	32.05	202.6	35.21	224.7	37.91	229.6	38.21
	25	128.5	19.77	153.0	25.10	178.2	31.06	190.4	34.31	202.6	37.65	224.7	39.53	227.7	39.84
	27	128.5	21.13	153.0	26.81	178.2	33.22	190.4	36.66	202.6	40.03	220.3	41.39	224.9	41.72
	29	128.5	22.48	153.0	28.62	178.2	35.48	190.4	39.18	202.6	42.37	216.2	43.05	221.5	43.40
	31	128.5	24.02	153.0	30.52	178.2	37.83	190.4	41.80	202.6	44.52	213.0	44.72	218.1	45.08
	33	128.5	25.46	153.0	32.50	178.2	40.36	190.4	44.60	202.6	46.19	209.5	46.39	214.7	46.76
	35	128.5	27.09	153.0	34.58	178.2	42.98	190.4	47.58	199.5	47.87	205.7	48.05	211.0	48.44
	37	128.5	29.01	153.0	37.09	178.2	45.52	190.4	49.85	196.3	50.09	201.9	50.29	206.7	50.76
	39	128.5	31.10	153.0	39.84	178.2	48.24	190.4	52.28	193.0	52.51	198.7	52.71	203.3	53.20
	41	126.5	33.19	150.6	42.59	175.3	50.96	182.7	54.72	186.7	54.94	191.1	55.13	197.3	55.64
	43	122.1	35.13	145.4	45.15	169.3	53.39	175.2	56.81	177.2	57.01	182.7	57.20	187.4	57.74
46	114.5	37.78	136.3	48.68	158.7	56.63	159.9	59.48	161.7	59.65	166.9	59.82	171.3	60.39	
48	101.3	32.62	120.5	42.12	137.0	48.41	139.0	50.46	140.4	50.63	145.1	50.74	149.0	51.15	
90	10	115.6	13.65	138.0	16.42	160.5	19.35	171.4	20.85	182.2	22.45	204.7	25.12	227.1	27.63
	12	115.6	13.82	138.0	16.67	160.5	19.68	171.4	21.27	182.2	22.95	204.7	25.62	227.1	28.43
	14	115.6	14.07	138.0	17.00	160.5	20.10	171.4	21.69	182.2	23.37	204.7	26.12	227.1	29.01
	16	115.6	14.32	138.0	17.34	160.5	20.52	171.4	22.11	182.2	23.79	204.7	26.62	227.1	29.50
	18	115.6	14.57	138.0	17.67	160.5	20.85	171.4	22.61	182.2	24.29	204.7	27.20	227.1	30.99
	20	115.6	14.82	138.0	18.01	160.5	21.27	171.4	23.03	182.2	25.21	204.7	29.10	227.1	32.47
	21	115.6	14.99	138.0	18.17	160.5	21.69	171.4	23.79	182.2	26.13	204.7	29.58	227.1	33.21
	23	115.6	15.33	138.0	18.93	160.5	23.20	171.4	25.54	182.2	27.97	204.7	31.37	224.0	34.78
	25	115.6	16.08	138.0	20.18	160.5	24.79	171.4	27.30	182.2	29.90	204.7	33.54	220.8	36.26
	27	115.6	17.17	138.0	21.52	160.5	26.47	171.4	29.15	182.2	31.99	204.7	35.66	217.5	37.97
	29	115.6	18.17	138.0	22.95	160.5	28.31	171.4	31.16	182.2	34.17	204.7	37.77	214.3	39.50
	31	115.6	19.35	138.0	24.46	160.5	30.15	171.4	33.17	182.2	36.43	204.7	39.65	211.1	41.03
	33	115.6	20.60	138.0	26.05	160.5	32.16	171.4	35.34	182.2	38.64	204.7	41.57	207.8	42.56
	35	115.6	21.86	138.0	27.64	160.5	34.17	171.4	37.69	182.2	40.98	201.2	43.96	204.6	44.97
	37	115.6	23.20	138.0	29.40	160.5	36.43	171.4	40.04	182.2	43.25	197.9	45.95	201.3	46.98
	39	115.6	24.56	138.0	31.27	160.5	38.56	171.4	42.60	182.2	45.48	194.7	48.44	198.1	49.03
	41	112.6	27.48	134.5	34.66	156.4	42.32	167.0	46.59	177.6	49.11	186.5	51.05	189.9	52.23
	43	109.9	29.67	131.2	37.46	152.5	46.23	162.8	50.18	173.2	52.65	178.9	54.63	182.1	55.33
46	103.0	33.39	122.9	42.66	142.9	52.67	152.6	56.89	157.4	58.50	163.3	59.68	166.3	59.89	
48	91.1	29.18	108.8	37.31	126.4	46.09	135.0	49.62	136.7	50.23	141.9	50.74	144.6	51.15	
80	10	102.7	12.73	122.4	15.30	142.1	17.95	152.3	19.37	162.5	20.78	182.2	23.70	202.0	25.73
	12	102.7	13.00	122.4	15.48	142.1	18.31	152.3	19.72	162.5	21.14	182.2	24.14	202.0	26.24
	14	102.7	13.18	122.4	15.83	142.1	18.57	152.3	20.07	162.5	21.49	182.2	24.58	202.0	26.75
	16	102.7	13.35	122.4	16.10	142.1	18.93	152.3	20.43	162.5	21.93	182.2	25.12	202.0	27.26
	18	102.7	13.62	122.4	16.36	142.1	19.28	152.3	20.78	162.5	22.37	182.2	25.56	202.0	27.86
	20	102.7	13.88	122.4	16.71	142.1	19.72	152.3	21.22	162.5	22.82	182.2	26.53	202.0	29.51
	21	102.7	13.97	122.4	16.89	142.1	19.90	152.3	21.49	162.5	23.35	182.2	27.37	202.0	30.29
	23	102.7	14.24	122.4	17.16	142.1	20.78	152.3	22.82	162.5	24.94	182.2	28.89	202.0	31.80
	25	102.7	14.77	122.4	18.31	142.1	22.29	152.3	24.41	162.5	26.71	182.2	30.92	202.0	34.00
	27	102.7	15.65	122.4	19.46	142.1	23.79	152.3	26.09	162.5	28.48	182.2	32.86	202.0	35.77
	29	102.7	16.63	122.4	20.78	142.1	25.29	152.3	27.77	162.5	30.42	182.2	35.21	202.0	37.52
	31	102.7	17.69	122.4	22.02	142.1	26.97	152.3	29.63	162.5	32.37	182.2	37.36	202.0	39.39
	33	102.7	18.75	122.4	23.52	142.1	28.74	152.3	31.57	162.5	34.49	182.2	39.37	202.0	41.28
	35	102.7	19.90	122.4	24.94	142.1	30.60	152.3	33.61	162.5	36.79	182.2	41.74	199.8	43.62
	37	102.7	21.05	122.4	26.51	142.1	32.46	152.3	35.73	162.5	39.09	182.2	44.05	196.6	45.67
	39	102.7	22.24	122.4	28.03	142.1	34.72	152.3	38.41	162.5	42.01	182.2	46.54	193.4	48.17
	41	100.1	24.61	119.3	31.06	138.5	38.10	148.4	42.10	158.4	46.16	177.6	50.03	185.2	51.18
	43	97.6	27.09	116.3	33.90	135.1	41.59	144.8	45.88	154.4	50.44	173.2	53.54	177.6	54.78
46	91.4	30.14	109.0	38.18	126.6	46.86	135.7	51.07	144.7	56.92	158.4	59.68	162.1	59.89	
48	80.9	26.32	96.4	33.39	112.0	40.99	120.0	44.61	128.0	49.76	137.6	50.74	140.9	51.15	



# 7. Capacity Tables

Cooling Capacity (68HP)

Combination (%)	Outdoor air temp. (DB, °C)	Indoor air temp. (DB/WB, °C)													
		20		23		26		27		28		30		32	
		14		16		18		19		20		22		24	
		TC	PI	TC	PI	TC	PI	TC	PI	TC	PI	TC	PI	TC	PI
70	10	89.8	11.27	107.4	13.40	124.4	15.52	133.3	16.77	142.1	17.92	159.1	20.40	176.8	22.82
	12	89.8	11.44	107.4	13.57	124.4	15.88	133.3	17.03	142.1	18.27	159.1	20.76	176.8	23.25
	14	89.8	11.62	107.4	13.75	124.4	16.15	133.3	17.30	142.1	18.54	159.1	21.20	176.8	23.68
	16	89.8	11.80	107.4	14.02	124.4	16.41	133.3	17.65	142.1	18.90	159.1	21.56	176.8	24.19
	18	89.8	11.98	107.4	14.28	124.4	16.77	133.3	18.01	142.1	19.25	159.1	21.91	176.8	24.61
	20	89.8	12.15	107.4	14.55	124.4	17.03	133.3	18.36	142.1	19.69	159.1	22.44	176.8	25.55
	21	89.8	12.33	107.4	14.64	124.4	17.21	133.3	18.54	142.1	19.87	159.1	22.80	176.8	26.09
	23	89.8	12.51	107.4	14.99	124.4	17.56	133.3	19.16	142.1	20.85	159.1	24.40	176.8	27.55
	25	89.8	12.69	107.4	15.52	124.4	18.72	133.3	20.49	142.1	22.27	159.1	26.08	176.8	28.89
	27	89.8	13.40	107.4	16.59	124.4	19.96	133.3	21.73	142.1	23.77	159.1	27.86	176.8	30.69
	29	89.8	14.28	107.4	17.56	124.4	21.20	133.3	23.15	142.1	25.28	159.1	29.72	176.8	32.89
	31	89.8	15.17	107.4	18.72	124.4	22.62	133.3	24.75	142.1	26.97	159.1	31.67	176.8	34.90
	33	89.8	16.06	107.4	19.78	124.4	24.04	133.3	26.26	142.1	28.65	159.1	33.71	176.8	37.15
	35	89.8	16.94	107.4	21.12	124.4	25.55	133.3	27.94	142.1	30.52	159.1	35.93	176.8	39.39
	37	89.8	18.01	107.4	22.37	124.4	27.15	133.3	29.72	142.1	32.47	159.1	38.23	176.8	41.57
	39	89.8	19.12	107.4	23.85	124.4	29.03	133.3	31.97	142.1	35.07	159.1	40.92	176.8	44.82
	41	87.5	21.14	104.7	26.12	121.3	31.84	129.9	35.07	138.5	38.13	155.0	44.94	172.3	48.35
	43	85.3	23.01	102.1	28.47	118.3	34.74	126.7	38.24	135.1	41.64	151.2	49.10	168.0	52.28
46	79.9	25.57	95.7	32.01	110.8	39.12	118.7	42.60	126.6	46.94	141.7	55.38	157.5	58.27	
48	70.7	22.32	84.6	27.96	98.0	34.20	105.0	37.22	112.0	41.06	125.4	48.46	139.3	50.30	
60	10	76.8	9.79	91.8	11.48	106.8	13.35	114.2	14.33	121.7	15.22	136.7	17.26	151.6	19.31
	12	76.8	9.97	91.8	11.66	106.8	13.53	114.2	14.51	121.7	15.48	136.7	17.53	151.6	19.67
	14	76.8	10.06	91.8	11.84	106.8	13.79	114.2	14.77	121.7	15.75	136.7	17.89	151.6	20.02
	16	76.8	10.23	91.8	12.10	106.8	13.97	114.2	15.04	121.7	16.11	136.7	18.24	151.6	20.38
	18	76.8	10.41	91.8	12.28	106.8	14.24	114.2	15.31	121.7	16.37	136.7	18.51	151.6	20.82
	20	76.8	10.59	91.8	12.46	106.8	14.51	114.2	15.57	121.7	16.64	136.7	18.87	151.6	21.27
	21	76.8	10.68	91.8	12.55	106.8	14.68	114.2	15.75	121.7	16.82	136.7	19.13	151.6	21.45
	23	76.8	10.86	91.8	12.81	106.8	14.86	114.2	16.02	121.7	17.17	136.7	19.84	151.6	22.78
	25	76.8	11.03	91.8	13.08	106.8	15.48	114.2	16.82	121.7	18.24	136.7	21.18	151.6	24.38
	27	76.8	11.39	91.8	13.79	106.8	16.46	114.2	17.89	121.7	19.40	136.7	22.51	151.6	25.98
	29	76.8	12.10	91.8	14.68	106.8	17.53	114.2	19.04	121.7	20.65	136.7	24.03	151.6	27.76
	31	76.8	12.81	91.8	15.57	106.8	18.60	114.2	20.29	121.7	21.98	136.7	25.63	151.6	29.54
	33	76.8	13.53	91.8	16.46	106.8	19.76	114.2	21.54	121.7	23.40	136.7	27.23	151.6	31.50
	35	76.8	14.33	91.8	17.53	106.8	21.00	114.2	22.87	121.7	24.83	136.7	29.01	151.6	33.46
	37	76.8	15.13	91.8	18.50	106.8	22.25	114.2	24.29	121.7	26.34	136.7	30.79	151.6	35.60
	39	76.8	16.09	91.8	19.70	106.8	24.01	114.2	26.06	121.7	28.35	136.7	33.01	151.6	38.14
	41	74.9	17.45	89.5	21.56	104.0	26.08	111.3	28.47	118.6	30.77	133.2	36.23	147.8	41.45
	43	73.0	18.96	87.2	23.47	101.5	28.43	108.6	31.03	115.7	33.55	129.9	39.55	144.1	45.28
46	68.4	21.24	81.8	26.35	95.1	31.97	101.7	34.88	108.4	37.76	121.7	44.56	135.0	51.58	
48	60.5	18.50	72.3	23.00	84.1	27.93	90.0	30.46	95.9	32.99	107.7	38.98	119.5	45.13	
50	10	64.3	8.48	76.8	9.82	89.1	11.16	95.2	11.96	101.3	12.68	113.6	14.28	126.5	15.89
	12	64.3	8.57	76.8	9.91	89.1	11.34	95.2	12.14	101.3	12.94	113.6	14.55	126.5	16.16
	14	64.3	8.66	76.8	10.09	89.1	11.52	95.2	12.32	101.3	13.12	113.6	14.73	126.5	16.42
	16	64.3	8.84	76.8	10.27	89.1	11.69	95.2	12.59	101.3	13.30	113.6	15.00	126.5	16.69
	18	64.3	8.93	76.8	10.35	89.1	11.87	95.2	12.76	101.3	13.57	113.6	15.26	126.5	17.05
	20	64.3	9.02	76.8	10.53	89.1	12.14	95.2	12.94	101.3	13.84	113.6	15.53	126.5	17.41
	21	64.3	9.11	76.8	10.62	89.1	12.23	95.2	13.12	101.3	13.93	113.6	15.71	126.5	17.59
	23	64.3	9.28	76.8	10.80	89.1	12.41	95.2	13.30	101.3	14.19	113.6	15.98	126.5	17.94
	25	64.3	9.37	76.8	10.98	89.1	12.68	95.2	13.57	101.3	14.64	113.6	16.78	126.5	19.19
	27	64.3	9.55	76.8	11.34	89.1	13.39	95.2	14.46	101.3	15.53	113.6	17.94	126.5	20.44
	29	64.3	10.09	76.8	12.05	89.1	14.19	95.2	15.35	101.3	16.51	113.6	19.01	126.5	21.69
	31	64.3	10.62	76.8	12.76	89.1	15.09	95.2	16.25	101.3	17.59	113.6	20.26	126.5	23.12
	33	64.3	11.25	76.8	13.48	89.1	15.98	95.2	17.23	101.3	18.66	113.6	21.51	126.5	24.64
	35	64.3	11.87	76.8	14.28	89.1	16.87	95.2	18.30	101.3	19.73	113.6	22.76	126.5	26.15
	37	64.3	12.59	76.8	15.09	89.1	17.85	95.2	19.37	101.3	20.89	113.6	24.28	126.5	27.76
	39	64.3	13.43	76.8	16.17	89.1	19.13	95.2	20.85	101.3	22.41	113.6	25.86	126.5	29.98
	41	62.6	14.52	74.9	17.50	86.8	20.92	92.8	22.58	98.7	24.28	110.7	28.35	123.2	32.56
	43	61.1	15.78	73.0	19.04	84.7	22.76	90.5	24.59	96.3	26.44	107.9	30.91	120.2	35.52
46	57.2	17.67	68.4	21.36	79.3	25.53	84.8	27.61	90.2	29.68	101.1	34.78	112.6	39.99	
48	50.6	15.40	60.5	18.62	70.2	22.27	75.0	24.10	79.8	25.90	89.5	30.39	99.6	34.96	

**Note**

1. TC: Total Capacity(kW), PI : Power Input(kW, Comp. + Outdoor fan motor)
2. Capacity tables show the average value of conditions which may occur.

# 7. Capacity Tables

◆ ARUM700LTE5

Cooling Capacity (70HP)

Combination (%)	Outdoor air temp. (DB, °C)	Indoor air temp. (DB/WB, °C)													
		20		23		26		27		28		30		32	
		14	16	16	18	18	19	19	20	20	22	22	24	24	
130	10	194.1	21.52	231.2	26.31	247.8	30.52	254.9	31.14	262.0	31.39	274.6	31.63	281.7	31.76
	12	194.1	22.06	231.2	27.24	247.8	31.77	254.9	31.98	262.0	32.23	274.6	32.49	281.7	32.78
	14	194.1	22.80	231.2	28.23	247.8	32.97	254.9	33.21	262.0	33.47	274.6	33.74	281.7	34.04
	16	194.1	23.63	231.2	29.22	247.8	34.44	254.9	34.76	262.0	35.04	274.6	35.35	281.7	35.63
	18	194.1	24.62	231.2	30.91	247.8	36.03	254.9	36.80	262.0	37.09	274.6	37.46	281.7	37.72
	20	194.1	25.71	231.2	32.93	247.8	37.80	254.9	40.48	262.0	40.81	270.6	41.21	277.7	41.49
	21	194.1	26.38	231.2	34.08	247.8	38.59	254.9	42.84	262.0	43.18	269.1	43.61	276.2	43.91
	23	194.1	28.31	231.2	35.85	247.8	40.60	254.9	47.27	258.7	47.65	265.1	48.12	272.2	48.45
	25	194.1	30.23	231.2	37.92	247.8	43.38	251.9	52.42	254.9	52.84	262.0	53.37	269.1	53.73
	27	194.1	32.35	231.2	40.53	244.7	46.22	247.8	57.71	251.9	58.17	258.7	58.75	265.1	59.15
	29	194.1	34.47	231.2	43.33	240.7	49.74	244.2	63.43	247.8	63.81	254.9	64.38	262.0	64.63
	31	194.1	36.78	230.4	45.64	236.7	52.90	240.7	63.16	244.2	63.54	250.9	64.11	258.0	64.36
	33	194.1	39.19	226.5	48.36	233.6	56.74	237.4	62.58	240.7	62.96	247.8	63.52	254.0	63.77
	35	194.1	41.79	222.5	50.65	229.6	61.46	233.6	61.77	237.4	62.14	243.8	62.69	250.9	62.94
	37	194.1	44.56	219.3	53.15	226.5	60.65	229.6	60.95	233.6	61.32	239.9	61.87	247.0	62.11
	39	194.1	47.45	215.5	55.95	222.5	59.83	226.5	60.14	229.6	60.50	236.7	61.04	243.8	61.28
41	189.2	50.34	206.5	58.75	213.5	59.02	216.7	59.32	220.9	59.68	227.6	60.21	233.7	60.45	
43	184.5	53.09	197.9	57.92	204.8	58.21	207.9	58.50	212.1	58.85	218.6	59.38	224.5	59.62	
46	172.9	56.82	180.5	56.71	187.1	56.99	190.0	57.28	194.0	57.62	200.1	58.14	205.6	58.37	
48	152.9	55.24	156.8	55.40	162.6	55.52	165.2	55.67	168.8	56.15	174.2	56.51	179.0	56.73	
120	10	175.7	19.36	208.9	23.74	228.3	28.21	235.2	30.49	242.2	30.97	255.3	31.10	261.6	31.35
	12	175.7	19.89	208.9	24.54	228.3	29.35	235.2	31.14	242.2	32.12	255.3	32.51	261.6	32.77
	14	175.7	20.57	208.9	25.38	228.3	30.53	235.2	32.32	242.2	33.30	255.3	33.79	261.6	34.06
	16	175.7	21.31	208.9	26.41	228.3	31.72	235.2	33.52	242.2	34.84	255.3	35.26	261.6	35.55
	18	175.7	22.15	208.9	27.61	228.3	32.98	235.2	35.29	242.2	36.62	255.3	37.04	261.6	37.34
	20	175.7	22.99	208.9	29.27	228.3	34.76	235.2	37.14	242.2	38.56	255.3	39.07	261.6	39.38
	21	175.7	23.69	208.9	30.33	228.3	35.73	235.2	38.23	242.2	39.83	255.3	40.34	261.6	40.66
	23	175.7	25.32	208.9	32.45	228.3	38.29	235.2	40.62	242.2	42.46	255.3	42.90	261.6	43.24
	25	175.7	27.05	208.9	34.76	228.3	40.38	235.2	43.30	242.2	45.54	252.3	45.92	258.4	46.29
	27	175.7	28.88	208.9	37.16	228.3	42.97	235.2	46.26	242.2	48.94	248.4	49.27	254.6	49.66
	29	175.7	30.81	208.9	39.67	228.3	45.22	235.2	49.51	238.3	52.16	244.5	52.94	251.4	53.37
	31	175.7	32.83	208.9	42.36	228.3	47.56	232.2	53.04	235.2	55.95	241.4	56.94	247.5	57.40
	33	175.7	34.95	208.9	45.16	225.2	50.31	228.3	57.57	231.3	60.07	237.5	60.76	243.7	61.24
	35	175.7	37.16	208.9	48.14	221.3	53.25	224.4	63.43	228.3	63.74	234.5	63.93	240.6	64.44
	37	175.7	39.98	208.9	50.80	218.1	56.77	221.3	62.09	224.4	62.40	230.6	62.59	236.8	63.09
	39	175.7	43.04	208.1	53.69	214.3	60.22	217.4	60.82	220.5	61.12	227.5	61.30	233.6	61.79
41	171.2	46.10	199.1	56.58	205.8	59.03	208.7	59.54	211.7	59.84	217.8	60.02	224.0	60.49	
43	166.9	49.20	190.7	55.77	197.3	57.70	200.2	58.26	203.1	58.56	209.1	58.73	215.1	59.20	
46	156.4	52.90	173.9	54.44	180.2	55.89	182.9	56.35	185.6	56.63	191.2	56.80	196.9	57.25	
48	138.4	51.82	151.0	53.47	156.6	54.80	159.0	55.13	161.4	55.31	166.4	55.53	171.4	55.75	
110	10	157.4	17.42	187.6	21.23	209.6	25.22	215.6	27.30	229.2	29.38	234.5	30.19	250.4	30.69
	12	157.4	17.96	187.6	21.94	209.6	26.26	215.6	28.06	229.2	30.48	234.5	31.46	250.4	32.19
	14	157.4	18.52	187.6	22.93	209.6	27.45	215.6	29.45	229.2	32.01	234.5	32.92	250.4	33.62
	16	157.4	19.18	187.6	23.77	209.6	28.59	215.6	30.74	229.2	33.49	234.5	34.40	250.4	35.01
	18	157.4	19.89	187.6	24.76	209.6	30.23	215.6	32.37	229.2	35.33	234.5	36.03	250.4	36.70
	20	157.4	20.60	187.6	26.00	209.6	32.06	215.6	33.86	229.2	37.04	234.5	37.95	250.4	38.56
	21	157.4	21.06	187.6	26.77	209.6	32.88	215.6	34.77	229.2	38.07	234.5	39.03	250.4	39.64
	23	157.4	22.43	187.6	28.69	209.6	34.72	215.6	36.71	229.2	40.22	234.5	41.08	250.4	41.76
	25	157.4	23.97	187.6	30.62	209.6	36.68	215.6	38.81	229.2	42.49	234.5	43.10	247.3	43.99
	27	157.4	25.61	187.6	32.74	209.6	38.76	215.6	41.07	229.2	44.38	234.5	45.40	243.7	46.17
	29	157.4	27.34	187.6	34.95	209.6	40.96	215.6	43.49	229.2	46.90	234.5	47.71	240.6	48.43
	31	157.4	29.08	187.6	37.26	209.6	43.29	215.6	46.08	225.5	49.28	231.5	50.25	236.8	50.78
	33	157.4	31.00	187.6	39.67	209.6	45.73	215.6	48.83	222.4	52.04	227.7	52.91	233.7	53.20
	35	157.4	32.93	187.6	42.36	209.6	48.30	215.6	51.74	218.7	54.93	223.9	55.43	230.0	55.71
	37	157.4	34.90	187.6	44.96	209.6	50.99	212.6	54.82	214.8	57.93	220.9	58.13	226.2	58.30
	39	157.4	37.62	187.6	47.78	205.8	53.80	208.8	58.64	211.8	60.80	217.1	60.90	223.2	60.96
41	153.3	40.35	182.8	50.60	196.9	56.73	200.0	63.43	202.6	63.43	208.6	63.93	213.7	64.44	
43	149.5	42.37	178.3	52.71	188.7	60.16	191.8	60.84	194.3	60.71	200.1	61.05	205.2	61.22	
46	140.1	41.36	167.1	50.89	172.2	57.10	175.2	57.10	177.5	57.59	182.9	57.91	187.7	58.06	
48	124.0	40.16	145.2	49.02	149.6	54.32	152.3	54.69	154.3	54.95	159.1	55.11	163.3	55.33	

# 7. Capacity Tables

Cooling Capacity (70HP)

Combination (%)	Outdoor air temp. (DB, °C)	Indoor air temp. (DB/WB, °C)													
		20		23		26		27		28		30		32	
		14		16		18		19		20		22		24	
		TC	PI	TC	PI	TC	PI	TC	PI	TC	PI	TC	PI	TC	PI
100	10	132.3	15.68	157.5	19.06	183.4	22.62	196.0	24.44	208.6	26.26	231.3	29.23	236.4	29.46
	12	132.3	16.19	157.5	19.84	183.4	23.38	196.0	25.10	208.6	27.10	231.3	30.80	236.4	31.10
	14	132.3	16.69	157.5	20.63	183.4	24.37	196.0	26.18	208.6	28.26	231.3	32.52	236.4	32.83
	16	132.3	17.20	157.5	21.32	183.4	25.41	196.0	27.42	208.6	29.78	231.3	34.09	236.4	34.57
	18	132.3	17.71	157.5	22.11	183.4	26.39	196.0	28.76	208.6	31.58	231.3	36.02	236.4	36.31
	20	132.3	18.34	157.5	22.94	183.4	27.92	196.0	30.81	208.6	33.79	231.3	37.74	236.4	38.05
	21	132.3	18.72	157.5	23.49	183.4	28.88	196.0	31.87	208.6	35.05	231.3	38.61	236.4	38.92
	23	132.3	19.83	157.5	25.13	183.4	31.00	196.0	34.18	208.6	37.55	231.3	40.43	236.4	40.75
	25	132.3	21.09	157.5	26.77	183.4	33.12	196.0	36.59	208.6	40.15	231.3	42.15	234.4	42.49
	27	132.3	22.53	157.5	28.60	183.4	35.43	196.0	39.09	208.6	42.69	226.8	44.14	231.6	44.49
	29	132.3	23.97	157.5	30.52	183.4	37.84	196.0	41.79	208.6	45.18	222.6	45.91	228.1	46.28
	31	132.3	25.61	157.5	32.54	183.4	40.34	196.0	44.58	208.6	47.47	219.2	47.69	224.6	48.07
	33	132.3	27.15	157.5	34.66	183.4	43.04	196.0	47.56	208.6	49.26	215.7	49.47	221.1	49.86
	35	132.3	28.88	157.5	36.88	183.4	45.83	196.0	50.74	205.4	51.04	211.8	51.24	217.2	51.65
	37	132.3	30.93	157.5	39.55	183.4	48.55	196.0	53.16	202.0	53.42	207.9	53.63	212.8	54.13
	39	132.3	33.16	157.5	42.49	183.4	51.44	196.0	55.75	198.7	56.00	204.5	56.21	209.3	56.73
	41	130.2	35.40	155.0	45.42	180.5	54.34	188.1	58.35	192.2	58.58	196.7	58.79	203.1	59.34
	43	125.7	37.46	149.7	48.15	174.3	56.94	180.3	60.58	182.4	60.80	188.0	61.00	192.9	61.57
46	117.8	40.29	140.3	51.91	163.3	60.39	164.6	63.43	166.4	63.61	171.8	63.80	176.4	64.40	
48	104.2	34.79	124.1	44.91	141.0	51.63	143.1	53.82	144.6	53.99	149.3	54.11	153.4	54.54	
90	10	119.0	14.46	142.1	17.39	165.2	20.50	176.4	22.10	187.6	23.78	210.7	26.62	233.8	29.46
	12	119.0	14.64	142.1	17.66	165.2	20.85	176.4	22.54	187.6	24.31	210.7	27.15	233.8	30.13
	14	119.0	14.91	142.1	18.01	165.2	21.30	176.4	22.98	187.6	24.76	210.7	27.67	233.8	30.74
	16	119.0	15.17	142.1	18.37	165.2	21.74	176.4	23.43	187.6	25.20	210.7	28.20	233.8	31.26
	18	119.0	15.44	142.1	18.72	165.2	22.10	176.4	23.96	187.6	25.73	210.7	28.81	233.8	32.83
	20	119.0	15.71	142.1	19.08	165.2	22.54	176.4	24.40	187.6	26.71	210.7	30.84	233.8	34.40
	21	119.0	15.88	142.1	19.26	165.2	22.98	176.4	25.20	187.6	27.69	210.7	31.34	233.8	35.19
	23	119.0	16.24	142.1	20.05	165.2	24.58	176.4	27.06	187.6	29.64	210.7	33.23	230.6	36.85
	25	119.0	17.04	142.1	21.39	165.2	26.27	176.4	28.93	187.6	31.68	210.7	35.53	227.3	38.42
	27	119.0	18.19	142.1	22.81	165.2	28.04	176.4	30.88	187.6	33.90	210.7	37.78	223.9	40.23
	29	119.0	19.26	142.1	24.31	165.2	29.99	176.4	33.01	187.6	36.20	210.7	40.02	220.6	41.85
	31	119.0	20.50	142.1	25.91	165.2	31.95	176.4	35.14	187.6	38.60	210.7	42.02	217.3	43.47
	33	119.0	21.83	142.1	27.60	165.2	34.08	176.4	37.45	187.6	40.94	210.7	44.05	213.9	45.09
	35	119.0	23.16	142.1	29.28	165.2	36.20	176.4	39.93	187.6	43.42	207.1	46.57	210.6	47.64
	37	119.0	24.58	142.1	31.15	165.2	38.60	176.4	42.42	187.6	45.83	203.7	48.69	207.3	49.78
	39	119.0	26.02	142.1	33.13	165.2	40.86	176.4	45.14	187.6	48.19	200.4	51.33	203.9	51.95
	41	116.0	29.12	138.5	36.73	161.0	44.84	171.9	49.37	182.8	52.03	192.0	54.09	195.5	55.33
	43	113.1	31.43	135.0	39.69	157.0	48.98	167.6	53.17	178.3	55.79	184.1	57.93	187.5	58.63
46	106.0	35.38	126.6	45.20	147.1	55.81	157.1	60.28	162.0	61.98	168.1	63.58	171.2	63.68	
48	93.8	30.92	112.0	39.54	130.1	48.83	139.0	52.58	140.7	53.41	146.1	54.11	148.9	54.54	
80	10	105.7	13.48	126.0	16.19	146.3	19.00	156.8	20.50	167.3	22.00	187.6	25.08	207.9	27.23
	12	105.7	13.76	126.0	16.38	146.3	19.37	156.8	20.87	167.3	22.37	187.6	25.55	207.9	27.77
	14	105.7	13.95	126.0	16.75	146.3	19.66	156.8	21.25	167.3	22.74	187.6	26.02	207.9	28.31
	16	105.7	14.13	126.0	17.03	146.3	20.03	156.8	21.62	167.3	23.21	187.6	26.58	207.9	28.85
	18	105.7	14.41	126.0	17.32	146.3	20.40	156.8	22.00	167.3	23.68	187.6	27.05	207.9	29.48
	20	105.7	14.70	126.0	17.69	146.3	20.87	156.8	22.46	167.3	24.15	187.6	28.08	207.9	31.23
	21	105.7	14.79	126.0	17.88	146.3	21.06	156.8	22.74	167.3	24.71	187.6	28.97	207.9	32.06
	23	105.7	15.07	126.0	18.16	146.3	22.00	156.8	24.15	167.3	26.39	187.6	30.58	207.9	33.65
	25	105.7	15.63	126.0	19.37	146.3	23.59	156.8	25.83	167.3	28.27	187.6	32.73	207.9	35.98
	27	105.7	16.57	126.0	20.59	146.3	25.18	156.8	27.61	167.3	30.14	187.6	34.78	207.9	37.86
	29	105.7	17.60	126.0	22.00	146.3	26.77	156.8	29.39	167.3	32.20	187.6	37.26	207.9	39.76
	31	105.7	18.72	126.0	23.31	146.3	28.55	156.8	31.36	167.3	34.26	187.6	39.54	207.9	41.73
	33	105.7	19.84	126.0	24.90	146.3	30.42	156.8	33.41	167.3	36.50	187.6	41.66	207.9	43.74
	35	105.7	21.06	126.0	26.39	146.3	32.39	156.8	35.57	167.3	38.94	187.6	44.18	205.7	46.21
	37	105.7	22.28	126.0	28.06	146.3	34.35	156.8	37.81	167.3	41.37	187.6	46.62	202.4	48.33
	39	105.7	23.54	126.0	29.67	146.3	36.75	156.8	40.65	167.3	44.46	187.6	49.26	199.0	50.99
	41	103.0	26.04	122.8	32.88	142.6	40.33	152.8	44.56	163.0	48.85	182.8	53.01	190.7	54.23
	43	100.4	28.67	119.7	35.88	139.0	44.02	149.0	48.56	159.0	53.39	178.3	56.77	182.8	58.04
46	94.1	31.90	112.2	40.41	130.3	49.60	139.6	54.05	149.0	60.24	163.0	63.58	166.9	63.68	
48	83.3	27.86	99.3	35.34	115.3	43.38	123.5	47.21	131.8	52.73	141.6	54.11	145.0	54.54	

# 7. Capacity Tables

Cooling Capacity (70HP)

Combination (%)	Outdoor air temp. (DB, °C)	Indoor air temp. (DB/WB, °C)													
		20		23		26		27		28		30		32	
		14	16	18	19	20	22	24	TC	PI	TC	PI	TC	PI	
70	10	92.4	11.91	110.6	14.16	128.1	16.41	137.2	17.73	146.3	18.95	163.8	21.57	182.0	24.13
	12	92.4	12.10	110.6	14.35	128.1	16.79	137.2	18.01	146.3	19.32	163.8	21.95	182.0	24.58
	14	92.4	12.29	110.6	14.54	128.1	17.07	137.2	18.29	146.3	19.60	163.8	22.42	182.0	25.03
	16	92.4	12.47	110.6	14.82	128.1	17.35	137.2	18.66	146.3	19.98	163.8	22.79	182.0	25.57
	18	92.4	12.66	110.6	15.10	128.1	17.73	137.2	19.04	146.3	20.35	163.8	23.17	182.0	26.02
	20	92.4	12.85	110.6	15.38	128.1	18.01	137.2	19.41	146.3	20.82	163.8	23.73	182.0	27.01
	21	92.4	13.04	110.6	15.48	128.1	18.20	137.2	19.60	146.3	21.01	163.8	24.10	182.0	27.59
	23	92.4	13.22	110.6	15.85	128.1	18.57	137.2	20.26	146.3	22.04	163.8	25.79	182.0	29.12
	25	92.4	13.41	110.6	16.41	128.1	19.79	137.2	21.67	146.3	23.54	163.8	27.57	182.0	30.54
	27	92.4	14.16	110.6	17.54	128.1	21.10	137.2	22.98	146.3	25.14	163.8	29.45	182.0	32.45
	29	92.4	15.10	110.6	18.57	128.1	22.42	137.2	24.48	146.3	26.73	163.8	31.42	182.0	34.77
	31	92.4	16.04	110.6	19.79	128.1	23.92	137.2	26.17	146.3	28.51	163.8	33.48	182.0	36.90
	33	92.4	16.98	110.6	20.92	128.1	25.42	137.2	27.76	146.3	30.29	163.8	35.64	182.0	39.28
	35	92.4	17.91	110.6	22.33	128.1	27.01	137.2	29.54	146.3	32.26	163.8	37.99	182.0	41.65
	37	92.4	19.04	110.6	23.65	128.1	28.70	137.2	31.42	146.3	34.33	163.8	40.42	182.0	43.95
	39	92.4	20.22	110.6	25.21	128.1	30.69	137.2	33.80	146.3	37.08	163.8	43.26	182.0	47.38
	41	90.0	22.35	107.8	27.62	124.8	33.66	133.7	37.08	142.6	40.31	159.6	47.52	177.3	51.12
43	87.8	24.33	105.1	30.10	121.7	36.73	130.4	40.43	139.0	44.02	155.7	51.91	173.0	55.27	
46	82.3	27.04	98.5	33.85	114.1	41.36	122.2	45.03	130.3	49.62	145.9	58.55	162.1	61.60	
48	72.8	23.60	87.1	29.56	100.9	36.16	108.1	39.36	115.3	43.41	129.0	51.23	143.4	53.32	
60	10	79.1	10.34	94.5	12.12	109.9	14.10	117.6	15.13	125.3	16.07	140.7	18.23	156.1	20.39
	12	79.1	10.53	94.5	12.31	109.9	14.29	117.6	15.32	125.3	16.35	140.7	18.51	156.1	20.77
	14	79.1	10.62	94.5	12.50	109.9	14.57	117.6	15.60	125.3	16.63	140.7	18.89	156.1	21.15
	16	79.1	10.81	94.5	12.78	109.9	14.76	117.6	15.88	125.3	17.01	140.7	19.27	156.1	21.52
	18	79.1	11.00	94.5	12.97	109.9	15.04	117.6	16.16	125.3	17.29	140.7	19.55	156.1	21.99
	20	79.1	11.18	94.5	13.16	109.9	15.32	117.6	16.45	125.3	17.57	140.7	19.92	156.1	22.46
	21	79.1	11.28	94.5	13.25	109.9	15.51	117.6	16.63	125.3	17.76	140.7	20.21	156.1	22.65
	23	79.1	11.47	94.5	13.53	109.9	15.69	117.6	16.92	125.3	18.14	140.7	20.96	156.1	24.06
	25	79.1	11.65	94.5	13.82	109.9	16.35	117.6	17.76	125.3	19.27	140.7	22.37	156.1	25.75
	27	79.1	12.03	94.5	14.57	109.9	17.39	117.6	18.89	125.3	20.49	140.7	23.78	156.1	27.44
	29	79.1	12.78	94.5	15.51	109.9	18.51	117.6	20.11	125.3	21.80	140.7	25.38	156.1	29.32
	31	79.1	13.53	94.5	16.45	109.9	19.64	117.6	21.43	125.3	23.21	140.7	27.07	156.1	31.20
	33	79.1	14.29	94.5	17.39	109.9	20.86	117.6	22.74	125.3	24.72	140.7	28.76	156.1	33.27
	35	79.1	15.13	94.5	18.51	109.9	22.18	117.6	24.15	125.3	26.22	140.7	30.64	156.1	35.34
	37	79.1	15.98	94.5	19.54	109.9	23.50	117.6	25.66	125.3	27.82	140.7	32.52	156.1	37.59
	39	79.1	16.99	94.5	20.80	109.9	25.36	117.6	27.53	125.3	29.94	140.7	34.87	156.1	40.28
	41	77.1	18.43	92.1	22.77	107.1	27.54	114.6	30.07	122.1	32.50	137.1	38.26	152.1	43.78
43	75.2	20.03	89.8	24.79	104.4	30.02	111.8	32.77	119.1	35.44	133.7	41.77	148.3	47.82	
46	70.4	22.43	84.2	27.83	97.9	33.77	104.7	36.84	111.6	39.87	125.3	47.07	139.0	54.48	
48	62.3	19.54	74.4	24.29	86.6	29.50	92.6	32.17	98.7	34.85	110.8	41.16	123.0	47.66	
50	10	66.2	8.95	79.1	10.36	91.7	11.77	98.0	12.62	104.3	13.37	116.9	15.07	130.2	16.76
	12	66.2	9.04	79.1	10.45	91.7	11.96	98.0	12.81	104.3	13.66	116.9	15.35	130.2	17.05
	14	66.2	9.13	79.1	10.64	91.7	12.15	98.0	13.00	104.3	13.84	116.9	15.54	130.2	17.33
	16	66.2	9.32	79.1	10.83	91.7	12.34	98.0	13.28	104.3	14.03	116.9	15.82	130.2	17.61
	18	66.2	9.42	79.1	10.92	91.7	12.53	98.0	13.47	104.3	14.31	116.9	16.10	130.2	17.99
	20	66.2	9.51	79.1	11.11	91.7	12.81	98.0	13.66	104.3	14.60	116.9	16.39	130.2	18.36
	21	66.2	9.61	79.1	11.21	91.7	12.90	98.0	13.84	104.3	14.69	116.9	16.57	130.2	18.55
	23	66.2	9.79	79.1	11.39	91.7	13.09	98.0	14.03	104.3	14.97	116.9	16.86	130.2	18.93
	25	66.2	9.89	79.1	11.58	91.7	13.37	98.0	14.31	104.3	15.44	116.9	17.70	130.2	20.25
	27	66.2	10.08	79.1	11.96	91.7	14.13	98.0	15.26	104.3	16.39	116.9	18.93	130.2	21.57
	29	66.2	10.64	79.1	12.71	91.7	14.97	98.0	16.20	104.3	17.42	116.9	20.06	130.2	22.88
	31	66.2	11.21	79.1	13.47	91.7	15.92	98.0	17.14	104.3	18.55	116.9	21.38	130.2	24.39
	33	66.2	11.87	79.1	14.22	91.7	16.86	98.0	18.18	104.3	19.68	116.9	22.70	130.2	25.99
	35	66.2	12.53	79.1	15.07	91.7	17.80	98.0	19.31	104.3	20.81	116.9	24.01	130.2	27.59
	37	66.2	13.28	79.1	15.92	91.7	18.83	98.0	20.44	104.3	22.04	116.9	25.62	130.2	29.29
	39	66.2	14.16	79.1	17.06	91.7	20.18	98.0	22.00	104.3	23.65	116.9	27.28	130.2	31.63
	41	64.5	15.32	77.1	18.47	89.4	22.07	95.5	23.82	101.6	25.62	113.9	29.91	126.9	34.35
43	62.9	16.64	75.2	20.09	87.1	24.01	93.1	25.94	99.1	27.89	111.1	32.61	123.7	37.47	
46	58.9	18.64	70.4	22.53	81.7	26.93	87.3	29.13	92.9	31.31	104.1	36.69	116.0	42.19	
48	52.1	16.25	62.3	19.65	72.2	23.49	77.2	25.43	82.2	27.33	92.1	32.07	102.6	36.88	

**Note**

1. TC: Total Capacity(kW), PI : Power Input(kW, Comp. + Outdoor fan motor)
2. Capacity tables show the average value of conditions which may occur.

# 7. Capacity Tables

◆ ARUM720LTE5

Cooling Capacity (72HP)

Combination (%)	Outdoor air temp. (DB, °C)	Indoor air temp. (DB/WB, °C)													
		20		23		26		27		28		30		32	
		14	16	16	18	18	19	19	20	20	22	22	24	24	
		TC	PI	TC	PI	TC	PI	TC	PI	TC	PI	TC	PI	TC	PI
130	10	199.7	22.16	237.8	27.08	254.9	31.41	262.2	32.05	269.5	32.31	282.5	32.56	289.8	32.69
	12	199.7	22.70	237.8	28.05	254.9	32.70	262.2	32.92	269.5	33.18	282.5	33.44	289.8	33.74
	14	199.7	23.47	237.8	29.06	254.9	33.93	262.2	34.18	269.5	34.45	282.5	34.73	289.8	35.03
	16	199.7	24.32	237.8	30.08	254.9	35.45	262.2	35.78	269.5	36.07	282.5	36.39	289.8	36.68
	18	199.7	25.34	237.8	31.81	254.9	37.08	262.2	37.88	269.5	38.18	282.5	38.56	289.8	38.83
	20	199.7	26.46	237.8	33.89	254.9	38.91	262.2	41.67	269.5	42.00	278.4	42.42	285.7	42.71
	21	199.7	27.16	237.8	35.08	254.9	39.73	262.2	44.10	269.5	44.45	276.8	44.89	284.1	45.20
	23	199.7	29.14	237.8	36.91	254.9	41.79	262.2	48.66	266.1	49.05	272.7	49.53	280.0	49.87
	25	199.7	31.12	237.8	39.03	254.9	44.66	259.1	53.96	262.2	54.39	269.5	54.93	276.8	55.31
	27	199.7	33.30	237.8	41.72	251.6	47.58	254.9	59.41	259.1	59.88	266.1	60.48	272.7	60.89
	29	199.7	35.48	237.8	44.61	247.6	51.20	251.2	65.29	254.9	65.68	262.2	66.27	269.5	66.53
	31	199.7	37.86	237.0	46.98	243.5	54.45	247.6	65.01	251.2	65.40	258.1	65.99	265.4	66.25
	33	199.7	40.34	232.9	49.78	240.2	58.40	244.1	64.42	247.6	64.81	254.9	65.39	261.3	65.64
	35	199.7	43.01	228.8	52.14	236.1	63.26	240.2	63.58	244.1	63.96	250.8	64.53	258.1	64.79
	37	199.7	45.87	225.6	54.71	232.9	62.43	236.1	62.74	240.2	63.12	246.8	63.68	254.1	63.93
	39	199.7	48.84	221.6	57.59	228.8	61.59	232.9	61.90	236.1	62.27	243.5	62.83	250.8	63.08
	41	194.6	51.81	212.4	60.47	219.6	60.76	222.9	61.06	227.2	61.43	234.1	61.98	240.4	62.22
	43	189.8	54.65	203.6	59.62	210.6	59.92	213.8	60.22	218.1	60.58	224.8	61.12	230.9	61.37
46	177.8	58.49	185.7	58.37	192.4	58.67	195.4	58.96	199.5	59.32	205.8	59.85	211.5	60.08	
48	157.3	56.86	161.3	57.03	167.3	57.15	170.0	57.31	173.6	57.80	179.1	58.17	184.1	58.40	
120	10	180.7	19.93	214.8	24.44	234.8	29.04	241.9	31.39	249.1	31.88	262.6	32.01	269.0	32.27
	12	180.7	20.47	214.8	25.26	234.8	30.21	241.9	32.05	249.1	33.06	262.6	33.46	269.0	33.73
	14	180.7	21.18	214.8	26.13	234.8	31.43	241.9	33.27	249.1	34.27	262.6	34.78	269.0	35.06
	16	180.7	21.94	214.8	27.19	234.8	32.65	241.9	34.51	249.1	35.86	262.6	36.30	269.0	36.59
	18	180.7	22.80	214.8	28.42	234.8	33.95	241.9	36.32	249.1	37.70	262.6	38.13	269.0	38.43
	20	180.7	23.67	214.8	30.13	234.8	35.78	241.9	38.23	249.1	39.69	262.6	40.22	269.0	40.54
	21	180.7	24.38	214.8	31.22	234.8	36.78	241.9	39.35	249.1	41.00	262.6	41.52	269.0	41.86
	23	180.7	26.07	214.8	33.40	234.8	39.41	241.9	41.82	249.1	43.71	262.6	44.16	269.0	44.51
	25	180.7	27.85	214.8	35.78	234.8	41.57	241.9	44.57	249.1	46.88	259.5	47.27	265.8	47.65
	27	180.7	29.73	214.8	38.26	234.8	44.23	241.9	47.62	249.1	50.38	255.5	50.72	261.9	51.12
	29	180.7	31.71	214.8	40.83	234.8	46.55	241.9	50.97	245.1	53.69	251.5	54.50	258.6	54.93
	31	180.7	33.80	214.8	43.61	234.8	48.96	238.8	54.60	241.9	57.59	248.3	58.61	254.6	59.08
	33	180.7	35.98	214.8	46.48	231.6	51.79	234.8	59.27	237.9	61.84	244.3	62.54	250.7	63.04
	35	180.7	38.26	214.8	49.55	227.6	54.81	230.8	65.29	234.8	65.61	241.2	65.81	247.5	66.33
	37	180.7	41.15	214.8	52.29	224.4	58.44	227.6	63.91	230.8	64.23	237.2	64.43	243.6	64.94
	39	180.7	44.30	214.1	55.27	220.5	61.98	223.6	62.60	226.8	62.91	234.0	63.10	240.3	63.60
	41	176.1	47.45	204.7	58.24	211.6	60.76	214.6	61.29	217.8	61.60	224.1	61.78	230.4	62.27
	43	171.7	50.64	196.2	57.41	203.0	59.40	205.9	59.98	208.9	60.28	215.1	60.46	221.3	60.94
46	160.9	54.46	178.9	56.04	185.3	57.53	188.1	58.01	190.9	58.30	196.7	58.47	202.5	58.93	
48	142.4	53.35	155.3	55.04	161.1	56.41	163.5	56.75	166.0	56.94	171.2	57.16	176.3	57.39	
110	10	161.9	17.93	193.0	21.85	215.6	25.96	221.7	28.10	235.8	30.24	241.2	31.08	257.5	31.60
	12	161.9	18.49	193.0	22.59	215.6	27.03	221.7	28.89	235.8	31.37	241.2	32.38	257.5	33.13
	14	161.9	19.06	193.0	23.61	215.6	28.26	221.7	30.32	235.8	32.95	241.2	33.89	257.5	34.61
	16	161.9	19.74	193.0	24.47	215.6	29.43	221.7	31.65	235.8	34.47	241.2	35.41	257.5	36.04
	18	161.9	20.47	193.0	25.49	215.6	31.12	221.7	33.32	235.8	36.36	241.2	37.08	257.5	37.77
	20	161.9	21.21	193.0	26.76	215.6	33.00	221.7	34.85	235.8	38.13	241.2	39.07	257.5	39.69
	21	161.9	21.68	193.0	27.55	215.6	33.85	221.7	35.79	235.8	39.19	241.2	40.18	257.5	40.81
	23	161.9	23.09	193.0	29.53	215.6	35.74	221.7	37.78	235.8	41.40	241.2	42.29	257.5	42.99
	25	161.9	24.68	193.0	31.52	215.6	37.76	221.7	39.95	235.8	43.74	241.2	44.37	254.4	45.28
	27	161.9	26.36	193.0	33.70	215.6	39.90	221.7	42.27	235.8	45.69	241.2	46.73	250.6	47.52
	29	161.9	28.15	193.0	35.98	215.6	42.17	221.7	44.77	235.8	48.28	241.2	49.11	247.5	49.85
	31	161.9	29.93	193.0	38.35	215.6	44.56	221.7	47.44	231.9	50.73	238.1	51.72	243.6	52.27
	33	161.9	31.91	193.0	40.83	215.6	47.07	221.7	50.27	228.7	53.57	234.2	54.46	240.4	54.76
	35	161.9	33.89	193.0	43.61	215.6	49.72	221.7	53.26	224.9	56.54	230.3	57.06	236.6	57.34
	37	161.9	35.92	193.0	46.28	215.6	52.49	218.6	56.43	221.0	59.63	227.2	59.84	232.7	60.01
	39	161.9	38.73	193.0	49.18	211.6	55.38	214.7	60.36	217.9	62.59	223.3	62.69	229.6	62.75
	41	157.7	41.54	188.0	52.08	202.6	58.40	205.7	65.29	208.4	65.29	214.5	65.81	219.9	66.33
	43	153.8	43.61	183.4	54.26	194.1	61.93	197.3	62.63	199.9	62.49	205.8	62.85	211.0	63.02
46	144.1	42.57	171.8	52.38	177.1	58.77	180.2	58.77	182.6	59.28	188.1	59.61	193.0	59.77	
48	127.5	41.34	149.4	50.46	153.9	55.92	156.7	56.29	158.7	56.57	163.6	56.72	168.0	56.95	

# 7. Capacity Tables

Cooling Capacity (72HP)

Combination (%)	Outdoor air temp. (DB, °C)	Indoor air temp. (DB/WB, °C)													
		20		23		26		27		28		30		32	
		14		16		18		19		20		22		24	
		TC	PI	TC	PI	TC	PI	TC	PI	TC	PI	TC	PI	TC	PI
100	10	136.1	16.14	162.0	19.62	188.6	23.28	201.6	25.15	214.6	27.03	237.9	30.09	243.1	30.33
	12	136.1	16.66	162.0	20.42	188.6	24.06	201.6	25.83	214.6	27.89	237.9	31.70	243.1	32.02
	14	136.1	17.18	162.0	21.24	188.6	25.08	201.6	26.95	214.6	29.09	237.9	33.48	243.1	33.79
	16	136.1	17.71	162.0	21.94	188.6	26.15	201.6	28.23	214.6	30.66	237.9	35.09	243.1	35.59
	18	136.1	18.23	162.0	22.76	188.6	27.17	201.6	29.61	214.6	32.51	237.9	37.08	243.1	37.37
	20	136.1	18.88	162.0	23.62	188.6	28.74	201.6	31.71	214.6	34.79	237.9	38.85	243.1	39.16
	21	136.1	19.27	162.0	24.18	188.6	29.73	201.6	32.80	214.6	36.08	237.9	39.74	243.1	40.06
	23	136.1	20.42	162.0	25.87	188.6	31.91	201.6	35.18	214.6	38.65	237.9	41.61	243.1	41.95
	25	136.1	21.70	162.0	27.55	188.6	34.09	201.6	37.66	214.6	41.33	237.9	43.39	241.1	43.74
	27	136.1	23.19	162.0	29.44	188.6	36.47	201.6	40.24	214.6	43.94	233.3	45.43	238.2	45.79
	29	136.1	24.68	162.0	31.42	188.6	38.95	201.6	43.01	214.6	46.51	228.9	47.26	234.6	47.64
	31	136.1	26.36	162.0	33.50	188.6	41.53	201.6	45.89	214.6	48.87	225.5	49.09	231.0	49.48
	33	136.1	27.95	162.0	35.68	188.6	44.30	201.6	48.96	214.6	50.70	221.9	50.92	227.4	51.33
	35	136.1	29.73	162.0	37.96	188.6	47.18	201.6	52.23	211.3	52.54	217.8	52.75	223.4	53.17
	37	136.1	31.84	162.0	40.71	188.6	49.97	201.6	54.72	207.8	54.99	213.8	55.21	218.9	55.72
	39	136.1	34.14	162.0	43.74	188.6	52.95	201.6	57.39	204.3	57.65	210.4	57.86	215.3	58.40
	41	133.9	36.43	159.4	46.76	185.7	55.94	193.4	60.06	197.7	60.30	202.3	60.52	208.9	61.08
	43	129.3	38.56	154.0	49.57	179.3	58.61	185.5	62.36	187.6	62.58	193.4	62.79	198.5	63.38
46	121.2	41.48	144.3	53.44	168.0	62.17	169.3	65.29	171.2	65.48	176.7	65.67	181.4	66.29	
48	107.2	35.81	127.6	46.23	145.0	53.15	147.2	55.40	148.7	55.58	153.6	55.70	157.8	56.15	
90	10	122.4	14.89	146.2	17.90	169.9	21.10	181.4	22.74	193.0	24.48	216.7	27.40	240.5	30.33
	12	122.4	15.07	146.2	18.18	169.9	21.47	181.4	23.20	193.0	25.03	216.7	27.94	240.5	31.01
	14	122.4	15.35	146.2	18.54	169.9	21.92	181.4	23.66	193.0	25.48	216.7	28.49	240.5	31.64
	16	122.4	15.62	146.2	18.91	169.9	22.38	181.4	24.11	193.0	25.94	216.7	29.03	240.5	32.18
	18	122.4	15.89	146.2	19.27	169.9	22.74	181.4	24.66	193.0	26.49	216.7	29.66	240.5	33.80
	20	122.4	16.17	146.2	19.64	169.9	23.20	181.4	25.12	193.0	27.49	216.7	31.74	240.5	35.42
	21	122.4	16.35	146.2	19.82	169.9	23.66	181.4	25.94	193.0	28.50	216.7	32.26	240.5	36.22
	23	122.4	16.72	146.2	20.64	169.9	25.30	181.4	27.86	193.0	30.51	216.7	34.21	237.2	37.93
	25	122.4	17.54	146.2	22.01	169.9	27.04	181.4	29.78	193.0	32.61	216.7	36.58	233.8	39.55
	27	122.4	18.73	146.2	23.48	169.9	28.86	181.4	31.79	193.0	34.89	216.7	38.89	230.3	41.41
	29	122.4	19.82	146.2	25.03	169.9	30.87	181.4	33.98	193.0	37.27	216.7	41.19	226.9	43.08
	31	122.4	21.10	146.2	26.67	169.9	32.88	181.4	36.17	193.0	39.73	216.7	43.25	223.5	44.75
	33	122.4	22.47	146.2	28.41	169.9	35.08	181.4	38.55	193.0	42.14	216.7	45.34	220.0	46.41
	35	122.4	23.84	146.2	30.14	169.9	37.27	181.4	41.10	193.0	44.69	213.0	47.94	216.6	49.04
	37	122.4	25.30	146.2	32.06	169.9	39.74	181.4	43.67	193.0	47.17	209.6	50.12	213.2	51.24
	39	122.4	26.79	146.2	34.10	169.9	42.06	181.4	46.47	193.0	49.61	206.1	52.84	209.8	53.47
	41	119.3	29.98	142.4	37.81	165.6	46.16	176.8	50.82	188.0	53.56	197.5	55.68	201.1	56.96
	43	116.3	32.36	138.9	40.85	161.5	50.42	172.4	54.73	183.4	57.42	189.4	59.63	192.8	60.35
46	109.0	36.42	130.2	46.53	151.3	57.45	161.6	62.05	166.6	63.80	172.9	65.45	176.1	65.55	
48	96.4	31.83	115.1	40.70	133.9	50.27	142.9	54.13	144.7	54.98	150.2	55.70	153.1	56.15	
80	10	108.7	13.87	129.6	16.67	150.5	19.56	161.3	21.10	172.1	22.64	193.0	25.82	213.8	28.03
	12	108.7	14.16	129.6	16.86	150.5	19.94	161.3	21.49	172.1	23.03	193.0	26.30	213.8	28.59
	14	108.7	14.36	129.6	17.25	150.5	20.23	161.3	21.87	172.1	23.41	193.0	26.78	213.8	29.14
	16	108.7	14.55	129.6	17.54	150.5	20.62	161.3	22.26	172.1	23.89	193.0	27.36	213.8	29.70
	18	108.7	14.84	129.6	17.82	150.5	21.00	161.3	22.64	172.1	24.38	193.0	27.84	213.8	30.35
	20	108.7	15.13	129.6	18.21	150.5	21.49	161.3	23.12	172.1	24.86	193.0	28.90	213.8	32.15
	21	108.7	15.22	129.6	18.40	150.5	21.68	161.3	23.41	172.1	25.44	193.0	29.82	213.8	33.00
	23	108.7	15.51	129.6	18.69	150.5	22.64	161.3	24.86	172.1	27.17	193.0	31.48	213.8	34.64
	25	108.7	16.09	129.6	19.94	150.5	24.28	161.3	26.59	172.1	29.10	193.0	33.69	213.8	37.04
	27	108.7	17.05	129.6	21.20	150.5	25.92	161.3	28.42	172.1	31.02	193.0	35.80	213.8	38.97
	29	108.7	18.11	129.6	22.64	150.5	27.56	161.3	30.25	172.1	33.14	193.0	38.36	213.8	40.92
	31	108.7	19.27	129.6	23.99	150.5	29.39	161.3	32.28	172.1	35.26	193.0	40.70	213.8	42.96
	33	108.7	20.43	129.6	25.63	150.5	31.31	161.3	34.40	172.1	37.58	193.0	42.89	213.8	45.02
	35	108.7	21.68	129.6	27.17	150.5	33.34	161.3	36.61	172.1	40.08	193.0	45.47	211.6	47.57
	37	108.7	22.93	129.6	28.89	150.5	35.36	161.3	38.92	172.1	42.59	193.0	47.99	208.2	49.75
	39	108.7	24.23	129.6	30.54	150.5	37.83	161.3	41.85	172.1	45.76	193.0	50.70	204.7	52.48
	41	105.9	26.81	126.3	33.84	146.6	41.51	157.2	45.87	167.7	50.29	188.0	54.57	196.1	55.82
	43	103.3	29.51	123.2	36.93	143.0	45.31	153.3	49.99	163.5	54.95	183.4	58.43	188.0	59.75
46	96.8	32.83	115.4	41.60	134.0	51.06	143.6	55.64	153.3	62.01	167.7	65.45	171.6	65.55	
48	85.7	28.67	102.1	36.37	118.6	44.65	127.1	48.60	135.6	54.28	145.6	55.70	149.1	56.15	

# 7. Capacity Tables

Cooling Capacity (72HP)

Combination (%)	Outdoor air temp. (DB, °C)	Indoor air temp. (DB/WB, °C)													
		20		23		26		27		28		30		32	
		14		16		18		19		20		22		24	
		TC	PI	TC	PI	TC	PI	TC	PI	TC	PI	TC	PI	TC	PI
70	10	95.0	12.26	113.8	14.58	131.8	16.90	141.1	18.25	150.5	19.50	168.5	22.21	187.2	24.84
	12	95.0	12.45	113.8	14.77	131.8	17.28	141.1	18.54	150.5	19.89	168.5	22.59	187.2	25.30
	14	95.0	12.65	113.8	14.96	131.8	17.57	141.1	18.83	150.5	20.18	168.5	23.07	187.2	25.77
	16	95.0	12.84	113.8	15.25	131.8	17.86	141.1	19.21	150.5	20.56	168.5	23.46	187.2	26.32
	18	95.0	13.03	113.8	15.54	131.8	18.25	141.1	19.60	150.5	20.95	168.5	23.85	187.2	26.79
	20	95.0	13.23	113.8	15.83	131.8	18.54	141.1	19.98	150.5	21.43	168.5	24.43	187.2	27.80
	21	95.0	13.42	113.8	15.93	131.8	18.73	141.1	20.18	150.5	21.63	168.5	24.81	187.2	28.40
	23	95.0	13.61	113.8	16.32	131.8	19.12	141.1	20.85	150.5	22.69	168.5	26.55	187.2	29.98
	25	95.0	13.81	113.8	16.90	131.8	20.37	141.1	22.30	150.5	24.23	168.5	28.38	187.2	31.44
	27	95.0	14.58	113.8	18.05	131.8	21.72	141.1	23.65	150.5	25.87	168.5	30.31	187.2	33.40
	29	95.0	15.54	113.8	19.12	131.8	23.07	141.1	25.20	150.5	27.52	168.5	32.34	187.2	35.79
	31	95.0	16.51	113.8	20.37	131.8	24.62	141.1	26.94	150.5	29.35	168.5	34.47	187.2	37.98
	33	95.0	17.47	113.8	21.53	131.8	26.16	141.1	28.58	150.5	31.18	168.5	36.69	187.2	40.43
	35	95.0	18.44	113.8	22.99	131.8	27.80	141.1	30.41	150.5	33.21	168.5	39.10	187.2	42.87
	37	95.0	19.60	113.8	24.34	131.8	29.54	141.1	32.34	150.5	35.34	168.5	41.61	187.2	45.24
	39	95.0	20.81	113.8	25.95	131.8	31.59	141.1	34.80	150.5	38.17	168.5	44.53	187.2	48.78
41	92.6	23.01	110.8	28.43	128.4	34.65	137.5	38.17	146.6	41.50	164.2	48.91	182.4	52.62	
43	90.3	25.05	108.1	30.99	125.2	37.81	134.1	41.62	143.0	45.31	160.1	53.43	177.9	56.89	
46	84.6	27.83	101.3	34.84	117.3	42.58	125.7	46.36	134.0	51.08	150.0	60.27	166.7	63.41	
48	74.9	24.29	89.6	30.43	103.8	37.22	111.2	40.51	118.6	44.69	132.7	52.74	147.5	54.88	
60	10	81.4	10.64	97.2	12.48	113.0	14.51	121.0	15.58	128.9	16.54	144.7	18.77	160.6	20.99
	12	81.4	10.84	97.2	12.67	113.0	14.70	121.0	15.77	128.9	16.83	144.7	19.06	160.6	21.38
	14	81.4	10.93	97.2	12.87	113.0	14.99	121.0	16.06	128.9	17.12	144.7	19.45	160.6	21.77
	16	81.4	11.13	97.2	13.16	113.0	15.19	121.0	16.35	128.9	17.51	144.7	19.83	160.6	22.15
	18	81.4	11.32	97.2	13.35	113.0	15.48	121.0	16.64	128.9	17.80	144.7	20.12	160.6	22.64
	20	81.4	11.51	97.2	13.54	113.0	15.77	121.0	16.93	128.9	18.09	144.7	20.51	160.6	23.12
	21	81.4	11.61	97.2	13.64	113.0	15.96	121.0	17.12	128.9	18.28	144.7	20.80	160.6	23.31
	23	81.4	11.80	97.2	13.93	113.0	16.16	121.0	17.41	128.9	18.67	144.7	21.57	160.6	24.77
	25	81.4	12.00	97.2	14.22	113.0	16.83	121.0	18.28	128.9	19.83	144.7	23.02	160.6	26.51
	27	81.4	12.38	97.2	14.99	113.0	17.90	121.0	19.45	128.9	21.09	144.7	24.48	160.6	28.25
	29	81.4	13.16	97.2	15.96	113.0	19.06	121.0	20.70	128.9	22.44	144.7	26.12	160.6	30.18
	31	81.4	13.93	97.2	16.93	113.0	20.22	121.0	22.06	128.9	23.90	144.7	27.86	160.6	32.12
	33	81.4	14.70	97.2	17.90	113.0	21.48	121.0	23.41	128.9	25.44	144.7	29.60	160.6	34.25
	35	81.4	15.58	97.2	19.06	113.0	22.83	121.0	24.86	128.9	26.99	144.7	31.54	160.6	36.37
	37	81.4	16.45	97.2	20.11	113.0	24.19	121.0	26.41	128.9	28.64	144.7	33.47	160.6	38.70
	39	81.4	17.49	97.2	21.42	113.0	26.11	121.0	28.34	128.9	30.82	144.7	35.89	160.6	41.47
41	79.3	18.97	94.7	23.43	110.1	28.35	117.9	30.95	125.6	33.45	141.0	39.39	156.5	45.06	
43	77.3	20.61	92.4	25.51	107.4	30.90	115.0	33.73	122.5	36.48	137.5	43.00	152.6	49.22	
46	72.5	23.09	86.6	28.65	100.7	34.76	107.7	37.92	114.8	41.05	128.9	48.45	143.0	56.08	
48	64.1	20.12	76.6	25.00	89.1	30.37	95.3	33.12	101.5	35.87	114.0	42.37	126.5	49.06	
50	10	68.0	9.21	81.4	10.66	94.3	12.12	100.8	12.99	107.3	13.77	120.2	15.51	133.9	17.26
	12	68.0	9.31	81.4	10.76	94.3	12.31	100.8	13.18	107.3	14.06	120.2	15.80	133.9	17.55
	14	68.0	9.40	81.4	10.95	94.3	12.51	100.8	13.38	107.3	14.25	120.2	15.99	133.9	17.84
	16	68.0	9.60	81.4	11.15	94.3	12.70	100.8	13.67	107.3	14.44	120.2	16.29	133.9	18.13
	18	68.0	9.69	81.4	11.24	94.3	12.89	100.8	13.86	107.3	14.73	120.2	16.58	133.9	18.52
	20	68.0	9.79	81.4	11.44	94.3	13.18	100.8	14.06	107.3	15.03	120.2	16.87	133.9	18.90
	21	68.0	9.89	81.4	11.54	94.3	13.28	100.8	14.25	107.3	15.12	120.2	17.06	133.9	19.10
	23	68.0	10.08	81.4	11.73	94.3	13.47	100.8	14.44	107.3	15.41	120.2	17.35	133.9	19.48
	25	68.0	10.18	81.4	11.92	94.3	13.77	100.8	14.73	107.3	15.90	120.2	18.22	133.9	20.84
	27	68.0	10.37	81.4	12.31	94.3	14.54	100.8	15.70	107.3	16.87	120.2	19.48	133.9	22.20
	29	68.0	10.95	81.4	13.09	94.3	15.41	100.8	16.67	107.3	17.93	120.2	20.65	133.9	23.56
	31	68.0	11.54	81.4	13.86	94.3	16.38	100.8	17.64	107.3	19.10	120.2	22.01	133.9	25.11
	33	68.0	12.21	81.4	14.64	94.3	17.35	100.8	18.71	107.3	20.26	120.2	23.36	133.9	26.76
	35	68.0	12.89	81.4	15.51	94.3	18.32	100.8	19.87	107.3	21.42	120.2	24.72	133.9	28.40
	37	68.0	13.67	81.4	16.38	94.3	19.39	100.8	21.04	107.3	22.68	120.2	26.37	133.9	30.15
	39	68.0	14.58	81.4	17.56	94.3	20.77	100.8	22.64	107.3	24.34	120.2	28.08	133.9	32.56
41	66.3	15.77	79.3	19.01	91.9	22.71	98.2	24.52	104.5	26.37	117.2	30.79	130.5	35.36	
43	64.7	17.13	77.3	20.68	89.6	24.71	95.8	26.70	101.9	28.71	114.3	33.57	127.3	38.57	
46	60.6	19.19	72.5	23.19	84.0	27.72	89.8	29.99	95.5	32.23	107.1	37.77	119.3	43.43	
48	53.6	16.72	64.1	20.23	74.3	24.18	79.4	26.17	84.5	28.13	94.7	33.01	105.5	37.96	

**Note**

1. TC: Total Capacity(kW), PI : Power Input(kW, Comp. + Outdoor fan motor)
2. Capacity tables show the average value of conditions which may occur.

# 7. Capacity Tables

◆ ARUM740LTE5

Cooling Capacity (74HP)

Combination (%)	Outdoor air temp. (DB, °C)	Indoor air temp. (DB/WB, °C)													
		20		23		26		27		28		30		32	
		14	16	18	19	20	22	24	TC	PI	TC	PI			
130	10	205.2	21.72	244.4	26.55	261.9	30.79	269.5	31.42	277.0	31.67	290.3	31.92	297.8	32.05
	12	205.2	22.26	244.4	27.49	261.9	32.06	269.5	32.27	277.0	32.53	290.3	32.78	297.8	33.07
	14	205.2	23.00	244.4	28.49	261.9	33.26	269.5	33.51	277.0	33.77	290.3	34.04	297.8	34.34
	16	205.2	23.84	244.4	29.48	261.9	34.75	269.5	35.08	277.0	35.36	290.3	35.67	297.8	35.95
	18	205.2	24.85	244.4	31.19	261.9	36.35	269.5	37.13	277.0	37.43	290.3	37.80	297.8	38.06
	20	205.2	25.94	244.4	33.23	261.9	38.14	269.5	40.85	277.0	41.18	286.1	41.58	293.6	41.87
	21	205.2	26.62	244.4	34.39	261.9	38.94	269.5	43.23	277.0	43.57	284.5	44.00	292.0	44.31
	23	205.2	28.56	244.4	36.18	261.9	40.97	269.5	47.70	273.5	48.08	280.3	48.56	287.8	48.89
	25	205.2	30.51	244.4	38.26	261.9	43.78	266.3	52.90	269.5	53.32	277.0	53.85	284.5	54.22
	27	205.2	32.64	244.4	40.90	258.6	46.64	261.9	58.23	266.3	58.70	273.5	59.28	280.3	59.69
	29	205.2	34.78	244.4	43.73	254.4	50.19	258.1	64.00	261.9	64.38	269.5	64.96	277.0	65.22
	31	205.2	37.11	243.6	46.06	250.2	53.38	254.4	63.73	258.1	64.12	265.3	64.69	272.8	64.94
	33	205.2	39.54	239.4	48.80	246.9	57.25	250.9	63.15	254.4	63.53	261.9	64.10	268.6	64.35
	35	205.2	42.16	235.2	51.11	242.7	62.02	246.9	62.33	250.9	62.70	257.7	63.26	265.3	63.51
	37	205.2	44.96	231.9	53.63	239.4	61.20	242.7	61.50	246.9	61.87	253.6	62.43	261.1	62.67
	39	205.2	47.88	227.8	56.46	235.2	60.38	239.4	60.68	242.7	61.04	250.2	61.59	257.7	61.83
41	200.0	50.79	218.3	59.28	225.7	59.56	229.1	59.86	233.5	60.22	240.6	60.76	247.1	60.99	
43	195.0	53.57	209.2	58.44	216.5	58.74	219.8	59.03	224.2	59.39	231.1	59.92	237.4	60.16	
46	182.8	57.34	190.9	57.22	197.8	57.51	200.9	57.80	205.0	58.15	211.5	58.67	217.3	58.90	
48	161.7	55.74	165.8	55.91	171.9	56.03	174.7	56.18	178.4	56.66	184.1	57.02	189.3	57.25	
120	10	185.7	19.54	220.8	23.96	241.3	28.47	248.7	30.77	256.0	31.25	269.9	31.38	276.5	31.63
	12	185.7	20.07	220.8	24.77	241.3	29.61	248.7	31.42	256.0	32.41	269.9	32.80	276.5	33.07
	14	185.7	20.76	220.8	25.61	241.3	30.81	248.7	32.61	256.0	33.60	269.9	34.09	276.5	34.37
	16	185.7	21.51	220.8	26.65	241.3	32.00	248.7	33.83	256.0	35.15	269.9	35.58	276.5	35.87
	18	185.7	22.35	220.8	27.86	241.3	33.28	248.7	35.61	256.0	36.96	269.9	37.38	276.5	37.68
	20	185.7	23.20	220.8	29.53	241.3	35.07	248.7	37.47	256.0	38.91	269.9	39.42	276.5	39.74
	21	185.7	23.90	220.8	30.60	241.3	36.06	248.7	38.57	256.0	40.19	269.9	40.70	276.5	41.03
	23	185.7	25.55	220.8	32.74	241.3	38.63	248.7	40.99	256.0	42.85	269.9	43.28	276.5	43.63
	25	185.7	27.30	220.8	35.07	241.3	40.75	248.7	43.69	256.0	45.95	266.7	46.34	273.2	46.71
	27	185.7	29.15	220.8	37.50	241.3	43.36	248.7	46.68	256.0	49.38	262.6	49.72	269.1	50.11
	29	185.7	31.09	220.8	40.03	241.3	45.63	248.7	49.96	251.9	52.63	258.5	53.42	265.8	53.85
	31	185.7	33.13	220.8	42.75	241.3	47.99	245.4	53.52	248.7	56.46	255.2	57.46	261.7	57.92
	33	185.7	35.27	220.8	45.57	238.1	50.77	241.3	58.10	244.5	60.62	251.1	61.31	257.7	61.80
	35	185.7	37.50	220.8	48.58	233.9	53.73	237.2	64.00	241.3	64.32	247.9	64.51	254.3	65.02
	37	185.7	40.34	220.8	51.26	230.6	57.29	233.9	62.65	237.2	62.97	243.8	63.16	250.3	63.66
	39	185.7	43.43	220.0	54.18	226.6	60.76	229.8	61.37	233.1	61.67	240.5	61.86	247.0	62.35
41	181.0	46.51	210.4	57.09	217.5	59.56	220.6	60.08	223.8	60.38	230.3	60.56	236.8	61.04	
43	176.5	49.65	201.6	56.28	208.6	58.23	211.6	58.79	214.7	59.09	221.1	59.26	227.4	59.73	
46	165.4	53.38	183.8	54.93	190.5	56.40	193.3	56.86	196.2	57.15	202.2	57.32	208.2	57.77	
48	146.3	52.29	159.6	53.96	165.6	55.30	168.1	55.63	170.7	55.81	175.9	56.04	181.2	56.26	
110	10	166.4	17.58	198.3	21.42	221.5	25.44	227.9	27.54	242.3	29.64	247.9	30.46	264.7	30.97
	12	166.4	18.12	198.3	22.14	221.5	26.50	227.9	28.32	242.3	30.75	247.9	31.74	264.7	32.48
	14	166.4	18.69	198.3	23.14	221.5	27.70	227.9	29.72	242.3	32.30	247.9	33.22	264.7	33.92
	16	166.4	19.35	198.3	23.99	221.5	28.85	227.9	31.02	242.3	33.79	247.9	34.71	264.7	35.33
	18	166.4	20.07	198.3	24.98	221.5	30.51	227.9	32.66	242.3	35.65	247.9	36.35	264.7	37.03
	20	166.4	20.79	198.3	26.23	221.5	32.35	227.9	34.17	242.3	37.38	247.9	38.30	264.7	38.91
	21	166.4	21.25	198.3	27.01	221.5	33.18	227.9	35.08	242.3	38.42	247.9	39.39	264.7	40.00
	23	166.4	22.64	198.3	28.95	221.5	35.04	227.9	37.04	242.3	40.59	247.9	41.46	264.7	42.14
	25	166.4	24.19	198.3	30.89	221.5	37.01	227.9	39.16	242.3	42.88	247.9	43.49	261.5	44.39
	27	166.4	25.84	198.3	33.03	221.5	39.11	227.9	41.44	242.3	44.78	247.9	45.81	257.6	46.59
	29	166.4	27.59	198.3	35.27	221.5	41.33	227.9	43.89	242.3	47.32	247.9	48.14	254.4	48.87
	31	166.4	29.34	198.3	37.60	221.5	43.68	227.9	46.50	238.3	49.73	244.7	50.70	250.3	51.24
	33	166.4	31.28	198.3	40.03	221.5	46.15	227.9	49.27	235.1	52.52	240.7	53.39	247.1	53.68
	35	166.4	33.23	198.3	42.75	221.5	48.74	227.9	52.21	231.1	55.42	236.7	55.94	243.1	56.21
	37	166.4	35.21	198.3	45.37	221.5	51.45	224.7	55.32	227.1	58.46	233.5	58.66	239.1	58.82
	39	166.4	37.97	198.3	48.21	217.5	54.29	220.7	59.17	223.9	61.35	229.5	61.46	235.9	61.52
41	162.1	40.72	193.2	51.05	208.2	57.25	211.5	64.00	214.2	64.00	220.5	64.51	226.0	65.02	
43	158.1	42.75	188.5	53.19	199.5	60.71	202.8	61.39	205.4	61.26	211.5	61.61	216.9	61.78	
46	148.2	41.73	176.6	51.35	182.1	57.61	185.2	57.61	187.6	58.11	193.4	58.43	198.4	58.59	
48	131.1	40.53	153.5	49.47	158.1	54.82	161.0	55.18	163.1	55.45	168.2	55.61	172.6	55.83	



# 7. Capacity Tables

Cooling Capacity (74HP)

Combination (%)	Outdoor air temp. (DB, °C)	Indoor air temp. (DB/WB, °C)													
		20		23		26		27		28		30		32	
		14		16		18		19		20		22		24	
		TC	PI	TC	PI	TC	PI	TC	PI	TC	PI	TC	PI	TC	PI
100	10	139.9	15.83	166.5	19.24	193.9	22.82	207.2	24.66	220.5	26.49	244.5	29.49	249.9	29.73
	12	139.9	16.33	166.5	20.02	193.9	23.59	207.2	25.32	220.5	27.34	244.5	31.08	249.9	31.39
	14	139.9	16.84	166.5	20.82	193.9	24.59	207.2	26.42	220.5	28.52	244.5	32.82	249.9	33.13
	16	139.9	17.36	166.5	21.51	193.9	25.64	207.2	27.67	220.5	30.05	244.5	34.40	249.9	34.88
	18	139.9	17.87	166.5	22.31	193.9	26.63	207.2	29.02	220.5	31.87	244.5	36.35	249.9	36.64
	20	139.9	18.51	166.5	23.15	193.9	28.17	207.2	31.09	220.5	34.10	244.5	38.09	249.9	38.39
	21	139.9	18.89	166.5	23.71	193.9	29.15	207.2	32.16	220.5	35.36	244.5	38.96	249.9	39.27
	23	139.9	20.01	166.5	25.36	193.9	31.28	207.2	34.49	220.5	37.89	244.5	40.79	249.9	41.12
	25	139.9	21.28	166.5	27.01	193.9	33.42	207.2	36.92	220.5	40.51	244.5	42.53	247.8	42.87
	27	139.9	22.73	166.5	28.85	193.9	35.75	207.2	39.44	220.5	43.07	239.7	44.54	244.8	44.89
	29	139.9	24.19	166.5	30.80	193.9	38.18	207.2	42.16	220.5	45.59	235.3	46.33	241.1	46.70
	31	139.9	25.84	166.5	32.84	193.9	40.71	207.2	44.98	220.5	47.90	231.8	48.12	237.4	48.51
	33	139.9	27.40	166.5	34.98	193.9	43.43	207.2	47.99	220.5	49.70	228.0	49.91	233.7	50.31
	35	139.9	29.15	166.5	37.21	193.9	46.25	207.2	51.20	217.1	51.51	223.9	51.71	229.6	52.12
	37	139.9	31.21	166.5	39.91	193.9	48.99	207.2	53.64	213.6	53.90	219.7	54.12	225.0	54.62
	39	139.9	33.47	166.5	42.87	193.9	51.91	207.2	56.26	210.0	56.51	216.2	56.72	221.3	57.25
	41	137.6	35.72	163.9	45.83	190.8	54.83	198.8	58.88	203.2	59.12	208.0	59.32	214.7	59.88
	43	132.9	37.80	158.2	48.59	184.2	57.45	190.6	61.13	192.8	61.35	198.8	61.55	204.0	62.13
46	124.6	40.66	148.3	52.38	172.7	60.94	174.0	64.00	175.9	64.19	181.6	64.38	186.4	64.98	
48	110.2	35.11	131.2	45.32	149.1	52.10	151.3	54.30	152.8	54.48	157.9	54.60	162.2	55.04	
90	10	125.8	14.65	150.2	17.62	174.6	20.76	186.5	22.38	198.3	24.09	222.7	26.96	247.2	29.73
	12	125.8	14.83	150.2	17.89	174.6	21.12	186.5	22.83	198.3	24.63	222.7	27.50	247.2	30.52
	14	125.8	15.10	150.2	18.25	174.6	21.57	186.5	23.28	198.3	25.08	222.7	28.03	247.2	31.14
	16	125.8	15.37	150.2	18.61	174.6	22.02	186.5	23.73	198.3	25.53	222.7	28.57	247.2	31.67
	18	125.8	15.64	150.2	18.97	174.6	22.38	186.5	24.27	198.3	26.07	222.7	29.19	247.2	33.26
	20	125.8	15.91	150.2	19.33	174.6	22.83	186.5	24.72	198.3	27.06	222.7	31.24	247.2	34.85
	21	125.8	16.09	150.2	19.51	174.6	23.28	186.5	25.53	198.3	28.05	222.7	31.75	247.2	35.65
	23	125.8	16.45	150.2	20.32	174.6	24.90	186.5	27.42	198.3	30.02	222.7	33.67	243.8	37.33
	25	125.8	17.26	150.2	21.66	174.6	26.61	186.5	29.30	198.3	32.09	222.7	36.00	240.2	38.92
	27	125.8	18.43	150.2	23.10	174.6	28.41	186.5	31.28	198.3	34.34	222.7	38.27	236.7	40.75
	29	125.8	19.51	150.2	24.63	174.6	30.38	186.5	33.44	198.3	36.68	222.7	40.54	233.2	42.39
	31	125.8	20.76	150.2	26.25	174.6	32.36	186.5	35.60	198.3	39.10	222.7	42.56	229.7	44.03
	33	125.8	22.11	150.2	27.96	174.6	34.52	186.5	37.93	198.3	41.47	222.7	44.62	226.2	45.68
	35	125.8	23.46	150.2	29.66	174.6	36.68	186.5	40.45	198.3	43.98	218.9	47.18	222.6	48.26
	37	125.8	24.90	150.2	31.55	174.6	39.11	186.5	42.97	198.3	46.43	215.4	49.32	219.1	50.43
	39	125.8	26.36	150.2	33.56	174.6	41.39	186.5	45.73	198.3	48.82	211.9	52.00	215.6	52.62
	41	122.6	29.50	146.4	37.21	170.2	45.43	181.7	50.01	193.2	52.71	203.0	54.80	206.6	56.05
	43	119.5	31.84	142.8	40.20	166.0	49.62	177.2	53.86	188.5	56.51	194.6	58.68	198.2	59.39
46	112.0	35.84	133.8	45.79	155.5	56.54	166.1	61.06	171.2	62.78	177.7	64.23	181.0	64.48	
48	99.1	31.32	118.3	40.05	137.6	49.47	146.9	53.27	148.7	54.07	154.4	54.60	157.4	55.04	
80	10	111.7	13.66	133.2	16.41	154.7	19.26	165.8	20.78	176.9	22.30	198.3	25.43	219.8	27.61
	12	111.7	13.95	133.2	16.60	154.7	19.64	165.8	21.16	176.9	22.68	198.3	25.90	219.8	28.15
	14	111.7	14.14	133.2	16.98	154.7	19.93	165.8	21.54	176.9	23.06	198.3	26.38	219.8	28.70
	16	111.7	14.33	133.2	17.27	154.7	20.30	165.8	21.92	176.9	23.53	198.3	26.95	219.8	29.25
	18	111.7	14.61	133.2	17.55	154.7	20.68	165.8	22.30	176.9	24.01	198.3	27.42	219.8	29.89
	20	111.7	14.90	133.2	17.93	154.7	21.16	165.8	22.77	176.9	24.48	198.3	28.46	219.8	31.66
	21	111.7	14.99	133.2	18.12	154.7	21.35	165.8	23.06	176.9	25.05	198.3	29.36	219.8	32.50
	23	111.7	15.28	133.2	18.41	154.7	22.30	165.8	24.48	176.9	26.76	198.3	31.00	219.8	34.11
	25	111.7	15.85	133.2	19.64	154.7	23.91	165.8	26.19	176.9	28.65	198.3	33.18	219.8	36.48
	27	111.7	16.79	133.2	20.87	154.7	25.52	165.8	27.99	176.9	30.55	198.3	35.25	219.8	38.38
	29	111.7	17.84	133.2	22.30	154.7	27.14	165.8	29.79	176.9	32.64	198.3	37.77	219.8	40.27
	31	111.7	18.98	133.2	23.63	154.7	28.94	165.8	31.79	176.9	34.73	198.3	40.08	219.8	42.27
	33	111.7	20.11	133.2	25.24	154.7	30.84	165.8	33.87	176.9	37.00	198.3	42.24	219.8	44.31
	35	111.7	21.35	133.2	26.76	154.7	32.83	165.8	36.06	176.9	39.47	198.3	44.78	217.5	46.82
	37	111.7	22.58	133.2	28.45	154.7	34.82	165.8	38.33	176.9	41.94	198.3	47.26	213.9	49.00
	39	111.7	23.87	133.2	30.08	154.7	37.25	165.8	41.21	176.9	45.07	198.3	49.93	210.4	51.69
	41	108.9	26.40	129.8	33.33	150.7	40.88	161.5	45.17	172.3	49.52	193.2	53.70	201.6	54.93
	43	106.2	29.06	126.6	36.37	147.0	44.62	157.5	49.23	168.1	54.12	188.5	57.51	193.3	58.80
46	99.5	32.33	118.6	40.97	137.7	50.28	147.6	54.79	157.5	61.07	172.4	64.23	176.4	64.48	
48	88.0	28.24	104.9	35.82	121.8	43.97	130.6	47.86	139.3	53.45	149.7	54.60	153.3	55.04	

# 7. Capacity Tables

Cooling Capacity (74HP)

Combination (%)	Outdoor air temp. (DB, °C)	Indoor air temp. (DB/WB, °C)													
		20		23		26		27		28		30		32	
		14		16		18		19		20		22		24	
		TC	PI	TC	PI	TC	PI	TC	PI	TC	PI	TC	PI	TC	PI
70	10	97.7	12.08	116.9	14.37	135.4	16.65	145.0	17.98	154.7	19.22	173.2	21.88	192.4	24.48
	12	97.7	12.27	116.9	14.56	135.4	17.03	145.0	18.27	154.7	19.60	173.2	22.26	192.4	24.93
	14	97.7	12.46	116.9	14.75	135.4	17.32	145.0	18.55	154.7	19.88	173.2	22.74	192.4	25.39
	16	97.7	12.65	116.9	15.03	135.4	17.60	145.0	18.93	154.7	20.26	173.2	23.12	192.4	25.94
	18	97.7	12.84	116.9	15.32	135.4	17.98	145.0	19.31	154.7	20.65	173.2	23.50	192.4	26.40
	20	97.7	13.03	116.9	15.60	135.4	18.27	145.0	19.69	154.7	21.12	173.2	24.07	192.4	27.40
	21	97.7	13.22	116.9	15.70	135.4	18.46	145.0	19.88	154.7	21.31	173.2	24.45	192.4	27.98
	23	97.7	13.41	116.9	16.08	135.4	18.84	145.0	20.55	154.7	22.36	173.2	26.16	192.4	29.54
	25	97.7	13.61	116.9	16.65	135.4	20.07	145.0	21.98	154.7	23.88	173.2	27.97	192.4	30.98
	27	97.7	14.37	116.9	17.79	135.4	21.41	145.0	23.31	154.7	25.50	173.2	29.87	192.4	32.92
	29	97.7	15.32	116.9	18.84	135.4	22.74	145.0	24.83	154.7	27.12	173.2	31.87	192.4	35.27
	31	97.7	16.27	116.9	20.07	135.4	24.26	145.0	26.54	154.7	28.92	173.2	33.97	192.4	37.43
	33	97.7	17.22	116.9	21.22	135.4	25.78	145.0	28.16	154.7	30.73	173.2	36.15	192.4	39.84
	35	97.7	18.17	116.9	22.65	135.4	27.40	145.0	29.97	154.7	32.73	173.2	38.53	192.4	42.25
	37	97.7	19.31	116.9	23.99	135.4	29.11	145.0	31.87	154.7	34.82	173.2	41.01	192.4	44.59
	39	97.7	20.51	116.9	25.57	135.4	31.13	145.0	34.29	154.7	37.61	173.2	43.89	192.4	48.07
	41	95.2	22.67	113.9	28.02	132.0	34.15	141.3	37.61	150.7	40.89	168.7	48.20	187.5	51.85
	43	92.8	24.68	111.1	30.53	128.7	37.26	137.8	41.01	147.0	44.65	164.6	52.66	182.8	56.06
46	87.0	27.43	104.1	34.33	120.6	41.96	129.2	45.68	137.7	50.34	154.2	59.39	171.3	62.49	
48	77.0	23.94	92.1	29.99	106.7	36.68	114.3	39.92	121.8	44.04	136.4	51.97	151.6	54.08	
60	10	83.6	10.49	99.9	12.31	116.2	14.31	124.3	15.36	132.5	16.31	148.7	18.51	165.0	20.70
	12	83.6	10.68	99.9	12.50	116.2	14.50	124.3	15.55	132.5	16.60	148.7	18.79	165.0	21.08
	14	83.6	10.78	99.9	12.69	116.2	14.79	124.3	15.84	132.5	16.89	148.7	19.18	165.0	21.46
	16	83.6	10.97	99.9	12.97	116.2	14.98	124.3	16.12	132.5	17.27	148.7	19.56	165.0	21.85
	18	83.6	11.16	99.9	13.17	116.2	15.26	124.3	16.41	132.5	17.55	148.7	19.84	165.0	22.32
	20	83.6	11.35	99.9	13.36	116.2	15.55	124.3	16.69	132.5	17.84	148.7	20.22	165.0	22.80
	21	83.6	11.45	99.9	13.45	116.2	15.74	124.3	16.89	132.5	18.03	148.7	20.51	165.0	22.99
	23	83.6	11.64	99.9	13.74	116.2	15.93	124.3	17.17	132.5	18.41	148.7	21.27	165.0	24.42
	25	83.6	11.83	99.9	14.02	116.2	16.60	124.3	18.03	132.5	19.56	148.7	22.71	165.0	26.14
	27	83.6	12.21	99.9	14.79	116.2	17.65	124.3	19.18	132.5	20.80	148.7	24.14	165.0	27.86
	29	83.6	12.97	99.9	15.74	116.2	18.79	124.3	20.42	132.5	22.13	148.7	25.76	165.0	29.76
	31	83.6	13.74	99.9	16.69	116.2	19.94	124.3	21.75	132.5	23.56	148.7	27.48	165.0	31.67
	33	83.6	14.50	99.9	17.65	116.2	21.18	124.3	23.09	132.5	25.09	148.7	29.19	165.0	33.77
	35	83.6	15.36	99.9	18.79	116.2	22.51	124.3	24.52	132.5	26.62	148.7	31.10	165.0	35.87
	37	83.6	16.22	99.9	19.83	116.2	23.85	124.3	26.04	132.5	28.24	148.7	33.01	165.0	38.16
	39	83.6	17.25	99.9	21.12	116.2	25.74	124.3	27.94	132.5	30.39	148.7	35.39	165.0	40.89
	41	81.5	18.71	97.3	23.11	113.2	27.96	121.1	30.52	129.1	32.99	144.9	38.84	160.8	44.44
	43	79.5	20.33	94.9	25.16	110.4	30.48	118.1	33.26	125.9	35.97	141.3	42.40	156.8	48.54
46	74.5	22.77	89.0	28.25	103.5	34.28	110.7	37.39	118.0	40.48	132.5	47.78	147.0	55.30	
48	65.9	19.84	78.7	24.66	91.5	29.95	97.9	32.66	104.4	35.37	117.2	41.78	130.0	48.38	
50	10	69.9	9.09	83.6	10.52	96.9	11.96	103.6	12.82	110.3	13.58	123.6	15.31	137.6	17.03
	12	69.9	9.18	83.6	10.62	96.9	12.15	103.6	13.01	110.3	13.87	123.6	15.59	137.6	17.31
	14	69.9	9.28	83.6	10.81	96.9	12.34	103.6	13.20	110.3	14.06	123.6	15.78	137.6	17.60
	16	69.9	9.47	83.6	11.00	96.9	12.53	103.6	13.49	110.3	14.25	123.6	16.07	137.6	17.89
	18	69.9	9.57	83.6	11.10	96.9	12.72	103.6	13.68	110.3	14.54	123.6	16.36	137.6	18.27
	20	69.9	9.66	83.6	11.29	96.9	13.01	103.6	13.87	110.3	14.83	123.6	16.64	137.6	18.65
	21	69.9	9.76	83.6	11.38	96.9	13.11	103.6	14.06	110.3	14.92	123.6	16.84	137.6	18.84
	23	69.9	9.95	83.6	11.57	96.9	13.30	103.6	14.25	110.3	15.21	123.6	17.12	137.6	19.23
	25	69.9	10.04	83.6	11.77	96.9	13.58	103.6	14.54	110.3	15.69	123.6	17.98	137.6	20.57
	27	69.9	10.24	83.6	12.15	96.9	14.35	103.6	15.50	110.3	16.64	123.6	19.23	137.6	21.91
	29	69.9	10.81	83.6	12.91	96.9	15.21	103.6	16.45	110.3	17.70	123.6	20.38	137.6	23.25
	31	69.9	11.38	83.6	13.68	96.9	16.17	103.6	17.41	110.3	18.84	123.6	21.71	137.6	24.78
	33	69.9	12.05	83.6	14.44	96.9	17.12	103.6	18.46	110.3	19.99	123.6	23.05	137.6	26.40
	35	69.9	12.72	83.6	15.31	96.9	18.08	103.6	19.61	110.3	21.14	123.6	24.39	137.6	28.03
	37	69.9	13.49	83.6	16.17	96.9	19.13	103.6	20.76	110.3	22.38	123.6	26.02	137.6	29.75
	39	69.9	14.39	83.6	17.33	96.9	20.50	103.6	22.34	110.3	24.02	123.6	27.71	137.6	32.13
	41	68.1	15.56	81.5	18.76	94.5	22.41	100.9	24.20	107.4	26.02	120.4	30.38	134.1	34.89
	43	66.5	16.91	79.5	20.41	92.1	24.39	98.5	26.35	104.8	28.33	117.4	33.13	130.8	38.07
46	62.3	18.94	74.5	22.88	86.3	27.36	92.3	29.59	98.2	31.81	110.1	37.27	122.6	42.85	
48	55.1	16.50	65.9	19.96	76.4	23.86	81.6	25.83	86.9	27.76	97.4	32.57	108.4	37.46	

**Note**

1. TC: Total Capacity(kW), PI : Power Input(kW, Comp. + Outdoor fan motor)
2. Capacity tables show the average value of conditions which may occur.

# 7. Capacity Tables

◆ ARUM760LTE5

Cooling Capacity (76HP)

Combination (%)	Outdoor air temp. (DB, °C)	Indoor air temp. (DB/WB, °C)													
		20		23		26		27		28		30		32	
		14	16	18	19	20	22	24	TC	PI	TC	PI	TC	PI	
130	10	210.8	22.67	251.0	27.70	269.0	32.13	276.7	32.79	284.5	33.05	298.1	33.31	305.9	33.44
	12	210.8	23.23	251.0	28.69	269.0	33.45	276.7	33.67	284.5	33.94	298.1	34.21	305.9	34.51
	14	210.8	24.01	251.0	29.73	269.0	34.71	276.7	34.97	284.5	35.25	298.1	35.53	305.9	35.84
	16	210.8	24.88	251.0	30.77	269.0	36.27	276.7	36.61	284.5	36.90	298.1	37.23	305.9	37.52
	18	210.8	25.93	251.0	32.54	269.0	37.94	276.7	38.75	284.5	39.06	298.1	39.45	305.9	39.72
	20	210.8	27.07	251.0	34.67	269.0	39.81	276.7	42.63	284.5	42.97	293.8	43.39	301.5	43.69
	21	210.8	27.78	251.0	35.89	269.0	40.64	276.7	45.11	284.5	45.47	292.2	45.92	299.9	46.24
	23	210.8	29.81	251.0	37.76	269.0	42.75	276.7	49.77	280.9	50.17	287.9	50.67	295.6	51.02
	25	210.8	31.83	251.0	39.93	269.0	45.68	273.4	55.20	276.7	55.64	284.5	56.20	292.2	56.58
	27	210.8	34.07	251.0	42.68	265.6	48.67	269.0	60.77	273.4	61.26	280.9	61.86	287.9	62.29
	29	210.8	36.30	251.0	45.63	261.3	52.37	265.1	66.79	269.0	67.19	276.7	67.79	284.5	68.06
	31	210.8	38.73	250.2	48.06	257.0	55.71	261.3	66.51	265.1	66.91	272.4	67.51	280.1	67.77
	33	210.8	41.26	245.9	50.93	253.6	59.75	257.7	65.90	261.3	66.30	269.0	66.89	275.8	67.15
	35	210.8	44.00	241.5	53.33	249.3	64.72	253.6	65.04	257.7	65.43	264.7	66.02	272.4	66.28
	37	210.8	46.92	238.1	55.97	245.9	63.86	249.3	64.18	253.6	64.57	260.5	65.15	268.2	65.40
	39	210.8	49.96	233.9	58.91	241.5	63.01	245.9	63.32	249.3	63.70	257.0	64.27	264.7	64.53
	41	205.4	53.01	224.2	61.86	231.8	62.15	235.3	62.46	239.8	62.84	247.1	63.40	253.8	63.65
	43	200.3	55.90	214.9	60.99	222.3	61.30	225.7	61.61	230.2	61.97	237.3	62.53	243.8	62.78
46	187.7	59.84	196.0	59.71	203.1	60.02	206.3	60.32	210.6	60.68	217.2	61.22	223.2	61.46	
48	166.1	58.17	170.2	58.34	176.6	58.47	179.4	58.63	183.2	59.13	189.1	59.51	194.4	59.74	
120	10	190.7	20.39	226.8	25.00	247.8	29.71	255.4	32.11	262.9	32.62	277.2	32.75	284.0	33.01
	12	190.7	20.94	226.8	25.85	247.8	30.90	255.4	32.79	262.9	33.82	277.2	34.23	284.0	34.51
	14	190.7	21.66	226.8	26.73	247.8	32.15	255.4	34.03	262.9	35.06	277.2	35.58	284.0	35.86
	16	190.7	22.44	226.8	27.82	247.8	33.40	255.4	35.30	262.9	36.69	277.2	37.13	284.0	37.43
	18	190.7	23.32	226.8	29.07	247.8	34.73	255.4	37.16	262.9	38.57	277.2	39.00	284.0	39.32
	20	190.7	24.21	226.8	30.82	247.8	36.60	255.4	39.11	262.9	40.61	277.2	41.14	284.0	41.47
	21	190.7	24.94	226.8	31.94	247.8	37.63	255.4	40.25	262.9	41.94	277.2	42.48	284.0	42.82
	23	190.7	26.66	226.8	34.17	247.8	40.32	255.4	42.78	262.9	44.72	277.2	45.17	284.0	45.53
	25	190.7	28.49	226.8	36.60	247.8	42.52	255.4	45.60	262.9	47.95	273.9	48.35	280.6	48.74
	27	190.7	30.42	226.8	39.13	247.8	45.25	255.4	48.72	262.9	51.53	269.7	51.88	276.4	52.30
	29	190.7	32.44	226.8	41.77	247.8	47.62	255.4	52.14	258.7	54.92	265.4	55.75	273.0	56.19
	31	190.7	34.57	226.8	44.61	247.8	50.08	252.1	55.86	255.4	58.92	262.1	59.96	268.8	60.44
	33	190.7	36.80	226.8	47.55	244.5	52.98	247.8	60.63	251.1	63.26	257.9	63.98	264.6	64.49
	35	190.7	39.13	226.8	50.69	240.3	56.07	243.6	66.79	247.8	67.12	254.6	67.32	261.2	67.86
	37	190.7	42.09	226.8	53.49	236.8	59.78	240.3	65.38	243.6	65.71	250.3	65.91	257.1	66.43
	39	190.7	45.32	226.0	56.54	232.7	63.41	236.0	64.04	239.4	64.36	247.0	64.55	253.7	65.06
	41	185.8	48.54	216.1	59.58	223.4	62.16	226.6	62.70	229.9	63.01	236.5	63.20	243.2	63.70
	43	181.2	51.81	207.1	58.73	214.2	60.76	217.3	61.35	220.5	61.66	227.0	61.84	233.6	62.34
46	169.9	55.71	188.8	57.33	195.6	58.86	198.5	59.34	201.6	59.64	207.6	59.81	213.8	60.29	
48	150.3	54.57	163.9	56.31	170.0	57.71	172.6	58.06	175.3	58.24	180.7	58.48	186.1	58.71	
110	10	170.8	18.34	203.7	22.36	227.5	26.55	234.0	28.74	248.9	30.93	254.6	31.79	271.8	32.32
	12	170.8	18.91	203.7	23.11	227.5	27.65	234.0	29.55	248.9	32.09	254.6	33.13	271.8	33.89
	14	170.8	19.50	203.7	24.15	227.5	28.91	234.0	31.02	248.9	33.71	254.6	34.67	271.8	35.40
	16	170.8	20.20	203.7	25.03	227.5	30.10	234.0	32.37	248.9	35.26	254.6	36.23	271.8	36.86
	18	170.8	20.94	203.7	26.07	227.5	31.83	234.0	34.09	248.9	37.20	254.6	37.94	271.8	38.64
	20	170.8	21.69	203.7	27.37	227.5	33.76	234.0	35.65	248.9	39.00	254.6	39.97	271.8	40.61
	21	170.8	22.17	203.7	28.19	227.5	34.63	234.0	36.61	248.9	40.09	254.6	41.10	271.8	41.74
	23	170.8	23.62	203.7	30.21	227.5	36.56	234.0	38.65	248.9	42.35	254.6	43.26	271.8	43.98
	25	170.8	25.24	203.7	32.24	227.5	38.62	234.0	40.86	248.9	44.75	254.6	45.39	268.5	46.32
	27	170.8	26.97	203.7	34.47	227.5	40.82	234.0	43.25	248.9	46.74	254.6	47.80	264.6	48.62
	29	170.8	28.79	203.7	36.80	227.5	43.13	234.0	45.80	248.9	49.39	254.6	50.24	261.2	51.00
	31	170.8	30.62	203.7	39.24	227.5	45.58	234.0	48.53	244.8	51.90	251.3	52.91	257.1	53.47
	33	170.8	32.65	203.7	41.77	227.5	48.16	234.0	51.42	241.4	54.80	247.3	55.71	253.8	56.02
	35	170.8	34.67	203.7	44.61	227.5	50.86	234.0	54.49	237.4	57.84	243.1	58.37	249.7	58.66
	37	170.8	36.75	203.7	47.34	227.5	53.69	230.8	57.73	233.3	61.00	239.9	61.21	245.6	61.39
	39	170.8	39.62	203.7	50.31	223.4	56.65	226.6	61.75	230.0	64.03	235.7	64.13	242.3	64.20
	41	166.5	42.49	198.5	53.28	213.8	59.74	217.2	66.79	220.0	66.79	226.4	67.32	232.1	67.86
	43	162.4	44.62	193.6	55.51	204.9	63.35	208.3	64.07	211.0	63.93	217.3	64.29	222.8	64.47
46	152.2	43.55	181.4	53.59	187.0	60.12	190.2	60.12	192.7	60.64	198.6	60.98	203.7	61.14	
48	134.6	42.29	157.7	51.62	162.4	57.20	165.4	57.59	167.5	57.86	172.7	58.03	177.3	58.26	

# 7. Capacity Tables

Cooling Capacity (76HP)

Combination (%)	Outdoor air temp. (DB, °C)	Indoor air temp. (DB/WB, °C)													
		20		23		26		27		28		30		32	
		14		16		18		19		20		22		24	
		TC	PI	TC	PI	TC	PI	TC	PI	TC	PI	TC	PI	TC	PI
100	10	143.6	16.52	171.0	20.07	199.1	23.82	212.8	25.73	226.5	27.65	251.1	30.78	256.6	31.02
	12	143.6	17.04	171.0	20.89	199.1	24.62	212.8	26.43	226.5	28.53	251.1	32.43	256.6	32.75
	14	143.6	17.58	171.0	21.73	199.1	25.66	212.8	27.57	226.5	29.76	251.1	34.25	256.6	34.57
	16	143.6	18.11	171.0	22.45	199.1	26.75	212.8	28.88	226.5	31.36	251.1	35.90	256.6	36.40
	18	143.6	18.65	171.0	23.28	199.1	27.79	212.8	30.29	226.5	33.25	251.1	37.93	256.6	38.23
	20	143.6	19.31	171.0	24.16	199.1	29.40	212.8	32.44	226.5	35.59	251.1	39.75	256.6	40.06
	21	143.6	19.72	171.0	24.74	199.1	30.42	212.8	33.56	226.5	36.90	251.1	40.65	256.6	40.98
	23	143.6	20.89	171.0	26.46	199.1	32.65	212.8	35.99	226.5	39.54	251.1	42.57	256.6	42.91
	25	143.6	22.20	171.0	28.19	199.1	34.88	212.8	38.53	226.5	42.28	251.1	44.39	254.4	44.74
	27	143.6	23.72	171.0	30.11	199.1	37.31	212.8	41.16	226.5	44.95	246.2	46.47	251.4	46.85
	29	143.6	25.24	171.0	32.14	199.1	39.84	212.8	44.00	226.5	47.57	241.6	48.35	247.6	48.73
	31	143.6	26.97	171.0	34.27	199.1	42.48	212.8	46.94	226.5	49.99	238.0	50.22	243.8	50.62
	33	143.6	28.59	171.0	36.50	199.1	45.32	212.8	50.08	226.5	51.87	234.2	52.09	240.0	52.51
	35	143.6	30.42	171.0	38.83	199.1	48.26	212.8	53.43	223.0	53.75	229.9	53.96	235.8	54.39
	37	143.6	32.57	171.0	41.65	199.1	51.12	212.8	55.97	219.4	56.25	225.7	56.47	231.0	57.00
	39	143.6	34.92	171.0	44.74	199.1	54.17	212.8	58.71	215.7	58.97	222.1	59.19	227.2	59.74
	41	141.4	37.27	168.3	47.83	196.0	57.22	204.2	61.44	208.7	61.69	213.6	61.91	220.5	62.49
	43	136.5	39.45	162.5	50.71	189.2	59.96	195.8	63.80	198.0	64.02	204.1	64.23	209.5	64.84
46	127.9	42.43	152.3	54.66	177.3	63.59	178.8	66.79	180.7	66.98	186.5	67.18	191.5	67.82	
48	113.2	36.64	134.7	47.29	153.1	54.37	155.3	56.67	157.0	56.85	162.1	56.98	166.5	57.44	
90	10	129.2	15.33	154.3	18.43	179.4	21.72	191.5	23.42	203.7	25.20	228.8	28.21	253.8	31.02
	12	129.2	15.52	154.3	18.71	179.4	22.10	191.5	23.89	203.7	25.77	228.8	28.77	253.8	31.93
	14	129.2	15.80	154.3	19.09	179.4	22.57	191.5	24.36	203.7	26.24	228.8	29.33	253.8	32.57
	16	129.2	16.08	154.3	19.47	179.4	23.04	191.5	24.83	203.7	26.71	228.8	29.88	253.8	33.13
	18	129.2	16.36	154.3	19.84	179.4	23.42	191.5	25.39	203.7	27.27	228.8	30.54	253.8	34.79
	20	129.2	16.64	154.3	20.22	179.4	23.89	191.5	25.86	203.7	28.31	228.8	32.68	253.8	36.46
	21	129.2	16.83	154.3	20.41	179.4	24.36	191.5	26.71	203.7	29.34	228.8	33.21	253.8	37.29
	23	129.2	17.21	154.3	21.25	179.4	26.05	191.5	28.68	203.7	31.41	228.8	35.22	250.4	39.05
	25	129.2	18.06	154.3	22.66	179.4	27.84	191.5	30.66	203.7	33.57	228.8	37.66	246.7	40.72
	27	129.2	19.28	154.3	24.17	179.4	29.72	191.5	32.73	203.7	35.92	228.8	40.04	243.1	42.63
	29	129.2	20.41	154.3	25.77	179.4	31.79	191.5	34.98	203.7	38.37	228.8	42.41	239.5	44.35
	31	129.2	21.72	154.3	27.46	179.4	33.85	191.5	37.24	203.7	40.91	228.8	44.53	235.9	46.07
	33	129.2	23.13	154.3	29.25	179.4	36.11	191.5	39.68	203.7	43.39	228.8	46.68	232.3	47.78
	35	129.2	24.54	154.3	31.03	179.4	38.37	191.5	42.32	203.7	46.01	224.8	49.36	228.7	50.49
	37	129.2	26.05	154.3	33.01	179.4	40.91	191.5	44.95	203.7	48.57	221.2	51.60	225.0	52.75
	39	129.2	27.58	154.3	35.11	179.4	43.30	191.5	47.84	203.7	51.07	217.6	54.40	221.4	55.05
	41	125.9	30.86	150.3	38.92	174.8	47.52	186.6	52.32	198.5	55.14	208.5	57.33	212.2	58.64
	43	122.8	33.31	146.6	42.06	170.4	51.91	182.0	56.34	193.6	59.12	199.9	61.35	203.5	62.13
46	115.1	37.49	137.4	47.90	159.7	59.15	170.6	63.88	175.9	65.68	182.5	67.03	185.9	67.31	
48	101.8	32.77	121.5	41.90	141.3	51.75	150.9	55.72	152.7	56.45	158.6	56.98	161.6	57.44	
80	10	114.8	14.30	136.8	17.17	158.8	20.15	170.2	21.74	181.6	23.33	203.7	26.61	225.7	28.89
	12	114.8	14.59	136.8	17.37	158.8	20.55	170.2	22.14	181.6	23.73	203.7	27.10	225.7	29.46
	14	114.8	14.79	136.8	17.77	158.8	20.85	170.2	22.53	181.6	24.12	203.7	27.60	225.7	30.03
	16	114.8	14.99	136.8	18.07	158.8	21.24	170.2	22.93	181.6	24.62	203.7	28.19	225.7	30.60
	18	114.8	15.29	136.8	18.37	158.8	21.64	170.2	23.33	181.6	25.12	203.7	28.69	225.7	31.27
	20	114.8	15.59	136.8	18.76	158.8	22.14	170.2	23.83	181.6	25.61	203.7	29.78	225.7	33.13
	21	114.8	15.69	136.8	18.96	158.8	22.34	170.2	24.12	181.6	26.21	203.7	30.72	225.7	34.01
	23	114.8	15.98	136.8	19.26	158.8	23.33	170.2	25.61	181.6	28.00	203.7	32.44	225.7	35.69
	25	114.8	16.58	136.8	20.55	158.8	25.02	170.2	27.40	181.6	29.98	203.7	34.71	225.7	38.16
	27	114.8	17.57	136.8	21.84	158.8	26.70	170.2	29.29	181.6	31.97	203.7	36.89	225.7	40.15
	29	114.8	18.66	136.8	23.33	158.8	28.39	170.2	31.17	181.6	34.15	203.7	39.52	225.7	42.13
	31	114.8	19.85	136.8	24.72	158.8	30.28	170.2	33.26	181.6	36.33	203.7	41.94	225.7	44.22
	33	114.8	21.05	136.8	26.41	158.8	32.26	170.2	35.44	181.6	38.72	203.7	44.19	225.7	46.35
	35	114.8	22.34	136.8	28.00	158.8	34.35	170.2	37.72	181.6	41.30	203.7	46.85	223.3	48.98
	37	114.8	23.63	136.8	29.76	158.8	36.43	170.2	40.11	181.6	43.88	203.7	49.45	219.7	51.26
	39	114.8	24.97	136.8	31.47	158.8	38.97	170.2	43.12	181.6	47.15	203.7	52.24	216.1	54.08
	41	111.8	27.62	133.3	34.87	154.8	42.77	165.9	47.26	177.0	51.81	198.5	56.18	207.0	57.47
	43	109.1	30.41	130.0	38.05	150.9	46.69	161.8	51.51	172.6	56.62	193.6	60.13	198.5	61.51
46	102.2	33.83	121.8	42.86	141.5	52.61	151.6	57.33	161.8	63.89	177.0	67.03	181.2	67.31	
48	90.4	29.54	107.8	37.48	125.1	46.01	134.1	50.08	143.1	55.88	153.7	56.98	157.4	57.44	

# 7. Capacity Tables

Cooling Capacity (76HP)

Combination (%)	Outdoor air temp. (DB, °C)	Indoor air temp. (DB/WB, °C)													
		20		23		26		27		28		30		32	
		14		16		18		19		20		22		24	
		TC	PI	TC	PI	TC	PI	TC	PI	TC	PI	TC	PI	TC	PI
70	10	100.3	12.64	120.1	15.03	139.1	17.42	149.0	18.82	158.8	20.11	177.8	22.90	197.6	25.61
	12	100.3	12.84	120.1	15.23	139.1	17.82	149.0	19.12	158.8	20.51	177.8	23.30	197.6	26.09
	14	100.3	13.04	120.1	15.43	139.1	18.12	149.0	19.41	158.8	20.81	177.8	23.79	197.6	26.57
	16	100.3	13.24	120.1	15.73	139.1	18.42	149.0	19.81	158.8	21.21	177.8	24.19	197.6	27.14
	18	100.3	13.44	120.1	16.03	139.1	18.82	149.0	20.21	158.8	21.60	177.8	24.59	197.6	27.62
	20	100.3	13.64	120.1	16.33	139.1	19.12	149.0	20.61	158.8	22.10	177.8	25.19	197.6	28.67
	21	100.3	13.84	120.1	16.43	139.1	19.31	149.0	20.81	158.8	22.30	177.8	25.59	197.6	29.28
	23	100.3	14.04	120.1	16.83	139.1	19.71	149.0	21.50	158.8	23.40	177.8	27.38	197.6	30.92
	25	100.3	14.24	120.1	17.42	139.1	21.01	149.0	23.00	158.8	24.99	177.8	29.27	197.6	32.42
	27	100.3	15.03	120.1	18.62	139.1	22.40	149.0	24.39	158.8	26.68	177.8	31.26	197.6	34.45
	29	100.3	16.03	120.1	19.71	139.1	23.79	149.0	25.98	158.8	28.37	177.8	33.35	197.6	36.91
	31	100.3	17.02	120.1	21.01	139.1	25.39	149.0	27.78	158.8	30.27	177.8	35.54	197.6	39.17
	33	100.3	18.02	120.1	22.20	139.1	26.98	149.0	29.47	158.8	32.16	177.8	37.83	197.6	41.69
	35	100.3	19.02	120.1	23.70	139.1	28.67	149.0	31.36	158.8	34.25	177.8	40.32	197.6	44.21
	37	100.3	20.21	120.1	25.10	139.1	30.46	149.0	33.35	158.8	36.44	177.8	42.91	197.6	46.66
	39	100.3	21.46	120.1	26.76	139.1	32.57	149.0	35.88	158.8	39.36	177.8	45.92	197.6	50.30
41	97.8	23.73	117.0	29.32	135.5	35.73	145.1	39.36	154.8	42.79	173.3	50.44	192.5	54.26	
43	95.3	25.83	114.1	31.95	132.2	38.99	141.6	42.92	150.9	46.73	169.0	55.10	187.8	58.67	
46	89.3	28.70	106.9	35.93	123.9	43.90	132.7	47.80	141.5	52.67	158.4	62.15	176.0	65.39	
48	79.0	25.05	94.6	31.38	109.6	38.38	117.4	41.78	125.1	46.08	140.1	54.38	155.7	56.49	
60	10	85.9	10.98	102.6	12.88	119.3	14.98	127.7	16.07	136.0	17.07	152.8	19.37	169.5	21.67
	12	85.9	11.18	102.6	13.08	119.3	15.18	127.7	16.27	136.0	17.37	152.8	19.67	169.5	22.07
	14	85.9	11.28	102.6	13.28	119.3	15.48	127.7	16.57	136.0	17.67	152.8	20.07	169.5	22.46
	16	85.9	11.48	102.6	13.58	119.3	15.68	127.7	16.87	136.0	18.07	152.8	20.47	169.5	22.86
	18	85.9	11.68	102.6	13.78	119.3	15.97	127.7	17.17	136.0	18.37	152.8	20.77	169.5	23.36
	20	85.9	11.88	102.6	13.98	119.3	16.27	127.7	17.47	136.0	18.67	152.8	21.17	169.5	23.86
	21	85.9	11.98	102.6	14.08	119.3	16.47	127.7	17.67	136.0	18.87	152.8	21.47	169.5	24.06
	23	85.9	12.18	102.6	14.38	119.3	16.67	127.7	17.97	136.0	19.27	152.8	22.26	169.5	25.56
	25	85.9	12.38	102.6	14.68	119.3	17.37	127.7	18.87	136.0	20.47	152.8	23.76	169.5	27.36
	27	85.9	12.78	102.6	15.48	119.3	18.47	127.7	20.07	136.0	21.77	152.8	25.26	169.5	29.15
	29	85.9	13.58	102.6	16.47	119.3	19.67	127.7	21.37	136.0	23.16	152.8	26.96	169.5	31.15
	31	85.9	14.38	102.6	17.47	119.3	20.87	127.7	22.76	136.0	24.66	152.8	28.75	169.5	33.15
	33	85.9	15.18	102.6	18.47	119.3	22.17	127.7	24.16	136.0	26.26	152.8	30.55	169.5	35.34
	35	85.9	16.07	102.6	19.67	119.3	23.56	127.7	25.66	136.0	27.86	152.8	32.55	169.5	37.54
	37	85.9	16.97	102.6	20.76	119.3	24.96	127.7	27.26	136.0	29.55	152.8	34.55	169.5	39.94
	39	85.9	18.05	102.6	22.10	119.3	26.94	127.7	29.24	136.0	31.80	152.8	37.04	169.5	42.80
41	83.7	19.58	100.0	24.19	116.3	29.26	124.4	31.95	132.6	34.52	148.9	40.65	165.1	46.51	
43	81.6	21.27	97.5	26.33	113.4	31.89	121.3	34.81	129.3	37.65	145.2	44.37	161.1	50.80	
46	76.5	23.83	91.4	29.57	106.3	35.87	113.7	39.13	121.2	42.36	136.0	50.00	150.9	57.87	
48	67.7	20.76	80.8	25.80	94.0	31.34	100.6	34.18	107.2	37.02	120.3	43.73	133.5	50.64	
50	10	71.8	9.51	85.9	11.01	99.6	12.52	106.4	13.42	113.2	14.22	126.9	16.02	141.4	17.82
	12	71.8	9.61	85.9	11.11	99.6	12.72	106.4	13.62	113.2	14.52	126.9	16.32	141.4	18.12
	14	71.8	9.71	85.9	11.31	99.6	12.92	106.4	13.82	113.2	14.72	126.9	16.52	141.4	18.42
	16	71.8	9.91	85.9	11.51	99.6	13.12	106.4	14.12	113.2	14.92	126.9	16.82	141.4	18.72
	18	71.8	10.01	85.9	11.61	99.6	13.32	106.4	14.32	113.2	15.22	126.9	17.12	141.4	19.12
	20	71.8	10.11	85.9	11.82	99.6	13.62	106.4	14.52	113.2	15.52	126.9	17.42	141.4	19.52
	21	71.8	10.21	85.9	11.92	99.6	13.72	106.4	14.72	113.2	15.62	126.9	17.62	141.4	19.73
	23	71.8	10.41	85.9	12.12	99.6	13.92	106.4	14.92	113.2	15.92	126.9	17.92	141.4	20.13
	25	71.8	10.51	85.9	12.32	99.6	14.22	106.4	15.22	113.2	16.42	126.9	18.82	141.4	21.53
	27	71.8	10.71	85.9	12.72	99.6	15.02	106.4	16.22	113.2	17.42	126.9	20.13	141.4	22.93
	29	71.8	11.31	85.9	13.52	99.6	15.92	106.4	17.22	113.2	18.52	126.9	21.33	141.4	24.33
	31	71.8	11.92	85.9	14.32	99.6	16.92	106.4	18.22	113.2	19.73	126.9	22.73	141.4	25.93
	33	71.8	12.62	85.9	15.12	99.6	17.92	106.4	19.32	113.2	20.93	126.9	24.13	141.4	27.64
	35	71.8	13.32	85.9	16.02	99.6	18.92	106.4	20.53	113.2	22.13	126.9	25.53	141.4	29.34
	37	71.8	14.12	85.9	16.92	99.6	20.03	106.4	21.73	113.2	23.43	126.9	27.23	141.4	31.14
	39	71.8	15.06	85.9	18.14	99.6	21.46	106.4	23.39	113.2	25.14	126.9	29.01	141.4	33.63
41	70.0	16.28	83.7	19.63	97.0	23.46	103.7	25.33	110.3	27.24	123.7	31.80	137.7	36.52	
43	68.3	17.70	81.6	21.36	94.6	25.53	101.1	27.58	107.6	29.65	120.6	34.67	134.3	39.84	
46	64.0	19.82	76.5	23.95	88.7	28.64	94.8	30.97	100.8	33.29	113.0	39.01	125.9	44.86	
48	56.6	17.27	67.7	20.89	78.4	24.98	83.8	27.03	89.2	29.06	100.0	34.09	111.4	39.21	

**Note**

1. TC: Total Capacity(kW), PI : Power Input(kW, Comp. + Outdoor fan motor)
2. Capacity tables show the average value of conditions which may occur.

# 7. Capacity Tables

◆ ARUM780LTE5

Cooling Capacity (78HP)

Combination (%)	Outdoor air temp. (DB, °C)	Indoor air temp. (DB/WB, °C)													
		20		23		26		27		28		30		32	
		14		16		18		19		20		22		24	
		TC	PI	TC	PI	TC	PI	TC	PI	TC	PI	TC	PI	TC	PI
130	10	216.3	22.72	257.6	27.77	276.1	32.21	284.0	32.87	291.9	33.13	306.0	33.39	313.9	33.52
	12	216.3	23.28	257.6	28.76	276.1	33.53	284.0	33.75	291.9	34.02	306.0	34.29	313.9	34.60
	14	216.3	24.06	257.6	29.80	276.1	34.80	284.0	35.05	291.9	35.33	306.0	35.61	313.9	35.93
	16	216.3	24.94	257.6	30.84	276.1	36.36	284.0	36.69	291.9	36.99	306.0	37.32	313.9	37.61
	18	216.3	25.99	257.6	32.62	276.1	38.03	284.0	38.85	291.9	39.16	306.0	39.54	313.9	39.82
	20	216.3	27.14	257.6	34.76	276.1	39.90	284.0	42.73	291.9	43.07	301.6	43.50	309.5	43.80
	21	216.3	27.85	257.6	35.98	276.1	40.74	284.0	45.22	291.9	45.58	299.9	46.03	307.8	46.35
	23	216.3	29.88	257.6	37.85	276.1	42.86	284.0	49.90	288.2	50.30	295.4	50.79	303.4	51.14
	25	216.3	31.91	257.6	40.02	276.1	45.79	280.6	55.34	284.0	55.78	291.9	56.33	299.9	56.72
	27	216.3	34.15	257.6	42.78	272.6	48.79	276.1	60.92	280.6	61.41	288.2	62.02	295.4	62.44
	29	216.3	36.38	257.6	45.74	268.2	52.50	272.1	66.95	276.1	67.35	284.0	67.95	291.9	68.22
	31	216.3	38.82	256.8	48.18	263.7	55.84	268.2	66.67	272.1	67.07	279.6	67.67	287.5	67.94
	33	216.3	41.36	252.3	51.05	260.3	59.89	264.5	66.06	268.2	66.46	276.1	67.05	283.1	67.32
	35	216.3	44.11	247.9	53.46	255.8	64.87	260.3	65.20	264.5	65.59	271.7	66.18	279.6	66.44
	37	216.3	47.04	244.4	56.10	252.3	64.02	255.8	64.34	260.3	64.72	267.3	65.30	275.3	65.56
	39	216.3	50.08	240.1	59.06	247.9	63.16	252.3	63.48	255.8	63.86	263.7	64.43	271.7	64.68
	41	210.8	53.13	230.1	62.01	237.9	62.30	241.4	62.62	246.2	62.99	253.6	63.56	260.4	63.81
	43	205.6	56.04	220.5	61.14	228.2	61.45	231.7	61.76	236.3	62.13	243.6	62.68	250.2	62.93
46	192.7	59.98	201.2	59.86	208.5	60.16	211.7	60.46	216.1	60.83	222.9	61.37	229.1	61.61	
48	170.4	58.31	174.7	58.48	181.2	58.61	184.1	58.77	188.1	59.27	194.1	59.65	199.5	59.89	
120	10	195.7	20.44	232.7	25.06	254.3	29.78	262.1	32.18	269.8	32.69	284.5	32.83	291.4	33.09
	12	195.7	20.99	232.7	25.91	254.3	30.98	262.1	32.87	269.8	33.90	284.5	34.32	291.4	34.59
	14	195.7	21.71	232.7	26.79	254.3	32.23	262.1	34.11	269.8	35.15	284.5	35.67	291.4	35.95
	16	195.7	22.50	232.7	27.88	254.3	33.48	262.1	35.39	269.8	36.77	284.5	37.22	291.4	37.52
	18	195.7	23.38	232.7	29.14	254.3	34.81	262.1	37.25	269.8	38.66	284.5	39.10	291.4	39.41
	20	195.7	24.27	232.7	30.90	254.3	36.69	262.1	39.20	269.8	40.71	284.5	41.24	291.4	41.57
	21	195.7	25.00	232.7	32.01	254.3	37.72	262.1	40.35	269.8	42.04	284.5	42.58	291.4	42.92
	23	195.7	26.73	232.7	34.25	254.3	40.41	262.1	42.88	269.8	44.82	284.5	45.28	291.4	45.64
	25	195.7	28.56	232.7	36.69	254.3	42.63	262.1	45.71	269.8	48.07	281.1	48.47	287.9	48.86
	27	195.7	30.49	232.7	39.23	254.3	45.36	262.1	48.84	269.8	51.66	276.8	52.01	283.7	52.42
	29	195.7	32.52	232.7	41.87	254.3	47.73	262.1	52.26	265.5	55.05	272.4	55.88	280.2	56.33
	31	195.7	34.66	232.7	44.72	254.3	50.21	258.7	55.99	262.1	59.06	269.0	60.11	275.8	60.59
	33	195.7	36.89	232.7	47.67	250.9	53.11	254.3	60.77	257.8	63.41	264.7	64.13	271.6	64.65
	35	195.7	39.23	232.7	50.82	246.6	56.21	250.0	66.95	254.3	67.28	261.3	67.49	268.1	68.02
	37	195.7	42.20	232.7	53.62	243.1	59.93	246.6	65.54	250.0	65.87	256.9	66.07	263.9	66.59
	39	195.7	45.43	231.9	56.67	238.8	63.56	242.3	64.20	245.7	64.52	253.5	64.71	260.3	65.22
	41	190.7	48.66	221.8	59.72	229.3	62.31	232.5	62.85	235.9	63.16	242.7	63.35	249.6	63.86
	43	186.0	51.93	212.5	58.87	219.9	60.91	223.0	61.50	226.3	61.81	233.0	62.00	239.7	62.49
46	174.3	55.84	193.8	57.47	200.8	59.00	203.8	59.48	206.9	59.78	213.1	59.96	219.4	60.44	
48	154.2	54.70	168.2	56.45	174.5	57.85	177.2	58.20	179.9	58.38	185.4	58.62	191.0	58.85	
110	10	175.3	18.39	209.0	22.41	233.5	26.62	240.2	28.81	255.4	31.01	261.3	31.87	279.0	32.40
	12	175.3	18.96	209.0	23.16	233.5	27.72	240.2	29.62	255.4	32.17	261.3	33.21	279.0	33.98
	14	175.3	19.55	209.0	24.21	233.5	28.98	240.2	31.09	255.4	33.79	261.3	34.75	279.0	35.49
	16	175.3	20.25	209.0	25.09	233.5	30.18	240.2	32.45	255.4	35.35	261.3	36.31	279.0	36.95
	18	175.3	21.00	209.0	26.13	233.5	31.91	240.2	34.17	255.4	37.29	261.3	38.03	279.0	38.74
	20	175.3	21.75	209.0	27.44	233.5	33.84	240.2	35.74	255.4	39.10	261.3	40.06	279.0	40.71
	21	175.3	22.23	209.0	28.25	233.5	34.71	240.2	36.70	255.4	40.19	261.3	41.20	279.0	41.85
	23	175.3	23.68	209.0	30.29	233.5	36.65	240.2	38.75	255.4	42.46	261.3	43.37	279.0	44.09
	25	175.3	25.31	209.0	32.32	233.5	38.72	240.2	40.96	255.4	44.86	261.3	45.50	275.6	46.43
	27	175.3	27.03	209.0	34.55	233.5	40.91	240.2	43.35	255.4	46.85	261.3	47.92	271.5	48.73
	29	175.3	28.86	209.0	36.89	233.5	43.24	240.2	45.91	255.4	49.51	261.3	50.36	268.1	51.12
	31	175.3	30.69	209.0	39.33	233.5	45.69	240.2	48.64	251.2	52.02	257.9	53.04	263.9	53.60
	33	175.3	32.73	209.0	41.87	233.5	48.27	240.2	51.55	247.8	54.94	253.8	55.85	260.4	56.16
	35	175.3	34.76	209.0	44.72	233.5	50.98	240.2	54.62	243.6	57.98	249.5	58.51	256.3	58.80
	37	175.3	36.84	209.0	47.46	233.5	53.82	236.9	57.87	239.4	61.15	246.2	61.36	252.0	61.54
	39	175.3	39.72	209.0	50.43	229.3	56.79	232.6	61.90	236.1	64.18	241.9	64.29	248.7	64.35
	41	170.9	42.59	203.7	53.41	219.5	59.89	222.9	66.95	225.8	66.95	232.4	67.49	238.2	68.02
	43	166.6	44.73	198.7	55.64	210.3	63.51	213.8	64.22	216.5	64.08	223.0	64.45	228.6	64.62
46	156.2	43.65	186.2	53.72	191.9	60.27	195.2	60.27	197.8	60.79	203.8	61.12	209.1	61.29	
48	138.1	42.40	161.8	51.75	166.7	57.34	169.7	57.73	171.9	58.01	177.3	58.17	181.9	58.40	

# 7. Capacity Tables

Cooling Capacity (78HP)

Combination (%)	Outdoor air temp. (DB, °C)	Indoor air temp. (DB/WB, °C)													
		20		23		26		27		28		30		32	
		14		16		18		19		20		22		24	
		TC	PI	TC	PI	TC	PI	TC	PI	TC	PI	TC	PI	TC	PI
100	10	147.4	16.56	175.5	20.12	204.4	23.87	218.4	25.79	232.4	27.72	257.7	30.85	263.4	31.10
	12	147.4	17.09	175.5	20.94	204.4	24.68	218.4	26.49	232.4	28.60	257.7	32.51	263.4	32.83
	14	147.4	17.62	175.5	21.78	204.4	25.72	218.4	27.64	232.4	29.83	257.7	34.33	263.4	34.65
	16	147.4	18.16	175.5	22.50	204.4	26.82	218.4	28.95	232.4	31.44	257.7	35.99	263.4	36.49
	18	147.4	18.69	175.5	23.34	204.4	27.86	218.4	30.36	232.4	33.34	257.7	38.02	263.4	38.33
	20	147.4	19.36	175.5	24.22	204.4	29.47	218.4	32.52	232.4	35.67	257.7	39.84	263.4	40.16
	21	147.4	19.76	175.5	24.80	204.4	30.49	218.4	33.64	232.4	36.99	257.7	40.75	263.4	41.08
	23	147.4	20.94	175.5	26.53	204.4	32.73	218.4	36.08	232.4	39.64	257.7	42.67	263.4	43.02
	25	147.4	22.26	175.5	28.25	204.4	34.96	218.4	38.62	232.4	42.38	257.7	44.49	261.1	44.85
	27	147.4	23.78	175.5	30.18	204.4	37.40	218.4	41.26	232.4	45.06	252.0	46.59	258.0	46.96
	29	147.4	25.31	175.5	32.22	204.4	39.94	218.4	44.11	232.4	47.69	248.7	48.46	254.1	48.85
	31	147.4	27.03	175.5	34.35	204.4	42.58	218.4	47.06	232.4	50.11	244.3	50.34	250.2	50.74
	33	147.4	28.66	175.5	36.59	204.4	45.43	218.4	50.21	232.4	52.00	240.3	52.22	246.3	52.63
	35	147.4	30.49	175.5	38.93	204.4	48.38	218.4	53.56	228.9	53.88	236.0	54.09	242.0	54.52
	37	147.4	32.65	175.5	41.75	204.4	51.24	218.4	56.11	225.1	56.39	231.6	56.61	237.1	57.14
	39	147.4	35.01	175.5	44.85	204.4	54.30	218.4	58.85	221.4	59.11	227.9	59.33	233.2	59.89
	41	145.1	37.36	172.7	47.95	201.1	57.36	209.6	61.59	214.2	61.84	219.2	62.06	226.3	62.64
	43	140.1	39.54	166.8	50.83	194.2	60.10	200.9	63.95	203.2	64.18	209.5	64.39	215.0	64.99
46	131.3	42.53	156.3	54.80	182.0	63.75	183.5	66.95	185.4	67.15	191.4	67.34	196.5	67.98	
48	116.1	36.72	138.3	47.41	157.1	54.50	159.4	56.81	161.1	56.99	166.4	57.12	170.9	57.58	
90	10	132.6	15.37	158.3	18.48	184.1	21.78	196.6	23.47	209.0	25.26	234.8	28.28	260.5	31.10
	12	132.6	15.55	158.3	18.76	184.1	22.15	196.6	23.95	209.0	25.83	234.8	28.84	260.5	32.01
	14	132.6	15.84	158.3	19.14	184.1	22.63	196.6	24.42	209.0	26.30	234.8	29.40	260.5	32.65
	16	132.6	16.12	158.3	19.51	184.1	23.10	196.6	24.89	209.0	26.77	234.8	29.96	260.5	33.21
	18	132.6	16.40	158.3	19.89	184.1	23.47	196.6	25.45	209.0	27.34	234.8	30.61	260.5	34.88
	20	132.6	16.69	158.3	20.27	184.1	23.95	196.6	25.92	209.0	28.38	234.8	32.76	260.5	36.55
	21	132.6	16.87	158.3	20.46	184.1	24.42	196.6	26.77	209.0	29.41	234.8	33.29	260.5	37.39
	23	132.6	17.25	158.3	21.31	184.1	26.11	196.6	28.75	209.0	31.49	234.8	35.31	256.9	39.15
	25	132.6	18.10	158.3	22.72	184.1	27.90	196.6	30.73	209.0	33.65	234.8	37.75	253.2	40.82
	27	132.6	19.33	158.3	24.23	184.1	29.79	196.6	32.81	209.0	36.01	234.8	40.14	249.5	42.74
	29	132.6	20.46	158.3	25.83	184.1	31.86	196.6	35.07	209.0	38.46	234.8	42.51	245.8	44.46
	31	132.6	21.78	158.3	27.53	184.1	33.94	196.6	37.33	209.0	41.01	234.8	44.64	242.1	46.18
	33	132.6	23.19	158.3	29.32	184.1	36.20	196.6	39.78	209.0	43.49	234.8	46.79	238.4	47.90
	35	132.6	24.60	158.3	31.11	184.1	38.46	196.6	42.42	209.0	46.12	230.7	49.48	234.7	50.61
	37	132.6	26.11	158.3	33.09	184.1	41.01	196.6	45.07	209.0	48.69	227.0	51.72	231.0	52.88
	39	132.6	27.65	158.3	35.19	184.1	43.41	196.6	47.96	209.0	51.20	223.3	54.53	227.2	55.19
	41	129.2	30.94	154.3	39.02	179.4	47.64	191.5	52.45	203.7	55.27	214.0	57.47	217.8	58.79
	43	126.0	33.39	150.5	42.16	174.9	52.04	186.8	56.48	198.7	59.27	205.2	61.50	208.9	62.28
46	118.1	37.59	141.0	48.02	163.9	59.29	175.1	64.04	180.5	65.84	187.3	67.20	190.8	67.47	
48	104.5	32.85	124.7	42.00	145.0	51.88	154.9	55.86	156.7	56.58	162.8	57.12	165.9	57.58	
80	10	117.8	14.33	140.4	17.22	163.0	20.20	174.7	21.79	186.4	23.39	209.0	26.67	231.7	28.96
	12	117.8	14.63	140.4	17.42	163.0	20.60	174.7	22.19	186.4	23.79	209.0	27.17	231.7	29.53
	14	117.8	14.83	140.4	17.81	163.0	20.90	174.7	22.59	186.4	24.18	209.0	27.67	231.7	30.10
	16	117.8	15.03	140.4	18.11	163.0	21.30	174.7	22.99	186.4	24.68	209.0	28.26	231.7	30.68
	18	117.8	15.33	140.4	18.41	163.0	21.70	174.7	23.39	186.4	25.18	209.0	28.76	231.7	31.35
	20	117.8	15.62	140.4	18.81	163.0	22.19	174.7	23.88	186.4	25.68	209.0	29.86	231.7	33.21
	21	117.8	15.72	140.4	19.01	163.0	22.39	174.7	24.18	186.4	26.27	209.0	30.80	231.7	34.09
	23	117.8	16.02	140.4	19.31	163.0	23.39	174.7	25.68	186.4	28.06	209.0	32.52	231.7	35.78
	25	117.8	16.62	140.4	20.60	163.0	25.08	174.7	27.47	186.4	30.05	209.0	34.80	231.7	38.26
	27	117.8	17.61	140.4	21.89	163.0	26.77	174.7	29.36	186.4	32.05	209.0	36.98	231.7	40.25
	29	117.8	18.71	140.4	23.39	163.0	28.46	174.7	31.25	186.4	34.23	209.0	39.62	231.7	42.24
	31	117.8	19.90	140.4	24.78	163.0	30.35	174.7	33.34	186.4	36.42	209.0	42.04	231.7	44.33
	33	117.8	21.10	140.4	26.47	163.0	32.34	174.7	35.53	186.4	38.81	209.0	44.30	231.7	46.46
	35	117.8	22.39	140.4	28.06	163.0	34.43	174.7	37.82	186.4	41.40	209.0	46.97	229.2	49.10
	37	117.8	23.69	140.4	29.84	163.0	36.52	174.7	40.21	186.4	43.99	209.0	49.57	225.5	51.39
	39	117.8	25.03	140.4	31.55	163.0	39.07	174.7	43.22	186.4	47.27	209.0	52.37	221.8	54.21
	41	114.8	27.69	136.8	34.96	158.8	42.88	170.2	47.38	181.6	51.94	203.7	56.32	212.5	57.61
	43	111.9	30.48	133.4	38.15	154.9	46.81	166.0	51.64	177.2	56.76	198.7	60.27	203.7	61.66
46	104.9	33.91	125.0	42.97	145.2	52.74	155.6	57.47	166.0	64.05	181.7	67.20	185.9	67.47	
48	92.8	29.62	110.6	37.57	128.4	46.12	137.6	50.20	146.9	56.02	157.8	57.12	161.6	57.58	

# 7. Capacity Tables

Cooling Capacity (78HP)

Combination (%)	Outdoor air temp. (DB, °C)	Indoor air temp. (DB/WB, °C)													
		20		23		26		27		28		30		32	
		14		16		18		19		20		22		24	
		TC	PI	TC	PI	TC	PI	TC	PI	TC	PI	TC	PI	TC	PI
70	10	103.0	12.68	123.2	15.07	142.7	17.47	152.9	18.86	163.0	20.16	182.5	22.96	202.8	25.68
	12	103.0	12.87	123.2	15.27	142.7	17.87	152.9	19.16	163.0	20.56	182.5	23.35	202.8	26.16
	14	103.0	13.07	123.2	15.47	142.7	18.16	152.9	19.46	163.0	20.86	182.5	23.85	202.8	26.64
	16	103.0	13.27	123.2	15.77	142.7	18.46	152.9	19.86	163.0	21.26	182.5	24.25	202.8	27.21
	18	103.0	13.47	123.2	16.07	142.7	18.86	152.9	20.26	163.0	21.66	182.5	24.65	202.8	27.69
	20	103.0	13.67	123.2	16.37	142.7	19.16	152.9	20.66	163.0	22.16	182.5	25.25	202.8	28.74
	21	103.0	13.87	123.2	16.47	142.7	19.36	152.9	20.86	163.0	22.36	182.5	25.65	202.8	29.36
	23	103.0	14.07	123.2	16.87	142.7	19.76	152.9	21.56	163.0	23.45	182.5	27.45	202.8	30.99
	25	103.0	14.27	123.2	17.47	142.7	21.06	152.9	23.06	163.0	25.05	182.5	29.34	202.8	32.50
	27	103.0	15.07	123.2	18.66	142.7	22.46	152.9	24.45	163.0	26.75	182.5	31.34	202.8	34.53
	29	103.0	16.07	123.2	19.76	142.7	23.85	152.9	26.05	163.0	28.44	182.5	33.44	202.8	37.00
	31	103.0	17.07	123.2	21.06	142.7	25.45	152.9	27.85	163.0	30.34	182.5	35.63	202.8	39.26
	33	103.0	18.06	123.2	22.26	142.7	27.05	152.9	29.54	163.0	32.24	182.5	37.93	202.8	41.80
	35	103.0	19.06	123.2	23.76	142.7	28.74	152.9	31.44	163.0	34.33	182.5	40.42	202.8	44.32
	37	103.0	20.26	123.2	25.16	142.7	30.54	152.9	33.44	163.0	36.53	182.5	43.02	202.8	46.77
	39	103.0	21.52	123.2	26.83	142.7	32.66	152.9	35.97	163.0	39.46	182.5	46.04	202.8	50.42
41	100.3	23.79	120.1	29.39	139.1	35.82	149.0	39.46	158.8	42.90	177.8	50.57	197.6	54.40	
43	97.8	25.89	117.1	32.03	135.6	39.08	145.3	43.02	154.9	46.84	173.5	55.24	192.7	58.81	
46	91.7	28.77	109.8	36.02	127.1	44.01	136.2	47.92	145.2	52.81	162.5	62.30	180.6	65.55	
48	81.1	25.11	97.1	31.46	112.5	38.48	120.4	41.88	128.4	46.20	143.8	54.52	159.8	56.63	
60	10	88.1	11.01	105.3	12.91	122.5	15.01	131.0	16.11	139.6	17.12	156.8	19.42	173.9	21.72
	12	88.1	11.21	105.3	13.11	122.5	15.21	131.0	16.32	139.6	17.42	156.8	19.72	173.9	22.12
	14	88.1	11.31	105.3	13.31	122.5	15.51	131.0	16.62	139.6	17.72	156.8	20.12	173.9	22.52
	16	88.1	11.51	105.3	13.61	122.5	15.71	131.0	16.92	139.6	18.12	156.8	20.52	173.9	22.92
	18	88.1	11.71	105.3	13.81	122.5	16.01	131.0	17.22	139.6	18.42	156.8	20.82	173.9	23.42
	20	88.1	11.91	105.3	14.01	122.5	16.32	131.0	17.52	139.6	18.72	156.8	21.22	173.9	23.92
	21	88.1	12.01	105.3	14.11	122.5	16.52	131.0	17.72	139.6	18.92	156.8	21.52	173.9	24.12
	23	88.1	12.21	105.3	14.41	122.5	16.72	131.0	18.02	139.6	19.32	156.8	22.32	173.9	25.62
	25	88.1	12.41	105.3	14.71	122.5	17.42	131.0	18.92	139.6	20.52	156.8	23.82	173.9	27.43
	27	88.1	12.81	105.3	15.51	122.5	18.52	131.0	20.12	139.6	21.82	156.8	25.32	173.9	29.23
	29	88.1	13.61	105.3	16.52	122.5	19.72	131.0	21.42	139.6	23.22	156.8	27.02	173.9	31.23
	31	88.1	14.41	105.3	17.52	122.5	20.92	131.0	22.82	139.6	24.72	156.8	28.83	173.9	33.23
	33	88.1	15.21	105.3	18.52	122.5	22.22	131.0	24.22	139.6	26.32	156.8	30.63	173.9	35.43
	35	88.1	16.11	105.3	19.72	122.5	23.62	131.0	25.72	139.6	27.93	156.8	32.63	173.9	37.63
	37	88.1	17.02	105.3	20.81	122.5	25.02	131.0	27.33	139.6	29.63	156.8	34.63	173.9	40.04
	39	88.1	18.10	105.3	22.16	122.5	27.01	131.0	29.32	139.6	31.88	156.8	37.13	173.9	42.90
41	85.9	19.63	102.6	24.25	119.3	29.33	127.7	32.03	136.0	34.61	152.8	40.75	169.5	46.62	
43	83.8	21.33	100.1	26.40	116.4	31.97	124.5	34.90	132.7	37.74	149.0	44.49	165.3	50.92	
46	78.5	23.88	93.8	29.64	109.1	35.96	116.7	39.23	124.3	42.47	139.6	50.13	154.9	58.02	
48	69.4	20.81	83.0	25.87	96.5	31.42	103.2	34.26	110.0	37.11	123.5	43.84	137.0	50.76	
50	10	73.7	9.54	88.1	11.04	102.2	12.55	109.2	13.45	116.2	14.25	130.3	16.06	145.1	17.87
	12	73.7	9.64	88.1	11.14	102.2	12.75	109.2	13.65	116.2	14.55	130.3	16.36	145.1	18.17
	14	73.7	9.74	88.1	11.34	102.2	12.95	109.2	13.85	116.2	14.76	130.3	16.56	145.1	18.47
	16	73.7	9.94	88.1	11.54	102.2	13.15	109.2	14.15	116.2	14.96	130.3	16.86	145.1	18.77
	18	73.7	10.04	88.1	11.64	102.2	13.35	109.2	14.35	116.2	15.26	130.3	17.16	145.1	19.17
	20	73.7	10.14	88.1	11.84	102.2	13.65	109.2	14.55	116.2	15.56	130.3	17.47	145.1	19.57
	21	73.7	10.24	88.1	11.95	102.2	13.75	109.2	14.76	116.2	15.66	130.3	17.67	145.1	19.77
	23	73.7	10.44	88.1	12.15	102.2	13.95	109.2	14.96	116.2	15.96	130.3	17.97	145.1	20.18
	25	73.7	10.54	88.1	12.35	102.2	14.25	109.2	15.26	116.2	16.46	130.3	18.87	145.1	21.58
	27	73.7	10.74	88.1	12.75	102.2	15.06	109.2	16.26	116.2	17.47	130.3	20.18	145.1	22.99
	29	73.7	11.34	88.1	13.55	102.2	15.96	109.2	17.27	116.2	18.57	130.3	21.38	145.1	24.39
	31	73.7	11.95	88.1	14.35	102.2	16.96	109.2	18.27	116.2	19.77	130.3	22.79	145.1	26.00
	33	73.7	12.65	88.1	15.16	102.2	17.97	109.2	19.37	116.2	20.98	130.3	24.19	145.1	27.70
	35	73.7	13.35	88.1	16.06	102.2	18.97	109.2	20.58	116.2	22.18	130.3	25.60	145.1	29.41
	37	73.7	14.15	88.1	16.96	102.2	20.08	109.2	21.78	116.2	23.49	130.3	27.30	145.1	31.22
	39	73.7	15.10	88.1	18.18	102.2	21.51	109.2	23.45	116.2	25.20	130.3	29.08	145.1	33.72
41	71.8	16.33	85.9	19.68	99.6	23.52	106.4	25.39	113.2	27.31	126.9	31.88	141.4	36.62	
43	70.0	17.74	83.8	21.41	97.1	25.59	103.8	27.65	110.4	29.73	123.8	34.76	137.9	39.94	
46	65.6	19.87	78.5	24.01	91.0	28.71	97.3	31.05	103.5	33.38	116.0	39.11	129.2	44.97	
48	58.1	17.32	69.4	20.94	80.5	25.04	86.0	27.10	91.6	29.13	102.6	34.18	114.3	39.31	

**Note**

1. TC: Total Capacity(kW), PI : Power Input(kW, Comp. + Outdoor fan motor)
2. Capacity tables show the average value of conditions which may occur.



# 7. Capacity Tables

◆ ARUM800LTE5

Cooling Capacity (80HP)

Combination (%)	Outdoor air temp. (DB, °C)	Indoor air temp. (DB/WB, °C)													
		20		23		26		27		28		30		32	
		14	16	16	18	18	19	19	20	20	22	22	24	24	
		TC	PI	TC	PI	TC	PI	TC	PI	TC	PI	TC	PI	TC	PI
130	10	221.9	23.45	264.2	28.67	283.2	33.25	291.3	33.93	299.4	34.20	313.8	34.47	322.0	34.61
	12	221.9	24.03	264.2	29.69	283.2	34.62	291.3	34.84	299.4	35.12	313.8	35.40	322.0	35.72
	14	221.9	24.84	264.2	30.77	283.2	35.92	291.3	36.18	299.4	36.47	313.8	36.76	322.0	37.09
	16	221.9	25.75	264.2	31.84	283.2	37.53	291.3	37.88	299.4	38.18	313.8	38.52	322.0	38.83
	18	221.9	26.83	264.2	33.68	283.2	39.26	291.3	40.10	299.4	40.42	313.8	40.82	322.0	41.10
	20	221.9	28.01	264.2	35.88	283.2	41.19	291.3	44.11	299.4	44.46	309.3	44.91	317.4	45.21
	21	221.9	28.75	264.2	37.14	283.2	42.05	291.3	46.68	299.4	47.05	307.6	47.52	315.7	47.85
	23	221.9	30.84	264.2	39.07	283.2	44.24	291.3	51.51	295.6	51.92	303.0	52.43	311.1	52.80
	25	221.9	32.94	264.2	41.32	283.2	47.27	287.8	57.12	291.3	57.58	299.4	58.15	307.6	58.55
	27	221.9	35.25	264.2	44.17	279.6	50.37	283.2	62.89	287.8	63.39	295.6	64.02	303.0	64.46
	29	221.9	37.56	264.2	47.22	275.1	54.20	279.1	69.11	283.2	69.53	291.3	70.15	299.4	70.43
	31	221.9	40.08	263.4	49.74	270.5	57.65	275.1	68.82	279.1	69.24	286.8	69.86	294.9	70.13
	33	221.9	42.70	258.8	52.70	266.9	61.83	271.3	68.19	275.1	68.60	283.2	69.22	290.3	69.49
	35	221.9	45.53	254.3	55.19	262.4	66.97	266.9	67.31	271.3	67.71	278.6	68.32	286.8	68.58
	37	221.9	48.55	250.7	57.92	258.8	66.08	262.4	66.42	266.9	66.82	274.2	67.41	282.3	67.68
	39	221.9	51.70	246.2	60.97	254.3	65.20	258.8	65.53	262.4	65.92	270.5	66.51	278.6	66.77
	41	216.2	54.85	236.0	64.01	244.0	64.32	247.6	64.64	252.5	65.03	260.1	65.61	267.1	65.87
	43	210.8	57.85	226.2	63.11	234.0	63.43	237.6	63.75	242.3	64.13	249.8	64.71	256.6	64.96
46	197.6	61.92	206.3	61.79	213.8	62.10	217.2	62.42	221.7	62.79	228.6	63.35	235.0	63.60	
48	174.8	60.19	179.2	60.37	185.9	60.50	188.8	60.67	192.9	61.19	199.1	61.58	204.6	61.82	
120	10	200.8	21.10	238.7	25.87	260.9	30.74	268.8	33.22	276.8	33.75	291.8	33.89	298.9	34.16
	12	200.8	21.67	238.7	26.74	260.9	31.98	268.8	33.93	276.8	35.00	291.8	35.42	298.9	35.71
	14	200.8	22.42	238.7	27.66	260.9	33.27	268.8	35.21	276.8	36.28	291.8	36.82	298.9	37.11
	16	200.8	23.22	238.7	28.78	260.9	34.56	268.8	36.53	276.8	37.96	291.8	38.43	298.9	38.73
	18	200.8	24.13	238.7	30.08	260.9	35.94	268.8	38.45	276.8	39.91	291.8	40.36	298.9	40.68
	20	200.8	25.05	238.7	31.89	260.9	37.87	268.8	40.47	276.8	42.02	291.8	42.57	298.9	42.91
	21	200.8	25.81	238.7	33.05	260.9	38.94	268.8	41.66	276.8	43.40	291.8	43.96	298.9	44.31
	23	200.8	27.59	238.7	35.36	260.9	41.72	268.8	44.27	276.8	46.27	291.8	46.74	298.9	47.12
	25	200.8	29.48	238.7	37.87	260.9	44.00	268.8	47.18	276.8	49.62	288.3	50.04	295.3	50.44
	27	200.8	31.47	238.7	40.50	260.9	46.82	268.8	50.41	276.8	53.33	283.9	53.69	291.0	54.12
	29	200.8	33.57	238.7	43.22	260.9	49.28	268.8	53.95	272.3	56.83	279.4	57.69	287.4	58.15
	31	200.8	35.78	238.7	46.16	260.9	51.83	265.3	57.80	268.8	60.97	275.9	62.05	282.9	62.54
	33	200.8	38.08	238.7	49.20	257.4	54.82	260.9	62.74	264.4	65.46	271.5	66.20	278.6	66.73
	35	200.8	40.50	238.7	52.46	252.9	58.03	256.4	69.11	260.9	69.46	268.0	69.67	275.0	70.22
	37	200.8	43.56	238.7	55.35	249.3	61.86	252.9	67.66	256.4	68.00	263.5	68.20	270.6	68.74
	39	200.8	46.89	237.9	58.50	245.0	65.62	248.5	66.27	252.0	66.60	260.0	66.80	267.0	67.33
	41	195.6	50.23	227.5	61.65	235.2	64.32	238.5	64.88	242.0	65.20	249.0	65.40	256.1	65.92
	43	190.8	53.61	217.9	60.77	225.5	62.88	228.8	63.49	232.1	63.81	239.0	64.00	245.9	64.51
46	178.8	57.65	198.7	59.32	205.9	60.91	209.0	61.40	212.2	61.71	218.6	61.90	225.0	62.39	
48	158.2	56.47	172.5	58.27	179.0	59.72	181.7	60.08	184.5	60.27	190.2	60.51	195.9	60.75	
110	10	179.8	18.98	214.4	23.13	239.5	27.48	246.4	29.74	262.0	32.01	268.0	32.90	286.1	33.45
	12	179.8	19.57	214.4	23.91	239.5	28.62	246.4	30.58	262.0	33.21	268.0	34.28	286.1	35.07
	14	179.8	20.18	214.4	24.99	239.5	29.91	246.4	32.10	262.0	34.88	268.0	35.88	286.1	36.63
	16	179.8	20.90	214.4	25.90	239.5	31.15	246.4	33.50	262.0	36.49	268.0	37.49	286.1	38.15
	18	179.8	21.67	214.4	26.98	239.5	32.94	246.4	35.27	262.0	38.49	268.0	39.26	286.1	39.99
	20	179.8	22.45	214.4	28.33	239.5	34.94	246.4	36.90	262.0	40.36	268.0	41.36	286.1	42.02
	21	179.8	22.95	214.4	29.17	239.5	35.83	246.4	37.88	262.0	41.48	268.0	42.53	286.1	43.20
	23	179.8	24.45	214.4	31.26	239.5	37.83	246.4	40.00	262.0	43.83	268.0	44.77	286.1	45.51
	25	179.8	26.12	214.4	33.36	239.5	39.97	246.4	42.29	262.0	46.31	268.0	46.97	282.7	47.93
	27	179.8	27.91	214.4	35.67	239.5	42.24	246.4	44.75	262.0	48.36	268.0	49.47	278.5	50.31
	29	179.8	29.80	214.4	38.08	239.5	44.64	246.4	47.39	262.0	51.10	268.0	51.99	275.0	52.77
	31	179.8	31.68	214.4	40.60	239.5	47.17	246.4	50.21	257.7	53.70	264.5	54.75	270.6	55.33
	33	179.8	33.78	214.4	43.22	239.5	49.83	246.4	53.21	254.1	56.71	260.3	57.65	267.1	57.97
	35	179.8	35.88	214.4	46.16	239.5	52.63	246.4	56.38	249.9	59.85	255.9	60.40	262.9	60.70
	37	179.8	38.03	214.4	48.99	239.5	55.56	242.9	59.74	245.5	63.12	252.5	63.35	258.5	63.52
	39	179.8	41.00	214.4	52.06	235.2	58.62	238.6	63.90	242.1	66.25	248.1	66.36	255.1	66.43
	41	175.2	43.97	208.9	55.13	225.1	61.82	228.6	69.11	231.6	69.11	238.4	69.67	244.3	70.22
	43	170.9	46.17	203.7	57.44	215.7	65.56	219.2	66.30	222.1	66.15	228.7	66.53	234.5	66.71
46	160.2	45.06	190.9	55.45	196.8	62.22	200.2	62.22	202.9	62.75	209.0	63.10	214.5	63.27	
48	141.7	43.77	166.0	53.42	171.0	59.20	174.1	59.59	176.3	59.88	181.8	60.05	186.6	60.29	

# 7. Capacity Tables

Cooling Capacity (80HP)

Combination (%)	Outdoor air temp. (DB, °C)	Indoor air temp. (DB/WB, °C)													
		20		23		26		27		28		30		32	
		14		16		18		19		20		22		24	
		TC	PI	TC	PI	TC	PI	TC	PI	TC	PI	TC	PI	TC	PI
100	10	151.2	17.09	180.0	20.77	209.6	24.64	224.0	26.63	238.4	28.61	264.3	31.85	270.1	32.10
	12	151.2	17.64	180.0	21.62	209.6	25.47	224.0	27.35	238.4	29.52	264.3	33.56	270.1	33.89
	14	151.2	18.19	180.0	22.48	209.6	26.55	224.0	28.53	238.4	30.80	264.3	35.44	270.1	35.77
	16	151.2	18.74	180.0	23.23	209.6	27.68	224.0	29.88	238.4	32.46	264.3	37.15	270.1	37.67
	18	151.2	19.30	180.0	24.09	209.6	28.76	224.0	31.34	238.4	34.41	264.3	39.25	270.1	39.56
	20	151.2	19.99	180.0	25.00	209.6	30.43	224.0	33.57	238.4	36.83	264.3	41.13	270.1	41.46
	21	151.2	20.40	180.0	25.60	209.6	31.47	224.0	34.73	238.4	38.19	264.3	42.07	270.1	42.41
	23	151.2	21.61	180.0	27.38	209.6	33.78	224.0	37.24	238.4	40.92	264.3	44.05	270.1	44.41
	25	151.2	22.98	180.0	29.17	209.6	36.09	224.0	39.87	238.4	43.75	264.3	45.93	267.8	46.30
	27	151.2	24.55	180.0	31.16	209.6	38.61	224.0	42.60	238.4	46.52	259.2	48.09	264.6	48.48
	29	151.2	26.12	180.0	33.26	209.6	41.23	224.0	45.53	238.4	49.23	254.4	50.03	260.6	50.43
	31	151.2	27.91	180.0	35.46	209.6	43.96	224.0	48.58	238.4	51.73	250.5	51.97	256.6	52.38
	33	151.2	29.59	180.0	37.77	209.6	46.90	224.0	51.83	238.4	53.68	246.5	53.90	252.6	54.33
	35	151.2	31.47	180.0	40.18	209.6	49.94	224.0	55.29	234.8	55.62	242.0	55.84	248.2	56.29
	37	151.2	33.71	180.0	43.10	209.6	52.90	224.0	57.92	230.9	58.21	237.6	58.44	243.2	58.98
	39	151.2	36.14	180.0	46.30	209.6	56.06	224.0	60.75	227.0	61.02	233.7	61.25	239.2	61.82
	41	148.8	38.57	177.1	49.50	206.3	59.21	214.9	63.58	219.7	63.84	224.8	64.06	232.1	64.66
	43	143.7	40.82	171.1	52.47	199.2	62.04	206.1	66.02	208.4	66.25	214.9	66.47	220.5	67.09
46	134.7	43.91	160.3	56.57	186.7	65.81	188.2	69.11	190.2	69.32	196.3	69.52	201.6	70.18	
48	119.1	37.91	141.8	48.94	161.2	56.26	163.5	58.64	165.2	58.83	170.6	58.96	175.3	59.44	
90	10	136.0	15.87	162.4	19.08	188.8	22.49	201.6	24.25	214.4	26.10	240.8	29.21	267.2	32.10
	12	136.0	16.07	162.4	19.38	188.8	22.88	201.6	24.73	214.4	26.68	240.8	29.79	267.2	33.06
	14	136.0	16.36	162.4	19.77	188.8	23.37	201.6	25.22	214.4	27.17	240.8	30.36	267.2	33.73
	16	136.0	16.65	162.4	20.16	188.8	23.86	201.6	25.71	214.4	27.65	240.8	30.94	267.2	34.30
	18	136.0	16.94	162.4	20.55	188.8	24.25	201.6	26.29	214.4	28.24	240.8	31.62	267.2	36.03
	20	136.0	17.23	162.4	20.93	188.8	24.73	201.6	26.78	214.4	29.31	240.8	33.84	267.2	37.75
	21	136.0	17.43	162.4	21.13	188.8	25.22	201.6	27.65	214.4	30.38	240.8	34.39	267.2	38.61
	23	136.0	17.82	162.4	22.01	188.8	26.97	201.6	29.70	214.4	32.52	240.8	36.47	263.5	40.44
	25	136.0	18.70	162.4	23.47	188.8	28.82	201.6	31.74	214.4	34.76	240.8	38.99	259.7	42.16
	27	136.0	19.96	162.4	25.02	188.8	30.77	201.6	33.88	214.4	37.20	240.8	41.46	255.9	44.14
	29	136.0	21.13	162.4	26.68	188.8	32.91	201.6	36.22	214.4	39.73	240.8	43.91	252.1	45.92
	31	136.0	22.49	162.4	28.43	188.8	35.05	201.6	38.56	214.4	42.36	240.8	46.10	248.3	47.70
	33	136.0	23.95	162.4	30.28	188.8	37.39	201.6	41.09	214.4	44.92	240.8	48.33	244.5	49.48
	35	136.0	25.41	162.4	32.13	188.8	39.73	201.6	43.82	214.4	47.64	236.7	51.11	240.7	52.28
	37	136.0	26.97	162.4	34.18	188.8	42.36	201.6	46.55	214.4	50.29	232.8	53.42	236.9	54.62
	39	136.0	28.56	162.4	36.35	188.8	44.83	201.6	49.53	214.4	52.88	229.0	56.32	233.1	57.00
	41	132.5	31.95	158.2	40.30	184.0	49.21	196.4	54.17	208.9	57.09	219.5	59.36	223.4	60.72
	43	129.2	34.49	154.3	43.55	179.4	53.75	191.6	58.34	203.7	61.21	210.4	63.52	214.3	64.33
46	121.1	38.82	144.6	49.60	168.1	61.24	179.5	66.14	185.1	68.01	192.1	69.37	195.7	69.67	
48	107.1	33.93	127.9	43.38	148.7	53.58	158.8	57.69	160.8	58.43	166.9	58.96	170.1	59.44	
80	10	120.8	14.80	144.0	17.78	167.2	20.87	179.2	22.51	191.2	24.16	214.4	27.55	237.6	29.91
	12	120.8	15.11	144.0	17.99	167.2	21.28	179.2	22.92	191.2	24.57	214.4	28.06	237.6	30.50
	14	120.8	15.32	144.0	18.40	167.2	21.59	179.2	23.34	191.2	24.98	214.4	28.58	237.6	31.10
	16	120.8	15.52	144.0	18.71	167.2	22.00	179.2	23.75	191.2	25.49	214.4	29.20	237.6	31.69
	18	120.8	15.83	144.0	19.02	167.2	22.41	179.2	24.16	191.2	26.01	214.4	29.71	237.6	32.38
	20	120.8	16.14	144.0	19.43	167.2	22.92	179.2	24.67	191.2	26.52	214.4	30.84	237.6	34.30
	21	120.8	16.24	144.0	19.64	167.2	23.13	179.2	24.98	191.2	27.14	214.4	31.81	237.6	35.22
	23	120.8	16.55	144.0	19.94	167.2	24.16	179.2	26.52	191.2	28.99	214.4	33.59	237.6	36.96
	25	120.8	17.17	144.0	21.28	167.2	25.91	179.2	28.37	191.2	31.05	214.4	35.95	237.6	39.52
	27	120.8	18.20	144.0	22.62	167.2	27.65	179.2	30.33	191.2	33.10	214.4	38.20	237.6	41.58
	29	120.8	19.33	144.0	24.16	167.2	29.40	179.2	32.28	191.2	35.36	214.4	40.92	237.6	43.62
	31	120.8	20.56	144.0	25.60	167.2	31.35	179.2	34.44	191.2	37.63	214.4	43.43	237.6	45.79
	33	120.8	21.79	144.0	27.35	167.2	33.41	179.2	36.70	191.2	40.09	214.4	45.76	237.6	47.99
	35	120.8	23.13	144.0	28.99	167.2	35.57	179.2	39.06	191.2	42.77	214.4	48.52	235.1	50.71
	37	120.8	24.47	144.0	30.82	167.2	37.73	179.2	41.53	191.2	45.44	214.4	51.21	231.3	53.09
	39	120.8	25.86	144.0	32.59	167.2	40.36	179.2	44.65	191.2	48.83	214.4	54.10	227.5	56.00
	41	117.7	28.60	140.3	36.11	162.9	44.29	174.6	48.94	186.3	53.65	208.9	58.17	217.9	59.50
	43	114.8	31.49	136.8	39.41	158.9	48.35	170.3	53.34	181.7	58.63	203.7	62.25	208.9	63.69
46	107.6	35.03	128.2	44.39	148.9	54.48	159.6	59.37	170.3	66.16	186.3	69.37	190.7	69.67	
48	95.2	30.59	113.4	38.81	131.7	47.64	141.2	51.86	150.6	57.86	161.8	58.96	165.7	59.44	

# 7. Capacity Tables

Cooling Capacity (80HP)

Combination (%)	Outdoor air temp. (DB, °C)	Indoor air temp. (DB/WB, °C)													
		20		23		26		27		28		30		32	
		14		16		18		19		20		22		24	
		TC	PI	TC	PI	TC	PI	TC	PI	TC	PI	TC	PI	TC	PI
70	10	105.6	13.09	126.4	15.57	146.4	18.04	156.8	19.49	167.2	20.83	187.2	23.71	208.0	26.53
	12	105.6	13.30	126.4	15.78	146.4	18.46	156.8	19.80	167.2	21.24	187.2	24.13	208.0	27.02
	14	105.6	13.51	126.4	15.98	146.4	18.77	156.8	20.11	167.2	21.55	187.2	24.64	208.0	27.52
	16	105.6	13.71	126.4	16.29	146.4	19.07	156.8	20.52	167.2	21.96	187.2	25.06	208.0	28.11
	18	105.6	13.92	126.4	16.60	146.4	19.49	156.8	20.93	167.2	22.37	187.2	25.47	208.0	28.61
	20	105.6	14.13	126.4	16.91	146.4	19.80	156.8	21.34	167.2	22.89	187.2	26.09	208.0	29.69
	21	105.6	14.33	126.4	17.01	146.4	20.00	156.8	21.55	167.2	23.10	187.2	26.50	208.0	30.33
	23	105.6	14.54	126.4	17.43	146.4	20.42	156.8	22.27	167.2	24.23	187.2	28.35	208.0	32.02
	25	105.6	14.74	126.4	18.04	146.4	21.76	156.8	23.82	167.2	25.88	187.2	30.31	208.0	33.57
	27	105.6	15.57	126.4	19.28	146.4	23.20	156.8	25.26	167.2	27.63	187.2	32.38	208.0	35.68
	29	105.6	16.60	126.4	20.42	146.4	24.64	156.8	26.91	167.2	29.39	187.2	34.54	208.0	38.22
	31	105.6	17.63	126.4	21.76	146.4	26.29	156.8	28.77	167.2	31.34	187.2	36.81	208.0	40.56
	33	105.6	18.66	126.4	22.99	146.4	27.94	156.8	30.52	167.2	33.30	187.2	39.18	208.0	43.18
	35	105.6	19.69	126.4	24.55	146.4	29.69	156.8	32.48	167.2	35.47	187.2	41.76	208.0	45.78
	37	105.6	20.93	126.4	26.00	146.4	31.55	156.8	34.54	167.2	37.74	187.2	44.44	208.0	48.32
	39	105.6	22.23	126.4	27.71	146.4	33.74	156.8	37.16	167.2	40.76	187.2	47.56	208.0	52.09
	41	102.9	24.57	123.2	30.36	142.7	37.01	152.8	40.76	162.9	44.32	182.4	52.24	202.7	56.20
	43	100.4	26.75	120.1	33.09	139.1	40.38	149.0	44.45	158.9	48.39	177.9	57.07	197.7	60.76
46	94.0	29.72	112.6	37.21	130.4	45.47	139.6	49.51	148.9	54.55	166.7	64.36	185.2	67.72	
48	83.2	25.94	99.6	32.50	115.3	39.75	123.5	43.27	131.7	47.72	147.5	56.32	163.9	58.49	
60	10	90.4	11.38	108.0	13.34	125.6	15.51	134.4	16.65	143.2	17.68	160.8	20.06	178.4	22.44
	12	90.4	11.58	108.0	13.55	125.6	15.72	134.4	16.86	143.2	17.99	160.8	20.37	178.4	22.85
	14	90.4	11.69	108.0	13.75	125.6	16.03	134.4	17.17	143.2	18.30	160.8	20.79	178.4	23.27
	16	90.4	11.89	108.0	14.06	125.6	16.24	134.4	17.48	143.2	18.72	160.8	21.20	178.4	23.68
	18	90.4	12.10	108.0	14.27	125.6	16.55	134.4	17.79	143.2	19.03	160.8	21.51	178.4	24.20
	20	90.4	12.31	108.0	14.48	125.6	16.86	134.4	18.10	143.2	19.34	160.8	21.92	178.4	24.72
	21	90.4	12.41	108.0	14.58	125.6	17.06	134.4	18.30	143.2	19.55	160.8	22.23	178.4	24.92
	23	90.4	12.62	108.0	14.89	125.6	17.27	134.4	18.61	143.2	19.96	160.8	23.06	178.4	26.47
	25	90.4	12.82	108.0	15.20	125.6	17.99	134.4	19.55	143.2	21.20	160.8	24.61	178.4	28.34
	27	90.4	13.24	108.0	16.03	125.6	19.13	134.4	20.79	143.2	22.54	160.8	26.16	178.4	30.20
	29	90.4	14.06	108.0	17.06	125.6	20.37	134.4	22.13	143.2	23.99	160.8	27.92	178.4	32.26
	31	90.4	14.89	108.0	18.10	125.6	21.61	134.4	23.58	143.2	25.54	160.8	29.78	178.4	34.33
	33	90.4	15.72	108.0	19.13	125.6	22.96	134.4	25.03	143.2	27.20	160.8	31.64	178.4	36.61
	35	90.4	16.65	108.0	20.37	125.6	24.41	134.4	26.58	143.2	28.85	160.8	33.71	178.4	38.88
	37	90.4	17.58	108.0	21.50	125.6	25.85	134.4	28.23	143.2	30.61	160.8	35.78	178.4	41.37
	39	90.4	18.70	108.0	22.89	125.6	27.91	134.4	30.29	143.2	32.94	160.8	38.37	178.4	44.33
	41	88.1	20.28	105.2	25.05	122.4	30.30	131.0	33.09	139.5	35.76	156.7	42.10	173.8	48.17
	43	85.9	22.04	102.6	27.27	119.4	33.04	127.7	36.06	136.1	38.99	152.8	45.96	169.5	52.61
46	80.5	24.68	96.2	30.62	111.9	37.16	119.7	40.53	127.5	43.88	143.2	51.79	158.9	59.94	
48	71.2	21.50	85.1	26.73	99.0	32.46	105.9	35.40	112.8	38.34	126.7	45.29	140.5	52.45	
50	10	75.6	9.85	90.4	11.41	104.8	12.96	112.0	13.90	119.2	14.73	133.6	16.60	148.8	18.46
	12	75.6	9.96	90.4	11.51	104.8	13.17	112.0	14.11	119.2	15.04	133.6	16.91	148.8	18.77
	14	75.6	10.06	90.4	11.72	104.8	13.38	112.0	14.31	119.2	15.25	133.6	17.11	148.8	19.08
	16	75.6	10.27	90.4	11.93	104.8	13.59	112.0	14.62	119.2	15.45	133.6	17.42	148.8	19.40
	18	75.6	10.37	90.4	12.03	104.8	13.79	112.0	14.83	119.2	15.77	133.6	17.74	148.8	19.81
	20	75.6	10.48	90.4	12.24	104.8	14.11	112.0	15.04	119.2	16.08	133.6	18.05	148.8	20.23
	21	75.6	10.58	90.4	12.34	104.8	14.21	112.0	15.25	119.2	16.18	133.6	18.25	148.8	20.43
	23	75.6	10.79	90.4	12.55	104.8	14.42	112.0	15.45	119.2	16.49	133.6	18.57	148.8	20.85
	25	75.6	10.89	90.4	12.76	104.8	14.73	112.0	15.77	119.2	17.01	133.6	19.50	148.8	22.30
	27	75.6	11.10	90.4	13.17	104.8	15.56	112.0	16.80	119.2	18.05	133.6	20.85	148.8	23.75
	29	75.6	11.72	90.4	14.00	104.8	16.49	112.0	17.84	119.2	19.19	133.6	22.09	148.8	25.20
	31	75.6	12.34	90.4	14.83	104.8	17.53	112.0	18.88	119.2	20.43	133.6	23.54	148.8	26.86
	33	75.6	13.07	90.4	15.66	104.8	18.57	112.0	20.02	119.2	21.68	133.6	25.00	148.8	28.63
	35	75.6	13.79	90.4	16.60	104.8	19.60	112.0	21.26	119.2	22.92	133.6	26.45	148.8	30.39
	37	75.6	14.62	90.4	17.53	104.8	20.74	112.0	22.51	119.2	24.27	133.6	28.21	148.8	32.26
	39	75.6	15.60	90.4	18.79	104.8	22.23	112.0	24.23	119.2	26.04	133.6	30.05	148.8	34.84
	41	73.7	16.87	88.1	20.34	102.1	24.30	109.1	26.24	116.1	28.22	130.2	32.94	145.0	37.83
	43	71.8	18.33	85.9	22.12	99.6	26.44	106.4	28.57	113.3	30.72	127.0	35.92	141.4	41.27
46	67.3	20.53	80.5	24.81	93.3	29.66	99.7	32.08	106.2	34.49	119.0	40.41	132.5	46.47	
48	59.6	17.89	71.2	21.64	82.6	25.87	88.2	28.00	93.9	30.10	105.3	35.32	117.2	40.62	

**Note**

1. TC: Total Capacity(kW), PI : Power Input(kW, Comp. + Outdoor fan motor)
2. Capacity tables show the average value of conditions which may occur.

# 7. Capacity Tables

◆ ARUM820LTE5

Cooling Capacity (82HP)

Combination (%)	Outdoor air temp. (DB, °C)	Indoor air temp. (DB/WB, °C)													
		20		23		26		27		28		30		32	
		14	16	18	19	20	22	24	TC	PI	TC	PI	TC	PI	
130	10	227.4	24.80	270.8	30.31	290.3	35.15	298.6	35.87	306.9	36.15	321.7	36.44	330.0	36.59
	12	227.4	25.41	270.8	31.38	290.3	36.60	298.6	36.84	306.9	37.13	321.7	37.43	330.0	37.76
	14	227.4	26.26	270.8	32.52	290.3	37.98	298.6	38.25	306.9	38.56	321.7	38.86	330.0	39.21
	16	227.4	27.22	270.8	33.66	290.3	39.68	298.6	40.04	306.9	40.37	321.7	40.73	330.0	41.05
	18	227.4	28.36	270.8	35.60	290.3	41.50	298.6	42.39	306.9	42.73	321.7	43.15	330.0	43.45
	20	227.4	29.61	270.8	37.93	290.3	43.55	298.6	46.63	306.9	47.01	317.0	47.47	325.4	47.80
	21	227.4	30.39	270.8	39.26	290.3	44.46	298.6	49.35	306.9	49.74	315.2	50.24	323.6	50.58
	23	227.4	32.61	270.8	41.30	290.3	46.77	298.6	54.45	303.0	54.89	310.6	55.43	318.9	55.81
	25	227.4	34.83	270.8	43.68	290.3	49.97	295.0	60.39	298.6	60.87	306.9	61.48	315.2	61.90
	27	227.4	37.27	270.8	46.69	286.6	53.25	290.3	66.48	295.0	67.01	303.0	67.68	310.6	68.14
	29	227.4	39.71	270.8	49.92	281.9	57.29	286.0	73.06	290.3	73.50	298.6	74.16	306.9	74.45
	31	227.4	42.37	269.9	52.58	277.3	60.94	281.9	72.76	286.0	73.19	293.9	73.85	302.3	74.14
	33	227.4	45.14	265.3	55.71	273.6	65.36	278.0	72.09	281.9	72.52	290.3	73.17	297.6	73.46
	35	227.4	48.14	260.6	58.34	268.9	70.80	273.6	71.15	278.0	71.58	285.6	72.22	293.9	72.50
	37	227.4	51.33	256.9	61.23	265.3	69.86	268.9	70.21	273.6	70.63	281.0	71.27	289.4	71.55
	39	227.4	54.66	252.4	64.45	260.6	68.93	265.3	69.27	268.9	69.69	277.3	70.31	285.6	70.59
	41	221.6	57.99	241.9	67.67	250.1	67.99	253.8	68.33	258.8	68.74	266.6	69.36	273.8	69.63
	43	216.1	61.15	231.8	66.72	239.9	67.06	243.5	67.39	248.4	67.80	256.0	68.40	263.0	68.67
46	202.5	65.46	211.5	65.32	219.1	65.65	222.6	65.98	227.2	66.38	234.4	66.97	240.8	67.24	
48	179.2	63.63	183.7	63.82	190.5	63.96	193.6	64.13	197.7	64.69	204.0	65.10	209.7	65.35	
120	10	205.8	22.31	244.7	27.35	267.4	32.50	275.5	35.12	283.7	35.68	299.1	35.82	306.4	36.11
	12	205.8	22.91	244.7	28.27	267.4	33.81	275.5	35.87	283.7	37.00	299.1	37.45	306.4	37.75
	14	205.8	23.70	244.7	29.24	267.4	35.17	275.5	37.23	283.7	38.36	299.1	38.92	306.4	39.23
	16	205.8	24.55	244.7	30.43	267.4	36.53	275.5	38.62	283.7	40.13	299.1	40.62	306.4	40.95
	18	205.8	25.51	244.7	31.80	267.4	37.99	275.5	40.65	283.7	42.19	299.1	42.67	306.4	43.01
	20	205.8	26.48	244.7	33.72	267.4	40.04	275.5	42.78	283.7	44.42	299.1	45.01	306.4	45.37
	21	205.8	27.28	244.7	34.94	267.4	41.16	275.5	44.04	283.7	45.88	299.1	46.47	306.4	46.84
	23	205.8	29.17	244.7	37.38	267.4	44.10	275.5	46.80	283.7	48.92	299.1	49.41	306.4	49.81
	25	205.8	31.17	244.7	40.04	267.4	46.52	275.5	49.88	283.7	52.46	295.5	52.90	302.7	53.32
	27	205.8	33.27	244.7	42.81	267.4	49.50	275.5	53.29	283.7	56.38	291.0	56.75	298.2	57.21
	29	205.8	35.49	244.7	45.70	267.4	52.09	275.5	57.04	279.1	60.08	286.4	60.99	294.6	61.47
	31	205.8	37.82	244.7	48.80	267.4	54.79	272.0	61.10	275.5	64.45	282.8	65.59	290.0	66.12
	33	205.8	40.26	244.7	52.02	263.8	57.96	267.4	66.32	271.0	69.20	278.3	69.99	285.5	70.55
	35	205.8	42.81	244.7	55.46	259.2	61.34	262.8	73.06	267.4	73.43	274.7	73.65	281.8	74.23
	37	205.8	46.05	244.7	58.52	255.5	65.40	259.2	71.53	262.8	71.88	270.1	72.10	277.4	72.67
	39	205.8	49.57	243.8	61.85	251.1	69.37	254.7	70.06	258.3	70.41	266.5	70.62	273.7	71.18
	41	200.5	53.10	233.2	65.18	241.0	68.00	244.5	68.59	248.0	68.93	255.2	69.14	262.5	69.69
	43	195.6	56.68	223.4	64.24	231.1	66.47	234.5	67.12	237.9	67.45	245.0	67.66	252.0	68.19
46	183.3	60.94	203.7	62.71	211.1	64.39	214.2	64.91	217.5	65.24	224.0	65.43	230.7	65.95	
48	162.1	59.70	176.9	61.60	183.5	63.13	186.2	63.51	189.1	63.72	194.9	63.97	200.8	64.23	
110	10	184.3	20.06	219.8	24.46	245.5	29.05	252.5	31.44	268.5	33.84	274.7	34.78	293.3	35.36
	12	184.3	20.69	219.8	25.28	245.5	30.25	252.5	32.33	268.5	35.11	274.7	36.24	293.3	37.08
	14	184.3	21.33	219.8	26.42	245.5	31.62	252.5	33.93	268.5	36.88	274.7	37.93	293.3	38.73
	16	184.3	22.09	219.8	27.38	245.5	32.93	252.5	35.41	268.5	38.58	274.7	39.63	293.3	40.33
	18	184.3	22.91	219.8	28.52	245.5	34.83	252.5	37.29	268.5	40.69	274.7	41.50	293.3	42.27
	20	184.3	23.73	219.8	29.95	245.5	36.93	252.5	39.00	268.5	42.67	274.7	43.72	293.3	44.42
	21	184.3	24.26	219.8	30.83	245.5	37.88	252.5	40.05	268.5	43.86	274.7	44.97	293.3	45.67
	23	184.3	25.84	219.8	33.05	245.5	40.00	252.5	42.28	268.5	46.33	274.7	47.33	293.3	48.11
	25	184.3	27.62	219.8	35.27	245.5	42.25	252.5	44.70	268.5	48.95	274.7	49.65	289.7	50.67
	27	184.3	29.50	219.8	37.71	245.5	44.65	252.5	47.31	268.5	51.13	274.7	52.30	285.4	53.18
	29	184.3	31.50	219.8	40.26	245.5	47.19	252.5	50.10	268.5	54.03	274.7	54.96	281.9	55.79
	31	184.3	33.50	219.8	42.92	245.5	49.86	252.5	53.08	264.1	56.77	271.1	57.88	277.4	58.49
	33	184.3	35.71	219.8	45.70	245.5	52.68	252.5	56.25	260.5	59.95	266.8	60.95	273.8	61.28
	35	184.3	37.93	219.8	48.80	245.5	55.64	252.5	59.61	256.1	63.27	262.3	63.86	269.4	64.17
	37	184.3	40.20	219.8	51.79	245.5	58.74	249.0	63.15	251.7	66.73	258.8	66.97	265.0	67.15
	39	184.3	43.34	219.8	55.04	241.0	61.97	244.5	67.55	248.2	70.04	254.3	70.16	261.5	70.23
	41	179.6	46.48	214.1	58.28	230.7	65.35	234.3	73.06	237.4	73.06	244.3	73.65	250.4	74.23
	43	175.2	48.81	208.8	60.72	221.1	69.30	224.7	70.09	227.6	69.93	234.4	70.33	240.4	70.52
46	164.2	47.64	195.7	58.62	201.7	65.77	205.3	65.77	207.9	66.34	214.3	66.71	219.8	66.89	
48	145.2	46.27	170.1	56.47	175.2	62.58	178.4	63.00	180.7	63.30	186.4	63.48	191.3	63.73	

# 7. Capacity Tables

Cooling Capacity (82HP)

Combination (%)	Outdoor air temp. (DB, °C)	Indoor air temp. (DB/WB, °C)													
		20		23		26		27		28		30		32	
		14		16		18		19		20		22		24	
		TC	PI	TC	PI	TC	PI	TC	PI	TC	PI	TC	PI	TC	PI
100	10	155.0	18.07	184.5	21.96	214.8	26.05	229.6	28.15	244.4	30.25	270.9	33.67	276.9	33.94
	12	155.0	18.65	184.5	22.86	214.8	26.93	229.6	28.91	244.4	31.21	270.9	35.48	276.9	35.83
	14	155.0	19.23	184.5	23.77	214.8	28.07	229.6	30.16	244.4	32.56	270.9	37.47	276.9	37.82
	16	155.0	19.81	184.5	24.56	214.8	29.27	229.6	31.59	244.4	34.31	270.9	39.27	276.9	39.82
	18	155.0	20.40	184.5	25.47	214.8	30.40	229.6	33.13	244.4	36.38	270.9	41.49	276.9	41.83
	20	155.0	21.13	184.5	26.43	214.8	32.16	229.6	35.49	244.4	38.93	270.9	43.48	276.9	43.83
	21	155.0	21.57	184.5	27.06	214.8	33.27	229.6	36.71	244.4	40.37	270.9	44.47	276.9	44.83
	23	155.0	22.85	184.5	28.95	214.8	35.71	229.6	39.37	244.4	43.26	270.9	46.57	276.9	46.94
	25	155.0	24.29	184.5	30.83	214.8	38.15	229.6	42.15	244.4	46.25	270.9	48.56	274.5	48.95
	27	155.0	25.95	184.5	32.94	214.8	40.82	229.6	45.03	244.4	49.17	265.6	50.84	271.3	51.25
	29	155.0	27.62	184.5	35.16	214.8	43.59	229.6	48.14	244.4	52.04	260.7	52.89	267.2	53.31
	31	155.0	29.50	184.5	37.49	214.8	46.47	229.6	51.35	244.4	54.69	256.8	54.94	263.1	55.38
	33	155.0	31.28	184.5	39.93	214.8	49.58	229.6	54.79	244.4	56.74	252.7	56.98	259.0	57.44
	35	155.0	33.27	184.5	42.48	214.8	52.79	229.6	58.45	240.6	58.80	248.1	59.03	254.4	59.50
	37	155.0	35.63	184.5	45.56	214.8	55.92	229.6	61.23	236.7	61.53	243.5	61.78	249.3	62.35
	39	155.0	38.20	184.5	48.94	214.8	59.26	229.6	64.23	232.7	64.51	239.6	64.75	245.2	65.35
	41	152.5	40.77	181.6	52.33	211.4	62.60	220.3	67.22	225.1	67.49	230.4	67.72	237.9	68.36
	43	147.3	43.15	175.3	55.47	204.2	65.59	211.2	69.79	213.7	70.04	220.3	70.27	226.0	70.93
46	138.0	46.42	164.3	59.80	191.3	69.57	192.9	73.06	194.9	73.28	201.2	73.49	206.6	74.19	
48	122.1	40.08	145.4	51.74	165.2	59.47	167.6	61.99	169.3	62.19	174.9	62.33	179.7	62.83	
90	10	139.4	16.68	166.5	20.06	193.5	23.64	206.6	25.49	219.8	27.43	246.8	30.70	273.9	33.94
	12	139.4	16.89	166.5	20.37	193.5	24.05	206.6	26.00	219.8	28.05	246.8	31.31	273.9	34.75
	14	139.4	17.20	166.5	20.78	193.5	24.57	206.6	26.51	219.8	28.56	246.8	31.92	273.9	35.46
	16	139.4	17.50	166.5	21.19	193.5	25.08	206.6	27.02	219.8	29.07	246.8	32.53	273.9	36.06
	18	139.4	17.81	166.5	21.60	193.5	25.49	206.6	27.64	219.8	29.68	246.8	33.24	273.9	37.87
	20	139.4	18.12	166.5	22.01	193.5	26.00	206.6	28.15	219.8	30.81	246.8	35.57	273.9	39.69
	21	139.4	18.32	166.5	22.21	193.5	26.51	206.6	29.07	219.8	31.94	246.8	36.15	273.9	40.59
	23	139.4	18.73	166.5	23.13	193.5	28.35	206.6	31.22	219.8	34.19	246.8	38.33	270.1	42.51
	25	139.4	19.65	166.5	24.67	193.5	30.30	206.6	33.37	219.8	36.54	246.8	40.99	266.2	44.32
	27	139.4	20.98	166.5	26.31	193.5	32.34	206.6	35.62	219.8	39.10	246.8	43.58	262.3	46.40
	29	139.4	22.21	166.5	28.05	193.5	34.60	206.6	38.08	219.8	41.76	246.8	46.16	258.4	48.27
	31	139.4	23.64	166.5	29.89	193.5	36.85	206.6	40.53	219.8	44.53	246.8	48.46	254.5	50.14
	33	139.4	25.18	166.5	31.83	193.5	39.31	206.6	43.19	219.8	47.22	246.8	50.81	250.6	52.01
	35	139.4	26.72	166.5	33.78	193.5	41.76	206.6	46.06	219.8	50.08	242.6	53.72	246.7	54.96
	37	139.4	28.35	166.5	35.93	193.5	44.53	206.6	48.93	219.8	52.86	238.7	56.16	242.8	57.42
	39	139.4	30.02	166.5	38.21	193.5	47.13	206.6	52.07	219.8	55.59	234.8	59.21	238.9	59.92
	41	135.8	33.59	162.2	42.37	188.6	51.73	201.4	56.94	214.1	60.01	225.0	62.40	229.0	63.83
	43	132.5	36.26	158.2	45.78	183.9	56.50	196.4	61.33	208.8	64.35	215.7	66.82	219.6	67.63
46	124.1	40.81	148.2	52.14	172.3	64.38	184.0	69.53	189.8	71.49	196.9	73.28	200.6	73.45	
48	109.8	35.67	131.1	45.61	152.5	56.33	162.8	60.66	164.8	61.61	171.1	62.33	174.4	62.83	
80	10	123.8	15.55	147.6	18.68	171.4	21.92	183.7	23.64	196.0	25.37	219.8	28.93	243.5	31.41
	12	123.8	15.87	147.6	18.89	171.4	22.35	183.7	24.08	196.0	25.80	219.8	29.47	243.5	32.04
	14	123.8	16.09	147.6	19.33	171.4	22.67	183.7	24.51	196.0	26.24	219.8	30.01	243.5	32.66
	16	123.8	16.30	147.6	19.65	171.4	23.10	183.7	24.94	196.0	26.78	219.8	30.66	243.5	33.28
	18	123.8	16.63	147.6	19.97	171.4	23.54	183.7	25.37	196.0	27.32	219.8	31.20	243.5	34.01
	20	123.8	16.95	147.6	20.41	171.4	24.08	183.7	25.91	196.0	27.85	219.8	32.39	243.5	36.03
	21	123.8	17.06	147.6	20.62	171.4	24.29	183.7	26.24	196.0	28.50	219.8	33.41	243.5	36.98
	23	123.8	17.38	147.6	20.95	171.4	25.37	183.7	27.85	196.0	30.45	219.8	35.28	243.5	38.82
	25	123.8	18.03	147.6	22.35	171.4	27.21	183.7	29.80	196.0	32.61	219.8	37.75	243.5	41.50
	27	123.8	19.11	147.6	23.75	171.4	29.04	183.7	31.85	196.0	34.76	219.8	40.12	243.5	43.67
	29	123.8	20.30	147.6	25.37	171.4	30.88	183.7	33.90	196.0	37.14	219.8	42.98	243.5	45.86
	31	123.8	21.59	147.6	26.88	171.4	32.93	183.7	36.17	196.0	39.52	219.8	45.61	243.5	48.14
	33	123.8	22.89	147.6	28.72	171.4	35.09	183.7	38.54	196.0	42.11	219.8	48.06	243.5	50.45
	35	123.8	24.29	147.6	30.45	171.4	37.36	183.7	41.03	196.0	44.91	219.8	50.96	241.0	53.31
	37	123.8	25.70	147.6	32.37	171.4	39.62	183.7	43.62	196.0	47.72	219.8	53.78	237.1	55.75
	39	123.8	27.16	147.6	34.22	171.4	42.39	183.7	46.89	196.0	51.28	219.8	56.82	233.2	58.81
	41	120.7	30.04	143.8	37.92	167.0	46.52	179.0	51.40	191.0	56.35	214.1	61.15	223.4	62.55
	43	117.7	33.07	140.3	41.39	162.9	50.78	174.6	56.02	186.2	61.58	208.8	65.48	214.2	66.95
46	110.3	36.79	131.5	46.62	152.6	57.21	163.6	62.35	174.5	69.49	191.0	73.28	195.5	73.45	
48	97.5	32.13	116.3	40.76	135.0	50.04	144.7	54.46	154.4	60.82	165.9	62.33	169.9	62.83	

# 7. Capacity Tables

Cooling Capacity (82HP)

Combination (%)	Outdoor air temp. (DB, °C)	Indoor air temp. (DB/WB, °C)													
		20		23		26		27		28		30		32	
		14	16	18	19	20	22	24	TC	PI	TC	PI	TC	PI	
70	10	108.2	13.74	129.6	16.34	150.1	18.93	160.7	20.45	171.4	21.85	191.9	24.88	213.2	27.83
	12	108.2	13.96	129.6	16.55	150.1	19.37	160.7	20.77	171.4	22.29	191.9	25.32	213.2	28.35
	14	108.2	14.17	129.6	16.77	150.1	19.69	160.7	21.10	171.4	22.61	191.9	25.86	213.2	28.87
	16	108.2	14.39	129.6	17.09	150.1	20.01	160.7	21.53	171.4	23.04	191.9	26.29	213.2	29.50
	18	108.2	14.61	129.6	17.42	150.1	20.45	160.7	21.96	171.4	23.48	191.9	26.72	213.2	30.02
	20	108.2	14.82	129.6	17.74	150.1	20.77	160.7	22.39	171.4	24.02	191.9	27.37	213.2	31.16
	21	108.2	15.04	129.6	17.85	150.1	20.99	160.7	22.61	171.4	24.23	191.9	27.80	213.2	31.82
	23	108.2	15.25	129.6	18.28	150.1	21.42	160.7	23.37	171.4	25.42	191.9	29.75	213.2	33.59
	25	108.2	15.47	129.6	18.93	150.1	22.83	160.7	24.99	171.4	27.15	191.9	31.81	213.2	35.23
	27	108.2	16.34	129.6	20.23	150.1	24.34	160.7	26.51	171.4	28.99	191.9	33.97	213.2	37.43
	29	108.2	17.42	129.6	21.42	150.1	25.86	160.7	28.24	171.4	30.83	191.9	36.24	213.2	40.11
	31	108.2	18.50	129.6	22.83	150.1	27.59	160.7	30.18	171.4	32.89	191.9	38.62	213.2	42.56
	33	108.2	19.58	129.6	24.13	150.1	29.32	160.7	32.02	171.4	34.94	191.9	41.11	213.2	45.31
	35	108.2	20.66	129.6	25.76	150.1	31.16	160.7	34.08	171.4	37.22	191.9	43.82	213.2	48.04
	37	108.2	21.96	129.6	27.28	150.1	33.10	160.7	36.24	171.4	39.60	191.9	46.63	213.2	50.70
	39	108.2	23.32	129.6	29.08	150.1	35.40	160.7	38.99	171.4	42.77	191.9	49.90	213.2	54.66
	41	105.5	25.78	126.2	31.86	146.2	38.83	156.6	42.77	167.0	46.50	187.0	54.81	207.7	58.97
43	102.9	28.07	123.1	34.72	142.6	42.37	152.7	46.64	162.9	50.78	182.3	59.88	202.6	63.75	
46	96.4	31.19	115.4	39.04	133.6	47.71	143.1	51.95	152.6	57.24	170.9	67.53	189.9	71.06	
48	85.3	27.22	102.1	34.10	118.2	41.71	126.6	45.40	135.0	50.07	151.2	59.10	168.0	61.50	
60	10	92.7	11.92	110.7	13.98	128.7	16.26	137.8	17.45	146.8	18.54	164.8	21.03	182.9	23.52
	12	92.7	12.14	110.7	14.20	128.7	16.48	137.8	17.67	146.8	18.86	164.8	21.36	182.9	23.96
	14	92.7	12.25	110.7	14.42	128.7	16.80	137.8	18.00	146.8	19.19	164.8	21.79	182.9	24.39
	16	92.7	12.47	110.7	14.74	128.7	17.02	137.8	18.32	146.8	19.62	164.8	22.22	182.9	24.83
	18	92.7	12.68	110.7	14.96	128.7	17.35	137.8	18.65	146.8	19.95	164.8	22.55	182.9	25.37
	20	92.7	12.90	110.7	15.18	128.7	17.67	137.8	18.97	146.8	20.27	164.8	22.98	182.9	25.91
	21	92.7	13.01	110.7	15.29	128.7	17.89	137.8	19.19	146.8	20.49	164.8	23.31	182.9	26.13
	23	92.7	13.23	110.7	15.61	128.7	18.10	137.8	19.51	146.8	20.92	164.8	24.17	182.9	27.75
	25	92.7	13.44	110.7	15.94	128.7	18.86	137.8	20.49	146.8	22.22	164.8	25.80	182.9	29.70
	27	92.7	13.88	110.7	16.80	128.7	20.06	137.8	21.79	146.8	23.63	164.8	27.43	182.9	31.65
	29	92.7	14.74	110.7	17.89	128.7	21.36	137.8	23.20	146.8	25.15	164.8	29.27	182.9	33.82
	31	92.7	15.61	110.7	18.97	128.7	22.66	137.8	24.72	146.8	26.78	164.8	31.22	182.9	35.99
	33	92.7	16.48	110.7	20.06	128.7	24.07	137.8	26.23	146.8	28.51	164.8	33.17	182.9	38.38
	35	92.7	17.45	110.7	21.36	128.7	25.58	137.8	27.86	146.8	30.25	164.8	35.34	182.9	40.76
	37	92.7	18.43	110.7	22.54	128.7	27.10	137.8	29.59	146.8	32.09	164.8	37.51	182.9	43.36
	39	92.7	19.60	110.7	24.00	128.7	29.25	137.8	31.75	146.8	34.53	164.8	40.22	182.9	46.47
	41	90.3	21.26	107.9	26.26	125.4	31.77	134.2	34.69	143.0	37.48	160.6	44.14	178.2	50.49
43	88.1	23.10	105.2	28.59	122.3	34.63	130.9	37.80	139.5	40.88	156.6	48.18	173.8	55.15	
46	82.5	25.87	98.6	32.10	114.7	38.95	122.7	42.49	130.7	46.00	146.8	54.29	162.9	62.84	
48	73.0	22.54	87.2	28.02	101.4	34.03	108.5	37.11	115.6	40.19	129.8	47.48	144.1	54.98	
50	10	77.5	10.32	92.7	11.95	107.4	13.58	114.8	14.56	122.2	15.43	136.9	17.38	152.5	19.34
	12	77.5	10.43	92.7	12.06	107.4	13.80	114.8	14.77	122.2	15.75	136.9	17.71	152.5	19.66
	14	77.5	10.54	92.7	12.27	107.4	14.01	114.8	14.99	122.2	15.97	136.9	17.92	152.5	19.99
	16	77.5	10.75	92.7	12.49	107.4	14.23	114.8	15.32	122.2	16.19	136.9	18.25	152.5	20.31
	18	77.5	10.86	92.7	12.60	107.4	14.45	114.8	15.53	122.2	16.51	136.9	18.58	152.5	20.75
	20	77.5	10.97	92.7	12.82	107.4	14.77	114.8	15.75	122.2	16.84	136.9	18.90	152.5	21.18
	21	77.5	11.08	92.7	12.93	107.4	14.88	114.8	15.97	122.2	16.95	136.9	19.12	152.5	21.40
	23	77.5	11.30	92.7	13.14	107.4	15.10	114.8	16.19	122.2	17.27	136.9	19.44	152.5	21.83
	25	77.5	11.41	92.7	13.36	107.4	15.43	114.8	16.51	122.2	17.81	136.9	20.42	152.5	23.35
	27	77.5	11.62	92.7	13.80	107.4	16.29	114.8	17.60	122.2	18.90	136.9	21.83	152.5	24.88
	29	77.5	12.27	92.7	14.66	107.4	17.27	114.8	18.68	122.2	20.10	136.9	23.14	152.5	26.40
	31	77.5	12.93	92.7	15.53	107.4	18.36	114.8	19.77	122.2	21.40	136.9	24.66	152.5	28.13
	33	77.5	13.69	92.7	16.40	107.4	19.44	114.8	20.97	122.2	22.70	136.9	26.18	152.5	29.98
	35	77.5	14.45	92.7	17.38	107.4	20.53	114.8	22.27	122.2	24.01	136.9	27.70	152.5	31.83
	37	77.5	15.32	92.7	18.36	107.4	21.73	114.8	23.57	122.2	25.42	136.9	29.55	152.5	33.78
	39	77.5	16.34	92.7	19.68	107.4	23.28	114.8	25.37	122.2	27.27	136.9	31.47	152.5	36.49
	41	75.5	17.67	90.3	21.30	104.7	25.45	111.9	27.48	119.1	29.55	133.4	34.50	148.6	39.62
43	73.6	19.20	88.1	23.17	102.1	27.69	109.1	29.92	116.1	32.17	130.1	37.62	144.9	43.23	
46	69.0	21.50	82.5	25.99	95.7	31.07	102.2	33.60	108.8	36.12	122.0	42.33	135.8	48.66	
48	61.0	18.74	73.0	22.66	84.6	27.10	90.4	29.33	96.3	31.52	107.9	36.99	120.2	42.54	

**Note**

1. TC: Total Capacity(kW), PI : Power Input(kW, Comp. + Outdoor fan motor)
2. Capacity tables show the average value of conditions which may occur.

# 7. Capacity Tables

◆ ARUM840LTE5

Cooling Capacity (84HP)

Combination (%)	Outdoor air temp. (DB, °C)	Indoor air temp. (DB/WB, °C)													
		20		23		26		27		28		30		32	
		14	16	16	18	18	19	19	20	20	22	22	24	24	
130	10	233.0	25.43	277.4	31.08	297.3	36.05	305.9	36.78	314.4	37.08	329.5	37.37	338.1	37.52
	12	233.0	26.06	277.4	32.18	297.3	37.53	305.9	37.78	314.4	38.08	329.5	38.38	338.1	38.72
	14	233.0	26.93	277.4	33.35	297.3	38.94	305.9	39.23	314.4	39.54	329.5	39.85	338.1	40.21
	16	233.0	27.91	277.4	34.51	297.3	40.69	305.9	41.07	314.4	41.39	329.5	41.76	338.1	42.09
	18	233.0	29.09	277.4	36.51	297.3	42.56	305.9	43.47	314.4	43.82	329.5	44.26	338.1	44.56
	20	233.0	30.37	277.4	38.90	297.3	44.66	305.9	47.82	314.4	48.20	324.8	48.68	333.3	49.02
	21	233.0	31.16	277.4	40.26	297.3	45.59	305.9	50.61	314.4	51.01	322.9	51.52	331.5	51.87
	23	233.0	33.44	277.4	42.36	297.3	47.96	305.9	55.84	310.4	56.29	318.2	56.84	326.7	57.24
	25	233.0	35.71	277.4	44.79	297.3	51.25	302.2	61.93	305.9	62.42	314.4	63.04	322.9	63.48
	27	233.0	38.22	277.4	47.88	293.6	54.61	297.3	68.18	302.2	68.72	310.4	69.40	318.2	69.88
	29	233.0	40.72	277.4	51.19	288.8	58.75	293.0	74.93	297.3	75.37	305.9	76.05	314.4	76.35
	31	233.0	43.45	276.5	53.92	284.0	62.49	288.8	74.61	293.0	75.06	301.1	75.73	309.6	76.03
	33	233.0	46.29	271.7	57.13	280.3	67.02	284.8	73.93	288.8	74.37	297.3	75.04	304.8	75.33
	35	233.0	49.36	267.0	59.83	275.5	72.60	280.3	72.97	284.8	73.40	292.6	74.06	301.1	74.35
	37	233.0	52.64	263.2	62.79	271.7	71.64	275.5	72.00	280.3	72.43	287.9	73.08	296.4	73.37
	39	233.0	56.05	258.6	66.09	267.0	70.68	271.7	71.04	275.5	71.47	284.0	72.10	292.6	72.39
	41	227.0	59.46	247.8	69.40	256.2	69.72	260.0	70.08	265.1	70.50	273.1	71.13	280.5	71.41
	43	221.4	62.71	237.5	68.42	245.7	68.77	249.5	69.11	254.5	69.53	262.3	70.15	269.4	70.42
46	207.5	67.13	216.6	66.99	224.5	67.33	228.0	67.67	232.8	68.07	240.1	68.68	246.7	68.95	
48	183.5	65.25	188.2	65.45	195.2	65.59	198.3	65.77	202.5	66.34	209.0	66.76	214.8	67.02	
120	10	210.8	22.87	250.6	28.05	273.9	33.33	282.3	36.02	290.6	36.59	306.4	36.74	313.9	37.03
	12	210.8	23.49	250.6	28.99	273.9	34.67	282.3	36.78	290.6	37.94	306.4	38.40	313.9	38.71
	14	210.8	24.30	250.6	29.98	273.9	36.07	282.3	38.18	290.6	39.33	306.4	39.91	313.9	40.23
	16	210.8	25.18	250.6	31.20	273.9	37.47	282.3	39.60	290.6	41.15	306.4	41.66	313.9	41.99
	18	210.8	26.16	250.6	32.61	273.9	38.96	282.3	41.69	290.6	43.26	306.4	43.76	313.9	44.11
	20	210.8	27.16	250.6	34.58	273.9	41.06	282.3	43.87	290.6	45.55	306.4	46.15	313.9	46.52
	21	210.8	27.98	250.6	35.83	273.9	42.21	282.3	45.16	290.6	47.05	306.4	47.65	313.9	48.03
	23	210.8	29.91	250.6	38.33	273.9	45.23	282.3	47.99	290.6	50.16	306.4	50.67	313.9	51.08
	25	210.8	31.96	250.6	41.06	273.9	47.70	282.3	51.15	290.6	53.80	302.7	54.25	310.1	54.68
	27	210.8	34.12	250.6	43.90	273.9	50.76	282.3	54.65	290.6	57.81	298.1	58.20	305.5	58.67
	29	210.8	36.40	250.6	46.86	273.9	53.42	282.3	58.49	285.9	61.61	293.4	62.54	301.7	63.04
	31	210.8	38.78	250.6	50.04	273.9	56.19	278.6	62.66	282.3	66.10	289.7	67.26	297.1	67.80
	33	210.8	41.29	250.6	53.34	270.2	59.43	273.9	68.01	277.6	70.96	285.0	71.77	292.5	72.35
	35	210.8	43.90	250.6	56.87	265.6	62.91	269.2	74.93	273.9	75.30	281.4	75.52	288.7	76.12
	37	210.8	47.22	250.6	60.01	261.8	67.07	265.6	73.35	269.2	73.72	276.7	73.94	284.1	74.52
	39	210.8	50.84	249.8	63.42	257.2	71.13	260.9	71.84	264.6	72.20	273.0	72.42	280.4	72.99
	41	205.4	54.45	238.9	66.84	246.9	69.73	250.4	70.34	254.1	70.69	261.4	70.90	268.9	71.46
	43	200.3	58.12	228.8	65.88	236.8	68.17	240.2	68.83	243.7	69.17	250.9	69.38	258.2	69.93
46	187.7	62.50	208.7	64.31	216.2	66.03	219.4	66.57	222.8	66.90	229.5	67.10	236.3	67.63	
48	166.1	61.22	181.2	63.17	187.9	64.74	190.8	65.13	193.7	65.34	199.7	65.60	205.7	65.86	
110	10	188.8	20.58	225.1	25.08	251.5	29.79	258.7	32.24	275.1	34.70	281.4	35.66	300.5	36.26
	12	188.8	21.22	225.1	25.92	251.5	31.02	258.7	33.15	275.1	36.00	281.4	37.16	300.5	38.02
	14	188.8	21.88	225.1	27.09	251.5	32.43	258.7	34.79	275.1	37.82	281.4	38.89	300.5	39.71
	16	188.8	22.66	225.1	28.08	251.5	33.77	258.7	36.32	275.1	39.56	281.4	40.64	300.5	41.36
	18	188.8	23.50	225.1	29.25	251.5	35.71	258.7	38.24	275.1	41.73	281.4	42.56	300.5	43.35
	20	188.8	24.34	225.1	30.71	251.5	37.87	258.7	40.00	275.1	43.76	281.4	44.84	300.5	45.55
	21	188.8	24.88	225.1	31.62	251.5	38.85	258.7	41.07	275.1	44.97	281.4	46.11	300.5	46.83
	23	188.8	26.50	225.1	33.89	251.5	41.02	258.7	43.36	275.1	47.51	281.4	48.53	300.5	49.34
	25	188.8	28.32	225.1	36.17	251.5	43.33	258.7	45.84	275.1	50.20	281.4	50.92	296.8	51.96
	27	188.8	30.25	225.1	38.67	251.5	45.79	258.7	48.52	275.1	52.43	281.4	53.63	292.4	54.54
	29	188.8	32.30	225.1	41.29	251.5	48.39	258.7	51.38	275.1	55.40	281.4	56.36	288.7	57.21
	31	188.8	34.35	225.1	44.02	251.5	51.13	258.7	54.44	270.6	58.22	277.7	59.36	284.2	59.98
	33	188.8	36.62	225.1	46.86	251.5	54.02	258.7	57.69	266.8	61.48	273.3	62.50	280.5	62.85
	35	188.8	38.90	225.1	50.04	251.5	57.06	258.7	61.13	262.4	64.89	268.7	65.48	276.0	65.81
	37	188.8	41.23	225.1	53.11	251.5	60.23	255.1	64.76	257.8	68.43	265.1	68.67	271.4	68.87
	39	188.8	44.45	225.1	56.44	246.9	63.55	250.5	69.27	254.2	71.83	260.5	71.95	267.8	72.02
	41	184.0	47.67	219.4	59.77	236.3	67.02	240.0	74.93	243.2	74.93	250.3	75.52	256.5	76.12
	43	179.4	50.05	213.9	62.27	226.5	71.07	230.2	71.87	233.2	71.72	240.1	72.12	246.2	72.32
46	168.2	48.85	200.5	60.11	206.7	67.45	210.3	67.45	213.0	68.03	219.5	68.41	225.2	68.59	
48	148.8	47.45	174.3	57.91	179.5	64.17	182.8	64.60	185.2	64.92	190.9	65.10	195.9	65.36	

# 7. Capacity Tables

Cooling Capacity (84HP)

Combination (%)	Outdoor air temp. (DB, °C)	Indoor air temp. (DB/WB, °C)													
		20		23		26		27		28		30		32	
		14		16		18		19		20		22		24	
		TC	PI	TC	PI	TC	PI	TC	PI	TC	PI	TC	PI	TC	PI
100	10	158.8	18.53	189.0	22.52	220.1	26.72	235.2	28.87	250.3	31.02	277.5	34.53	283.6	34.80
	12	158.8	19.12	189.0	23.44	220.1	27.62	235.2	29.65	250.3	32.01	277.5	36.38	283.6	36.74
	14	158.8	19.72	189.0	24.37	220.1	28.79	235.2	30.93	250.3	33.39	277.5	38.42	283.6	38.78
	16	158.8	20.32	189.0	25.18	220.1	30.01	235.2	32.40	250.3	35.18	277.5	40.27	283.6	40.84
	18	158.8	20.92	189.0	26.12	220.1	31.18	235.2	33.98	250.3	37.31	277.5	42.55	283.6	42.89
	20	158.8	21.67	189.0	27.11	220.1	32.98	235.2	36.40	250.3	39.92	277.5	44.59	283.6	44.95
	21	158.8	22.12	189.0	27.75	220.1	34.12	235.2	37.65	250.3	41.40	277.5	45.61	283.6	45.97
	23	158.8	23.43	189.0	29.69	220.1	36.62	235.2	40.38	250.3	44.36	277.5	47.76	283.6	48.14
	25	158.8	24.91	189.0	31.62	220.1	39.13	235.2	43.22	250.3	47.43	277.5	49.79	281.2	50.19
	27	158.8	26.61	189.0	33.78	220.1	41.86	235.2	46.18	250.3	50.43	272.1	52.14	277.9	52.55
	29	158.8	28.32	189.0	36.05	220.1	44.70	235.2	49.36	250.3	53.37	267.1	54.24	273.7	54.67
	31	158.8	30.25	189.0	38.44	220.1	47.66	235.2	52.66	250.3	56.08	263.1	56.34	269.5	56.79
	33	158.8	32.07	189.0	40.95	220.1	50.84	235.2	56.19	250.3	58.19	258.8	58.44	265.3	58.90
	35	158.8	34.12	189.0	43.56	220.1	54.14	235.2	59.94	246.5	60.30	254.1	60.53	260.6	61.02
	37	158.8	36.54	189.0	46.72	220.1	57.35	235.2	62.79	242.4	63.10	249.4	63.36	255.4	63.94
	39	158.8	39.18	189.0	50.19	220.1	60.77	235.2	65.86	238.4	66.15	245.4	66.40	251.2	67.02
	41	156.2	41.81	186.0	53.66	216.6	64.19	225.7	68.93	230.6	69.21	236.1	69.45	243.7	70.10
	43	150.9	44.25	179.6	56.88	209.1	67.26	216.4	71.57	218.9	71.82	225.6	72.06	231.5	72.74
46	141.4	47.60	168.3	61.32	196.0	71.34	197.6	74.93	199.7	75.14	206.1	75.36	211.6	76.08	
48	125.1	41.10	148.9	53.06	169.2	60.99	171.7	63.57	173.5	63.78	179.2	63.92	184.1	64.43	
90	10	142.8	17.11	170.5	20.57	198.2	24.25	211.7	26.14	225.1	28.13	252.8	31.49	280.6	34.80
	12	142.8	17.32	170.5	20.89	198.2	24.67	211.7	26.66	225.1	28.76	252.8	32.11	280.6	35.63
	14	142.8	17.63	170.5	21.31	198.2	25.19	211.7	27.19	225.1	29.28	252.8	32.73	280.6	36.36
	16	142.8	17.95	170.5	21.73	198.2	25.72	211.7	27.71	225.1	29.81	252.8	33.36	280.6	36.98
	18	142.8	18.26	170.5	22.15	198.2	26.14	211.7	28.34	225.1	30.44	252.8	34.08	280.6	38.84
	20	142.8	18.58	170.5	22.57	198.2	26.66	211.7	28.86	225.1	31.59	252.8	36.47	280.6	40.70
	21	142.8	18.79	170.5	22.78	198.2	27.19	211.7	29.81	225.1	32.75	252.8	37.07	280.6	41.63
	23	142.8	19.21	170.5	23.72	198.2	29.07	211.7	32.01	225.1	35.06	252.8	39.31	276.7	43.59
	25	142.8	20.15	170.5	25.30	198.2	31.07	211.7	34.22	225.1	37.47	252.8	42.03	272.7	45.45
	27	142.8	21.52	170.5	26.98	198.2	33.17	211.7	36.53	225.1	40.10	252.8	44.69	268.7	47.59
	29	142.8	22.78	170.5	28.76	198.2	35.48	211.7	39.05	225.1	42.82	252.8	47.34	264.7	49.50
	31	142.8	24.25	170.5	30.65	198.2	37.79	211.7	41.57	225.1	45.66	252.8	49.70	260.7	51.42
	33	142.8	25.82	170.5	32.64	198.2	40.31	211.7	44.29	225.1	48.43	252.8	52.10	256.7	53.33
	35	142.8	27.40	170.5	34.64	198.2	42.82	211.7	47.23	225.1	51.35	248.5	55.09	252.7	56.35
	37	142.8	29.07	170.5	36.84	198.2	45.66	211.7	50.18	225.1	54.21	244.5	57.59	248.7	58.88
	39	142.8	30.78	170.5	39.19	198.2	48.33	211.7	53.39	225.1	57.00	240.5	60.71	244.7	61.45
	41	139.1	34.44	166.2	43.44	193.2	53.04	206.3	58.39	219.4	61.54	230.4	63.99	234.6	65.45
	43	135.7	37.18	162.0	46.95	188.4	57.94	201.2	62.89	213.9	65.99	220.9	68.52	225.0	69.35
46	127.2	41.85	151.9	53.46	176.5	66.02	188.5	71.30	194.4	73.31	201.7	75.15	205.5	75.32	
48	112.5	36.58	134.3	46.77	156.2	57.76	166.8	62.20	168.8	63.17	175.3	63.92	178.6	64.43	
80	10	126.8	15.94	151.2	19.15	175.6	22.47	188.2	24.25	200.8	26.02	225.1	29.67	249.5	32.21
	12	126.8	16.27	151.2	19.37	175.6	22.92	188.2	24.69	200.8	26.46	225.1	30.22	249.5	32.85
	14	126.8	16.50	151.2	19.82	175.6	23.25	188.2	25.13	200.8	26.90	225.1	30.78	249.5	33.49
	16	126.8	16.72	151.2	20.15	175.6	23.69	188.2	25.57	200.8	27.46	225.1	31.44	249.5	34.13
	18	126.8	17.05	151.2	20.48	175.6	24.14	188.2	26.02	200.8	28.01	225.1	32.00	249.5	34.87
	20	126.8	17.38	151.2	20.92	175.6	24.69	188.2	26.57	200.8	28.56	225.1	33.21	249.5	36.94
	21	126.8	17.49	151.2	21.15	175.6	24.91	188.2	26.90	200.8	29.23	225.1	34.26	249.5	37.93
	23	126.8	17.82	151.2	21.48	175.6	26.02	188.2	28.56	200.8	31.22	225.1	36.17	249.5	39.81
	25	126.8	18.49	151.2	22.92	175.6	27.90	188.2	30.56	200.8	33.44	225.1	38.71	249.5	42.56
	27	126.8	19.60	151.2	24.36	175.6	29.78	188.2	32.66	200.8	35.65	225.1	41.14	249.5	44.78
	29	126.8	20.81	151.2	26.02	175.6	31.66	188.2	34.76	200.8	38.09	225.1	44.07	249.5	47.03
	31	126.8	22.14	151.2	27.57	175.6	33.77	188.2	37.09	200.8	40.52	225.1	46.77	249.5	49.36
	33	126.8	23.47	151.2	29.45	175.6	35.98	188.2	39.52	200.8	43.18	225.1	49.28	249.5	51.73
	35	126.8	24.91	151.2	31.22	175.6	38.31	188.2	42.07	200.8	46.06	225.1	52.25	246.8	54.66
	37	126.8	26.35	151.2	33.19	175.6	40.63	188.2	44.73	200.8	48.94	225.1	55.15	242.8	57.17
	39	126.8	27.85	151.2	35.10	175.6	43.47	188.2	48.09	200.8	52.59	225.1	58.26	238.8	60.31
	41	123.6	30.81	147.3	38.89	171.1	47.70	183.3	52.71	195.6	57.78	219.4	62.71	228.8	64.14
	43	120.5	33.91	143.7	42.44	166.8	52.07	178.8	57.44	190.8	63.15	213.9	67.15	219.4	68.65
46	113.0	37.73	134.7	47.80	156.4	58.67	167.6	63.93	178.8	71.26	195.6	75.15	200.2	75.32	
48	99.9	32.95	119.1	41.80	138.3	51.31	148.2	55.85	158.2	62.37	169.9	63.92	174.0	64.43	



# 7. Capacity Tables

Cooling Capacity (84HP)

Combination (%)	Outdoor air temp. (DB, °C)	Indoor air temp. (DB/WB, °C)													
		20		23		26		27		28		30		32	
		14		16		18		19		20		22		24	
		TC	PI	TC	PI	TC	PI	TC	PI	TC	PI	TC	PI	TC	PI
70	10	110.9	14.09	132.7	16.75	153.7	19.41	164.6	20.97	175.6	22.41	196.6	25.52	218.4	28.54
	12	110.9	14.31	132.7	16.97	153.7	19.86	164.6	21.30	175.6	22.85	196.6	25.96	218.4	29.08
	14	110.9	14.53	132.7	17.20	153.7	20.19	164.6	21.63	175.6	23.19	196.6	26.51	218.4	29.61
	16	110.9	14.76	132.7	17.53	153.7	20.52	164.6	22.08	175.6	23.63	196.6	26.96	218.4	30.25
	18	110.9	14.98	132.7	17.86	153.7	20.97	164.6	22.52	175.6	24.07	196.6	27.40	218.4	30.78
	20	110.9	15.20	132.7	18.19	153.7	21.30	164.6	22.96	175.6	24.63	196.6	28.07	218.4	31.95
	21	110.9	15.42	132.7	18.31	153.7	21.52	164.6	23.19	175.6	24.85	196.6	28.51	218.4	32.63
	23	110.9	15.64	132.7	18.75	153.7	21.97	164.6	23.96	175.6	26.07	196.6	30.51	218.4	34.45
	25	110.9	15.86	132.7	19.41	153.7	23.41	164.6	25.63	175.6	27.85	196.6	32.62	218.4	36.12
	27	110.9	16.75	132.7	20.75	153.7	24.96	164.6	27.18	175.6	29.73	196.6	34.84	218.4	38.39
	29	110.9	17.86	132.7	21.97	153.7	26.51	164.6	28.96	175.6	31.62	196.6	37.16	218.4	41.13
	31	110.9	18.97	132.7	23.41	153.7	28.29	164.6	30.95	175.6	33.73	196.6	39.61	218.4	43.64
	33	110.9	20.08	132.7	24.74	153.7	30.06	164.6	32.84	175.6	35.83	196.6	42.16	218.4	46.46
	35	110.9	21.19	132.7	26.41	153.7	31.95	164.6	34.95	175.6	38.16	196.6	44.93	218.4	49.26
	37	110.9	22.52	132.7	27.97	153.7	33.95	164.6	37.16	175.6	40.60	196.6	47.82	218.4	51.99
	39	110.9	23.92	132.7	29.82	153.7	36.30	164.6	39.99	175.6	43.86	196.6	51.17	218.4	56.05
	41	108.0	26.44	129.3	32.67	149.8	39.82	160.4	43.86	171.1	47.68	191.5	56.21	212.8	60.47
	43	105.4	28.78	126.1	35.61	146.1	43.44	156.5	47.82	166.8	52.07	186.8	61.40	207.5	65.37
46	98.7	31.98	118.2	40.03	136.9	48.92	146.6	53.27	156.4	58.70	175.1	69.25	194.5	72.87	
48	87.4	27.91	104.6	34.97	121.1	42.77	129.7	46.55	138.3	51.35	154.9	60.60	172.1	63.06	
60	10	94.9	12.23	113.4	14.34	131.9	16.67	141.1	17.90	150.4	19.01	168.8	21.57	187.3	24.12
	12	94.9	12.45	113.4	14.56	131.9	16.90	141.1	18.12	150.4	19.34	168.8	21.90	187.3	24.57
	14	94.9	12.56	113.4	14.79	131.9	17.23	141.1	18.45	150.4	19.68	168.8	22.34	187.3	25.01
	16	94.9	12.78	113.4	15.12	131.9	17.45	141.1	18.79	150.4	20.12	168.8	22.79	187.3	25.46
	18	94.9	13.01	113.4	15.34	131.9	17.79	141.1	19.12	150.4	20.45	168.8	23.12	187.3	26.01
	20	94.9	13.23	113.4	15.56	131.9	18.12	141.1	19.45	150.4	20.79	168.8	23.57	187.3	26.57
	21	94.9	13.34	113.4	15.67	131.9	18.34	141.1	19.68	150.4	21.01	168.8	23.90	187.3	26.79
	23	94.9	13.56	113.4	16.01	131.9	18.56	141.1	20.01	150.4	21.46	168.8	24.79	187.3	28.46
	25	94.9	13.78	113.4	16.34	131.9	19.34	141.1	21.01	150.4	22.79	168.8	26.46	187.3	30.46
	27	94.9	14.23	113.4	17.23	131.9	20.57	141.1	22.34	150.4	24.23	168.8	28.13	187.3	32.46
	29	94.9	15.12	113.4	18.34	131.9	21.90	141.1	23.79	150.4	25.79	168.8	30.01	187.3	34.68
	31	94.9	16.01	113.4	19.45	131.9	23.23	141.1	25.35	150.4	27.46	168.8	32.02	187.3	36.91
	33	94.9	16.90	113.4	20.57	131.9	24.68	141.1	26.90	150.4	29.24	168.8	34.02	187.3	39.35
	35	94.9	17.90	113.4	21.90	131.9	26.24	141.1	28.57	150.4	31.02	168.8	36.24	187.3	41.80
	37	94.9	18.90	113.4	23.11	131.9	27.79	141.1	30.35	150.4	32.91	168.8	38.46	187.3	44.47
	39	94.9	20.10	113.4	24.61	131.9	30.00	141.1	32.56	150.4	35.41	168.8	41.24	187.3	47.65
	41	92.5	21.80	110.5	26.93	128.5	32.58	137.5	35.57	146.5	38.44	164.5	45.26	182.5	51.78
	43	90.2	23.69	107.8	29.32	125.3	35.51	134.1	38.76	142.9	41.92	160.5	49.41	178.0	56.56
46	84.5	26.53	101.0	32.92	117.5	39.94	125.7	43.57	133.9	47.17	150.4	55.67	166.8	64.44	
48	74.8	23.12	89.3	28.73	103.9	34.90	111.2	38.05	118.5	41.22	133.0	48.69	147.6	56.38	
50	10	79.4	10.58	94.9	12.25	110.0	13.92	117.6	14.93	125.2	15.82	140.3	17.82	156.2	19.83
	12	79.4	10.69	94.9	12.36	110.0	14.15	117.6	15.15	125.2	16.15	140.3	18.16	156.2	20.16
	14	79.4	10.81	94.9	12.59	110.0	14.37	117.6	15.37	125.2	16.37	140.3	18.38	156.2	20.50
	16	79.4	11.03	94.9	12.81	110.0	14.59	117.6	15.71	125.2	16.60	140.3	18.71	156.2	20.83
	18	79.4	11.14	94.9	12.92	110.0	14.82	117.6	15.93	125.2	16.93	140.3	19.05	156.2	21.28
	20	79.4	11.25	94.9	13.14	110.0	15.15	117.6	16.15	125.2	17.27	140.3	19.38	156.2	21.72
	21	79.4	11.36	94.9	13.26	110.0	15.26	117.6	16.37	125.2	17.38	140.3	19.61	156.2	21.94
	23	79.4	11.58	94.9	13.48	110.0	15.48	117.6	16.60	125.2	17.71	140.3	19.94	156.2	22.39
	25	79.4	11.70	94.9	13.70	110.0	15.82	117.6	16.93	125.2	18.27	140.3	20.94	156.2	23.95
	27	79.4	11.92	94.9	14.15	110.0	16.71	117.6	18.05	125.2	19.38	140.3	22.39	156.2	25.51
	29	79.4	12.59	94.9	15.04	110.0	17.71	117.6	19.16	125.2	20.61	140.3	23.73	156.2	27.07
	31	79.4	13.26	94.9	15.93	110.0	18.83	117.6	20.27	125.2	21.94	140.3	25.29	156.2	28.85
	33	79.4	14.04	94.9	16.82	110.0	19.94	117.6	21.50	125.2	23.28	140.3	26.85	156.2	30.74
	35	79.4	14.82	94.9	17.82	110.0	21.05	117.6	22.84	125.2	24.62	140.3	28.41	156.2	32.64
	37	79.4	15.71	94.9	18.83	110.0	22.28	117.6	24.17	125.2	26.07	140.3	30.30	156.2	34.64
	39	79.4	16.75	94.9	20.18	110.0	23.87	117.6	26.02	125.2	27.97	140.3	32.27	156.2	37.42
	41	77.3	18.12	92.5	21.84	107.2	26.10	114.6	28.18	122.0	30.30	136.7	35.38	152.2	40.63
	43	75.4	19.69	90.2	23.76	104.6	28.40	111.8	30.68	118.9	32.99	133.3	38.58	148.5	44.33
46	70.7	22.05	84.5	26.65	98.0	31.86	104.7	34.46	111.5	37.04	124.9	43.40	139.1	49.90	
48	62.5	19.22	74.8	23.24	86.7	27.79	92.6	30.08	98.6	32.32	110.5	37.93	123.1	43.62	

**Note**

1. TC: Total Capacity(kW), PI : Power Input(kW, Comp. + Outdoor fan motor)
2. Capacity tables show the average value of conditions which may occur.

# 7. Capacity Tables

◆ ARUM860LTE5

Cooling Capacity (86HP)

Combination (%)	Outdoor air temp. (DB, °C)	Indoor air temp. (DB/WB, °C)													
		20		23		26		27		28		30		32	
		14	16	18	19	20	22	24	TC	PI	TC	PI	TC	PI	
130	10	238.5	25.83	284.0	31.58	304.4	36.63	313.2	37.37	321.9	37.67	337.4	37.97	346.1	38.12
	12	238.5	26.47	284.0	32.70	304.4	38.13	313.2	38.38	321.9	38.69	337.4	38.99	346.1	39.34
	14	238.5	27.36	284.0	33.89	304.4	39.57	313.2	39.85	321.9	40.17	337.4	40.49	346.1	40.85
	16	238.5	28.36	284.0	35.07	304.4	41.34	313.2	41.72	321.9	42.06	337.4	42.43	346.1	42.77
	18	238.5	29.55	284.0	37.09	304.4	43.24	313.2	44.17	321.9	44.52	337.4	44.96	346.1	45.27
	20	238.5	30.85	284.0	39.52	304.4	45.37	313.2	48.59	321.9	48.98	332.5	49.46	341.2	49.80
	21	238.5	31.66	284.0	40.91	304.4	46.32	313.2	51.42	321.9	51.83	330.6	52.34	339.4	52.70
	23	238.5	33.97	284.0	43.03	304.4	48.73	313.2	56.73	317.8	57.19	325.7	57.76	334.5	58.15
	25	238.5	36.29	284.0	45.51	304.4	52.07	309.4	62.92	313.2	63.42	321.9	64.05	330.6	64.49
	27	238.5	38.83	284.0	48.65	300.6	55.48	304.4	69.27	309.4	69.82	317.8	70.51	325.7	71.00
	29	238.5	41.37	284.0	52.01	295.7	59.69	300.0	76.13	304.4	76.58	313.2	77.27	321.9	77.57
	31	238.5	44.14	283.1	54.78	290.8	63.49	295.7	75.81	300.0	76.26	308.3	76.94	317.0	77.25
	33	238.5	47.03	278.2	58.05	287.0	68.10	291.6	75.11	295.7	75.56	304.4	76.24	312.1	76.54
	35	238.5	50.15	273.3	60.79	282.1	73.76	287.0	74.13	291.6	74.58	299.5	75.25	308.3	75.54
	37	238.5	53.48	269.5	63.79	278.2	72.79	282.1	73.16	287.0	73.59	294.8	74.25	303.5	74.55
	39	238.5	56.95	264.7	67.15	273.3	71.82	278.2	72.18	282.1	72.61	290.8	73.26	299.5	73.55
41	232.4	60.42	253.7	70.51	262.3	70.84	266.2	71.20	271.4	71.62	279.6	72.27	287.2	72.55	
43	226.7	63.72	243.1	69.52	251.6	69.87	255.4	70.22	260.5	70.64	268.5	71.27	275.8	71.55	
46	212.4	68.20	221.8	68.06	229.8	68.41	233.4	68.75	238.3	69.16	245.8	69.78	252.6	70.06	
48	187.9	66.30	192.6	66.50	199.8	66.64	203.0	66.82	207.3	67.40	214.0	67.83	219.9	68.09	
120	10	215.8	23.24	256.6	28.50	280.4	33.86	289.0	36.60	297.5	37.18	313.7	37.32	321.3	37.62
	12	215.8	23.87	256.6	29.46	280.4	35.22	289.0	37.37	297.5	38.55	313.7	39.02	321.3	39.33
	14	215.8	24.69	256.6	30.46	280.4	36.65	289.0	38.79	297.5	39.96	313.7	40.55	321.3	40.88
	16	215.8	25.58	256.6	31.70	280.4	38.07	289.0	40.24	297.5	41.81	313.7	42.33	321.3	42.66
	18	215.8	26.58	256.6	33.13	280.4	39.59	289.0	42.35	297.5	43.96	313.7	44.46	321.3	44.81
	20	215.8	27.59	256.6	35.13	280.4	41.72	289.0	44.57	297.5	46.28	313.7	46.89	321.3	47.27
	21	215.8	28.43	256.6	36.40	280.4	42.89	289.0	45.88	297.5	47.81	313.7	48.42	321.3	48.80
	23	215.8	30.39	256.6	38.94	280.4	45.95	289.0	48.76	297.5	50.97	313.7	51.48	321.3	51.90
	25	215.8	32.47	256.6	41.72	280.4	48.47	289.0	51.97	297.5	54.66	309.9	55.11	317.5	55.56
	27	215.8	34.67	256.6	44.61	280.4	51.58	289.0	55.53	297.5	58.74	305.2	59.13	312.8	59.61
	29	215.8	36.98	256.6	47.61	280.4	54.28	289.0	59.43	292.7	62.60	300.4	63.54	308.9	64.05
	31	215.8	39.41	256.6	50.85	280.4	57.09	285.2	63.66	289.0	67.15	296.6	68.34	304.1	68.89
	33	215.8	41.95	256.6	54.20	276.7	60.38	280.4	69.10	284.2	72.10	291.8	72.92	299.5	73.51
	35	215.8	44.61	256.6	57.78	271.9	63.91	275.6	76.13	280.4	76.51	288.1	76.73	295.6	77.34
	37	215.8	47.98	256.6	60.97	268.0	68.14	271.9	74.52	275.6	74.90	283.3	75.12	290.9	75.72
	39	215.8	51.65	255.7	64.44	263.3	72.27	267.1	72.99	270.9	73.36	279.5	73.58	287.0	74.16
41	210.3	55.33	244.6	67.91	252.8	70.85	256.4	71.46	260.1	71.82	267.6	72.03	275.3	72.61	
43	205.1	59.05	234.3	66.94	242.4	69.26	245.9	69.93	249.6	70.28	256.9	70.49	264.3	71.05	
46	192.2	63.50	213.6	65.34	221.4	67.09	224.7	67.64	228.1	67.97	235.0	68.18	241.9	68.72	
48	170.0	62.20	185.5	64.18	192.4	65.78	195.3	66.17	198.3	66.39	204.4	66.65	210.6	66.92	
110	10	193.3	20.90	230.5	25.48	257.5	30.27	264.8	32.76	281.6	35.26	288.2	36.24	307.6	36.84
	12	193.3	21.56	230.5	26.34	257.5	31.52	264.8	33.68	281.6	36.58	288.2	37.76	307.6	38.63
	14	193.3	22.23	230.5	27.53	257.5	32.95	264.8	35.35	281.6	38.42	288.2	39.52	307.6	40.35
	16	193.3	23.02	230.5	28.53	257.5	34.31	264.8	36.90	281.6	40.19	288.2	41.29	307.6	42.02
	18	193.3	23.87	230.5	29.72	257.5	36.29	264.8	38.85	281.6	42.40	288.2	43.24	307.6	44.04
	20	193.3	24.73	230.5	31.20	257.5	38.48	264.8	40.64	281.6	44.46	288.2	45.55	307.6	46.28
	21	193.3	25.27	230.5	32.13	257.5	39.47	264.8	41.73	281.6	45.69	288.2	46.85	307.6	47.58
	23	193.3	26.93	230.5	34.44	257.5	41.67	264.8	44.06	281.6	48.28	288.2	49.31	307.6	50.13
	25	193.3	28.77	230.5	36.75	257.5	44.02	264.8	46.58	281.6	51.00	288.2	51.73	303.9	52.79
	27	193.3	30.74	230.5	39.29	257.5	46.52	264.8	49.29	281.6	53.27	288.2	54.49	299.4	55.41
	29	193.3	32.82	230.5	41.95	257.5	49.16	264.8	52.20	281.6	56.29	288.2	57.26	295.6	58.13
	31	193.3	34.90	230.5	44.72	257.5	51.95	264.8	55.31	277.0	59.15	284.4	60.31	290.9	60.94
	33	193.3	37.21	230.5	47.61	257.5	54.89	264.8	58.61	273.2	62.47	279.8	63.50	287.1	63.85
	35	193.3	39.52	230.5	50.85	257.5	57.97	264.8	62.11	268.6	65.92	275.1	66.53	282.6	66.86
	37	193.3	41.89	230.5	53.96	257.5	61.20	261.2	65.80	263.9	69.53	271.4	69.77	277.9	69.97
	39	193.3	45.16	230.5	57.35	252.8	64.57	256.5	70.38	260.3	72.98	266.7	73.10	274.2	73.17
41	188.4	48.43	224.6	60.73	242.0	68.09	245.8	76.13	248.9	76.13	256.2	76.73	262.6	77.34	
43	183.7	50.85	219.0	63.27	231.9	72.21	235.7	73.02	238.8	72.86	245.9	73.28	252.1	73.48	
46	172.2	49.64	205.3	61.08	211.6	68.53	215.3	68.53	218.1	69.12	224.7	69.50	230.6	69.69	
48	152.3	48.21	178.4	58.84	183.8	65.20	187.1	65.64	189.6	65.95	195.5	66.14	200.6	66.40	

# 7. Capacity Tables

Cooling Capacity (86HP)

Combination (%)	Outdoor air temp. (DB, °C)	Indoor air temp. (DB/WB, °C)													
		20		23		26		27		28		30		32	
		14		16		18		19		20		22		24	
		TC	PI	TC	PI	TC	PI	TC	PI	TC	PI	TC	PI	TC	PI
100	10	162.5	18.82	193.5	22.88	225.3	27.14	240.8	29.33	256.3	31.51	284.1	35.08	290.4	35.36
	12	162.5	19.43	193.5	23.81	225.3	28.06	240.8	30.12	256.3	32.52	284.1	36.97	290.4	37.33
	14	162.5	20.04	193.5	24.76	225.3	29.25	240.8	31.42	256.3	33.92	284.1	39.04	290.4	39.40
	16	162.5	20.65	193.5	25.59	225.3	30.49	240.8	32.91	256.3	35.75	284.1	40.92	290.4	41.49
	18	162.5	21.25	193.5	26.54	225.3	31.67	240.8	34.52	256.3	37.90	284.1	43.23	290.4	43.58
	20	162.5	22.02	193.5	27.54	225.3	33.51	240.8	36.98	256.3	40.56	284.1	45.30	290.4	45.67
	21	162.5	22.47	193.5	28.20	225.3	34.67	240.8	38.25	256.3	42.06	284.1	46.34	290.4	46.71
	23	162.5	23.81	193.5	30.16	225.3	37.21	240.8	41.02	256.3	45.07	284.1	48.52	290.4	48.91
	25	162.5	25.31	193.5	32.13	225.3	39.75	240.8	43.91	256.3	48.19	284.1	50.59	287.9	51.00
	27	162.5	27.04	193.5	34.32	225.3	42.53	240.8	46.92	256.3	51.24	284.1	52.97	284.5	53.40
	29	162.5	28.77	193.5	36.63	225.3	45.41	240.8	50.15	256.3	54.23	273.4	55.11	280.2	55.55
	31	162.5	30.74	193.5	39.06	225.3	48.42	240.8	53.50	256.3	56.98	269.3	57.24	275.9	57.70
	33	162.5	32.59	193.5	41.60	225.3	51.66	240.8	57.09	256.3	59.12	265.0	59.37	271.6	59.85
	35	162.5	34.67	193.5	44.26	225.3	55.01	240.8	60.90	252.4	61.27	260.2	61.50	266.8	62.00
	37	162.5	37.13	193.5	47.47	225.3	58.27	240.8	63.80	248.2	64.11	255.4	64.37	261.4	64.97
	39	162.5	39.81	193.5	51.00	225.3	61.74	240.8	66.92	244.1	67.21	251.3	67.47	257.1	68.09
	41	160.0	42.48	190.4	54.52	221.7	65.22	231.0	70.04	236.1	70.32	241.7	70.56	249.5	71.22
43	154.5	44.96	183.9	57.80	214.1	68.34	221.5	72.71	224.1	72.97	231.0	73.21	237.1	73.90	
46	144.8	48.36	172.3	62.31	200.7	72.49	202.3	76.13	204.5	76.35	211.0	76.57	216.7	77.30	
48	128.1	41.76	152.4	53.91	173.2	61.97	175.8	64.59	177.6	64.80	183.4	64.95	188.5	65.47	
90	10	146.2	17.40	174.6	20.92	203.0	24.65	216.7	26.57	230.5	28.60	258.9	32.01	287.2	35.36
	12	146.2	17.61	174.6	21.24	203.0	25.08	216.7	27.11	230.5	29.24	258.9	32.65	287.2	36.23
	14	146.2	17.93	174.6	21.66	203.0	25.61	216.7	27.64	230.5	29.77	258.9	33.28	287.2	36.97
	16	146.2	18.25	174.6	22.09	203.0	26.15	216.7	28.17	230.5	30.31	258.9	33.91	287.2	37.60
	18	146.2	18.57	174.6	22.52	203.0	26.57	216.7	28.81	230.5	30.95	258.9	34.65	287.2	39.49
	20	146.2	18.89	174.6	22.94	203.0	27.11	216.7	29.35	230.5	32.12	258.9	37.08	287.2	41.38
	21	146.2	19.10	174.6	23.16	203.0	27.64	216.7	30.31	230.5	33.30	258.9	37.69	287.2	42.32
	23	146.2	19.53	174.6	24.12	203.0	29.56	216.7	32.55	230.5	35.64	258.9	39.97	283.3	44.32
	25	146.2	20.49	174.6	25.72	203.0	31.59	216.7	34.79	230.5	38.10	258.9	42.74	279.2	46.21
	27	146.2	21.88	174.6	27.43	203.0	33.72	216.7	37.14	230.5	40.77	258.9	45.44	275.1	48.38
	29	146.2	23.16	174.6	29.24	203.0	36.07	216.7	39.70	230.5	43.54	258.9	48.13	271.0	50.33
	31	146.2	24.65	174.6	31.16	203.0	38.42	216.7	42.26	230.5	46.42	258.9	50.53	266.9	52.28
	33	146.2	26.25	174.6	33.19	203.0	40.98	216.7	45.04	230.5	49.24	258.9	52.97	262.8	54.23
	35	146.2	27.85	174.6	35.22	203.0	43.54	216.7	48.02	230.5	52.21	254.4	56.01	258.7	57.30
	37	146.2	29.56	174.6	37.46	203.0	46.43	216.7	51.02	230.5	55.12	250.3	58.55	254.6	59.87
	39	146.2	31.30	174.6	39.84	203.0	49.14	216.7	54.29	230.5	57.96	246.2	61.73	250.6	62.47
	41	142.5	35.02	170.1	44.17	197.8	53.93	211.2	59.37	224.6	62.57	235.9	65.06	240.2	66.55
43	138.9	37.80	165.9	47.73	192.9	58.91	206.0	63.94	219.0	67.09	226.2	69.66	230.3	70.51	
46	130.2	42.55	155.5	54.36	180.8	67.12	193.0	72.49	199.0	74.54	206.5	76.35	210.4	76.55	
48	115.2	37.19	137.5	47.55	159.9	58.73	170.7	63.24	172.8	64.20	179.5	64.95	182.9	65.47	
80	10	129.9	16.22	154.8	19.49	179.7	22.86	192.6	24.67	205.5	26.47	230.5	30.19	255.4	32.77
	12	129.9	16.56	154.8	19.71	179.7	23.31	192.6	25.12	205.5	26.92	230.5	30.75	255.4	33.42
	14	129.9	16.78	154.8	20.16	179.7	23.65	192.6	25.57	205.5	27.37	230.5	31.31	255.4	34.07
	16	129.9	17.01	154.8	20.50	179.7	24.10	192.6	26.02	205.5	27.93	230.5	31.99	255.4	34.72
	18	129.9	17.35	154.8	20.84	179.7	24.55	192.6	26.47	205.5	28.50	230.5	32.55	255.4	35.48
	20	129.9	17.68	154.8	21.29	179.7	25.12	192.6	27.03	205.5	29.06	230.5	33.79	255.4	37.58
	21	129.9	17.80	154.8	21.51	179.7	25.34	192.6	27.37	205.5	29.73	230.5	34.86	255.4	38.58
	23	129.9	18.13	154.8	21.85	179.7	26.47	192.6	29.06	205.5	31.76	230.5	36.80	255.4	40.50
	25	129.9	18.81	154.8	23.31	179.7	28.38	192.6	31.09	205.5	34.01	230.5	39.38	255.4	43.30
	27	129.9	19.94	154.8	24.78	179.7	30.30	192.6	33.23	205.5	36.27	230.5	41.85	255.4	45.56
	29	129.9	21.17	154.8	26.47	179.7	32.21	192.6	35.37	205.5	38.75	230.5	44.84	255.4	47.81
	31	129.9	22.53	154.8	28.05	179.7	34.35	192.6	37.73	205.5	41.22	230.5	47.58	255.4	50.19
	33	129.9	23.88	154.8	29.96	179.7	36.61	192.6	40.21	205.5	43.93	230.5	50.14	255.4	52.60
	35	129.9	25.34	154.8	31.76	179.7	38.97	192.6	42.80	205.5	46.85	230.5	53.16	252.7	55.58
	37	129.9	26.81	154.8	33.77	179.7	41.34	192.6	45.50	205.5	49.78	230.5	56.10	248.6	58.16
	39	129.9	28.33	154.8	35.70	179.7	44.22	192.6	48.92	205.5	53.50	230.5	59.27	244.5	61.36
	41	126.5	31.34	150.8	39.56	175.1	48.53	187.7	53.62	200.3	58.79	224.6	63.76	234.3	65.22
43	123.4	34.50	147.1	43.17	170.8	52.97	183.1	58.44	195.3	64.24	219.0	68.27	224.6	69.80	
46	115.7	38.38	137.9	48.63	160.1	59.69	171.6	65.04	183.1	72.49	200.3	76.35	205.0	76.55	
48	102.3	33.52	122.0	42.52	141.6	52.20	151.8	56.82	161.9	63.45	174.0	64.95	178.1	65.47	

# 7. Capacity Tables

Cooling Capacity (86HP)

Combination (%)	Outdoor air temp. (DB, °C)	Indoor air temp. (DB/WB, °C)													
		20		23		26		27		28		30		32	
		14		16		18		19		20		22		24	
		TC	PI	TC	PI	TC	PI	TC	PI	TC	PI	TC	PI	TC	PI
70	10	113.5	14.34	135.9	17.05	157.4	19.76	168.6	21.34	179.7	22.81	201.2	25.97	223.6	29.05
	12	113.5	14.57	135.9	17.28	157.4	20.21	168.6	21.68	179.7	23.26	201.2	26.42	223.6	29.60
	14	113.5	14.79	135.9	17.50	157.4	20.55	168.6	22.02	179.7	23.60	201.2	26.99	223.6	30.14
	16	113.5	15.02	135.9	17.84	157.4	20.89	168.6	22.47	179.7	24.05	201.2	27.44	223.6	30.79
	18	113.5	15.25	135.9	18.18	157.4	21.34	168.6	22.92	179.7	24.51	201.2	27.89	223.6	31.33
	20	113.5	15.47	135.9	18.52	157.4	21.68	168.6	23.38	179.7	25.07	201.2	28.57	223.6	32.52
	21	113.5	15.70	135.9	18.63	157.4	21.91	168.6	23.60	179.7	25.30	201.2	29.02	223.6	33.21
	23	113.5	15.92	135.9	19.08	157.4	22.36	168.6	24.39	179.7	26.54	201.2	31.05	223.6	35.07
	25	113.5	16.15	135.9	19.76	157.4	23.83	168.6	26.09	179.7	28.34	201.2	33.20	223.6	36.77
	27	113.5	17.05	135.9	21.12	157.4	25.41	168.6	27.67	179.7	30.26	201.2	35.46	223.6	39.07
	29	113.5	18.18	135.9	22.36	157.4	26.99	168.6	29.47	179.7	32.18	201.2	37.83	223.6	41.86
	31	113.5	19.31	135.9	23.83	157.4	28.80	168.6	31.51	179.7	34.33	201.2	40.31	223.6	44.42
	33	113.5	20.44	135.9	25.18	157.4	30.60	168.6	33.43	179.7	36.48	201.2	42.91	223.6	47.29
	35	113.5	21.57	135.9	26.89	157.4	32.52	168.6	35.57	179.7	38.85	201.2	45.74	223.6	50.14
	37	113.5	22.92	135.9	28.47	157.4	34.56	168.6	37.83	179.7	41.33	201.2	48.67	223.6	52.92
	39	113.5	24.34	135.9	30.35	157.4	36.95	168.6	40.70	179.7	44.65	201.2	52.09	223.6	57.05
	41	110.6	26.91	132.4	33.25	153.4	40.53	164.2	44.64	175.1	48.54	196.1	57.21	217.9	61.55
	43	107.9	29.30	129.1	36.24	149.6	44.22	160.2	48.68	170.8	53.00	191.2	62.50	212.5	66.55
46	101.1	32.56	121.0	40.75	140.2	49.80	150.1	54.22	160.1	59.75	179.2	70.49	199.1	74.17	
48	89.4	28.41	107.0	35.60	124.0	43.54	132.8	47.39	141.6	52.27	158.5	61.69	176.2	64.19	
60	10	97.2	12.45	116.1	14.61	135.0	16.98	144.5	18.23	153.9	19.36	172.9	21.97	191.8	24.57
	12	97.2	12.68	116.1	14.83	135.0	17.21	144.5	18.46	153.9	19.70	172.9	22.30	191.8	25.02
	14	97.2	12.79	116.1	15.06	135.0	17.55	144.5	18.79	153.9	20.04	172.9	22.76	191.8	25.47
	16	97.2	13.02	116.1	15.40	135.0	17.78	144.5	19.13	153.9	20.49	172.9	23.21	191.8	25.93
	18	97.2	13.25	116.1	15.62	135.0	18.12	144.5	19.47	153.9	20.83	172.9	23.55	191.8	26.49
	20	97.2	13.47	116.1	15.85	135.0	18.46	144.5	19.81	153.9	21.17	172.9	24.00	191.8	27.06
	21	97.2	13.59	116.1	15.96	135.0	18.68	144.5	20.04	153.9	21.40	172.9	24.34	191.8	27.29
	23	97.2	13.81	116.1	16.30	135.0	18.91	144.5	20.38	153.9	21.85	172.9	25.25	191.8	28.98
	25	97.2	14.04	116.1	16.64	135.0	19.70	144.5	21.40	153.9	23.21	172.9	26.95	191.8	31.02
	27	97.2	14.49	116.1	17.55	135.0	20.95	144.5	22.76	153.9	24.68	172.9	28.65	191.8	33.06
	29	97.2	15.40	116.1	18.68	135.0	22.30	144.5	24.23	153.9	26.27	172.9	30.57	191.8	35.33
	31	97.2	16.30	116.1	19.81	135.0	23.66	144.5	25.81	153.9	27.97	172.9	32.61	191.8	37.59
	33	97.2	17.21	116.1	20.95	135.0	25.14	144.5	27.40	153.9	29.78	172.9	34.65	191.8	40.08
	35	97.2	18.23	116.1	22.30	135.0	26.72	144.5	29.10	153.9	31.59	172.9	36.91	191.8	42.57
	37	97.2	19.25	116.1	23.54	135.0	28.31	144.5	30.91	153.9	33.51	172.9	39.17	191.8	45.29
	39	97.2	20.47	116.1	25.06	135.0	30.55	144.5	33.16	153.9	36.07	172.9	42.00	191.8	48.53
	41	94.7	22.20	113.1	27.43	131.6	33.18	140.8	36.23	150.0	39.15	168.4	46.10	186.9	52.74
	43	92.4	24.13	110.3	29.86	128.3	36.17	137.3	39.48	146.3	42.69	164.3	50.32	182.3	57.60
46	86.5	27.02	103.4	33.53	120.2	40.68	128.7	44.38	137.1	48.04	153.9	56.70	170.8	65.63	
48	76.6	23.54	91.5	29.26	106.4	35.54	113.8	38.76	121.3	41.98	136.2	49.59	151.1	57.42	
50	10	81.3	10.78	97.2	12.49	112.7	14.19	120.4	15.21	128.1	16.12	143.6	18.16	160.0	20.21
	12	81.3	10.90	97.2	12.60	112.7	14.42	120.4	15.44	128.1	16.46	143.6	18.50	160.0	20.55
	14	81.3	11.01	97.2	12.83	112.7	14.64	120.4	15.67	128.1	16.69	143.6	18.73	160.0	20.89
	16	81.3	11.24	97.2	13.05	112.7	14.87	120.4	16.01	128.1	16.91	143.6	19.07	160.0	21.23
	18	81.3	11.35	97.2	13.17	112.7	15.10	120.4	16.23	128.1	17.25	143.6	19.41	160.0	21.68
	20	81.3	11.47	97.2	13.40	112.7	15.44	120.4	16.46	128.1	17.60	143.6	19.75	160.0	22.14
	21	81.3	11.58	97.2	13.51	112.7	15.55	120.4	16.69	128.1	17.71	143.6	19.98	160.0	22.36
	23	81.3	11.81	97.2	13.74	112.7	15.78	120.4	16.91	128.1	18.05	143.6	20.32	160.0	22.82
	25	81.3	11.92	97.2	13.96	112.7	16.12	120.4	17.25	128.1	18.62	143.6	21.34	160.0	24.41
	27	81.3	12.15	97.2	14.42	112.7	17.03	120.4	18.39	128.1	19.75	143.6	22.82	160.0	26.00
	29	81.3	12.83	97.2	15.32	112.7	18.05	120.4	19.53	128.1	21.00	143.6	24.18	160.0	27.58
	31	81.3	13.51	97.2	16.23	112.7	19.18	120.4	20.66	128.1	22.36	143.6	25.77	160.0	29.40
	33	81.3	14.30	97.2	17.14	112.7	20.32	120.4	21.91	128.1	23.73	143.6	27.36	160.0	31.33
	35	81.3	15.10	97.2	18.16	112.7	21.45	120.4	23.27	128.1	25.09	143.6	28.95	160.0	33.26
	37	81.3	16.01	97.2	19.18	112.7	22.70	120.4	24.63	128.1	26.56	143.6	30.88	160.0	35.30
	39	81.3	17.07	97.2	20.56	112.7	24.33	120.4	26.52	128.1	28.50	143.6	32.89	160.0	38.13
	41	79.2	18.46	94.7	22.26	109.8	26.60	117.3	28.72	124.9	30.88	139.9	36.05	155.9	41.41
	43	77.2	20.06	92.4	24.21	107.1	28.94	114.4	31.27	121.8	33.62	136.5	39.31	152.0	45.17
46	72.4	22.47	86.5	27.16	100.3	32.47	107.2	35.12	114.1	37.75	127.9	44.23	142.5	50.86	
48	64.0	19.58	76.6	23.69	88.8	28.32	94.9	30.65	101.0	32.94	113.1	38.65	126.0	44.45	

**Note**

1. TC: Total Capacity(kW), PI : Power Input(kW, Comp. + Outdoor fan motor)
2. Capacity tables show the average value of conditions which may occur.

# 7. Capacity Tables

◆ ARUM880LTE5

Cooling Capacity (88HP)

Combination (%)	Outdoor air temp. (DB, °C)	Indoor air temp. (DB/WB, °C)													
		20		23		26		27		28		30		32	
		14		16		18		19		20		22		24	
		TC	PI	TC	PI	TC	PI	TC	PI	TC	PI	TC	PI	TC	PI
130	10	244.1	26.78	290.6	32.73	311.5	37.97	320.4	38.74	329.4	39.05	345.2	39.36	354.2	39.51
	12	244.1	27.44	290.6	33.90	311.5	39.53	320.4	39.79	329.4	40.10	345.2	40.42	354.2	40.78
	14	244.1	28.36	290.6	35.13	311.5	41.02	320.4	41.31	329.4	41.64	345.2	41.97	354.2	42.35
	16	244.1	29.40	290.6	36.35	311.5	42.85	320.4	43.25	329.4	43.60	345.2	43.99	354.2	44.33
	18	244.1	30.63	290.6	38.45	311.5	44.82	320.4	45.79	329.4	46.15	345.2	46.61	354.2	46.93
	20	244.1	31.98	290.6	40.97	311.5	47.03	320.4	50.37	329.4	50.77	340.2	51.27	349.2	51.63
	21	244.1	32.82	290.6	42.41	311.5	48.02	320.4	53.30	329.4	53.73	338.3	54.26	347.3	54.63
	23	244.1	35.22	290.6	44.61	311.5	50.52	320.4	58.81	325.2	59.28	333.3	59.87	342.2	60.28
	25	244.1	37.61	290.6	47.18	311.5	53.98	316.6	65.22	320.4	65.75	329.4	66.40	338.3	66.85
	27	244.1	40.25	290.6	50.43	307.6	57.51	311.5	71.80	316.6	72.38	325.2	73.10	333.3	73.60
	29	244.1	42.89	290.6	53.92	302.6	61.88	307.0	78.91	311.5	79.39	320.4	80.10	329.4	80.41
	31	244.1	45.76	289.7	56.79	297.6	65.82	302.6	78.58	307.0	79.05	315.4	79.76	324.4	80.08
	33	244.1	48.76	284.7	60.17	293.6	70.59	298.4	77.86	302.6	78.33	311.5	79.03	319.4	79.34
	35	244.1	51.99	279.7	63.02	288.6	76.47	293.6	76.85	298.4	77.31	306.5	78.00	315.4	78.31
	37	244.1	55.44	275.8	66.13	284.7	75.46	288.6	75.83	293.6	76.29	301.6	76.97	310.5	77.28
	39	244.1	59.03	270.9	69.61	279.7	74.45	284.7	74.82	288.6	75.27	297.6	75.94	306.5	76.24
	41	237.8	62.63	259.6	73.09	268.4	73.44	272.4	73.80	277.7	74.25	286.1	74.91	293.8	75.21
	43	231.9	66.05	248.8	72.06	257.4	72.43	261.4	72.79	266.6	73.23	274.8	73.88	282.3	74.17
46	217.3	70.70	227.0	70.55	235.2	70.91	238.9	71.27	243.8	71.69	251.5	72.34	258.5	72.62	
48	192.3	68.73	197.1	68.93	204.5	69.08	207.7	69.27	212.2	69.87	219.0	70.31	225.1	70.59	
120	10	220.8	24.09	262.6	29.54	287.0	35.10	295.7	37.94	304.4	38.54	321.0	38.69	328.8	39.00
	12	220.8	24.74	262.6	30.54	287.0	36.51	295.7	38.74	304.4	39.96	321.0	40.45	328.8	40.77
	14	220.8	25.59	262.6	31.58	287.0	37.99	295.7	40.21	304.4	41.43	321.0	42.04	328.8	42.38
	16	220.8	26.52	262.6	32.86	287.0	39.46	295.7	41.71	304.4	43.35	321.0	43.88	328.8	44.23
	18	220.8	27.56	262.6	34.35	287.0	41.03	295.7	43.91	304.4	45.57	321.0	46.08	328.8	46.45
	20	220.8	28.60	262.6	36.42	287.0	43.24	295.7	46.20	304.4	47.98	321.0	48.61	328.8	49.00
	21	220.8	29.47	262.6	37.73	287.0	44.46	295.7	47.56	304.4	49.56	321.0	50.19	328.8	50.59
	23	220.8	31.51	262.6	40.37	287.0	47.64	295.7	50.54	304.4	52.83	321.0	53.37	328.8	53.80
	25	220.8	33.66	262.6	43.24	287.0	50.24	295.7	53.88	304.4	56.66	317.2	57.13	324.8	57.59
	27	220.8	35.94	262.6	46.24	287.0	53.46	295.7	57.56	304.4	60.89	312.3	61.30	320.1	61.79
	29	220.8	38.33	262.6	49.35	287.0	56.26	295.7	61.60	299.5	64.89	307.4	65.87	316.1	66.40
	31	220.8	40.85	262.6	52.71	287.0	59.18	291.8	66.00	295.7	69.61	303.5	70.84	311.2	71.41
	33	220.8	43.48	262.6	56.18	283.1	62.60	287.0	71.63	290.8	74.74	298.6	75.59	306.4	76.20
	35	220.8	46.24	262.6	59.90	278.2	66.25	282.1	78.91	287.0	79.31	294.8	79.54	302.5	80.18
	37	220.8	49.74	262.6	63.20	274.2	70.64	278.2	77.25	282.1	77.64	289.9	77.87	297.7	78.49
	39	220.8	53.54	261.7	66.80	269.5	74.92	273.3	75.67	277.2	76.04	286.0	76.27	293.7	76.88
	41	215.2	57.35	250.2	70.39	258.7	73.44	262.3	74.08	266.2	74.45	273.9	74.67	281.7	75.26
	43	209.9	61.21	239.7	69.39	248.1	71.80	251.6	72.49	255.4	72.85	262.9	73.07	270.5	73.65
46	196.7	65.82	218.6	67.73	226.5	69.54	229.9	70.11	233.4	70.46	240.4	70.67	247.5	71.23	
48	174.0	64.48	189.8	66.53	196.9	68.18	199.9	68.60	202.9	68.82	209.2	69.09	215.5	69.37	
110	10	197.8	21.67	235.8	26.41	263.5	31.37	271.0	33.96	288.2	36.55	294.9	37.56	314.8	38.19
	12	197.8	22.35	235.8	27.30	263.5	32.67	271.0	34.92	288.2	37.92	294.9	39.14	314.8	40.05
	14	197.8	23.04	235.8	28.53	263.5	34.16	271.0	36.65	288.2	39.83	294.9	40.96	314.8	41.83
	16	197.8	23.86	235.8	29.57	263.5	35.57	271.0	38.25	288.2	41.67	294.9	42.80	314.8	43.56
	18	197.8	24.75	235.8	30.80	263.5	37.61	271.0	40.27	288.2	43.95	294.9	44.82	314.8	45.66
	20	197.8	25.63	235.8	32.34	263.5	39.89	271.0	42.13	288.2	46.08	294.9	47.22	314.8	47.98
	21	197.8	26.20	235.8	33.30	263.5	40.91	271.0	43.26	288.2	47.37	294.9	48.57	314.8	49.32
	23	197.8	27.91	235.8	35.70	263.5	43.20	271.0	45.67	288.2	50.04	294.9	51.12	314.8	51.96
	25	197.8	29.83	235.8	38.09	263.5	45.64	271.0	48.28	288.2	52.87	294.9	53.63	310.9	54.73
	27	197.8	31.86	235.8	40.73	263.5	48.23	271.0	51.10	288.2	55.22	294.9	56.48	306.3	57.44
	29	197.8	34.02	235.8	43.48	263.5	50.96	271.0	54.12	288.2	58.35	294.9	59.36	302.5	60.26
	31	197.8	36.18	235.8	46.36	263.5	53.86	271.0	57.33	283.4	61.32	291.0	62.52	297.7	63.17
	33	197.8	38.57	235.8	49.35	263.5	56.90	271.0	60.76	279.6	64.75	286.3	65.83	293.8	66.19
	35	197.8	40.97	235.8	52.71	263.5	60.09	271.0	64.38	274.9	68.34	281.5	68.97	289.1	69.31
	37	197.8	43.42	235.8	55.94	263.5	63.44	267.2	68.21	270.1	72.08	277.7	72.33	284.4	72.53
	39	197.8	46.81	235.8	59.45	258.7	66.94	262.4	72.96	266.3	75.65	272.9	75.77	280.6	75.85
	41	192.8	50.20	229.8	62.95	247.6	70.59	251.5	78.91	254.7	78.91	262.2	79.54	268.7	80.18
	43	188.0	52.72	224.1	65.58	237.3	74.85	241.2	75.70	244.3	75.53	251.6	75.96	257.9	76.17
46	176.2	51.45	210.0	63.31	216.5	71.04	220.3	71.04	223.1	71.65	230.0	72.05	235.9	72.24	
48	155.9	49.97	182.6	60.99	188.0	67.59	191.5	68.04	194.0	68.37	200.0	68.56	205.3	68.84	

# 7. Capacity Tables

Cooling Capacity (88HP)

Combination (%)	Outdoor air temp. (DB, °C)	Indoor air temp. (DB/WB, °C)													
		20		23		26		27		28		30		32	
		14		16		18		19		20		22		24	
		TC	PI	TC	PI	TC	PI	TC	PI	TC	PI	TC	PI	TC	PI
100	10	166.3	19.51	198.0	23.72	230.6	28.14	246.4	30.40	262.2	32.67	290.8	36.37	297.1	36.66
	12	166.3	20.14	198.0	24.69	230.6	29.09	246.4	31.22	262.2	33.71	290.8	38.32	297.1	38.70
	14	166.3	20.77	198.0	25.67	230.6	30.32	246.4	32.57	262.2	35.16	290.8	40.47	297.1	40.85
	16	166.3	21.40	198.0	26.52	230.6	31.61	246.4	34.12	262.2	37.06	290.8	42.42	297.1	43.01
	18	166.3	22.03	198.0	27.51	230.6	32.83	246.4	35.79	262.2	39.29	290.8	44.82	297.1	45.17
	20	166.3	22.82	198.0	28.55	230.6	34.74	246.4	38.33	262.2	42.05	290.8	46.96	297.1	47.34
	21	166.3	23.29	198.0	29.23	230.6	35.94	246.4	39.65	262.2	43.60	290.8	48.03	297.1	48.42
	23	166.3	24.68	198.0	31.27	230.6	38.57	246.4	42.53	262.2	46.72	290.8	50.30	297.1	50.70
	25	166.3	26.23	198.0	33.30	230.6	41.21	246.4	45.52	262.2	49.95	290.8	52.44	294.6	52.86
	27	166.3	28.03	198.0	35.58	230.6	44.08	246.4	48.64	262.2	53.11	285.1	54.91	291.1	55.35
	29	166.3	29.83	198.0	37.97	230.6	47.08	246.4	51.99	262.2	56.21	279.8	57.12	286.7	57.58
	31	166.3	31.86	198.0	40.49	230.6	50.19	246.4	55.46	262.2	59.06	275.6	59.33	282.3	59.81
	33	166.3	33.78	198.0	43.12	230.6	53.55	246.4	59.18	262.2	61.29	271.2	61.55	277.9	62.04
	35	166.3	35.94	198.0	45.88	230.6	57.02	246.4	63.13	258.2	63.51	266.2	63.76	273.0	64.27
	37	166.3	38.49	198.0	49.21	230.6	60.40	246.4	66.14	254.0	66.46	261.3	66.73	267.5	67.35
	39	166.3	41.26	198.0	52.86	230.6	64.00	246.4	69.37	249.8	69.68	257.1	69.94	263.1	70.59
	41	163.7	44.04	194.9	56.51	226.9	67.61	236.4	72.60	241.6	72.89	247.3	73.15	255.3	73.83
	43	158.1	46.61	188.2	59.91	219.1	70.84	226.7	75.38	229.3	75.65	236.4	75.89	242.6	76.61
46	148.1	50.13	176.3	64.59	205.3	75.14	207.0	78.91	209.2	79.14	215.9	79.38	221.7	80.13	
48	131.0	43.29	156.0	55.88	177.3	64.24	179.9	66.96	181.7	67.17	187.7	67.32	192.8	67.86	
90	10	149.6	18.07	178.6	21.73	207.7	25.61	221.8	27.61	235.8	29.71	264.9	33.26	293.9	36.66
	12	149.6	18.29	178.6	22.06	207.7	26.05	221.8	28.16	235.8	30.38	264.9	33.92	293.9	37.64
	14	149.6	18.63	178.6	22.51	207.7	26.61	221.8	28.71	235.8	30.93	264.9	34.57	293.9	38.40
	16	149.6	18.96	178.6	22.95	207.7	27.16	221.8	29.27	235.8	31.49	264.9	35.23	293.9	39.06
	18	149.6	19.29	178.6	23.39	207.7	27.61	221.8	29.93	235.8	32.15	264.9	36.00	293.9	41.02
	20	149.6	19.62	178.6	23.84	207.7	28.16	221.8	30.49	235.8	33.37	264.9	38.53	293.9	42.98
	21	149.6	19.85	178.6	24.06	207.7	28.71	221.8	31.49	235.8	34.59	264.9	39.15	293.9	43.97
	23	149.6	20.29	178.6	25.06	207.7	30.71	221.8	33.81	235.8	37.03	264.9	41.52	289.9	46.04
	25	149.6	21.29	178.6	26.72	207.7	32.82	221.8	36.14	235.8	39.58	264.9	44.40	285.7	48.00
	27	149.6	22.73	178.6	28.49	207.7	35.03	221.8	38.58	235.8	42.35	264.9	47.20	281.5	50.26
	29	149.6	24.06	178.6	30.38	207.7	37.47	221.8	41.24	235.8	45.23	264.9	50.00	277.3	52.29
	31	149.6	25.61	178.6	32.37	207.7	39.91	221.8	43.90	235.8	48.23	264.9	52.49	273.1	54.31
	33	149.6	27.27	178.6	34.48	207.7	42.57	221.8	46.79	235.8	51.15	264.9	55.03	268.9	56.33
	35	149.6	28.94	178.6	36.59	207.7	45.23	221.8	49.89	235.8	54.24	260.3	58.19	264.8	59.52
	37	149.6	30.71	178.6	38.91	207.7	48.23	221.8	53.00	235.8	57.26	256.1	60.83	260.6	62.19
	39	149.6	32.51	178.6	41.39	207.7	51.05	221.8	56.40	235.8	60.21	251.9	64.13	256.4	64.90
	41	145.8	36.38	174.1	45.89	202.4	56.03	216.1	61.68	229.8	65.00	241.4	67.59	245.7	69.13
	43	142.2	39.27	169.8	49.59	197.4	61.20	210.7	66.42	224.1	69.70	231.5	72.34	235.7	73.25
46	133.2	44.20	159.1	56.47	185.0	69.73	197.5	75.31	203.6	77.43	211.3	79.16	215.3	79.38	
48	117.9	38.63	140.7	49.40	163.6	61.01	174.7	65.69	176.8	66.57	183.6	67.32	187.1	67.86	
80	10	132.9	16.85	158.4	20.24	183.9	23.76	197.1	25.63	210.3	27.50	235.8	31.36	261.4	34.05
	12	132.9	17.20	158.4	20.48	183.9	24.22	197.1	26.10	210.3	27.97	235.8	31.95	261.4	34.72
	14	132.9	17.44	158.4	20.95	183.9	24.57	197.1	26.56	210.3	28.44	235.8	32.53	261.4	35.40
	16	132.9	17.67	158.4	21.30	183.9	25.04	197.1	27.03	210.3	29.02	235.8	33.23	261.4	36.07
	18	132.9	18.02	158.4	21.65	183.9	25.51	197.1	27.50	210.3	29.61	235.8	33.82	261.4	36.86
	20	132.9	18.37	158.4	22.12	183.9	26.10	197.1	28.09	210.3	30.19	235.8	35.11	261.4	39.05
	21	132.9	18.49	158.4	22.35	183.9	26.33	197.1	28.44	210.3	30.89	235.8	36.22	261.4	40.09
	23	132.9	18.84	158.4	22.70	183.9	27.50	197.1	30.19	210.3	33.00	235.8	38.23	261.4	42.07
	25	132.9	19.54	158.4	24.22	183.9	29.49	197.1	32.30	210.3	35.34	235.8	40.92	261.4	44.99
	27	132.9	20.71	158.4	25.75	183.9	31.48	197.1	34.52	210.3	37.68	235.8	43.48	261.4	47.33
	29	132.9	22.00	158.4	27.50	183.9	33.47	197.1	36.75	210.3	40.26	235.8	46.59	261.4	49.67
	31	132.9	23.40	158.4	29.14	183.9	35.69	197.1	39.20	210.3	42.83	235.8	49.44	261.4	52.14
	33	132.9	24.81	158.4	31.13	183.9	38.03	197.1	41.78	210.3	45.64	235.8	52.09	261.4	54.64
	35	132.9	26.33	158.4	33.00	183.9	40.49	197.1	44.47	210.3	48.68	235.8	55.23	258.6	57.74
	37	132.9	27.85	158.4	35.08	183.9	42.95	197.1	47.28	210.3	51.72	235.8	58.29	254.4	60.43
	39	132.9	29.44	158.4	37.10	183.9	45.94	197.1	50.83	210.3	55.59	235.8	61.59	250.2	63.75
	41	129.5	32.56	154.3	41.10	179.2	50.42	192.1	55.71	204.9	61.08	229.8	66.23	239.7	67.75
	43	126.3	35.84	150.5	44.86	174.8	55.04	187.3	60.72	199.9	66.75	224.1	70.89	229.8	72.52
46	118.3	39.88	141.1	50.53	163.8	62.01	175.6	67.58	187.3	75.32	205.0	79.16	209.8	79.38	
48	104.7	34.83	124.8	44.18	144.9	54.24	155.3	59.03	165.7	65.88	178.0	67.32	182.3	67.86	

# 7. Capacity Tables

Cooling Capacity (88HP)

Combination (%)	Outdoor air temp. (DB, °C)	Indoor air temp. (DB/WB, °C)													
		20		23		26		27		28		30		32	
		14		16		18		19		20		22		24	
		TC	PI	TC	PI	TC	PI	TC	PI	TC	PI	TC	PI	TC	PI
70	10	116.2	14.90	139.0	17.72	161.0	20.54	172.5	22.18	183.9	23.70	205.9	26.99	228.8	30.19
	12	116.2	15.14	139.0	17.95	161.0	21.00	172.5	22.53	183.9	24.17	205.9	27.46	228.8	30.75
	14	116.2	15.37	139.0	18.19	161.0	21.36	172.5	22.88	183.9	24.52	205.9	28.05	228.8	31.32
	16	116.2	15.61	139.0	18.54	161.0	21.71	172.5	23.35	183.9	24.99	205.9	28.51	228.8	31.99
	18	116.2	15.84	139.0	18.89	161.0	22.18	172.5	23.82	183.9	25.46	205.9	28.98	228.8	32.56
	20	116.2	16.08	139.0	19.24	161.0	22.53	172.5	24.29	183.9	26.05	205.9	29.69	228.8	33.80
	21	116.2	16.31	139.0	19.36	161.0	22.76	172.5	24.52	183.9	26.29	205.9	30.16	228.8	34.51
	23	116.2	16.55	139.0	19.83	161.0	23.23	172.5	25.35	183.9	27.58	205.9	32.27	228.8	36.44
	25	116.2	16.78	139.0	20.54	161.0	24.76	172.5	27.11	183.9	29.45	205.9	34.50	228.8	38.21
	27	116.2	17.72	139.0	21.94	161.0	26.40	172.5	28.75	183.9	31.45	205.9	36.85	228.8	40.60
	29	116.2	18.89	139.0	23.23	161.0	28.05	172.5	30.63	183.9	33.44	205.9	39.31	228.8	43.50
	31	116.2	20.07	139.0	24.76	161.0	29.92	172.5	32.74	183.9	35.67	205.9	41.89	228.8	46.16
	33	116.2	21.24	139.0	26.17	161.0	31.80	172.5	34.73	183.9	37.90	205.9	44.59	228.8	49.14
	35	116.2	22.41	139.0	27.94	161.0	33.80	172.5	36.96	183.9	40.37	205.9	47.52	228.8	52.10
	37	116.2	23.82	139.0	29.58	161.0	35.91	172.5	39.31	183.9	42.95	205.9	50.58	228.8	54.99
	39	116.2	25.30	139.0	31.54	161.0	38.39	172.5	42.29	183.9	46.39	205.9	54.13	228.8	59.28
	41	113.2	27.97	135.5	34.56	156.9	42.11	168.1	46.39	179.2	50.44	200.7	59.45	222.9	63.96
43	110.4	30.44	132.1	37.66	153.0	45.95	163.9	50.58	174.8	55.07	195.7	64.95	217.4	69.15	
46	103.5	33.83	123.8	42.35	143.4	51.75	153.6	56.34	163.8	62.09	183.4	73.25	203.8	77.07	
48	91.5	29.52	109.5	36.99	126.9	45.24	135.9	49.24	144.9	54.31	162.2	64.10	180.3	66.60	
60	10	99.4	12.94	118.8	15.18	138.2	17.65	147.8	18.94	157.5	20.12	176.9	22.83	196.2	25.53
	12	99.4	13.18	118.8	15.41	138.2	17.89	147.8	19.18	157.5	20.47	176.9	23.18	196.2	26.00
	14	99.4	13.30	118.8	15.65	138.2	18.24	147.8	19.53	157.5	20.83	176.9	23.65	196.2	26.47
	16	99.4	13.53	118.8	16.00	138.2	18.47	147.8	19.89	157.5	21.30	176.9	24.12	196.2	26.95
	18	99.4	13.77	118.8	16.24	138.2	18.83	147.8	20.24	157.5	21.65	176.9	24.47	196.2	27.53
	20	99.4	14.00	118.8	16.47	138.2	19.18	147.8	20.59	157.5	22.00	176.9	24.95	196.2	28.12
	21	99.4	14.12	118.8	16.59	138.2	19.41	147.8	20.83	157.5	22.24	176.9	25.30	196.2	28.36
	23	99.4	14.36	118.8	16.94	138.2	19.65	147.8	21.18	157.5	22.71	176.9	26.24	196.2	30.12
	25	99.4	14.59	118.8	17.30	138.2	20.47	147.8	22.24	157.5	24.12	176.9	28.00	196.2	32.24
	27	99.4	15.06	118.8	18.24	138.2	21.77	147.8	23.65	157.5	25.65	176.9	29.77	196.2	34.36
	29	99.4	16.00	118.8	19.41	138.2	23.18	147.8	25.18	157.5	27.30	176.9	31.77	196.2	36.71
	31	99.4	16.94	118.8	20.59	138.2	24.59	147.8	26.83	157.5	29.06	176.9	33.89	196.2	39.06
	33	99.4	17.89	118.8	21.77	138.2	26.12	147.8	28.47	157.5	30.95	176.9	36.01	196.2	41.65
	35	99.4	18.94	118.8	23.18	138.2	27.77	147.8	30.24	157.5	32.83	176.9	38.36	196.2	44.24
	37	99.4	20.00	118.8	24.46	138.2	29.42	147.8	32.12	157.5	34.83	176.9	40.71	196.2	47.07
	39	99.4	21.27	118.8	26.05	138.2	31.75	147.8	34.46	157.5	37.48	176.9	43.65	196.2	50.44
	41	96.9	23.07	115.8	28.50	134.6	34.48	144.1	37.65	153.5	40.69	172.4	47.91	191.2	54.81
43	94.5	25.07	112.9	31.03	131.3	37.59	140.5	41.02	149.7	44.37	168.1	52.30	186.5	59.87	
46	88.6	28.08	105.8	34.84	123.0	42.28	131.7	46.12	140.3	49.92	157.5	58.93	174.8	68.20	
48	78.3	24.47	93.6	30.41	108.8	36.94	116.5	40.28	124.1	43.63	139.4	51.53	154.6	59.67	
50	10	83.2	11.21	99.4	12.98	115.3	14.75	123.2	15.81	131.1	16.75	147.0	18.88	163.7	21.00
	12	83.2	11.33	99.4	13.10	115.3	14.98	123.2	16.05	131.1	17.11	147.0	19.23	163.7	21.36
	14	83.2	11.44	99.4	13.33	115.3	15.22	123.2	16.28	131.1	17.34	147.0	19.47	163.7	21.71
	16	83.2	11.68	99.4	13.57	115.3	15.46	123.2	16.64	131.1	17.58	147.0	19.82	163.7	22.06
	18	83.2	11.80	99.4	13.69	115.3	15.69	123.2	16.87	131.1	17.93	147.0	20.18	163.7	22.54
	20	83.2	11.92	99.4	13.92	115.3	16.05	123.2	17.11	131.1	18.29	147.0	20.53	163.7	23.01
	21	83.2	12.03	99.4	14.04	115.3	16.16	123.2	17.34	131.1	18.41	147.0	20.77	163.7	23.24
	23	83.2	12.27	99.4	14.28	115.3	16.40	123.2	17.58	131.1	18.76	147.0	21.12	163.7	23.72
	25	83.2	12.39	99.4	14.51	115.3	16.75	123.2	17.93	131.1	19.35	147.0	22.18	163.7	25.37
	27	83.2	12.62	99.4	14.98	115.3	17.70	123.2	19.11	131.1	20.53	147.0	23.72	163.7	27.02
	29	83.2	13.33	99.4	15.93	115.3	18.76	123.2	20.29	131.1	21.83	147.0	25.13	163.7	28.67
	31	83.2	14.04	99.4	16.87	115.3	19.94	123.2	21.47	131.1	23.24	147.0	26.78	163.7	30.56
	33	83.2	14.87	99.4	17.82	115.3	21.12	123.2	22.77	131.1	24.66	147.0	28.43	163.7	32.56
	35	83.2	15.69	99.4	18.88	115.3	22.30	123.2	24.19	131.1	26.07	147.0	30.09	163.7	34.57
	37	83.2	16.64	99.4	19.94	115.3	23.60	123.2	25.60	131.1	27.61	147.0	32.09	163.7	36.69
	39	83.2	17.75	99.4	21.37	115.3	25.28	123.2	27.56	131.1	29.62	147.0	34.18	163.7	39.63
	41	81.0	19.19	96.9	23.14	112.3	27.65	120.0	29.85	127.8	32.10	143.2	37.47	159.5	43.04
43	79.0	20.85	94.5	25.17	109.6	30.08	117.1	32.50	124.6	34.94	139.7	40.86	155.5	46.95	
46	74.1	23.36	88.6	28.23	102.7	33.74	109.7	36.50	116.8	39.23	130.9	45.97	145.8	52.86	
48	65.5	20.35	78.3	24.62	90.8	29.43	97.1	31.86	103.3	34.24	115.8	40.17	129.0	46.20	

**Note**

1. TC: Total Capacity(kW), PI : Power Input(kW, Comp. + Outdoor fan motor)
2. Capacity tables show the average value of conditions which may occur.

# 7. Capacity Tables

◆ ARUM900LTE5

Cooling Capacity (90HP)

Combination (%)	Outdoor air temp. (DB, °C)	Indoor air temp. (DB/WB, °C)													
		20		23		26		27		28		30		32	
		14	16	18	19	20	22	24	TC	PI	TC	PI			
130	10	249.6	26.84	297.3	32.80	318.6	38.05	327.7	38.82	336.9	39.13	353.1	39.44	362.2	39.60
	12	249.6	27.50	297.3	33.97	318.6	39.61	327.7	39.87	336.9	40.19	353.1	40.51	362.2	40.86
	14	249.6	28.42	297.3	35.20	318.6	41.10	327.7	41.40	336.9	41.73	353.1	42.06	362.2	42.43
	16	249.6	29.46	297.3	36.43	318.6	42.94	327.7	43.34	336.9	43.69	353.1	44.08	362.2	44.42
	18	249.6	30.70	297.3	38.53	318.6	44.91	327.7	45.88	336.9	46.25	353.1	46.71	362.2	47.03
	20	249.6	32.05	297.3	41.05	318.6	47.13	327.7	50.47	336.9	50.87	348.0	51.38	357.1	51.73
	21	249.6	32.89	297.3	42.49	318.6	48.12	327.7	53.41	336.9	53.84	346.0	54.37	355.1	54.74
	23	249.6	35.29	297.3	44.70	318.6	50.62	327.7	58.93	332.6	59.40	340.9	59.99	350.0	60.41
	25	249.6	37.69	297.3	47.27	318.6	54.09	323.8	65.36	327.7	65.88	336.9	66.53	346.0	66.99
	27	249.6	40.33	297.3	50.53	314.6	57.63	318.6	71.95	323.8	72.53	332.6	73.25	340.9	73.75
	29	249.6	42.97	297.3	54.03	309.4	62.01	313.9	79.08	318.6	79.55	327.7	80.26	336.9	80.58
	31	249.6	45.85	296.3	56.91	304.3	65.95	309.4	78.74	313.9	79.22	322.6	79.93	331.7	80.24
	33	249.6	48.86	291.2	60.30	300.3	70.74	305.2	78.02	309.4	78.49	318.6	79.20	326.6	79.51
	35	249.6	52.10	286.0	63.15	295.2	76.62	300.3	77.01	305.2	77.47	313.5	78.16	322.6	78.47
	37	249.6	55.55	282.0	66.27	291.2	75.61	295.2	75.99	300.3	76.45	308.5	77.13	317.6	77.43
	39	249.6	59.16	277.0	69.75	286.0	74.60	291.2	74.97	295.2	75.42	304.3	76.10	313.5	76.40
	41	243.2	62.76	265.5	73.24	274.5	73.59	278.6	73.96	284.0	74.40	292.6	75.07	300.5	75.36
	43	237.2	66.19	254.5	72.21	263.3	72.57	267.3	72.94	272.6	73.38	281.0	74.03	288.7	74.33
46	222.3	70.85	232.1	70.70	240.5	71.06	244.3	71.41	249.4	71.84	257.2	72.48	264.3	72.77	
48	196.6	68.87	201.6	69.08	209.1	69.22	212.5	69.41	217.0	70.01	223.9	70.45	230.2	70.73	
120	10	225.9	24.14	268.6	29.60	293.5	35.17	302.4	38.01	311.4	38.62	328.3	38.77	336.3	39.08
	12	225.9	24.79	268.6	30.60	293.5	36.59	302.4	38.82	311.4	40.04	328.3	40.53	336.3	40.85
	14	225.9	25.65	268.6	31.64	293.5	38.07	302.4	40.29	311.4	41.51	328.3	42.13	336.3	42.46
	16	225.9	26.57	268.6	32.93	293.5	39.54	302.4	41.80	311.4	43.43	328.3	43.97	336.3	44.32
	18	225.9	27.61	268.6	34.42	293.5	41.12	302.4	44.00	311.4	45.66	328.3	46.18	336.3	46.55
	20	225.9	28.66	268.6	36.49	293.5	43.33	302.4	46.30	311.4	48.08	328.3	48.71	336.3	49.10
	21	225.9	29.53	268.6	37.81	293.5	44.55	302.4	47.66	311.4	49.66	328.3	50.29	336.3	50.69
	23	225.9	31.57	268.6	40.45	293.5	47.73	302.4	50.65	311.4	52.94	328.3	53.48	336.3	53.91
	25	225.9	33.73	268.6	43.33	293.5	50.35	302.4	53.99	311.4	56.78	324.4	57.25	332.2	57.71
	27	225.9	36.01	268.6	46.33	293.5	53.57	302.4	57.68	311.4	61.01	319.4	61.43	327.3	61.92
	29	225.9	38.41	268.6	49.46	293.5	56.38	302.4	61.73	306.4	65.02	314.3	66.01	323.3	66.53
	31	225.9	40.93	268.6	52.82	293.5	59.30	298.5	66.13	302.4	69.76	310.4	70.99	318.3	71.56
	33	225.9	43.57	268.6	56.30	289.5	62.72	293.5	71.78	297.4	74.89	305.4	75.75	313.4	76.35
	35	225.9	46.33	268.6	60.02	284.5	66.39	288.5	79.08	293.5	79.47	301.5	79.71	309.3	80.34
	37	225.9	49.84	268.6	63.33	280.5	70.78	284.5	77.41	288.5	77.80	296.5	78.03	304.4	78.65
	39	225.9	53.65	267.6	66.94	275.6	75.07	279.5	75.82	283.5	76.20	292.5	76.43	300.4	77.04
	41	220.1	57.47	255.9	70.54	264.6	73.59	268.3	74.23	272.2	74.60	280.1	74.83	288.1	75.42
	43	214.6	61.34	245.2	69.53	253.7	71.94	257.4	72.64	261.2	73.00	268.9	73.22	276.6	73.80
46	201.1	65.96	223.6	67.87	231.7	69.68	235.1	70.26	238.7	70.61	245.9	70.82	253.2	71.38	
48	177.9	64.61	194.1	66.67	201.4	68.32	204.4	68.74	207.6	68.96	213.9	69.23	220.4	69.51	
110	10	202.3	21.71	241.2	26.47	269.4	31.44	277.2	34.03	294.7	36.62	301.6	37.64	321.9	38.27
	12	202.3	22.39	241.2	27.36	269.4	32.74	277.2	34.99	294.7	38.00	301.6	39.22	321.9	40.13
	14	202.3	23.09	241.2	28.59	269.4	34.23	277.2	36.72	294.7	39.91	301.6	41.05	321.9	41.91
	16	202.3	23.91	241.2	29.63	269.4	35.64	277.2	38.33	294.7	41.75	301.6	42.89	321.9	43.65
	18	202.3	24.80	241.2	30.87	269.4	37.69	277.2	40.36	294.7	44.04	301.6	44.91	321.9	45.75
	20	202.3	25.68	241.2	32.41	269.4	39.97	277.2	42.21	294.7	46.18	301.6	47.32	321.9	48.08
	21	202.3	26.25	241.2	33.37	269.4	41.00	277.2	43.35	294.7	47.46	301.6	48.67	321.9	49.43
	23	202.3	27.97	241.2	35.77	269.4	43.29	277.2	45.76	294.7	50.15	301.6	51.22	321.9	52.07
	25	202.3	29.89	241.2	38.17	269.4	45.73	277.2	48.38	294.7	52.98	301.6	53.74	318.0	54.84
	27	202.3	31.93	241.2	40.81	269.4	48.32	277.2	51.20	294.7	55.33	301.6	56.60	313.3	57.56
	29	202.3	34.09	241.2	43.57	269.4	51.07	277.2	54.23	294.7	58.47	301.6	59.48	309.4	60.38
	31	202.3	36.25	241.2	46.45	269.4	53.97	277.2	57.45	289.9	61.44	297.6	62.65	304.5	63.30
	33	202.3	38.65	241.2	49.46	269.4	57.02	277.2	60.88	285.9	64.89	292.8	65.96	300.5	66.33
	35	202.3	41.05	241.2	52.82	269.4	60.22	277.2	64.51	281.1	68.48	287.9	69.11	295.7	69.45
	37	202.3	43.51	241.2	56.06	269.4	63.57	273.3	68.35	276.2	72.22	284.0	72.48	290.8	72.68
	39	202.3	46.91	241.2	59.57	264.5	67.07	268.4	73.11	272.4	75.80	279.1	75.93	287.0	76.01
	41	197.1	50.31	235.0	63.08	253.2	70.73	257.2	79.08	260.5	79.08	268.1	79.71	274.8	80.34
	43	192.3	52.83	229.2	65.72	242.7	75.01	246.7	75.85	249.9	75.69	257.3	76.12	263.8	76.33
46	180.2	51.56	214.8	63.44	221.4	71.18	225.3	71.18	228.2	71.80	235.2	72.19	241.3	72.39	
48	159.4	50.07	186.7	61.12	192.3	67.73	195.8	68.18	198.4	68.51	204.5	68.70	209.9	68.98	



# 7. Capacity Tables

Cooling Capacity (90HP)

Combination (%)	Outdoor air temp. (DB, °C)	Indoor air temp. (DB/WB, °C)													
		20		23		26		27		28		30		32	
		14		16		18		19		20		22		24	
		TC	PI	TC	PI	TC	PI	TC	PI	TC	PI	TC	PI	TC	PI
100	10	170.1	19.55	202.5	23.77	235.8	28.20	252.0	30.47	268.2	32.73	297.4	36.44	303.9	36.73
	12	170.1	20.18	202.5	24.74	235.8	29.15	252.0	31.29	268.2	33.78	297.4	38.40	303.9	38.78
	14	170.1	20.81	202.5	25.72	235.8	30.38	252.0	32.64	268.2	35.24	297.4	40.55	303.9	40.93
	16	170.1	21.45	202.5	26.58	235.8	31.68	252.0	34.19	268.2	37.13	297.4	42.51	303.9	43.10
	18	170.1	22.08	202.5	27.56	235.8	32.90	252.0	35.86	268.2	39.37	297.4	44.91	303.9	45.27
	20	170.1	22.87	202.5	28.61	235.8	34.81	252.0	38.41	268.2	42.13	297.4	47.06	303.9	47.43
	21	170.1	23.34	202.5	29.29	235.8	36.01	252.0	39.73	268.2	43.69	297.4	48.13	303.9	48.52
	23	170.1	24.73	202.5	31.33	235.8	38.65	252.0	42.61	268.2	46.81	297.4	50.40	303.9	50.81
	25	170.1	26.29	202.5	33.37	235.8	41.29	252.0	45.61	268.2	50.06	297.4	52.55	301.3	52.97
	27	170.1	28.09	202.5	35.65	235.8	44.17	252.0	48.74	268.2	53.22	291.6	55.03	297.7	55.47
	29	170.1	29.89	202.5	38.05	235.8	47.17	252.0	52.10	268.2	56.33	286.1	57.24	293.2	57.70
	31	170.1	31.93	202.5	40.57	235.8	50.30	252.0	55.58	268.2	59.19	281.9	59.46	288.7	59.93
	33	170.1	33.85	202.5	43.21	235.8	53.66	252.0	59.30	268.2	61.41	277.3	61.67	284.2	62.17
	35	170.1	36.01	202.5	45.97	235.8	57.14	252.0	63.26	264.1	63.64	272.3	63.89	279.2	64.40
	37	170.1	38.57	202.5	49.31	235.8	60.53	252.0	66.27	259.8	66.60	267.2	66.86	273.6	67.48
	39	170.1	41.35	202.5	52.97	235.8	64.14	252.0	69.51	255.4	69.82	263.0	70.08	269.1	70.73
	41	167.4	44.13	199.3	56.63	232.1	67.75	241.8	72.75	247.1	73.04	252.9	73.30	261.1	73.98
	43	161.6	46.70	192.4	60.04	224.1	70.99	231.8	75.53	234.5	75.80	241.8	76.05	248.1	76.76
46	151.5	50.23	180.3	64.72	210.0	75.29	211.7	79.08	214.0	79.31	220.8	79.54	226.8	80.29	
48	134.0	43.38	159.5	56.00	181.3	64.37	184.0	67.09	185.9	67.31	192.0	67.46	197.2	68.00	
90	10	153.0	18.11	182.7	21.78	212.4	25.66	226.8	27.66	241.2	29.77	270.9	33.33	300.6	36.73
	12	153.0	18.33	182.7	22.11	212.4	26.11	226.8	28.22	241.2	30.44	270.9	33.99	300.6	37.72
	14	153.0	18.66	182.7	22.55	212.4	26.66	226.8	28.77	241.2	31.00	270.9	34.65	300.6	38.48
	16	153.0	19.00	182.7	23.00	212.4	27.22	226.8	29.33	241.2	31.55	270.9	35.31	300.6	39.14
	18	153.0	19.33	182.7	23.44	212.4	27.66	226.8	30.00	241.2	32.22	270.9	36.08	300.6	41.11
	20	153.0	19.66	182.7	23.89	212.4	28.22	226.8	30.55	241.2	33.44	270.9	38.61	300.6	43.08
	21	153.0	19.89	182.7	24.11	212.4	28.77	226.8	31.55	241.2	34.66	270.9	39.24	300.6	44.06
	23	153.0	20.33	182.7	25.11	212.4	30.77	226.8	33.89	241.2	37.11	270.9	41.61	296.5	46.14
	25	153.0	21.33	182.7	26.77	212.4	32.89	226.8	36.22	241.2	39.66	270.9	44.49	292.2	48.10
	27	153.0	22.78	182.7	28.55	212.4	35.11	226.8	38.66	241.2	42.44	270.9	47.30	287.9	50.37
	29	153.0	24.11	182.7	30.44	212.4	37.55	226.8	41.33	241.2	45.33	270.9	50.10	283.6	52.40
	31	153.0	25.66	182.7	32.44	212.4	40.00	226.8	44.00	241.2	48.33	270.9	52.60	279.3	54.42
	33	153.0	27.33	182.7	34.55	212.4	42.66	226.8	46.88	241.2	51.26	270.9	55.15	275.1	56.45
	35	153.0	29.00	182.7	36.66	212.4	45.33	226.8	49.99	241.2	54.36	266.2	58.31	270.8	59.65
	37	153.0	30.77	182.7	39.00	212.4	48.33	226.8	53.11	241.2	57.38	262.0	60.96	266.5	62.32
	39	153.0	32.58	182.7	41.48	212.4	51.15	226.8	56.52	241.2	60.34	257.7	64.26	262.2	65.04
	41	149.1	36.46	178.0	45.98	207.0	56.15	221.0	61.81	235.0	65.14	246.9	67.73	251.3	69.28
	43	145.4	39.36	173.6	49.69	201.8	61.33	215.5	66.56	229.2	69.84	236.7	72.49	241.0	73.40
46	136.3	44.30	162.7	56.59	189.2	69.88	202.0	75.47	208.3	77.60	216.1	79.32	220.2	79.55	
48	120.5	38.71	143.9	49.50	167.3	61.14	178.7	65.83	180.9	66.71	187.8	67.46	191.4	68.00	
80	10	135.9	16.89	162.0	20.29	188.1	23.81	201.6	25.68	215.1	27.56	241.2	31.43	267.3	34.12
	12	135.9	17.24	162.0	20.52	188.1	24.27	201.6	26.15	215.1	28.03	241.2	32.01	267.3	34.80
	14	135.9	17.47	162.0	20.99	188.1	24.63	201.6	26.62	215.1	28.50	241.2	32.60	267.3	35.47
	16	135.9	17.71	162.0	21.34	188.1	25.10	201.6	27.09	215.1	29.08	241.2	33.30	267.3	36.15
	18	135.9	18.06	162.0	21.69	188.1	25.56	201.6	27.56	215.1	29.67	241.2	33.89	267.3	36.94
	20	135.9	18.41	162.0	22.16	188.1	26.15	201.6	28.14	215.1	30.26	241.2	35.18	267.3	39.13
	21	135.9	18.53	162.0	22.40	188.1	26.39	201.6	28.50	215.1	30.96	241.2	36.29	267.3	40.17
	23	135.9	18.88	162.0	22.75	188.1	27.56	201.6	30.26	215.1	33.07	241.2	38.32	267.3	42.16
	25	135.9	19.58	162.0	24.27	188.1	29.55	201.6	32.37	215.1	35.42	241.2	41.01	267.3	45.08
	27	135.9	20.76	162.0	25.80	188.1	31.55	201.6	34.59	215.1	37.76	241.2	43.57	267.3	47.43
	29	135.9	22.05	162.0	27.56	188.1	33.54	201.6	36.82	215.1	40.34	241.2	46.68	267.3	49.78
	31	135.9	23.45	162.0	29.20	188.1	35.77	201.6	39.29	215.1	42.92	241.2	49.54	267.3	52.25
	33	135.9	24.86	162.0	31.19	188.1	38.11	201.6	41.87	215.1	45.74	241.2	52.20	267.3	54.76
	35	135.9	26.39	162.0	33.07	188.1	40.58	201.6	44.56	215.1	48.78	241.2	55.35	264.5	57.86
	37	135.9	27.91	162.0	35.16	188.1	43.04	201.6	47.38	215.1	51.83	241.2	58.41	260.2	60.56
	39	135.9	29.50	162.0	37.17	188.1	46.04	201.6	50.93	215.1	55.70	241.2	61.71	255.9	63.88
	41	132.4	32.63	157.9	41.19	183.3	50.53	196.4	55.83	209.6	61.21	235.0	66.37	245.2	67.89
	43	129.1	35.92	154.0	44.95	178.8	55.15	191.6	60.85	204.4	66.89	229.2	71.04	235.0	72.67
46	121.0	39.96	144.3	50.63	167.5	62.14	179.5	67.72	191.6	75.48	209.6	79.32	214.6	79.55	
48	107.1	34.90	127.6	44.27	148.2	54.35	158.8	59.15	169.5	66.02	182.1	67.46	186.4	68.00	

# 7. Capacity Tables

Cooling Capacity (90HP)

Combination (%)	Outdoor air temp. (DB, °C)	Indoor air temp. (DB/WB, °C)													
		20		23		26		27		28		30		32	
		14		16		18		19		20		22		24	
		TC	PI	TC	PI	TC	PI	TC	PI	TC	PI	TC	PI	TC	PI
70	10	118.8	14.93	142.2	17.76	164.7	20.58	176.4	22.22	188.1	23.75	210.6	27.05	234.0	30.25
	12	118.8	15.17	142.2	17.99	164.7	21.05	176.4	22.58	188.1	24.22	210.6	27.52	234.0	30.82
	14	118.8	15.40	142.2	18.23	164.7	21.40	176.4	22.93	188.1	24.58	210.6	28.10	234.0	31.38
	16	118.8	15.64	142.2	18.58	164.7	21.75	176.4	23.40	188.1	25.05	210.6	28.57	234.0	32.06
	18	118.8	15.87	142.2	18.93	164.7	22.22	176.4	23.87	188.1	25.52	210.6	29.05	234.0	32.62
	20	118.8	16.11	142.2	19.29	164.7	22.58	176.4	24.34	188.1	26.11	210.6	29.75	234.0	33.87
	21	118.8	16.35	142.2	19.40	164.7	22.81	176.4	24.58	188.1	26.34	210.6	30.22	234.0	34.59
	23	118.8	16.58	142.2	19.87	164.7	23.28	176.4	25.40	188.1	27.63	210.6	32.34	234.0	36.52
	25	118.8	16.82	142.2	20.58	164.7	24.81	176.4	27.16	188.1	29.52	210.6	34.57	234.0	38.29
	27	118.8	17.76	142.2	21.99	164.7	26.46	176.4	28.81	188.1	31.51	210.6	36.92	234.0	40.69
	29	118.8	18.93	142.2	23.28	164.7	28.10	176.4	30.69	188.1	33.51	210.6	39.39	234.0	43.59
	31	118.8	20.11	142.2	24.81	164.7	29.99	176.4	32.81	188.1	35.75	210.6	41.98	234.0	46.26
	33	118.8	21.28	142.2	26.22	164.7	31.87	176.4	34.81	188.1	37.98	210.6	44.68	234.0	49.25
	35	118.8	22.46	142.2	28.00	164.7	33.87	176.4	37.04	188.1	40.45	210.6	47.62	234.0	52.21
	37	118.8	23.87	142.2	29.65	164.7	35.98	176.4	39.39	188.1	43.04	210.6	50.68	234.0	55.11
	39	118.8	25.35	142.2	31.61	164.7	38.47	176.4	42.38	188.1	46.49	210.6	54.24	234.0	59.41
	41	115.8	28.03	138.6	34.63	160.5	42.20	171.9	46.49	183.3	50.54	205.2	59.58	228.0	64.09
	43	112.9	30.51	135.1	37.74	156.5	46.05	167.6	50.69	178.8	55.19	200.1	65.08	222.4	69.29
46	105.8	33.90	126.6	42.44	146.7	51.86	157.1	56.46	167.5	62.22	187.6	73.41	208.4	77.23	
48	93.6	29.58	112.0	37.07	129.8	45.34	139.0	49.34	148.2	54.43	165.9	64.24	184.4	66.74	
60	10	101.7	12.97	121.5	15.21	141.3	17.69	151.2	18.98	161.1	20.16	180.9	22.88	200.7	25.59
	12	101.7	13.21	121.5	15.45	141.3	17.92	151.2	19.22	161.1	20.52	180.9	23.23	200.7	26.06
	14	101.7	13.32	121.5	15.68	141.3	18.28	151.2	19.57	161.1	20.87	180.9	23.70	200.7	26.53
	16	101.7	13.56	121.5	16.04	141.3	18.51	151.2	19.93	161.1	21.34	180.9	24.17	200.7	27.00
	18	101.7	13.80	121.5	16.27	141.3	18.87	151.2	20.28	161.1	21.70	180.9	24.53	200.7	27.59
	20	101.7	14.03	121.5	16.51	141.3	19.22	151.2	20.64	161.1	22.05	180.9	25.00	200.7	28.18
	21	101.7	14.15	121.5	16.63	141.3	19.46	151.2	20.87	161.1	22.29	180.9	25.35	200.7	28.42
	23	101.7	14.39	121.5	16.98	141.3	19.69	151.2	21.22	161.1	22.76	180.9	26.29	200.7	30.19
	25	101.7	14.62	121.5	17.33	141.3	20.52	151.2	22.29	161.1	24.17	180.9	28.06	200.7	32.31
	27	101.7	15.09	121.5	18.28	141.3	21.81	151.2	23.70	161.1	25.71	180.9	29.83	200.7	34.43
	29	101.7	16.04	121.5	19.46	141.3	23.23	151.2	25.23	161.1	27.36	180.9	31.84	200.7	36.79
	31	101.7	16.98	121.5	20.64	141.3	24.64	151.2	26.88	161.1	29.12	180.9	33.96	200.7	39.15
	33	101.7	17.92	121.5	21.81	141.3	26.18	151.2	28.54	161.1	31.01	180.9	36.08	200.7	41.74
	35	101.7	18.98	121.5	23.23	141.3	27.83	151.2	30.30	161.1	32.90	180.9	38.44	200.7	44.34
	37	101.7	20.05	121.5	24.51	141.3	29.48	151.2	32.19	161.1	34.90	180.9	40.80	200.7	47.17
	39	101.7	21.32	121.5	26.10	141.3	31.82	151.2	34.54	161.1	37.56	180.9	43.75	200.7	50.54
	41	99.1	23.12	118.4	28.56	137.7	34.55	147.3	37.73	157.0	40.77	176.3	48.01	195.6	54.92
	43	96.6	25.13	115.5	31.10	134.3	37.67	143.7	41.11	153.1	44.46	171.9	52.41	190.7	59.99
46	90.6	28.14	108.2	34.92	125.8	42.37	134.7	46.22	143.5	50.03	161.1	59.05	178.7	68.35	
48	80.1	24.52	95.7	30.47	111.3	37.01	119.1	40.36	126.9	43.72	142.5	51.64	158.1	59.80	
50	10	85.1	11.23	101.7	13.01	117.9	14.78	126.0	15.84	134.1	16.79	150.3	18.92	167.4	21.05
	12	85.1	11.35	101.7	13.12	117.9	15.02	126.0	16.08	134.1	17.14	150.3	19.27	167.4	21.40
	14	85.1	11.47	101.7	13.36	117.9	15.25	126.0	16.32	134.1	17.38	150.3	19.51	167.4	21.76
	16	85.1	11.71	101.7	13.60	117.9	15.49	126.0	16.67	134.1	17.62	150.3	19.86	167.4	22.11
	18	85.1	11.82	101.7	13.72	117.9	15.73	126.0	16.91	134.1	17.97	150.3	20.22	167.4	22.58
	20	85.1	11.94	101.7	13.95	117.9	16.08	126.0	17.14	134.1	18.33	150.3	20.57	167.4	23.06
	21	85.1	12.06	101.7	14.07	117.9	16.20	126.0	17.38	134.1	18.45	150.3	20.81	167.4	23.29
	23	85.1	12.30	101.7	14.31	117.9	16.43	126.0	17.62	134.1	18.80	150.3	21.16	167.4	23.77
	25	85.1	12.41	101.7	14.54	117.9	16.79	126.0	17.97	134.1	19.39	150.3	22.23	167.4	25.42
	27	85.1	12.65	101.7	15.02	117.9	17.74	126.0	19.15	134.1	20.57	150.3	23.77	167.4	27.08
	29	85.1	13.36	101.7	15.96	117.9	18.80	126.0	20.34	134.1	21.87	150.3	25.18	167.4	28.73
	31	85.1	14.07	101.7	16.91	117.9	19.98	126.0	21.52	134.1	23.29	150.3	26.84	167.4	30.62
	33	85.1	14.90	101.7	17.85	117.9	21.16	126.0	22.82	134.1	24.71	150.3	28.50	167.4	32.63
	35	85.1	15.73	101.7	18.92	117.9	22.35	126.0	24.24	134.1	26.13	150.3	30.15	167.4	34.64
	37	85.1	16.67	101.7	19.98	117.9	23.65	126.0	25.66	134.1	27.67	150.3	32.16	167.4	36.77
	39	85.1	17.78	101.7	21.42	117.9	25.34	126.0	27.62	134.1	29.69	150.3	34.26	167.4	39.72
	41	82.9	19.23	99.1	23.19	114.9	27.71	122.8	29.91	130.7	32.17	146.5	37.55	163.1	43.13
	43	80.8	20.90	96.6	25.22	112.0	30.14	119.7	32.57	127.4	35.02	142.8	40.95	159.1	47.05
46	75.7	23.41	90.6	28.29	105.0	33.82	112.2	36.58	119.4	39.32	133.9	46.07	149.1	52.97	
48	67.0	20.40	80.1	24.67	92.9	29.50	99.3	31.92	105.6	34.31	118.4	40.26	131.9	46.30	

**Note**

1. TC: Total Capacity(kW), PI : Power Input(kW, Comp. + Outdoor fan motor)
2. Capacity tables show the average value of conditions which may occur.

# 7. Capacity Tables

◆ ARUM920LTE5

Cooling Capacity (92HP)

Combination (%)	Outdoor air temp. (DB, °C)	Indoor air temp. (DB/WB, °C)													
		20		23		26		27		28		30		32	
		14	16	18	19	20	22	24	TC	PI	TC	PI	TC	PI	
130	10	255.1	28.25	303.9	34.90	325.7	40.69	335.0	40.96	344.3	41.29	360.9	41.61	370.3	41.98
	12	255.1	29.20	303.9	36.16	325.7	42.22	335.0	42.53	344.3	42.87	360.9	43.21	370.3	43.59
	14	255.1	30.26	303.9	37.42	325.7	44.12	335.0	44.53	344.3	44.88	360.9	45.28	370.3	45.64
	16	255.1	31.54	303.9	39.59	325.7	46.14	335.0	47.14	344.3	47.51	360.9	47.98	370.3	48.31
	18	255.1	32.93	303.9	42.18	325.7	48.42	335.0	51.85	344.3	52.26	355.7	52.78	365.0	53.15
	20	255.1	33.79	303.9	43.66	325.7	49.43	335.0	54.87	344.3	55.31	353.7	55.86	363.0	56.24
	21	255.1	36.26	303.9	45.92	325.7	52.00	335.0	60.54	340.0	61.03	348.5	61.63	357.8	62.06
	23	255.1	38.72	303.9	48.57	325.7	55.57	331.0	67.15	335.0	67.68	344.3	68.35	353.7	68.82
	25	255.1	41.44	303.9	51.92	321.5	59.21	325.7	73.92	331.0	74.51	340.0	75.25	348.5	75.77
	27	255.1	44.15	303.9	55.50	316.3	63.70	320.9	81.24	325.7	81.72	335.0	82.46	344.3	82.78
	29	255.1	47.11	302.9	58.46	311.1	67.76	316.3	80.90	320.9	81.38	329.8	82.11	339.1	82.44
	31	255.1	50.19	297.6	61.95	307.0	72.67	312.0	80.16	316.3	80.64	325.7	81.36	333.9	81.68
	33	255.1	53.52	292.4	64.87	301.7	78.72	307.0	79.11	312.0	79.59	320.4	80.30	329.8	80.62
	35	255.1	57.07	288.3	68.08	297.6	77.68	301.7	78.07	307.0	78.54	315.3	79.24	324.7	79.55
	37	255.1	60.77	283.2	71.66	292.4	76.64	297.6	77.02	301.7	77.49	311.1	78.18	320.4	78.49
	39	248.6	64.47	271.4	75.24	280.6	75.60	284.8	75.98	290.3	76.43	299.1	77.12	307.2	77.42
	41	242.5	68.00	260.1	74.18	269.1	74.56	273.2	74.93	278.7	75.38	287.3	76.06	295.1	76.36
	43	227.2	72.78	237.3	72.63	245.9	73.00	249.7	73.37	254.9	73.81	262.9	74.47	270.2	74.76
46	201.0	70.75	206.1	70.96	213.8	71.12	217.2	71.31	221.8	71.92	228.9	72.38	235.3	72.67	
48	230.9	24.80	274.5	30.41	300.0	36.14	309.1	39.05	318.3	39.67	335.6	39.83	343.8	40.15	
120	10	230.9	25.47	274.5	31.44	300.0	37.59	309.1	39.88	318.3	41.14	335.6	41.64	343.8	41.97
	12	230.9	26.35	274.5	32.51	300.0	39.11	309.1	41.39	318.3	42.65	335.6	43.28	343.8	43.62
	14	230.9	27.30	274.5	33.83	300.0	40.62	309.1	42.94	318.3	44.62	335.6	45.17	343.8	45.53
	16	230.9	28.37	274.5	35.36	300.0	42.24	309.1	45.20	318.3	46.91	335.6	47.44	343.8	47.82
	18	230.9	29.45	274.5	37.49	300.0	44.52	309.1	47.57	318.3	49.39	335.6	50.04	343.8	50.44
	20	230.9	30.34	274.5	38.85	300.0	45.77	309.1	48.96	318.3	51.02	335.6	51.67	343.8	52.08
	21	230.9	32.43	274.5	41.56	300.0	49.04	309.1	52.03	318.3	54.39	335.6	54.94	343.8	55.38
	23	230.9	34.65	274.5	44.52	300.0	51.72	309.1	55.46	318.3	58.33	331.6	58.82	339.6	59.29
	25	230.9	37.00	274.5	47.60	300.0	55.04	309.1	59.26	318.3	62.68	326.4	63.11	334.6	63.61
	27	230.9	39.46	274.5	50.81	300.0	57.92	309.1	63.42	313.2	66.80	321.3	67.81	330.5	68.35
	29	230.9	42.05	274.5	54.26	300.0	60.92	305.1	67.94	309.1	71.66	317.3	72.93	325.4	73.52
	31	230.9	44.77	274.5	57.84	296.0	64.44	300.0	73.74	304.0	76.94	312.2	77.82	320.4	78.44
	33	230.9	47.60	274.5	61.66	290.9	68.21	294.9	81.24	300.0	81.64	308.2	81.89	316.2	82.54
	35	230.9	51.20	274.5	65.07	286.7	72.72	290.9	79.53	294.9	79.93	303.0	80.17	311.2	80.80
	37	230.9	55.12	273.5	68.77	281.7	77.13	285.7	77.90	289.8	78.29	299.0	78.52	307.1	79.14
	39	225.0	59.04	261.6	72.47	270.4	75.61	274.3	76.26	278.3	76.64	286.3	76.87	294.5	77.48
	41	219.4	63.02	250.6	71.43	259.3	73.91	263.1	74.63	267.0	75.00	274.8	75.23	282.8	75.82
	43	205.6	67.76	228.5	69.73	236.8	71.59	240.3	72.18	244.0	72.54	251.4	72.75	258.8	73.33
46	181.9	66.38	198.4	68.49	205.8	70.19	208.9	70.62	212.2	70.84	218.7	71.13	225.3	71.41	
48	206.8	22.31	246.6	27.19	275.4	32.30	283.3	34.96	301.3	37.63	308.3	38.67	329.1	39.31	
110	10	206.8	23.01	246.6	28.11	275.4	33.64	283.3	35.95	301.3	39.04	308.3	40.29	329.1	41.23
	12	206.8	23.72	246.6	29.37	275.4	35.16	283.3	37.73	301.3	41.00	308.3	42.17	329.1	43.06
	14	206.8	24.57	246.6	30.45	275.4	36.62	283.3	39.38	301.3	42.89	308.3	44.06	329.1	44.84
	16	206.8	25.48	246.6	31.71	275.4	38.72	283.3	41.46	301.3	45.25	308.3	46.14	329.1	47.00
	18	206.8	26.39	246.6	33.30	275.4	41.07	283.3	43.37	301.3	47.44	308.3	48.61	329.1	49.39
	20	206.8	26.97	246.6	34.28	275.4	42.12	283.3	44.53	301.3	48.76	308.3	50.00	329.1	50.78
	21	206.8	28.73	246.6	36.75	275.4	44.47	283.3	47.01	301.3	51.52	308.3	52.62	329.1	53.49
	23	206.8	30.71	246.6	39.22	275.4	46.98	283.3	49.70	301.3	54.43	308.3	55.21	325.1	56.34
	25	206.8	32.80	246.6	41.93	275.4	49.65	283.3	52.60	301.3	56.85	308.3	58.15	320.3	59.13
	27	206.8	35.02	246.6	44.77	275.4	52.47	283.3	55.71	301.3	60.07	308.3	61.11	316.2	62.03
	29	206.8	37.24	246.6	47.73	275.4	55.44	283.3	59.02	296.3	63.12	304.2	64.36	311.2	65.04
	31	206.8	39.71	246.6	50.81	275.4	58.58	283.3	62.55	292.3	66.66	299.3	67.77	307.2	68.14
	33	206.8	42.18	246.6	54.26	275.4	61.86	283.3	66.28	287.4	70.35	294.3	71.00	302.3	71.35
	35	206.8	44.70	246.6	57.59	275.4	65.31	279.4	70.22	282.4	74.20	290.4	74.46	297.3	74.67
	37	206.8	48.19	246.6	61.20	270.4	68.91	274.4	75.11	278.4	77.88	285.3	78.01	293.3	78.09
	39	201.5	51.68	240.2	64.80	258.8	72.67	262.9	81.24	266.3	81.24	274.1	81.89	280.9	82.54
	41	196.5	54.27	234.3	67.51	248.1	77.06	252.1	77.93	255.4	77.76	263.0	78.20	269.7	78.41
	43	184.2	52.97	219.6	65.18	226.3	73.13	230.3	73.13	233.3	73.76	240.4	74.17	246.6	74.37
46	162.9	51.44	190.9	62.79	196.6	69.58	200.2	70.04	202.8	70.38	209.1	70.58	214.6	70.86	
48	173.9	20.09	207.0	24.42	241.0	28.97	257.6	31.30	274.2	33.63	304.0	37.44	310.6	37.74	

# 7. Capacity Tables

Cooling Capacity (92HP)

Combination (%)	Outdoor air temp. (DB, °C)	Indoor air temp. (DB/WB, °C)													
		20		23		26		27		28		30		32	
		14		16		18		19		20		22		24	
		TC	PI	TC	PI	TC	PI	TC	PI	TC	PI	TC	PI	TC	PI
100	10	173.9	20.73	207.0	25.41	241.0	29.94	257.6	32.14	274.2	34.70	304.0	39.45	310.6	39.84
	12	173.9	21.38	207.0	26.43	241.0	31.21	257.6	33.53	274.2	36.20	304.0	41.66	310.6	42.05
	14	173.9	22.03	207.0	27.30	241.0	32.54	257.6	35.12	274.2	38.15	304.0	43.67	310.6	44.28
	16	173.9	22.68	207.0	28.32	241.0	33.80	257.6	36.84	274.2	40.45	304.0	46.14	310.6	46.51
	18	173.9	23.49	207.0	29.39	241.0	35.76	257.6	39.46	274.2	43.29	304.0	48.35	310.6	48.73
	20	173.9	23.98	207.0	30.09	241.0	37.00	257.6	40.82	274.2	44.89	304.0	49.45	310.6	49.85
	21	173.9	25.40	207.0	32.19	241.0	39.71	257.6	43.78	274.2	48.10	304.0	51.78	310.6	52.20
	23	173.9	27.01	207.0	34.28	241.0	42.42	257.6	46.86	274.2	51.42	304.0	53.99	308.0	54.42
	25	173.9	28.86	207.0	36.63	241.0	45.38	257.6	50.07	274.2	54.68	298.0	56.53	304.3	56.98
	27	173.9	30.71	207.0	39.09	241.0	48.47	257.6	53.52	274.2	57.87	292.5	58.81	299.7	59.28
	29	173.9	32.80	207.0	41.68	241.0	51.67	257.6	57.10	274.2	60.80	288.1	61.08	295.1	61.57
	31	173.9	34.78	207.0	44.40	241.0	55.12	257.6	60.92	274.2	63.09	283.5	63.36	290.5	63.87
	33	173.9	37.00	207.0	47.23	241.0	58.70	257.6	64.99	270.0	65.38	278.3	65.64	285.4	66.16
	35	173.9	39.62	207.0	50.66	241.0	62.18	257.6	68.08	265.5	68.42	273.2	68.69	279.7	69.33
	37	173.9	42.48	207.0	54.42	241.0	65.89	257.6	71.41	261.1	71.73	268.8	72.00	275.1	72.67
	39	171.1	45.34	203.7	58.18	237.2	69.60	247.2	74.74	252.6	75.04	258.5	75.30	266.9	76.01
	41	165.2	47.98	196.7	61.68	229.1	72.93	237.0	77.60	239.7	77.87	247.1	78.13	253.6	78.86
	43	154.9	51.61	184.4	66.49	214.7	77.35	216.4	81.24	218.7	81.48	225.7	81.71	231.8	82.49
46	137.0	44.56	163.1	57.53	185.3	66.13	188.0	68.93	190.0	69.15	196.2	69.31	201.6	69.86	
48	156.4	18.61	186.8	22.38	217.1	26.38	231.8	28.44	246.6	30.61	276.9	34.26	307.3	37.74	
90	10	156.4	18.84	186.8	22.73	217.1	26.84	231.8	29.01	246.6	31.29	276.9	34.93	307.3	38.77
	12	156.4	19.19	186.8	23.18	217.1	27.41	231.8	29.58	246.6	31.86	276.9	35.61	307.3	39.56
	14	156.4	19.53	186.8	23.64	217.1	27.98	231.8	30.15	246.6	32.43	276.9	36.29	307.3	40.23
	16	156.4	19.87	186.8	24.10	217.1	28.44	231.8	30.83	246.6	33.12	276.9	37.08	307.3	42.25
	18	156.4	20.21	186.8	24.55	217.1	29.01	231.8	31.40	246.6	34.37	276.9	39.68	307.3	44.28
	20	156.4	20.44	186.8	24.78	217.1	29.58	231.8	32.43	246.6	35.63	276.9	40.33	307.3	45.29
	21	156.4	20.90	186.8	25.81	217.1	31.63	231.8	34.83	246.6	38.14	276.9	42.77	303.1	47.42
	23	156.4	21.93	186.8	27.52	217.1	33.80	231.8	37.23	246.6	40.77	276.9	45.73	298.7	49.45
	25	156.4	23.41	186.8	29.35	217.1	36.09	231.8	39.74	246.6	43.62	276.9	48.62	294.3	51.77
	27	156.4	24.78	186.8	31.29	217.1	38.60	231.8	42.48	246.6	46.59	276.9	51.50	289.9	53.86
	29	156.4	26.38	186.8	33.35	217.1	41.11	231.8	45.22	246.6	49.68	276.9	54.07	285.5	55.94
	31	156.4	28.09	186.8	35.52	217.1	43.85	231.8	48.19	246.6	52.69	276.9	56.68	281.2	58.03
	33	156.4	29.81	186.8	37.69	217.1	46.59	231.8	51.39	246.6	55.87	272.2	59.94	276.8	61.31
	35	156.4	31.63	186.8	40.08	217.1	49.68	231.8	54.59	246.6	58.98	267.8	62.66	272.4	64.06
	37	156.4	33.49	186.8	42.63	217.1	52.58	231.8	58.09	246.6	62.02	263.4	66.06	268.0	66.85
	39	152.4	37.48	182.0	47.27	211.6	57.71	225.9	63.53	240.3	66.96	252.4	69.62	256.9	71.21
	41	148.6	40.45	177.5	51.08	206.3	63.04	220.3	68.42	234.3	71.79	242.0	74.51	246.4	75.45
	43	139.3	45.53	166.3	58.17	193.4	71.82	206.5	77.57	212.9	79.76	220.9	81.50	225.1	81.74
46	123.2	39.79	147.1	50.88	171.1	62.84	182.6	67.66	184.9	68.55	192.0	69.31	195.6	69.86	
48	138.9	17.36	165.6	20.86	192.3	24.47	206.1	26.40	219.9	28.33	246.6	32.31	273.2	35.08	
80	10	138.9	17.72	165.6	21.10	192.3	24.95	206.1	26.88	219.9	28.81	246.6	32.91	273.2	35.77
	12	138.9	17.96	165.6	21.58	192.3	25.32	206.1	27.37	219.9	29.29	246.6	33.51	273.2	36.47
	14	138.9	18.20	165.6	21.94	192.3	25.80	206.1	27.85	219.9	29.90	246.6	34.24	273.2	37.16
	16	138.9	18.56	165.6	22.30	192.3	26.28	206.1	28.33	219.9	30.50	246.6	34.84	273.2	37.97
	18	138.9	18.93	165.6	22.78	192.3	26.88	206.1	28.93	219.9	31.10	246.6	36.17	273.2	40.23
	20	138.9	19.05	165.6	23.03	192.3	27.12	206.1	29.29	219.9	31.83	246.6	37.31	273.2	41.30
	21	138.9	19.41	165.6	23.39	192.3	28.33	206.1	31.10	219.9	34.00	246.6	39.39	273.2	43.34
	23	138.9	20.13	165.6	24.95	192.3	30.38	206.1	33.27	219.9	36.41	246.6	42.15	273.2	46.34
	25	138.9	21.34	165.6	26.52	192.3	32.43	206.1	35.56	219.9	38.82	246.6	44.79	273.2	48.76
	27	138.9	22.66	165.6	28.33	192.3	34.48	206.1	37.85	219.9	41.47	246.6	47.99	273.2	51.16
	29	138.9	24.11	165.6	30.02	192.3	36.77	206.1	40.38	219.9	44.12	246.6	50.93	273.2	53.70
	31	138.9	25.56	165.6	32.07	192.3	39.18	206.1	43.04	219.9	47.01	246.6	53.66	273.2	56.29
	33	138.9	27.12	165.6	34.00	192.3	41.71	206.1	45.81	219.9	50.15	246.6	56.90	270.4	59.47
	35	138.9	28.69	165.6	36.14	192.3	44.24	206.1	48.70	219.9	53.28	246.6	60.05	266.0	62.25
	37	138.9	30.32	165.6	38.21	192.3	47.33	206.1	52.36	219.9	57.26	246.6	63.44	261.6	65.67
	39	135.4	33.54	161.4	42.34	187.4	51.94	200.8	57.39	214.3	62.92	240.3	68.22	250.6	69.79
	41	132.0	36.93	157.4	46.21	182.7	56.70	195.8	62.55	209.0	68.76	234.3	73.02	240.3	74.69
	43	123.7	41.08	147.5	52.05	171.2	63.88	183.5	69.62	195.8	77.59	214.3	81.50	219.3	81.74
46	109.4	35.88	130.5	45.51	151.5	55.87	162.4	60.81	173.2	67.86	186.1	69.31	190.6	69.86	
48	121.4	15.35	145.4	18.25	168.4	21.16	180.3	22.85	192.3	24.42	215.3	27.81	239.2	31.10	

# 7. Capacity Tables

Cooling Capacity (92HP)

Combination (%)	Outdoor air temp. (DB, °C)	Indoor air temp. (DB/WB, °C)													
		20		23		26		27		28		30		32	
		14		16		18		19		20		22		24	
		TC	PI	TC	PI	TC	PI	TC	PI	TC	PI	TC	PI	TC	PI
70	10	121.4	15.60	145.4	18.50	168.4	21.64	180.3	23.21	192.3	24.90	215.3	28.29	239.2	31.68
	12	121.4	15.84	145.4	18.74	168.4	22.00	180.3	23.57	192.3	25.27	215.3	28.89	239.2	32.26
	14	121.4	16.08	145.4	19.10	168.4	22.37	180.3	24.06	192.3	25.75	215.3	29.38	239.2	32.96
	16	121.4	16.32	145.4	19.46	168.4	22.85	180.3	24.54	192.3	26.23	215.3	29.86	239.2	33.54
	18	121.4	16.56	145.4	19.83	168.4	23.21	180.3	25.02	192.3	26.84	215.3	30.59	239.2	34.82
	20	121.4	16.80	145.4	19.95	168.4	23.45	180.3	25.27	192.3	27.08	215.3	31.07	239.2	35.56
	21	121.4	17.05	145.4	20.43	168.4	23.94	180.3	26.11	192.3	28.41	215.3	33.25	239.2	37.54
	23	121.4	17.29	145.4	21.16	168.4	25.51	180.3	27.93	192.3	30.34	215.3	35.54	239.2	39.37
	25	121.4	18.25	145.4	22.61	168.4	27.20	180.3	29.62	192.3	32.40	215.3	37.96	239.2	41.83
	27	121.4	19.46	145.4	23.94	168.4	28.89	180.3	31.55	192.3	34.45	215.3	40.50	239.2	44.82
	29	121.4	20.67	145.4	25.51	168.4	30.83	180.3	33.73	192.3	36.75	215.3	43.16	239.2	47.56
	31	121.4	21.88	145.4	26.96	168.4	32.76	180.3	35.78	192.3	39.05	215.3	45.94	239.2	50.63
	33	121.4	23.09	145.4	28.78	168.4	34.82	180.3	38.08	192.3	41.59	215.3	48.96	239.2	53.68
	35	121.4	24.54	145.4	30.48	168.4	36.99	180.3	40.50	192.3	44.25	215.3	52.10	239.2	56.65
	37	121.4	26.06	145.4	32.50	168.4	39.55	180.3	43.57	192.3	47.80	215.3	55.76	239.2	61.08
	39	118.3	28.81	141.6	35.60	164.1	43.39	175.7	47.79	187.4	51.96	209.8	61.25	233.1	65.89
	41	115.4	31.36	138.1	38.80	160.0	47.34	171.4	52.11	182.7	56.74	204.6	66.91	227.3	71.24
	43	108.2	34.85	129.5	43.63	149.9	53.31	160.6	58.05	171.2	63.96	191.7	75.47	213.0	79.40
46	95.7	30.42	114.5	38.11	132.6	46.61	142.1	50.73	151.5	55.96	169.6	66.04	188.4	68.60	
48	104.0	13.34	124.2	15.64	144.4	18.19	154.6	19.52	164.7	20.73	184.9	23.52	205.2	26.31	
60	10	104.0	13.58	124.2	15.88	144.4	18.43	154.6	19.76	164.7	21.09	184.9	23.88	205.2	26.79
	12	104.0	13.70	124.2	16.12	144.4	18.79	154.6	20.13	164.7	21.46	184.9	24.37	205.2	27.28
	14	104.0	13.94	124.2	16.49	144.4	19.03	154.6	20.49	164.7	21.94	184.9	24.85	205.2	27.76
	16	104.0	14.18	124.2	16.73	144.4	19.40	154.6	20.85	164.7	22.31	184.9	25.22	205.2	28.37
	18	104.0	14.43	124.2	16.97	144.4	19.76	154.6	21.22	164.7	22.67	184.9	25.70	205.2	28.98
	20	104.0	14.55	124.2	17.09	144.4	20.00	154.6	21.46	164.7	22.91	184.9	26.07	205.2	29.22
	21	104.0	14.79	124.2	17.46	144.4	20.25	154.6	21.82	164.7	23.40	184.9	27.04	205.2	31.04
	23	104.0	15.03	124.2	17.82	144.4	21.09	154.6	22.91	164.7	24.85	184.9	28.85	205.2	33.22
	25	104.0	15.52	124.2	18.79	144.4	22.43	154.6	24.37	164.7	26.43	184.9	30.67	205.2	35.40
	27	104.0	16.49	124.2	20.00	144.4	23.88	154.6	25.94	164.7	28.13	184.9	32.73	205.2	37.83
	29	104.0	17.46	124.2	21.22	144.4	25.34	154.6	27.64	164.7	29.95	184.9	34.92	205.2	40.25
	31	104.0	18.43	124.2	22.43	144.4	26.91	154.6	29.34	164.7	31.88	184.9	37.10	205.2	42.92
	33	104.0	19.52	124.2	23.88	144.4	28.61	154.6	31.16	164.7	33.82	184.9	39.52	205.2	45.58
	35	104.0	20.61	124.2	25.21	144.4	30.31	154.6	33.10	164.7	35.89	184.9	41.95	205.2	48.49
	37	104.0	21.92	124.2	26.84	144.4	32.71	154.6	35.51	164.7	38.62	184.9	44.98	205.2	51.97
	39	101.3	23.77	121.0	29.37	140.7	35.53	150.6	38.79	160.5	41.92	180.2	49.36	199.9	56.47
	41	98.8	25.83	118.0	31.97	137.3	38.73	146.9	42.27	156.5	45.71	175.7	53.88	195.0	61.68
	43	92.6	28.93	110.6	35.90	128.6	43.56	137.6	47.52	146.7	51.44	164.7	60.71	182.7	70.27
46	81.9	25.21	97.8	31.33	113.8	38.06	121.8	41.50	129.7	44.95	145.7	53.10	161.6	61.49	
48	86.9	11.55	104.0	13.37	120.5	15.20	128.8	16.29	137.1	17.26	153.6	19.45	171.1	21.64	
50	10	86.9	11.67	104.0	13.50	120.5	15.44	128.8	16.53	137.1	17.63	153.6	19.82	171.1	22.01
	12	86.9	11.79	104.0	13.74	120.5	15.68	128.8	16.78	137.1	17.87	153.6	20.06	171.1	22.37
	14	86.9	12.04	104.0	13.98	120.5	15.93	128.8	17.14	137.1	18.12	153.6	20.43	171.1	22.74
	16	86.9	12.16	104.0	14.10	120.5	16.17	128.8	17.39	137.1	18.48	153.6	20.79	171.1	23.22
	18	86.9	12.28	104.0	14.35	120.5	16.53	128.8	17.63	137.1	18.84	153.6	21.15	171.1	23.71
	20	86.9	12.40	104.0	14.47	120.5	16.66	128.8	17.87	137.1	18.97	153.6	21.40	171.1	23.95
	21	86.9	12.64	104.0	14.71	120.5	16.90	128.8	18.12	137.1	19.33	153.6	21.76	171.1	24.44
	23	86.9	12.77	104.0	14.95	120.5	17.26	128.8	18.48	137.1	19.94	153.6	22.86	171.1	26.14
	25	86.9	13.01	104.0	15.44	120.5	18.24	128.8	19.70	137.1	21.15	153.6	24.44	171.1	27.84
	27	86.9	13.74	104.0	16.41	120.5	19.33	128.8	20.91	137.1	22.49	153.6	25.90	171.1	29.54
	29	86.9	14.47	104.0	17.39	120.5	20.55	128.8	22.13	137.1	23.95	153.6	27.60	171.1	31.49
	31	86.9	15.32	104.0	18.36	120.5	21.76	128.8	23.46	137.1	25.41	153.6	29.30	171.1	33.56
	33	86.9	16.17	104.0	19.45	120.5	22.98	128.8	24.92	137.1	26.87	153.6	31.00	171.1	35.62
	35	86.9	17.14	104.0	20.55	120.5	24.32	128.8	26.38	137.1	28.45	153.6	33.07	171.1	37.81
	37	86.9	18.29	104.0	22.02	120.5	26.05	128.8	28.40	137.1	30.53	153.6	35.22	171.1	40.84
	39	84.7	19.77	101.3	23.84	117.4	28.49	125.5	30.76	133.6	33.07	149.7	38.61	166.7	44.35
	41	82.6	21.49	98.8	25.93	114.5	30.99	122.4	33.49	130.3	36.01	146.0	42.10	162.6	48.38
	43	77.4	24.07	92.6	29.09	107.3	34.77	114.7	37.61	122.1	40.43	136.8	47.37	152.4	54.47
46	68.5	20.97	81.9	25.37	94.9	30.33	101.5	32.83	108.0	35.28	121.0	41.40	134.8	47.61	
48	68.6	20.96	82.0	25.36	95.0	30.33	101.6	32.82	108.1	35.27	121.1	41.40	134.9	47.61	

**Note**

1. TC: Total Capacity(kW), PI : Power Input(kW, Comp. + Outdoor fan motor)
2. Capacity tables show the average value of conditions which may occur.

# 7. Capacity Tables

◆ ARUM940LTE5

Cooling Capacity (94HP)

Combination (%)	Outdoor air temp. (DB, °C)	Indoor air temp. (DB/WB, °C)													
		20		23		26		27		28		30		32	
		14	16	16	18	18	19	20	20	22	22	24	24		
		TC	PI	TC	PI	TC	PI	TC	PI	TC	PI	TC	PI	TC	PI
130	10	260.7	28.91	310.5	35.33	332.7	40.99	342.3	41.82	351.8	42.15	368.8	42.49	378.3	42.66
	12	260.7	29.62	310.5	36.59	332.7	42.67	342.3	42.95	351.8	43.29	368.8	43.64	378.3	44.02
	14	260.7	30.62	310.5	37.92	332.7	44.28	342.3	44.60	351.8	44.96	368.8	45.31	378.3	45.71
	16	260.7	31.74	310.5	39.24	332.7	46.26	342.3	46.69	351.8	47.06	368.8	47.48	378.3	47.86
	18	260.7	33.07	310.5	41.51	332.7	48.39	342.3	49.43	351.8	49.82	368.8	50.32	378.3	50.66
	20	260.7	34.53	310.5	44.23	332.7	50.77	342.3	54.37	351.8	54.81	363.4	55.35	373.0	55.73
	21	260.7	35.43	310.5	45.78	332.7	51.83	342.3	57.54	351.8	58.00	361.4	58.57	370.9	58.98
	23	260.7	38.02	310.5	48.16	332.7	54.53	342.3	63.49	347.4	64.00	356.0	64.63	365.6	65.08
	25	260.7	40.61	310.5	50.93	332.7	58.27	338.2	70.41	342.3	70.97	351.8	71.68	361.4	72.17
	27	260.7	43.45	310.5	54.44	328.5	62.08	332.7	77.51	338.2	78.13	347.4	78.91	356.0	79.45
	29	260.7	46.30	310.5	58.20	323.2	66.80	327.9	85.19	332.7	85.70	342.3	86.47	351.8	86.81
	31	260.7	49.40	309.4	61.31	317.8	71.05	323.2	84.83	327.9	85.34	336.9	86.10	346.5	86.44
	33	260.7	52.63	304.1	64.96	313.6	76.21	318.7	84.06	323.2	84.56	332.7	85.32	341.1	85.65
	35	260.7	56.12	298.8	68.03	308.3	82.55	313.6	82.96	318.7	83.46	327.4	84.20	336.9	84.54
	37	260.7	59.85	294.6	71.39	304.1	81.46	308.3	81.86	313.6	82.36	322.2	83.09	331.7	83.42
	39	260.7	63.73	289.3	75.15	298.8	80.37	304.1	80.77	308.3	81.25	317.8	81.98	327.4	82.30
41	254.0	67.61	277.3	78.90	286.7	79.27	291.0	79.67	296.6	80.15	305.6	80.87	313.9	81.19	
43	247.7	71.30	265.8	77.79	275.0	78.18	279.2	78.58	284.8	79.05	293.5	79.76	301.5	80.07	
46	232.2	76.32	242.4	76.16	251.2	76.55	255.2	76.93	260.5	77.40	268.7	78.09	276.1	78.40	
48	205.4	74.19	210.6	74.42	218.4	74.57	221.9	74.78	226.6	75.42	233.9	75.90	240.4	76.20	
120	10	235.9	26.01	280.5	31.89	306.5	37.89	315.9	40.95	325.2	41.60	342.9	41.77	351.2	42.10
	12	235.9	26.71	280.5	32.97	306.5	39.42	315.9	41.82	325.2	43.14	342.9	43.66	351.2	44.01
	14	235.9	27.63	280.5	34.09	306.5	41.01	315.9	43.41	325.2	44.72	342.9	45.38	351.2	45.75
	16	235.9	28.62	280.5	35.48	306.5	42.60	315.9	45.03	325.2	46.79	342.9	47.36	351.2	47.74
	18	235.9	29.75	280.5	37.08	306.5	44.30	315.9	47.40	325.2	49.19	342.9	49.75	351.2	50.15
	20	235.9	30.88	280.5	39.31	306.5	46.68	315.9	49.88	325.2	51.79	342.9	52.48	351.2	52.90
	21	235.9	31.81	280.5	40.73	306.5	47.99	315.9	51.34	325.2	53.50	342.9	54.18	351.2	54.61
	23	235.9	34.01	280.5	43.58	306.5	51.42	315.9	54.56	325.2	57.03	342.9	57.61	351.2	58.07
	25	235.9	36.34	280.5	46.68	306.5	54.24	315.9	58.16	325.2	61.16	338.8	61.68	347.0	62.17
	27	235.9	38.80	280.5	49.92	306.5	57.72	315.9	62.14	325.2	65.73	333.5	66.17	341.9	66.70
	29	235.9	41.38	280.5	53.28	306.5	60.74	315.9	66.50	320.0	70.05	328.3	71.11	337.7	71.68
	31	235.9	44.10	280.5	56.90	306.5	63.88	311.7	71.24	315.9	75.15	324.2	76.48	332.4	77.09
	33	235.9	46.94	280.5	60.65	302.4	67.57	306.5	77.33	310.6	80.68	319.0	81.60	327.3	82.26
	35	235.9	49.92	280.5	64.66	297.2	71.52	301.3	85.19	306.5	85.61	314.9	85.87	323.1	86.55
	37	235.9	53.69	280.5	68.23	292.9	76.25	297.2	83.40	301.3	83.81	309.6	84.06	318.0	84.73
	39	235.9	57.80	279.5	72.11	287.8	80.88	291.9	81.68	296.1	82.09	305.5	82.34	313.7	82.99
41	229.9	61.91	267.3	75.99	276.3	79.28	280.2	79.97	284.3	80.37	292.5	80.61	300.9	81.25	
43	224.2	66.08	256.1	74.91	265.0	77.50	268.8	78.26	272.8	78.65	280.8	78.88	288.9	79.51	
46	210.1	71.06	233.5	73.12	242.0	75.07	245.6	75.69	249.3	76.07	256.8	76.29	264.4	76.90	
48	185.8	69.61	202.7	71.82	210.3	73.61	213.5	74.05	216.8	74.29	223.4	74.59	230.2	74.88	
110	10	211.3	23.39	251.9	28.51	281.4	33.87	289.5	36.66	307.8	39.45	315.0	40.55	336.2	41.23
	12	211.3	24.13	251.9	29.47	281.4	35.27	289.5	37.69	307.8	40.93	315.0	42.25	336.2	43.23
	14	211.3	24.87	251.9	30.80	281.4	36.87	289.5	39.56	307.8	43.00	315.0	44.22	336.2	45.15
	16	211.3	25.76	251.9	31.93	281.4	38.40	289.5	41.29	307.8	44.98	315.0	46.21	336.2	47.02
	18	211.3	26.71	251.9	33.25	281.4	40.61	289.5	43.48	307.8	47.45	315.0	48.39	336.2	49.29
	20	211.3	27.67	251.9	34.92	281.4	43.06	289.5	45.48	307.8	49.75	315.0	50.98	336.2	51.79
	21	211.3	28.28	251.9	35.95	281.4	44.17	289.5	46.70	307.8	51.13	315.0	52.43	336.2	53.25
	23	211.3	30.13	251.9	38.54	281.4	46.64	289.5	49.30	307.8	54.02	315.0	55.18	336.2	56.09
	25	211.3	32.20	251.9	41.12	281.4	49.27	289.5	52.12	307.8	57.08	315.0	57.89	332.1	59.08
	27	211.3	34.40	251.9	43.97	281.4	52.06	289.5	55.16	307.8	59.61	315.0	60.97	327.2	62.01
	29	211.3	36.73	251.9	46.94	281.4	55.02	289.5	58.42	307.8	62.99	315.0	64.08	323.1	65.05
	31	211.3	39.05	251.9	50.05	281.4	58.14	289.5	61.89	302.8	66.19	310.8	67.49	318.0	68.20
	33	211.3	41.64	251.9	53.28	281.4	61.42	289.5	65.59	298.6	69.90	305.8	71.06	313.9	71.46
	35	211.3	44.23	251.9	56.90	281.4	64.87	289.5	69.50	293.6	73.77	300.7	74.45	308.9	74.82
	37	211.3	46.87	251.9	60.39	281.4	68.48	285.4	73.63	288.5	77.81	296.7	78.08	303.7	78.30
	39	211.3	50.53	251.9	64.17	276.3	72.26	280.3	78.76	284.5	81.66	291.5	81.80	299.7	81.88
41	205.9	54.20	245.5	67.96	264.5	76.20	268.6	85.19	272.1	85.19	280.1	85.87	287.0	86.55	
43	200.8	56.91	239.4	70.80	253.5	80.81	257.6	81.72	261.0	81.54	268.7	82.00	275.5	82.23	
46	188.2	55.54	224.4	68.35	231.3	76.69	235.3	76.69	238.4	77.35	245.6	77.78	252.0	77.99	
48	166.5	53.95	195.0	65.84	200.9	72.96	204.5	73.45	207.2	73.81	213.6	74.01	219.3	74.31	

# 7. Capacity Tables

Cooling Capacity (94HP)

Combination (%)	Outdoor air temp. (DB, °C)	Indoor air temp. (DB/WB, °C)													
		20		23		26		27		28		30		32	
		14		16		18		19		20		22		24	
		TC	PI	TC	PI	TC	PI	TC	PI	TC	PI	TC	PI	TC	PI
100	10	177.7	21.07	211.5	25.60	246.3	30.38	263.2	32.82	280.1	35.26	310.6	39.26	317.4	39.57
	12	177.7	21.74	211.5	26.65	246.3	31.40	263.2	33.71	280.1	36.39	310.6	41.37	317.4	41.78
	14	177.7	22.42	211.5	27.71	246.3	32.73	263.2	35.16	280.1	37.96	310.6	43.68	317.4	44.09
	16	177.7	23.10	211.5	28.63	246.3	34.12	263.2	36.83	280.1	40.00	310.6	45.79	317.4	46.43
	18	177.7	23.78	211.5	29.69	246.3	35.45	263.2	38.63	280.1	42.42	310.6	48.38	317.4	48.77
	20	177.7	24.64	211.5	30.82	246.3	37.50	263.2	41.38	280.1	45.39	310.6	50.70	317.4	51.10
	21	177.7	25.15	211.5	31.55	246.3	38.80	263.2	42.80	280.1	47.07	310.6	51.85	317.4	52.27
	23	177.7	26.64	211.5	33.75	246.3	41.64	263.2	45.91	280.1	50.43	310.6	54.30	317.4	54.73
	25	177.7	28.32	211.5	35.95	246.3	44.49	263.2	49.14	280.1	53.93	310.6	56.61	314.7	57.07
	27	177.7	30.26	211.5	38.41	246.3	47.59	263.2	52.50	280.1	57.33	310.6	59.28	311.0	59.75
	29	177.7	32.20	211.5	40.99	246.3	50.82	263.2	56.12	280.1	60.68	298.9	61.67	306.3	62.16
	31	177.7	34.40	211.5	43.71	246.3	54.18	263.2	59.87	280.1	63.76	294.4	64.05	301.6	64.57
	33	177.7	36.47	211.5	46.55	246.3	57.80	263.2	63.88	280.1	66.16	289.7	66.44	296.9	66.97
	35	177.7	38.80	211.5	49.53	246.3	61.55	263.2	68.15	275.8	68.56	284.4	68.83	291.6	69.38
	37	177.7	41.55	211.5	53.12	246.3	65.20	263.2	71.39	271.3	71.75	279.1	72.03	285.8	72.70
	39	177.7	44.54	211.5	57.07	246.3	69.09	263.2	74.88	266.8	75.22	274.6	75.50	281.1	76.20
	41	174.8	47.54	208.1	61.01	242.4	72.98	252.5	78.37	258.1	78.69	264.2	78.96	272.7	79.70
	43	168.8	50.31	201.0	64.68	234.0	76.47	242.1	81.37	244.9	81.66	252.5	81.93	259.1	82.70
46	158.2	54.12	188.4	69.72	219.3	81.11	221.1	85.19	223.5	85.44	230.7	85.69	236.8	86.50	
48	140.0	46.73	166.6	60.32	189.4	69.34	192.1	72.28	194.1	72.52	200.5	72.68	206.0	73.26	
90	10	159.8	19.43	190.8	23.36	221.8	27.53	236.9	29.68	251.9	31.94	282.9	35.75	314.0	39.57
	12	159.8	19.67	190.8	23.72	221.8	28.01	236.9	30.27	251.9	32.66	282.9	36.46	314.0	40.46
	14	159.8	20.02	190.8	24.19	221.8	28.60	236.9	30.87	251.9	33.25	282.9	37.17	314.0	41.28
	16	159.8	20.38	190.8	24.67	221.8	29.20	236.9	31.46	251.9	33.85	282.9	37.88	314.0	41.99
	18	159.8	20.74	190.8	25.15	221.8	29.68	236.9	32.18	251.9	34.56	282.9	38.70	314.0	44.10
	20	159.8	21.10	190.8	25.62	221.8	30.27	236.9	32.78	251.9	35.87	282.9	41.42	314.0	46.21
	21	159.8	21.33	190.8	25.86	221.8	30.87	236.9	33.85	251.9	37.19	282.9	42.09	314.0	47.27
	23	159.8	21.81	190.8	26.94	221.8	33.01	236.9	36.35	251.9	39.81	282.9	44.64	309.7	49.49
	25	159.8	22.88	190.8	28.72	221.8	35.28	236.9	38.85	251.9	42.55	282.9	47.73	305.2	51.61
	27	159.8	24.43	190.8	30.63	221.8	37.66	236.9	41.48	251.9	45.53	282.9	50.74	300.7	54.03
	29	159.8	25.86	190.8	32.66	221.8	40.28	236.9	44.34	251.9	48.63	282.9	53.75	296.2	56.21
	31	159.8	27.53	190.8	34.80	221.8	42.91	236.9	47.20	251.9	51.85	282.9	56.43	291.8	58.38
	33	159.8	29.32	190.8	37.07	221.8	45.77	236.9	50.30	251.9	54.99	282.9	59.16	287.3	60.56
	35	159.8	31.11	190.8	39.33	221.8	48.63	236.9	53.63	251.9	58.31	278.1	62.56	282.8	63.99
	37	159.8	33.01	190.8	41.83	221.8	51.85	236.9	56.98	251.9	61.55	273.6	65.39	278.3	66.86
	39	159.8	34.95	190.8	44.49	221.8	54.88	236.9	60.63	251.9	64.73	269.1	68.94	273.9	69.77
	41	155.7	39.11	185.9	49.33	216.2	60.23	230.8	66.31	245.5	69.88	257.9	72.66	262.5	74.32
	43	151.9	42.22	181.3	53.31	210.8	65.79	225.1	71.41	239.4	74.93	247.2	77.80	251.7	78.74
46	142.3	47.52	169.9	60.71	197.6	74.96	211.0	80.96	217.5	83.24	225.7	85.40	229.9	85.53	
48	125.9	41.53	150.3	53.10	174.8	65.59	186.6	70.63	188.9	71.73	196.2	72.68	199.9	73.26	
80	10	141.9	18.10	169.2	21.75	196.5	25.52	210.6	27.53	224.7	29.54	251.9	33.69	279.2	36.58
	12	141.9	18.48	169.2	22.00	196.5	26.02	210.6	28.03	224.7	30.05	251.9	34.32	279.2	37.30
	14	141.9	18.73	169.2	22.50	196.5	26.40	210.6	28.54	224.7	30.55	251.9	34.95	279.2	38.03
	16	141.9	18.98	169.2	22.88	196.5	26.90	210.6	29.04	224.7	31.18	251.9	35.70	279.2	38.75
	18	141.9	19.36	169.2	23.26	196.5	27.41	210.6	29.54	224.7	31.81	251.9	36.33	279.2	39.60
	20	141.9	19.74	169.2	23.76	196.5	28.03	210.6	30.17	224.7	32.43	251.9	37.71	279.2	41.95
	21	141.9	19.86	169.2	24.01	196.5	28.29	210.6	30.55	224.7	33.19	251.9	38.91	279.2	43.06
	23	141.9	20.24	169.2	24.39	196.5	29.54	210.6	32.43	224.7	35.45	251.9	41.07	279.2	45.20
	25	141.9	20.99	169.2	26.02	196.5	31.68	210.6	34.70	224.7	37.97	251.9	43.96	279.2	48.33
	27	141.9	22.25	169.2	27.66	196.5	33.82	210.6	37.09	224.7	40.48	251.9	46.71	279.2	50.85
	29	141.9	23.63	169.2	29.54	196.5	35.95	210.6	39.47	224.7	43.25	251.9	50.05	279.2	53.40
	31	141.9	25.14	169.2	31.30	196.5	38.34	210.6	42.11	224.7	46.01	251.9	53.11	279.2	56.05
	33	141.9	26.65	169.2	33.44	196.5	40.86	210.6	44.88	224.7	49.03	251.9	55.96	279.2	58.74
	35	141.9	28.29	169.2	35.45	196.5	43.50	210.6	47.77	224.7	52.30	251.9	59.33	276.2	62.07
	37	141.9	29.92	169.2	37.69	196.5	46.14	210.6	50.79	224.7	55.57	251.9	62.62	271.8	64.92
	39	141.9	31.62	169.2	39.85	196.5	49.36	210.6	54.60	224.7	59.71	251.9	66.16	267.3	68.48
	41	138.3	34.98	164.9	44.16	191.4	54.17	205.2	59.85	218.9	65.61	245.5	71.20	256.1	72.83
	43	134.9	38.51	160.8	48.19	186.7	59.13	200.1	65.23	213.5	71.70	239.4	76.24	245.5	77.96
46	126.4	42.84	150.7	54.28	175.0	66.62	187.5	72.60	200.1	80.91	218.9	85.40	224.1	85.53	
48	111.8	37.41	133.3	47.46	154.8	58.26	165.9	63.41	177.0	70.82	190.1	72.68	194.7	73.26	

# 7. Capacity Tables

Cooling Capacity (94HP)

Combination (%)	Outdoor air temp. (DB, °C)	Indoor air temp. (DB/WB, °C)													
		20		23		26		27		28		30		32	
		14		16		18		19		20		22		24	
		TC	PI	TC	PI	TC	PI	TC	PI	TC	PI	TC	PI	TC	PI
70	10	124.1	16.00	148.5	19.02	172.0	22.05	184.2	23.81	196.5	25.45	220.0	28.97	244.4	32.41
	12	124.1	16.25	148.5	19.27	172.0	22.55	184.2	24.19	196.5	25.95	220.0	29.48	244.4	33.01
	14	124.1	16.50	148.5	19.53	172.0	22.93	184.2	24.56	196.5	26.33	220.0	30.11	244.4	33.62
	16	124.1	16.75	148.5	19.90	172.0	23.30	184.2	25.07	196.5	26.83	220.0	30.61	244.4	34.34
	18	124.1	17.01	148.5	20.28	172.0	23.81	184.2	25.57	196.5	27.34	220.0	31.12	244.4	34.95
	20	124.1	17.26	148.5	20.66	172.0	24.19	184.2	26.08	196.5	27.97	220.0	31.87	244.4	36.28
	21	124.1	17.51	148.5	20.79	172.0	24.44	184.2	26.33	196.5	28.22	220.0	32.37	244.4	37.05
	23	124.1	17.76	148.5	21.29	172.0	24.94	184.2	27.21	196.5	29.60	220.0	34.64	244.4	39.12
	25	124.1	18.01	148.5	22.05	172.0	26.58	184.2	29.10	196.5	31.62	220.0	37.04	244.4	41.02
	27	124.1	19.02	148.5	23.56	172.0	28.34	184.2	30.86	196.5	33.76	220.0	39.56	244.4	43.59
	29	124.1	20.28	148.5	24.94	172.0	30.11	184.2	32.88	196.5	35.90	220.0	42.20	244.4	46.70
	31	124.1	21.54	148.5	26.58	172.0	32.12	184.2	35.15	196.5	38.30	220.0	44.97	244.4	49.56
	33	124.1	22.80	148.5	28.09	172.0	34.14	184.2	37.29	196.5	40.69	220.0	47.87	244.4	52.75
	35	124.1	24.06	148.5	29.99	172.0	36.28	184.2	39.68	196.5	43.33	220.0	51.02	244.4	55.94
	37	124.1	25.57	148.5	31.76	172.0	38.55	184.2	42.20	196.5	46.11	220.0	54.29	244.4	59.03
	39	124.1	27.16	148.5	33.86	172.0	41.22	184.2	45.40	196.5	49.80	220.0	58.11	244.4	63.64
	41	120.9	30.02	144.7	37.10	167.6	45.21	179.5	49.80	191.4	54.14	214.3	63.82	238.1	68.66
	43	117.9	32.68	141.1	40.43	163.5	49.33	175.1	54.30	186.7	59.12	209.0	69.72	232.3	74.23
46	110.5	36.32	132.3	45.46	153.2	55.55	164.1	60.49	175.0	66.65	195.9	78.64	217.7	82.74	
48	97.8	31.69	117.0	39.71	135.5	48.57	145.1	52.86	154.8	58.31	173.3	68.81	192.5	71.61	
60	10	106.2	13.89	126.9	16.28	147.6	18.93	157.9	20.32	168.3	21.59	188.9	24.49	209.6	27.39
	12	106.2	14.14	126.9	16.54	147.6	19.19	157.9	20.58	168.3	21.96	188.9	24.87	209.6	27.90
	14	106.2	14.26	126.9	16.79	147.6	19.57	157.9	20.95	168.3	22.34	188.9	25.37	209.6	28.40
	16	106.2	14.52	126.9	17.17	147.6	19.82	157.9	21.33	168.3	22.85	188.9	25.88	209.6	28.91
	18	106.2	14.77	126.9	17.42	147.6	20.20	157.9	21.71	168.3	23.23	188.9	26.26	209.6	29.54
	20	106.2	15.02	126.9	17.67	147.6	20.58	157.9	22.09	168.3	23.60	188.9	26.76	209.6	30.17
	21	106.2	15.15	126.9	17.80	147.6	20.83	157.9	22.34	168.3	23.86	188.9	27.14	209.6	30.42
	23	106.2	15.40	126.9	18.18	147.6	21.08	157.9	22.72	168.3	24.36	188.9	28.15	209.6	32.31
	25	106.2	15.65	126.9	18.56	147.6	21.96	157.9	23.86	168.3	25.88	188.9	30.04	209.6	34.59
	27	106.2	16.16	126.9	19.57	147.6	23.35	157.9	25.37	168.3	27.52	188.9	31.94	209.6	36.86
	29	106.2	17.17	126.9	20.83	147.6	24.87	157.9	27.01	168.3	29.29	188.9	34.08	209.6	39.38
	31	106.2	18.18	126.9	22.09	147.6	26.38	157.9	28.78	168.3	31.18	188.9	36.35	209.6	41.91
	33	106.2	19.19	126.9	23.35	147.6	28.02	157.9	30.55	168.3	33.20	188.9	38.63	209.6	44.69
	35	106.2	20.32	126.9	24.87	147.6	29.79	157.9	32.44	168.3	35.22	188.9	41.15	209.6	47.46
	37	106.2	21.46	126.9	26.24	147.6	31.56	157.9	34.46	168.3	37.36	188.9	43.68	209.6	50.49
	39	106.2	22.82	126.9	27.94	147.6	34.06	157.9	36.97	168.3	40.21	188.9	46.83	209.6	54.11
	41	103.5	24.75	123.7	30.58	143.8	36.99	153.9	40.39	164.0	43.65	184.1	51.39	204.3	58.80
	43	100.9	26.90	120.6	33.29	140.2	40.32	150.1	44.01	159.9	47.60	179.6	56.10	199.2	64.22
46	94.6	30.12	113.0	37.38	131.4	45.35	140.6	49.47	149.8	53.56	168.3	63.21	186.7	73.17	
48	83.7	26.25	100.0	32.62	116.3	39.62	124.4	43.21	132.6	46.80	148.9	55.29	165.1	64.02	
50	10	88.8	12.02	106.2	13.91	123.1	15.81	131.6	16.95	140.1	17.96	157.0	20.24	174.8	22.51
	12	88.8	12.14	106.2	14.04	123.1	16.06	131.6	17.20	140.1	18.34	157.0	20.62	174.8	22.89
	14	88.8	12.27	106.2	14.29	123.1	16.32	131.6	17.46	140.1	18.59	157.0	20.87	174.8	23.27
	16	88.8	12.52	106.2	14.55	123.1	16.57	131.6	17.83	140.1	18.85	157.0	21.25	174.8	23.65
	18	88.8	12.65	106.2	14.67	123.1	16.82	131.6	18.09	140.1	19.23	157.0	21.63	174.8	24.16
	20	88.8	12.78	106.2	14.93	123.1	17.20	131.6	18.34	140.1	19.61	157.0	22.01	174.8	24.66
	21	88.8	12.90	106.2	15.05	123.1	17.33	131.6	18.59	140.1	19.73	157.0	22.26	174.8	24.92
	23	88.8	13.15	106.2	15.30	123.1	17.58	131.6	18.85	140.1	20.11	157.0	22.64	174.8	25.42
	25	88.8	13.28	106.2	15.56	123.1	17.96	131.6	19.23	140.1	20.74	157.0	23.78	174.8	27.19
	27	88.8	13.53	106.2	16.06	123.1	18.97	131.6	20.49	140.1	22.01	157.0	25.42	174.8	28.97
	29	88.8	14.29	106.2	17.08	123.1	20.11	131.6	21.76	140.1	23.40	157.0	26.94	174.8	30.74
	31	88.8	15.05	106.2	18.09	123.1	21.38	131.6	23.02	140.1	24.92	157.0	28.71	174.8	32.76
	33	88.8	15.94	106.2	19.10	123.1	22.64	131.6	24.41	140.1	26.44	157.0	30.48	174.8	34.91
	35	88.8	16.82	106.2	20.24	123.1	23.91	131.6	25.93	140.1	27.95	157.0	32.25	174.8	37.06
	37	88.8	17.83	106.2	21.38	123.1	25.30	131.6	27.45	140.1	29.60	157.0	34.40	174.8	39.34
	39	88.8	19.02	106.2	22.91	123.1	27.10	131.6	29.54	140.1	31.76	157.0	36.64	174.8	42.49
	41	86.6	20.57	103.5	24.80	120.0	29.64	128.2	32.00	136.5	34.41	153.0	40.17	170.4	46.14
	43	84.4	22.36	100.9	26.98	117.0	32.25	125.1	34.84	133.1	37.46	149.2	43.80	166.2	50.33
46	79.1	25.04	94.6	30.26	109.7	36.17	117.2	39.13	124.7	42.06	139.8	49.29	155.7	56.67	
48	70.0	21.82	83.7	26.39	97.0	31.55	103.7	34.15	110.3	36.70	123.7	43.07	137.7	49.53	

**Note**

1. TC: Total Capacity(kW), PI : Power Input(kW, Comp. + Outdoor fan motor)
2. Capacity tables show the average value of conditions which may occur.



# 7. Capacity Tables

◆ ARUM960LTE5

Cooling Capacity (96HP)

Combination (%)	Outdoor air temp. (DB, °C)	Indoor air temp. (DB/WB, °C)													
		20		23		26		27		28		30		32	
		14	16	18	19	20	22	24	TC	PI	TC	PI	TC	PI	
130	10	266.2	29.54	317.1	36.11	339.8	41.88	349.6	42.73	359.3	43.08	376.6	43.42	386.4	43.59
	12	266.2	30.27	317.1	37.39	339.8	43.60	349.6	43.89	359.3	44.24	376.6	44.59	386.4	44.99
	14	266.2	31.29	317.1	38.75	339.8	45.25	349.6	45.57	359.3	45.94	376.6	46.30	386.4	46.71
	16	266.2	32.43	317.1	40.10	339.8	47.27	349.6	47.71	359.3	48.09	376.6	48.52	386.4	48.90
	18	266.2	33.79	317.1	42.42	339.8	49.44	349.6	50.51	359.3	50.91	376.6	51.42	386.4	51.77
	20	266.2	35.28	317.1	45.19	339.8	51.88	349.6	55.56	359.3	56.00	371.1	56.56	380.9	56.95
	21	266.2	36.21	317.1	46.78	339.8	52.97	349.6	58.80	359.3	59.27	369.1	59.85	378.8	60.26
	23	266.2	38.85	317.1	49.21	339.8	55.73	349.6	64.88	354.8	65.39	363.6	66.04	373.4	66.50
	25	266.2	41.49	317.1	52.04	339.8	59.54	345.4	71.95	349.6	72.53	359.3	73.24	369.1	73.75
	27	266.2	44.40	317.1	55.63	335.5	63.44	339.8	79.21	345.4	79.84	354.8	80.63	363.6	81.19
	29	266.2	47.31	317.1	59.48	330.1	68.26	334.9	87.05	339.8	87.57	349.6	88.36	359.3	88.70
	31	266.2	50.48	316.0	62.65	324.6	72.61	330.1	86.69	334.9	87.21	344.1	87.99	353.9	88.33
	33	266.2	53.78	310.6	66.38	320.3	77.87	325.5	85.89	330.1	86.41	339.8	87.18	348.4	87.53
	35	266.2	57.35	305.1	69.51	314.9	84.35	320.3	84.77	325.5	85.28	334.4	86.05	344.1	86.39
	37	266.2	61.16	300.8	72.95	310.6	83.24	314.9	83.65	320.3	84.16	329.0	84.91	338.8	85.24
	39	266.2	65.12	295.5	76.79	305.1	82.12	310.6	82.53	314.9	83.03	324.6	83.77	334.4	84.10
41	259.4	69.09	283.2	80.63	292.8	81.01	297.2	81.42	303.0	81.90	312.1	82.64	320.5	82.96	
43	253.0	72.86	271.4	79.49	280.8	79.89	285.1	80.30	290.8	80.78	299.8	81.50	307.9	81.82	
46	237.1	77.99	247.6	77.83	256.6	78.22	260.6	78.62	266.0	79.09	274.4	79.80	282.0	80.11	
48	209.8	75.81	215.0	76.04	223.1	76.21	226.6	76.41	231.5	77.07	238.9	77.56	245.5	77.86	
120	10	240.9	26.58	286.5	32.59	313.0	38.72	322.6	41.85	332.1	42.51	350.2	42.68	358.7	43.02
	12	240.9	27.30	286.5	33.69	313.0	40.28	322.6	42.73	332.1	44.08	350.2	44.62	358.7	44.98
	14	240.9	28.23	286.5	34.83	313.0	41.91	322.6	44.35	332.1	45.70	350.2	46.37	358.7	46.75
	16	240.9	29.25	286.5	36.25	313.0	43.53	322.6	46.01	332.1	47.81	350.2	48.40	358.7	48.79
	18	240.9	30.40	286.5	37.89	313.0	45.27	322.6	48.43	332.1	50.27	350.2	50.84	358.7	51.24
	20	240.9	31.55	286.5	40.17	313.0	47.70	322.6	50.97	332.1	52.93	350.2	53.62	358.7	54.05
	21	240.9	32.51	286.5	41.63	313.0	49.04	322.6	52.47	332.1	54.67	350.2	55.36	358.7	55.81
	23	240.9	34.75	286.5	44.53	313.0	52.55	322.6	55.75	332.1	58.28	350.2	58.87	358.7	59.34
	25	240.9	37.13	286.5	47.70	313.0	55.42	322.6	59.43	332.1	62.50	346.0	63.02	354.4	63.53
	27	240.9	39.64	286.5	51.01	313.0	58.98	322.6	63.50	332.1	67.17	340.6	67.62	349.2	68.16
	29	240.9	42.29	286.5	54.44	313.0	62.06	322.6	67.95	326.8	71.58	335.3	72.66	344.8	73.24
	31	240.9	45.06	286.5	58.14	313.0	65.28	318.4	72.80	322.6	76.79	331.1	78.15	339.5	78.78
	33	240.9	47.97	286.5	61.98	308.8	69.05	313.0	79.02	317.2	82.45	325.8	83.39	334.3	84.05
	35	240.9	51.01	286.5	66.07	303.5	73.09	307.7	87.05	313.0	87.49	321.6	87.75	330.0	88.44
	37	240.9	54.87	286.5	69.72	299.2	77.92	303.5	85.22	307.7	85.65	316.2	85.90	324.7	86.58
	39	240.9	59.07	285.4	73.69	294.0	82.65	298.2	83.47	302.4	83.89	312.0	84.14	320.4	84.80
41	234.8	63.27	273.0	77.65	282.2	81.02	286.2	81.72	290.4	82.13	298.8	82.37	307.3	83.03	
43	228.9	67.53	261.5	76.54	270.6	79.20	274.5	79.97	278.6	80.37	286.8	80.61	295.1	81.25	
46	214.6	72.61	238.5	74.72	247.1	76.71	250.8	77.34	254.6	77.73	262.3	77.96	270.0	78.58	
48	189.8	71.13	207.1	73.39	214.8	75.21	218.0	75.67	221.4	75.91	228.2	76.22	235.1	76.52	
110	10	215.8	23.90	257.3	29.14	287.4	34.61	295.6	37.46	314.4	40.32	321.7	41.44	343.4	42.13
	12	215.8	24.65	257.3	30.12	287.4	36.04	295.6	38.52	314.4	41.83	321.7	43.18	343.4	44.18
	14	215.8	25.42	257.3	31.48	287.4	37.68	295.6	40.43	314.4	43.94	321.7	45.19	343.4	46.14
	16	215.8	26.32	257.3	32.62	287.4	39.24	295.6	42.19	314.4	45.96	321.7	47.22	343.4	48.05
	18	215.8	27.30	257.3	33.98	287.4	41.49	295.6	44.43	314.4	48.48	321.7	49.44	343.4	50.37
	20	215.8	28.27	257.3	35.68	287.4	44.00	295.6	46.47	314.4	50.84	321.7	52.09	343.4	52.93
	21	215.8	28.90	257.3	36.74	287.4	45.13	295.6	47.72	314.4	52.25	321.7	53.57	343.4	54.41
	23	215.8	30.79	257.3	39.38	287.4	47.65	295.6	50.38	314.4	55.20	321.7	56.39	343.4	57.32
	25	215.8	32.90	257.3	42.02	287.4	50.34	295.6	53.26	314.4	58.32	321.7	59.16	339.2	60.37
	27	215.8	35.15	257.3	44.93	287.4	53.20	295.6	56.37	314.4	60.91	321.7	62.31	334.2	63.37
	29	215.8	37.53	257.3	47.97	287.4	56.22	295.6	59.70	314.4	64.37	321.7	65.48	330.0	66.47
	31	215.8	39.91	257.3	51.14	287.4	59.41	295.6	63.25	309.2	67.64	317.4	68.96	324.8	69.69
	33	215.8	42.55	257.3	54.44	287.4	62.77	295.6	67.02	305.0	71.43	312.3	72.61	320.5	73.02
	35	215.8	45.19	257.3	58.14	287.4	66.29	295.6	71.02	299.9	75.39	307.1	76.08	315.4	76.46
	37	215.8	47.90	257.3	61.71	287.4	69.98	291.5	75.24	294.6	79.51	303.0	79.79	310.2	80.01
	39	215.8	51.64	257.3	65.58	282.2	73.84	286.3	80.48	290.5	83.45	297.7	83.59	306.1	83.67
41	210.3	55.38	250.7	69.44	270.1	77.86	274.3	87.05	277.9	87.05	286.0	87.75	293.1	88.44	
43	205.1	58.15	244.5	72.35	258.9	82.57	263.1	83.50	266.5	83.32	274.4	83.79	281.4	84.03	
46	192.2	56.76	229.1	69.84	236.2	78.36	240.3	78.36	243.4	79.04	250.9	79.48	257.4	79.69	
48	170.0	55.13	199.2	67.28	205.1	74.56	208.9	75.06	211.6	75.42	218.2	75.63	223.9	75.93	

# 7. Capacity Tables

Cooling Capacity (96HP)

Combination (%)	Outdoor air temp. (DB, °C)	Indoor air temp. (DB/WB, °C)													
		20		23		26		27		28		30		32	
		14		16		18		19		20		22		24	
		TC	PI	TC	PI	TC	PI	TC	PI	TC	PI	TC	PI	TC	PI
100	10	181.4	21.53	216.0	26.16	251.5	31.04	268.8	33.54	286.1	36.04	317.2	40.12	324.1	40.44
	12	181.4	22.22	216.0	27.23	251.5	32.09	268.8	34.44	286.1	37.19	317.2	42.27	324.1	42.69
	14	181.4	22.91	216.0	28.32	251.5	33.44	268.8	35.93	286.1	38.79	317.2	44.64	324.1	45.06
	16	181.4	23.61	216.0	29.26	251.5	34.87	268.8	37.64	286.1	40.88	317.2	46.79	324.1	47.45
	18	181.4	24.30	216.0	30.34	251.5	36.22	268.8	39.48	286.1	43.34	317.2	49.44	324.1	49.83
	20	181.4	25.17	216.0	31.49	251.5	38.32	268.8	42.29	286.1	46.38	317.2	51.80	324.1	52.22
	21	181.4	25.70	216.0	32.24	251.5	39.64	268.8	43.74	286.1	48.10	317.2	52.99	324.1	53.41
	23	181.4	27.22	216.0	34.49	251.5	42.55	268.8	46.91	286.1	51.54	317.2	55.49	324.1	55.93
	25	181.4	28.94	216.0	36.74	251.5	45.46	268.8	50.21	286.1	55.10	317.2	57.85	321.4	58.32
	27	181.4	30.92	216.0	39.25	251.5	48.63	268.8	53.65	286.1	58.59	311.0	60.57	317.6	61.06
	29	181.4	32.90	216.0	41.89	251.5	51.93	268.8	57.35	286.1	62.01	305.2	63.01	312.8	63.52
	31	181.4	35.15	216.0	44.66	251.5	55.37	268.8	61.18	286.1	65.16	300.7	65.45	308.0	65.98
	33	181.4	37.26	216.0	47.57	251.5	59.07	268.8	65.28	286.1	67.61	295.8	67.89	303.2	68.44
	35	181.4	39.64	216.0	50.61	251.5	62.90	268.8	69.64	281.7	70.06	290.4	70.33	297.8	70.89
	37	181.4	42.46	216.0	54.28	251.5	66.63	268.8	72.96	277.1	73.31	285.1	73.61	291.8	74.29
	39	181.4	45.52	216.0	58.31	251.5	70.60	268.8	76.52	272.5	76.86	280.5	77.15	287.0	77.87
	41	178.6	48.58	212.6	62.34	247.5	74.58	257.9	80.09	263.6	80.41	269.8	80.69	278.5	81.44
	43	172.4	51.41	205.3	66.09	239.0	78.15	247.3	83.15	250.1	83.45	257.9	83.72	264.6	84.51
46	161.6	55.30	192.4	71.25	224.0	82.89	225.8	87.05	228.2	87.31	235.6	87.56	241.9	88.39	
48	142.9	47.75	170.2	61.64	193.4	70.86	196.2	73.86	198.3	74.10	204.8	74.27	210.4	74.86	
90	10	163.2	19.85	194.9	23.87	226.6	28.13	241.9	30.33	257.3	32.64	289.0	36.53	320.6	40.44
	12	163.2	20.10	194.9	24.24	226.6	28.62	241.9	30.93	257.3	33.37	289.0	37.26	320.6	41.35
	14	163.2	20.46	194.9	24.72	226.6	29.23	241.9	31.54	257.3	33.98	289.0	37.98	320.6	42.19
	16	163.2	20.83	194.9	25.21	226.6	29.84	241.9	32.15	257.3	34.59	289.0	38.70	320.6	42.91
	18	163.2	21.19	194.9	25.70	226.6	30.33	241.9	32.88	257.3	35.32	289.0	39.55	320.6	45.06
	20	163.2	21.56	194.9	26.18	226.6	30.93	241.9	33.49	257.3	36.66	289.0	42.32	320.6	47.22
	21	163.2	21.80	194.9	26.43	226.6	31.54	241.9	34.59	257.3	38.00	289.0	43.01	320.6	48.30
	23	163.2	22.29	194.9	27.52	226.6	33.74	241.9	37.15	257.3	40.68	289.0	45.61	316.2	50.58
	25	163.2	23.38	194.9	29.35	226.6	36.05	241.9	39.70	257.3	43.48	289.0	48.77	311.7	52.73
	27	163.2	24.97	194.9	31.30	226.6	38.49	241.9	42.38	257.3	46.52	289.0	51.85	307.1	55.21
	29	163.2	26.43	194.9	33.37	226.6	41.17	241.9	45.31	257.3	49.69	289.0	54.92	302.5	57.44
	31	163.2	28.13	194.9	35.56	226.6	43.84	241.9	48.23	257.3	52.98	289.0	57.67	298.0	59.66
	33	163.2	29.96	194.9	37.88	226.6	46.77	241.9	51.40	257.3	56.19	289.0	60.45	293.4	61.88
	35	163.2	31.79	194.9	40.19	226.6	49.69	241.9	54.81	257.3	59.59	284.0	63.92	288.8	65.39
	37	163.2	33.74	194.9	42.75	226.6	52.98	241.9	58.22	257.3	62.90	279.4	66.82	284.3	68.32
	39	163.2	35.72	194.9	45.47	226.6	56.08	241.9	61.95	257.3	66.14	274.8	70.45	279.7	71.30
	41	159.0	39.97	189.9	50.41	220.8	61.55	235.7	67.76	250.7	71.41	263.4	74.24	268.1	75.95
	43	155.1	43.14	185.2	54.47	215.3	67.23	229.9	72.97	244.5	76.57	252.5	79.50	257.1	80.47
46	145.3	48.56	173.6	62.03	201.8	76.60	215.5	82.73	222.2	85.06	230.5	87.27	234.8	87.40	
48	128.6	42.44	153.5	54.26	178.5	67.02	190.6	72.17	192.9	73.30	200.3	74.27	204.1	74.86	
80	10	145.0	18.50	172.8	22.22	200.6	26.08	215.0	28.13	229.4	30.19	257.3	34.43	285.1	37.38
	12	145.0	18.88	172.8	22.48	200.6	26.59	215.0	28.65	229.4	30.70	257.3	35.07	285.1	38.12
	14	145.0	19.14	172.8	22.99	200.6	26.98	215.0	29.16	229.4	31.22	257.3	35.71	285.1	38.86
	16	145.0	19.40	172.8	23.38	200.6	27.49	215.0	29.67	229.4	31.86	257.3	36.48	285.1	39.60
	18	145.0	19.78	172.8	23.77	200.6	28.00	215.0	30.19	229.4	32.50	257.3	37.13	285.1	40.46
	20	145.0	20.17	172.8	24.28	200.6	28.65	215.0	30.83	229.4	33.14	257.3	38.54	285.1	42.87
	21	145.0	20.30	172.8	24.54	200.6	28.90	215.0	31.22	229.4	33.91	257.3	39.76	285.1	44.01
	23	145.0	20.68	172.8	24.92	200.6	30.19	215.0	33.14	229.4	36.23	257.3	41.97	285.1	46.19
	25	145.0	21.45	172.8	26.59	200.6	32.37	215.0	35.46	229.4	38.80	257.3	44.92	285.1	49.38
	27	145.0	22.74	172.8	28.26	200.6	34.56	215.0	37.90	229.4	41.37	257.3	47.73	285.1	51.96
	29	145.0	24.15	172.8	30.19	200.6	36.74	215.0	40.34	229.4	44.19	257.3	51.14	285.1	54.57
	31	145.0	25.69	172.8	31.99	200.6	39.18	215.0	43.04	229.4	47.02	257.3	54.27	285.1	57.27
	33	145.0	27.23	172.8	34.17	200.6	41.75	215.0	45.86	229.4	50.10	257.3	57.18	285.1	60.03
	35	145.0	28.90	172.8	36.23	200.6	44.45	215.0	48.82	229.4	53.44	257.3	60.63	282.1	63.43
	37	145.0	30.57	172.8	38.51	200.6	47.15	215.0	51.90	229.4	56.78	257.3	63.99	277.5	66.34
	39	145.0	32.31	172.8	40.72	200.6	50.43	215.0	55.80	229.4	61.02	257.3	67.61	273.0	69.98
	41	141.3	35.74	168.4	45.12	195.5	55.35	209.5	61.16	223.6	67.05	250.7	72.76	261.5	74.43
	43	137.8	39.35	164.2	49.24	190.7	60.42	204.4	66.65	218.0	73.27	244.5	77.91	250.7	79.66
46	129.1	43.78	153.9	55.47	178.7	68.08	191.5	74.18	204.3	82.68	223.6	87.27	228.9	87.40	
48	114.2	38.23	136.1	48.50	158.1	59.54	169.4	64.80	180.8	72.37	194.2	74.27	198.8	74.86	

# 7. Capacity Tables

Cooling Capacity (96HP)

Combination (%)	Outdoor air temp. (DB, °C)	Indoor air temp. (DB/WB, °C)													
		20		23		26		27		28		30		32	
		14	16	18	19	20	22	24	TC	PI	TC	PI	TC	PI	
70	10	126.7	16.35	151.7	19.44	175.7	22.53	188.2	24.33	200.6	26.00	224.6	29.61	249.6	33.12
	12	126.7	16.61	151.7	19.70	175.7	23.04	188.2	24.72	200.6	26.52	224.6	30.12	249.6	33.74
	14	126.7	16.86	151.7	19.95	175.7	23.43	188.2	25.10	200.6	26.90	224.6	30.77	249.6	34.35
	16	126.7	17.12	151.7	20.34	175.7	23.81	188.2	25.62	200.6	27.42	224.6	31.28	249.6	35.10
	18	126.7	17.38	151.7	20.72	175.7	24.33	188.2	26.13	200.6	27.93	224.6	31.80	249.6	35.71
	20	126.7	17.64	151.7	21.11	175.7	24.72	188.2	26.65	200.6	28.58	224.6	32.57	249.6	37.07
	21	126.7	17.89	151.7	21.24	175.7	24.97	188.2	26.90	200.6	28.83	224.6	33.08	249.6	37.86
	23	126.7	18.15	151.7	21.75	175.7	25.49	188.2	27.80	200.6	30.25	224.6	35.40	249.6	39.97
	25	126.7	18.41	151.7	22.53	175.7	27.16	188.2	29.74	200.6	32.31	224.6	37.85	249.6	41.92
	27	126.7	19.44	151.7	24.07	175.7	28.96	188.2	31.54	200.6	34.50	224.6	40.42	249.6	44.54
	29	126.7	20.72	151.7	25.49	175.7	30.77	188.2	33.60	200.6	36.69	224.6	43.12	249.6	47.72
	31	126.7	22.01	151.7	27.16	175.7	32.83	188.2	35.91	200.6	39.13	224.6	45.96	249.6	50.64
	33	126.7	23.30	151.7	28.71	175.7	34.88	188.2	38.10	200.6	41.58	224.6	48.92	249.6	53.91
	35	126.7	24.59	151.7	30.65	175.7	37.07	188.2	40.55	200.6	44.28	224.6	52.13	249.6	57.16
	37	126.7	26.13	151.7	32.45	175.7	39.39	188.2	43.12	200.6	47.11	224.6	55.48	249.6	60.33
	39	126.7	27.75	151.7	34.60	175.7	42.12	188.2	46.40	200.6	50.89	224.6	59.38	249.6	65.03
	41	123.5	30.68	147.8	37.91	171.2	46.20	183.3	50.89	195.5	55.33	218.9	65.22	243.2	70.16
	43	120.4	33.39	144.1	41.31	167.0	50.41	178.8	55.49	190.7	60.42	213.5	71.24	237.2	75.86
46	112.9	37.11	135.1	46.45	156.5	56.77	167.6	61.81	178.7	68.11	200.1	80.36	222.3	84.55	
48	99.8	32.39	119.5	40.58	138.4	49.63	148.2	54.02	158.1	59.58	177.0	70.32	196.6	73.18	
60	10	108.5	14.19	129.6	16.64	150.7	19.35	161.3	20.77	171.8	22.06	193.0	25.02	214.1	27.99
	12	108.5	14.45	129.6	16.90	150.7	19.61	161.3	21.03	171.8	22.44	193.0	25.41	214.1	28.51
	14	108.5	14.58	129.6	17.16	150.7	19.99	161.3	21.41	171.8	22.83	193.0	25.93	214.1	29.02
	16	108.5	14.83	129.6	17.54	150.7	20.25	161.3	21.80	171.8	23.35	193.0	26.44	214.1	29.54
	18	108.5	15.09	129.6	17.80	150.7	20.64	161.3	22.19	171.8	23.73	193.0	26.83	214.1	30.18
	20	108.5	15.35	129.6	18.06	150.7	21.03	161.3	22.57	171.8	24.12	193.0	27.35	214.1	30.83
	21	108.5	15.48	129.6	18.19	150.7	21.28	161.3	22.83	171.8	24.38	193.0	27.73	214.1	31.09
	23	108.5	15.74	129.6	18.57	150.7	21.54	161.3	23.22	171.8	24.89	193.0	28.76	214.1	33.02
	25	108.5	15.99	129.6	18.96	150.7	22.44	161.3	24.38	171.8	26.44	193.0	30.70	214.1	35.34
	27	108.5	16.51	129.6	19.99	150.7	23.86	161.3	25.93	171.8	28.12	193.0	32.63	214.1	37.66
	29	108.5	17.54	129.6	21.28	150.7	25.41	161.3	27.60	171.8	29.93	193.0	34.83	214.1	40.24
	31	108.5	18.57	129.6	22.57	150.7	26.96	161.3	29.41	171.8	31.86	193.0	37.15	214.1	42.82
	33	108.5	19.61	129.6	23.86	150.7	28.64	161.3	31.22	171.8	33.92	193.0	39.47	214.1	45.66
	35	108.5	20.77	129.6	25.41	150.7	30.44	161.3	33.15	171.8	35.99	193.0	42.05	214.1	48.50
	37	108.5	21.93	129.6	26.82	150.7	32.25	161.3	35.21	171.8	38.18	193.0	44.63	214.1	51.60
	39	108.5	23.32	129.6	28.55	150.7	34.81	161.3	37.78	171.8	41.09	193.0	47.85	214.1	55.29
	41	105.7	25.29	126.3	31.25	146.9	37.80	157.2	41.27	167.4	44.60	188.0	52.52	208.6	60.08
	43	103.1	27.49	123.2	34.02	143.2	41.21	153.3	44.97	163.3	48.64	183.4	57.33	203.4	65.63
46	96.6	30.78	115.4	38.20	134.2	46.35	143.6	50.56	153.0	54.73	171.8	64.60	190.7	74.77	
48	85.5	26.82	102.1	33.34	118.7	40.49	127.1	44.15	135.4	47.83	152.0	56.49	168.7	65.42	
50	10	90.7	12.28	108.5	14.22	125.8	16.16	134.4	17.32	143.0	18.35	160.3	20.68	178.6	23.01
	12	90.7	12.41	108.5	14.35	125.8	16.41	134.4	17.58	143.0	18.74	160.3	21.07	178.6	23.39
	14	90.7	12.54	108.5	14.61	125.8	16.67	134.4	17.84	143.0	19.00	160.3	21.33	178.6	23.78
	16	90.7	12.80	108.5	14.86	125.8	16.93	134.4	18.22	143.0	19.26	160.3	21.71	178.6	24.17
	18	90.7	12.93	108.5	14.99	125.8	17.19	134.4	18.48	143.0	19.65	160.3	22.10	178.6	24.69
	20	90.7	13.05	108.5	15.25	125.8	17.58	134.4	18.74	143.0	20.03	160.3	22.49	178.6	25.20
	21	90.7	13.18	108.5	15.38	125.8	17.71	134.4	19.00	143.0	20.16	160.3	22.75	178.6	25.46
	23	90.7	13.44	108.5	15.64	125.8	17.97	134.4	19.26	143.0	20.55	160.3	23.14	178.6	25.98
	25	90.7	13.57	108.5	15.90	125.8	18.35	134.4	19.65	143.0	21.20	160.3	24.30	178.6	27.79
	27	90.7	13.83	108.5	16.41	125.8	19.39	134.4	20.94	143.0	22.49	160.3	25.98	178.6	29.60
	29	90.7	14.61	108.5	17.45	125.8	20.55	134.4	22.23	143.0	23.91	160.3	27.53	178.6	31.41
	31	90.7	15.38	108.5	18.48	125.8	21.84	134.4	23.52	143.0	25.46	160.3	29.34	178.6	33.48
	33	90.7	16.29	108.5	19.52	125.8	23.14	134.4	24.95	143.0	27.01	160.3	31.15	178.6	35.67
	35	90.7	17.19	108.5	20.68	125.8	24.43	134.4	26.50	143.0	28.56	160.3	32.96	178.6	37.87
	37	90.7	18.22	108.5	21.84	125.8	25.85	134.4	28.05	143.0	30.24	160.3	35.16	178.6	40.20
	39	90.7	19.44	108.5	23.41	125.8	27.70	134.4	30.19	143.0	32.45	160.3	37.45	178.6	43.42
	41	88.4	21.02	105.7	25.35	122.5	30.29	131.0	32.70	139.4	35.16	156.2	41.05	174.0	47.15
	43	86.2	22.84	103.1	27.57	119.5	32.95	127.7	35.60	135.9	38.28	152.4	44.76	169.7	51.43
46	80.8	25.59	96.6	30.92	112.0	36.97	119.7	39.98	127.4	42.98	142.8	50.36	159.0	57.90	
48	71.5	22.30	85.5	26.97	99.1	32.24	105.9	34.90	112.7	37.51	126.3	44.01	140.7	50.62	

**Note**

1. TC: Total Capacity(kW), PI : Power Input(kW, Comp. + Outdoor fan motor)
2. Capacity tables show the average value of conditions which may occur.

# 7. Capacity Tables

## 7.1.1 SLC Mode

### ◆ ARUM080LTE5

Cooling Capacity (8HP)

Combination (%)	Outdoor air temp. (DB, °C)	Indoor air temp. (DB/WB, °C)													
		20		23		26		27		28		30		32	
		14	16	18	19	20	22	24	TC	PI	TC	PI	TC	PI	
130	10	3.2	0.30	4.3	0.38	5.7	0.46	8.1	0.56	10.7	0.70	15.4	0.93	20.4	1.24
	12	3.2	0.31	4.3	0.38	5.7	0.46	8.1	0.57	10.7	0.71	15.4	0.94	20.4	1.25
	14	3.2	0.31	4.3	0.39	5.7	0.47	8.1	0.57	10.7	0.71	15.4	0.95	20.4	1.26
	16	3.2	0.31	4.3	0.39	5.7	0.47	8.1	0.58	10.7	0.72	15.4	0.96	20.4	1.27
	18	3.2	0.31	4.3	0.39	5.7	0.48	8.1	0.58	10.7	0.73	15.4	0.97	20.4	1.29
	20	3.2	0.32	4.3	0.40	5.7	0.48	8.1	0.59	10.7	0.74	15.4	0.98	20.4	1.30
	21	3.2	0.32	4.4	0.41	7.1	0.60	9.4	0.70	11.9	0.90	16.3	1.23	21.0	1.46
	23	5.5	0.57	7.6	0.75	9.9	0.85	12.3	0.95	14.4	1.36	18.4	1.76	22.3	2.07
	25	8.1	0.90	9.8	1.12	12.6	1.28	15.4	1.51	17.0	1.96	20.4	2.56	23.6	3.01
	27	10.6	1.44	12.5	1.70	15.4	1.93	18.2	2.31	19.5	2.93	22.4	3.69	24.9	4.16
	29	13.0	2.00	15.3	2.34	18.2	2.83	21.2	3.34	22.0	3.98	24.5	4.77	26.2	5.31
	31	15.8	2.61	18.4	3.22	21.4	3.91	23.9	4.56	24.5	5.20	25.8	6.54	27.6	6.63
	33	18.6	3.22	21.8	4.20	24.4	5.03	25.8	6.53	26.4	6.49	27.2	8.54	29.0	6.64
	35	22.2	4.35	25.4	5.27	26.2	6.40	26.7	6.43	27.1	6.47	27.9	6.52	28.7	6.55
	37	22.2	4.64	25.1	5.53	25.9	6.31	26.2	6.34	26.7	6.38	27.4	6.44	28.2	6.46
	39	22.2	4.94	24.6	5.82	25.4	6.23	25.9	6.26	26.2	6.30	27.1	6.35	27.9	6.38
41	21.6	5.24	23.6	6.11	24.4	6.14	24.8	6.17	25.2	6.21	26.0	6.27	26.7	6.29	
43	21.1	5.52	22.6	6.03	23.4	6.06	23.8	6.09	24.2	6.12	25.0	6.18	25.7	6.20	
46	19.8	5.91	20.6	5.90	21.4	5.93	21.7	5.96	22.2	6.00	22.9	6.05	23.5	6.07	
48	17.5	5.75	17.9	5.77	18.6	5.78	18.9	5.79	19.3	5.84	19.9	5.88	20.5	5.90	
120	10	2.9	0.28	4.0	0.35	5.3	0.43	7.5	0.52	9.8	0.65	14.2	0.87	18.8	1.16
	12	2.9	0.29	4.0	0.36	5.3	0.43	7.5	0.53	9.8	0.66	14.2	0.88	18.8	1.17
	14	2.9	0.29	4.0	0.36	5.3	0.44	7.5	0.53	9.8	0.67	14.2	0.89	18.8	1.18
	16	2.9	0.29	4.0	0.36	5.3	0.44	7.5	0.54	9.8	0.68	14.2	0.90	18.8	1.19
	18	2.9	0.29	4.0	0.37	5.3	0.45	7.5	0.55	9.8	0.68	14.2	0.91	18.8	1.20
	20	2.9	0.30	4.0	0.37	5.3	0.45	7.5	0.55	9.8	0.69	14.2	0.92	18.8	1.22
	21	2.9	0.30	4.0	0.38	6.7	0.58	8.7	0.66	11.1	0.85	15.2	1.15	19.5	1.37
	23	5.0	0.53	7.2	0.71	9.5	0.82	11.4	0.89	13.8	1.27	17.2	1.65	20.8	1.94
	25	7.9	0.85	10.2	1.07	12.5	1.19	14.2	1.41	16.5	1.83	19.4	2.39	22.2	2.82
	27	10.9	1.34	13.8	1.59	15.5	1.79	16.8	2.14	19.2	2.72	21.7	3.43	23.5	3.92
	29	14.0	1.85	16.6	2.14	18.4	2.63	19.5	3.10	22.0	3.69	23.9	4.43	24.9	4.98
	31	17.0	2.35	20.0	2.83	21.4	3.49	22.5	4.10	24.8	4.68	25.5	5.63	26.3	5.73
	33	19.7	2.89	23.6	3.70	25.0	4.49	25.4	5.21	25.8	6.13	26.5	6.20	27.4	6.25
	35	20.1	3.87	23.9	5.01	25.3	5.54	25.6	6.60	26.1	6.63	26.8	6.65	27.5	6.71
	37	20.1	4.16	23.9	5.29	24.9	5.91	25.3	6.46	25.6	6.49	26.4	6.51	27.1	6.56
	39	20.1	4.48	23.8	5.59	24.5	6.27	24.8	6.33	25.2	6.36	26.0	6.38	26.7	6.43
41	19.6	4.80	22.7	5.89	23.5	6.14	23.8	6.20	24.2	6.23	24.9	6.25	25.6	6.29	
43	19.1	5.12	21.8	5.80	22.6	6.00	22.9	6.06	23.2	6.09	23.9	6.11	24.6	6.16	
46	17.9	5.51	19.9	5.67	20.6	5.82	20.9	5.86	21.2	5.89	21.9	5.91	22.5	5.96	
48	15.8	5.39	17.3	5.56	17.9	5.70	18.2	5.74	18.4	5.76	19.0	5.78	19.6	5.80	
110	10	2.7	0.27	3.6	0.33	4.8	0.40	6.8	0.49	9.0	0.62	13.0	0.82	17.2	1.09
	12	2.7	0.27	3.6	0.34	4.8	0.41	6.8	0.50	9.0	0.62	13.0	0.83	17.2	1.10
	14	2.7	0.27	3.6	0.34	4.8	0.41	6.8	0.50	9.0	0.63	13.0	0.84	17.2	1.11
	16	2.7	0.27	3.6	0.34	4.8	0.42	6.8	0.51	9.0	0.63	13.0	0.85	17.2	1.12
	18	2.7	0.28	3.6	0.35	4.8	0.42	6.8	0.51	9.0	0.64	13.0	0.85	17.2	1.13
	20	2.7	0.28	3.6	0.35	4.8	0.42	6.8	0.52	9.0	0.65	13.0	0.86	17.2	1.14
	21	2.7	0.28	3.6	0.36	6.1	0.53	8.0	0.62	10.0	0.80	14.0	1.09	18.1	1.29
	23	4.8	0.50	6.1	0.67	8.5	0.75	10.5	0.84	12.7	1.20	15.9	1.55	19.7	1.82
	25	6.9	0.79	8.5	1.00	10.9	1.12	12.9	1.32	15.1	1.72	17.8	2.25	21.2	2.65
	27	9.0	1.26	10.9	1.49	13.4	1.68	15.4	2.01	17.6	2.55	19.8	3.22	22.9	3.69
	29	11.1	1.74	13.4	2.01	15.8	2.47	17.9	2.91	20.1	3.47	21.8	4.08	24.2	4.52
	31	13.4	2.21	16.1	2.66	18.6	3.28	20.4	3.86	22.6	4.40	23.8	4.72	25.1	5.08
	33	15.6	2.72	18.6	3.47	21.1	4.22	23.0	4.71	24.4	5.29	25.2	5.44	25.8	5.44
	35	18.0	3.43	21.4	4.41	24.0	5.03	24.6	5.38	25.0	5.72	25.6	5.77	26.3	5.80
	37	18.0	3.63	21.4	4.68	24.0	5.31	24.3	5.70	24.6	6.03	25.2	6.05	25.9	6.07
	39	18.0	3.92	21.4	4.97	23.5	5.60	23.9	6.10	24.2	6.33	24.8	6.34	25.5	6.34
41	17.5	4.20	20.9	5.26	22.5	5.90	22.9	6.60	23.2	6.60	23.8	6.65	24.4	6.71	
43	17.1	4.41	20.4	5.49	21.6	6.26	21.9	6.33	22.2	6.32	22.9	6.35	23.4	6.37	
46	16.0	4.30	19.1	5.30	19.7	5.94	20.0	5.94	20.3	5.99	20.9	6.03	21.4	6.04	
48	14.2	4.18	16.6	5.10	17.1	5.65	17.4	5.69	17.6	5.72	18.2	5.73	18.7	5.76	

# 7. Capacity Tables

Cooling Capacity (8HP)

Combination (%)	Outdoor air temp. (DB, °C)	Indoor air temp. (DB/WB, °C)													
		20		23		26		27		28		30		32	
		14		16		18		19		20		22		24	
		TC	PI	TC	PI	TC	PI	TC	PI	TC	PI	TC	PI	TC	PI
100	10	2.4	0.24	3.3	0.30	4.4	0.37	6.3	0.45	8.3	0.56	11.9	0.75	15.8	1.00
	12	2.4	0.25	3.3	0.31	4.4	0.37	6.3	0.46	8.3	0.57	11.9	0.76	15.8	1.01
	14	2.4	0.25	3.3	0.31	4.4	0.38	6.3	0.46	8.3	0.58	11.9	0.77	15.8	1.02
	16	2.4	0.25	3.3	0.31	4.4	0.38	6.3	0.47	8.3	0.58	11.9	0.78	15.8	1.03
	18	2.4	0.25	3.3	0.32	4.4	0.39	6.3	0.47	8.3	0.59	11.9	0.78	15.8	1.04
	20	2.4	0.26	3.3	0.32	4.4	0.39	6.3	0.48	8.3	0.59	11.9	0.79	15.8	1.05
	21	2.4	0.26	3.3	0.33	5.5	0.49	7.4	0.57	9.4	0.73	12.8	1.00	16.6	1.18
	23	4.2	0.46	5.8	0.61	7.7	0.69	9.7	0.77	11.8	1.10	14.7	1.42	18.2	1.67
	25	6.0	0.73	7.9	0.92	9.9	1.03	12.1	1.21	14.1	1.58	16.6	2.06	19.8	2.43
	27	7.9	1.15	9.9	1.37	12.1	1.54	14.4	1.85	16.4	2.34	18.5	2.95	21.4	3.38
	29	9.7	1.60	11.9	1.85	14.4	2.27	16.7	2.67	18.8	3.18	20.4	3.82	23.0	4.15
	31	11.5	2.02	14.0	2.44	16.6	3.01	19.0	3.54	21.1	4.03	22.3	4.41	24.8	4.71
	33	13.3	2.50	16.0	3.19	18.8	3.87	21.4	4.49	23.5	4.90	24.2	4.99	24.8	5.10
	35	15.1	3.01	18.0	3.84	21.0	4.77	22.4	5.28	23.5	5.31	24.2	5.33	24.8	5.38
	37	15.1	3.22	18.0	4.12	21.0	5.05	22.4	5.53	23.1	5.56	23.8	5.58	24.3	5.63
	39	15.1	3.45	18.0	4.42	21.0	5.35	22.4	5.80	22.7	5.83	23.4	5.85	23.9	5.90
	41	14.9	3.68	17.7	4.73	20.6	5.65	21.5	6.07	22.0	6.10	22.5	6.12	23.2	6.17
43	14.4	3.90	17.1	5.01	19.9	5.92	20.6	6.30	20.8	6.33	21.5	6.35	22.1	6.41	
46	13.5	4.19	16.0	5.40	18.7	6.28	18.8	6.60	19.0	6.62	19.6	6.64	20.2	6.70	
48	11.9	3.62	14.2	4.67	16.1	5.37	16.4	5.60	16.5	5.62	17.1	5.63	17.5	5.68	
90	10	2.2	0.22	3.0	0.28	4.0	0.35	5.5	0.40	7.4	0.52	10.7	0.68	14.2	0.90
	12	2.2	0.23	3.0	0.28	4.0	0.36	5.5	0.41	7.4	0.52	10.7	0.69	14.2	0.91
	14	2.2	0.23	3.0	0.29	4.0	0.36	5.5	0.41	7.4	0.53	10.7	0.70	14.2	0.92
	16	2.2	0.23	3.0	0.29	4.0	0.36	5.5	0.41	7.4	0.54	10.7	0.71	14.2	0.93
	18	2.2	0.23	3.0	0.29	4.0	0.37	5.5	0.42	7.4	0.54	10.7	0.71	14.2	0.93
	20	2.2	0.24	3.0	0.29	4.0	0.37	5.5	0.42	7.4	0.55	10.7	0.72	14.2	0.94
	21	2.2	0.24	3.0	0.30	5.0	0.47	6.5	0.50	8.4	0.66	11.6	0.79	14.9	1.04
	23	3.0	0.37	4.4	0.51	7.0	0.66	8.5	0.72	10.3	0.96	13.3	1.17	16.5	1.43
	25	4.7	0.62	6.4	0.82	9.0	0.98	10.4	1.14	12.1	1.41	15.0	1.78	18.0	2.06
	27	6.5	0.92	8.4	1.17	11.0	1.52	12.4	1.69	14.0	2.05	16.8	2.39	19.5	2.70
	29	8.3	1.24	10.3	1.60	13.0	2.12	14.3	2.34	15.9	2.70	18.5	3.07	21.0	3.58
	31	10.0	1.55	12.3	2.06	14.9	2.65	16.3	2.99	17.7	3.37	20.2	3.57	22.5	4.16
	33	11.8	1.99	14.3	2.54	16.9	3.21	18.2	3.54	19.6	3.92	21.9	4.23	24.1	4.64
	35	13.6	2.47	16.2	3.12	18.9	3.86	20.2	4.25	21.4	4.63	23.7	4.96	24.1	5.08
	37	13.6	2.62	16.2	3.32	18.9	4.11	20.2	4.52	21.4	4.88	23.3	5.19	23.7	5.30
	39	13.6	2.77	16.2	3.53	18.9	4.35	20.2	4.81	21.4	5.13	22.9	5.47	23.3	5.53
	41	13.3	3.10	15.8	3.91	18.4	4.78	19.6	5.26	20.9	5.54	21.9	5.76	22.3	5.90
43	12.9	3.35	15.4	4.23	17.9	5.22	19.2	5.66	20.4	5.94	21.0	6.16	21.4	6.25	
46	12.1	3.77	14.5	4.82	16.8	5.95	18.0	6.42	18.5	6.60	19.2	6.64	19.6	6.70	
48	10.7	3.29	12.8	4.21	14.9	5.20	15.9	5.60	16.1	5.62	16.7	5.63	17.0	5.68	
80	10	1.9	0.20	2.6	0.25	3.4	0.31	4.8	0.36	6.4	0.46	9.2	0.61	12.2	0.79
	12	1.9	0.20	2.6	0.25	3.4	0.31	4.8	0.36	6.4	0.46	9.2	0.61	12.2	0.80
	14	1.9	0.20	2.6	0.25	3.4	0.32	4.8	0.37	6.4	0.47	9.2	0.62	12.2	0.81
	16	1.9	0.20	2.6	0.26	3.4	0.32	4.8	0.37	6.4	0.47	9.2	0.62	12.2	0.82
	18	1.9	0.21	2.6	0.26	3.4	0.32	4.8	0.37	6.4	0.48	9.2	0.63	12.2	0.83
	20	1.9	0.21	2.6	0.26	3.4	0.33	4.8	0.38	6.4	0.48	9.2	0.64	12.2	0.83
	21	1.9	0.21	2.6	0.27	4.3	0.41	5.8	0.45	7.2	0.58	10.0	0.70	12.9	0.92
	23	3.3	0.39	4.3	0.46	6.1	0.58	7.6	0.65	8.9	0.85	11.6	1.04	14.4	1.26
	25	4.8	0.56	5.9	0.74	7.8	0.87	9.5	1.02	10.6	1.24	13.2	1.57	15.9	1.83
	27	6.2	0.82	7.6	1.05	9.6	1.34	11.4	1.52	12.3	1.81	14.9	2.11	17.5	2.39
	29	7.7	1.07	9.3	1.44	11.4	1.87	13.2	2.11	14.0	2.39	16.5	2.71	19.0	3.16
	31	9.2	1.31	11.0	1.82	13.1	2.34	15.1	2.69	16.0	2.90	18.1	3.13	20.5	3.64
	33	10.6	1.72	12.7	2.24	14.9	2.75	17.0	3.19	18.0	3.33	19.8	3.70	22.0	4.09
	35	12.1	2.25	14.4	2.82	16.7	3.47	17.9	3.81	19.1	4.17	21.4	4.73	23.5	4.92
	37	12.1	2.38	14.4	3.00	16.7	3.68	17.9	4.05	19.1	4.43	21.4	4.99	23.1	5.17
	39	12.1	2.52	14.4	3.17	16.7	3.93	17.9	4.35	19.1	4.76	21.4	5.27	22.7	5.46
	41	11.8	2.79	14.0	3.52	16.3	4.32	17.5	4.77	18.6	5.23	20.9	5.65	21.8	5.78
43	11.5	3.07	13.7	3.84	15.9	4.71	17.0	5.20	18.2	5.71	20.4	6.03	20.9	6.18	
46	10.8	3.41	12.8	4.32	14.9	5.31	16.0	5.78	17.0	6.45	18.6	6.64	19.1	6.70	
48	9.5	2.98	11.3	3.78	13.2	4.64	14.1	5.05	15.1	5.62	16.2	5.63	16.6	5.68	

## 7. Capacity Tables

Cooling Capacity (8HP)

Combination (%)	Outdoor air temp. (DB, °C)	Indoor air temp. (DB/WB, °C)													
		20		23		26		27		28		30		32	
		14		16		18		19		20		22		24	
		TC	PI	TC	PI	TC	PI	TC	PI	TC	PI	TC	PI	TC	PI
70	10	1.6	0.18	2.2	0.22	3.0	0.27	4.2	0.32	5.5	0.41	8.0	0.54	10.6	0.70
	12	1.6	0.18	2.2	0.22	3.0	0.28	4.2	0.32	5.5	0.41	8.0	0.54	10.6	0.71
	14	1.6	0.18	2.2	0.22	3.0	0.28	4.2	0.32	5.5	0.41	8.0	0.55	10.6	0.72
	16	1.6	0.18	2.2	0.23	3.0	0.28	4.2	0.33	5.5	0.42	8.0	0.55	10.6	0.72
	18	1.6	0.18	2.2	0.23	3.0	0.29	4.2	0.33	5.5	0.42	8.0	0.56	10.6	0.73
	20	1.6	0.18	2.2	0.23	3.0	0.29	4.2	0.34	5.5	0.43	8.0	0.56	10.6	0.74
	21	1.6	0.19	2.6	0.27	3.9	0.38	5.2	0.42	6.4	0.51	8.8	0.62	11.4	0.81
	23	2.3	0.28	4.0	0.44	5.4	0.56	7.0	0.60	8.1	0.75	10.4	0.92	13.0	1.12
	25	3.7	0.46	5.5	0.65	6.9	0.76	8.8	0.95	9.8	1.10	12.1	1.39	14.5	1.61
	27	5.1	0.67	6.9	0.93	8.5	1.13	10.6	1.42	11.6	1.60	13.7	1.87	16.1	2.11
	29	6.5	0.85	8.3	1.23	10.0	1.53	12.4	1.93	13.3	2.11	15.4	2.40	17.7	2.79
	31	7.8	1.05	9.7	1.53	11.5	1.92	14.2	2.42	15.0	2.56	17.1	2.76	19.3	3.21
	33	9.2	1.41	11.2	1.86	13.1	2.23	15.7	2.81	16.7	2.94	18.7	3.27	20.8	3.62
	35	10.6	1.93	12.6	2.40	14.6	2.90	15.7	3.18	16.7	3.47	18.7	4.08	20.8	4.48
	37	10.6	2.05	12.6	2.54	14.6	3.08	15.7	3.38	16.7	3.69	18.7	4.34	20.8	4.72
	39	10.6	2.17	12.6	2.71	14.6	3.30	15.7	3.63	16.7	3.99	18.7	4.65	20.8	5.09
	41	10.3	2.40	12.3	2.97	14.3	3.62	15.3	3.98	16.3	4.33	18.2	5.11	20.3	5.49
43	10.0	2.61	12.0	3.23	13.9	3.95	14.9	4.35	15.9	4.73	17.8	5.58	19.8	5.94	
46	9.4	2.91	11.3	3.64	13.0	4.45	14.0	4.84	14.9	5.33	16.7	6.29	18.5	6.62	
48	8.3	2.54	10.0	3.18	11.5	3.89	12.4	4.23	13.2	4.67	14.7	5.51	16.4	5.68	
60	10	1.4	0.16	1.9	0.19	2.6	0.24	3.6	0.28	4.8	0.36	6.9	0.48	9.2	0.62
	12	1.4	0.16	1.9	0.20	2.6	0.25	3.6	0.29	4.8	0.36	6.9	0.48	9.2	0.63
	14	1.4	0.16	1.9	0.20	2.6	0.25	3.6	0.29	4.8	0.37	6.9	0.49	9.2	0.64
	16	1.4	0.16	1.9	0.20	2.6	0.25	3.6	0.29	4.8	0.37	6.9	0.49	9.2	0.64
	18	1.4	0.16	1.9	0.20	2.6	0.25	3.6	0.30	4.8	0.38	6.9	0.50	9.2	0.65
	20	1.4	0.16	1.9	0.20	2.6	0.26	3.6	0.30	4.8	0.38	6.9	0.50	9.2	0.66
	21	1.4	0.16	1.9	0.21	3.2	0.33	4.3	0.36	5.5	0.46	7.5	0.55	9.7	0.72
	23	1.4	0.18	3.2	0.38	4.6	0.49	5.9	0.53	6.9	0.67	8.7	0.82	10.9	0.99
	25	2.7	0.35	4.5	0.58	5.9	0.68	7.6	0.90	8.4	0.98	10.1	1.21	12.1	1.43
	27	4.0	0.51	5.7	0.83	7.2	1.00	9.2	1.25	9.8	1.40	11.4	1.60	13.2	1.85
	29	5.2	0.66	7.0	1.06	8.5	1.34	10.9	1.65	11.2	1.79	12.6	2.01	14.4	2.36
	31	6.5	0.83	8.3	1.27	9.9	1.63	12.2	1.98	12.6	2.07	14.2	2.22	15.5	2.72
	33	7.8	1.16	9.5	1.54	11.2	1.83	13.1	2.22	14.1	2.37	15.3	2.63	16.7	3.10
	35	9.0	1.63	10.8	2.00	12.6	2.39	13.4	2.61	14.3	2.83	16.1	3.31	17.8	3.81
	37	9.0	1.72	10.8	2.11	12.6	2.54	13.4	2.77	14.3	3.00	16.1	3.51	17.8	4.06
	39	9.0	1.83	10.8	2.25	12.6	2.74	13.4	2.97	14.3	3.23	16.1	3.76	17.8	4.35
	41	8.8	1.99	10.5	2.46	12.2	2.97	13.1	3.25	14.0	3.51	15.7	4.13	17.4	4.72
43	8.6	2.16	10.3	2.68	11.9	3.24	12.8	3.54	13.6	3.82	15.3	4.51	17.0	5.16	
46	8.1	2.42	9.6	3.00	11.2	3.64	12.0	3.98	12.8	4.30	14.3	5.08	15.9	5.88	
48	7.1	2.11	8.5	2.62	9.9	3.18	10.6	3.47	11.3	3.76	12.7	4.44	14.1	5.14	
50	10	1.3	0.14	1.8	0.17	2.5	0.22	3.3	0.27	4.4	0.32	6.3	0.42	8.4	0.55
	12	1.3	0.14	1.8	0.17	2.5	0.22	3.3	0.27	4.4	0.32	6.3	0.43	8.4	0.56
	14	1.3	0.14	1.8	0.18	2.5	0.22	3.3	0.27	4.4	0.33	6.3	0.43	8.4	0.56
	16	1.3	0.14	1.8	0.18	2.5	0.22	3.3	0.27	4.4	0.33	6.3	0.44	8.4	0.57
	18	1.3	0.14	1.8	0.18	2.5	0.23	3.3	0.28	4.4	0.33	6.3	0.44	8.4	0.57
	20	1.3	0.15	1.8	0.18	2.5	0.23	3.3	0.28	4.4	0.34	6.3	0.45	8.4	0.58
	21	1.3	0.15	1.8	0.19	3.1	0.29	3.9	0.34	5.0	0.40	6.8	0.49	8.8	0.64
	23	1.3	0.16	2.8	0.32	4.3	0.44	5.5	0.53	6.3	0.60	7.9	0.73	9.7	0.88
	25	2.3	0.28	3.8	0.47	5.5	0.62	7.3	0.85	7.8	0.87	8.9	1.02	10.6	1.24
	27	3.4	0.41	4.9	0.66	6.8	0.86	8.5	1.13	9.0	1.17	10.0	1.34	11.6	1.58
	29	4.4	0.53	5.9	0.86	7.9	1.10	9.6	1.41	10.3	1.51	11.0	1.66	12.5	1.99
	31	5.5	0.68	7.0	1.02	9.0	1.34	10.4	1.57	11.0	1.67	12.0	1.79	13.4	2.19
	33	6.5	0.95	8.0	1.23	10.0	1.51	10.8	1.72	11.5	1.84	13.0	2.12	14.3	2.46
	35	7.6	1.36	9.0	1.63	10.5	1.93	11.2	2.09	11.9	2.26	13.4	2.60	14.9	2.99
	37	7.6	1.44	9.0	1.73	10.5	2.04	11.2	2.21	11.9	2.39	13.4	2.78	14.9	3.17
	39	7.6	1.54	9.0	1.85	10.5	2.19	11.2	2.38	11.9	2.56	13.4	2.96	14.9	3.43
	41	7.4	1.66	8.8	2.00	10.2	2.39	10.9	2.58	11.6	2.78	13.0	3.24	14.5	3.72
43	7.2	1.80	8.6	2.18	10.0	2.60	10.6	2.81	11.3	3.02	12.7	3.53	14.1	4.06	
46	6.7	2.02	8.1	2.44	9.3	2.92	10.0	3.16	10.6	3.39	11.9	3.98	13.3	4.57	
48	6.0	1.76	7.1	2.13	8.3	2.55	8.8	2.76	9.4	2.96	10.5	3.48	11.7	4.00	

**Note**

1. TC: Total Capacity(kW), PI : Power Input(kW, Comp. + Outdoor fan motor)
2. Capacity tables show the average value of conditions which may occur.

# 7. Capacity Tables

## ◆ ARUM100LTE5

Cooling Capacity (10HP)

Combination (%)	Outdoor air temp. (DB, °C)	Indoor air temp. (DB/WB, °C)													
		20		23		26		27		28		30		32	
		14	16	16	18	18	19	19	20	20	22	22	24	24	
		TC	PI	TC	PI	TC	PI	TC	PI	TC	PI	TC	PI	TC	PI
130	10	3.9	0.39	5.4	0.49	7.2	0.59	10.1	0.72	13.3	0.91	19.2	1.21	25.5	1.60
	12	3.9	0.39	5.4	0.49	7.2	0.60	10.1	0.73	13.3	0.91	19.2	1.22	25.5	1.62
	14	3.9	0.40	5.4	0.50	7.2	0.61	10.1	0.74	13.3	0.92	19.2	1.23	25.5	1.63
	16	3.9	0.40	5.4	0.50	7.2	0.61	10.1	0.75	13.3	0.93	19.2	1.25	25.5	1.65
	18	3.9	0.41	5.4	0.51	7.2	0.62	10.1	0.75	13.3	0.94	19.2	1.26	25.5	1.67
	20	3.9	0.41	5.4	0.51	7.2	0.62	10.1	0.76	13.3	0.95	19.2	1.27	25.5	1.68
	21	3.9	0.42	5.5	0.53	8.9	0.78	11.8	0.91	14.9	1.17	20.4	1.60	26.3	1.89
	23	6.8	0.74	9.5	0.97	12.3	1.11	15.4	1.23	18.0	1.76	23.0	2.28	27.9	2.68
	25	10.1	1.17	12.3	1.45	15.8	1.65	19.2	1.95	21.2	2.53	25.5	3.31	29.5	3.90
	27	13.2	1.86	15.7	2.20	19.3	2.50	22.8	2.98	24.3	3.79	28.0	4.78	31.2	5.38
	29	16.3	2.59	19.1	3.03	22.7	3.66	26.5	4.32	27.5	5.14	30.6	6.17	32.8	6.87
	31	19.8	3.38	22.9	4.17	26.7	5.06	29.9	5.90	30.6	6.73	32.3	8.46	34.5	8.58
	33	23.3	4.16	27.2	5.44	30.5	6.51	32.3	8.45	33.0	8.39	34.0	8.46	36.3	8.58
	35	27.7	5.62	31.8	6.82	32.8	8.27	33.4	8.31	33.9	8.36	34.8	8.44	35.8	8.47
	37	27.7	6.00	31.3	7.15	32.4	8.16	32.8	8.20	33.4	8.25	34.3	8.33	35.3	8.36
	39	27.7	6.39	30.8	7.53	31.8	8.05	32.4	8.09	32.8	8.14	33.8	8.22	34.8	8.25
41	27.0	6.78	29.5	7.91	30.5	7.94	31.0	7.98	31.6	8.03	32.5	8.10	33.4	8.14	
43	26.4	7.15	28.3	7.80	29.3	7.84	29.7	7.88	30.3	7.92	31.2	7.99	32.1	8.02	
46	24.7	7.65	25.8	7.63	26.7	7.67	27.1	7.71	27.7	7.76	28.6	7.83	29.4	7.86	
48	21.8	7.44	22.4	7.46	23.2	7.47	23.6	7.49	24.1	7.56	24.9	7.61	25.6	7.64	
120	10	3.6	0.37	5.0	0.46	6.6	0.56	9.3	0.68	12.3	0.85	17.7	1.13	23.5	1.50
	12	3.6	0.37	5.0	0.46	6.6	0.56	9.3	0.68	12.3	0.86	17.7	1.14	23.5	1.51
	14	3.6	0.37	5.0	0.47	6.6	0.57	9.3	0.69	12.3	0.86	17.7	1.15	23.5	1.53
	16	3.6	0.38	5.0	0.47	6.6	0.57	9.3	0.70	12.3	0.87	17.7	1.16	23.5	1.54
	18	3.6	0.38	5.0	0.48	6.6	0.58	9.3	0.71	12.3	0.88	17.7	1.18	23.5	1.56
	20	3.6	0.38	5.0	0.48	6.6	0.58	9.3	0.71	12.3	0.89	17.7	1.19	23.5	1.57
	21	3.6	0.39	5.0	0.50	8.4	0.74	10.9	0.85	13.9	1.09	19.0	1.49	24.3	1.77
	23	6.3	0.69	9.1	0.92	11.9	1.06	14.2	1.15	17.2	1.65	21.5	2.13	26.0	2.51
	25	9.8	1.09	12.7	1.38	15.6	1.55	17.7	1.82	20.6	2.37	24.3	3.10	27.7	3.64
	27	13.7	1.73	17.3	2.06	19.3	2.32	21.0	2.77	24.0	3.51	27.1	4.43	29.4	5.07
	29	17.5	2.40	20.8	2.77	23.0	3.40	24.4	4.00	27.5	4.77	29.8	5.73	31.1	6.44
	31	21.2	3.04	25.0	3.66	26.8	4.51	28.1	5.31	31.0	6.05	31.8	7.28	32.9	7.42
	33	24.6	3.74	29.5	4.78	31.3	5.81	31.7	6.74	32.3	7.92	33.2	8.01	34.2	8.08
	35	25.1	5.00	29.8	6.48	31.6	7.17	32.1	8.54	32.6	8.58	33.5	8.61	34.4	8.67
	37	25.1	5.38	29.8	6.84	31.2	7.64	31.6	8.36	32.1	8.40	32.9	8.42	33.8	8.49
	39	25.1	5.79	29.7	7.23	30.6	8.11	31.1	8.19	31.5	8.23	32.5	8.25	33.4	8.32
41	24.5	6.20	28.4	7.62	29.4	7.95	29.8	8.01	30.2	8.05	31.1	8.08	32.0	8.14	
43	23.8	6.62	27.2	7.51	28.2	7.77	28.6	7.84	29.0	7.88	29.9	7.91	30.7	7.97	
46	22.3	7.12	24.8	7.33	25.7	7.52	26.1	7.59	26.5	7.62	27.3	7.65	28.1	7.71	
48	19.8	6.98	21.6	7.20	22.4	7.38	22.7	7.42	23.1	7.45	23.8	7.48	24.5	7.50	
110	10	3.3	0.34	4.5	0.43	6.1	0.52	8.5	0.64	11.3	0.80	16.2	1.06	21.5	1.40
	12	3.3	0.35	4.5	0.43	6.1	0.53	8.5	0.64	11.3	0.80	16.2	1.07	21.5	1.42
	14	3.3	0.35	4.5	0.44	6.1	0.53	8.5	0.65	11.3	0.81	16.2	1.08	21.5	1.43
	16	3.3	0.35	4.5	0.44	6.1	0.54	8.5	0.66	11.3	0.82	16.2	1.09	21.5	1.45
	18	3.3	0.36	4.5	0.45	6.1	0.54	8.5	0.66	11.3	0.83	16.2	1.11	21.5	1.46
	20	3.3	0.36	4.5	0.45	6.1	0.55	8.5	0.67	11.3	0.84	16.2	1.12	21.5	1.48
	21	3.3	0.37	4.5	0.47	7.6	0.69	10.0	0.80	12.5	1.03	17.5	1.40	22.6	1.66
	23	6.0	0.65	7.6	0.87	10.6	0.97	13.1	1.08	15.9	1.55	19.9	2.00	24.6	2.36
	25	8.6	1.03	10.6	1.30	13.7	1.45	16.2	1.71	18.9	2.23	22.2	2.91	26.5	3.42
	27	11.2	1.62	13.7	1.93	16.7	2.18	19.2	2.60	22.0	3.30	24.8	4.16	28.6	4.77
	29	13.8	2.25	16.7	2.60	19.8	3.20	22.3	3.76	25.1	4.49	27.3	5.28	30.2	5.85
	31	16.8	2.85	20.1	3.44	23.2	4.24	25.5	4.99	28.2	5.69	29.8	6.10	31.3	6.57
	33	19.4	3.52	23.2	4.49	26.3	5.46	28.7	6.10	30.5	6.84	31.5	7.03	32.3	7.04
	35	22.5	4.43	26.8	5.70	29.9	6.50	30.8	6.97	31.2	7.39	32.0	7.46	32.9	7.50
	37	22.5	4.70	26.8	6.05	29.9	6.86	30.4	7.38	30.7	7.80	31.6	7.83	32.3	7.85
	39	22.5	5.06	26.8	6.43	29.4	7.24	29.8	7.89	30.3	8.18	31.0	8.20	31.9	8.21
41	21.9	5.43	26.1	6.81	28.1	7.64	28.6	8.54	28.9	8.54	29.8	8.61	30.5	8.67	
43	21.4	5.70	25.5	7.10	27.0	8.10	27.4	8.19	27.8	8.17	28.6	8.22	29.3	8.24	
46	20.0	5.57	23.9	6.85	24.6	7.69	25.0	7.69	25.4	7.75	26.1	7.79	26.8	7.82	
48	17.7	5.41	20.7	6.60	21.4	7.31	21.8	7.36	22.0	7.40	22.7	7.42	23.3	7.45	

# 7. Capacity Tables

Cooling Capacity (10HP)

Combination (%)	Outdoor air temp. (DB, °C)	Indoor air temp. (DB/WB, °C)													
		20		23		26		27		28		30		32	
		14		16		18		19		20		22		24	
		TC	PI	TC	PI	TC	PI	TC	PI	TC	PI	TC	PI	TC	PI
100	10	3.1	0.32	4.2	0.39	5.6	0.48	7.8	0.58	10.3	0.73	14.9	0.97	19.7	1.29
	12	3.1	0.32	4.2	0.40	5.6	0.48	7.8	0.59	10.3	0.74	14.9	0.98	19.7	1.30
	14	3.1	0.32	4.2	0.40	5.6	0.49	7.8	0.60	10.3	0.75	14.9	0.99	19.7	1.32
	16	3.1	0.33	4.2	0.41	5.6	0.49	7.8	0.60	10.3	0.75	14.9	1.00	19.7	1.33
	18	3.1	0.33	4.2	0.41	5.6	0.50	7.8	0.61	10.3	0.76	14.9	1.01	19.7	1.34
	20	3.1	0.33	4.2	0.41	5.6	0.50	7.8	0.61	10.3	0.77	14.9	1.02	19.7	1.36
	21	3.1	0.34	4.2	0.43	6.9	0.63	9.2	0.73	11.8	0.94	16.1	1.29	20.7	1.53
	23	5.3	0.59	7.3	0.79	9.7	0.89	12.1	0.99	14.7	1.42	18.4	1.84	22.8	2.16
	25	7.6	0.94	9.8	1.19	12.4	1.33	15.1	1.57	17.6	2.04	20.8	2.67	24.8	3.14
	27	9.8	1.49	12.4	1.77	15.2	2.00	18.0	2.39	20.5	3.03	23.1	3.82	26.8	4.37
	29	12.1	2.07	14.9	2.39	17.9	2.93	20.9	3.45	23.5	4.12	25.5	4.94	28.8	5.37
	31	14.3	2.62	17.5	3.16	20.7	3.89	23.8	4.58	26.4	5.22	27.8	5.71	31.0	6.09
	33	16.6	3.23	20.0	4.12	23.5	5.01	26.7	5.81	29.3	6.34	30.3	6.45	31.0	6.59
	35	18.9	3.89	22.5	4.96	26.2	6.17	28.0	6.83	29.3	6.87	30.3	6.90	31.0	6.95
	37	18.9	4.16	22.5	5.32	26.2	6.53	28.0	7.16	28.9	7.19	29.7	7.22	30.4	7.29
	39	18.9	4.46	22.5	5.72	26.2	6.92	28.0	7.50	28.4	7.54	29.2	7.57	29.9	7.64
41	18.6	4.76	22.1	6.11	25.8	7.31	26.9	7.85	27.5	7.89	28.1	7.91	29.0	7.99	
43	18.0	5.04	21.4	6.48	24.9	7.66	25.8	8.16	26.1	8.18	26.9	8.21	27.6	8.29	
46	16.8	5.42	20.0	6.99	23.3	8.13	23.5	8.54	23.8	8.56	24.5	8.59	25.2	8.67	
48	14.9	4.68	17.7	6.05	20.1	6.95	20.4	7.24	20.7	7.27	21.3	7.28	21.9	7.34	
90	10	2.7	0.29	3.7	0.36	5.0	0.45	6.9	0.52	9.3	0.67	13.4	0.89	17.8	1.16
	12	2.7	0.29	3.7	0.37	5.0	0.46	6.9	0.53	9.3	0.68	13.4	0.90	17.8	1.17
	14	2.7	0.30	3.7	0.37	5.0	0.46	6.9	0.53	9.3	0.69	13.4	0.90	17.8	1.18
	16	2.7	0.30	3.7	0.37	5.0	0.47	6.9	0.54	9.3	0.69	13.4	0.91	17.8	1.20
	18	2.7	0.30	3.7	0.38	5.0	0.47	6.9	0.54	9.3	0.70	13.4	0.92	17.8	1.21
	20	2.7	0.31	3.7	0.38	5.0	0.48	6.9	0.55	9.3	0.71	13.4	0.93	17.8	1.22
	21	2.7	0.31	3.7	0.38	6.3	0.60	8.2	0.65	10.5	0.85	14.5	1.03	18.7	1.34
	23	3.7	0.48	5.5	0.66	8.8	0.86	10.6	0.93	12.8	1.25	16.6	1.52	20.6	1.85
	25	5.9	0.81	8.0	1.06	11.2	1.27	13.0	1.47	15.2	1.82	18.8	2.30	22.5	2.67
	27	8.1	1.18	10.4	1.51	13.7	1.96	15.5	2.19	17.5	2.65	20.9	3.09	24.4	3.49
	29	10.3	1.60	12.9	2.07	16.2	2.74	17.9	3.03	19.8	3.50	23.1	3.97	26.3	4.63
	31	12.6	2.00	15.4	2.66	18.7	3.43	20.3	3.86	22.2	4.36	25.3	4.62	28.2	5.38
	33	14.8	2.58	17.8	3.28	21.2	4.15	22.8	4.58	24.5	5.07	27.4	5.48	30.1	6.00
	35	17.0	3.19	20.3	4.04	23.6	4.99	25.2	5.50	26.8	5.98	29.6	6.42	30.1	6.57
	37	17.0	3.39	20.3	4.29	23.6	5.32	25.2	5.85	26.8	6.32	29.1	6.71	29.6	6.86
	39	17.0	3.59	20.3	4.57	23.6	5.63	25.2	6.22	26.8	6.64	28.6	7.07	29.1	7.16
41	16.6	4.01	19.8	5.06	23.0	6.18	24.6	6.80	26.1	7.17	27.4	7.46	27.9	7.63	
43	16.2	4.33	19.3	5.47	22.4	6.75	23.9	7.33	25.5	7.69	26.3	7.96	26.8	8.08	
46	15.1	4.88	18.1	6.23	21.0	7.69	22.4	8.31	23.1	8.54	24.0	8.59	24.5	8.67	
48	13.4	4.26	16.0	5.45	18.6	6.73	19.9	7.24	20.1	7.27	20.9	7.28	21.3	7.34	
80	10	2.4	0.26	3.2	0.32	4.3	0.40	6.0	0.46	8.0	0.59	11.5	0.78	15.2	1.03
	12	2.4	0.26	3.2	0.32	4.3	0.41	6.0	0.47	8.0	0.60	11.5	0.79	15.2	1.04
	14	2.4	0.26	3.2	0.33	4.3	0.41	6.0	0.47	8.0	0.61	11.5	0.80	15.2	1.05
	16	2.4	0.26	3.2	0.33	4.3	0.41	6.0	0.48	8.0	0.61	11.5	0.81	15.2	1.06
	18	2.4	0.27	3.2	0.33	4.3	0.42	6.0	0.48	8.0	0.62	11.5	0.82	15.2	1.07
	20	2.4	0.27	3.2	0.34	4.3	0.42	6.0	0.49	8.0	0.62	11.5	0.82	15.2	1.08
	21	2.4	0.27	3.2	0.35	5.4	0.53	7.2	0.58	9.0	0.75	12.5	0.91	16.2	1.19
	23	4.2	0.50	5.3	0.60	7.6	0.76	9.5	0.84	11.1	1.10	14.5	1.34	18.0	1.63
	25	6.0	0.73	7.4	0.95	9.8	1.12	11.9	1.33	13.3	1.61	16.5	2.03	19.9	2.36
	27	7.8	1.07	9.5	1.36	12.0	1.74	14.2	1.97	15.4	2.34	18.6	2.73	21.8	3.09
	29	9.6	1.38	11.7	1.87	14.2	2.42	16.5	2.72	17.5	3.09	20.6	3.51	23.7	4.09
	31	11.5	1.69	13.8	2.35	16.4	3.03	18.9	3.48	20.0	3.75	22.7	4.04	25.6	4.70
	33	13.3	2.23	15.9	2.89	18.6	3.56	21.2	4.12	22.4	4.31	24.7	4.79	27.5	5.30
	35	15.1	2.92	18.0	3.65	20.9	4.48	22.4	4.92	23.9	5.39	26.8	6.11	29.4	6.37
	37	15.1	3.08	18.0	3.88	20.9	4.75	22.4	5.23	23.9	5.73	26.8	6.45	28.9	6.69
	39	15.1	3.26	18.0	4.11	20.9	5.09	22.4	5.63	23.9	6.15	26.8	6.82	28.4	7.06
41	14.7	3.60	17.5	4.55	20.4	5.58	21.8	6.17	23.3	6.76	26.1	7.31	27.2	7.47	
43	14.3	3.97	17.1	4.97	19.9	6.09	21.3	6.72	22.7	7.39	25.5	7.81	26.1	8.00	
46	13.4	4.42	16.0	5.59	18.6	6.87	19.9	7.48	21.3	8.34	23.3	8.59	23.8	8.67	
48	11.9	3.86	14.2	4.89	16.5	6.00	17.6	6.54	18.8	7.27	20.2	7.28	20.7	7.34	



# 7. Capacity Tables

Cooling Capacity (10HP)

Combination (%)	Outdoor air temp. (DB, °C)	Indoor air temp. (DB/WB, °C)													
		20		23		26		27		28		30		32	
		14		16		18		19		20		22		24	
		TC	PI	TC	PI	TC	PI	TC	PI	TC	PI	TC	PI	TC	PI
70	10	2.0	0.23	2.8	0.28	3.7	0.36	5.3	0.41	6.9	0.52	10.0	0.69	13.2	0.91
	12	2.0	0.23	2.8	0.29	3.7	0.36	5.3	0.42	6.9	0.53	10.0	0.70	13.2	0.92
	14	2.0	0.23	2.8	0.29	3.7	0.36	5.3	0.42	6.9	0.54	10.0	0.71	13.2	0.93
	16	2.0	0.23	2.8	0.29	3.7	0.37	5.3	0.42	6.9	0.54	10.0	0.71	13.2	0.94
	18	2.0	0.24	2.8	0.29	3.7	0.37	5.3	0.43	6.9	0.55	10.0	0.72	13.2	0.94
	20	2.0	0.24	2.8	0.30	3.7	0.37	5.3	0.43	6.9	0.55	10.0	0.73	13.2	0.95
	21	2.0	0.24	3.3	0.35	4.8	0.49	6.5	0.54	8.0	0.66	11.0	0.80	14.2	1.05
	23	2.9	0.36	5.0	0.57	6.8	0.72	8.8	0.78	10.2	0.97	13.1	1.19	16.2	1.44
	25	4.6	0.59	6.8	0.84	8.7	0.99	11.0	1.23	12.3	1.42	15.1	1.79	18.2	2.09
	27	6.4	0.87	8.6	1.20	10.6	1.46	13.3	1.83	14.5	2.07	17.2	2.42	20.1	2.73
	29	8.1	1.10	10.4	1.59	12.5	1.98	15.5	2.49	16.6	2.73	19.3	3.10	22.1	3.61
	31	9.8	1.35	12.2	1.97	14.4	2.48	17.8	3.13	18.8	3.31	21.3	3.57	24.1	4.16
	33	11.5	1.82	14.0	2.40	16.4	2.89	19.6	3.64	20.9	3.81	23.4	4.24	26.0	4.68
	35	13.2	2.49	15.8	3.10	18.3	3.76	19.6	4.11	20.9	4.49	23.4	5.28	26.0	5.79
	37	13.2	2.65	15.8	3.29	18.3	3.99	19.6	4.37	20.9	4.77	23.4	5.62	26.0	6.11
	39	13.2	2.81	15.8	3.50	18.3	4.27	19.6	4.70	20.9	5.15	23.4	6.01	26.0	6.59
	41	12.9	3.11	15.4	3.84	17.8	4.68	19.1	5.15	20.4	5.60	22.8	6.61	25.3	7.10
43	12.5	3.38	15.0	4.18	17.4	5.11	18.6	5.62	19.9	6.12	22.2	7.22	24.7	7.68	
46	11.8	3.76	14.1	4.71	16.3	5.75	17.5	6.26	18.6	6.90	20.8	8.14	23.2	8.56	
48	10.4	3.28	12.4	4.11	14.4	5.03	15.4	5.47	16.5	6.03	18.4	7.12	20.5	7.34	
60	10	1.8	0.20	2.4	0.25	3.2	0.32	4.5	0.37	6.0	0.47	8.6	0.62	11.4	0.81
	12	1.8	0.20	2.4	0.25	3.2	0.32	4.5	0.37	6.0	0.47	8.6	0.62	11.4	0.81
	14	1.8	0.21	2.4	0.26	3.2	0.32	4.5	0.38	6.0	0.48	8.6	0.63	11.4	0.82
	16	1.8	0.21	2.4	0.26	3.2	0.33	4.5	0.38	6.0	0.48	8.6	0.63	11.4	0.83
	18	1.8	0.21	2.4	0.26	3.2	0.33	4.5	0.38	6.0	0.49	8.6	0.64	11.4	0.84
	20	1.8	0.21	2.4	0.26	3.2	0.33	4.5	0.39	6.0	0.49	8.6	0.65	11.4	0.85
	21	1.8	0.21	2.4	0.27	4.0	0.43	5.3	0.47	6.9	0.59	9.4	0.71	12.2	0.93
	23	1.8	0.24	4.0	0.50	5.7	0.64	7.4	0.68	8.7	0.87	10.9	1.06	13.6	1.28
	25	3.4	0.45	5.6	0.75	7.4	0.88	9.5	1.16	10.4	1.26	12.7	1.56	15.1	1.85
	27	4.9	0.65	7.2	1.07	9.0	1.30	11.5	1.62	12.2	1.81	14.2	2.07	16.5	2.39
	29	6.5	0.85	8.8	1.37	10.7	1.73	13.6	2.13	14.0	2.31	15.8	2.60	18.0	3.05
	31	8.1	1.08	10.3	1.64	12.3	2.11	15.2	2.56	15.8	2.68	17.7	2.88	19.4	3.52
	33	9.7	1.50	11.9	1.99	14.0	2.36	16.4	2.87	17.6	3.07	19.1	3.41	20.8	4.01
	35	11.3	2.11	13.5	2.58	15.7	3.10	16.8	3.37	17.9	3.66	20.1	4.28	22.3	4.93
	37	11.3	2.23	13.5	2.73	15.7	3.28	16.8	3.58	17.9	3.88	20.1	4.54	22.3	5.25
	39	11.3	2.37	13.5	2.90	15.7	3.54	16.8	3.84	17.9	4.18	20.1	4.87	22.3	5.62
	41	11.0	2.57	13.2	3.18	15.3	3.84	16.4	4.20	17.4	4.54	19.6	5.34	21.7	6.11
43	10.7	2.80	12.8	3.46	14.9	4.19	16.0	4.57	17.0	4.95	19.1	5.83	21.2	6.68	
46	10.1	3.13	12.0	3.89	14.0	4.71	15.0	5.14	15.9	5.57	17.9	6.57	19.9	7.61	
48	8.9	2.73	10.6	3.39	12.4	4.12	13.2	4.49	14.1	4.86	15.8	5.75	17.6	6.65	
50	10	1.6	0.18	2.2	0.22	3.1	0.28	4.2	0.34	5.5	0.41	7.9	0.55	10.5	0.71
	12	1.6	0.18	2.2	0.23	3.1	0.28	4.2	0.35	5.5	0.42	7.9	0.55	10.5	0.72
	14	1.6	0.18	2.2	0.23	3.1	0.29	4.2	0.35	5.5	0.42	7.9	0.56	10.5	0.73
	16	1.6	0.18	2.2	0.23	3.1	0.29	4.2	0.36	5.5	0.43	7.9	0.56	10.5	0.74
	18	1.6	0.19	2.2	0.23	3.1	0.29	4.2	0.36	5.5	0.43	7.9	0.57	10.5	0.74
	20	1.6	0.19	2.2	0.24	3.1	0.30	4.2	0.36	5.5	0.44	7.9	0.58	10.5	0.75
	21	1.6	0.19	2.2	0.24	3.9	0.38	4.9	0.43	6.2	0.52	8.6	0.63	11.0	0.83
	23	1.6	0.20	3.5	0.41	5.4	0.57	6.9	0.68	7.9	0.77	9.9	0.94	12.2	1.14
	25	2.9	0.37	4.8	0.61	6.9	0.80	9.2	1.10	9.7	1.12	11.2	1.32	13.3	1.60
	27	4.2	0.53	6.1	0.86	8.5	1.11	10.6	1.47	11.3	1.51	12.5	1.73	14.5	2.04
	29	5.5	0.69	7.4	1.11	9.9	1.43	11.9	1.82	12.8	1.95	13.8	2.14	15.6	2.58
	31	6.8	0.88	8.7	1.32	11.2	1.74	13.0	2.03	13.7	2.16	15.0	2.31	16.7	2.84
	33	8.1	1.22	10.0	1.58	12.6	1.95	13.5	2.23	14.3	2.38	16.3	2.74	17.9	3.18
	35	9.5	1.76	11.3	2.11	13.1	2.50	14.0	2.71	14.9	2.92	16.7	3.37	18.6	3.87
	37	9.5	1.86	11.3	2.23	13.1	2.64	14.0	2.87	14.9	3.09	16.7	3.59	18.6	4.11
	39	9.5	1.99	11.3	2.39	13.1	2.83	14.0	3.08	14.9	3.32	16.7	3.83	18.6	4.44
	41	9.2	2.15	11.0	2.59	12.8	3.09	13.6	3.34	14.5	3.59	16.3	4.19	18.1	4.82
43	9.0	2.33	10.7	2.82	12.4	3.37	13.3	3.64	14.2	3.91	15.9	4.57	17.7	5.25	
46	8.4	2.61	10.1	3.16	11.7	3.78	12.5	4.08	13.3	4.39	14.9	5.14	16.6	5.92	
48	7.4	2.28	8.9	2.75	10.3	3.29	11.0	3.57	11.7	3.83	13.2	4.50	14.7	5.17	

**Note**

1. TC: Total Capacity(kW), PI : Power Input(kW, Comp. + Outdoor fan motor)
2. Capacity tables show the average value of conditions which may occur.

# 7. Capacity Tables

## ◆ ARUM120LTE5

Cooling Capacity (12HP)

Combination (%)	Outdoor air temp. (DB, °C)	Indoor air temp. (DB/WB, °C)													
		20		23		26		27		28		30		32	
		14	16	16	18	18	19	19	20	20	22	22	24	24	
		TC	PI	TC	PI	TC	PI	TC	PI	TC	PI	TC	PI	TC	PI
130	10	4.7	0.44	6.4	0.55	8.6	0.67	12.1	0.82	16.0	1.02	23.0	1.36	30.5	1.80
	12	4.7	0.45	6.4	0.56	8.6	0.68	12.1	0.83	16.0	1.03	23.0	1.38	30.5	1.82
	14	4.7	0.45	6.4	0.56	8.6	0.68	12.1	0.83	16.0	1.04	23.0	1.39	30.5	1.84
	16	4.7	0.45	6.4	0.57	8.6	0.69	12.1	0.84	16.0	1.05	23.0	1.41	30.5	1.86
	18	4.7	0.46	6.4	0.57	8.6	0.70	12.1	0.85	16.0	1.06	23.0	1.42	30.5	1.88
	20	4.7	0.46	6.4	0.58	8.6	0.71	12.1	0.86	16.0	1.08	23.0	1.43	30.5	1.90
	21	4.7	0.47	6.5	0.60	10.6	0.88	14.1	1.02	17.9	1.32	24.5	1.80	31.5	2.14
	23	8.2	0.83	11.4	1.09	14.8	1.25	18.5	1.39	21.7	1.99	27.6	2.57	33.5	3.03
	25	12.1	1.32	14.7	1.64	19.0	1.87	23.0	2.20	25.4	2.86	30.6	3.74	35.4	4.40
	27	15.9	2.10	18.8	2.48	23.1	2.82	27.4	3.37	29.2	4.28	33.6	5.39	37.4	6.07
	29	19.6	2.92	22.9	3.42	27.3	4.14	31.8	4.87	33.0	5.81	36.7	6.97	39.4	7.76
	31	23.7	3.81	27.5	4.70	32.0	5.71	35.8	6.66	36.7	7.60	38.8	9.55	41.4	9.68
	33	27.9	4.70	32.6	6.14	36.6	7.35	38.7	9.54	39.6	9.47	40.8	9.56	43.5	9.69
	35	33.3	6.35	38.1	7.70	39.4	9.34	40.0	9.39	40.7	9.44	41.8	9.53	43.0	9.56
	37	33.3	6.77	37.6	8.08	38.8	9.22	39.4	9.26	40.0	9.32	41.1	9.40	42.3	9.44
	39	33.3	7.21	36.9	8.50	38.1	9.09	38.8	9.14	39.4	9.19	40.6	9.27	41.8	9.31
41	32.4	7.65	35.4	8.93	36.6	8.97	37.1	9.01	37.9	9.07	39.0	9.15	40.1	9.18	
43	31.6	8.07	33.9	8.80	35.1	8.85	35.6	8.89	36.4	8.94	37.5	9.02	38.5	9.06	
46	29.6	8.63	30.9	8.62	32.1	8.66	32.6	8.70	33.3	8.76	34.3	8.83	35.2	8.87	
48	26.2	8.39	26.9	8.42	27.9	8.44	28.3	8.46	28.9	8.53	29.9	8.59	30.7	8.62	
120	10	4.4	0.41	5.9	0.52	7.9	0.63	11.2	0.76	14.8	0.96	21.2	1.27	28.2	1.69
	12	4.4	0.42	5.9	0.52	7.9	0.63	11.2	0.77	14.8	0.97	21.2	1.29	28.2	1.71
	14	4.4	0.42	5.9	0.53	7.9	0.64	11.2	0.78	14.8	0.98	21.2	1.30	28.2	1.72
	16	4.4	0.43	5.9	0.53	7.9	0.65	11.2	0.79	14.8	0.99	21.2	1.31	28.2	1.74
	18	4.4	0.43	5.9	0.54	7.9	0.65	11.2	0.80	14.8	1.00	21.2	1.33	28.2	1.76
	20	4.4	0.43	5.9	0.54	7.9	0.66	11.2	0.80	14.8	1.01	21.2	1.34	28.2	1.78
	21	4.4	0.44	6.0	0.56	10.0	0.84	13.0	0.96	16.7	1.24	22.7	1.69	29.2	2.00
	23	7.6	0.78	10.9	1.04	14.3	1.20	17.0	1.30	20.6	1.86	25.9	2.41	31.2	2.83
	25	11.8	1.23	15.2	1.56	18.7	1.74	21.2	2.06	24.7	2.67	29.2	3.50	33.2	4.11
	27	16.4	1.95	20.7	2.32	23.2	2.61	25.2	3.13	28.8	3.97	32.5	5.00	35.3	5.73
	29	21.0	2.71	25.0	3.13	27.7	3.84	29.3	4.52	33.0	5.39	35.8	6.47	37.3	7.27
	31	25.5	3.43	30.1	4.13	32.2	5.09	33.7	5.99	37.2	6.83	38.2	8.22	39.5	8.37
	33	29.5	4.23	35.4	5.40	37.6	6.56	38.1	7.60	38.7	8.95	39.8	9.05	41.0	9.12
	35	30.1	5.65	35.8	7.31	37.9	8.09	38.5	9.64	39.1	9.69	40.2	9.71	41.2	9.79
	37	30.1	6.07	35.8	7.72	37.4	8.63	37.9	9.43	38.5	9.48	39.5	9.51	40.6	9.59
	39	30.1	6.54	35.7	8.16	36.7	9.15	37.3	9.24	37.8	9.29	39.0	9.31	40.1	9.39
41	29.3	7.00	34.1	8.60	35.3	8.97	35.8	9.05	36.3	9.09	37.3	9.12	38.4	9.19	
43	28.6	7.48	32.7	8.47	33.8	8.77	34.3	8.85	34.8	8.90	35.8	8.92	36.9	9.00	
46	26.8	8.04	29.8	8.27	30.9	8.49	31.3	8.56	31.8	8.61	32.8	8.63	33.8	8.70	
48	23.7	7.87	25.9	8.13	26.8	8.33	27.3	8.38	27.7	8.40	28.5	8.44	29.4	8.47	
110	10	4.0	0.39	5.4	0.48	7.3	0.59	10.3	0.72	13.5	0.90	19.5	1.20	25.8	1.59
	12	4.0	0.39	5.4	0.49	7.3	0.60	10.3	0.73	13.5	0.91	19.5	1.21	25.8	1.60
	14	4.0	0.40	5.4	0.49	7.3	0.60	10.3	0.73	13.5	0.92	19.5	1.22	25.8	1.62
	16	4.0	0.40	5.4	0.50	7.3	0.61	10.3	0.74	13.5	0.93	19.5	1.24	25.8	1.64
	18	4.0	0.40	5.4	0.50	7.3	0.61	10.3	0.75	13.5	0.94	19.5	1.25	25.8	1.65
	20	4.0	0.41	5.4	0.51	7.3	0.62	10.3	0.76	13.5	0.95	19.5	1.26	25.8	1.67
	21	4.0	0.41	5.4	0.53	9.1	0.77	12.0	0.90	15.0	1.16	21.0	1.58	27.1	1.88
	23	7.2	0.73	9.1	0.98	12.8	1.10	15.7	1.22	19.1	1.75	23.9	2.26	29.5	2.66
	25	10.3	1.16	12.8	1.47	16.4	1.64	19.4	1.93	22.6	2.51	26.7	3.29	31.8	3.87
	27	13.4	1.83	16.4	2.18	20.1	2.46	23.1	2.94	26.4	3.73	29.7	4.70	34.4	5.38
	29	16.6	2.55	20.0	2.94	23.7	3.61	26.8	4.25	30.1	5.06	32.7	5.96	36.3	6.61
	31	20.1	3.22	24.2	3.89	27.9	4.79	30.6	5.63	33.9	6.42	35.8	6.89	37.6	7.41
	33	23.3	3.97	27.9	5.07	31.6	6.16	34.5	6.88	36.6	7.72	37.8	7.94	38.7	7.95
	35	27.0	5.00	32.2	6.44	35.9	7.34	37.0	7.86	37.5	8.35	38.4	8.42	39.4	8.46
	37	27.0	5.30	32.2	6.83	35.9	7.75	36.4	8.33	36.8	8.80	37.9	8.83	38.8	8.86
	39	27.0	5.72	32.2	7.26	35.3	8.17	35.8	8.91	36.3	9.24	37.2	9.25	38.3	9.26
41	26.3	6.13	31.3	7.69	33.8	8.62	34.3	9.64	34.7	9.64	35.8	9.71	36.6	9.79	
43	25.6	6.44	30.6	8.01	32.4	9.14	32.9	9.24	33.3	9.22	34.3	9.28	35.2	9.30	
46	24.0	6.28	28.6	7.73	29.5	8.68	30.0	8.68	30.4	8.75	31.4	8.80	32.2	8.82	
48	21.3	6.10	24.9	7.45	25.6	8.25	26.1	8.31	26.5	8.35	27.3	8.37	28.0	8.41	

# 7. Capacity Tables

Cooling Capacity (12HP)

Combination (%)	Outdoor air temp. (DB, °C)	Indoor air temp. (DB/WB, °C)													
		20		23		26		27		28		30		32	
		14		16		18		19		20		22		24	
		TC	PI	TC	PI	TC	PI	TC	PI	TC	PI	TC	PI	TC	PI
100	10	3.7	0.36	5.0	0.44	6.7	0.54	9.4	0.66	12.4	0.82	17.9	1.10	23.7	1.45
	12	3.7	0.36	5.0	0.45	6.7	0.55	9.4	0.67	12.4	0.83	17.9	1.11	23.7	1.47
	14	3.7	0.36	5.0	0.45	6.7	0.55	9.4	0.67	12.4	0.84	17.9	1.12	23.7	1.49
	16	3.7	0.37	5.0	0.46	6.7	0.56	9.4	0.68	12.4	0.85	17.9	1.13	23.7	1.50
	18	3.7	0.37	5.0	0.46	6.7	0.56	9.4	0.69	12.4	0.86	17.9	1.15	23.7	1.52
	20	3.7	0.37	5.0	0.47	6.7	0.57	9.4	0.69	12.4	0.87	17.9	1.16	23.7	1.53
	21	3.7	0.38	5.0	0.48	8.3	0.71	11.1	0.83	14.1	1.07	19.3	1.45	24.9	1.72
	23	6.4	0.67	8.8	0.90	11.6	1.01	14.6	1.12	17.6	1.60	22.1	2.07	27.3	2.44
	25	9.1	1.06	11.8	1.35	14.9	1.50	18.1	1.77	21.1	2.31	24.9	3.01	29.7	3.55
	27	11.8	1.68	14.9	2.00	18.2	2.25	21.6	2.69	24.7	3.42	27.8	4.31	32.1	4.94
	29	14.5	2.33	17.9	2.70	21.5	3.31	25.1	3.90	28.2	4.65	30.6	5.58	34.5	6.06
	31	17.2	2.96	21.0	3.56	24.8	4.39	28.6	5.17	31.7	5.89	33.4	6.45	37.2	6.87
	33	19.9	3.64	24.0	4.65	28.1	5.65	32.1	6.55	35.2	7.16	36.3	7.28	37.2	7.44
	35	22.7	4.39	27.0	5.60	31.4	6.96	33.6	7.71	35.2	7.76	36.3	7.79	37.2	7.85
	37	22.7	4.70	27.0	6.01	31.4	7.38	33.6	8.08	34.6	8.12	35.6	8.15	36.5	8.22
	39	22.7	5.04	27.0	6.46	31.4	7.82	33.6	8.47	34.1	8.51	35.1	8.54	35.9	8.62
	41	22.3	5.38	26.6	6.90	30.9	8.26	32.2	8.87	32.9	8.90	33.7	8.93	34.8	9.02
43	21.6	5.69	25.7	7.32	29.9	8.65	30.9	9.21	31.3	9.24	32.2	9.27	33.1	9.36	
46	20.2	6.12	24.0	7.89	28.0	9.18	28.2	9.64	28.5	9.67	29.4	9.69	30.2	9.79	
48	17.9	5.29	21.3	6.82	24.2	7.85	24.5	8.18	24.8	8.20	25.6	8.22	26.3	8.29	
90	10	3.3	0.33	4.5	0.41	6.0	0.51	8.3	0.59	11.2	0.76	16.1	1.00	21.3	1.31
	12	3.3	0.33	4.5	0.41	6.0	0.52	8.3	0.59	11.2	0.77	16.1	1.01	21.3	1.32
	14	3.3	0.33	4.5	0.42	6.0	0.52	8.3	0.60	11.2	0.77	16.1	1.02	21.3	1.34
	16	3.3	0.34	4.5	0.42	6.0	0.53	8.3	0.61	11.2	0.78	16.1	1.03	21.3	1.35
	18	3.3	0.34	4.5	0.43	6.0	0.54	8.3	0.61	11.2	0.79	16.1	1.04	21.3	1.36
	20	3.3	0.34	4.5	0.43	6.0	0.54	8.3	0.62	11.2	0.80	16.1	1.05	21.3	1.38
	21	3.3	0.35	4.5	0.43	7.5	0.68	9.8	0.73	12.6	0.96	17.4	1.16	22.4	1.52
	23	4.5	0.54	6.6	0.75	10.5	0.97	12.7	1.05	15.4	1.41	20.0	1.72	24.7	2.09
	25	7.1	0.91	9.6	1.20	13.5	1.43	15.7	1.66	18.2	2.05	22.5	2.59	27.0	3.01
	27	9.8	1.34	12.5	1.71	16.5	2.22	18.6	2.47	21.0	2.99	25.1	3.49	29.3	3.94
	29	12.4	1.81	15.5	2.34	19.4	3.09	21.5	3.42	23.8	3.95	27.7	4.48	31.5	5.22
	31	15.1	2.26	18.4	3.01	22.4	3.87	24.4	4.36	26.6	4.92	30.3	5.22	33.8	6.07
	33	17.7	2.91	21.4	3.70	25.4	4.69	27.3	5.17	29.4	5.72	32.9	6.18	36.1	6.78
	35	20.4	3.60	24.4	4.56	28.3	5.63	30.2	6.21	32.2	6.75	35.5	7.25	36.1	7.41
	37	20.4	3.82	24.4	4.85	28.3	6.01	30.2	6.60	32.2	7.13	34.9	7.57	35.5	7.74
	39	20.4	4.05	24.4	5.15	28.3	6.36	30.2	7.02	32.2	7.50	34.4	7.99	35.0	8.08
	41	19.9	4.53	23.7	5.71	27.6	6.98	29.5	7.68	31.3	8.09	32.9	8.42	33.5	8.61
43	19.4	4.89	23.1	6.17	26.9	7.62	28.7	8.27	30.6	8.68	31.6	8.99	32.1	9.12	
46	18.2	5.50	21.7	7.03	25.2	8.68	26.9	9.38	27.8	9.64	28.8	9.69	29.4	9.79	
48	16.1	4.81	19.2	6.15	22.3	7.60	23.8	8.18	24.1	8.20	25.0	8.22	25.5	8.29	
80	10	2.8	0.29	3.8	0.36	5.1	0.45	7.2	0.52	9.5	0.67	13.7	0.88	18.2	1.16
	12	2.8	0.29	3.8	0.36	5.1	0.46	7.2	0.53	9.5	0.68	13.7	0.89	18.2	1.17
	14	2.8	0.30	3.8	0.37	5.1	0.46	7.2	0.53	9.5	0.68	13.7	0.90	18.2	1.18
	16	2.8	0.30	3.8	0.37	5.1	0.47	7.2	0.54	9.5	0.69	13.7	0.91	18.2	1.19
	18	2.8	0.30	3.8	0.38	5.1	0.47	7.2	0.54	9.5	0.70	13.7	0.92	18.2	1.21
	20	2.8	0.30	3.8	0.38	5.1	0.48	7.2	0.55	9.5	0.71	13.7	0.93	18.2	1.22
	21	2.8	0.31	3.8	0.39	6.4	0.60	8.6	0.66	10.8	0.85	14.9	1.02	19.4	1.34
	23	5.0	0.57	6.4	0.67	9.1	0.85	11.4	0.95	13.4	1.24	17.4	1.52	21.7	1.84
	25	7.2	0.82	8.9	1.08	11.8	1.26	14.2	1.50	15.9	1.81	19.9	2.29	23.9	2.66
	27	9.4	1.20	11.5	1.53	14.4	1.96	17.0	2.22	18.5	2.65	22.3	3.08	26.2	3.49
	29	11.6	1.56	14.0	2.11	17.1	2.73	19.8	3.07	21.0	3.49	24.8	3.96	28.5	4.62
	31	13.7	1.91	16.5	2.65	19.7	3.42	22.6	3.92	24.1	4.23	27.2	4.56	30.7	5.31
	33	15.9	2.51	19.1	3.27	22.4	4.02	25.4	4.65	26.9	4.86	29.7	5.41	33.0	5.98
	35	18.1	3.29	21.6	4.12	25.1	5.06	26.9	5.56	28.7	6.08	32.2	6.90	35.3	7.19
	37	18.1	3.48	21.6	4.38	25.1	5.37	26.9	5.91	28.7	6.46	32.2	7.29	34.7	7.55
	39	18.1	3.68	21.6	4.64	25.1	5.74	26.9	6.35	28.7	6.95	32.2	7.70	34.1	7.97
	41	17.7	4.07	21.0	5.14	24.4	6.30	26.2	6.96	27.9	7.63	31.3	8.25	32.7	8.44
43	17.2	4.48	20.5	5.61	23.8	6.88	25.5	7.59	27.3	8.34	30.6	8.81	31.3	9.03	
46	16.1	4.98	19.2	6.31	22.3	7.75	23.9	8.45	25.5	9.41	27.9	9.69	28.6	9.79	
48	14.3	4.35	17.0	5.52	19.8	6.78	21.2	7.38	22.6	8.20	24.3	8.22	24.9	8.29	

# 7. Capacity Tables

Cooling Capacity (12HP)

Combination (%)	Outdoor air temp. (DB, °C)	Indoor air temp. (DB/WB, °C)													
		20		23		26		27		28		30		32	
		14		16		18		19		20		22		24	
		TC	PI	TC	PI	TC	PI	TC	PI	TC	PI	TC	PI	TC	PI
70	10	2.5	0.26	3.3	0.32	4.5	0.40	6.3	0.46	8.3	0.59	12.0	0.78	15.9	1.02
	12	2.5	0.26	3.3	0.32	4.5	0.41	6.3	0.47	8.3	0.60	12.0	0.79	15.9	1.03
	14	2.5	0.26	3.3	0.33	4.5	0.41	6.3	0.47	8.3	0.60	12.0	0.80	15.9	1.04
	16	2.5	0.26	3.3	0.33	4.5	0.41	6.3	0.48	8.3	0.61	12.0	0.81	15.9	1.06
	18	2.5	0.27	3.3	0.33	4.5	0.42	6.3	0.48	8.3	0.62	12.0	0.81	15.9	1.07
	20	2.5	0.27	3.3	0.34	4.5	0.42	6.3	0.49	8.3	0.62	12.0	0.82	15.9	1.08
	21	2.5	0.27	3.9	0.39	5.8	0.55	7.8	0.61	9.6	0.75	13.2	0.90	17.1	1.18
	23	3.5	0.41	6.0	0.65	8.1	0.81	10.5	0.88	12.2	1.10	15.7	1.34	19.4	1.63
	25	5.6	0.67	8.2	0.95	10.4	1.12	13.2	1.39	14.8	1.60	18.1	2.03	21.8	2.36
	27	7.6	0.98	10.3	1.36	12.7	1.65	15.9	2.07	17.3	2.34	20.6	2.73	24.2	3.08
	29	9.7	1.24	12.5	1.79	15.0	2.24	18.6	2.81	19.9	3.09	23.1	3.50	26.5	4.08
	31	11.7	1.53	14.6	2.23	17.3	2.80	21.3	3.53	22.5	3.74	25.6	4.04	28.9	4.69
	33	13.8	2.05	16.8	2.71	19.6	3.26	23.5	4.10	25.1	4.30	28.1	4.78	31.2	5.28
	35	15.8	2.81	19.0	3.50	22.0	4.24	23.5	4.64	25.1	5.06	28.1	5.96	31.2	6.54
	37	15.8	2.99	19.0	3.71	22.0	4.50	23.5	4.93	25.1	5.39	28.1	6.34	31.2	6.90
	39	15.8	3.17	19.0	3.96	22.0	4.82	23.5	5.30	25.1	5.82	28.1	6.79	31.2	7.44
	41	15.4	3.51	18.5	4.33	21.4	5.28	22.9	5.82	24.4	6.33	27.4	7.46	30.4	8.01
43	15.1	3.82	18.0	4.72	20.9	5.76	22.4	6.34	23.8	6.91	26.7	8.15	29.6	8.67	
46	14.1	4.24	16.9	5.31	19.6	6.49	20.9	7.07	22.3	7.79	25.0	9.19	27.8	9.67	
48	12.5	3.70	14.9	4.64	17.3	5.67	18.5	6.18	19.8	6.81	22.1	8.04	24.6	8.29	
60	10	2.2	0.23	2.9	0.28	3.9	0.35	5.5	0.41	7.2	0.52	10.4	0.69	13.7	0.90
	12	2.2	0.23	2.9	0.29	3.9	0.36	5.5	0.42	7.2	0.53	10.4	0.70	13.7	0.91
	14	2.2	0.23	2.9	0.29	3.9	0.36	5.5	0.42	7.2	0.53	10.4	0.71	13.7	0.92
	16	2.2	0.23	2.9	0.29	3.9	0.37	5.5	0.43	7.2	0.54	10.4	0.71	13.7	0.93
	18	2.2	0.24	2.9	0.29	3.9	0.37	5.5	0.43	7.2	0.55	10.4	0.72	13.7	0.94
	20	2.2	0.24	2.9	0.30	3.9	0.37	5.5	0.44	7.2	0.55	10.4	0.73	13.7	0.95
	21	2.2	0.24	2.9	0.31	4.8	0.48	6.4	0.53	8.2	0.66	11.2	0.80	14.6	1.05
	23	2.2	0.26	4.8	0.56	6.8	0.72	8.9	0.77	10.4	0.97	13.1	1.18	16.3	1.44
	25	4.0	0.50	6.7	0.84	8.8	0.99	11.4	1.31	12.5	1.42	15.2	1.76	18.1	2.08
	27	5.9	0.73	8.6	1.20	10.8	1.46	13.8	1.82	14.7	2.03	17.1	2.33	19.8	2.68
	29	7.8	0.95	10.5	1.54	12.8	1.94	16.3	2.39	16.8	2.59	19.0	2.92	21.5	3.43
	31	9.7	1.21	12.4	1.84	14.8	2.36	18.3	2.87	19.0	3.01	21.2	3.23	23.3	3.95
	33	11.6	1.69	14.3	2.23	16.8	2.65	19.7	3.22	21.1	3.45	22.9	3.83	25.0	4.50
	35	13.6	2.38	16.2	2.92	18.8	3.50	20.2	3.81	21.5	4.13	24.1	4.83	26.8	5.57
	37	13.6	2.52	16.2	3.08	18.8	3.70	20.2	4.04	21.5	4.38	24.1	5.12	26.8	5.92
	39	13.6	2.68	16.2	3.28	18.8	4.00	20.2	4.34	21.5	4.72	24.1	5.50	26.8	6.35
	41	13.2	2.90	15.8	3.59	18.4	4.34	19.6	4.74	20.9	5.12	23.5	6.03	26.1	6.90
43	12.9	3.16	15.4	3.91	17.9	4.73	19.2	5.16	20.4	5.58	22.9	6.58	25.4	7.54	
46	12.1	3.53	14.4	4.39	16.8	5.32	18.0	5.81	19.1	6.28	21.5	7.42	23.8	8.59	
48	10.7	3.08	12.8	3.83	14.8	4.65	15.9	5.07	16.9	5.49	19.0	6.49	21.1	7.51	
50	10	1.9	0.20	2.6	0.25	3.7	0.31	5.0	0.38	6.6	0.46	9.5	0.61	12.5	0.80
	12	1.9	0.20	2.6	0.25	3.7	0.32	5.0	0.39	6.6	0.47	9.5	0.62	12.5	0.80
	14	1.9	0.20	2.6	0.25	3.7	0.32	5.0	0.39	6.6	0.47	9.5	0.62	12.5	0.81
	16	1.9	0.21	2.6	0.26	3.7	0.32	5.0	0.40	6.6	0.48	9.5	0.63	12.5	0.82
	18	1.9	0.21	2.6	0.26	3.7	0.33	5.0	0.40	6.6	0.48	9.5	0.64	12.5	0.83
	20	1.9	0.21	2.6	0.26	3.7	0.33	5.0	0.40	6.6	0.49	9.5	0.64	12.5	0.84
	21	1.9	0.21	2.6	0.27	4.6	0.42	5.9	0.49	7.5	0.58	10.3	0.71	13.2	0.92
	23	1.9	0.22	4.2	0.46	6.4	0.63	8.3	0.76	9.5	0.86	11.8	1.05	14.6	1.27
	25	3.5	0.41	5.8	0.68	8.2	0.89	11.0	1.23	11.6	1.25	13.4	1.47	16.0	1.79
	27	5.1	0.59	7.3	0.96	10.2	1.24	12.7	1.64	13.5	1.69	14.9	1.93	17.3	2.28
	29	6.6	0.77	8.9	1.24	11.8	1.59	14.3	2.03	15.4	2.18	16.5	2.39	18.7	2.88
	31	8.2	0.98	10.4	1.47	13.4	1.94	15.6	2.27	16.5	2.41	18.0	2.58	20.1	3.17
	33	9.8	1.37	12.0	1.77	15.1	2.18	16.2	2.48	17.2	2.66	19.5	3.06	21.4	3.55
	35	11.3	1.98	13.6	2.38	15.7	2.82	16.8	3.06	17.9	3.29	20.0	3.80	22.3	4.37
	37	11.3	2.10	13.6	2.52	15.7	2.98	16.8	3.23	17.9	3.49	20.0	4.05	22.3	4.64
	39	11.3	2.24	13.6	2.70	15.7	3.19	16.8	3.48	17.9	3.74	20.0	4.32	22.3	5.01
	41	11.0	2.42	13.2	2.92	15.3	3.49	16.4	3.77	17.4	4.05	19.5	4.73	21.7	5.44
43	10.8	2.63	12.9	3.18	14.9	3.80	16.0	4.11	17.0	4.41	19.0	5.16	21.2	5.93	
46	10.1	2.95	12.1	3.57	14.0	4.26	15.0	4.61	15.9	4.96	17.8	5.81	19.9	6.68	
48	8.9	2.57	10.7	3.11	12.4	3.72	13.2	4.02	14.1	4.33	15.8	5.08	17.6	5.84	

**Note**

1. TC: Total Capacity(kW), PI : Power Input(kW, Comp. + Outdoor fan motor)
2. Capacity tables show the average value of conditions which may occur.

# 7. Capacity Tables

## ◆ ARUM140LTE5

Cooling Capacity (14HP)

Combination (%)	Outdoor air temp. (DB, °C)	Indoor air temp. (DB/WB, °C)													
		20		23		26		27		28		30		32	
		14	PI	16	PI	18	PI	19	PI	20	PI	22	PI	24	PI
130	10	5.5	0.50	7.5	0.62	10.0	0.75	14.2	0.92	18.7	1.15	26.9	1.53	35.6	2.03
	12	5.5	0.50	7.5	0.63	10.0	0.76	14.2	0.93	18.7	1.16	26.9	1.55	35.6	2.05
	14	5.5	0.51	7.5	0.63	10.0	0.77	14.2	0.94	18.7	1.17	26.9	1.56	35.6	2.07
	16	5.5	0.51	7.5	0.64	10.0	0.78	14.2	0.95	18.7	1.19	26.9	1.58	35.6	2.09
	18	5.5	0.52	7.5	0.65	10.0	0.79	14.2	0.96	18.7	1.20	26.9	1.60	35.6	2.11
	20	5.5	0.52	7.5	0.65	10.0	0.79	14.2	0.97	18.7	1.21	26.9	1.61	35.6	2.14
	21	5.5	0.53	7.6	0.67	12.4	0.99	16.5	1.15	20.9	1.49	28.6	2.03	36.8	2.40
	23	9.6	0.94	13.4	1.23	17.3	1.40	21.6	1.56	25.3	2.24	32.2	2.89	39.1	3.41
	25	14.2	1.48	17.2	1.85	22.1	2.10	26.9	2.47	29.7	3.21	35.7	4.20	41.3	4.95
	27	18.5	2.36	21.9	2.79	27.0	3.17	31.9	3.79	34.1	4.81	39.2	6.06	43.6	6.83
	29	22.8	3.28	26.7	3.85	31.8	4.65	37.1	5.48	38.5	6.53	42.8	7.84	45.9	8.72
	31	27.7	4.29	32.1	5.29	37.4	6.42	41.8	7.49	42.9	8.55	45.2	10.74	48.3	10.89
	33	32.6	5.29	38.1	6.90	42.7	8.26	45.2	10.73	46.2	10.65	47.6	10.75	50.8	10.90
	35	38.8	7.14	44.5	8.65	45.9	10.50	46.7	10.55	47.5	10.62	48.8	10.71	50.2	10.75
	37	38.8	7.61	43.9	9.08	45.3	10.36	45.9	10.41	46.7	10.48	48.0	10.57	49.4	10.61
	39	38.8	8.11	43.1	9.56	44.5	10.22	45.3	10.28	45.9	10.34	47.3	10.43	48.8	10.47
41	37.8	8.60	41.3	10.04	42.7	10.09	43.3	10.14	44.2	10.20	45.5	10.29	46.7	10.33	
43	36.9	9.07	39.6	9.90	41.0	9.95	41.6	10.00	42.4	10.06	43.7	10.15	44.9	10.19	
46	34.6	9.71	36.1	9.69	37.4	9.74	38.0	9.79	38.8	9.85	40.0	9.93	41.1	9.97	
48	30.6	9.44	31.4	9.47	32.5	9.49	33.0	9.51	33.8	9.60	34.8	9.66	35.8	9.69	
120	10	5.1	0.46	6.9	0.58	9.3	0.70	13.1	0.86	17.2	1.07	24.8	1.43	32.9	1.90
	12	5.1	0.47	6.9	0.59	9.3	0.71	13.1	0.87	17.2	1.09	24.8	1.45	32.9	1.92
	14	5.1	0.47	6.9	0.59	9.3	0.72	13.1	0.88	17.2	1.10	24.8	1.46	32.9	1.94
	16	5.1	0.48	6.9	0.60	9.3	0.73	13.1	0.89	17.2	1.11	24.8	1.48	32.9	1.96
	18	5.1	0.48	6.9	0.60	9.3	0.73	13.1	0.90	17.2	1.12	24.8	1.49	32.9	1.98
	20	5.1	0.49	6.9	0.61	9.3	0.74	13.1	0.91	17.2	1.13	24.8	1.51	32.9	2.00
	21	5.1	0.49	7.1	0.63	11.7	0.95	15.2	1.08	19.5	1.39	26.5	1.90	34.1	2.25
	23	8.8	0.88	12.7	1.17	16.7	1.35	19.9	1.46	24.1	2.09	30.2	2.71	36.4	3.19
	25	13.8	1.39	17.8	1.76	21.8	1.96	24.8	2.31	28.9	3.01	34.0	3.93	38.8	4.63
	27	19.1	2.19	24.2	2.61	27.1	2.94	29.4	3.52	33.7	4.46	37.9	5.63	41.1	6.44
	29	24.5	3.05	29.1	3.52	32.3	4.32	34.2	5.08	38.4	6.06	41.8	7.27	43.5	8.18
	31	29.7	3.86	35.1	4.65	37.5	5.73	39.4	6.74	43.4	7.68	44.6	9.24	46.1	9.42
	33	34.4	4.75	41.4	6.07	43.8	7.37	44.4	8.55	45.2	10.06	46.4	10.17	47.9	10.26
	35	35.1	6.35	41.8	8.23	44.3	9.10	44.9	10.84	45.7	10.89	46.9	10.92	48.1	11.01
	37	35.1	6.83	41.8	8.68	43.6	9.70	44.3	10.61	44.9	10.66	46.1	10.69	47.4	10.78
	39	35.1	7.35	41.6	9.17	42.9	10.29	43.5	10.39	44.1	10.44	45.5	10.47	46.7	10.56
41	34.2	7.88	39.8	9.67	41.2	10.09	41.7	10.17	42.3	10.22	43.6	10.26	44.8	10.34	
43	33.4	8.41	38.1	9.53	39.5	9.86	40.0	9.96	40.6	10.01	41.8	10.04	43.0	10.12	
46	31.3	9.04	34.8	9.30	36.0	9.55	36.6	9.63	37.1	9.68	38.2	9.71	39.4	9.78	
48	27.7	8.86	30.2	9.14	31.3	9.36	31.8	9.42	32.3	9.45	33.3	9.49	34.3	9.53	
110	10	4.7	0.44	6.4	0.54	8.5	0.66	12.0	0.81	15.8	1.01	22.7	1.35	30.1	1.78
	12	4.7	0.44	6.4	0.55	8.5	0.67	12.0	0.82	15.8	1.02	22.7	1.36	30.1	1.80
	14	4.7	0.45	6.4	0.56	8.5	0.68	12.0	0.83	15.8	1.03	22.7	1.38	30.1	1.82
	16	4.7	0.45	6.4	0.56	8.5	0.68	12.0	0.83	15.8	1.04	22.7	1.39	30.1	1.84
	18	4.7	0.45	6.4	0.57	8.5	0.69	12.0	0.84	15.8	1.05	22.7	1.40	30.1	1.86
	20	4.7	0.46	6.4	0.57	8.5	0.70	12.0	0.85	15.8	1.06	22.7	1.42	30.1	1.88
	21	4.7	0.46	6.4	0.59	10.6	0.87	14.1	1.01	17.5	1.31	24.5	1.78	31.6	2.11
	23	8.3	0.82	10.6	1.10	14.9	1.23	18.3	1.37	22.2	1.97	27.8	2.54	34.4	2.99
	25	12.0	1.30	14.9	1.65	19.1	1.84	22.6	2.17	26.4	2.83	31.1	3.70	37.1	4.35
	27	15.7	2.06	19.1	2.45	23.4	2.76	26.9	3.30	30.8	4.19	34.7	5.29	40.1	6.05
	29	19.4	2.86	23.4	3.30	27.7	4.06	31.3	4.78	35.2	5.69	38.2	6.70	42.3	7.43
	31	23.5	3.62	28.2	4.37	32.5	5.38	35.7	6.33	39.5	7.22	41.7	7.74	43.9	8.34
	33	27.2	4.47	32.5	5.70	36.9	6.93	40.2	7.74	42.7	8.69	44.1	8.93	45.2	8.94
	35	31.5	5.63	37.5	7.24	41.9	8.25	43.1	8.84	43.7	9.39	44.8	9.47	46.0	9.52
	37	31.5	5.96	37.5	7.68	41.9	8.71	42.5	9.37	43.0	9.90	44.2	9.93	45.2	9.96
	39	31.5	6.43	37.5	8.16	41.2	9.19	41.8	10.02	42.4	10.39	43.4	10.41	44.6	10.42
41	30.7	6.89	36.6	8.65	39.4	9.69	40.0	10.84	40.5	10.84	41.7	10.92	42.7	11.01	
43	29.9	7.24	35.7	9.01	37.7	10.28	38.4	10.40	38.9	10.37	40.0	10.43	41.0	10.46	
46	28.0	7.07	33.4	8.70	34.4	9.76	35.0	9.76	35.5	9.84	36.6	9.89	37.5	9.92	
48	24.8	6.86	29.0	8.38	29.9	9.28	30.5	9.34	30.9	9.39	31.8	9.42	32.7	9.45	

# 7. Capacity Tables

Cooling Capacity (14HP)

Combination (%)	Outdoor air temp. (DB, °C)	Indoor air temp. (DB/WB, °C)													
		20		23		26		27		28		30		32	
		14		16		18		19		20		22		24	
		TC	PI	TC	PI	TC	PI	TC	PI	TC	PI	TC	PI	TC	PI
100	10	4.3	0.40	5.8	0.50	7.8	0.61	11.0	0.74	14.5	0.93	20.8	1.24	27.6	1.64
	12	4.3	0.40	5.8	0.50	7.8	0.61	11.0	0.75	14.5	0.94	20.8	1.25	27.6	1.65
	14	4.3	0.41	5.8	0.51	7.8	0.62	11.0	0.76	14.5	0.95	20.8	1.26	27.6	1.67
	16	4.3	0.41	5.8	0.52	7.8	0.63	11.0	0.76	14.5	0.96	20.8	1.27	27.6	1.69
	18	4.3	0.42	5.8	0.52	7.8	0.63	11.0	0.77	14.5	0.97	20.8	1.29	27.6	1.71
	20	4.3	0.42	5.8	0.53	7.8	0.64	11.0	0.78	14.5	0.98	20.8	1.30	27.6	1.72
	21	4.3	0.43	5.8	0.54	9.7	0.80	12.9	0.93	16.5	1.20	22.5	1.63	29.0	1.94
	23	7.4	0.75	10.2	1.01	13.5	1.13	17.0	1.26	20.6	1.80	25.8	2.33	31.9	2.75
	25	10.6	1.20	13.8	1.51	17.4	1.69	21.2	1.99	24.7	2.59	29.1	3.39	34.7	3.99
	27	13.8	1.89	17.3	2.25	21.3	2.53	25.1	3.03	28.8	3.85	32.4	4.85	37.5	5.55
	29	16.9	2.63	20.9	3.03	25.1	3.72	29.2	4.38	32.9	5.22	35.7	6.27	40.3	6.81
	31	20.1	3.32	24.5	4.01	29.0	4.94	33.3	5.81	36.9	6.62	39.0	7.25	43.4	7.73
	33	23.3	4.10	28.0	5.23	32.8	6.35	37.4	7.37	41.1	8.05	42.4	8.19	43.4	8.37
	35	26.5	4.94	31.5	6.30	36.7	7.83	39.2	8.67	41.1	8.72	42.4	8.76	43.4	8.83
	37	26.5	5.29	31.5	6.76	36.7	8.30	39.2	9.08	40.4	9.13	41.6	9.16	42.6	9.25
	39	26.5	5.67	31.5	7.26	36.7	8.79	39.2	9.53	39.7	9.57	40.9	9.60	41.9	9.69
41	26.0	6.05	31.0	7.76	36.1	9.29	37.6	9.97	38.4	10.01	39.3	10.05	40.6	10.14	
43	25.1	6.40	29.9	8.23	34.9	9.73	36.1	10.35	36.5	10.39	37.6	10.42	38.6	10.52	
46	23.6	6.88	28.1	8.87	32.7	10.32	32.9	10.84	33.3	10.87	34.4	10.90	35.3	11.00	
48	20.8	5.94	24.8	7.67	28.2	8.82	28.6	9.20	28.9	9.23	29.9	9.25	30.7	9.32	
90	10	3.8	0.37	5.2	0.46	7.0	0.58	9.7	0.66	13.0	0.85	18.7	1.12	24.9	1.47
	12	3.8	0.37	5.2	0.46	7.0	0.58	9.7	0.67	13.0	0.86	18.7	1.14	24.9	1.49
	14	3.8	0.38	5.2	0.47	7.0	0.59	9.7	0.67	13.0	0.87	18.7	1.15	24.9	1.50
	16	3.8	0.38	5.2	0.47	7.0	0.60	9.7	0.68	13.0	0.88	18.7	1.16	24.9	1.52
	18	3.8	0.38	5.2	0.48	7.0	0.60	9.7	0.69	13.0	0.89	18.7	1.17	24.9	1.53
	20	3.8	0.39	5.2	0.48	7.0	0.61	9.7	0.69	13.0	0.90	18.7	1.18	24.9	1.55
	21	3.8	0.39	5.2	0.49	8.8	0.77	11.5	0.82	14.7	1.08	20.3	1.30	26.2	1.71
	23	5.2	0.61	7.7	0.84	12.3	1.09	14.9	1.18	17.9	1.58	23.3	1.93	28.8	2.35
	25	8.3	1.02	11.2	1.35	15.7	1.61	18.3	1.87	21.2	2.31	26.3	2.92	31.5	3.39
	27	11.4	1.50	14.6	1.92	19.2	2.49	21.7	2.78	24.5	3.36	29.3	3.92	34.1	4.44
	29	14.5	2.03	18.1	2.63	22.7	3.47	25.1	3.84	27.8	4.44	32.4	5.04	36.8	5.87
	31	17.6	2.54	21.5	3.38	26.1	4.35	28.5	4.90	31.0	5.53	35.4	5.87	39.5	6.82
	33	20.7	3.27	25.0	4.16	29.6	5.27	31.9	5.81	34.3	6.43	38.4	6.95	42.1	7.62
	35	23.8	4.05	28.4	5.12	33.0	6.33	35.3	6.99	37.5	7.60	41.4	8.15	42.1	8.34
	37	23.8	4.30	28.4	5.45	33.0	6.75	35.3	7.42	37.5	8.02	40.7	8.52	41.5	8.71
	39	23.8	4.55	28.4	5.80	33.0	7.15	35.3	7.90	37.5	8.43	40.1	8.98	40.8	9.09
41	23.2	5.09	27.7	6.43	32.2	7.85	34.4	8.64	36.6	9.10	38.4	9.46	39.1	9.68	
43	22.6	5.50	27.0	6.94	31.4	8.57	33.5	9.30	35.7	9.76	36.8	10.11	37.5	10.26	
46	21.2	6.19	25.3	7.91	29.4	9.76	31.4	10.55	32.4	10.84	33.6	10.90	34.2	11.00	
48	18.8	5.41	22.4	6.92	26.0	8.54	27.8	9.20	28.1	9.23	29.2	9.25	29.8	9.32	
80	10	3.3	0.33	4.5	0.41	6.0	0.51	8.5	0.59	11.1	0.75	16.0	0.99	21.3	1.30
	12	3.3	0.33	4.5	0.41	6.0	0.52	8.5	0.59	11.1	0.76	16.0	1.00	21.3	1.32
	14	3.3	0.33	4.5	0.41	6.0	0.52	8.5	0.60	11.1	0.77	16.0	1.01	21.3	1.33
	16	3.3	0.34	4.5	0.42	6.0	0.53	8.5	0.61	11.1	0.78	16.0	1.03	21.3	1.34
	18	3.3	0.34	4.5	0.42	6.0	0.53	8.5	0.61	11.1	0.79	16.0	1.04	21.3	1.36
	20	3.3	0.34	4.5	0.43	6.0	0.54	8.5	0.62	11.1	0.79	16.0	1.05	21.3	1.37
	21	3.3	0.34	4.5	0.44	7.5	0.68	10.1	0.74	12.6	0.95	17.4	1.15	22.6	1.51
	23	5.8	0.64	7.5	0.76	10.6	0.96	13.3	1.06	15.6	1.40	20.3	1.71	25.3	2.07
	25	8.4	0.92	10.4	1.21	13.7	1.42	16.6	1.68	18.6	2.04	23.2	2.58	27.9	3.00
	27	10.9	1.35	13.4	1.73	16.8	2.20	19.9	2.50	21.6	2.97	26.0	3.47	30.6	3.92
	29	13.5	1.75	16.3	2.37	19.9	3.07	23.1	3.46	24.5	3.93	28.9	4.45	33.2	5.19
	31	16.0	2.15	19.3	2.98	23.0	3.85	26.4	4.41	28.1	4.76	31.7	5.13	35.9	5.97
	33	18.6	2.83	22.2	3.67	26.1	4.52	29.7	5.23	31.4	5.47	34.6	6.08	38.5	6.72
	35	21.1	3.70	25.2	4.64	29.3	5.69	31.4	6.25	33.5	6.84	37.5	7.76	41.1	8.09
	37	21.1	3.91	25.2	4.93	29.3	6.04	31.4	6.64	33.5	7.27	37.5	8.19	40.5	8.49
	39	21.1	4.14	25.2	5.21	29.3	6.46	31.4	7.14	33.5	7.81	37.5	8.66	39.8	8.96
41	20.6	4.58	24.6	5.78	28.5	7.09	30.6	7.83	32.6	8.58	36.6	9.27	38.1	9.49	
43	20.1	5.04	23.9	6.30	27.8	7.74	29.8	8.53	31.8	9.38	35.7	9.91	36.6	10.15	
46	18.8	5.60	22.4	7.10	26.1	8.72	27.9	9.50	29.8	10.58	32.6	10.90	33.4	11.00	
48	16.7	4.89	19.9	6.21	23.1	7.62	24.7	8.30	26.4	9.23	28.3	9.25	29.0	9.32	

# 7. Capacity Tables

Cooling Capacity (14HP)

Combination (%)	Outdoor air temp. (DB, °C)	Indoor air temp. (DB/WB, °C)													
		20		23		26		27		28		30		32	
		14		16		18		19		20		22		24	
		TC	PI	TC	PI	TC	PI	TC	PI	TC	PI	TC	PI	TC	PI
70	10	2.9	0.29	3.9	0.36	5.2	0.45	7.4	0.52	9.7	0.67	14.0	0.88	18.5	1.15
	12	2.9	0.29	3.9	0.36	5.2	0.46	7.4	0.53	9.7	0.67	14.0	0.89	18.5	1.16
	14	2.9	0.29	3.9	0.37	5.2	0.46	7.4	0.53	9.7	0.68	14.0	0.90	18.5	1.17
	16	2.9	0.30	3.9	0.37	5.2	0.47	7.4	0.54	9.7	0.69	14.0	0.91	18.5	1.19
	18	2.9	0.30	3.9	0.37	5.2	0.47	7.4	0.54	9.7	0.69	14.0	0.92	18.5	1.20
	20	2.9	0.30	3.9	0.38	5.2	0.47	7.4	0.55	9.7	0.70	14.0	0.93	18.5	1.21
	21	2.9	0.30	4.6	0.44	6.8	0.62	9.1	0.69	11.2	0.84	15.4	1.02	19.9	1.33
	23	4.1	0.46	7.1	0.73	9.5	0.91	12.3	0.99	14.2	1.24	18.3	1.51	22.7	1.83
	25	6.5	0.75	9.6	1.07	12.1	1.26	15.4	1.56	17.2	1.80	21.2	2.28	25.4	2.65
	27	8.9	1.10	12.1	1.53	14.8	1.85	18.6	2.33	20.2	2.63	24.1	3.07	28.2	3.47
	29	11.3	1.40	14.6	2.01	17.5	2.52	21.7	3.16	23.2	3.47	27.0	3.94	31.0	4.59
	31	13.7	1.72	17.1	2.51	20.2	3.15	24.9	3.97	26.3	4.21	29.8	4.54	33.7	5.28
	33	16.1	2.31	19.6	3.05	22.9	3.66	27.4	4.61	29.3	4.83	32.8	5.38	36.4	5.94
	35	18.5	3.16	22.1	3.94	25.6	4.77	27.4	5.21	29.3	5.69	32.8	6.70	36.4	7.35
	37	18.5	3.36	22.1	4.17	25.6	5.06	27.4	5.54	29.3	6.06	32.8	7.13	36.4	7.76
	39	18.5	3.57	22.1	4.45	25.6	5.42	27.4	5.97	29.3	6.54	32.8	7.63	36.4	8.36
	41	18.0	3.94	21.6	4.87	25.0	5.94	26.7	6.54	28.5	7.11	31.9	8.39	35.5	9.01
43	17.6	4.29	21.0	5.31	24.3	6.48	26.1	7.13	27.8	7.77	31.1	9.16	34.6	9.75	
46	16.5	4.77	19.7	5.97	22.8	7.30	24.4	7.95	26.1	8.76	29.2	10.33	32.4	10.87	
48	14.6	4.16	17.4	5.22	20.2	6.38	21.6	6.95	23.1	7.66	25.8	9.04	28.7	9.32	
60	10	2.5	0.26	3.4	0.33	4.5	0.41	6.4	0.48	8.4	0.61	12.1	0.80	16.0	1.05
	12	2.5	0.26	3.4	0.33	4.5	0.42	6.4	0.48	8.4	0.61	12.1	0.81	16.0	1.06
	14	2.5	0.27	3.4	0.33	4.5	0.42	6.4	0.49	8.4	0.62	12.1	0.82	16.0	1.07
	16	2.5	0.27	3.4	0.34	4.5	0.42	6.4	0.49	8.4	0.63	12.1	0.83	16.0	1.08
	18	2.5	0.27	3.4	0.34	4.5	0.43	6.4	0.50	8.4	0.63	12.1	0.83	16.0	1.09
	20	2.5	0.28	3.4	0.34	4.5	0.43	6.4	0.50	8.4	0.64	12.1	0.84	16.0	1.10
	21	2.5	0.28	3.4	0.36	5.6	0.55	7.5	0.61	9.6	0.77	13.1	0.93	17.0	1.21
	23	2.5	0.31	5.6	0.65	8.0	0.83	10.4	0.89	12.1	1.13	15.3	1.37	19.1	1.67
	25	4.7	0.58	7.8	0.98	10.3	1.14	13.3	1.51	14.6	1.64	17.7	2.03	21.1	2.41
	27	6.9	0.85	10.0	1.39	12.6	1.69	16.1	2.11	17.1	2.36	19.9	2.69	23.1	3.11
	29	9.1	1.10	12.3	1.78	15.0	2.25	19.0	2.77	19.6	3.00	22.1	3.38	25.1	3.97
	31	11.4	1.40	14.5	2.13	17.3	2.74	21.3	3.32	22.1	3.49	24.8	3.74	27.2	4.58
	33	13.6	1.95	16.7	2.59	19.6	3.07	23.0	3.73	24.6	3.99	26.7	4.43	29.2	5.21
	35	15.8	2.68	18.9	3.28	22.0	3.93	23.5	4.28	25.1	4.65	28.1	5.43	31.2	6.26
	37	15.8	2.83	18.9	3.46	22.0	4.16	23.5	4.55	25.1	4.93	28.1	5.76	31.2	6.66
	39	15.8	3.01	18.9	3.69	22.0	4.49	23.5	4.88	25.1	5.31	28.1	6.18	31.2	7.14
	41	15.4	3.27	18.4	4.03	21.4	4.88	22.9	5.33	24.4	5.76	27.4	6.78	30.4	7.76
43	15.0	3.55	18.0	4.39	20.9	5.32	22.4	5.81	23.8	6.28	26.7	7.40	29.7	8.47	
46	14.1	3.97	16.8	4.93	19.6	5.98	20.9	6.53	22.3	7.07	25.1	8.34	27.8	9.65	
48	12.5	3.46	14.9	4.30	17.3	5.23	18.5	5.70	19.7	6.18	22.2	7.30	24.6	8.45	
50	10	2.3	0.24	3.1	0.30	4.4	0.37	5.8	0.46	7.7	0.55	11.0	0.73	14.6	0.95
	12	2.3	0.24	3.1	0.30	4.4	0.38	5.8	0.46	7.7	0.56	11.0	0.74	14.6	0.96
	14	2.3	0.24	3.1	0.30	4.4	0.38	5.8	0.47	7.7	0.56	11.0	0.74	14.6	0.97
	16	2.3	0.25	3.1	0.31	4.4	0.39	5.8	0.47	7.7	0.57	11.0	0.75	14.6	0.98
	18	2.3	0.25	3.1	0.31	4.4	0.39	5.8	0.48	7.7	0.58	11.0	0.76	14.6	0.99
	20	2.3	0.25	3.1	0.31	4.4	0.39	5.8	0.48	7.7	0.58	11.0	0.77	14.6	1.00
	21	2.3	0.25	3.1	0.32	5.4	0.51	6.9	0.58	8.7	0.70	12.0	0.84	15.4	1.10
	23	2.3	0.27	4.9	0.55	7.5	0.76	9.7	0.90	11.0	1.03	13.8	1.25	17.0	1.51
	25	4.1	0.49	6.7	0.81	9.6	1.06	12.8	1.47	13.6	1.49	15.6	1.76	18.6	2.14
	27	5.9	0.70	8.5	1.14	11.9	1.48	14.9	1.95	15.8	2.01	17.4	2.30	20.2	2.72
	29	7.7	0.92	10.4	1.48	13.8	1.90	16.7	2.42	18.0	2.60	19.3	2.85	21.8	3.43
	31	9.5	1.17	12.2	1.75	15.7	2.31	18.2	2.70	19.2	2.87	21.0	3.08	23.4	3.78
	33	11.4	1.63	14.0	2.11	17.6	2.60	18.9	2.96	20.1	3.18	22.8	3.65	25.0	4.24
	35	13.2	2.23	15.8	2.68	18.3	3.17	19.6	3.44	20.9	3.70	23.4	4.27	26.0	4.91
	37	13.2	2.36	15.8	2.83	18.3	3.35	19.6	3.64	20.9	3.92	23.4	4.56	26.0	5.21
	39	13.2	2.52	15.8	3.04	18.3	3.59	19.6	3.92	20.9	4.21	23.4	4.86	26.0	5.63
	41	12.9	2.73	15.4	3.29	17.9	3.93	19.1	4.24	20.3	4.56	22.8	5.32	25.4	6.11
43	12.6	2.96	15.0	3.58	17.4	4.27	18.6	4.62	19.8	4.96	22.2	5.80	24.7	6.67	
46	11.8	3.32	14.1	4.01	16.3	4.79	17.5	5.18	18.6	5.57	20.8	6.53	23.2	7.51	
48	10.4	2.89	12.5	3.50	14.4	4.18	15.4	4.53	16.4	4.86	18.4	5.71	20.5	6.56	

**Note**

1. TC: Total Capacity(kW), PI : Power Input(kW, Comp. + Outdoor fan motor)
2. Capacity tables show the average value of conditions which may occur.

# 7. Capacity Tables

## ◆ ARUM160LTE5

Cooling Capacity (16HP)

Combination (%)	Outdoor air temp. (DB, °C)	Indoor air temp. (DB/WB, °C)													
		20		23		26		27		28		30		32	
		14	16	16	18	18	19	19	20	20	22	22	24	24	
		TC	PI	TC	PI	TC	PI	TC	PI	TC	PI	TC	PI	TC	PI
130	10	6.3	0.62	8.6	0.78	11.5	0.95	16.2	1.16	21.3	1.44	30.7	1.93	40.7	2.55
	12	6.3	0.63	8.6	0.79	11.5	0.96	16.2	1.17	21.3	1.46	30.7	1.95	40.7	2.58
	14	6.3	0.64	8.6	0.79	11.5	0.97	16.2	1.18	21.3	1.47	30.7	1.97	40.7	2.60
	16	6.3	0.64	8.6	0.80	11.5	0.98	16.2	1.19	21.3	1.49	30.7	1.99	40.7	2.63
	18	6.3	0.65	8.6	0.81	11.5	0.99	16.2	1.20	21.3	1.51	30.7	2.01	40.7	2.66
	20	6.3	0.66	8.6	0.82	11.5	1.00	16.2	1.22	21.3	1.52	30.7	2.03	40.7	2.68
	21	6.3	0.66	8.7	0.84	14.2	1.25	18.9	1.45	23.8	1.87	32.7	2.55	42.0	3.02
	23	11.0	1.18	15.3	1.55	19.7	1.76	24.6	1.96	28.9	2.81	36.7	3.64	44.6	4.28
	25	16.2	1.87	19.6	2.32	25.3	2.64	30.7	3.11	33.9	4.04	40.8	5.28	47.2	6.22
	27	21.1	2.97	25.1	3.51	30.8	3.98	36.5	4.76	38.9	6.04	44.8	7.62	49.9	8.59
	29	26.1	4.13	30.5	4.84	36.3	5.85	42.4	6.89	44.0	8.21	48.9	9.85	52.5	10.97
	31	31.7	5.39	36.7	6.65	42.7	8.07	47.8	9.42	49.0	10.74	51.7	13.50	55.2	13.69
	33	37.2	6.65	43.5	8.68	48.9	10.39	51.6	13.48	52.7	13.39	54.4	13.51	58.1	13.70
	35	44.4	8.98	50.9	10.88	52.5	13.20	53.4	13.27	54.3	13.35	55.7	13.47	57.4	13.52
	37	44.4	9.57	50.1	11.42	51.8	13.03	52.5	13.09	53.4	13.17	54.8	13.29	56.5	13.34
	39	44.4	10.19	49.2	12.02	50.9	12.85	51.8	12.92	52.5	13.00	54.1	13.11	55.7	13.16
41	43.2	10.81	47.2	12.62	48.8	12.68	49.5	12.74	50.5	12.82	52.0	12.93	53.4	12.99	
43	42.2	11.40	45.2	12.44	46.8	12.50	47.5	12.57	48.5	12.64	50.0	12.76	51.3	12.81	
46	39.5	12.21	41.3	12.18	42.8	12.24	43.4	12.30	44.3	12.38	45.7	12.49	47.0	12.54	
48	35.0	11.87	35.8	11.90	37.2	11.93	37.8	11.96	38.6	12.06	39.8	12.14	40.9	12.19	
120	10	5.8	0.58	7.9	0.73	10.6	0.89	14.9	1.08	19.7	1.35	28.3	1.80	37.6	2.39
	12	5.8	0.59	7.9	0.74	10.6	0.90	14.9	1.09	19.7	1.37	28.3	1.82	37.6	2.41
	14	5.8	0.60	7.9	0.74	10.6	0.90	14.9	1.10	19.7	1.38	28.3	1.84	37.6	2.44
	16	5.8	0.60	7.9	0.75	10.6	0.91	14.9	1.12	19.7	1.39	28.3	1.86	37.6	2.46
	18	5.8	0.61	7.9	0.76	10.6	0.92	14.9	1.13	19.7	1.41	28.3	1.88	37.6	2.49
	20	5.8	0.61	7.9	0.77	10.6	0.93	14.9	1.14	19.7	1.42	28.3	1.90	37.6	2.51
	21	5.8	0.62	8.1	0.79	13.4	1.19	17.4	1.36	22.2	1.75	30.3	2.38	38.9	2.83
	23	10.1	1.10	14.5	1.47	19.0	1.69	22.7	1.83	27.5	2.63	34.5	3.40	41.6	4.01
	25	15.7	1.74	20.3	2.21	24.9	2.47	28.3	2.91	33.0	3.78	38.9	4.94	44.3	5.82
	27	21.8	2.76	27.6	3.28	30.9	3.70	33.6	4.42	38.5	5.61	43.3	7.07	47.0	8.10
	29	28.0	3.83	33.3	4.42	36.9	5.43	39.1	6.39	43.9	7.62	47.7	9.14	49.7	10.28
	31	34.0	4.85	40.1	5.85	42.9	7.20	45.0	8.47	49.6	9.66	50.9	11.62	52.7	11.84
	33	39.3	5.98	47.3	7.63	50.1	9.27	50.8	10.75	51.7	12.65	53.1	12.79	54.7	12.89
	35	40.2	7.98	47.7	10.34	50.6	11.44	51.3	13.63	52.2	13.69	53.6	13.73	55.0	13.84
	37	40.2	8.59	47.7	10.91	49.9	12.20	50.6	13.34	51.3	13.41	52.7	13.45	54.1	13.55
	39	40.2	9.24	47.6	11.53	49.0	12.94	49.7	13.06	50.4	13.13	52.0	13.17	53.4	13.27
41	39.1	9.90	45.5	12.15	47.0	12.68	47.7	12.79	48.4	12.85	49.8	12.89	51.2	13.00	
43	38.2	10.57	43.6	11.98	45.1	12.40	45.8	12.52	46.4	12.58	47.8	12.62	49.2	12.72	
46	35.8	11.36	39.7	11.69	41.2	12.01	41.8	12.11	42.4	12.17	43.7	12.20	45.0	12.30	
48	31.6	11.13	34.5	11.49	35.8	11.77	36.3	11.84	36.9	11.88	38.0	11.93	39.2	11.98	
110	10	5.3	0.55	7.3	0.68	9.7	0.83	13.7	1.02	18.0	1.27	25.9	1.69	34.4	2.24
	12	5.3	0.55	7.3	0.69	9.7	0.84	13.7	1.03	18.0	1.28	25.9	1.71	34.4	2.27
	14	5.3	0.56	7.3	0.70	9.7	0.85	13.7	1.04	18.0	1.30	25.9	1.73	34.4	2.29
	16	5.3	0.57	7.3	0.71	9.7	0.86	13.7	1.05	18.0	1.31	25.9	1.75	34.4	2.31
	18	5.3	0.57	7.3	0.71	9.7	0.87	13.7	1.06	18.0	1.32	25.9	1.76	34.4	2.34
	20	5.3	0.58	7.3	0.72	9.7	0.88	13.7	1.07	18.0	1.34	25.9	1.78	34.4	2.36
	21	5.3	0.58	7.3	0.74	12.1	1.10	16.1	1.27	20.1	1.64	28.0	2.24	36.2	2.66
	23	9.5	1.03	12.1	1.38	17.0	1.55	21.0	1.72	25.4	2.47	31.8	3.20	39.3	3.76
	25	13.7	1.64	17.0	2.07	21.9	2.32	25.9	2.73	30.2	3.55	35.6	4.65	42.4	5.47
	27	17.9	2.59	21.9	3.08	26.7	3.47	30.8	4.15	35.2	5.27	39.6	6.65	45.8	7.61
	29	22.1	3.60	26.7	4.15	31.6	5.10	35.7	6.01	40.2	7.16	43.6	8.42	48.4	9.34
	31	26.8	4.56	32.2	5.49	37.2	6.77	40.7	7.96	45.2	9.08	47.7	9.74	50.1	10.48
	33	31.1	5.62	37.2	7.17	42.2	8.71	45.9	9.73	48.8	10.92	50.4	11.22	51.6	11.24
	35	36.0	7.07	42.9	9.10	47.9	10.38	49.3	11.12	50.0	11.80	51.2	11.91	52.6	11.97
	37	36.0	7.50	42.9	9.66	47.9	10.95	48.6	11.78	49.1	12.44	50.5	12.49	51.7	12.52
	39	36.0	8.08	42.9	10.26	47.0	11.56	47.7	12.60	48.4	13.06	49.6	13.08	51.0	13.10
41	35.0	8.67	41.8	10.87	45.0	12.19	45.7	13.63	46.3	13.63	47.7	13.73	48.9	13.84	
43	34.2	9.10	40.7	11.32	43.1	12.92	43.8	13.07	44.4	13.04	45.7	13.12	46.9	13.15	
46	32.0	8.88	38.2	10.93	39.4	12.27	40.0	12.27	40.6	12.37	41.8	12.44	42.9	12.47	
48	28.3	8.63	33.2	10.53	34.2	11.67	34.8	11.75	35.3	11.80	36.4	11.84	37.3	11.89	



# 7. Capacity Tables

Cooling Capacity (16HP)

Combination (%)	Outdoor air temp. (DB, °C)	Indoor air temp. (DB/WB, °C)													
		20		23		26		27		28		30		32	
		14		16		18		19		20		22		24	
		TC	PI	TC	PI	TC	PI	TC	PI	TC	PI	TC	PI	TC	PI
100	10	4.9	0.50	6.7	0.63	8.9	0.76	12.5	0.93	16.5	1.16	23.8	1.55	31.6	2.06
	12	4.9	0.51	6.7	0.63	8.9	0.77	12.5	0.94	16.5	1.18	23.8	1.57	31.6	2.08
	14	4.9	0.51	6.7	0.64	8.9	0.78	12.5	0.95	16.5	1.19	23.8	1.59	31.6	2.10
	16	4.9	0.52	6.7	0.65	8.9	0.79	12.5	0.96	16.5	1.20	23.8	1.60	31.6	2.12
	18	4.9	0.52	6.7	0.65	8.9	0.80	12.5	0.97	16.5	1.21	23.8	1.62	31.6	2.14
	20	4.9	0.53	6.7	0.66	8.9	0.80	12.5	0.98	16.5	1.23	23.8	1.64	31.6	2.17
	21	4.9	0.53	6.7	0.68	11.1	1.00	14.7	1.17	18.8	1.51	25.7	2.06	33.2	2.44
	23	8.5	0.95	11.7	1.27	15.5	1.42	19.4	1.58	23.5	2.27	29.5	2.93	36.4	3.45
	25	12.1	1.50	15.7	1.90	19.9	2.13	24.2	2.51	28.2	3.26	33.2	4.26	39.6	5.01
	27	15.7	2.38	19.8	2.83	24.3	3.19	28.7	3.81	32.9	4.84	37.0	6.10	42.8	6.98
	29	19.3	3.30	23.9	3.81	28.7	4.68	33.4	5.51	37.6	6.57	40.8	7.88	46.0	8.57
	31	23.0	4.18	28.0	5.04	33.1	6.21	38.1	7.30	42.2	8.33	44.6	9.11	49.6	9.71
	33	26.6	5.15	32.0	6.58	37.5	7.99	42.7	9.27	47.0	10.12	48.4	10.30	49.6	10.52
	35	30.2	6.20	36.0	7.92	41.9	9.85	44.8	10.90	47.0	10.97	48.4	11.01	49.6	11.10
	37	30.2	6.65	36.0	8.50	41.9	10.43	44.8	11.42	46.2	11.48	47.5	11.52	48.6	11.63
	39	30.2	7.12	36.0	9.13	41.9	11.05	44.8	11.98	45.4	12.03	46.7	12.08	47.8	12.19
41	29.8	7.60	35.4	9.76	41.3	11.67	43.0	12.54	43.9	12.59	45.0	12.63	46.4	12.75	
43	28.7	8.05	34.2	10.34	39.8	12.23	41.2	13.01	41.7	13.06	43.0	13.10	44.1	13.23	
46	26.9	8.66	32.1	11.15	37.3	12.97	37.6	13.63	38.0	13.66	39.3	13.70	40.3	13.83	
48	23.8	7.47	28.4	9.65	32.2	11.09	32.7	11.56	33.0	11.60	34.1	11.62	35.1	11.72	
90	10	4.4	0.46	6.0	0.58	8.0	0.73	11.1	0.83	14.9	1.07	21.4	1.41	28.4	1.85
	12	4.4	0.47	6.0	0.58	8.0	0.73	11.1	0.84	14.9	1.08	21.4	1.43	28.4	1.87
	14	4.4	0.47	6.0	0.59	8.0	0.74	11.1	0.85	14.9	1.09	21.4	1.44	28.4	1.89
	16	4.4	0.48	6.0	0.60	8.0	0.75	11.1	0.86	14.9	1.11	21.4	1.46	28.4	1.91
	18	4.4	0.48	6.0	0.60	8.0	0.76	11.1	0.86	14.9	1.12	21.4	1.47	28.4	1.93
	20	4.4	0.49	6.0	0.61	8.0	0.76	11.1	0.87	14.9	1.13	21.4	1.49	28.4	1.95
	21	4.4	0.49	6.0	0.61	10.0	0.96	13.1	1.03	16.8	1.35	23.1	1.64	29.9	2.14
	23	6.0	0.76	8.8	1.06	14.0	1.36	17.0	1.49	20.5	1.99	26.6	2.43	32.9	2.95
	25	9.5	1.29	12.8	1.69	18.0	2.02	20.9	2.35	24.2	2.90	30.1	3.67	36.0	4.26
	27	13.0	1.89	16.7	2.41	21.9	3.14	24.8	3.49	28.0	4.23	33.5	4.93	39.0	5.58
	29	16.6	2.55	20.7	3.31	25.9	4.37	28.7	4.83	31.7	5.58	37.0	6.33	42.0	7.38
	31	20.1	3.19	24.6	4.25	29.9	5.47	32.5	6.16	35.5	6.96	40.4	7.37	45.1	8.58
	33	23.6	4.11	28.5	5.23	33.9	6.63	36.4	7.31	39.2	8.09	43.9	8.74	48.1	9.58
	35	27.2	5.09	32.5	6.44	37.8	7.96	40.3	8.78	42.9	9.55	47.3	10.24	48.1	10.48
	37	27.2	5.41	32.5	6.85	37.8	8.49	40.3	9.33	42.9	10.08	46.6	10.71	47.4	10.95
	39	27.2	5.72	32.5	7.29	37.8	8.99	40.3	9.93	42.9	10.60	45.8	11.29	46.6	11.43
41	26.5	6.40	31.6	8.08	36.8	9.86	39.3	10.86	41.8	11.44	43.9	11.90	44.7	12.17	
43	25.8	6.91	30.9	8.73	35.9	10.77	38.3	11.69	40.7	12.27	42.1	12.71	42.9	12.89	
46	24.2	7.78	28.9	9.94	33.6	12.28	35.9	13.26	37.0	13.63	38.4	13.70	39.1	13.83	
48	21.4	6.80	25.6	8.70	29.7	10.74	31.8	11.56	32.2	11.60	33.4	11.62	34.0	11.72	
80	10	3.8	0.41	5.1	0.51	6.8	0.64	9.7	0.74	12.7	0.95	18.3	1.25	24.3	1.64
	12	3.8	0.41	5.1	0.52	6.8	0.65	9.7	0.75	12.7	0.96	18.3	1.26	24.3	1.65
	14	3.8	0.42	5.1	0.52	6.8	0.66	9.7	0.75	12.7	0.97	18.3	1.28	24.3	1.67
	16	3.8	0.42	5.1	0.53	6.8	0.66	9.7	0.76	12.7	0.98	18.3	1.29	24.3	1.69
	18	3.8	0.43	5.1	0.53	6.8	0.67	9.7	0.77	12.7	0.99	18.3	1.30	24.3	1.71
	20	3.8	0.43	5.1	0.54	6.8	0.68	9.7	0.78	12.7	1.00	18.3	1.32	24.3	1.72
	21	3.8	0.43	5.1	0.55	8.6	0.85	11.5	0.93	14.4	1.20	19.9	1.45	25.8	1.89
	23	6.7	0.80	8.5	0.95	12.1	1.21	15.3	1.34	17.8	1.76	23.2	2.14	28.9	2.61
	25	9.6	1.16	11.9	1.52	15.7	1.79	19.0	2.11	21.2	2.56	26.5	3.24	31.9	3.77
	27	12.5	1.70	15.3	2.17	19.2	2.77	22.7	3.14	24.6	3.74	29.7	4.36	34.9	4.93
	29	15.4	2.21	18.7	2.98	22.7	3.86	26.4	4.35	28.0	4.94	33.0	5.60	38.0	6.53
	31	18.3	2.70	22.0	3.75	26.3	4.84	30.2	5.55	32.1	5.98	36.3	6.45	41.0	7.51
	33	21.2	3.55	25.4	4.62	29.8	5.68	33.9	6.58	35.9	6.87	39.5	7.65	44.0	8.45
	35	24.2	4.65	28.8	5.83	33.4	7.15	35.8	7.86	38.2	8.60	42.9	9.76	47.0	10.16
	37	24.2	4.92	28.8	6.20	33.4	7.59	35.8	8.35	38.2	9.14	42.9	10.30	46.3	10.68
	39	24.2	5.20	28.8	6.55	33.4	8.12	35.8	8.98	38.2	9.82	42.9	10.88	45.5	11.26
41	23.5	5.75	28.1	7.26	32.6	8.91	34.9	9.84	37.3	10.79	41.8	11.66	43.6	11.93	
43	23.0	6.33	27.4	7.93	31.8	9.72	34.1	10.73	36.3	11.79	40.7	12.46	41.8	12.77	
46	21.5	7.05	25.6	8.93	29.8	10.96	31.9	11.94	34.1	13.31	37.3	13.70	38.1	13.83	
48	19.0	6.15	22.7	7.81	26.3	9.58	28.2	10.43	30.1	11.60	32.4	11.62	33.1	11.72	

# 7. Capacity Tables

Cooling Capacity (16HP)

Combination (%)	Outdoor air temp. (DB, °C)	Indoor air temp. (DB/WB, °C)													
		20		23		26		27		28		30		32	
		14		16		18		19		20		22		24	
		TC	PI	TC	PI	TC	PI	TC	PI	TC	PI	TC	PI	TC	PI
70	10	3.3	0.36	4.5	0.45	6.0	0.57	8.4	0.66	11.1	0.84	15.9	1.10	21.2	1.45
	12	3.3	0.37	4.5	0.46	6.0	0.57	8.4	0.66	11.1	0.85	15.9	1.12	21.2	1.46
	14	3.3	0.37	4.5	0.46	6.0	0.58	8.4	0.67	11.1	0.86	15.9	1.13	21.2	1.48
	16	3.3	0.37	4.5	0.47	6.0	0.59	8.4	0.68	11.1	0.86	15.9	1.14	21.2	1.49
	18	3.3	0.38	4.5	0.47	6.0	0.59	8.4	0.68	11.1	0.87	15.9	1.15	21.2	1.51
	20	3.3	0.38	4.5	0.48	6.0	0.60	8.4	0.69	11.1	0.88	15.9	1.16	21.2	1.52
	21	3.3	0.38	5.2	0.56	7.7	0.78	10.4	0.87	12.8	1.06	17.6	1.28	22.8	1.68
	23	4.7	0.58	8.1	0.91	10.8	1.15	14.0	1.24	16.2	1.55	20.9	1.90	25.9	2.30
	25	7.4	0.95	10.9	1.35	13.9	1.58	17.6	1.97	19.7	2.27	24.2	2.86	29.1	3.33
	27	10.2	1.38	13.8	1.92	17.0	2.33	21.2	2.92	23.1	3.31	27.5	3.86	32.2	4.36
	29	12.9	1.75	16.6	2.53	20.0	3.17	24.8	3.98	26.6	4.36	30.8	4.95	35.4	5.77
	31	15.7	2.16	19.5	3.15	23.1	3.96	28.4	5.00	30.0	5.29	34.1	5.71	38.5	6.64
	33	18.4	2.90	22.4	3.83	26.2	4.60	31.4	5.80	33.4	6.08	37.4	6.76	41.6	7.47
	35	21.1	3.97	25.3	4.95	29.3	5.99	31.4	6.55	33.4	7.16	37.4	8.43	41.6	9.24
	37	21.1	4.22	25.3	5.25	29.3	6.37	31.4	6.97	33.4	7.62	37.4	8.97	41.6	9.75
	39	21.1	4.49	25.3	5.59	29.3	6.81	31.4	7.50	33.4	8.23	37.4	9.60	41.6	10.51
	41	20.6	4.96	24.6	6.13	28.5	7.47	30.6	8.23	32.6	8.94	36.5	10.54	40.5	11.33
43	20.1	5.40	24.0	6.68	27.8	8.15	29.8	8.97	31.8	9.77	35.6	11.52	39.5	12.26	
46	18.8	6.00	22.5	7.51	26.1	9.18	27.9	9.99	29.8	11.01	33.3	12.99	37.0	13.67	
48	16.6	5.24	19.9	6.56	23.1	8.02	24.7	8.73	26.3	9.63	29.5	11.37	32.8	11.72	
60	10	2.9	0.32	3.9	0.40	5.2	0.50	7.3	0.59	9.6	0.74	13.8	0.98	18.3	1.29
	12	2.9	0.32	3.9	0.41	5.2	0.51	7.3	0.59	9.6	0.75	13.8	0.99	18.3	1.30
	14	2.9	0.33	3.9	0.41	5.2	0.51	7.3	0.60	9.6	0.76	13.8	1.00	18.3	1.31
	16	2.9	0.33	3.9	0.41	5.2	0.52	7.3	0.61	9.6	0.77	13.8	1.01	18.3	1.33
	18	2.9	0.33	3.9	0.42	5.2	0.53	7.3	0.61	9.6	0.78	13.8	1.02	18.3	1.34
	20	2.9	0.34	3.9	0.42	5.2	0.53	7.3	0.62	9.6	0.78	13.8	1.03	18.3	1.35
	21	2.9	0.34	3.9	0.44	6.5	0.68	8.5	0.75	11.0	0.94	15.0	1.14	19.5	1.49
	23	2.9	0.38	6.4	0.79	9.1	1.02	11.8	1.09	13.9	1.38	17.4	1.68	21.8	2.05
	25	5.4	0.72	8.9	1.20	11.8	1.40	15.2	1.86	16.7	2.01	20.3	2.49	24.1	2.96
	27	7.9	1.04	11.5	1.70	14.4	2.07	18.4	2.59	19.6	2.89	22.8	3.30	26.4	3.81
	29	10.4	1.35	14.0	2.18	17.1	2.76	21.7	3.40	22.4	3.68	25.3	4.14	28.7	4.87
	31	13.0	1.72	16.5	2.61	19.8	3.36	24.4	4.08	25.3	4.28	28.3	4.59	31.0	5.61
	33	15.5	2.40	19.1	3.17	22.4	3.77	26.3	4.57	28.2	4.90	30.6	5.44	33.3	6.39
	35	18.1	3.37	21.6	4.13	25.1	4.94	26.9	5.38	28.6	5.84	32.2	6.83	35.7	7.87
	37	18.1	3.56	21.6	4.35	25.1	5.24	26.9	5.72	28.6	6.20	32.2	7.25	35.7	8.38
	39	18.1	3.79	21.6	4.64	25.1	5.65	26.9	6.13	28.6	6.67	32.2	7.77	35.7	8.98
	41	17.6	4.11	21.0	5.07	24.5	6.14	26.2	6.70	27.9	7.24	31.3	8.53	34.8	9.75
43	17.2	4.46	20.5	5.52	23.9	6.69	25.5	7.30	27.2	7.90	30.6	9.31	33.9	10.65	
46	16.1	5.00	19.2	6.20	22.4	7.52	23.9	8.21	25.5	8.88	28.6	10.49	31.8	12.14	
48	14.2	4.35	17.0	5.41	19.8	6.57	21.2	7.17	22.6	7.76	25.3	9.17	28.1	10.62	
50	10	2.6	0.29	3.5	0.36	5.0	0.45	6.6	0.55	8.8	0.66	12.6	0.87	16.7	1.14
	12	2.6	0.29	3.5	0.36	5.0	0.45	6.6	0.56	8.8	0.67	12.6	0.88	16.7	1.15
	14	2.6	0.29	3.5	0.36	5.0	0.46	6.6	0.56	8.8	0.67	12.6	0.89	16.7	1.16
	16	2.6	0.29	3.5	0.37	5.0	0.46	6.6	0.57	8.8	0.68	12.6	0.90	16.7	1.17
	18	2.6	0.30	3.5	0.37	5.0	0.47	6.6	0.57	8.8	0.69	12.6	0.91	16.7	1.18
	20	2.6	0.30	3.5	0.38	5.0	0.47	6.6	0.58	8.8	0.70	12.6	0.92	16.7	1.20
	21	2.6	0.30	3.5	0.39	6.2	0.60	7.8	0.69	10.0	0.84	13.7	1.01	17.6	1.32
	23	2.6	0.32	5.6	0.66	8.6	0.90	11.1	1.08	12.6	1.23	15.8	1.50	19.5	1.81
	25	4.7	0.59	7.7	0.97	11.0	1.27	14.7	1.76	15.5	1.79	17.8	2.11	21.3	2.56
	27	6.7	0.84	9.8	1.37	13.6	1.77	17.0	2.34	18.0	2.41	19.9	2.76	23.1	3.25
	29	8.8	1.10	11.8	1.77	15.8	2.27	19.1	2.90	20.5	3.11	22.0	3.41	24.9	4.11
	31	10.9	1.40	13.9	2.10	17.9	2.77	20.8	3.24	22.0	3.44	24.0	3.69	26.8	4.52
	33	13.0	1.95	16.0	2.53	20.1	3.11	21.6	3.55	22.9	3.80	26.0	4.37	28.6	5.08
	35	15.1	2.80	18.1	3.37	21.0	3.98	22.4	4.32	23.8	4.66	26.7	5.37	29.8	6.17
	37	15.1	2.97	18.1	3.56	21.0	4.21	22.4	4.57	23.8	4.93	26.7	5.73	29.8	6.55
	39	15.1	3.17	18.1	3.82	21.0	4.52	22.4	4.92	23.8	5.29	26.7	6.10	29.8	7.08
	41	14.7	3.43	17.6	4.13	20.4	4.94	21.8	5.33	23.2	5.73	26.0	6.69	29.0	7.69
43	14.4	3.72	17.2	4.49	19.9	5.37	21.3	5.80	22.7	6.24	25.4	7.30	28.3	8.39	
46	13.5	4.17	16.1	5.04	18.7	6.03	19.9	6.52	21.2	7.01	23.8	8.21	26.5	9.44	
48	11.9	3.64	14.2	4.40	16.5	5.26	17.6	5.69	18.8	6.11	21.1	7.17	23.4	8.25	

**Note**

1. TC: Total Capacity(kW), PI : Power Input(kW, Comp. + Outdoor fan motor)
2. Capacity tables show the average value of conditions which may occur.

# 7. Capacity Tables

## ◆ ARUM180LTE5

Cooling Capacity (18HP)

Combination (%)	Outdoor air temp. (DB, °C)	Indoor air temp. (DB/WB, °C)													
		20		23		26		27		28		30		32	
		14	16	16	18	18	19	19	20	20	22	22	24	24	
		TC	PI	TC	PI	TC	PI	TC	PI	TC	PI	TC	PI	TC	PI
130	10	7.1	0.63	9.7	0.79	12.9	0.96	18.2	1.17	24.0	1.46	34.5	1.95	45.8	2.58
	12	7.1	0.64	9.7	0.80	12.9	0.97	18.2	1.18	24.0	1.48	34.5	1.97	45.8	2.61
	14	7.1	0.64	9.7	0.80	12.9	0.98	18.2	1.19	24.0	1.49	34.5	1.99	45.8	2.64
	16	7.1	0.65	9.7	0.81	12.9	0.99	18.2	1.21	24.0	1.51	34.5	2.01	45.8	2.66
	18	7.1	0.66	9.7	0.82	12.9	1.00	18.2	1.22	24.0	1.52	34.5	2.03	45.8	2.69
	20	7.1	0.66	9.7	0.83	12.9	1.01	18.2	1.23	24.0	1.54	34.5	2.05	45.8	2.72
	21	7.1	0.67	9.8	0.85	16.0	1.26	21.2	1.47	26.8	1.89	36.8	2.58	47.3	3.06
	23	12.3	1.19	17.2	1.57	22.2	1.78	27.7	1.98	32.5	2.85	41.3	3.68	50.2	4.33
	25	18.2	1.89	22.1	2.35	28.4	2.67	34.6	3.15	38.1	4.09	45.9	5.35	53.2	6.29
	27	23.8	3.01	28.2	3.55	34.7	4.03	41.1	4.82	43.8	6.12	50.5	7.71	56.1	8.69
	29	29.3	4.18	34.4	4.90	40.9	5.92	47.7	6.97	49.4	8.31	55.1	9.97	59.1	11.10
	31	35.6	5.46	41.3	6.73	48.1	8.17	53.7	9.53	55.1	10.87	58.1	13.66	62.1	13.85
	33	41.9	6.72	49.0	8.78	55.0	10.51	58.1	13.65	59.3	13.55	61.2	13.67	65.3	13.86
	35	49.9	9.08	57.2	11.01	59.0	13.36	60.1	13.43	61.0	13.51	62.7	13.63	64.5	13.68
	37	49.9	9.69	56.4	11.55	58.2	13.18	59.0	13.25	60.1	13.33	61.7	13.45	63.5	13.50
	39	49.9	10.31	55.4	12.16	57.2	13.01	58.2	13.07	59.0	13.15	60.9	13.27	62.7	13.32
41	48.6	10.94	53.1	12.77	54.9	12.83	55.7	12.90	56.8	12.97	58.5	13.09	60.1	13.14	
43	47.4	11.54	50.9	12.59	52.7	12.65	53.5	12.72	54.5	12.79	56.2	12.91	57.7	12.96	
46	44.5	12.35	46.4	12.33	48.1	12.39	48.9	12.45	49.9	12.53	51.4	12.64	52.9	12.69	
48	39.3	12.01	40.3	12.04	41.8	12.07	42.5	12.10	43.4	12.21	44.8	12.28	46.0	12.33	
120	10	6.5	0.59	8.9	0.74	11.9	0.90	16.8	1.09	22.1	1.37	31.9	1.82	42.3	2.41
	12	6.5	0.60	8.9	0.74	11.9	0.91	16.8	1.11	22.1	1.38	31.9	1.84	42.3	2.44
	14	6.5	0.60	8.9	0.75	11.9	0.92	16.8	1.12	22.1	1.40	31.9	1.86	42.3	2.47
	16	6.5	0.61	8.9	0.76	11.9	0.93	16.8	1.13	22.1	1.41	31.9	1.88	42.3	2.49
	18	6.5	0.62	8.9	0.77	11.9	0.93	16.8	1.14	22.1	1.43	31.9	1.90	42.3	2.52
	20	6.5	0.62	8.9	0.78	11.9	0.94	16.8	1.15	22.1	1.44	31.9	1.92	42.3	2.54
	21	6.5	0.63	9.1	0.80	15.1	1.20	19.6	1.37	25.0	1.77	34.1	2.41	43.8	2.86
	23	11.3	1.11	16.3	1.49	21.4	1.71	25.5	1.86	31.0	2.66	38.8	3.44	46.8	4.05
	25	17.7	1.77	22.9	2.23	28.0	2.50	31.8	2.94	37.1	3.83	43.8	5.00	49.9	5.89
	27	24.6	2.79	31.1	3.32	34.8	3.74	37.8	4.47	43.3	5.68	48.7	7.16	52.9	8.20
	29	31.5	3.87	37.4	4.47	41.5	5.49	44.0	6.47	49.4	7.71	53.7	9.25	56.0	10.40
	31	38.2	4.91	45.1	5.92	48.2	7.29	50.6	8.57	55.8	9.78	57.3	11.76	59.2	11.98
	33	44.3	6.05	53.2	7.72	56.3	9.38	57.1	10.88	58.1	12.80	59.7	12.94	61.6	13.05
	35	45.2	8.08	53.7	10.46	56.9	11.58	57.7	13.79	58.7	13.86	60.3	13.90	61.9	14.01
	37	45.2	8.69	53.7	11.04	56.1	12.34	56.9	13.50	57.7	13.57	59.3	13.61	60.9	13.71
	39	45.2	9.36	53.5	11.67	55.1	13.09	55.9	13.22	56.7	13.29	58.5	13.33	60.1	13.43
41	44.0	10.02	51.2	12.30	52.9	12.83	53.7	12.94	54.4	13.01	56.0	13.05	57.6	13.15	
43	42.9	10.70	49.0	12.12	50.7	12.54	51.5	12.67	52.2	12.73	53.8	12.77	55.3	12.87	
46	40.2	11.50	44.7	11.83	46.3	12.15	47.0	12.25	47.7	12.31	49.2	12.35	50.6	12.45	
48	35.6	11.27	38.8	11.62	40.3	11.91	40.9	11.99	41.5	12.02	42.8	12.07	44.1	12.12	
110	10	6.0	0.55	8.2	0.69	10.9	0.84	15.4	1.03	20.3	1.28	29.2	1.71	38.7	2.27
	12	6.0	0.56	8.2	0.70	10.9	0.85	15.4	1.04	20.3	1.30	29.2	1.73	38.7	2.29
	14	6.0	0.57	8.2	0.71	10.9	0.86	15.4	1.05	20.3	1.31	29.2	1.75	38.7	2.32
	16	6.0	0.57	8.2	0.71	10.9	0.87	15.4	1.06	20.3	1.33	29.2	1.77	38.7	2.34
	18	6.0	0.58	8.2	0.72	10.9	0.88	15.4	1.07	20.3	1.34	29.2	1.79	38.7	2.36
	20	6.0	0.58	8.2	0.73	10.9	0.89	15.4	1.08	20.3	1.35	29.2	1.80	38.7	2.39
	21	6.0	0.59	8.2	0.75	13.7	1.11	18.1	1.29	22.6	1.66	31.5	2.27	40.7	2.69
	23	10.7	1.05	13.7	1.40	19.1	1.57	23.6	1.74	28.6	2.50	35.8	3.23	44.2	3.81
	25	15.4	1.66	19.1	2.10	24.6	2.35	29.1	2.77	33.9	3.59	40.0	4.70	47.7	5.53
	27	20.2	2.62	24.6	3.12	30.1	3.51	34.6	4.20	39.6	5.33	44.6	6.72	51.6	7.70
	29	24.9	3.64	30.1	4.20	35.6	5.16	40.2	6.08	45.2	7.24	49.1	8.52	54.4	9.45
	31	30.2	4.61	36.3	5.56	41.8	6.85	45.8	8.06	50.8	9.19	53.6	9.85	56.4	10.61
	33	35.0	5.68	41.8	7.25	47.4	8.81	51.7	9.85	55.0	11.05	56.7	11.36	58.1	11.37
	35	40.5	7.16	48.2	9.21	53.9	10.50	55.4	11.25	56.2	11.94	57.6	12.05	59.1	12.11
	37	40.5	7.59	48.2	9.77	53.9	11.08	54.7	11.92	55.2	12.59	56.8	12.64	58.2	12.67
	39	40.5	8.18	48.2	10.39	52.9	11.70	53.7	12.75	54.5	13.22	55.8	13.24	57.4	13.25
41	39.4	8.77	47.0	11.00	50.6	12.33	51.4	13.79	52.1	13.79	53.6	13.90	55.0	14.01	
43	38.5	9.21	45.8	11.46	48.5	13.08	49.3	13.23	50.0	13.20	51.5	13.27	52.8	13.31	
46	36.0	8.99	43.0	11.06	44.3	12.41	45.1	12.41	45.6	12.52	47.0	12.59	48.3	12.62	
48	31.9	8.73	37.3	10.66	38.5	11.81	39.2	11.89	39.7	11.95	40.9	11.98	42.0	12.03	

# 7. Capacity Tables

Cooling Capacity (18HP)

Combination (%)	Outdoor air temp. (DB, °C)	Indoor air temp. (DB/WB, °C)													
		20		23		26		27		28		30		32	
		14		16		18		19		20		22		24	
		TC	PI	TC	PI	TC	PI	TC	PI	TC	PI	TC	PI	TC	PI
100	10	5.5	0.51	7.5	0.64	10.0	0.77	14.1	0.94	18.6	1.18	26.8	1.57	35.5	2.08
	12	5.5	0.51	7.5	0.64	10.0	0.78	14.1	0.95	18.6	1.19	26.8	1.59	35.5	2.10
	14	5.5	0.52	7.5	0.65	10.0	0.79	14.1	0.96	18.6	1.20	26.8	1.61	35.5	2.13
	16	5.5	0.52	7.5	0.66	10.0	0.80	14.1	0.97	18.6	1.22	26.8	1.62	35.5	2.15
	18	5.5	0.53	7.5	0.66	10.0	0.81	14.1	0.98	18.6	1.23	26.8	1.64	35.5	2.17
	20	5.5	0.54	7.5	0.67	10.0	0.81	14.1	0.99	18.6	1.24	26.8	1.65	35.5	2.19
	21	5.5	0.54	7.5	0.69	12.5	1.02	16.6	1.18	21.2	1.52	28.9	2.08	37.3	2.47
	23	9.5	0.96	13.1	1.28	17.4	1.44	21.8	1.60	26.5	2.29	33.2	2.97	41.0	3.50
	25	13.6	1.52	17.7	1.93	22.4	2.15	27.2	2.54	31.7	3.30	37.4	4.31	44.6	5.07
	27	17.7	2.41	22.3	2.86	27.3	3.22	32.3	3.86	37.0	4.89	41.6	6.17	48.2	7.06
	29	21.8	3.34	26.9	3.86	32.3	4.73	37.6	5.58	42.2	6.65	45.9	7.98	51.8	8.67
	31	25.8	4.23	31.4	5.10	37.3	6.28	42.8	7.39	47.5	8.43	50.1	9.22	55.8	9.83
	33	29.9	5.21	36.0	6.65	42.2	8.08	48.1	9.38	52.8	10.24	54.5	10.42	55.8	10.65
	35	34.0	6.28	40.5	8.02	47.2	9.96	50.4	11.03	52.8	11.10	54.5	11.14	55.8	11.23
	37	34.0	6.72	40.5	8.60	47.2	10.55	50.4	11.56	52.0	11.61	53.4	11.66	54.7	11.77
	39	34.0	7.21	40.5	9.24	47.2	11.18	50.4	12.12	51.1	12.17	52.6	12.22	53.8	12.33
41	33.5	7.69	39.9	9.87	46.4	11.81	48.4	12.68	49.4	12.74	50.6	12.78	52.2	12.90	
43	32.3	8.14	38.5	10.47	44.8	12.38	46.4	13.17	46.9	13.22	48.4	13.26	49.6	13.38	
46	30.3	8.76	36.1	11.28	42.0	13.13	42.3	13.79	42.8	13.83	44.2	13.87	45.4	14.00	
48	26.8	7.56	31.9	9.76	36.3	11.22	36.8	11.70	37.2	11.74	38.4	11.76	39.4	11.86	
90	10	4.9	0.47	6.7	0.58	9.0	0.73	12.4	0.84	16.7	1.08	24.1	1.43	32.0	1.87
	12	4.9	0.47	6.7	0.59	9.0	0.74	12.4	0.85	16.7	1.10	24.1	1.45	32.0	1.89
	14	4.9	0.48	6.7	0.60	9.0	0.75	12.4	0.86	16.7	1.11	24.1	1.46	32.0	1.91
	16	4.9	0.48	6.7	0.60	9.0	0.76	12.4	0.87	16.7	1.12	24.1	1.48	32.0	1.93
	18	4.9	0.49	6.7	0.61	9.0	0.77	12.4	0.87	16.7	1.13	24.1	1.49	32.0	1.95
	20	4.9	0.49	6.7	0.62	9.0	0.77	12.4	0.88	16.7	1.14	24.1	1.51	32.0	1.97
	21	4.9	0.50	6.7	0.62	11.3	0.97	14.7	1.05	18.9	1.37	26.0	1.66	33.6	2.17
	23	6.7	0.77	9.9	1.07	15.8	1.38	19.1	1.50	23.1	2.01	29.9	2.45	37.1	2.98
	25	10.7	1.30	14.4	1.71	20.2	2.04	23.5	2.38	27.3	2.94	33.8	3.71	40.5	4.31
	27	14.7	1.91	18.8	2.44	24.7	3.17	27.9	3.54	31.5	4.28	37.7	4.99	43.9	5.64
	29	18.6	2.58	23.2	3.35	29.2	4.42	32.2	4.89	35.7	5.65	41.6	6.41	47.3	7.47
	31	22.6	3.23	27.7	4.30	33.6	5.53	36.6	6.24	39.9	7.04	45.5	7.46	50.7	8.68
	33	26.6	4.16	32.1	5.30	38.1	6.71	41.0	7.40	44.1	8.18	49.4	8.84	54.2	9.70
	35	30.6	5.15	36.5	6.52	42.5	8.06	45.4	8.89	48.2	9.66	53.2	10.37	54.2	10.60
	37	30.6	5.47	36.5	6.93	42.5	8.59	45.4	9.44	48.2	10.20	52.4	10.84	53.3	11.08
	39	30.6	5.79	36.5	7.37	42.5	9.09	45.4	10.05	48.2	10.73	51.5	11.42	52.4	11.56
41	29.8	6.48	35.6	8.17	41.4	9.98	44.2	10.99	47.0	11.58	49.4	12.04	50.3	12.32	
43	29.1	7.00	34.7	8.83	40.4	10.90	43.1	11.83	45.8	12.42	47.3	12.86	48.2	13.05	
46	27.3	7.87	32.5	10.06	37.8	12.42	40.4	13.42	41.7	13.79	43.2	13.87	44.0	14.00	
48	24.1	6.88	28.8	8.80	33.5	10.87	35.7	11.70	36.2	11.74	37.6	11.76	38.3	11.86	
80	10	4.2	0.41	5.8	0.52	7.7	0.65	10.9	0.75	14.3	0.96	20.6	1.26	27.3	1.66
	12	4.2	0.42	5.8	0.52	7.7	0.66	10.9	0.75	14.3	0.97	20.6	1.28	27.3	1.67
	14	4.2	0.42	5.8	0.53	7.7	0.66	10.9	0.76	14.3	0.98	20.6	1.29	27.3	1.69
	16	4.2	0.43	5.8	0.53	7.7	0.67	10.9	0.77	14.3	0.99	20.6	1.30	27.3	1.71
	18	4.2	0.43	5.8	0.54	7.7	0.68	10.9	0.78	14.3	1.00	20.6	1.32	27.3	1.73
	20	4.2	0.44	5.8	0.54	7.7	0.68	10.9	0.79	14.3	1.01	20.6	1.33	27.3	1.74
	21	4.2	0.44	5.8	0.56	9.7	0.86	13.0	0.94	16.2	1.21	22.4	1.46	29.1	1.92
	23	7.5	0.81	9.6	0.96	13.6	1.22	17.2	1.35	20.1	1.78	26.1	2.17	32.5	2.64
	25	10.8	1.17	13.4	1.54	17.6	1.81	21.4	2.14	23.9	2.59	29.8	3.28	35.9	3.81
	27	14.1	1.72	17.2	2.20	21.6	2.80	25.5	3.18	27.7	3.78	33.5	4.41	39.3	4.99
	29	17.3	2.23	21.0	3.02	25.6	3.91	29.7	4.40	31.6	4.99	37.1	5.67	42.7	6.60
	31	20.6	2.74	24.8	3.80	29.6	4.89	33.9	5.61	36.1	6.05	40.8	6.53	46.1	7.60
	33	23.9	3.60	28.6	4.67	33.6	5.75	38.2	6.66	40.4	6.96	44.5	7.74	49.5	8.55
	35	27.2	4.71	32.4	5.90	37.6	7.24	40.3	7.95	43.0	8.70	48.2	9.88	52.9	10.29
	37	27.2	4.98	32.4	6.27	37.6	7.68	40.3	8.45	43.0	9.25	48.2	10.42	52.0	10.80
	39	27.2	5.26	32.4	6.63	37.6	8.21	40.3	9.09	43.0	9.94	48.2	11.01	51.2	11.40
41	26.5	5.82	31.6	7.35	36.7	9.01	39.3	9.96	41.9	10.92	47.0	11.80	49.0	12.07	
43	25.8	6.41	30.8	8.02	35.8	9.84	38.3	10.86	40.9	11.93	45.8	12.60	47.0	12.92	
46	24.2	7.13	28.9	9.03	33.5	11.09	35.9	12.08	38.3	13.47	41.9	13.87	42.9	14.00	
48	21.4	6.23	25.5	7.90	29.6	9.70	31.8	10.55	33.9	11.74	36.4	11.76	37.3	11.86	

# 7. Capacity Tables

Cooling Capacity (18HP)

Combination (%)	Outdoor air temp. (DB, °C)	Indoor air temp. (DB/WB, °C)													
		20		23		26		27		28		30		32	
		14		16		18		19		20		22		24	
		TC	PI	TC	PI	TC	PI	TC	PI	TC	PI	TC	PI	TC	PI
70	10	3.7	0.37	5.0	0.46	6.7	0.57	9.5	0.66	12.5	0.85	17.9	1.12	23.8	1.46
	12	3.7	0.37	5.0	0.46	6.7	0.58	9.5	0.67	12.5	0.86	17.9	1.13	23.8	1.48
	14	3.7	0.37	5.0	0.47	6.7	0.59	9.5	0.68	12.5	0.87	17.9	1.14	23.8	1.49
	16	3.7	0.38	5.0	0.47	6.7	0.59	9.5	0.69	12.5	0.87	17.9	1.15	23.8	1.51
	18	3.7	0.38	5.0	0.48	6.7	0.60	9.5	0.69	12.5	0.88	17.9	1.17	23.8	1.53
	20	3.7	0.39	5.0	0.48	6.7	0.60	9.5	0.70	12.5	0.89	17.9	1.18	23.8	1.54
	21	3.7	0.39	5.9	0.56	8.7	0.79	11.7	0.88	14.4	1.07	19.8	1.29	25.6	1.70
	23	5.3	0.58	9.1	0.92	12.2	1.16	15.8	1.26	18.3	1.57	23.5	1.92	29.2	2.33
	25	8.4	0.96	12.3	1.36	15.6	1.60	19.8	1.99	22.1	2.29	27.2	2.90	32.7	3.37
	27	11.5	1.40	15.5	1.94	19.1	2.36	23.9	2.96	26.0	3.35	30.9	3.90	36.3	4.41
	29	14.5	1.78	18.7	2.56	22.5	3.20	27.9	4.02	29.9	4.42	34.7	5.01	39.8	5.84
	31	17.6	2.18	21.9	3.19	26.0	4.01	32.0	5.06	33.8	5.35	38.4	5.77	43.3	6.72
	33	20.7	2.94	25.1	3.88	29.4	4.66	35.3	5.87	37.6	6.15	42.1	6.84	46.8	7.56
	35	23.8	4.02	28.4	5.01	32.9	6.06	35.3	6.63	37.6	7.24	42.1	8.53	46.8	9.35
	37	23.8	4.27	28.4	5.31	32.9	6.44	35.3	7.05	37.6	7.71	42.1	9.08	46.8	9.87
	39	23.8	4.54	28.4	5.66	32.9	6.89	35.3	7.59	37.6	8.32	42.1	9.71	46.8	10.64
	41	23.2	5.02	27.7	6.20	32.1	7.56	34.4	8.32	36.7	9.05	41.0	10.67	45.6	11.47
43	22.6	5.46	27.0	6.76	31.3	8.25	33.5	9.08	35.8	9.88	40.0	11.65	44.5	12.40	
46	21.2	6.07	25.3	7.60	29.3	9.29	31.4	10.11	33.5	11.14	37.5	13.14	41.7	13.83	
48	18.7	5.30	22.4	6.64	26.0	8.12	27.8	8.84	29.6	9.75	33.2	11.50	36.9	11.86	
60	10	3.2	0.34	4.3	0.42	5.8	0.53	8.2	0.62	10.8	0.79	15.5	1.04	20.6	1.36
	12	3.2	0.34	4.3	0.43	5.8	0.54	8.2	0.63	10.8	0.79	15.5	1.05	20.6	1.37
	14	3.2	0.35	4.3	0.43	5.8	0.54	8.2	0.63	10.8	0.80	15.5	1.06	20.6	1.39
	16	3.2	0.35	4.3	0.44	5.8	0.55	8.2	0.64	10.8	0.81	15.5	1.07	20.6	1.40
	18	3.2	0.35	4.3	0.44	5.8	0.56	8.2	0.65	10.8	0.82	15.5	1.08	20.6	1.42
	20	3.2	0.36	4.3	0.45	5.8	0.56	8.2	0.65	10.8	0.83	15.5	1.09	20.6	1.43
	21	3.2	0.36	4.3	0.46	7.3	0.72	9.6	0.79	12.4	0.99	16.9	1.20	21.9	1.57
	23	3.2	0.40	7.2	0.84	10.3	1.08	13.3	1.15	15.6	1.46	19.6	1.78	24.5	2.16
	25	6.0	0.76	10.1	1.27	13.2	1.48	17.1	1.96	18.8	2.13	22.8	2.64	27.1	3.13
	27	8.9	1.10	12.9	1.80	16.2	2.19	20.7	2.73	22.0	3.06	25.6	3.49	29.7	4.03
	29	11.7	1.43	15.8	2.31	19.2	2.92	24.4	3.59	25.2	3.89	28.4	4.38	32.3	5.15
	31	14.6	1.82	18.6	2.76	22.2	3.55	27.4	4.31	28.4	4.52	31.8	4.85	34.9	5.93
	33	17.4	2.53	21.5	3.36	25.2	3.99	29.6	4.83	31.7	5.18	34.4	5.75	37.5	6.76
	35	20.3	3.41	24.3	4.17	28.3	5.00	30.2	5.45	32.2	5.91	36.2	6.91	40.1	7.97
	37	20.3	3.60	24.3	4.41	28.3	5.30	30.2	5.78	32.2	6.27	36.2	7.33	40.1	8.48
	39	20.3	3.83	24.3	4.69	28.3	5.72	30.2	6.21	32.2	6.75	36.2	7.86	40.1	9.08
	41	19.8	4.16	23.7	5.13	27.5	6.21	29.5	6.78	31.4	7.33	35.3	8.63	39.1	9.87
43	19.3	4.52	23.1	5.59	26.9	6.77	28.7	7.39	30.6	7.99	34.4	9.42	38.1	10.78	
46	18.1	5.06	21.6	6.27	25.2	7.61	26.9	8.31	28.7	8.99	32.2	10.61	35.7	12.28	
48	16.0	4.41	19.1	5.48	22.3	6.65	23.8	7.25	25.4	7.86	28.5	9.28	31.6	10.75	
50	10	2.9	0.32	4.0	0.39	5.6	0.49	7.5	0.61	9.9	0.73	14.2	0.96	18.8	1.26
	12	2.9	0.32	4.0	0.40	5.6	0.50	7.5	0.61	9.9	0.74	14.2	0.97	18.8	1.27
	14	2.9	0.32	4.0	0.40	5.6	0.50	7.5	0.62	9.9	0.75	14.2	0.98	18.8	1.28
	16	2.9	0.33	4.0	0.41	5.6	0.51	7.5	0.63	9.9	0.75	14.2	0.99	18.8	1.30
	18	2.9	0.33	4.0	0.41	5.6	0.52	7.5	0.63	9.9	0.76	14.2	1.00	18.8	1.31
	20	2.9	0.33	4.0	0.41	5.6	0.52	7.5	0.64	9.9	0.77	14.2	1.01	18.8	1.32
	21	2.9	0.33	4.0	0.43	7.0	0.67	8.8	0.77	11.2	0.92	15.4	1.12	19.8	1.45
	23	2.9	0.35	6.3	0.73	9.7	1.00	12.5	1.20	14.2	1.36	17.7	1.65	21.9	2.00
	25	5.2	0.65	8.6	1.08	12.3	1.40	16.5	1.94	17.4	1.98	20.1	2.33	24.0	2.82
	27	7.6	0.93	11.0	1.51	15.3	1.95	19.1	2.58	20.3	2.66	22.4	3.04	26.0	3.60
	29	9.9	1.22	13.3	1.95	17.7	2.51	21.5	3.21	23.1	3.43	24.8	3.77	28.1	4.54
	31	12.3	1.55	15.7	2.32	20.2	3.06	23.4	3.58	24.7	3.80	27.1	4.07	30.1	5.00
	33	14.6	2.16	18.0	2.79	22.6	3.43	24.3	3.92	25.8	4.20	29.3	4.83	32.1	5.61
	35	17.0	2.84	20.3	3.41	23.6	4.03	25.2	4.37	26.8	4.71	30.1	5.44	33.5	6.25
	37	17.0	3.01	20.3	3.60	23.6	4.26	25.2	4.63	26.8	4.99	30.1	5.80	33.5	6.63
	39	17.0	3.21	20.3	3.86	23.6	4.57	25.2	4.98	26.8	5.35	30.1	6.18	33.5	7.16
	41	16.6	3.47	19.8	4.18	23.0	5.00	24.6	5.39	26.1	5.80	29.3	6.77	32.6	7.78
43	16.2	3.77	19.3	4.55	22.4	5.44	23.9	5.87	25.5	6.32	28.6	7.38	31.8	8.49	
46	15.1	4.22	18.1	5.10	21.0	6.10	22.4	6.60	23.9	7.09	26.8	8.31	29.8	9.55	
48	13.4	3.68	16.0	4.45	18.6	5.32	19.9	5.76	21.1	6.19	23.7	7.26	26.4	8.35	

**Note**

1. TC: Total Capacity(kW), PI : Power Input(kW, Comp. + Outdoor fan motor)
2. Capacity tables show the average value of conditions which may occur.

# 7. Capacity Tables

## ◆ ARUM200LTE5

Cooling Capacity (20HP)

Combination (%)	Outdoor air temp. (DB, °C)	Indoor air temp. (DB/WB, °C)													
		20		23		26		27		28		30		32	
		14	16	16	18	18	19	19	20	20	22	22	24	24	
		TC	PI	TC	PI	TC	PI	TC	PI	TC	PI	TC	PI	TC	PI
130	10	7.9	0.73	10.7	0.91	14.3	1.11	20.2	1.35	26.7	1.69	38.4	2.26	50.9	2.99
	12	7.9	0.74	10.7	0.92	14.3	1.12	20.2	1.37	26.7	1.71	38.4	2.28	50.9	3.02
	14	7.9	0.75	10.7	0.93	14.3	1.13	20.2	1.38	26.7	1.73	38.4	2.30	50.9	3.05
	16	7.9	0.75	10.7	0.94	14.3	1.14	20.2	1.40	26.7	1.74	38.4	2.33	50.9	3.08
	18	7.9	0.76	10.7	0.95	14.3	1.16	20.2	1.41	26.7	1.76	38.4	2.35	50.9	3.11
	20	7.9	0.77	10.7	0.96	14.3	1.17	20.2	1.42	26.7	1.78	38.4	2.37	50.9	3.14
	21	7.9	0.78	10.9	0.99	17.7	1.46	23.6	1.70	29.8	2.19	40.9	2.98	52.5	3.54
	23	13.7	1.38	19.1	1.81	24.7	2.06	30.8	2.30	36.1	3.29	45.9	4.26	55.8	5.01
	25	20.2	2.18	24.5	2.72	31.6	3.09	38.4	3.64	42.4	4.73	51.0	6.19	59.1	7.28
	27	26.4	3.48	31.3	4.11	38.5	4.66	45.6	5.57	48.7	7.08	56.1	8.92	62.3	10.05
	29	32.6	4.83	38.2	5.67	45.4	6.85	53.0	8.06	54.9	9.61	61.2	11.53	65.6	12.84
	31	39.6	6.31	45.9	7.79	53.4	9.45	59.7	11.03	61.2	12.58	64.6	15.80	69.0	16.02
	33	46.5	7.78	54.4	10.16	61.1	12.16	64.5	15.79	65.9	15.67	68.0	15.81	72.6	16.04
	35	55.5	10.51	63.6	12.74	65.6	15.46	66.7	15.53	67.8	15.63	69.7	15.77	71.7	15.83
	37	55.5	11.21	62.7	13.37	64.7	15.25	65.6	15.33	66.7	15.42	68.5	15.56	70.6	15.62
	39	55.5	11.93	61.6	14.07	63.6	15.05	64.7	15.12	65.6	15.21	67.6	15.35	69.7	15.41
41	54.0	12.66	59.0	14.77	61.0	14.84	61.9	14.92	63.1	15.01	65.0	15.14	66.8	15.20	
43	52.7	13.35	56.5	14.57	58.5	14.64	59.4	14.71	60.6	14.80	62.4	14.93	64.1	14.99	
46	49.4	14.29	51.6	14.26	53.5	14.33	54.3	14.40	55.4	14.49	57.2	14.62	58.7	14.68	
48	43.7	13.89	44.8	13.93	46.5	13.96	47.2	14.00	48.2	14.12	49.8	14.21	51.1	14.27	
120	10	7.3	0.68	9.9	0.85	13.2	1.04	18.7	1.27	24.6	1.58	35.4	2.11	47.0	2.79
	12	7.3	0.69	9.9	0.86	13.2	1.05	18.7	1.28	24.6	1.60	35.4	2.13	47.0	2.82
	14	7.3	0.70	9.9	0.87	13.2	1.06	18.7	1.29	24.6	1.62	35.4	2.15	47.0	2.85
	16	7.3	0.70	9.9	0.88	13.2	1.07	18.7	1.31	24.6	1.63	35.4	2.18	47.0	2.88
	18	7.3	0.71	9.9	0.89	13.2	1.08	18.7	1.32	24.6	1.65	35.4	2.20	47.0	2.91
	20	7.3	0.72	9.9	0.90	13.2	1.09	18.7	1.33	24.6	1.67	35.4	2.22	47.0	2.94
	21	7.3	0.73	10.1	0.92	16.7	1.39	21.7	1.59	27.8	2.05	37.9	2.79	48.7	3.31
	23	12.6	1.29	18.1	1.72	23.8	1.98	28.4	2.15	34.4	3.08	43.1	3.98	52.0	4.69
	25	19.7	2.04	25.4	2.58	31.2	2.89	35.4	3.40	41.2	4.43	48.6	5.79	55.4	6.81
	27	27.3	3.23	34.5	3.84	38.7	4.33	42.0	5.17	48.1	6.57	54.1	8.28	58.8	9.48
	29	35.0	4.48	41.6	5.18	46.1	6.35	48.9	7.48	54.9	8.92	59.6	10.70	62.2	12.04
	31	42.4	5.68	50.1	6.84	53.6	8.43	56.2	9.92	62.0	11.31	63.7	13.60	65.8	13.86
	33	49.2	7.00	59.1	8.93	62.6	10.85	63.5	12.58	64.6	14.80	66.3	14.97	68.4	15.09
	35	50.2	9.35	59.7	12.11	63.2	13.39	64.1	15.95	65.2	16.03	67.0	16.08	68.7	16.21
	37	50.2	10.05	59.7	12.77	62.3	14.28	63.2	15.61	64.1	15.69	65.9	15.74	67.7	15.86
	39	50.2	10.82	59.5	13.50	61.2	15.14	62.1	15.29	63.0	15.37	65.0	15.42	66.8	15.54
41	48.9	11.59	56.9	14.23	58.8	14.84	59.6	14.97	60.5	15.05	62.2	15.09	64.0	15.21	
43	47.7	12.37	54.5	14.03	56.4	14.51	57.2	14.65	58.0	14.73	59.7	14.77	61.5	14.89	
46	44.7	13.30	49.7	13.69	51.5	14.06	52.2	14.17	53.0	14.24	54.6	14.28	56.3	14.40	
48	39.5	13.03	43.1	13.45	44.7	13.78	45.4	13.86	46.1	13.91	47.5	13.97	49.0	14.02	
110	10	6.7	0.64	9.1	0.80	12.1	0.97	17.1	1.19	22.5	1.49	32.4	1.98	43.0	2.62
	12	6.7	0.65	9.1	0.81	12.1	0.99	17.1	1.20	22.5	1.50	32.4	2.00	43.0	2.65
	14	6.7	0.66	9.1	0.82	12.1	1.00	17.1	1.21	22.5	1.52	32.4	2.02	43.0	2.68
	16	6.7	0.66	9.1	0.83	12.1	1.01	17.1	1.23	22.5	1.53	32.4	2.04	43.0	2.71
	18	6.7	0.67	9.1	0.83	12.1	1.02	17.1	1.24	22.5	1.55	32.4	2.07	43.0	2.74
	20	6.7	0.68	9.1	0.84	12.1	1.03	17.1	1.25	22.5	1.56	32.4	2.09	43.0	2.76
	21	6.7	0.68	9.1	0.87	15.2	1.28	20.1	1.49	25.1	1.92	35.0	2.62	45.2	3.11
	23	11.9	1.21	15.2	1.62	21.3	1.81	26.2	2.02	31.8	2.89	39.8	3.74	49.1	4.41
	25	17.2	1.92	21.3	2.43	27.3	2.71	32.4	3.20	37.7	4.16	44.5	5.44	53.0	6.40
	27	22.4	3.03	27.3	3.61	33.4	4.07	38.4	4.86	44.0	6.17	49.5	7.78	57.3	8.91
	29	27.6	4.21	33.4	4.86	39.5	5.97	44.7	7.03	50.2	8.38	54.6	9.86	60.4	10.93
	31	33.5	5.33	40.3	6.43	46.5	7.92	50.9	9.32	56.5	10.63	59.6	11.40	62.7	12.27
	33	38.9	6.57	46.5	8.39	52.7	10.19	57.4	11.39	61.1	12.78	63.0	13.14	64.6	13.15
	35	45.0	8.28	53.6	10.65	59.9	12.15	61.6	13.01	62.5	13.81	64.0	13.94	65.7	14.01
	37	45.0	8.78	53.6	11.31	59.9	12.82	60.7	13.79	61.4	14.57	63.1	14.62	64.6	14.66
	39	45.0	9.46	53.6	12.02	58.8	13.53	59.6	14.75	60.5	15.29	62.0	15.32	63.8	15.33
41	43.8	10.15	52.2	12.72	56.3	14.27	57.2	15.95	57.9	15.95	59.6	16.08	61.1	16.21	
43	42.7	10.66	50.9	13.26	53.9	15.13	54.8	15.30	55.5	15.27	57.2	15.35	58.6	15.40	
46	40.0	10.40	47.7	12.80	49.2	14.36	50.1	14.36	50.7	14.48	52.3	14.56	53.6	14.60	
48	35.4	10.10	41.5	12.33	42.7	13.66	43.5	13.75	44.1	13.82	45.5	13.86	46.7	13.91	

# 7. Capacity Tables

Cooling Capacity (20HP)

Combination (%)	Outdoor air temp. (DB, °C)	Indoor air temp. (DB/WB, °C)													
		20		23		26		27		28		30		32	
		14		16		18		19		20		22		24	
		TC	PI	TC	PI	TC	PI	TC	PI	TC	PI	TC	PI	TC	PI
100	10	6.1	0.59	8.3	0.74	11.1	0.89	15.7	1.09	20.7	1.36	29.8	1.82	39.5	2.41
	12	6.1	0.59	8.3	0.74	11.1	0.90	15.7	1.10	20.7	1.38	29.8	1.84	39.5	2.43
	14	6.1	0.60	8.3	0.75	11.1	0.91	15.7	1.11	20.7	1.39	29.8	1.86	39.5	2.46
	16	6.1	0.61	8.3	0.76	11.1	0.92	15.7	1.13	20.7	1.41	29.8	1.88	39.5	2.48
	18	6.1	0.61	8.3	0.77	11.1	0.93	15.7	1.14	20.7	1.42	29.8	1.90	39.5	2.51
	20	6.1	0.62	8.3	0.77	11.1	0.94	15.7	1.15	20.7	1.44	29.8	1.91	39.5	2.53
	21	6.1	0.63	8.3	0.80	13.8	1.18	18.4	1.37	23.6	1.76	32.1	2.41	41.5	2.85
	23	10.6	1.11	14.6	1.48	19.4	1.67	24.3	1.85	29.4	2.65	36.8	3.43	45.5	4.04
	25	15.1	1.76	19.7	2.23	24.9	2.49	30.2	2.93	35.2	3.82	41.6	4.99	49.5	5.87
	27	19.6	2.78	24.8	3.31	30.4	3.73	35.9	4.46	41.1	5.66	46.3	7.14	53.5	8.17
	29	24.2	3.86	29.9	4.46	35.9	5.48	41.8	6.45	46.9	7.69	51.0	9.23	57.6	10.03
	31	28.7	4.89	34.9	5.90	41.4	7.27	47.6	8.55	52.8	9.75	55.7	10.67	62.0	11.37
	33	33.2	6.03	40.0	7.70	46.9	9.35	53.4	10.85	58.7	11.85	60.5	12.05	62.0	12.31
	35	37.8	7.26	45.0	9.27	52.4	11.53	56.0	12.76	58.7	12.84	60.5	12.89	62.0	12.99
	37	37.8	7.78	45.0	9.95	52.4	12.21	56.0	13.37	57.7	13.43	59.4	13.49	60.8	13.61
	39	37.8	8.34	45.0	10.68	52.4	12.94	56.0	14.02	56.8	14.08	58.4	14.14	59.8	14.27
41	37.2	8.90	44.3	11.42	51.6	13.67	53.7	14.67	54.9	14.73	56.2	14.78	58.0	14.92	
43	35.9	9.42	42.8	12.11	49.8	14.32	51.5	15.24	52.1	15.29	53.7	15.34	55.1	15.48	
46	33.7	10.13	40.1	13.05	46.7	15.19	47.0	15.95	47.5	16.00	49.1	16.04	50.4	16.20	
48	29.8	8.75	35.5	11.29	40.3	12.98	40.9	13.53	41.3	13.58	42.7	13.61	43.8	13.72	
90	10	5.5	0.54	7.5	0.68	10.0	0.85	13.8	0.97	18.6	1.25	26.8	1.65	35.5	2.17
	12	5.5	0.55	7.5	0.68	10.0	0.86	13.8	0.98	18.6	1.27	26.8	1.67	35.5	2.19
	14	5.5	0.55	7.5	0.69	10.0	0.87	13.8	0.99	18.6	1.28	26.8	1.69	35.5	2.21
	16	5.5	0.56	7.5	0.70	10.0	0.88	13.8	1.00	18.6	1.29	26.8	1.71	35.5	2.24
	18	5.5	0.56	7.5	0.70	10.0	0.89	13.8	1.01	18.6	1.31	26.8	1.72	35.5	2.26
	20	5.5	0.57	7.5	0.71	10.0	0.89	13.8	1.02	18.6	1.32	26.8	1.74	35.5	2.28
	21	5.5	0.58	7.5	0.72	12.5	1.13	16.4	1.21	21.0	1.58	28.9	1.92	37.4	2.51
	23	7.5	0.89	11.0	1.24	17.5	1.60	21.2	1.74	25.6	2.33	33.3	2.84	41.2	3.45
	25	11.9	1.51	16.0	1.98	22.5	2.36	26.1	2.75	30.3	3.40	37.6	4.29	45.0	4.99
	27	16.3	2.21	20.9	2.82	27.4	3.67	31.0	4.09	35.0	4.95	41.9	5.78	48.8	6.53
	29	20.7	2.99	25.8	3.88	32.4	5.11	35.8	5.65	39.6	6.54	46.2	7.42	52.6	8.64
	31	25.1	3.74	30.7	4.98	37.4	6.40	40.7	7.21	44.3	8.14	50.5	8.63	56.4	10.04
	33	29.5	4.82	35.7	6.13	42.3	7.76	45.5	8.56	49.0	9.47	54.9	10.23	60.2	11.22
	35	34.0	5.96	40.6	7.54	47.2	9.32	50.4	10.28	53.6	11.18	59.2	11.99	60.2	12.27
	37	34.0	6.33	40.6	8.02	47.2	9.94	50.4	10.92	53.6	11.80	58.2	12.54	59.2	12.82
	39	34.0	6.70	40.6	8.53	47.2	10.52	50.4	11.62	53.6	12.41	57.3	13.22	58.3	13.38
41	33.1	7.50	39.6	9.46	46.0	11.55	49.1	12.71	52.2	13.40	54.9	13.93	55.8	14.25	
43	32.3	8.09	38.6	10.22	44.9	12.61	47.9	13.69	50.9	14.36	52.6	14.88	53.6	15.10	
46	30.3	9.11	36.2	11.64	42.0	14.37	44.9	15.52	46.3	15.96	48.0	16.04	48.9	16.20	
48	26.8	7.96	32.0	10.18	37.2	12.57	39.7	13.53	40.2	13.58	41.7	13.61	42.5	13.72	
80	10	4.7	0.48	6.4	0.60	8.6	0.75	12.1	0.86	15.9	1.11	22.9	1.46	30.4	1.92
	12	4.7	0.48	6.4	0.60	8.6	0.76	12.1	0.87	15.9	1.12	22.9	1.48	30.4	1.94
	14	4.7	0.49	6.4	0.61	8.6	0.77	12.1	0.88	15.9	1.13	22.9	1.49	30.4	1.96
	16	4.7	0.49	6.4	0.62	8.6	0.77	12.1	0.89	15.9	1.14	22.9	1.51	30.4	1.98
	18	4.7	0.50	6.4	0.62	8.6	0.78	12.1	0.90	15.9	1.16	22.9	1.52	30.4	2.00
	20	4.7	0.50	6.4	0.63	8.6	0.79	12.1	0.91	15.9	1.17	22.9	1.54	30.4	2.02
	21	4.7	0.51	6.4	0.65	10.7	1.00	14.4	1.09	18.0	1.40	24.9	1.69	32.3	2.22
	23	8.3	0.94	10.6	1.11	15.2	1.41	19.1	1.57	22.3	2.06	29.0	2.51	36.1	3.05
	25	12.0	1.35	14.9	1.78	19.6	2.09	23.7	2.48	26.5	3.00	33.1	3.79	39.9	4.41
	27	15.6	1.99	19.1	2.54	24.0	3.24	28.4	3.68	30.8	4.38	37.2	5.11	43.7	5.77
	29	19.3	2.58	23.3	3.49	28.4	4.52	33.0	5.09	35.1	5.78	41.3	6.55	47.4	7.64
	31	22.9	3.16	27.5	4.39	32.9	5.66	37.7	6.49	40.1	7.00	45.3	7.55	51.2	8.79
	33	26.5	4.16	31.8	5.40	37.3	6.65	42.4	7.70	44.9	8.05	49.4	8.95	55.0	9.89
	35	30.2	5.45	36.0	6.83	41.8	8.37	44.8	9.20	47.8	10.07	53.6	11.42	58.8	11.90
	37	30.2	5.76	36.0	7.26	41.8	8.88	44.8	9.78	47.8	10.70	53.6	12.06	57.8	12.50
	39	30.2	6.09	36.0	7.67	41.8	9.50	44.8	10.51	47.8	11.50	53.6	12.74	56.9	13.19
41	29.4	6.73	35.1	8.50	40.7	10.43	43.7	11.52	46.6	12.63	52.2	13.65	54.5	13.96	
43	28.7	7.41	34.2	9.28	39.7	11.38	42.6	12.56	45.4	13.81	50.9	14.58	52.2	14.94	
46	26.9	8.25	32.1	10.45	37.2	12.83	39.9	13.98	42.6	15.58	46.6	16.04	47.7	16.20	
48	23.8	7.20	28.4	9.14	32.9	11.22	35.3	12.21	37.7	13.58	40.5	13.61	41.4	13.72	

# 7. Capacity Tables

Cooling Capacity (20HP)

Combination (%)	Outdoor air temp. (DB, °C)	Indoor air temp. (DB/WB, °C)													
		20		23		26		27		28		30		32	
		14		16		18		19		20		22		24	
		TC	PI	TC	PI	TC	PI	TC	PI	TC	PI	TC	PI	TC	PI
70	10	4.1	0.42	5.6	0.53	7.4	0.66	10.5	0.77	13.8	0.98	19.9	1.29	26.4	1.69
	12	4.1	0.43	5.6	0.53	7.4	0.67	10.5	0.78	13.8	0.99	19.9	1.31	26.4	1.71
	14	4.1	0.43	5.6	0.54	7.4	0.68	10.5	0.79	13.8	1.00	19.9	1.32	26.4	1.73
	16	4.1	0.44	5.6	0.55	7.4	0.68	10.5	0.79	13.8	1.01	19.9	1.33	26.4	1.75
	18	4.1	0.44	5.6	0.55	7.4	0.69	10.5	0.80	13.8	1.02	19.9	1.35	26.4	1.76
	20	4.1	0.45	5.6	0.56	7.4	0.70	10.5	0.81	13.8	1.03	19.9	1.36	26.4	1.78
	21	4.1	0.45	6.5	0.65	9.7	0.92	13.0	1.02	16.0	1.24	22.0	1.50	28.5	1.96
	23	5.9	0.67	10.1	1.07	13.5	1.34	17.5	1.46	20.3	1.82	26.1	2.22	32.4	2.70
	25	9.3	1.11	13.7	1.58	17.3	1.85	22.0	2.30	24.6	2.65	30.2	3.35	36.3	3.90
	27	12.7	1.62	17.2	2.25	21.2	2.73	26.5	3.42	28.9	3.87	34.4	4.51	40.3	5.10
	29	16.2	2.05	20.8	2.97	25.0	3.71	31.0	4.66	33.2	5.11	38.5	5.79	44.2	6.75
	31	19.6	2.53	24.4	3.69	28.9	4.64	35.5	5.85	37.5	6.19	42.6	6.68	48.2	7.77
	33	23.0	3.40	27.9	4.48	32.7	5.39	39.2	6.79	41.8	7.11	46.8	7.91	52.0	8.75
	35	26.4	4.65	31.6	5.80	36.6	7.02	39.2	7.67	41.8	8.38	46.8	9.87	52.0	10.82
	37	26.4	4.94	31.6	6.14	36.6	7.45	39.2	8.16	41.8	8.92	46.8	10.50	52.0	11.42
	39	26.4	5.25	31.6	6.55	36.6	7.97	39.2	8.78	41.8	9.63	46.8	11.24	52.0	12.31
41	25.7	5.81	30.8	7.17	35.7	8.74	38.2	9.63	40.7	10.47	45.6	12.34	50.7	13.26	
43	25.1	6.32	30.0	7.82	34.8	9.54	37.3	10.50	39.7	11.43	44.5	13.48	49.4	14.35	
46	23.5	7.02	28.1	8.79	32.6	10.74	34.9	11.70	37.2	12.89	41.7	15.21	46.3	16.00	
48	20.8	6.13	24.9	7.68	28.8	9.39	30.9	10.22	32.9	11.27	36.9	13.31	41.0	13.72	
60	10	3.6	0.39	4.8	0.49	6.4	0.62	9.1	0.72	12.0	0.91	17.3	1.20	22.9	1.57
	12	3.6	0.40	4.8	0.50	6.4	0.62	9.1	0.73	12.0	0.92	17.3	1.21	22.9	1.59
	14	3.6	0.40	4.8	0.50	6.4	0.63	9.1	0.73	12.0	0.93	17.3	1.23	22.9	1.61
	16	3.6	0.41	4.8	0.51	6.4	0.64	9.1	0.74	12.0	0.94	17.3	1.24	22.9	1.62
	18	3.6	0.41	4.8	0.51	6.4	0.64	9.1	0.75	12.0	0.95	17.3	1.25	22.9	1.64
	20	3.6	0.41	4.8	0.52	6.4	0.65	9.1	0.76	12.0	0.96	17.3	1.26	22.9	1.65
	21	3.6	0.42	4.8	0.54	8.1	0.83	10.7	0.92	13.7	1.15	18.7	1.39	24.3	1.82
	23	3.6	0.46	8.0	0.97	11.4	1.25	14.8	1.33	17.3	1.69	21.8	2.06	27.2	2.50
	25	6.7	0.87	11.2	1.46	14.7	1.72	19.1	2.27	20.9	2.46	25.3	3.05	30.1	3.62
	27	9.9	1.28	14.3	2.08	18.0	2.53	23.0	3.16	24.5	3.54	28.5	4.04	33.0	4.66
	29	13.0	1.66	17.5	2.67	21.4	3.37	27.1	4.16	28.0	4.51	31.6	5.07	35.9	5.96
	31	16.2	2.11	20.7	3.19	24.7	4.11	30.5	4.99	31.6	5.23	35.4	5.61	38.8	6.86
	33	19.4	2.93	23.9	3.88	28.0	4.61	32.9	5.59	35.2	5.99	38.2	6.65	41.7	7.82
	35	22.6	3.95	27.0	4.83	31.4	5.79	33.6	6.30	35.8	6.84	40.2	7.99	44.6	9.22
	37	22.6	4.17	27.0	5.10	31.4	6.13	33.6	6.69	35.8	7.26	40.2	8.48	44.6	9.81
	39	22.6	4.43	27.0	5.43	31.4	6.61	33.6	7.18	35.8	7.81	40.2	9.09	44.6	10.51
41	22.0	4.81	26.3	5.94	30.6	7.18	32.7	7.84	34.9	8.48	39.2	9.98	43.5	11.42	
43	21.5	5.22	25.7	6.47	29.8	7.83	31.9	8.55	34.0	9.24	38.2	10.89	42.4	12.47	
46	20.1	5.85	24.0	7.26	28.0	8.81	29.9	9.61	31.9	10.40	35.8	12.28	39.7	14.21	
48	17.8	5.10	21.3	6.34	24.7	7.69	26.5	8.39	28.2	9.09	31.7	10.74	35.1	12.43	
50	10	3.2	0.36	4.4	0.46	6.2	0.57	8.3	0.70	11.0	0.84	15.8	1.11	20.9	1.45
	12	3.2	0.37	4.4	0.46	6.2	0.58	8.3	0.71	11.0	0.85	15.8	1.13	20.9	1.47
	14	3.2	0.37	4.4	0.46	6.2	0.58	8.3	0.72	11.0	0.86	15.8	1.14	20.9	1.48
	16	3.2	0.38	4.4	0.47	6.2	0.59	8.3	0.72	11.0	0.87	15.8	1.15	20.9	1.50
	18	3.2	0.38	4.4	0.47	6.2	0.60	8.3	0.73	11.0	0.88	15.8	1.16	20.9	1.51
	20	3.2	0.38	4.4	0.48	6.2	0.60	8.3	0.74	11.0	0.89	15.8	1.17	20.9	1.53
	21	3.2	0.39	4.4	0.50	7.7	0.77	9.8	0.89	12.5	1.07	17.1	1.29	22.0	1.68
	23	3.2	0.41	7.0	0.85	10.7	1.16	13.8	1.38	15.8	1.57	19.7	1.91	24.3	2.31
	25	5.8	0.75	9.6	1.24	13.7	1.62	18.3	2.24	19.4	2.29	22.3	2.69	26.6	3.27
	27	8.4	1.07	12.2	1.75	17.0	2.26	21.2	2.99	22.5	3.08	24.9	3.52	28.9	4.16
	29	11.0	1.41	14.8	2.26	19.7	2.90	23.9	3.71	25.7	3.97	27.5	4.36	31.2	5.25
	31	13.6	1.79	17.4	2.68	22.4	3.54	26.0	4.14	27.5	4.40	30.1	4.71	33.5	5.78
	33	16.3	2.49	20.0	3.23	25.1	3.97	27.0	4.53	28.6	4.86	32.5	5.58	35.7	6.49
	35	18.9	3.28	22.6	3.95	26.2	4.66	28.0	5.06	29.8	5.45	33.4	6.29	37.2	7.23
	37	18.9	3.48	22.6	4.17	26.2	4.93	28.0	5.35	29.8	5.77	33.4	6.71	37.2	7.67
	39	18.9	3.71	22.6	4.47	26.2	5.29	28.0	5.76	29.8	6.19	33.4	7.15	37.2	8.29
41	18.4	4.01	22.0	4.84	25.5	5.78	27.3	6.24	29.0	6.71	32.5	7.83	36.2	9.00	
43	18.0	4.36	21.5	5.26	24.9	6.29	26.6	6.80	28.3	7.31	31.7	8.54	35.4	9.82	
46	16.8	4.88	20.1	5.90	23.3	7.05	24.9	7.63	26.5	8.20	29.7	9.61	33.1	11.05	
48	14.9	4.26	17.8	5.15	20.6	6.15	22.1	6.66	23.5	7.16	26.3	8.40	29.3	9.66	

**Note**

1. TC: Total Capacity(kW), PI : Power Input(kW, Comp. + Outdoor fan motor)
2. Capacity tables show the average value of conditions which may occur.



# 7. Capacity Tables

## ◆ ARUM220LTE5

Cooling Capacity (22HP)

Combination (%)	Outdoor air temp. (DB, °C)	Indoor air temp. (DB/WB, °C)													
		20		23		26		27		28		30		32	
		14	16	16	18	18	19	19	20	20	22	22	24	24	
		TC	PI	TC	PI	TC	PI	TC	PI	TC	PI	TC	PI	TC	PI
130	10	8.7	0.91	11.8	1.14	15.8	1.38	22.2	1.69	29.3	2.11	42.2	2.81	56.0	3.73
	12	8.7	0.92	11.8	1.15	15.8	1.40	22.2	1.71	29.3	2.13	42.2	2.84	56.0	3.76
	14	8.7	0.93	11.8	1.16	15.8	1.41	22.2	1.72	29.3	2.15	42.2	2.87	56.0	3.80
	16	8.7	0.94	11.8	1.17	15.8	1.43	22.2	1.74	29.3	2.18	42.2	2.90	56.0	3.84
	18	8.7	0.95	11.8	1.19	15.8	1.44	22.2	1.76	29.3	2.20	42.2	2.93	56.0	3.88
	20	8.7	0.96	11.8	1.20	15.8	1.46	22.2	1.78	29.3	2.22	42.2	2.96	56.0	3.92
	21	8.7	0.97	12.0	1.23	19.5	1.82	25.9	2.12	32.8	2.73	45.0	3.72	57.8	4.41
	23	15.1	1.72	21.0	2.26	27.1	2.58	33.9	2.86	39.7	4.11	50.5	5.31	61.4	6.26
	25	22.3	2.72	27.0	3.39	34.7	3.85	42.2	4.54	46.6	5.90	56.1	7.72	65.0	9.08
	27	29.1	4.34	34.5	5.13	42.4	5.82	50.2	6.96	53.5	8.83	61.7	11.13	68.6	12.54
	29	35.9	6.03	42.0	7.07	50.0	8.54	58.3	10.06	60.4	11.99	67.3	14.39	72.2	16.02
	31	43.5	7.87	50.5	9.71	58.7	11.79	65.7	13.76	67.4	15.69	71.1	19.71	75.9	19.99
	33	51.2	9.71	59.8	12.68	67.2	15.17	71.0	19.69	72.5	19.56	74.8	19.73	79.8	20.01
	35	61.0	13.11	69.9	15.89	72.2	19.28	73.4	19.38	74.6	19.50	76.6	19.67	78.9	19.75
	37	61.0	13.98	68.9	16.68	71.2	19.03	72.2	19.12	73.4	19.24	75.4	19.41	77.6	19.49
	39	61.0	14.89	67.7	17.55	69.9	18.77	71.2	18.87	72.2	18.98	74.4	19.15	76.6	19.23
41	59.5	15.79	64.9	18.43	67.1	18.52	68.1	18.61	69.4	18.72	71.5	18.89	73.5	18.97	
43	58.0	16.66	62.2	18.17	64.4	18.26	65.3	18.36	66.6	18.47	68.7	18.63	70.6	18.70	
46	54.3	17.83	56.7	17.79	58.8	17.88	59.7	17.97	61.0	18.08	62.9	18.24	64.6	18.31	
48	48.1	17.33	49.3	17.38	51.1	17.42	51.9	17.47	53.0	17.62	54.7	17.73	56.3	17.80	
120	10	8.0	0.85	10.9	1.06	14.5	1.29	20.5	1.58	27.1	1.97	38.9	2.63	51.7	3.49
	12	8.0	0.86	10.9	1.07	14.5	1.31	20.5	1.60	27.1	1.99	38.9	2.66	51.7	3.52
	14	8.0	0.87	10.9	1.09	14.5	1.32	20.5	1.61	27.1	2.02	38.9	2.69	51.7	3.56
	16	8.0	0.88	10.9	1.10	14.5	1.34	20.5	1.63	27.1	2.04	38.9	2.72	51.7	3.60
	18	8.0	0.89	10.9	1.11	14.5	1.35	20.5	1.65	27.1	2.06	38.9	2.74	51.7	3.63
	20	8.0	0.90	10.9	1.12	14.5	1.36	20.5	1.66	27.1	2.08	38.9	2.77	51.7	3.67
	21	8.0	0.91	11.1	1.15	18.4	1.74	23.9	1.98	30.6	2.55	41.7	3.48	53.5	4.13
	23	13.9	1.61	19.9	2.15	26.2	2.47	31.2	2.68	37.8	3.84	47.4	4.97	57.2	5.85
	25	21.6	2.55	27.9	3.22	34.3	3.60	38.9	4.25	45.4	5.52	53.5	7.22	60.9	8.49
	27	30.0	4.03	38.0	4.79	42.5	5.40	46.2	6.45	52.9	8.19	59.5	10.33	64.6	11.83
	29	38.6	5.59	45.7	6.46	50.7	7.93	53.7	9.34	60.4	11.13	65.6	13.35	68.4	15.02
	31	46.7	7.08	55.1	8.54	58.9	10.52	61.9	12.37	68.2	14.11	70.0	16.97	72.4	17.29
	33	54.1	8.73	65.0	11.14	68.9	13.54	69.8	15.70	71.0	18.47	73.0	18.68	75.2	18.83
	35	55.2	11.66	65.6	15.10	69.6	16.71	70.5	19.90	71.7	20.00	73.7	20.06	75.6	20.22
	37	55.2	12.54	65.6	15.94	68.6	17.81	69.6	19.48	70.5	19.58	72.5	19.64	74.4	19.79
	39	55.2	13.50	65.4	16.85	67.4	18.89	68.3	19.08	69.3	19.18	71.5	19.23	73.4	19.39
41	53.8	14.46	62.6	17.75	64.7	18.52	65.6	18.68	66.5	18.77	68.5	18.83	70.4	18.98	
43	52.5	15.44	59.9	17.50	62.0	18.11	62.9	18.28	63.8	18.37	65.7	18.43	67.6	18.57	
46	49.2	16.60	54.7	17.08	56.6	17.54	57.5	17.68	58.3	17.77	60.1	17.82	61.9	17.96	
48	43.5	16.26	47.5	16.78	49.2	17.19	50.0	17.30	50.7	17.35	52.3	17.42	53.9	17.49	
110	10	7.3	0.80	10.0	1.00	13.3	1.22	18.8	1.48	24.8	1.85	35.7	2.47	47.3	3.27
	12	7.3	0.81	10.0	1.01	13.3	1.23	18.8	1.50	24.8	1.87	35.7	2.50	47.3	3.31
	14	7.3	0.82	10.0	1.02	13.3	1.24	18.8	1.51	24.8	1.89	35.7	2.53	47.3	3.34
	16	7.3	0.83	10.0	1.03	13.3	1.25	18.8	1.53	24.8	1.91	35.7	2.55	47.3	3.38
	18	7.3	0.83	10.0	1.04	13.3	1.27	18.8	1.55	24.8	1.93	35.7	2.58	47.3	3.41
	20	7.3	0.84	10.0	1.05	13.3	1.28	18.8	1.56	24.8	1.95	35.7	2.60	47.3	3.45
	21	7.3	0.85	10.0	1.08	16.7	1.60	22.1	1.86	27.6	2.40	38.5	3.27	49.7	3.88
	23	13.1	1.51	16.7	2.02	23.4	2.26	28.8	2.52	34.9	3.61	43.8	4.67	54.1	5.50
	25	18.9	2.39	23.4	3.03	30.1	3.39	35.6	3.99	41.5	5.19	48.9	6.78	58.3	7.98
	27	24.6	3.79	30.1	4.51	36.8	5.07	42.3	6.06	48.4	7.70	54.5	9.71	63.0	11.11
	29	30.4	5.26	36.8	6.07	43.5	7.45	49.2	8.77	55.2	10.45	60.0	12.30	66.5	13.64
	31	36.9	6.65	44.3	8.02	51.1	9.88	56.0	11.63	62.1	13.26	65.6	14.22	68.9	15.31
	33	42.8	8.20	51.1	10.47	58.0	12.72	63.2	14.21	67.2	15.95	69.2	16.39	71.0	16.41
	35	49.5	10.33	59.0	13.29	65.9	15.15	67.7	16.24	68.7	17.23	70.4	17.39	72.3	17.48
	37	49.5	10.95	59.0	14.11	65.9	16.00	66.8	17.20	67.5	18.18	69.4	18.24	71.1	18.29
	39	49.5	11.80	59.0	14.99	64.7	16.88	65.6	18.40	66.6	19.08	68.2	19.11	70.1	19.13
41	48.2	12.66	57.5	15.87	61.9	17.80	62.9	19.90	63.7	19.90	65.5	20.06	67.2	20.22	
43	47.0	13.29	56.0	16.54	59.3	18.88	60.3	19.09	61.1	19.05	62.9	19.16	64.5	19.21	
46	44.0	12.98	52.5	15.97	54.1	17.91	55.1	17.91	55.8	18.07	57.5	18.17	59.0	18.22	
48	39.0	12.60	45.6	15.38	47.0	17.04	47.9	17.16	48.5	17.24	50.0	17.29	51.3	17.36	

# 7. Capacity Tables

Cooling Capacity (22HP)

Combination (%)	Outdoor air temp. (DB, °C)	Indoor air temp. (DB/WB, °C)													
		20		23		26		27		28		30		32	
		14		16		18		19		20		22		24	
		TC	PI	TC	PI	TC	PI	TC	PI	TC	PI	TC	PI	TC	PI
100	10	6.7	0.73	9.2	0.92	12.2	1.12	17.2	1.36	22.7	1.70	32.7	2.27	43.4	3.00
	12	6.7	0.74	9.2	0.93	12.2	1.13	17.2	1.38	22.7	1.72	32.7	2.29	43.4	3.04
	14	6.7	0.75	9.2	0.94	12.2	1.14	17.2	1.39	22.7	1.74	32.7	2.32	43.4	3.07
	16	6.7	0.76	9.2	0.95	12.2	1.15	17.2	1.40	22.7	1.76	32.7	2.34	43.4	3.10
	18	6.7	0.77	9.2	0.96	12.2	1.16	17.2	1.42	22.7	1.77	32.7	2.36	43.4	3.13
	20	6.7	0.77	9.2	0.97	12.2	1.17	17.2	1.43	22.7	1.79	32.7	2.39	43.4	3.16
	21	6.7	0.78	9.2	0.99	15.2	1.47	20.3	1.71	25.9	2.20	35.3	3.00	45.6	3.56
	23	11.7	1.39	16.1	1.85	21.3	2.08	26.7	2.31	32.3	3.31	40.5	4.28	50.1	5.04
	25	16.6	2.20	21.7	2.78	27.4	3.11	33.3	3.66	38.8	4.76	45.7	6.22	54.5	7.32
	27	21.6	3.47	27.2	4.13	33.4	4.65	39.5	5.56	45.2	7.06	50.9	8.90	58.9	10.20
	29	26.6	4.82	32.8	5.57	39.5	6.83	45.9	8.05	51.6	9.59	56.1	11.51	63.3	12.51
	31	31.6	6.10	38.4	7.36	45.5	9.07	52.4	10.67	58.1	12.16	61.3	13.31	68.3	14.19
	33	36.5	7.52	44.0	9.60	51.6	11.67	58.8	13.53	64.6	14.78	66.6	15.04	68.3	15.36
	35	41.6	9.06	49.5	11.57	57.6	14.38	61.6	15.92	64.6	16.02	66.6	16.08	68.3	16.21
	37	41.6	9.71	49.5	12.41	57.6	15.23	61.6	16.68	63.5	16.76	65.3	16.83	66.9	16.98
	39	41.6	10.41	49.5	13.33	57.6	16.14	61.6	17.49	62.4	17.57	64.3	17.64	65.8	17.80
41	40.9	11.11	48.7	14.25	56.7	17.05	59.1	18.31	60.4	18.38	61.8	18.45	63.8	18.62	
43	39.5	11.75	47.0	15.11	54.8	17.86	56.7	19.01	57.3	19.08	59.1	19.14	60.6	19.32	
46	37.0	12.64	44.1	16.29	51.3	18.95	51.7	19.90	52.3	19.96	54.0	20.02	55.4	20.21	
48	32.8	10.92	39.0	14.09	44.3	16.20	45.0	16.88	45.4	16.94	46.9	16.98	48.2	17.11	
90	10	6.0	0.68	8.2	0.84	11.0	1.06	15.2	1.21	20.5	1.57	29.5	2.06	39.1	2.70
	12	6.0	0.68	8.2	0.85	11.0	1.07	15.2	1.22	20.5	1.58	29.5	2.09	39.1	2.73
	14	6.0	0.69	8.2	0.86	11.0	1.08	15.2	1.24	20.5	1.60	29.5	2.11	39.1	2.76
	16	6.0	0.70	8.2	0.87	11.0	1.09	15.2	1.25	20.5	1.61	29.5	2.13	39.1	2.79
	18	6.0	0.70	8.2	0.88	11.0	1.10	15.2	1.26	20.5	1.63	29.5	2.15	39.1	2.82
	20	6.0	0.71	8.2	0.89	11.0	1.12	15.2	1.28	20.5	1.65	29.5	2.17	39.1	2.85
	21	6.0	0.72	8.2	0.90	13.8	1.41	18.0	1.51	23.1	1.98	31.8	2.39	41.1	3.13
	23	8.2	1.11	12.1	1.54	19.3	1.99	23.4	2.17	28.2	2.91	36.6	3.54	45.3	4.31
	25	13.1	1.88	17.6	2.47	24.7	2.95	28.7	3.43	33.3	4.24	41.3	5.35	49.5	6.22
	27	17.9	2.76	23.0	3.52	30.2	4.58	34.1	5.10	38.5	6.18	46.1	7.21	53.6	8.14
	29	22.8	3.73	28.4	4.84	35.6	6.38	39.4	7.05	43.6	8.16	50.8	9.25	57.8	10.78
	31	27.6	4.67	33.8	6.21	41.1	7.99	44.7	9.00	48.8	10.16	55.6	10.77	62.0	12.53
	33	32.5	6.01	39.2	7.64	46.5	9.68	50.1	10.67	53.9	11.81	60.4	12.76	66.2	13.99
	35	37.4	7.44	44.7	9.41	51.9	11.63	55.4	12.83	59.0	13.95	65.1	14.96	66.2	15.30
	37	37.4	7.90	44.7	10.01	51.9	12.40	55.4	13.63	59.0	14.72	64.0	15.64	65.1	15.99
	39	37.4	8.36	44.7	10.64	51.9	13.13	55.4	14.50	59.0	15.48	63.0	16.49	64.1	16.69
41	36.4	9.35	43.5	11.80	50.6	14.41	54.0	15.86	57.5	16.71	60.4	17.38	61.4	17.78	
43	35.5	10.10	42.4	12.75	49.3	15.74	52.7	17.08	56.0	17.92	57.9	18.56	58.9	18.83	
46	33.3	11.37	39.8	14.52	46.2	17.93	49.4	19.36	50.9	19.91	52.8	20.02	53.8	20.21	
48	29.5	9.93	35.2	12.70	40.9	15.69	43.7	16.88	44.2	16.94	45.9	16.98	46.8	17.11	
80	10	5.2	0.60	7.1	0.75	9.4	0.94	13.3	1.08	17.5	1.38	25.2	1.83	33.4	2.39
	12	5.2	0.60	7.1	0.75	9.4	0.95	13.3	1.09	17.5	1.40	25.2	1.84	33.4	2.42
	14	5.2	0.61	7.1	0.76	9.4	0.96	13.3	1.10	17.5	1.41	25.2	1.86	33.4	2.44
	16	5.2	0.62	7.1	0.77	9.4	0.97	13.3	1.11	17.5	1.43	25.2	1.88	33.4	2.47
	18	5.2	0.62	7.1	0.78	9.4	0.98	13.3	1.12	17.5	1.44	25.2	1.90	33.4	2.49
	20	5.2	0.63	7.1	0.79	9.4	0.99	13.3	1.13	17.5	1.46	25.2	1.92	33.4	2.52
	21	5.2	0.63	7.1	0.81	11.8	1.24	15.8	1.36	19.8	1.75	27.4	2.11	35.5	2.77
	23	9.2	1.17	11.7	1.39	16.7	1.76	21.0	1.95	24.5	2.57	31.9	3.13	39.7	3.81
	25	13.2	1.69	16.4	2.23	21.5	2.61	26.1	3.09	29.2	3.75	36.4	4.73	43.9	5.50
	27	17.2	2.48	21.0	3.17	26.4	4.05	31.2	4.59	33.9	5.46	40.9	6.37	48.0	7.20
	29	21.2	3.22	25.6	4.35	31.3	5.64	36.4	6.35	38.6	7.21	45.4	8.18	52.2	9.53
	31	25.2	3.95	30.3	5.48	36.1	7.06	41.5	8.10	44.1	8.74	49.9	9.43	56.4	10.97
	33	29.2	5.19	34.9	6.74	41.0	8.30	46.6	9.61	49.4	10.04	54.4	11.17	60.5	12.34
	35	33.2	6.79	39.6	8.52	46.0	10.45	49.3	11.48	52.6	12.56	59.0	14.25	64.6	14.85
	37	33.2	7.19	39.6	9.05	46.0	11.08	49.3	12.20	52.6	13.35	59.0	15.04	63.6	15.59
	39	33.2	7.60	39.6	9.57	46.0	11.86	49.3	13.12	52.6	14.34	59.0	15.89	62.6	16.45
41	32.4	8.40	38.6	10.61	44.8	13.01	48.0	14.38	51.2	15.76	57.5	17.03	59.9	17.42	
43	31.6	9.25	37.6	11.58	43.7	14.20	46.8	15.67	50.0	17.22	56.0	18.19	57.5	18.65	
46	29.6	10.29	35.3	13.04	40.9	16.00	43.9	17.44	46.8	19.44	51.2	20.02	52.4	20.21	
48	26.2	8.99	31.2	11.40	36.2	14.00	38.8	15.23	41.4	16.94	44.5	16.98	45.6	17.11	

# 7. Capacity Tables

Cooling Capacity (22HP)

Combination (%)	Outdoor air temp. (DB, °C)	Indoor air temp. (DB/WB, °C)													
		20		23		26		27		28		30		32	
		14		16		18		19		20		22		24	
		TC	PI	TC	PI	TC	PI	TC	PI	TC	PI	TC	PI	TC	PI
70	10	4.5	0.53	6.1	0.66	8.2	0.83	11.6	0.96	15.2	1.22	21.9	1.61	29.1	2.11
	12	4.5	0.53	6.1	0.67	8.2	0.84	11.6	0.97	15.2	1.24	21.9	1.63	29.1	2.14
	14	4.5	0.54	6.1	0.67	8.2	0.85	11.6	0.98	15.2	1.25	21.9	1.65	29.1	2.16
	16	4.5	0.54	6.1	0.68	8.2	0.85	11.6	0.99	15.2	1.26	21.9	1.66	29.1	2.18
	18	4.5	0.55	6.1	0.69	8.2	0.86	11.6	1.00	15.2	1.27	21.9	1.68	29.1	2.20
	20	4.5	0.56	6.1	0.69	8.2	0.87	11.6	1.01	15.2	1.29	21.9	1.70	29.1	2.22
	21	4.5	0.56	7.2	0.82	10.6	1.14	14.3	1.27	17.6	1.55	24.2	1.87	31.3	2.45
	23	6.5	0.84	11.1	1.33	14.9	1.67	19.3	1.82	22.3	2.27	28.7	2.77	35.6	3.37
	25	10.2	1.39	15.0	1.97	19.1	2.31	24.2	2.87	27.1	3.31	33.3	4.18	40.0	4.86
	27	14.0	2.02	18.9	2.80	23.3	3.40	29.2	4.27	31.8	4.83	37.8	5.63	44.3	6.36
	29	17.8	2.56	22.9	3.70	27.5	4.63	34.1	5.81	36.5	6.37	42.4	7.23	48.6	8.43
	31	21.5	3.15	26.8	4.60	31.8	5.79	39.1	7.30	41.3	7.72	46.9	8.33	53.0	9.69
	33	25.3	4.24	30.7	5.60	36.0	6.72	43.1	8.47	46.0	8.87	51.5	9.87	57.2	10.91
	35	29.0	5.80	34.8	7.24	40.3	8.75	43.1	9.57	46.0	10.45	51.5	12.31	57.2	13.49
	37	29.0	6.17	34.8	7.66	40.3	9.30	43.1	10.18	46.0	11.12	51.5	13.10	57.2	14.24
	39	29.0	6.55	34.8	8.17	40.3	9.94	43.1	10.95	46.0	12.02	51.5	14.02	57.2	15.35
	41	28.3	7.24	33.9	8.95	39.2	10.91	42.0	12.01	44.8	13.06	50.2	15.40	55.7	16.55
43	27.6	7.88	33.0	9.75	38.3	11.90	41.0	13.10	43.7	14.26	48.9	16.82	54.4	17.90	
46	25.9	8.76	31.0	10.97	35.9	13.40	38.4	14.59	40.9	16.08	45.8	18.97	50.9	19.96	
48	22.9	7.65	27.4	9.58	31.7	11.72	34.0	12.75	36.2	14.07	40.6	16.60	45.1	17.11	
60	10	4.0	0.46	5.3	0.57	7.1	0.72	10.0	0.84	13.2	1.06	19.0	1.40	25.2	1.83
	12	4.0	0.46	5.3	0.58	7.1	0.73	10.0	0.85	13.2	1.07	19.0	1.41	25.2	1.85
	14	4.0	0.47	5.3	0.58	7.1	0.73	10.0	0.85	13.2	1.08	19.0	1.43	25.2	1.87
	16	4.0	0.47	5.3	0.59	7.1	0.74	10.0	0.86	13.2	1.09	19.0	1.44	25.2	1.89
	18	4.0	0.48	5.3	0.60	7.1	0.75	10.0	0.87	13.2	1.10	19.0	1.46	25.2	1.91
	20	4.0	0.48	5.3	0.60	7.1	0.76	10.0	0.88	13.2	1.12	19.0	1.47	25.2	1.93
	21	4.0	0.48	5.3	0.62	8.9	0.97	11.8	1.07	15.1	1.34	20.6	1.62	26.8	2.12
	23	4.0	0.54	8.8	1.13	12.5	1.45	16.3	1.55	19.0	1.97	24.0	2.40	30.0	2.92
	25	7.4	1.02	12.3	1.70	16.2	2.00	21.0	2.65	23.0	2.87	27.9	3.55	33.1	4.21
	27	10.9	1.49	15.8	2.43	19.8	2.95	25.3	3.68	26.9	4.12	31.3	4.70	36.3	5.43
	29	14.4	1.93	19.3	3.11	23.5	3.93	29.9	4.84	30.8	5.25	34.7	5.90	39.5	6.94
	31	17.8	2.45	22.7	3.72	27.2	4.78	33.5	5.81	34.8	6.09	38.9	6.53	42.7	7.99
	33	21.3	3.41	26.2	4.52	30.8	5.37	36.1	6.51	38.7	6.97	42.0	7.74	45.9	9.10
	35	24.9	4.92	29.7	6.03	34.5	7.22	37.0	7.86	39.4	8.53	44.2	9.97	49.1	11.50
	37	24.9	5.20	29.7	6.36	34.5	7.65	37.0	8.35	39.4	9.05	44.2	10.58	49.1	12.23
	39	24.9	5.53	29.7	6.77	34.5	8.25	37.0	8.96	39.4	9.74	44.2	11.35	49.1	13.11
	41	24.2	6.00	28.9	7.41	33.7	8.96	36.0	9.79	38.4	10.58	43.1	12.45	47.8	14.25
43	23.6	6.52	28.2	8.07	32.8	9.77	35.1	10.66	37.4	11.53	42.0	13.59	46.6	15.56	
46	22.1	7.30	26.5	9.06	30.8	10.99	32.9	11.99	35.1	12.98	39.4	15.32	43.7	17.73	
48	19.6	6.36	23.4	7.90	27.2	9.60	29.1	10.47	31.0	11.34	34.8	13.40	38.7	15.51	
50	10	3.6	0.40	4.9	0.49	6.8	0.62	9.1	0.76	12.0	0.92	17.3	1.21	23.0	1.58
	12	3.6	0.40	4.9	0.50	6.8	0.63	9.1	0.77	12.0	0.93	17.3	1.22	23.0	1.60
	14	3.6	0.40	4.9	0.51	6.8	0.63	9.1	0.78	12.0	0.94	17.3	1.24	23.0	1.61
	16	3.6	0.41	4.9	0.51	6.8	0.64	9.1	0.79	12.0	0.95	17.3	1.25	23.0	1.63
	18	3.6	0.41	4.9	0.52	6.8	0.65	9.1	0.79	12.0	0.96	17.3	1.26	23.0	1.65
	20	3.6	0.42	4.9	0.52	6.8	0.65	9.1	0.80	12.0	0.97	17.3	1.27	23.0	1.66
	21	3.6	0.42	4.9	0.54	8.5	0.84	10.8	0.96	13.7	1.16	18.8	1.40	24.3	1.83
	23	3.6	0.45	7.7	0.92	11.8	1.26	15.2	1.50	17.3	1.70	21.7	2.08	26.8	2.51
	25	6.4	0.81	10.6	1.35	15.1	1.76	20.1	2.44	21.3	2.48	24.5	2.92	29.3	3.55
	27	9.3	1.17	13.4	1.90	18.7	2.45	23.4	3.25	24.8	3.35	27.4	3.83	31.8	4.52
	29	12.1	1.53	16.3	2.45	21.7	3.16	26.3	4.03	28.3	4.32	30.3	4.74	34.3	5.71
	31	15.0	1.95	19.1	2.92	24.7	3.84	28.6	4.50	30.2	4.78	33.1	5.12	36.8	6.28
	33	17.9	2.71	22.0	3.51	27.6	4.32	29.7	4.93	31.5	5.28	35.8	6.07	39.3	7.05
	35	20.8	4.09	24.9	4.92	28.8	5.82	30.8	6.31	32.8	6.80	36.7	7.85	40.9	9.02
	37	20.8	4.34	24.9	5.20	28.8	6.16	30.8	6.68	32.8	7.20	36.7	8.37	40.9	9.57
	39	20.8	4.63	24.9	5.58	28.8	6.60	30.8	7.19	32.8	7.73	36.7	8.92	40.9	10.34
	41	20.3	5.01	24.2	6.04	28.1	7.21	30.0	7.79	31.9	8.37	35.8	9.77	39.9	11.23
43	19.8	5.44	23.6	6.57	27.4	7.85	29.3	8.48	31.2	9.11	34.9	10.66	38.9	12.25	
46	18.5	6.09	22.1	7.36	25.7	8.80	27.4	9.52	29.2	10.23	32.7	11.99	36.4	13.79	
48	16.4	5.31	19.6	6.42	22.7	7.68	24.3	8.31	25.8	8.93	28.9	10.48	32.2	12.05	

**Note**

1. TC: Total Capacity(kW), PI : Power Input(kW, Comp. + Outdoor fan motor)
2. Capacity tables show the average value of conditions which may occur.

# 7. Capacity Tables

## ◆ ARUM240LTE5

Cooling Capacity (24HP)

Combination (%)	Outdoor air temp. (DB, °C)	Indoor air temp. (DB/WB, °C)													
		20		23		26		27		28		30		32	
		14	16	16	18	18	19	19	20	20	22	22	24	24	
		TC	PI	TC	PI	TC	PI	TC	PI	TC	PI	TC	PI	TC	PI
130	10	9.5	1.00	12.9	1.24	17.2	1.51	24.3	1.85	32.0	2.31	46.1	3.08	61.1	4.07
	12	9.5	1.01	12.9	1.26	17.2	1.53	24.3	1.87	32.0	2.33	46.1	3.11	61.1	4.12
	14	9.5	1.02	12.9	1.27	17.2	1.55	24.3	1.88	32.0	2.36	46.1	3.14	61.1	4.16
	16	9.5	1.03	12.9	1.28	17.2	1.56	24.3	1.90	32.0	2.38	46.1	3.17	61.1	4.20
	18	9.5	1.04	12.9	1.30	17.2	1.58	24.3	1.92	32.0	2.40	46.1	3.21	61.1	4.25
	20	9.5	1.05	12.9	1.31	17.2	1.59	24.3	1.94	32.0	2.43	46.1	3.24	61.1	4.29
	21	9.5	1.06	13.1	1.35	21.3	1.99	28.3	2.31	35.8	2.98	49.0	4.07	63.0	4.83
	23	16.4	1.88	22.9	2.47	29.6	2.82	37.0	3.13	43.3	4.49	55.1	5.81	66.9	6.84
	25	24.3	2.98	29.4	3.71	37.9	4.21	46.1	4.97	50.9	6.45	61.2	8.44	70.9	9.93
	27	31.7	4.75	37.6	5.61	46.2	6.36	54.7	7.61	58.4	9.65	67.3	12.17	74.8	13.72
	29	39.1	6.59	45.8	7.73	54.5	9.34	63.6	11.00	65.9	13.11	73.4	15.74	78.7	17.52
	31	47.5	8.61	55.1	10.62	64.1	12.89	71.7	15.05	73.5	17.16	77.5	21.56	82.8	21.86
	33	55.9	10.61	65.3	13.86	73.3	16.59	77.4	21.54	79.1	21.39	81.6	21.58	87.1	21.88
	35	66.6	14.34	76.3	17.38	78.7	21.09	80.1	21.19	81.4	21.32	83.6	21.51	86.0	21.60
	37	66.6	15.29	75.2	18.24	77.6	20.81	78.7	20.91	80.1	21.04	82.3	21.23	84.7	21.31
	39	66.6	16.28	73.9	19.20	76.3	20.53	77.6	20.63	78.7	20.76	81.2	20.94	83.6	21.03
41	64.9	17.27	70.8	20.16	73.2	20.25	74.3	20.35	75.7	20.48	78.0	20.66	80.1	20.74	
43	63.3	18.22	67.9	19.87	70.2	19.97	71.3	20.07	72.7	20.19	74.9	20.37	77.0	20.46	
46	59.3	19.50	61.9	19.46	64.1	19.56	65.1	19.65	66.5	19.77	68.6	19.95	70.5	20.03	
48	52.4	18.95	53.8	19.01	55.8	19.05	56.7	19.10	57.9	19.27	59.7	19.39	61.4	19.47	
120	10	8.7	0.93	11.9	1.16	15.9	1.42	22.4	1.73	29.5	2.16	42.5	2.88	56.3	3.81
	12	8.7	0.94	11.9	1.18	15.9	1.43	22.4	1.74	29.5	2.18	42.5	2.91	56.3	3.85
	14	8.7	0.95	11.9	1.19	15.9	1.45	22.4	1.76	29.5	2.20	42.5	2.94	56.3	3.89
	16	8.7	0.96	11.9	1.20	15.9	1.46	22.4	1.78	29.5	2.23	42.5	2.97	56.3	3.93
	18	8.7	0.97	11.9	1.21	15.9	1.48	22.4	1.80	29.5	2.25	42.5	3.00	56.3	3.97
	20	8.7	0.98	11.9	1.22	15.9	1.49	22.4	1.82	29.5	2.27	42.5	3.03	56.3	4.01
	21	8.7	0.99	12.1	1.26	20.1	1.90	26.1	2.16	33.4	2.79	45.5	3.81	58.4	4.51
	23	15.1	1.76	21.7	2.35	28.6	2.70	34.1	2.93	41.3	4.20	51.7	5.43	62.4	6.40
	25	23.6	2.79	30.5	3.53	37.4	3.94	42.5	4.64	49.5	6.04	58.3	7.90	66.5	9.29
	27	32.8	4.41	41.4	5.24	46.4	5.90	50.4	7.06	57.7	8.96	65.0	11.30	70.5	12.94
	29	42.1	6.12	49.9	7.06	55.3	8.67	58.6	10.21	65.9	12.17	71.6	14.60	74.6	16.42
	31	50.9	7.74	60.1	9.34	64.3	11.50	67.5	13.53	74.4	15.43	76.4	18.56	79.0	18.91
	33	59.0	9.54	70.9	12.18	75.1	14.80	76.2	17.17	77.5	20.20	79.6	20.43	82.1	20.59
	35	60.2	12.75	71.6	16.52	75.9	18.27	76.9	21.76	78.3	21.87	80.4	21.94	82.5	22.11
	37	60.2	13.72	71.6	17.43	74.8	19.48	75.9	21.30	76.9	21.41	79.1	21.48	81.2	21.65
	39	60.2	14.77	71.4	18.42	73.5	20.66	74.5	20.87	75.6	20.97	78.0	21.03	80.1	21.20
41	58.7	15.82	68.2	19.41	70.5	20.25	71.5	20.43	72.6	20.53	74.7	20.59	76.8	20.76	
43	57.2	16.88	65.4	19.14	67.7	19.80	68.6	19.99	69.6	20.09	71.7	20.15	73.8	20.31	
46	53.6	18.15	59.6	18.68	61.8	19.18	62.7	19.34	63.6	19.43	65.6	19.49	67.5	19.64	
48	47.5	17.78	51.8	18.35	53.7	18.80	54.5	18.92	55.3	18.98	57.1	19.05	58.8	19.13	
110	10	8.0	0.88	10.9	1.09	14.5	1.33	20.5	1.62	27.0	2.03	38.9	2.70	51.6	3.58
	12	8.0	0.88	10.9	1.10	14.5	1.34	20.5	1.64	27.0	2.05	38.9	2.73	51.6	3.62
	14	8.0	0.89	10.9	1.12	14.5	1.36	20.5	1.66	27.0	2.07	38.9	2.76	51.6	3.66
	16	8.0	0.90	10.9	1.13	14.5	1.37	20.5	1.67	27.0	2.09	38.9	2.79	51.6	3.69
	18	8.0	0.91	10.9	1.14	14.5	1.39	20.5	1.69	27.0	2.11	38.9	2.82	51.6	3.73
	20	8.0	0.92	10.9	1.15	14.5	1.40	20.5	1.71	27.0	2.13	38.9	2.85	51.6	3.77
	21	8.0	0.93	10.9	1.19	18.2	1.75	24.1	2.03	30.1	2.62	42.0	3.58	54.3	4.24
	23	14.3	1.65	18.2	2.21	25.5	2.48	31.4	2.75	38.1	3.95	47.7	5.11	59.0	6.01
	25	20.6	2.62	25.5	3.31	32.8	3.70	38.8	4.36	45.3	5.67	53.4	7.42	63.6	8.73
	27	26.9	4.14	32.8	4.93	40.1	5.55	46.1	6.63	52.8	8.42	59.4	10.61	68.7	12.15
	29	33.2	5.75	40.1	6.64	47.4	8.15	53.6	9.59	60.3	11.43	65.5	13.45	72.5	14.92
	31	40.3	7.28	48.3	8.77	55.8	10.81	61.1	12.71	67.8	14.50	71.5	15.55	75.2	16.74
	33	46.7	8.97	55.8	11.45	63.2	13.91	68.9	15.54	73.3	17.44	75.5	17.92	77.5	17.95
	35	54.0	11.30	64.3	14.54	71.9	16.57	73.9	17.75	75.0	18.85	76.8	19.02	78.9	19.11
	37	54.0	11.97	64.3	15.43	71.9	17.50	72.9	18.81	73.7	19.88	75.7	19.95	77.6	20.00
	39	54.0	12.91	64.3	16.39	70.5	18.46	71.6	20.12	72.6	20.86	74.4	20.90	76.5	20.92
41	52.6	13.85	62.7	17.36	67.5	19.47	68.6	21.76	69.5	21.76	71.5	21.94	73.3	22.11	
43	51.3	14.54	61.1	18.09	64.7	20.64	65.8	20.88	66.6	20.83	68.6	20.95	70.3	21.01	
46	48.0	14.19	57.3	17.46	59.0	19.59	60.1	19.59	60.9	19.76	62.7	19.87	64.3	19.92	
48	42.5	13.78	49.8	16.82	51.3	18.64	52.2	18.76	52.9	18.86	54.5	18.91	56.0	18.98	

# 7. Capacity Tables

Cooling Capacity (24HP)

Combination (%)	Outdoor air temp. (DB, °C)	Indoor air temp. (DB/WB, °C)													
		20		23		26		27		28		30		32	
		14		16		18		19		20		22		24	
		TC	PI	TC	PI	TC	PI	TC	PI	TC	PI	TC	PI	TC	PI
100	10	7.3	0.80	10.0	1.00	13.3	1.22	18.8	1.49	24.8	1.86	35.7	2.48	47.4	3.29
	12	7.3	0.81	10.0	1.01	13.3	1.23	18.8	1.50	24.8	1.88	35.7	2.51	47.4	3.32
	14	7.3	0.82	10.0	1.02	13.3	1.25	18.8	1.52	24.8	1.90	35.7	2.53	47.4	3.35
	16	7.3	0.83	10.0	1.03	13.3	1.26	18.8	1.54	24.8	1.92	35.7	2.56	47.4	3.39
	18	7.3	0.84	10.0	1.05	13.3	1.27	18.8	1.55	24.8	1.94	35.7	2.59	47.4	3.42
	20	7.3	0.85	10.0	1.06	13.3	1.28	18.8	1.57	24.8	1.96	35.7	2.61	47.4	3.46
	21	7.3	0.85	10.0	1.09	16.6	1.60	22.1	1.87	28.3	2.41	38.5	3.28	49.8	3.89
	23	12.7	1.52	17.5	2.03	23.2	2.27	29.1	2.53	35.3	3.62	44.2	4.68	54.6	5.52
	25	18.1	2.40	23.6	3.04	29.8	3.40	36.3	4.00	42.3	5.21	49.9	6.81	59.4	8.01
	27	23.6	3.80	29.7	4.52	36.4	5.09	43.1	6.08	49.3	7.72	55.5	9.74	64.2	11.15
	29	29.0	5.27	35.8	6.09	43.1	7.47	50.1	8.80	56.3	10.49	61.2	12.59	69.1	13.68
	31	34.4	6.68	41.9	8.05	49.7	9.91	57.1	11.66	63.3	13.30	66.8	14.56	74.5	15.51
	33	39.9	8.23	48.0	10.50	56.3	12.76	64.1	14.80	70.4	16.16	72.6	16.44	74.5	16.80
	35	45.4	9.91	54.0	12.65	62.9	15.73	67.2	17.41	70.4	17.51	72.6	17.58	74.5	17.72
	37	45.4	10.61	54.0	13.57	62.9	16.66	67.2	18.24	69.3	18.33	71.3	18.40	73.0	18.57
	39	45.4	11.38	54.0	14.58	62.9	17.65	67.2	19.13	68.1	19.22	70.1	19.29	71.8	19.47
	41	44.6	12.14	53.1	15.59	61.9	18.65	64.5	20.02	65.9	20.10	67.4	20.17	69.6	20.36
43	43.1	12.85	51.3	16.52	59.8	19.54	61.8	20.79	62.5	20.86	64.5	20.93	66.2	21.13	
46	40.4	13.83	48.1	17.81	56.0	20.72	56.4	21.76	57.1	21.83	58.9	21.89	60.5	22.10	
48	35.7	11.94	42.5	15.41	48.3	17.72	49.1	18.47	49.6	18.53	51.2	18.57	52.6	18.72	
90	10	6.6	0.74	9.0	0.92	12.0	1.16	16.6	1.32	22.3	1.71	32.1	2.26	42.6	2.96
	12	6.6	0.75	9.0	0.93	12.0	1.17	16.6	1.34	22.3	1.73	32.1	2.28	42.6	2.99
	14	6.6	0.75	9.0	0.94	12.0	1.18	16.6	1.35	22.3	1.75	32.1	2.31	42.6	3.02
	16	6.6	0.76	9.0	0.95	12.0	1.20	16.6	1.37	22.3	1.77	32.1	2.33	42.6	3.05
	18	6.6	0.77	9.0	0.96	12.0	1.21	16.6	1.38	22.3	1.78	32.1	2.35	42.6	3.08
	20	6.6	0.78	9.0	0.97	12.0	1.22	16.6	1.39	22.3	1.80	32.1	2.38	42.6	3.11
	21	6.6	0.79	9.0	0.98	15.1	1.54	19.6	1.65	25.2	2.16	34.7	2.61	44.8	3.42
	23	9.0	1.22	13.2	1.69	21.0	2.18	25.5	2.38	30.8	3.18	39.9	3.87	49.4	4.71
	25	14.2	2.05	19.2	2.70	27.0	3.23	31.3	3.75	36.4	4.63	45.1	5.85	54.0	6.81
	27	19.5	3.02	25.1	3.85	32.9	5.01	37.1	5.58	42.0	6.76	50.3	7.88	58.5	8.91
	29	24.8	4.08	31.0	5.29	38.9	6.98	43.0	7.71	47.6	8.92	55.5	10.12	63.1	11.79
	31	30.1	5.10	36.9	6.79	44.8	8.74	48.8	9.84	53.2	11.11	60.7	11.78	67.6	13.70
	33	35.4	6.57	42.8	8.36	50.8	10.59	54.6	11.67	58.8	12.92	65.8	13.96	72.2	15.30
	35	40.8	8.14	48.7	10.29	56.6	12.72	60.5	14.03	64.3	15.25	71.0	16.36	72.2	16.74
	37	40.8	8.64	48.7	10.94	56.6	13.56	60.5	14.90	64.3	16.10	69.9	17.10	71.1	17.49
	39	40.8	9.14	48.7	11.64	56.6	14.35	60.5	15.86	64.3	16.93	68.7	18.03	69.9	18.25
	41	39.8	10.23	47.5	12.90	55.2	15.75	58.9	17.34	62.7	18.28	65.8	19.00	67.0	19.44
43	38.8	11.04	46.3	13.94	53.8	17.21	57.5	18.68	61.1	19.60	63.1	20.30	64.3	20.60	
46	36.3	12.43	43.4	15.88	50.4	19.61	53.9	21.18	55.5	21.77	57.6	21.89	58.7	22.10	
48	32.1	10.86	38.4	13.89	44.6	17.16	47.6	18.47	48.2	18.53	50.1	18.57	51.0	18.72	
80	10	5.6	0.65	7.7	0.82	10.3	1.02	14.5	1.18	19.1	1.51	27.5	2.00	36.5	2.61
	12	5.6	0.66	7.7	0.82	10.3	1.04	14.5	1.19	19.1	1.53	27.5	2.02	36.5	2.64
	14	5.6	0.67	7.7	0.83	10.3	1.05	14.5	1.20	19.1	1.55	27.5	2.04	36.5	2.67
	16	5.6	0.67	7.7	0.84	10.3	1.06	14.5	1.22	19.1	1.56	27.5	2.06	36.5	2.70
	18	5.6	0.68	7.7	0.85	10.3	1.07	14.5	1.23	19.1	1.58	27.5	2.08	36.5	2.72
	20	5.6	0.69	7.7	0.86	10.3	1.08	14.5	1.24	19.1	1.59	27.5	2.10	36.5	2.75
	21	5.6	0.69	7.7	0.88	12.9	1.36	17.3	1.49	21.6	1.91	29.9	2.31	38.8	3.03
	23	10.0	1.28	12.8	1.52	18.2	1.93	22.9	2.14	26.7	2.81	34.8	3.42	43.3	4.16
	25	14.4	1.85	17.8	2.43	23.5	2.85	28.5	3.38	31.9	4.10	39.7	5.18	47.8	6.02
	27	18.7	2.72	22.9	3.47	28.8	4.43	34.1	5.02	37.0	5.97	44.6	6.97	52.4	7.87
	29	23.1	3.52	28.0	4.76	34.1	6.17	39.7	6.94	42.1	7.88	49.5	8.94	56.9	10.42
	31	27.5	4.32	33.0	5.99	39.4	7.72	45.2	8.86	48.1	9.56	54.4	10.31	61.5	11.99
	33	31.9	5.68	38.1	7.37	44.7	9.08	50.9	10.51	53.9	10.98	59.3	12.22	66.0	13.50
	35	36.2	7.43	43.2	9.31	50.2	11.43	53.8	12.55	57.4	13.74	64.3	15.59	70.5	16.24
	37	36.2	7.86	43.2	9.90	50.2	12.12	53.8	13.34	57.4	14.60	64.3	16.45	69.4	17.05
	39	36.2	8.31	43.2	10.47	50.2	12.97	53.8	14.34	57.4	15.69	64.3	17.38	68.2	17.99
	41	35.3	9.19	42.1	11.60	48.9	14.23	52.4	15.72	55.9	17.24	62.7	18.62	65.4	19.05
43	34.4	10.12	41.1	12.66	47.7	15.53	51.1	17.14	54.5	18.84	61.1	19.90	62.7	20.39	
46	32.3	11.25	38.5	14.26	44.7	17.50	47.9	19.07	51.1	21.26	55.9	21.89	57.2	22.10	
48	28.6	9.83	34.0	12.47	39.5	15.31	42.4	16.66	45.2	18.53	48.5	18.57	49.7	18.72	

# 7. Capacity Tables

Cooling Capacity (24HP)

Combination (%)	Outdoor air temp. (DB, °C)	Indoor air temp. (DB/WB, °C)													
		20		23		26		27		28		30		32	
		14		16		18		19		20		22		24	
		TC	PI	TC	PI	TC	PI	TC	PI	TC	PI	TC	PI	TC	PI
70	10	4.9	0.58	6.7	0.72	8.9	0.91	12.6	1.05	16.6	1.34	23.9	1.76	31.7	2.31
	12	4.9	0.58	6.7	0.73	8.9	0.92	12.6	1.06	16.6	1.35	23.9	1.78	31.7	2.34
	14	4.9	0.59	6.7	0.74	8.9	0.93	12.6	1.07	16.6	1.37	23.9	1.80	31.7	2.36
	16	4.9	0.60	6.7	0.74	8.9	0.93	12.6	1.08	16.6	1.38	23.9	1.82	31.7	2.38
	18	4.9	0.60	6.7	0.75	8.9	0.94	12.6	1.09	16.6	1.39	23.9	1.84	31.7	2.41
	20	4.9	0.61	6.7	0.76	8.9	0.95	12.6	1.10	16.6	1.41	23.9	1.86	31.7	2.43
	21	4.9	0.61	7.8	0.89	11.6	1.25	15.6	1.39	19.2	1.69	26.4	2.04	34.1	2.68
	23	7.0	0.92	12.1	1.46	16.2	1.83	21.0	1.99	24.4	2.48	31.3	3.03	38.9	3.68
	25	11.2	1.52	16.4	2.15	20.8	2.52	26.4	3.14	29.5	3.62	36.3	4.57	43.6	5.32
	27	15.3	2.21	20.7	3.06	25.4	3.72	31.8	4.67	34.7	5.28	41.2	6.16	48.3	6.96
	29	19.4	2.80	25.0	4.05	30.0	5.06	37.2	6.35	39.8	6.97	46.2	7.91	53.1	9.21
	31	23.5	3.45	29.2	5.03	34.6	6.33	42.6	7.98	45.0	8.45	51.2	9.11	57.8	10.60
	33	27.6	4.64	33.5	6.12	39.3	7.35	47.0	9.27	50.2	9.71	56.2	10.80	62.4	11.93
	35	31.7	6.35	37.9	7.91	43.9	9.57	47.0	10.47	50.2	11.43	56.2	13.46	62.4	14.76
	37	31.7	6.75	37.9	8.38	43.9	10.17	47.0	11.13	50.2	12.16	56.2	14.32	62.4	15.58
	39	31.7	7.16	37.9	8.93	43.9	10.87	47.0	11.98	50.2	13.14	56.2	15.33	62.4	16.79
41	30.9	7.92	36.9	9.79	42.8	11.93	45.8	13.14	48.9	14.28	54.7	16.84	60.8	18.10	
43	30.1	8.62	36.0	10.67	41.7	13.02	44.7	14.33	47.7	15.60	53.4	18.39	59.3	19.57	
46	28.2	9.58	33.8	11.99	39.1	14.66	41.9	15.96	44.7	17.58	50.0	20.75	55.6	21.83	
48	25.0	8.36	29.9	10.48	34.6	12.81	37.1	13.95	39.5	15.38	44.2	18.16	49.2	18.72	
60	10	4.3	0.48	5.8	0.61	7.7	0.76	10.9	0.89	14.4	1.12	20.7	1.48	27.5	1.94
	12	4.3	0.49	5.8	0.61	7.7	0.77	10.9	0.90	14.4	1.14	20.7	1.50	27.5	1.96
	14	4.3	0.50	5.8	0.62	7.7	0.78	10.9	0.91	14.4	1.15	20.7	1.51	27.5	1.98
	16	4.3	0.50	5.8	0.62	7.7	0.78	10.9	0.92	14.4	1.16	20.7	1.53	27.5	2.00
	18	4.3	0.51	5.8	0.63	7.7	0.79	10.9	0.92	14.4	1.17	20.7	1.54	27.5	2.02
	20	4.3	0.51	5.8	0.64	7.7	0.80	10.9	0.93	14.4	1.18	20.7	1.56	27.5	2.04
	21	4.3	0.51	5.8	0.66	9.7	1.03	12.8	1.13	16.5	1.42	22.5	1.72	29.2	2.25
	23	4.3	0.57	9.6	1.20	13.7	1.54	17.8	1.64	20.8	2.09	26.2	2.54	32.7	3.09
	25	8.1	1.08	13.4	1.81	17.7	2.12	22.9	2.81	25.1	3.04	30.4	3.77	36.2	4.47
	27	11.9	1.58	17.2	2.57	21.7	3.12	27.6	3.90	29.4	4.36	34.2	4.99	39.6	5.75
	29	15.7	2.04	21.0	3.30	25.6	4.16	32.6	5.13	33.6	5.56	37.9	6.26	43.1	7.35
	31	19.5	2.60	24.8	3.94	29.6	5.07	36.6	6.16	37.9	6.46	42.5	6.93	46.6	8.47
	33	23.3	3.62	28.6	4.79	33.6	5.69	39.4	6.90	42.3	7.39	45.8	8.21	50.0	9.65
	35	27.1	5.38	32.4	6.59	37.7	7.89	40.3	8.60	43.0	9.33	48.2	10.90	53.5	12.58
	37	27.1	5.69	32.4	6.95	37.7	8.36	40.3	9.13	43.0	9.90	48.2	11.57	53.5	13.38
	39	27.1	6.05	32.4	7.40	37.7	9.03	40.3	9.80	43.0	10.65	48.2	12.41	53.5	14.34
41	26.4	6.56	31.6	8.10	36.7	9.80	39.3	10.70	41.9	11.56	47.0	13.62	52.2	15.58	
43	25.8	7.13	30.8	8.82	35.8	10.68	38.3	11.66	40.8	12.61	45.8	14.87	50.9	17.02	
46	24.2	7.98	28.9	9.90	33.6	12.02	35.9	13.11	38.3	14.19	43.0	16.75	47.7	19.39	
48	21.4	6.95	25.5	8.64	29.7	10.50	31.8	11.45	33.8	12.40	38.0	14.65	42.2	16.96	
50	10	3.9	0.41	5.3	0.51	7.5	0.64	10.0	0.78	13.1	0.94	18.9	1.24	25.1	1.62
	12	3.9	0.41	5.3	0.51	7.5	0.65	10.0	0.79	13.1	0.95	18.9	1.26	25.1	1.64
	14	3.9	0.42	5.3	0.52	7.5	0.65	10.0	0.80	13.1	0.96	18.9	1.27	25.1	1.66
	16	3.9	0.42	5.3	0.52	7.5	0.66	10.0	0.81	13.1	0.97	18.9	1.28	25.1	1.67
	18	3.9	0.42	5.3	0.53	7.5	0.67	10.0	0.82	13.1	0.98	18.9	1.30	25.1	1.69
	20	3.9	0.43	5.3	0.54	7.5	0.67	10.0	0.83	13.1	0.99	18.9	1.31	25.1	1.71
	21	3.9	0.43	5.3	0.55	9.3	0.86	11.8	0.99	14.9	1.19	20.5	1.44	26.5	1.88
	23	3.9	0.46	8.4	0.94	12.9	1.29	16.6	1.55	18.9	1.75	23.7	2.13	29.2	2.58
	25	7.0	0.84	11.5	1.39	16.5	1.81	22.0	2.51	23.3	2.55	26.8	3.00	31.9	3.65
	27	10.1	1.20	14.6	1.96	20.4	2.52	25.5	3.34	27.0	3.44	29.9	3.93	34.7	4.65
	29	13.2	1.57	17.8	2.52	23.6	3.24	28.7	4.14	30.8	4.44	33.0	4.87	37.4	5.87
	31	16.4	2.00	20.9	3.00	26.9	3.95	31.2	4.62	33.0	4.91	36.1	5.26	40.2	6.46
	33	19.5	2.79	24.0	3.61	30.1	4.43	32.4	5.06	34.4	5.42	39.0	6.24	42.9	7.24
	35	22.7	4.48	27.1	5.39	31.4	6.36	33.6	6.90	35.8	7.44	40.1	8.58	44.6	9.86
	37	22.7	4.75	27.1	5.69	31.4	6.73	33.6	7.30	35.8	7.88	40.1	9.15	44.6	10.47
	39	22.7	5.06	27.1	6.10	31.4	7.21	33.6	7.86	35.8	8.45	40.1	9.75	44.6	11.31
41	22.1	5.47	26.4	6.60	30.6	7.89	32.7	8.51	34.8	9.16	39.1	10.69	43.5	12.28	
43	21.6	5.95	25.8	7.18	29.9	8.58	31.9	9.27	34.0	9.97	38.1	11.66	42.4	13.39	
46	20.2	6.66	24.2	8.05	28.0	9.63	29.9	10.41	31.8	11.19	35.7	13.11	39.8	15.08	
48	17.9	5.81	21.4	7.02	24.8	8.40	26.5	9.09	28.2	9.77	31.6	11.46	35.2	13.18	

**Note**

1. TC: Total Capacity(kW), PI : Power Input(kW, Comp. + Outdoor fan motor)
2. Capacity tables show the average value of conditions which may occur.

# 7. Capacity Tables

## ◆ ARUM260LTE5

Cooling Capacity (26HP)

Combination (%)	Outdoor air temp. (DB, °C)	Indoor air temp. (DB/WB, °C)													
		20		23		26		27		28		30		32	
		14	16	16	18	18	19	19	20	20	22	22	24	24	
		TC	PI	TC	PI	TC	PI	TC	PI	TC	PI	TC	PI	TC	PI
130	10	10.2	1.16	14.0	1.44	18.6	1.76	26.3	2.14	34.7	2.68	49.9	3.57	66.2	4.73
	12	10.2	1.17	14.0	1.46	18.6	1.78	26.3	2.17	34.7	2.71	49.9	3.61	66.2	4.78
	14	10.2	1.18	14.0	1.47	18.6	1.79	26.3	2.19	34.7	2.74	49.9	3.65	66.2	4.83
	16	10.2	1.19	14.0	1.49	18.6	1.81	26.3	2.21	34.7	2.76	49.9	3.69	66.2	4.88
	18	10.2	1.21	14.0	1.51	18.6	1.83	26.3	2.23	34.7	2.79	49.9	3.72	66.2	4.93
	20	10.2	1.22	14.0	1.52	18.6	1.85	26.3	2.26	34.7	2.82	49.9	3.76	66.2	4.98
	21	10.2	1.23	14.2	1.57	23.1	2.31	30.6	2.69	38.8	3.47	53.1	4.73	68.3	5.61
	23	17.8	2.18	24.8	2.87	32.1	3.27	40.0	3.64	46.9	5.22	59.7	6.75	72.5	7.95
	25	26.3	3.46	31.9	4.31	41.1	4.89	49.9	5.77	55.1	7.50	66.3	9.80	76.8	11.53
	27	34.4	5.51	40.8	6.51	50.1	7.39	59.3	8.83	63.3	11.21	72.9	14.14	81.0	15.93
	29	42.4	7.65	49.6	8.98	59.1	10.85	68.9	12.78	71.4	15.23	79.5	18.28	85.3	20.34
	31	51.4	10.00	59.7	12.34	69.4	14.97	77.6	17.48	79.6	19.93	84.0	25.04	89.7	25.39
	33	60.5	12.33	70.7	16.10	79.4	19.27	83.9	25.01	85.7	24.84	88.4	25.06	94.4	25.41
	35	72.1	16.65	82.6	20.18	85.3	24.49	86.8	24.61	88.2	24.76	90.6	24.98	93.2	25.08
	37	72.1	17.76	81.5	21.18	84.1	24.17	85.3	24.29	86.8	24.43	89.1	24.65	91.8	24.75
	39	72.1	18.91	80.0	22.30	82.6	23.84	84.1	23.96	85.3	24.11	87.9	24.32	90.6	24.42
41	70.3	20.06	76.7	23.41	79.3	23.52	80.5	23.64	82.1	23.78	84.5	23.99	86.8	24.09	
43	68.5	21.16	73.5	23.08	76.1	23.20	77.2	23.31	78.8	23.45	81.2	23.66	83.4	23.76	
46	64.2	22.64	67.1	22.60	69.5	22.71	70.6	22.83	72.0	22.96	74.3	23.17	76.4	23.26	
48	56.8	22.01	58.2	22.08	60.4	22.13	61.4	22.19	62.7	22.38	64.7	22.52	66.5	22.61	
120	10	9.5	1.08	12.9	1.35	17.2	1.64	24.3	2.01	32.0	2.51	46.0	3.34	61.0	4.43
	12	9.5	1.09	12.9	1.37	17.2	1.66	24.3	2.03	32.0	2.53	46.0	3.38	61.0	4.47
	14	9.5	1.10	12.9	1.38	17.2	1.68	24.3	2.05	32.0	2.56	46.0	3.41	61.0	4.52
	16	9.5	1.12	12.9	1.39	17.2	1.70	24.3	2.07	32.0	2.59	46.0	3.45	61.0	4.57
	18	9.5	1.13	12.9	1.41	17.2	1.71	24.3	2.09	32.0	2.61	46.0	3.48	61.0	4.61
	20	9.5	1.14	12.9	1.42	17.2	1.73	24.3	2.11	32.0	2.64	46.0	3.52	61.0	4.66
	21	9.5	1.15	13.1	1.47	21.8	2.21	28.3	2.51	36.1	3.24	49.3	4.42	63.3	5.24
	23	16.4	2.04	23.5	2.73	30.9	3.14	36.9	3.40	44.7	4.88	56.0	6.31	67.6	7.43
	25	25.6	3.24	33.0	4.09	40.5	4.58	46.0	5.39	53.6	7.01	63.2	9.17	72.0	10.79
	27	35.5	5.12	44.9	6.09	50.3	6.86	54.6	8.20	62.5	10.41	70.4	13.12	76.4	15.02
	29	45.6	7.10	54.1	8.20	59.9	10.07	63.5	11.86	71.4	14.13	77.5	16.96	80.8	19.07
	31	55.2	8.99	65.1	10.84	69.7	13.36	73.1	15.71	80.6	17.92	82.8	21.56	85.6	21.96
	33	63.9	11.09	76.8	14.15	81.4	17.19	82.5	19.94	83.9	23.46	86.2	23.73	88.9	23.92
	35	65.2	14.81	77.6	19.18	82.2	21.22	83.3	25.28	84.8	25.40	87.1	25.48	89.4	25.68
	37	65.2	15.93	77.6	20.24	81.0	22.62	82.2	24.74	83.3	24.87	85.6	24.94	88.0	25.14
	39	65.2	17.15	77.3	21.40	79.6	24.00	80.8	24.24	81.9	24.36	84.5	24.43	86.8	24.62
41	63.6	18.37	73.9	22.55	76.4	23.52	77.5	23.73	78.6	23.85	80.9	23.92	83.2	24.11	
43	62.0	19.61	70.8	22.22	73.3	23.00	74.3	23.22	75.4	23.33	77.7	23.40	79.9	23.59	
46	58.1	21.08	64.6	21.69	66.9	22.27	67.9	22.46	69.0	22.57	71.0	22.64	73.1	22.82	
48	51.4	20.65	56.1	21.31	58.2	21.84	59.1	21.97	60.0	22.04	61.8	22.13	63.7	22.22	
110	10	8.7	1.02	11.8	1.27	15.7	1.54	22.2	1.88	29.3	2.36	42.2	3.14	55.9	4.16
	12	8.7	1.03	11.8	1.28	15.7	1.56	22.2	1.90	29.3	2.38	42.2	3.17	55.9	4.20
	14	8.7	1.04	11.8	1.30	15.7	1.58	22.2	1.92	29.3	2.41	42.2	3.21	55.9	4.25
	16	8.7	1.05	11.8	1.31	15.7	1.59	22.2	1.94	29.3	2.43	42.2	3.24	55.9	4.29
	18	8.7	1.06	11.8	1.32	15.7	1.61	22.2	1.96	29.3	2.45	42.2	3.27	55.9	4.33
	20	8.7	1.07	11.8	1.34	15.7	1.63	22.2	1.98	29.3	2.48	42.2	3.31	55.9	4.38
	21	8.7	1.08	11.8	1.38	19.7	2.03	26.1	2.36	32.6	3.05	45.5	4.16	58.8	4.93
	23	15.5	1.92	19.7	2.56	27.6	2.88	34.1	3.20	41.3	4.59	51.7	5.93	63.9	6.98
	25	22.3	3.04	27.6	3.85	35.5	4.30	42.1	5.07	49.0	6.59	57.8	8.62	68.9	10.14
	27	29.1	4.81	35.5	5.72	43.4	6.44	50.0	7.70	57.2	9.78	64.4	12.33	74.5	14.12
	29	35.9	6.67	43.4	7.71	51.4	9.46	58.1	11.14	65.3	13.28	70.9	15.62	78.6	17.32
	31	43.6	8.45	52.4	10.19	60.4	12.55	66.2	14.77	73.4	16.84	77.5	18.06	81.5	19.44
	33	50.6	10.42	60.4	13.30	68.5	16.15	74.7	18.05	79.4	20.26	81.8	20.82	83.9	20.85
	35	58.4	13.12	69.7	16.88	77.8	19.25	80.1	20.62	81.2	21.89	83.2	22.09	85.4	22.20
	37	58.4	13.91	69.7	17.92	77.8	20.32	79.0	21.85	79.8	23.09	82.1	23.17	84.0	23.23
	39	58.4	14.99	69.7	19.04	76.4	21.44	77.5	23.37	78.7	24.23	80.6	24.27	82.9	24.29
41	57.0	16.08	67.9	20.16	73.2	22.61	74.3	25.28	75.3	25.28	77.5	25.48	79.4	25.68	
43	55.5	16.88	66.2	21.01	70.1	23.97	71.3	24.25	72.2	24.19	74.3	24.33	76.2	24.40	
46	52.1	16.48	62.1	20.28	64.0	22.75	65.1	22.75	65.9	22.95	67.9	23.08	69.7	23.14	
48	46.0	16.01	53.9	19.54	55.6	21.65	56.6	21.79	57.3	21.90	59.1	21.96	60.6	22.05	

# 7. Capacity Tables

Cooling Capacity (26HP)

Combination (%)	Outdoor air temp. (DB, °C)	Indoor air temp. (DB/WB, °C)													
		20		23		26		27		28		30		32	
		14		16		18		19		20		22		24	
		TC	PI	TC	PI	TC	PI	TC	PI	TC	PI	TC	PI	TC	PI
100	10	7.9	0.93	10.8	1.16	14.4	1.42	20.4	1.73	26.9	2.16	38.7	2.88	51.3	3.82
	12	7.9	0.94	10.8	1.18	14.4	1.43	20.4	1.75	26.9	2.18	38.7	2.91	51.3	3.86
	14	7.9	0.95	10.8	1.19	14.4	1.45	20.4	1.77	26.9	2.21	38.7	2.94	51.3	3.90
	16	7.9	0.96	10.8	1.20	14.4	1.46	20.4	1.78	26.9	2.23	38.7	2.97	51.3	3.94
	18	7.9	0.97	10.8	1.21	14.4	1.48	20.4	1.80	26.9	2.25	38.7	3.00	51.3	3.98
	20	7.9	0.98	10.8	1.23	14.4	1.49	20.4	1.82	26.9	2.27	38.7	3.03	51.3	4.02
	21	7.9	0.99	10.8	1.26	18.0	1.86	23.9	2.17	30.6	2.79	41.8	3.81	53.9	4.52
	23	13.8	1.76	19.0	2.35	25.2	2.64	31.5	2.93	38.2	4.21	47.9	5.44	59.2	6.41
	25	19.7	2.79	25.6	3.53	32.3	3.94	39.3	4.65	45.8	6.05	54.0	7.91	64.4	9.30
	27	25.5	4.41	32.2	5.25	39.5	5.91	46.7	7.07	53.4	8.97	60.1	11.31	69.6	12.95
	29	31.4	6.12	38.8	7.07	46.7	8.68	54.3	10.22	61.0	12.18	66.3	14.62	74.8	15.89
	31	37.3	7.75	45.4	9.35	53.8	11.52	61.9	13.55	68.6	15.45	72.4	16.91	80.7	18.02
	33	43.2	9.56	52.0	12.20	61.0	14.82	69.5	17.19	76.3	18.77	78.7	19.10	80.7	19.51
	35	49.1	11.51	58.5	14.69	68.1	18.26	72.8	20.22	76.3	20.34	78.7	20.42	80.7	20.58
	37	49.1	12.33	58.5	15.76	68.1	19.35	72.8	21.18	75.0	21.29	77.2	21.37	79.0	21.57
	39	49.1	13.22	58.5	16.93	68.1	20.50	72.8	22.22	73.8	22.32	76.0	22.40	77.7	22.61
	41	48.4	14.11	57.6	18.10	67.0	21.65	69.9	23.25	71.4	23.35	73.1	23.43	75.4	23.65
	43	46.7	14.93	55.6	19.19	64.7	22.69	67.0	24.14	67.7	24.23	69.8	24.31	71.7	24.54
46	43.8	16.06	52.1	20.69	60.7	24.07	61.2	25.28	61.8	25.35	63.8	25.42	65.5	25.66	
48	38.7	13.86	46.1	17.90	52.4	20.57	53.1	21.45	53.7	21.52	55.5	21.56	57.0	21.74	
90	10	7.1	0.86	9.7	1.07	13.0	1.35	18.0	1.54	24.2	1.99	34.8	2.62	46.2	3.43
	12	7.1	0.87	9.7	1.08	13.0	1.36	18.0	1.55	24.2	2.01	34.8	2.65	46.2	3.47
	14	7.1	0.88	9.7	1.09	13.0	1.37	18.0	1.57	24.2	2.03	34.8	2.68	46.2	3.51
	16	7.1	0.89	9.7	1.11	13.0	1.39	18.0	1.59	24.2	2.05	34.8	2.71	46.2	3.54
	18	7.1	0.89	9.7	1.12	13.0	1.40	18.0	1.60	24.2	2.07	34.8	2.73	46.2	3.58
	20	7.1	0.90	9.7	1.13	13.0	1.42	18.0	1.62	24.2	2.09	34.8	2.76	46.2	3.61
	21	7.1	0.91	9.7	1.14	16.3	1.79	21.3	1.92	27.3	2.51	37.6	3.04	48.6	3.98
	23	9.7	1.41	14.3	1.96	22.8	2.53	27.6	2.76	33.3	3.69	43.2	4.50	53.5	5.47
	25	15.4	2.39	20.7	3.14	29.2	3.75	33.9	4.36	39.4	5.38	48.8	6.80	58.5	7.91
	27	21.2	3.51	27.2	4.47	35.7	5.82	40.2	6.48	45.5	7.85	54.5	9.15	63.4	10.34
	29	26.9	4.74	33.6	6.14	42.1	8.10	46.6	8.96	51.5	10.36	60.1	11.75	68.3	13.69
	31	32.6	5.93	40.0	7.89	48.6	10.15	52.9	11.43	57.6	12.90	65.7	13.68	73.3	15.91
	33	38.4	7.63	46.4	9.71	55.0	12.30	59.2	13.56	63.7	15.00	71.3	16.21	78.2	17.77
	35	44.2	9.45	52.8	11.95	61.4	14.77	65.5	16.29	69.7	17.71	76.9	19.00	82.2	19.44
	37	44.2	10.03	52.8	12.71	61.4	15.75	65.5	17.31	69.7	18.70	75.7	19.86	77.0	20.31
	39	44.2	10.62	52.8	13.52	61.4	16.67	65.5	18.42	69.7	19.66	74.4	20.94	75.7	21.19
	41	43.1	11.88	51.4	14.99	59.8	18.30	63.8	20.14	67.9	21.23	71.3	22.07	72.6	22.58
	43	42.0	12.83	50.2	16.19	58.3	19.99	62.3	21.69	66.2	22.76	68.4	23.58	69.6	23.92
46	39.4	14.44	47.0	18.44	54.6	22.77	58.4	24.59	60.2	25.29	62.4	25.42	63.6	25.66	
48	34.8	12.62	41.6	16.13	48.3	19.92	51.6	21.45	52.2	21.52	54.3	21.56	55.3	21.74	
80	10	6.1	0.76	8.3	0.95	11.1	1.19	15.7	1.37	20.7	1.76	29.8	2.32	39.5	3.04
	12	6.1	0.77	8.3	0.96	11.1	1.20	15.7	1.38	20.7	1.78	29.8	2.34	39.5	3.07
	14	6.1	0.77	8.3	0.97	11.1	1.22	15.7	1.40	20.7	1.79	29.8	2.37	39.5	3.10
	16	6.1	0.78	8.3	0.98	11.1	1.23	15.7	1.41	20.7	1.81	29.8	2.39	39.5	3.13
	18	6.1	0.79	8.3	0.99	11.1	1.24	15.7	1.43	20.7	1.83	29.8	2.42	39.5	3.16
	20	6.1	0.80	8.3	1.00	11.1	1.25	15.7	1.44	20.7	1.85	29.8	2.44	39.5	3.20
	21	6.1	0.80	8.3	1.03	14.0	1.58	18.7	1.73	23.4	2.22	32.4	2.68	42.0	3.52
	23	10.8	1.48	13.8	1.76	19.7	2.24	24.8	2.48	29.0	3.26	37.7	3.98	46.9	4.84
	25	15.6	2.15	19.3	2.83	25.5	3.31	30.8	3.92	34.5	4.76	43.0	6.01	51.8	6.99
	27	20.3	3.16	24.8	4.02	31.2	5.14	36.9	5.83	40.0	6.94	48.3	8.09	56.8	9.14
	29	25.0	4.09	30.3	5.53	37.0	7.16	43.0	8.06	45.6	9.16	53.6	10.39	61.7	12.11
	31	29.8	5.01	35.8	6.96	42.7	8.97	49.0	10.29	52.1	11.10	59.0	11.97	66.6	13.93
	33	34.5	6.59	41.3	8.56	48.5	10.54	55.1	12.20	58.3	12.75	64.3	14.19	71.5	15.68
	35	39.3	8.63	46.8	10.82	54.3	13.27	58.2	14.58	62.1	15.96	69.7	18.10	76.4	18.86
	37	39.3	9.13	46.8	11.50	54.3	14.08	58.2	15.50	62.1	16.95	69.7	19.11	75.2	19.81
	39	39.3	9.65	46.8	12.16	54.3	15.06	58.2	16.66	62.1	18.22	69.7	20.19	73.9	20.89
	41	38.3	10.67	45.6	13.47	52.9	16.53	56.7	18.26	60.5	20.02	67.9	21.63	70.8	22.13
	43	37.3	11.75	44.5	14.70	51.6	18.04	55.3	19.90	59.1	21.88	66.2	23.11	67.9	23.68
46	35.0	13.07	41.7	16.56	48.4	20.33	51.9	22.15	55.3	24.69	60.6	25.42	62.0	25.66	
48	30.9	11.41	36.9	14.48	42.8	17.78	45.9	19.35	49.0	21.52	52.6	21.56	53.9	21.74	



# 7. Capacity Tables

Cooling Capacity (26HP)

Combination (%)	Outdoor air temp. (DB, °C)	Indoor air temp. (DB/WB, °C)													
		20		23		26		27		28		30		32	
		14		16		18		19		20		22		24	
		TC	PI	TC	PI	TC	PI	TC	PI	TC	PI	TC	PI	TC	PI
70	10	5.3	0.67	7.3	0.84	9.7	1.05	13.7	1.22	18.0	1.55	25.9	2.05	34.4	2.68
	12	5.3	0.68	7.3	0.85	9.7	1.06	13.7	1.23	18.0	1.57	25.9	2.07	34.4	2.71
	14	5.3	0.68	7.3	0.86	9.7	1.07	13.7	1.24	18.0	1.59	25.9	2.09	34.4	2.74
	16	5.3	0.69	7.3	0.86	9.7	1.09	13.7	1.26	18.0	1.60	25.9	2.11	34.4	2.77
	18	5.3	0.70	7.3	0.87	9.7	1.10	13.7	1.27	18.0	1.62	25.9	2.14	34.4	2.80
	20	5.3	0.71	7.3	0.88	9.7	1.11	13.7	1.28	18.0	1.64	25.9	2.16	34.4	2.82
	21	5.3	0.71	8.5	1.04	12.6	1.45	16.9	1.61	20.8	1.96	28.6	2.37	37.0	3.11
	23	7.6	1.07	13.1	1.69	17.6	2.13	22.8	2.31	26.4	2.88	33.9	3.52	42.1	4.27
	25	12.1	1.76	17.7	2.50	22.6	2.93	28.6	3.65	32.0	4.20	39.3	5.31	47.2	6.18
	27	16.5	2.57	22.4	3.56	27.5	4.32	34.5	5.42	37.6	6.13	44.7	7.15	52.4	8.08
	29	21.0	3.25	27.0	4.70	32.5	5.87	40.3	7.38	43.2	8.09	50.1	9.18	57.5	10.70
	31	25.5	4.00	31.7	5.84	37.5	7.35	46.2	9.27	48.8	9.81	55.4	10.58	62.6	12.31
	33	29.9	5.39	36.3	7.11	42.5	8.54	51.0	10.76	54.3	11.27	60.8	12.54	67.6	13.86
	35	34.3	7.37	41.1	9.19	47.6	11.12	51.0	12.16	54.3	13.28	60.8	15.63	67.6	17.14
	37	34.3	7.84	41.1	9.73	47.6	11.81	51.0	12.93	54.3	14.13	60.8	16.64	67.6	18.09
	39	34.3	8.32	41.1	10.38	47.6	12.63	51.0	13.91	54.3	15.26	60.8	17.80	67.6	19.50
41	33.4	9.20	40.0	11.37	46.4	13.85	49.7	15.26	52.9	16.59	59.3	19.56	65.9	21.02	
43	32.6	10.01	39.0	12.39	45.2	15.12	48.4	16.64	51.6	18.12	57.8	21.36	64.2	22.73	
46	30.6	11.13	36.6	13.93	42.4	17.02	45.4	18.53	48.4	20.42	54.2	24.10	60.2	25.35	
48	27.0	9.71	32.4	12.17	37.5	14.88	40.1	16.20	42.8	17.87	47.9	21.09	53.3	21.74	
60	10	4.7	0.56	6.3	0.70	8.4	0.88	11.8	1.03	15.6	1.30	22.4	1.72	29.8	2.25
	12	4.7	0.57	6.3	0.71	8.4	0.89	11.8	1.04	15.6	1.32	22.4	1.74	29.8	2.28
	14	4.7	0.58	6.3	0.72	8.4	0.90	11.8	1.05	15.6	1.33	22.4	1.76	29.8	2.30
	16	4.7	0.58	6.3	0.73	8.4	0.91	11.8	1.06	15.6	1.35	22.4	1.78	29.8	2.32
	18	4.7	0.59	6.3	0.73	8.4	0.92	11.8	1.07	15.6	1.36	22.4	1.79	29.8	2.35
	20	4.7	0.59	6.3	0.74	8.4	0.93	11.8	1.08	15.6	1.37	22.4	1.81	29.8	2.37
	21	4.7	0.60	6.3	0.77	10.5	1.19	13.9	1.32	17.9	1.65	24.4	1.99	31.7	2.61
	23	4.7	0.66	10.4	1.39	14.8	1.79	19.2	1.91	22.5	2.42	28.3	2.95	35.4	3.59
	25	8.7	1.25	14.5	2.10	19.1	2.46	24.8	3.26	27.2	3.53	33.0	4.37	39.2	5.19
	27	12.8	1.83	18.6	2.99	23.5	3.63	29.9	4.53	31.8	5.07	37.0	5.79	42.9	6.68
	29	17.0	2.37	22.8	3.83	27.8	4.83	35.3	5.96	36.4	6.46	41.1	7.27	46.7	8.54
	31	21.1	3.02	26.9	4.58	32.1	5.89	39.6	7.15	41.1	7.50	46.0	8.04	50.4	9.84
	33	25.2	4.20	31.0	5.57	36.4	6.61	42.7	8.02	45.8	8.59	49.7	9.53	54.2	11.21
	35	29.4	6.25	35.1	7.65	40.8	9.17	43.7	9.98	46.5	10.84	52.3	12.66	58.0	14.61
	37	29.4	6.60	35.1	8.08	40.8	9.71	43.7	10.60	46.5	11.50	52.3	13.44	58.0	15.54
	39	29.4	7.02	35.1	8.60	40.8	10.48	43.7	11.38	46.5	12.37	52.3	14.41	58.0	16.65
41	28.6	7.62	34.2	9.41	39.8	11.38	42.6	12.43	45.3	13.43	50.9	15.82	56.5	18.09	
43	27.9	8.28	33.4	10.24	38.8	12.41	41.5	13.54	44.2	14.65	49.7	17.26	55.1	19.76	
46	26.2	9.27	31.3	11.50	36.4	13.96	38.9	15.22	41.4	16.48	46.5	19.45	51.6	22.52	
48	23.1	8.08	27.7	10.04	32.2	12.19	34.4	13.30	36.7	14.40	41.2	17.01	45.7	19.70	
50	10	4.2	0.47	5.7	0.59	8.1	0.74	10.8	0.91	14.2	1.10	20.5	1.45	27.2	1.88
	12	4.2	0.48	5.7	0.60	8.1	0.75	10.8	0.92	14.2	1.11	20.5	1.46	27.2	1.90
	14	4.2	0.48	5.7	0.60	8.1	0.76	10.8	0.93	14.2	1.12	20.5	1.48	27.2	1.92
	16	4.2	0.49	5.7	0.61	8.1	0.77	10.8	0.94	14.2	1.13	20.5	1.49	27.2	1.94
	18	4.2	0.49	5.7	0.62	8.1	0.77	10.8	0.95	14.2	1.14	20.5	1.51	27.2	1.96
	20	4.2	0.50	5.7	0.62	8.1	0.78	10.8	0.96	14.2	1.15	20.5	1.52	27.2	1.98
	21	4.2	0.50	5.7	0.64	10.1	1.00	12.7	1.15	16.2	1.38	22.2	1.67	28.7	2.18
	23	4.2	0.53	9.1	1.10	13.9	1.50	18.0	1.79	20.5	2.03	25.6	2.48	31.6	3.00
	25	7.6	0.97	12.5	1.61	17.8	2.10	23.8	2.91	25.2	2.97	29.0	3.49	34.6	4.24
	27	10.9	1.39	15.9	2.27	22.1	2.93	27.6	3.88	29.3	4.00	32.4	4.57	37.6	5.40
	29	14.3	1.83	19.2	2.93	25.6	3.77	31.0	4.81	33.4	5.15	35.8	5.66	40.5	6.81
	31	17.7	2.32	22.6	3.48	29.1	4.59	33.8	5.37	35.7	5.70	39.1	6.11	43.5	7.50
	33	21.1	3.24	26.0	4.19	32.7	5.15	35.1	5.88	37.2	6.30	42.3	7.24	46.4	8.41
	35	24.6	5.20	29.4	6.25	34.1	7.39	36.4	8.01	38.7	8.64	43.4	9.97	48.4	11.45
	37	24.6	5.51	29.4	6.61	34.1	7.82	36.4	8.48	38.7	9.15	43.4	10.63	48.4	12.16
	39	24.6	5.88	29.4	7.08	34.1	8.38	36.4	9.13	38.7	9.81	43.4	11.32	48.4	13.13
41	23.9	6.36	28.6	7.67	33.2	9.16	35.5	9.89	37.7	10.63	42.3	12.41	47.1	14.26	
43	23.3	6.91	27.9	8.34	32.4	9.97	34.6	10.77	36.8	11.58	41.3	13.54	46.0	15.55	
46	21.9	7.74	26.2	9.35	30.3	11.18	32.4	12.09	34.5	13.00	38.7	15.23	43.1	17.51	
48	19.4	6.74	23.1	8.16	26.8	9.75	28.7	10.55	30.5	11.34	34.2	13.31	38.1	15.31	

**Note**

1. TC: Total Capacity(kW), PI : Power Input(kW, Comp. + Outdoor fan motor)
2. Capacity tables show the average value of conditions which may occur.

# 7. Capacity Tables

◆ ARUM221LTE5

Cooling Capacity (22HP)

Combination (%)	Outdoor air temp. (DB, °C)	Indoor air temp. (DB/WB, °C)													
		20		23		26		27		28		30		32	
		14	16	16	18	19	20	22	24	22	24	24	24		
		TC	PI	TC	PI	TC	PI	TC	PI	TC	PI	TC	PI	TC	PI
130	10	8.7	0.83	11.8	1.04	15.8	1.26	22.2	1.54	29.3	1.93	42.2	2.57	56.0	3.40
	12	8.7	0.84	11.8	1.05	15.8	1.28	22.2	1.56	29.3	1.95	42.2	2.60	56.0	3.44
	14	8.7	0.85	11.8	1.06	15.8	1.29	22.2	1.57	29.3	1.97	42.2	2.62	56.0	3.47
	16	8.7	0.86	11.8	1.07	15.8	1.30	22.2	1.59	29.3	1.99	42.2	2.65	56.0	3.51
	18	8.7	0.87	11.8	1.08	15.8	1.32	22.2	1.61	29.3	2.01	42.2	2.68	56.0	3.55
	20	8.7	0.88	11.8	1.09	15.8	1.33	22.2	1.62	29.3	2.03	42.2	2.70	56.0	3.58
	21	8.7	0.88	12.0	1.13	19.5	1.66	25.9	1.93	32.8	2.49	45.0	3.40	57.8	4.03
	23	15.1	1.57	21.0	2.06	27.1	2.35	33.9	2.62	39.7	3.75	50.5	4.85	61.4	5.71
	25	22.3	2.49	27.0	3.10	34.7	3.52	42.2	4.15	46.6	5.39	56.1	7.05	65.0	8.29
	27	29.1	3.96	34.5	4.68	42.4	5.31	50.2	6.35	53.5	8.06	61.7	10.17	68.6	11.45
	29	35.9	5.50	42.0	6.46	50.0	7.80	58.3	9.19	60.4	10.95	67.3	13.14	72.2	14.63
	31	43.5	7.19	50.5	8.87	58.7	10.76	65.7	12.57	67.4	14.33	71.1	18.00	75.9	18.26
	33	51.2	8.86	59.8	11.58	67.2	13.85	71.0	17.99	72.5	17.86	74.8	18.02	79.8	18.27
	35	61.0	11.97	69.9	14.51	72.2	17.61	73.4	17.70	74.6	17.81	76.6	17.97	78.9	18.04
	37	61.0	12.77	68.9	15.23	71.2	17.38	72.2	17.47	73.4	17.57	75.4	17.73	77.6	17.80
	39	61.0	13.60	67.7	16.03	69.9	17.15	71.2	17.23	72.2	17.34	74.4	17.49	76.6	17.56
	41	59.5	14.42	64.9	16.83	67.1	16.91	68.1	17.00	69.4	17.10	71.5	17.25	73.5	17.32
	43	58.0	15.21	62.2	16.60	64.4	16.68	65.3	16.76	66.6	16.87	68.7	17.02	70.6	17.08
46	54.3	16.28	56.7	16.25	58.8	16.33	59.7	16.41	61.0	16.51	62.9	16.66	64.6	16.73	
48	48.1	15.83	49.3	15.88	51.1	15.91	51.9	15.95	53.0	16.09	54.7	16.19	56.3	16.26	
120	10	8.0	0.78	10.9	0.97	14.5	1.18	20.5	1.44	27.1	1.80	38.9	2.40	51.7	3.18
	12	8.0	0.79	10.9	0.98	14.5	1.19	20.5	1.46	27.1	1.82	38.9	2.43	51.7	3.22
	14	8.0	0.79	10.9	0.99	14.5	1.21	20.5	1.47	27.1	1.84	38.9	2.45	51.7	3.25
	16	8.0	0.80	10.9	1.00	14.5	1.22	20.5	1.49	27.1	1.86	38.9	2.48	51.7	3.28
	18	8.0	0.81	10.9	1.01	14.5	1.23	20.5	1.50	27.1	1.88	38.9	2.51	51.7	3.32
	20	8.0	0.82	10.9	1.02	14.5	1.24	20.5	1.52	27.1	1.90	38.9	2.53	51.7	3.35
	21	8.0	0.83	11.1	1.05	18.4	1.59	23.9	1.81	30.6	2.33	41.7	3.18	53.5	3.77
	23	13.9	1.47	19.9	1.96	26.2	2.26	31.2	2.45	37.8	3.51	47.4	4.54	57.2	5.34
	25	21.6	2.33	27.9	2.94	34.3	3.29	38.9	3.88	45.4	5.04	53.5	6.59	60.9	7.76
	27	30.0	3.68	38.0	4.38	42.5	4.93	46.2	5.89	52.9	7.48	59.5	9.43	64.6	10.80
	29	38.6	5.11	45.7	5.90	50.7	7.24	53.7	8.53	60.4	10.16	65.6	12.20	68.4	13.71
	31	46.7	6.47	55.1	7.80	58.9	9.61	61.9	11.30	68.2	12.89	70.0	15.50	72.4	15.79
	33	54.1	7.97	65.0	10.18	68.9	12.36	69.8	14.34	71.0	16.87	73.0	17.06	75.2	17.20
	35	55.2	10.65	65.6	13.80	69.6	15.26	70.5	18.18	71.7	18.27	73.7	18.32	75.6	18.47
	37	55.2	11.46	65.6	14.56	68.6	16.27	69.6	17.79	70.5	17.88	72.5	17.94	74.4	18.08
	39	55.2	12.33	65.4	15.39	67.4	17.26	68.3	17.43	69.3	17.51	71.5	17.57	73.4	17.71
	41	53.8	13.21	62.6	16.21	64.7	16.92	65.6	17.06	66.5	17.15	68.5	17.20	70.4	17.33
	43	52.5	14.10	59.9	15.98	62.0	16.54	62.9	16.70	63.8	16.78	65.7	16.83	67.6	16.96
46	49.2	15.16	54.7	15.60	56.6	16.02	57.5	16.15	58.3	16.23	60.1	16.28	61.9	16.41	
48	43.5	14.85	47.5	15.32	49.2	15.70	50.0	15.80	50.7	15.85	52.3	15.91	53.9	15.98	
110	10	7.3	0.73	10.0	0.91	13.3	1.11	18.8	1.36	24.8	1.69	35.7	2.26	47.3	2.99
	12	7.3	0.74	10.0	0.92	13.3	1.12	18.8	1.37	24.8	1.71	35.7	2.28	47.3	3.02
	14	7.3	0.75	10.0	0.93	13.3	1.13	18.8	1.38	24.8	1.73	35.7	2.31	47.3	3.05
	16	7.3	0.75	10.0	0.94	13.3	1.15	18.8	1.40	24.8	1.75	35.7	2.33	47.3	3.09
	18	7.3	0.76	10.0	0.95	13.3	1.16	18.8	1.41	24.8	1.77	35.7	2.35	47.3	3.12
	20	7.3	0.77	10.0	0.96	13.3	1.17	18.8	1.43	24.8	1.78	35.7	2.38	47.3	3.15
	21	7.3	0.78	10.0	0.99	16.7	1.46	22.1	1.70	27.6	2.19	38.5	2.99	49.7	3.54
	23	13.1	1.38	16.7	1.84	23.4	2.07	28.8	2.30	34.9	3.30	43.8	4.26	54.1	5.02
	25	18.9	2.19	23.4	2.77	30.1	3.09	35.6	3.65	41.5	4.74	48.9	6.20	58.3	7.29
	27	24.6	3.46	30.1	4.11	36.8	4.63	42.3	5.54	48.4	7.03	54.5	8.86	63.0	10.15
	29	30.4	4.80	36.8	5.54	43.5	6.80	49.2	8.01	55.2	9.55	60.0	11.23	66.5	12.46
	31	36.9	6.08	44.3	7.33	51.1	9.03	56.0	10.62	62.1	12.11	65.6	12.99	68.9	13.98
	33	42.8	7.49	51.1	9.56	58.0	11.62	63.2	12.98	67.2	14.57	69.2	14.97	71.0	14.99
	35	49.5	9.44	59.0	12.14	65.9	13.84	67.7	14.83	68.7	15.74	70.4	15.88	72.3	15.96
	37	49.5	10.00	59.0	12.88	65.9	14.61	66.8	15.71	67.5	16.60	69.4	16.66	71.1	16.71
	39	49.5	10.78	59.0	13.69	64.7	15.42	65.6	16.80	66.6	17.42	68.2	17.45	70.1	17.47
	41	48.2	11.56	57.5	14.50	61.9	16.26	62.9	18.18	63.7	18.18	65.5	18.32	67.2	18.47
	43	47.0	12.14	56.0	15.10	59.3	17.24	60.3	17.43	61.1	17.40	62.9	17.50	64.5	17.54
46	44.0	11.85	52.5	14.58	54.1	16.36	55.1	16.36	55.8	16.50	57.5	16.59	59.0	16.64	
48	39.0	11.51	45.6	14.05	47.0	15.57	47.9	15.67	48.5	15.75	50.0	15.79	51.3	15.85	

# 7. Capacity Tables

Cooling Capacity (22HP)

Combination (%)	Outdoor air temp. (DB, °C)	Indoor air temp. (DB/WB, °C)													
		20		23		26		27		28		30		32	
		14		16		18		19		20		22		24	
		TC	PI	TC	PI	TC	PI	TC	PI	TC	PI	TC	PI	TC	PI
100	10	6.7	0.67	9.2	0.84	12.2	1.02	17.2	1.24	22.7	1.55	32.7	2.07	43.4	2.74
	12	6.7	0.68	9.2	0.85	12.2	1.03	17.2	1.26	22.7	1.57	32.7	2.09	43.4	2.77
	14	6.7	0.68	9.2	0.86	12.2	1.04	17.2	1.27	22.7	1.59	32.7	2.12	43.4	2.80
	16	6.7	0.69	9.2	0.86	12.2	1.05	17.2	1.28	22.7	1.60	32.7	2.14	43.4	2.83
	18	6.7	0.70	9.2	0.87	12.2	1.06	17.2	1.30	22.7	1.62	32.7	2.16	43.4	2.86
	20	6.7	0.71	9.2	0.88	12.2	1.07	17.2	1.31	22.7	1.64	32.7	2.18	43.4	2.89
	21	6.7	0.71	9.2	0.91	15.2	1.34	20.3	1.56	25.9	2.01	35.3	2.74	45.6	3.25
	23	11.7	1.27	16.1	1.69	21.3	1.90	26.7	2.11	32.3	3.03	40.5	3.91	50.1	4.61
	25	16.6	2.01	21.7	2.54	27.4	2.84	33.3	3.34	38.8	4.35	45.7	5.69	54.5	6.69
	27	21.6	3.17	27.2	3.78	33.4	4.25	39.5	5.08	45.2	6.45	50.9	8.13	58.9	9.31
	29	26.6	4.40	32.8	5.08	39.5	6.24	45.9	7.35	51.6	8.76	56.1	10.51	63.3	11.43
	31	31.6	5.58	38.4	6.72	45.5	8.28	52.4	9.74	58.1	11.11	61.3	12.16	68.3	12.96
	33	36.5	6.87	44.0	8.77	51.6	10.66	58.8	12.36	64.6	13.50	66.6	13.73	68.3	14.03
	35	41.6	8.28	49.5	10.57	57.6	13.13	61.6	14.54	64.6	14.63	66.6	14.68	68.3	14.80
	37	41.6	8.86	49.5	11.33	57.6	13.91	61.6	15.23	63.5	15.31	65.3	15.37	66.9	15.51
	39	41.6	9.50	49.5	12.18	57.6	14.74	61.6	15.98	62.4	16.05	64.3	16.11	65.8	16.26
	41	40.9	10.14	48.7	13.02	56.7	15.57	59.1	16.72	60.4	16.79	61.8	16.85	63.8	17.00
43	39.5	10.73	47.0	13.80	54.8	16.32	56.7	17.36	57.3	17.42	59.1	17.48	60.6	17.64	
46	37.0	11.55	44.1	14.88	51.3	17.31	51.7	18.18	52.3	18.23	54.0	18.28	55.4	18.45	
48	32.8	9.97	39.0	12.87	44.3	14.79	45.0	15.42	45.4	15.47	46.9	15.51	48.2	15.63	
90	10	6.0	0.62	8.2	0.77	11.0	0.97	15.2	1.11	20.5	1.43	29.5	1.89	39.1	2.47
	12	6.0	0.62	8.2	0.78	11.0	0.98	15.2	1.12	20.5	1.44	29.5	1.91	39.1	2.50
	14	6.0	0.63	8.2	0.79	11.0	0.99	15.2	1.13	20.5	1.46	29.5	1.93	39.1	2.52
	16	6.0	0.64	8.2	0.79	11.0	1.00	15.2	1.14	20.5	1.47	29.5	1.95	39.1	2.55
	18	6.0	0.64	8.2	0.80	11.0	1.01	15.2	1.15	20.5	1.49	29.5	1.97	39.1	2.57
	20	6.0	0.65	8.2	0.81	11.0	1.02	15.2	1.16	20.5	1.50	29.5	1.99	39.1	2.60
	21	6.0	0.66	8.2	0.82	13.8	1.28	18.0	1.38	23.1	1.81	31.8	2.18	41.1	2.86
	23	8.2	1.02	12.1	1.41	19.3	1.82	23.4	1.98	28.2	2.65	36.6	3.23	45.3	3.93
	25	13.1	1.72	17.6	2.26	24.7	2.69	28.7	3.13	33.3	3.87	41.3	4.89	49.5	5.69
	27	17.9	2.52	23.0	3.22	30.2	4.18	34.1	4.66	38.5	5.64	46.1	6.58	53.6	7.44
	29	22.8	3.41	28.4	4.42	35.6	5.83	39.4	6.44	43.6	7.45	50.8	8.45	57.8	9.85
	31	27.6	4.26	33.8	5.67	41.1	7.30	44.7	8.22	48.8	9.28	55.6	9.84	62.0	11.44
	33	32.5	5.49	39.2	6.98	46.5	8.84	50.1	9.75	53.9	10.79	60.4	11.66	66.2	12.78
	35	37.4	6.80	44.7	8.59	51.9	10.62	55.4	11.72	59.0	12.74	65.1	13.66	66.2	13.98
	37	37.4	7.21	44.7	9.14	51.9	11.33	55.4	12.45	59.0	13.45	64.0	14.28	65.1	14.60
	39	37.4	7.64	44.7	9.72	51.9	11.99	55.4	13.24	59.0	14.14	63.0	15.06	64.1	15.24
	41	36.4	8.54	43.5	10.78	50.6	13.16	54.0	14.48	57.5	15.27	60.4	15.87	61.4	16.23
43	35.5	9.22	42.4	11.64	49.3	14.37	52.7	15.60	56.0	16.37	57.9	16.96	58.9	17.20	
46	33.3	10.38	39.8	13.26	46.2	16.37	49.4	17.68	50.9	18.18	52.8	18.28	53.8	18.45	
48	29.5	9.07	35.2	11.60	40.9	14.33	43.7	15.42	44.2	15.47	45.9	15.51	46.8	15.63	
80	10	5.2	0.55	7.1	0.68	9.4	0.86	13.3	0.98	17.5	1.26	25.2	1.67	33.4	2.18
	12	5.2	0.55	7.1	0.69	9.4	0.86	13.3	1.00	17.5	1.28	25.2	1.68	33.4	2.21
	14	5.2	0.56	7.1	0.70	9.4	0.87	13.3	1.01	17.5	1.29	25.2	1.70	33.4	2.23
	16	5.2	0.56	7.1	0.70	9.4	0.88	13.3	1.02	17.5	1.30	25.2	1.72	33.4	2.25
	18	5.2	0.57	7.1	0.71	9.4	0.89	13.3	1.03	17.5	1.32	25.2	1.74	33.4	2.27
	20	5.2	0.57	7.1	0.72	9.4	0.90	13.3	1.04	17.5	1.33	25.2	1.75	33.4	2.30
	21	5.2	0.58	7.1	0.74	11.8	1.14	15.8	1.24	19.8	1.60	27.4	1.93	35.5	2.53
	23	9.2	1.07	11.7	1.27	16.7	1.61	21.0	1.79	24.5	2.35	31.9	2.86	39.7	3.48
	25	13.2	1.54	16.4	2.03	21.5	2.38	26.1	2.82	29.2	3.42	36.4	4.32	43.9	5.03
	27	17.2	2.27	21.0	2.89	26.4	3.70	31.2	4.19	33.9	4.99	40.9	5.82	48.0	6.58
	29	21.2	2.94	25.6	3.98	31.3	5.15	36.4	5.80	38.6	6.58	45.4	7.47	52.2	8.71
	31	25.2	3.61	30.3	5.00	36.1	6.45	41.5	7.40	44.1	7.98	49.9	8.61	56.4	10.01
	33	29.2	4.74	34.9	6.16	41.0	7.58	46.6	8.77	49.4	9.17	54.4	10.20	60.5	11.27
	35	33.2	6.21	39.6	7.78	46.0	9.54	49.3	10.48	52.6	11.47	59.0	13.02	64.6	13.56
	37	33.2	6.56	39.6	8.27	46.0	10.12	49.3	11.14	52.6	12.19	59.0	13.74	63.6	14.24
	39	33.2	6.94	39.6	8.74	46.0	10.83	49.3	11.98	52.6	13.10	59.0	14.52	62.6	15.02
	41	32.4	7.67	38.6	9.69	44.8	11.88	48.0	13.13	51.2	14.40	57.5	15.55	59.9	15.91
43	31.6	8.45	37.6	10.57	43.7	12.97	46.8	14.31	50.0	15.73	56.0	16.62	57.5	17.03	
46	29.6	9.40	35.3	11.91	40.9	14.62	43.9	15.93	46.8	17.75	51.2	18.28	52.4	18.45	
48	26.2	8.21	31.2	10.41	36.2	12.78	38.8	13.91	41.4	15.47	44.5	15.51	45.6	15.63	

# 7. Capacity Tables

Cooling Capacity (22HP)

Combination (%)	Outdoor air temp. (DB, °C)	Indoor air temp. (DB/WB, °C)													
		20		23		26		27		28		30		32	
		14		16		18		19		20		22		24	
		TC	PI	TC	PI	TC	PI	TC	PI	TC	PI	TC	PI	TC	PI
70	10	4.5	0.48	6.1	0.60	8.2	0.76	11.6	0.88	15.2	1.12	21.9	1.47	29.1	1.93
	12	4.5	0.49	6.1	0.61	8.2	0.76	11.6	0.89	15.2	1.13	21.9	1.49	29.1	1.95
	14	4.5	0.49	6.1	0.61	8.2	0.77	11.6	0.89	15.2	1.14	21.9	1.50	29.1	1.97
	16	4.5	0.50	6.1	0.62	8.2	0.78	11.6	0.90	15.2	1.15	21.9	1.52	29.1	1.99
	18	4.5	0.50	6.1	0.63	8.2	0.79	11.6	0.91	15.2	1.16	21.9	1.54	29.1	2.01
	20	4.5	0.51	6.1	0.63	8.2	0.80	11.6	0.92	15.2	1.18	21.9	1.55	29.1	2.03
	21	4.5	0.51	7.2	0.74	10.6	1.04	14.3	1.16	17.6	1.41	24.2	1.71	31.3	2.23
	23	6.5	0.77	11.1	1.22	14.9	1.53	19.3	1.66	22.3	2.07	28.7	2.53	35.6	3.07
	25	10.2	1.27	15.0	1.80	19.1	2.11	24.2	2.62	27.1	3.02	33.3	3.82	40.0	4.44
	27	14.0	1.85	18.9	2.56	23.3	3.11	29.2	3.90	31.8	4.41	37.8	5.14	44.3	5.81
	29	17.8	2.34	22.9	3.38	27.5	4.22	34.1	5.31	36.5	5.82	42.4	6.60	48.6	7.70
	31	21.5	2.88	26.8	4.20	31.8	5.29	39.1	6.67	41.3	7.05	46.9	7.61	53.0	8.85
	33	25.3	3.87	30.7	5.11	36.0	6.14	43.1	7.74	46.0	8.11	51.5	9.02	57.2	9.97
	35	29.0	5.30	34.8	6.61	40.3	7.99	43.1	8.74	46.0	9.55	51.5	11.24	57.2	12.33
	37	29.0	5.63	34.8	7.00	40.3	8.49	43.1	9.30	46.0	10.16	51.5	11.96	57.2	13.01
	39	29.0	5.98	34.8	7.46	40.3	9.08	43.1	10.00	46.0	10.97	51.5	12.80	57.2	14.02
	41	28.3	6.62	33.9	8.17	39.2	9.96	42.0	10.97	44.8	11.93	50.2	14.06	55.7	15.11
43	27.6	7.20	33.0	8.91	38.3	10.87	41.0	11.97	43.7	13.03	48.9	15.36	54.4	16.35	
46	25.9	8.00	31.0	10.02	35.9	12.24	38.4	13.33	40.9	14.69	45.8	17.33	50.9	18.23	
48	22.9	6.98	27.4	8.75	31.7	10.70	34.0	11.65	36.2	12.85	40.6	15.16	45.1	15.63	
60	10	4.0	0.43	5.3	0.53	7.1	0.67	10.0	0.78	13.2	0.99	19.0	1.31	25.2	1.71
	12	4.0	0.43	5.3	0.54	7.1	0.68	10.0	0.79	13.2	1.00	19.0	1.32	25.2	1.73
	14	4.0	0.44	5.3	0.54	7.1	0.68	10.0	0.80	13.2	1.01	19.0	1.33	25.2	1.75
	16	4.0	0.44	5.3	0.55	7.1	0.69	10.0	0.81	13.2	1.02	19.0	1.35	25.2	1.76
	18	4.0	0.45	5.3	0.56	7.1	0.70	10.0	0.81	13.2	1.03	19.0	1.36	25.2	1.78
	20	4.0	0.45	5.3	0.56	7.1	0.71	10.0	0.82	13.2	1.04	19.0	1.37	25.2	1.80
	21	4.0	0.45	5.3	0.58	8.9	0.91	11.8	1.00	15.1	1.25	20.6	1.51	26.8	1.98
	23	4.0	0.50	8.8	1.06	12.5	1.36	16.3	1.45	19.0	1.84	24.0	2.24	30.0	2.72
	25	7.4	0.95	12.3	1.59	16.2	1.87	21.0	2.47	23.0	2.68	27.9	3.32	33.1	3.94
	27	10.9	1.39	15.8	2.27	19.8	2.75	25.3	3.44	26.9	3.85	31.3	4.40	36.3	5.07
	29	14.4	1.80	19.3	2.91	23.5	3.67	29.9	4.52	30.8	4.90	34.7	5.51	39.5	6.48
	31	17.8	2.29	22.7	3.47	27.2	4.47	33.5	5.43	34.8	5.69	38.9	6.10	42.7	7.47
	33	21.3	3.19	26.2	4.22	30.8	5.02	36.1	6.08	38.7	6.52	42.0	7.23	45.9	8.51
	35	24.9	4.50	29.7	5.50	34.5	6.59	37.0	7.18	39.4	7.79	44.2	9.11	49.1	10.50
	37	24.9	4.75	29.7	5.81	34.5	6.98	37.0	7.63	39.4	8.27	44.2	9.66	49.1	11.17
	39	24.9	5.05	29.7	6.18	34.5	7.54	37.0	8.18	39.4	8.90	44.2	10.36	49.1	11.97
	41	24.2	5.48	28.9	6.77	33.7	8.19	36.0	8.94	38.4	9.66	43.1	11.37	47.8	13.01
43	23.6	5.95	28.2	7.37	32.8	8.92	35.1	9.74	37.4	10.53	42.0	12.41	46.6	14.21	
46	22.1	6.67	26.5	8.27	30.8	10.04	32.9	10.95	35.1	11.85	39.4	13.99	43.7	16.19	
48	19.6	5.81	23.4	7.22	27.2	8.77	29.1	9.56	31.0	10.36	34.8	12.23	38.7	14.17	
50	10	3.6	0.38	4.9	0.47	6.8	0.59	9.1	0.73	12.0	0.88	17.3	1.16	23.0	1.51
	12	3.6	0.38	4.9	0.48	6.8	0.60	9.1	0.74	12.0	0.89	17.3	1.17	23.0	1.52
	14	3.6	0.39	4.9	0.48	6.8	0.61	9.1	0.74	12.0	0.90	17.3	1.18	23.0	1.54
	16	3.6	0.39	4.9	0.49	6.8	0.61	9.1	0.75	12.0	0.91	17.3	1.19	23.0	1.56
	18	3.6	0.39	4.9	0.49	6.8	0.62	9.1	0.76	12.0	0.91	17.3	1.21	23.0	1.57
	20	3.6	0.40	4.9	0.50	6.8	0.63	9.1	0.77	12.0	0.92	17.3	1.22	23.0	1.59
	21	3.6	0.40	4.9	0.52	8.5	0.80	10.8	0.92	13.7	1.11	18.8	1.34	24.3	1.75
	23	3.6	0.43	7.7	0.88	11.8	1.20	15.2	1.44	17.3	1.63	21.7	1.99	26.8	2.40
	25	6.4	0.78	10.6	1.29	15.1	1.68	20.1	2.33	21.3	2.38	24.5	2.79	29.3	3.40
	27	9.3	1.11	13.4	1.82	18.7	2.35	23.4	3.11	24.8	3.20	27.4	3.66	31.8	4.32
	29	12.1	1.46	16.3	2.34	21.7	3.02	26.3	3.85	28.3	4.13	30.3	4.53	34.3	5.46
	31	15.0	1.86	19.1	2.79	24.7	3.67	28.6	4.30	30.2	4.57	33.1	4.90	36.8	6.00
	33	17.9	2.59	22.0	3.35	27.6	4.12	29.7	4.71	31.5	5.05	35.8	5.80	39.3	6.74
	35	20.8	3.74	24.9	4.50	28.8	5.31	30.8	5.76	32.8	6.21	36.7	7.17	40.9	8.24
	37	20.8	3.96	24.9	4.75	28.8	5.62	30.8	6.10	32.8	6.58	36.7	7.65	40.9	8.74
	39	20.8	4.23	24.9	5.09	28.8	6.02	30.8	6.57	32.8	7.06	36.7	8.14	40.9	9.44
	41	20.3	4.57	24.2	5.51	28.1	6.59	30.0	7.11	31.9	7.65	35.8	8.93	39.9	10.25
43	19.8	4.97	23.6	6.00	27.4	7.17	29.3	7.74	31.2	8.32	34.9	9.73	38.9	11.19	
46	18.5	5.56	22.1	6.72	25.7	8.04	27.4	8.70	29.2	9.35	32.7	10.95	36.4	12.59	
48	16.4	4.85	19.6	5.86	22.7	7.01	24.3	7.59	25.8	8.16	28.9	9.57	32.2	11.01	

**Note**

1. TC: Total Capacity(kW), PI : Power Input(kW, Comp. + Outdoor fan motor)
2. Capacity tables show the average value of conditions which may occur.

# 7. Capacity Tables

◆ ARUM241LTE5

Cooling Capacity (24HP)

Combination (%)	Outdoor air temp. (DB, °C)	Indoor air temp. (DB/WB, °C)													
		20		23		26		27		28		30		32	
		14	16	18	19	20	22	24							
130	10	9.5	0.88	12.9	1.10	17.2	1.34	24.3	1.63	32.0	2.04	46.1	2.73	61.1	3.61
	12	9.5	0.89	12.9	1.11	17.2	1.35	24.3	1.65	32.0	2.07	46.1	2.75	61.1	3.65
	14	9.5	0.90	12.9	1.12	17.2	1.37	24.3	1.67	32.0	2.09	46.1	2.78	61.1	3.68
	16	9.5	0.91	12.9	1.14	17.2	1.38	24.3	1.69	32.0	2.11	46.1	2.81	61.1	3.72
	18	9.5	0.92	12.9	1.15	17.2	1.40	24.3	1.70	32.0	2.13	46.1	2.84	61.1	3.76
	20	9.5	0.93	12.9	1.16	17.2	1.41	24.3	1.72	32.0	2.15	46.1	2.87	61.1	3.80
	21	9.5	0.94	13.1	1.19	21.3	1.76	28.3	2.05	35.8	2.64	49.0	3.61	63.0	4.27
	23	16.4	1.66	22.9	2.19	29.6	2.50	37.0	2.77	43.3	3.98	55.1	5.14	66.9	6.06
	25	24.3	2.64	29.4	3.28	37.9	3.73	46.1	4.40	50.9	5.72	61.2	7.48	70.9	8.80
	27	31.7	4.20	37.6	4.96	46.2	5.63	54.7	6.74	58.4	8.55	67.3	10.78	74.8	12.15
	29	39.1	5.84	45.8	6.85	54.5	8.27	63.6	9.74	65.9	11.61	73.4	13.94	78.7	15.51
	31	47.5	7.63	55.1	9.41	64.1	11.42	71.7	13.33	73.5	15.20	77.5	19.09	82.8	19.36
	33	55.9	9.40	65.3	12.28	73.3	14.69	77.4	19.08	79.1	18.94	81.6	19.11	87.1	19.38
	35	66.6	12.70	76.3	15.39	78.7	18.68	80.1	18.77	81.4	18.88	83.6	19.05	86.0	19.13
	37	66.6	13.54	75.2	16.15	77.6	18.43	78.7	18.52	80.1	18.63	82.3	18.80	84.7	18.88
	39	66.6	14.42	73.9	17.00	76.3	18.18	77.6	18.28	78.7	18.38	81.2	18.55	83.6	18.62
41	64.9	15.30	70.8	17.85	73.2	17.94	74.3	18.03	75.7	18.14	78.0	18.30	80.1	18.37	
43	63.3	16.13	67.9	17.60	70.2	17.69	71.3	17.78	72.7	17.89	74.9	18.05	77.0	18.12	
46	59.3	17.27	61.9	17.23	64.1	17.32	65.1	17.41	66.5	17.51	68.6	17.67	70.5	17.74	
48	52.4	16.79	53.8	16.84	55.8	16.87	56.7	16.92	57.9	17.07	59.7	17.17	61.4	17.24	
120	10	8.7	0.83	11.9	1.03	15.9	1.25	22.4	1.53	29.5	1.91	42.5	2.55	56.3	3.38
	12	8.7	0.83	11.9	1.04	15.9	1.27	22.4	1.55	29.5	1.93	42.5	2.58	56.3	3.41
	14	8.7	0.84	11.9	1.05	15.9	1.28	22.4	1.56	29.5	1.95	42.5	2.60	56.3	3.45
	16	8.7	0.85	11.9	1.06	15.9	1.29	22.4	1.58	29.5	1.97	42.5	2.63	56.3	3.48
	18	8.7	0.86	11.9	1.07	15.9	1.31	22.4	1.59	29.5	1.99	42.5	2.66	56.3	3.52
	20	8.7	0.87	11.9	1.08	15.9	1.32	22.4	1.61	29.5	2.01	42.5	2.68	56.3	3.55
	21	8.7	0.88	12.1	1.12	20.1	1.68	26.1	1.92	33.4	2.47	45.5	3.37	58.4	4.00
	23	15.1	1.56	21.7	2.08	28.6	2.39	34.1	2.60	41.3	3.72	51.7	4.81	62.4	5.67
	25	23.6	2.47	30.5	3.12	37.4	3.49	42.5	4.11	49.5	5.35	58.3	6.99	66.5	8.23
	27	32.8	3.90	41.4	4.64	46.4	5.23	50.4	6.25	57.7	7.94	65.0	10.01	70.5	11.46
	29	42.1	5.42	49.9	6.26	55.3	7.68	58.6	9.04	65.9	10.78	71.6	12.94	74.6	14.54
	31	50.9	6.86	60.1	8.27	64.3	10.19	67.5	11.98	74.4	13.67	76.4	16.44	79.0	16.75
	33	59.0	8.45	70.9	10.79	75.1	13.11	76.2	15.21	77.5	17.89	79.6	18.09	82.1	18.24
	35	60.2	11.29	71.6	14.63	75.9	16.18	76.9	19.28	78.3	19.37	80.4	19.43	82.5	19.58
	37	60.2	12.15	71.6	15.44	74.8	17.25	75.9	18.87	76.9	18.96	79.1	19.02	81.2	19.17
	39	60.2	13.08	71.4	16.32	73.5	18.30	74.5	18.48	75.6	18.57	78.0	18.63	80.1	18.78
41	58.7	14.01	68.2	17.19	70.5	17.94	71.5	18.09	72.6	18.18	74.7	18.24	76.8	18.38	
43	57.2	14.95	65.4	16.95	67.7	17.54	68.6	17.71	69.6	17.80	71.7	17.85	73.8	17.99	
46	53.6	16.08	59.6	16.54	61.8	16.99	62.7	17.13	63.6	17.21	65.6	17.26	67.5	17.40	
48	47.5	15.75	51.8	16.25	53.7	16.65	54.5	16.76	55.3	16.81	57.1	16.88	58.8	16.94	
110	10	8.0	0.78	10.9	0.97	14.5	1.18	20.5	1.44	27.0	1.80	38.9	2.40	51.6	3.17
	12	8.0	0.78	10.9	0.98	14.5	1.19	20.5	1.45	27.0	1.82	38.9	2.42	51.6	3.21
	14	8.0	0.79	10.9	0.99	14.5	1.20	20.5	1.47	27.0	1.83	38.9	2.45	51.6	3.24
	16	8.0	0.80	10.9	1.00	14.5	1.22	20.5	1.48	27.0	1.85	38.9	2.47	51.6	3.27
	18	8.0	0.81	10.9	1.01	14.5	1.23	20.5	1.50	27.0	1.87	38.9	2.50	51.6	3.31
	20	8.0	0.82	10.9	1.02	14.5	1.24	20.5	1.51	27.0	1.89	38.9	2.52	51.6	3.34
	21	8.0	0.82	10.9	1.05	18.2	1.55	24.1	1.80	30.1	2.32	42.0	3.17	54.3	3.76
	23	14.3	1.46	18.2	1.96	25.5	2.19	31.4	2.44	38.1	3.50	47.7	4.52	59.0	5.33
	25	20.6	2.32	25.5	2.93	32.8	3.28	38.8	3.87	45.3	5.03	53.4	6.57	63.6	7.73
	27	26.9	3.67	32.8	4.36	40.1	4.91	46.1	5.87	52.8	7.46	59.4	9.40	68.7	10.77
	29	33.2	5.09	40.1	5.88	47.4	7.21	53.6	8.50	60.3	10.13	65.5	11.91	72.5	13.21
	31	40.3	6.44	48.3	7.77	55.8	9.57	61.1	11.26	67.8	12.84	71.5	13.77	75.2	14.83
	33	46.7	7.94	55.8	10.14	63.2	12.32	68.9	13.77	73.3	15.45	75.5	15.88	77.5	15.90
	35	54.0	10.01	64.3	12.87	71.9	14.68	73.9	15.73	75.0	16.69	76.8	16.85	78.9	16.93
	37	54.0	10.61	64.3	13.66	71.9	15.50	72.9	16.66	73.7	17.61	75.7	17.67	77.6	17.72
	39	54.0	11.43	64.3	14.52	70.5	16.35	71.6	17.82	72.6	18.48	74.4	18.51	76.5	18.53
41	52.6	12.26	62.7	15.38	67.5	17.24	68.6	19.28	69.5	19.28	71.5	19.43	73.3	19.58	
43	51.3	12.88	61.1	16.02	64.7	18.28	65.8	18.49	66.6	18.45	68.6	18.55	70.3	18.61	
46	48.0	12.57	57.3	15.46	59.0	17.35	60.1	17.35	60.9	17.50	62.7	17.60	64.3	17.65	
48	42.5	12.21	49.8	14.90	51.3	16.51	52.2	16.62	52.9	16.70	54.5	16.75	56.0	16.81	

# 7. Capacity Tables

Cooling Capacity (24HP)

Combination (%)	Outdoor air temp. (DB, °C)	Indoor air temp. (DB/WB, °C)													
		20		23		26		27		28		30		32	
		14		16		18		19		20		22		24	
		TC	PI	TC	PI	TC	PI	TC	PI	TC	PI	TC	PI	TC	PI
100	10	7.3	0.71	10.0	0.89	13.3	1.08	18.8	1.32	24.8	1.65	35.7	2.20	47.4	2.91
	12	7.3	0.72	10.0	0.90	13.3	1.09	18.8	1.33	24.8	1.67	35.7	2.22	47.4	2.94
	14	7.3	0.73	10.0	0.91	13.3	1.10	18.8	1.35	24.8	1.68	35.7	2.24	47.4	2.97
	16	7.3	0.73	10.0	0.92	13.3	1.11	18.8	1.36	24.8	1.70	35.7	2.27	47.4	3.00
	18	7.3	0.74	10.0	0.93	13.3	1.13	18.8	1.37	24.8	1.72	35.7	2.29	47.4	3.03
	20	7.3	0.75	10.0	0.93	13.3	1.14	18.8	1.39	24.8	1.73	35.7	2.31	47.4	3.06
	21	7.3	0.76	10.0	0.96	16.6	1.42	22.1	1.65	28.3	2.13	38.5	2.91	49.8	3.45
	23	12.7	1.34	17.5	1.79	23.2	2.01	29.1	2.24	35.3	3.21	44.2	4.15	54.6	4.89
	25	18.1	2.13	23.6	2.69	29.8	3.01	36.3	3.55	42.3	4.61	49.9	6.03	59.4	7.09
	27	23.6	3.36	29.7	4.00	36.4	4.51	43.1	5.39	49.3	6.84	55.5	8.63	64.2	9.88
	29	29.0	4.67	35.8	5.39	43.1	6.62	50.1	7.79	56.3	9.29	61.2	11.15	69.1	12.12
	31	34.4	5.91	41.9	7.13	49.7	8.78	57.1	10.33	63.3	11.78	66.8	12.89	74.5	13.74
	33	39.9	7.29	48.0	9.30	56.3	11.30	64.1	13.11	70.4	14.32	72.6	14.56	74.5	14.88
	35	45.4	8.78	54.0	11.21	62.9	13.93	67.2	15.42	70.4	15.51	72.6	15.57	74.5	15.70
	37	45.4	9.40	54.0	12.02	62.9	14.75	67.2	16.15	69.3	16.23	71.3	16.30	73.0	16.45
	39	45.4	10.08	54.0	12.91	62.9	15.63	67.2	16.94	68.1	17.02	70.1	17.08	71.8	17.24
	41	44.6	10.76	53.1	13.80	61.9	16.51	64.5	17.73	65.9	17.80	67.4	17.87	69.6	18.03
	43	43.1	11.38	51.3	14.63	59.8	17.30	61.8	18.41	62.5	18.48	64.5	18.54	66.2	18.71
46	40.4	12.25	48.1	15.78	56.0	18.35	56.4	19.28	57.1	19.33	58.9	19.39	60.5	19.57	
48	35.7	10.57	42.5	13.65	48.3	15.69	49.1	16.35	49.6	16.41	51.2	16.44	52.6	16.58	
90	10	6.6	0.65	9.0	0.82	12.0	1.03	16.6	1.17	22.3	1.52	32.1	2.00	42.6	2.62
	12	6.6	0.66	9.0	0.83	12.0	1.04	16.6	1.19	22.3	1.53	32.1	2.02	42.6	2.65
	14	6.6	0.67	9.0	0.83	12.0	1.05	16.6	1.20	22.3	1.55	32.1	2.04	42.6	2.67
	16	6.6	0.68	9.0	0.84	12.0	1.06	16.6	1.21	22.3	1.56	32.1	2.06	42.6	2.70
	18	6.6	0.68	9.0	0.85	12.0	1.07	16.6	1.22	22.3	1.58	32.1	2.08	42.6	2.73
	20	6.6	0.69	9.0	0.86	12.0	1.08	16.6	1.24	22.3	1.60	32.1	2.11	42.6	2.76
	21	6.6	0.70	9.0	0.87	15.1	1.36	19.6	1.46	25.2	1.92	34.7	2.32	44.8	3.03
	23	9.0	1.08	13.2	1.49	21.0	1.93	25.5	2.10	30.8	2.81	39.9	3.43	49.4	4.17
	25	14.2	1.82	19.2	2.40	27.0	2.86	31.3	3.32	36.4	4.10	45.1	5.19	54.0	6.03
	27	19.5	2.67	25.1	3.41	32.9	4.44	37.1	4.94	42.0	5.98	50.3	6.98	58.5	7.89
	29	24.8	3.61	31.0	4.68	38.9	6.18	43.0	6.83	47.6	7.90	55.5	8.96	63.1	10.44
	31	30.1	4.52	36.9	6.02	44.8	7.74	48.8	8.72	53.2	9.84	60.7	10.43	67.6	12.14
	33	35.4	5.82	42.8	7.40	50.8	9.38	54.6	10.34	58.8	11.44	65.8	12.36	72.2	13.56
	35	40.8	7.21	48.7	9.11	56.6	11.27	60.5	12.42	64.3	13.51	71.0	14.49	72.2	14.82
	37	40.8	7.65	48.7	9.69	56.6	12.01	60.5	13.20	64.3	14.26	69.9	15.15	71.1	15.49
	39	40.8	8.10	48.7	10.31	56.6	12.71	60.5	14.05	64.3	14.99	68.7	15.97	69.9	16.16
	41	39.8	9.06	47.5	11.43	55.2	13.95	58.9	15.36	62.7	16.19	65.8	16.83	67.0	17.22
	43	38.8	9.78	46.3	12.35	53.8	15.24	57.5	16.54	61.1	17.36	63.1	17.98	64.3	18.24
46	36.3	11.01	43.4	14.06	50.4	17.37	53.9	18.75	55.5	19.28	57.6	19.39	58.7	19.57	
48	32.1	9.62	38.4	12.30	44.6	15.19	47.6	16.35	48.2	16.41	50.1	16.44	51.0	16.58	
80	10	5.6	0.58	7.7	0.72	10.3	0.91	14.5	1.04	19.1	1.34	27.5	1.77	36.5	2.32
	12	5.6	0.58	7.7	0.73	10.3	0.92	14.5	1.06	19.1	1.35	27.5	1.79	36.5	2.34
	14	5.6	0.59	7.7	0.74	10.3	0.93	14.5	1.07	19.1	1.37	27.5	1.81	36.5	2.36
	16	5.6	0.60	7.7	0.75	10.3	0.94	14.5	1.08	19.1	1.38	27.5	1.82	36.5	2.39
	18	5.6	0.60	7.7	0.75	10.3	0.95	14.5	1.09	19.1	1.40	27.5	1.84	36.5	2.41
	20	5.6	0.61	7.7	0.76	10.3	0.96	14.5	1.10	19.1	1.41	27.5	1.86	36.5	2.44
	21	5.6	0.61	7.7	0.78	12.9	1.20	17.3	1.32	21.6	1.69	29.9	2.05	38.8	2.68
	23	10.0	1.13	12.8	1.34	18.2	1.71	22.9	1.89	26.7	2.49	34.8	3.03	43.3	3.69
	25	14.4	1.64	17.8	2.16	23.5	2.53	28.5	2.99	31.9	3.63	39.7	4.58	47.8	5.33
	27	18.7	2.41	22.9	3.07	28.8	3.92	34.1	4.45	37.0	5.29	44.6	6.17	52.4	6.97
	29	23.1	3.12	28.0	4.22	34.1	5.46	39.7	6.15	42.1	6.98	49.5	7.92	56.9	9.23
	31	27.5	3.82	33.0	5.31	39.4	6.84	45.2	7.85	48.1	8.46	54.4	9.13	61.5	10.62
	33	31.9	5.03	38.1	6.53	44.7	8.04	50.9	9.31	53.9	9.72	59.3	10.82	66.0	11.96
	35	36.2	6.58	43.2	8.25	50.2	10.12	53.8	11.12	57.4	12.17	64.3	13.81	70.5	14.38
	37	36.2	6.96	43.2	8.77	50.2	10.73	53.8	11.82	57.4	12.93	64.3	14.57	69.4	15.10
	39	36.2	7.36	43.2	9.27	50.2	11.48	53.8	12.70	57.4	13.89	64.3	15.39	68.2	15.93
	41	35.3	8.14	42.1	10.27	48.9	12.60	52.4	13.93	55.9	15.27	62.7	16.50	65.4	16.87
	43	34.4	8.96	41.1	11.21	47.7	13.76	51.1	15.18	54.5	16.68	61.1	17.62	62.7	18.06
46	32.3	9.97	38.5	12.63	44.7	15.50	47.9	16.89	51.1	18.83	55.9	19.39	57.2	19.57	
48	28.6	8.71	34.0	11.04	39.5	13.56	42.4	14.75	45.2	16.41	48.5	16.44	49.7	16.58	

## 7. Capacity Tables

Cooling Capacity (24HP)

Combination (%)	Outdoor air temp. (DB, °C)	Indoor air temp. (DB/WB, °C)													
		20		23		26		27		28		30		32	
		14		16		18		19		20		22		24	
		TC	PI	TC	PI	TC	PI	TC	PI	TC	PI	TC	PI	TC	PI
70	10	4.9	0.51	6.7	0.64	8.9	0.80	12.6	0.93	16.6	1.18	23.9	1.56	31.7	2.05
	12	4.9	0.52	6.7	0.65	8.9	0.81	12.6	0.94	16.6	1.20	23.9	1.58	31.7	2.07
	14	4.9	0.52	6.7	0.65	8.9	0.82	12.6	0.95	16.6	1.21	23.9	1.60	31.7	2.09
	16	4.9	0.53	6.7	0.66	8.9	0.83	12.6	0.96	16.6	1.22	23.9	1.61	31.7	2.11
	18	4.9	0.53	6.7	0.67	8.9	0.84	12.6	0.97	16.6	1.23	23.9	1.63	31.7	2.13
	20	4.9	0.54	6.7	0.67	8.9	0.84	12.6	0.98	16.6	1.25	23.9	1.65	31.7	2.15
	21	4.9	0.54	7.8	0.79	11.6	1.11	15.6	1.23	19.2	1.50	26.4	1.81	34.1	2.37
	23	7.0	0.81	12.1	1.29	16.2	1.62	21.0	1.76	24.4	2.20	31.3	2.68	38.9	3.26
	25	11.2	1.34	16.4	1.91	20.8	2.23	26.4	2.78	29.5	3.21	36.3	4.05	43.6	4.71
	27	15.3	1.96	20.7	2.71	25.4	3.29	31.8	4.14	34.7	4.68	41.2	5.45	48.3	6.16
	29	19.4	2.48	25.0	3.58	30.0	4.48	37.2	5.63	39.8	6.17	46.2	7.00	53.1	8.16
	31	23.5	3.05	29.2	4.46	34.6	5.61	42.6	7.07	45.0	7.48	51.2	8.07	57.8	9.39
	33	27.6	4.11	33.5	5.42	39.3	6.51	47.0	8.21	50.2	8.60	56.2	9.56	62.4	10.57
	35	31.7	5.62	37.9	7.01	43.9	8.48	47.0	9.27	50.2	10.13	56.2	11.92	62.4	13.07
	37	31.7	5.98	37.9	7.42	43.9	9.01	47.0	9.86	50.2	10.77	56.2	12.69	62.4	13.80
	39	31.7	6.35	37.9	7.91	43.9	9.63	47.0	10.61	50.2	11.64	56.2	13.58	62.4	14.87
	41	30.9	7.02	36.9	8.67	42.8	10.56	45.8	11.64	48.9	12.65	54.7	14.91	60.8	16.03
43	30.1	7.64	36.0	9.45	41.7	11.53	44.7	12.69	47.7	13.82	53.4	16.29	59.3	17.34	
46	28.2	8.49	33.8	10.62	39.1	12.98	41.9	14.13	44.7	15.57	50.0	18.38	55.6	19.33	
48	25.0	7.41	29.9	9.28	34.6	11.35	37.1	12.35	39.5	13.63	44.2	16.08	49.2	16.58	
60	10	4.3	0.45	5.8	0.56	7.7	0.71	10.9	0.83	14.4	1.05	20.7	1.38	27.5	1.81
	12	4.3	0.46	5.8	0.57	7.7	0.72	10.9	0.84	14.4	1.06	20.7	1.40	27.5	1.83
	14	4.3	0.46	5.8	0.58	7.7	0.72	10.9	0.84	14.4	1.07	20.7	1.41	27.5	1.85
	16	4.3	0.47	5.8	0.58	7.7	0.73	10.9	0.85	14.4	1.08	20.7	1.43	27.5	1.87
	18	4.3	0.47	5.8	0.59	7.7	0.74	10.9	0.86	14.4	1.09	20.7	1.44	27.5	1.89
	20	4.3	0.48	5.8	0.59	7.7	0.75	10.9	0.87	14.4	1.10	20.7	1.45	27.5	1.90
	21	4.3	0.48	5.8	0.62	9.7	0.96	12.8	1.06	16.5	1.32	22.5	1.60	29.2	2.09
	23	4.3	0.53	9.6	1.12	13.7	1.43	17.8	1.53	20.8	1.94	26.2	2.37	32.7	2.88
	25	8.1	1.01	13.4	1.68	17.7	1.97	22.9	2.62	25.1	2.83	30.4	3.51	36.2	4.17
	27	11.9	1.47	17.2	2.40	21.7	2.91	27.6	3.64	29.4	4.07	34.2	4.65	39.6	5.36
	29	15.7	1.91	21.0	3.07	25.6	3.88	32.6	4.78	33.6	5.19	37.9	5.83	43.1	6.86
	31	19.5	2.42	24.8	3.67	29.6	4.73	36.6	5.74	37.9	6.02	42.5	6.46	46.6	7.90
	33	23.3	3.37	28.6	4.47	33.6	5.31	39.4	6.43	42.3	6.89	45.8	7.65	50.0	9.00
	35	27.1	4.77	32.4	5.84	37.7	6.99	40.3	7.61	43.0	8.26	48.2	9.66	53.5	11.14
	37	27.1	5.04	32.4	6.16	37.7	7.41	40.3	8.09	43.0	8.77	48.2	10.25	53.5	11.85
	39	27.1	5.36	32.4	6.56	37.7	7.99	40.3	8.68	43.0	9.44	48.2	10.99	53.5	12.70
	41	26.4	5.81	31.6	7.18	36.7	8.68	39.3	9.48	41.9	10.24	47.0	12.06	52.2	13.80
43	25.8	6.31	30.8	7.81	35.8	9.46	38.3	10.33	40.8	11.17	45.8	13.17	50.9	15.07	
46	24.2	7.07	28.9	8.77	33.6	10.64	35.9	11.61	38.3	12.57	43.0	14.84	47.7	17.17	
48	21.4	6.16	25.5	7.66	29.7	9.30	31.8	10.14	33.8	10.98	38.0	12.97	42.2	15.02	
50	10	3.9	0.40	5.3	0.50	7.5	0.63	10.0	0.77	13.1	0.93	18.9	1.22	25.1	1.59
	12	3.9	0.40	5.3	0.50	7.5	0.63	10.0	0.78	13.1	0.94	18.9	1.23	25.1	1.61
	14	3.9	0.41	5.3	0.51	7.5	0.64	10.0	0.79	13.1	0.95	18.9	1.25	25.1	1.63
	16	3.9	0.41	5.3	0.51	7.5	0.65	10.0	0.79	13.1	0.96	18.9	1.26	25.1	1.64
	18	3.9	0.42	5.3	0.52	7.5	0.65	10.0	0.80	13.1	0.96	18.9	1.27	25.1	1.66
	20	3.9	0.42	5.3	0.53	7.5	0.66	10.0	0.81	13.1	0.97	18.9	1.29	25.1	1.68
	21	3.9	0.42	5.3	0.54	9.3	0.85	11.8	0.97	14.9	1.17	20.5	1.41	26.5	1.84
	23	3.9	0.45	8.4	0.93	12.9	1.27	16.6	1.52	18.9	1.72	23.7	2.10	29.2	2.54
	25	7.0	0.82	11.5	1.36	16.5	1.78	22.0	2.46	23.3	2.51	26.8	2.95	31.9	3.58
	27	10.1	1.18	14.6	1.92	20.4	2.48	25.5	3.28	27.0	3.38	29.9	3.86	34.7	4.56
	29	13.2	1.54	17.8	2.47	23.6	3.18	28.7	4.06	30.8	4.36	33.0	4.78	37.4	5.76
	31	16.4	1.96	20.9	2.94	26.9	3.88	31.2	4.53	33.0	4.82	36.1	5.17	40.2	6.34
	33	19.5	2.73	24.0	3.54	30.1	4.35	32.4	4.97	34.4	5.32	39.0	6.12	42.9	7.11
	35	22.7	3.96	27.1	4.77	31.4	5.63	33.6	6.11	35.8	6.59	40.1	7.60	44.6	8.73
	37	22.7	4.20	27.1	5.04	31.4	5.96	33.6	6.47	35.8	6.98	40.1	8.11	44.6	9.27
	39	22.7	4.48	27.1	5.40	31.4	6.39	33.6	6.96	35.8	7.48	40.1	8.64	44.6	10.01
	41	22.1	4.85	26.4	5.85	30.6	6.99	32.7	7.54	34.8	8.11	39.1	9.47	43.5	10.87
43	21.6	5.27	25.8	6.36	29.9	7.60	31.9	8.21	34.0	8.83	38.1	10.32	42.4	11.86	
46	20.2	5.90	24.2	7.13	28.0	8.53	29.9	9.22	31.8	9.91	35.7	11.62	39.8	13.35	
48	17.9	5.14	21.4	6.22	24.8	7.44	26.5	8.05	28.2	8.65	31.6	10.15	35.2	11.67	

**Note**

1. TC: Total Capacity(kW), PI : Power Input(kW, Comp. + Outdoor fan motor)
2. Capacity tables show the average value of conditions which may occur.

# 7. Capacity Tables

◆ ARUM261LTE5

Cooling Capacity (26HP)

Combination (%)	Outdoor air temp. (DB, °C)	Indoor air temp. (DB/WB, °C)													
		20		23		26		27		28		30		32	
		14	16	18	19	20	22	24	TC	PI	TC	PI			
130	10	10.2	0.94	14.0	1.17	18.6	1.42	26.3	1.74	34.7	2.17	49.9	2.89	66.2	3.83
	12	10.2	0.95	14.0	1.18	18.6	1.44	26.3	1.75	34.7	2.19	49.9	2.93	66.2	3.87
	14	10.2	0.96	14.0	1.19	18.6	1.45	26.3	1.77	34.7	2.22	49.9	2.96	66.2	3.91
	16	10.2	0.97	14.0	1.21	18.6	1.47	26.3	1.79	34.7	2.24	49.9	2.99	66.2	3.95
	18	10.2	0.98	14.0	1.22	18.6	1.48	26.3	1.81	34.7	2.26	49.9	3.02	66.2	3.99
	20	10.2	0.99	14.0	1.23	18.6	1.50	26.3	1.83	34.7	2.29	49.9	3.05	66.2	4.03
	21	10.2	1.00	14.2	1.27	23.1	1.87	30.6	2.18	38.8	2.81	53.1	3.83	68.3	4.54
	23	17.8	1.77	24.8	2.33	32.1	2.65	40.0	2.95	46.9	4.23	59.7	5.46	72.5	6.44
	25	26.3	2.80	31.9	3.49	41.1	3.96	49.9	4.67	55.1	6.07	66.3	7.94	76.8	9.34
	27	34.4	4.47	40.8	5.27	50.1	5.99	59.3	7.16	63.3	9.08	72.9	11.45	81.0	12.90
	29	42.4	6.20	49.6	7.27	59.1	8.79	68.9	10.35	71.4	12.34	79.5	14.81	85.3	16.48
	31	51.4	8.10	59.7	10.00	69.4	12.13	77.6	14.16	79.6	16.15	84.0	20.28	89.7	20.57
	33	60.5	9.99	70.7	13.04	79.4	15.61	83.9	20.26	85.7	20.12	88.4	20.30	94.4	20.59
	35	72.1	13.49	82.6	16.35	85.3	19.84	86.8	19.94	88.2	20.06	90.6	20.24	93.2	20.32
	37	72.1	14.38	81.5	17.16	84.1	19.58	85.3	19.68	86.8	19.79	89.1	19.97	91.8	20.05
	39	72.1	15.32	80.0	18.06	82.6	19.32	84.1	19.41	85.3	19.53	87.9	19.70	90.6	19.78
41	70.3	16.25	76.7	18.96	79.3	19.05	80.5	19.15	82.1	19.26	84.5	19.44	86.8	19.51	
43	68.5	17.14	73.5	18.70	76.1	18.79	77.2	18.89	78.8	19.00	81.2	19.17	83.4	19.25	
46	64.2	18.34	67.1	18.31	69.5	18.40	70.6	18.49	72.0	18.60	74.3	18.77	76.4	18.84	
48	56.8	17.83	58.2	17.89	60.4	17.92	61.4	17.97	62.7	18.13	64.7	18.24	66.5	18.31	
120	10	9.5	0.88	12.9	1.09	17.2	1.33	24.3	1.62	32.0	2.03	46.0	2.71	61.0	3.59
	12	9.5	0.89	12.9	1.11	17.2	1.35	24.3	1.64	32.0	2.05	46.0	2.74	61.0	3.62
	14	9.5	0.90	12.9	1.12	17.2	1.36	24.3	1.66	32.0	2.07	46.0	2.77	61.0	3.66
	16	9.5	0.90	12.9	1.13	17.2	1.37	24.3	1.68	32.0	2.09	46.0	2.79	61.0	3.70
	18	9.5	0.91	12.9	1.14	17.2	1.39	24.3	1.69	32.0	2.12	46.0	2.82	61.0	3.74
	20	9.5	0.92	12.9	1.15	17.2	1.40	24.3	1.71	32.0	2.14	46.0	2.85	61.0	3.77
	21	9.5	0.93	13.1	1.19	21.8	1.79	28.3	2.04	36.1	2.63	49.3	3.58	63.3	4.25
	23	16.4	1.65	23.5	2.21	30.9	2.54	36.9	2.76	44.7	3.95	56.0	5.11	67.6	6.02
	25	25.6	2.62	33.0	3.32	40.5	3.71	46.0	4.37	53.6	5.68	63.2	7.43	72.0	8.74
	27	35.5	4.14	44.9	4.93	50.3	5.55	54.6	6.64	62.5	8.43	70.4	10.63	76.4	12.17
	29	45.6	5.75	54.1	6.64	59.9	8.16	63.5	9.60	71.4	11.45	77.5	13.74	80.8	15.45
	31	55.2	7.29	65.1	8.78	69.7	10.82	73.1	12.73	80.6	14.52	82.8	17.46	85.6	17.79
	33	63.9	8.98	76.8	11.46	81.4	13.93	82.5	16.15	83.9	19.00	86.2	19.22	88.9	19.37
	35	65.2	12.00	77.6	15.54	82.2	17.19	83.3	20.48	84.8	20.58	87.1	20.64	89.4	20.80
	37	65.2	12.90	77.6	16.40	81.0	18.33	82.2	20.04	83.3	20.14	85.6	20.20	88.0	20.37
	39	65.2	13.89	77.3	17.33	79.6	19.44	80.8	19.63	81.9	19.73	84.5	19.79	86.8	19.95
41	63.6	14.88	73.9	18.26	76.4	19.06	77.5	19.22	78.6	19.32	80.9	19.37	83.2	19.53	
43	62.0	15.88	70.8	18.00	73.3	18.63	74.3	18.81	75.4	18.90	77.7	18.96	79.9	19.11	
46	58.1	17.08	64.6	17.57	66.9	18.04	67.9	18.19	69.0	18.28	71.0	18.34	73.1	18.48	
48	51.4	16.73	56.1	17.26	58.2	17.69	59.1	17.80	60.0	17.86	61.8	17.93	63.7	18.00	
110	10	8.7	0.82	11.8	1.03	15.7	1.25	22.2	1.53	29.3	1.91	42.2	2.54	55.9	3.37
	12	8.7	0.83	11.8	1.04	15.7	1.26	22.2	1.54	29.3	1.93	42.2	2.57	55.9	3.40
	14	8.7	0.84	11.8	1.05	15.7	1.28	22.2	1.56	29.3	1.95	42.2	2.60	55.9	3.44
	16	8.7	0.85	11.8	1.06	15.7	1.29	22.2	1.57	29.3	1.97	42.2	2.63	55.9	3.48
	18	8.7	0.86	11.8	1.07	15.7	1.30	22.2	1.59	29.3	1.99	42.2	2.65	55.9	3.51
	20	8.7	0.87	11.8	1.08	15.7	1.32	22.2	1.61	29.3	2.01	42.2	2.68	55.9	3.55
	21	8.7	0.88	11.8	1.12	19.7	1.65	26.1	1.91	32.6	2.47	45.5	3.37	58.8	3.99
	23	15.5	1.55	19.7	2.08	27.6	2.33	34.1	2.59	41.3	3.71	51.7	4.80	63.9	5.66
	25	22.3	2.46	27.6	3.12	35.5	3.48	42.1	4.11	49.0	5.34	57.8	6.98	68.9	8.21
	27	29.1	3.89	35.5	4.64	43.4	5.22	50.0	6.24	57.2	7.92	64.4	9.99	74.5	11.44
	29	35.9	5.41	43.4	6.24	51.4	7.66	58.1	9.03	65.3	10.76	70.9	12.65	78.6	14.03
	31	43.6	6.85	52.4	8.25	60.4	10.17	66.2	11.96	73.4	13.64	77.5	14.63	81.5	15.75
	33	50.6	8.44	60.4	10.77	68.5	13.09	74.7	14.62	79.4	16.41	81.8	16.86	83.9	16.89
	35	58.4	10.63	69.7	13.68	77.8	15.59	80.1	16.70	81.2	17.73	83.2	17.90	85.4	17.98
	37	58.4	11.27	69.7	14.51	77.8	16.46	79.0	17.70	79.8	18.70	82.1	18.77	84.0	18.82
	39	58.4	12.15	69.7	15.42	76.4	17.37	77.5	18.93	78.7	19.63	80.6	19.66	82.9	19.68
41	57.0	13.03	67.9	16.33	73.2	18.31	74.3	20.48	75.3	20.48	77.5	20.64	79.4	20.80	
43	55.5	13.68	66.2	17.02	70.1	19.42	71.3	19.64	72.2	19.60	74.3	19.71	76.2	19.76	
46	52.1	13.35	62.1	16.43	64.0	18.43	65.1	18.43	65.9	18.59	67.9	18.69	69.7	18.74	
48	46.0	12.97	53.9	15.83	55.6	17.54	56.6	17.65	57.3	17.74	59.1	17.79	60.6	17.86	



# 7. Capacity Tables

Cooling Capacity (26HP)

Combination (%)	Outdoor air temp. (DB, °C)	Indoor air temp. (DB/WB, °C)													
		20		23		26		27		28		30		32	
		14		16		18		19		20		22		24	
		TC	PI	TC	PI	TC	PI	TC	PI	TC	PI	TC	PI	TC	PI
100	10	7.9	0.76	10.8	0.94	14.4	1.15	20.4	1.40	26.9	1.75	38.7	2.33	51.3	3.09
	12	7.9	0.76	10.8	0.95	14.4	1.16	20.4	1.42	26.9	1.77	38.7	2.36	51.3	3.12
	14	7.9	0.77	10.8	0.96	14.4	1.17	20.4	1.43	26.9	1.79	38.7	2.38	51.3	3.16
	16	7.9	0.78	10.8	0.97	14.4	1.18	20.4	1.44	26.9	1.81	38.7	2.41	51.3	3.19
	18	7.9	0.79	10.8	0.98	14.4	1.20	20.4	1.46	26.9	1.82	38.7	2.43	51.3	3.22
	20	7.9	0.80	10.8	0.99	14.4	1.21	20.4	1.47	26.9	1.84	38.7	2.46	51.3	3.25
	21	7.9	0.80	10.8	1.02	18.0	1.51	23.9	1.76	30.6	2.26	41.8	3.09	53.9	3.66
	23	13.8	1.43	19.0	1.91	25.2	2.14	31.5	2.38	38.2	3.41	47.9	4.41	59.2	5.19
	25	19.7	2.26	25.6	2.86	32.3	3.20	39.3	3.77	45.8	4.90	54.0	6.40	64.4	7.53
	27	25.5	3.57	32.2	4.25	39.5	4.79	46.7	5.72	53.4	7.27	60.1	9.16	69.6	10.49
	29	31.4	4.96	38.8	5.73	46.7	7.03	54.3	8.28	61.0	9.87	66.3	11.85	74.8	12.87
	31	37.3	6.28	45.4	7.57	53.8	9.33	61.9	10.97	68.6	12.52	72.4	13.70	80.7	14.60
	33	43.2	7.74	52.0	9.88	61.0	12.01	69.5	13.93	76.3	15.21	78.7	15.47	80.7	15.81
	35	49.1	9.32	58.5	11.90	68.1	14.79	72.8	16.38	76.3	16.48	78.7	16.54	80.7	16.67
	37	49.1	9.99	58.5	12.77	68.1	15.67	72.8	17.16	75.0	17.24	77.2	17.31	79.0	17.47
	39	49.1	10.71	58.5	13.72	68.1	16.61	72.8	18.00	73.8	18.08	76.0	18.15	77.7	18.31
	41	48.4	11.43	57.6	14.66	67.0	17.54	69.9	18.84	71.4	18.91	73.1	18.98	75.4	19.16
	43	46.7	12.09	55.6	15.54	64.7	18.38	67.0	19.56	67.7	19.63	69.8	19.69	71.7	19.88
46	43.8	13.01	52.1	16.76	60.7	19.50	61.2	20.48	61.8	20.54	63.8	20.60	65.5	20.79	
48	38.7	11.23	46.1	14.50	52.4	16.67	53.1	17.37	53.7	17.43	55.5	17.47	57.0	17.61	
90	10	7.1	0.70	9.7	0.87	13.0	1.09	18.0	1.25	24.2	1.61	34.8	2.12	46.2	2.78
	12	7.1	0.70	9.7	0.88	13.0	1.10	18.0	1.26	24.2	1.63	34.8	2.15	46.2	2.81
	14	7.1	0.71	9.7	0.89	13.0	1.11	18.0	1.27	24.2	1.64	34.8	2.17	46.2	2.84
	16	7.1	0.72	9.7	0.90	13.0	1.13	18.0	1.29	24.2	1.66	34.8	2.19	46.2	2.87
	18	7.1	0.72	9.7	0.90	13.0	1.14	18.0	1.30	24.2	1.68	34.8	2.21	46.2	2.90
	20	7.1	0.73	9.7	0.91	13.0	1.15	18.0	1.31	24.2	1.70	34.8	2.24	46.2	2.93
	21	7.1	0.74	9.7	0.92	16.3	1.45	21.3	1.55	27.3	2.03	37.6	2.46	48.6	3.22
	23	9.7	1.14	14.3	1.59	22.8	2.05	27.6	2.23	33.3	2.99	43.2	3.64	53.5	4.43
	25	15.4	1.93	20.7	2.54	29.2	3.04	33.9	3.53	39.4	4.36	48.8	5.51	58.5	6.40
	27	21.2	2.84	27.2	3.62	35.7	4.71	40.2	5.25	45.5	6.36	54.5	7.41	63.4	8.38
	29	26.9	3.84	33.6	4.98	42.1	6.57	46.6	7.26	51.5	8.39	60.1	9.52	68.3	11.09
	31	32.6	4.80	40.0	6.39	48.6	8.22	52.9	9.26	57.6	10.45	65.7	11.08	73.3	12.89
	33	38.4	6.18	46.4	7.86	55.0	9.96	59.2	10.98	63.7	12.15	71.3	13.13	78.2	14.40
	35	44.2	7.66	52.8	9.68	61.4	11.97	65.5	13.20	69.7	14.35	76.9	15.39	82.2	15.75
	37	44.2	8.12	52.8	10.29	61.4	12.76	65.5	14.02	69.7	15.15	75.7	16.09	77.0	16.45
	39	44.2	8.60	52.8	10.95	61.4	13.50	65.5	14.92	69.7	15.93	74.4	16.97	75.7	17.17
	41	43.1	9.62	51.4	12.14	59.8	14.82	63.8	16.32	67.9	17.20	71.3	17.88	72.6	18.29
	43	42.0	10.39	50.2	13.12	58.3	16.19	62.3	17.57	66.2	18.44	68.4	19.10	69.6	19.38
46	39.4	11.69	47.0	14.94	54.6	18.45	58.4	19.92	60.2	20.49	62.4	20.60	63.6	20.79	
48	34.8	10.22	41.6	13.07	48.3	16.14	51.6	17.37	52.2	17.43	54.3	17.47	55.3	17.61	
80	10	6.1	0.61	8.3	0.77	11.1	0.96	15.7	1.11	20.7	1.42	29.8	1.88	39.5	2.46
	12	6.1	0.62	8.3	0.78	11.1	0.97	15.7	1.12	20.7	1.44	29.8	1.90	39.5	2.49
	14	6.1	0.63	8.3	0.78	11.1	0.98	15.7	1.13	20.7	1.45	29.8	1.92	39.5	2.51
	16	6.1	0.63	8.3	0.79	11.1	0.99	15.7	1.14	20.7	1.47	29.8	1.94	39.5	2.54
	18	6.1	0.64	8.3	0.80	11.1	1.00	15.7	1.16	20.7	1.48	29.8	1.96	39.5	2.56
	20	6.1	0.65	8.3	0.81	11.1	1.01	15.7	1.17	20.7	1.50	29.8	1.98	39.5	2.59
	21	6.1	0.65	8.3	0.83	14.0	1.28	18.7	1.40	23.4	1.80	32.4	2.17	42.0	2.85
	23	10.8	1.20	13.8	1.43	19.7	1.81	24.8	2.01	29.0	2.64	37.7	3.22	46.9	3.92
	25	15.6	1.74	19.3	2.29	25.5	2.68	30.8	3.18	34.5	3.85	43.0	4.87	51.8	5.66
	27	20.3	2.56	24.8	3.26	31.2	4.17	36.9	4.72	40.0	5.62	48.3	6.55	56.8	7.41
	29	25.0	3.31	30.3	4.48	37.0	5.80	43.0	6.53	45.6	7.42	53.6	8.41	61.7	9.81
	31	29.8	4.06	35.8	5.64	42.7	7.27	49.0	8.34	52.1	8.99	59.0	9.70	66.6	11.28
	33	34.5	5.34	41.3	6.94	48.5	8.54	55.1	9.88	58.3	10.33	64.3	11.49	71.5	12.70
	35	39.3	6.99	46.8	8.76	54.3	10.75	58.2	11.81	62.1	12.93	69.7	14.66	76.4	15.27
	37	39.3	7.40	46.8	9.32	54.3	11.40	58.2	12.55	62.1	13.73	69.7	15.48	75.2	16.05
	39	39.3	7.82	46.8	9.85	54.3	12.20	58.2	13.50	62.1	14.76	69.7	16.35	73.9	16.93
	41	38.3	8.65	45.6	10.91	52.9	13.39	56.7	14.79	60.5	16.22	67.9	17.52	70.8	17.92
	43	37.3	9.52	44.5	11.91	51.6	14.61	55.3	16.12	59.1	17.72	66.2	18.72	67.9	19.18
46	35.0	10.59	41.7	13.42	48.4	16.47	51.9	17.94	55.3	20.00	60.6	20.60	62.0	20.79	
48	30.9	9.25	36.9	11.73	42.8	14.40	45.9	15.67	49.0	17.43	52.6	17.47	53.9	17.61	

# 7. Capacity Tables

Cooling Capacity (26HP)

Combination (%)	Outdoor air temp. (DB, °C)	Indoor air temp. (DB/WB, °C)													
		20		23		26		27		28		30		32	
		14		16		18		19		20		22		24	
		TC	PI	TC	PI	TC	PI	TC	PI	TC	PI	TC	PI	TC	PI
70	10	5.3	0.54	7.3	0.68	9.7	0.85	13.7	0.99	18.0	1.26	25.9	1.66	34.4	2.17
	12	5.3	0.55	7.3	0.69	9.7	0.86	13.7	1.00	18.0	1.27	25.9	1.68	34.4	2.20
	14	5.3	0.55	7.3	0.69	9.7	0.87	13.7	1.01	18.0	1.29	25.9	1.70	34.4	2.22
	16	5.3	0.56	7.3	0.70	9.7	0.88	13.7	1.02	18.0	1.30	25.9	1.71	34.4	2.24
	18	5.3	0.57	7.3	0.71	9.7	0.89	13.7	1.03	18.0	1.31	25.9	1.73	34.4	2.27
	20	5.3	0.57	7.3	0.71	9.7	0.90	13.7	1.04	18.0	1.32	25.9	1.75	34.4	2.29
	21	5.3	0.57	8.5	0.84	12.6	1.18	16.9	1.30	20.8	1.59	28.6	1.92	37.0	2.52
	23	7.6	0.86	13.1	1.37	17.6	1.72	22.8	1.87	26.4	2.34	33.9	2.85	42.1	3.46
	25	12.1	1.43	17.7	2.02	22.6	2.37	28.6	2.96	32.0	3.41	39.3	4.30	47.2	5.00
	27	16.5	2.08	22.4	2.88	27.5	3.50	34.5	4.39	37.6	4.97	44.7	5.79	52.4	6.55
	29	21.0	2.64	27.0	3.81	32.5	4.76	40.3	5.98	43.2	6.56	50.1	7.44	57.5	8.67
	31	25.5	3.24	31.7	4.73	37.5	5.96	46.2	7.51	48.8	7.95	55.4	8.57	62.6	9.97
	33	29.9	4.36	36.3	5.76	42.5	6.92	51.0	8.72	54.3	9.13	60.8	10.16	67.6	11.23
	35	34.3	5.97	41.1	7.45	47.6	9.01	51.0	9.85	54.3	10.76	60.8	12.66	67.6	13.88
	37	34.3	6.35	41.1	7.88	47.6	9.57	51.0	10.48	54.3	11.44	60.8	13.48	67.6	14.65
	39	34.3	6.74	41.1	8.41	47.6	10.23	51.0	11.27	54.3	12.36	60.8	14.42	67.6	15.80
41	33.4	7.45	40.0	9.21	46.4	11.22	49.7	12.36	52.9	13.44	59.3	15.84	65.9	17.03	
43	32.6	8.11	39.0	10.04	45.2	12.25	48.4	13.48	51.6	14.68	57.8	17.31	64.2	18.42	
46	30.6	9.01	36.6	11.28	42.4	13.79	45.4	15.01	48.4	16.54	54.2	19.52	60.2	20.54	
48	27.0	7.87	32.4	9.86	37.5	12.06	40.1	13.12	42.8	14.47	47.9	17.08	53.3	17.61	
60	10	4.7	0.49	6.3	0.61	8.4	0.77	11.8	0.89	15.6	1.13	22.4	1.49	29.8	1.95
	12	4.7	0.49	6.3	0.62	8.4	0.77	11.8	0.90	15.6	1.14	22.4	1.51	29.8	1.97
	14	4.7	0.50	6.3	0.62	8.4	0.78	11.8	0.91	15.6	1.15	22.4	1.52	29.8	1.99
	16	4.7	0.50	6.3	0.63	8.4	0.79	11.8	0.92	15.6	1.17	22.4	1.54	29.8	2.01
	18	4.7	0.51	6.3	0.63	8.4	0.80	11.8	0.93	15.6	1.18	22.4	1.55	29.8	2.03
	20	4.7	0.51	6.3	0.64	8.4	0.81	11.8	0.94	15.6	1.19	22.4	1.57	29.8	2.06
	21	4.7	0.52	6.3	0.66	10.5	1.03	13.9	1.14	17.9	1.43	24.4	1.73	31.7	2.26
	23	4.7	0.57	10.4	1.20	14.8	1.55	19.2	1.65	22.5	2.10	28.3	2.56	35.4	3.11
	25	8.7	1.09	14.5	1.82	19.1	2.13	24.8	2.82	27.2	3.06	33.0	3.79	39.2	4.49
	27	12.8	1.59	18.6	2.59	23.5	3.14	29.9	3.93	31.8	4.39	37.0	5.02	42.9	5.79
	29	17.0	2.06	22.8	3.32	27.8	4.19	35.3	5.16	36.4	5.60	41.1	6.29	46.7	7.40
	31	21.1	2.62	26.9	3.97	32.1	5.10	39.6	6.19	41.1	6.50	46.0	6.97	50.4	8.53
	33	25.2	3.64	31.0	4.82	36.4	5.73	42.7	6.94	45.8	7.44	49.7	8.26	54.2	9.71
	35	29.4	5.07	35.1	6.20	40.8	7.43	43.7	8.09	46.5	8.78	52.3	10.26	58.0	11.83
	37	29.4	5.35	35.1	6.54	40.8	7.87	43.7	8.59	46.5	9.31	52.3	10.89	58.0	12.59
	39	29.4	5.69	35.1	6.97	40.8	8.49	43.7	9.22	46.5	10.02	52.3	11.67	58.0	13.49
41	28.6	6.17	34.2	7.62	39.8	9.22	42.6	10.07	45.3	10.88	50.9	12.81	56.5	14.66	
43	27.9	6.71	33.4	8.30	38.8	10.05	41.5	10.97	44.2	11.87	49.7	13.99	55.1	16.01	
46	26.2	7.51	31.3	9.32	36.4	11.31	38.9	12.33	41.4	13.35	46.5	15.76	51.6	18.24	
48	23.1	6.54	27.7	8.13	32.2	9.88	34.4	10.77	36.7	11.67	41.2	13.78	45.7	15.96	
50	10	4.2	0.44	5.7	0.55	8.1	0.69	10.8	0.84	14.2	1.02	20.5	1.34	27.2	1.75
	12	4.2	0.44	5.7	0.55	8.1	0.69	10.8	0.85	14.2	1.03	20.5	1.35	27.2	1.76
	14	4.2	0.45	5.7	0.56	8.1	0.70	10.8	0.86	14.2	1.04	20.5	1.37	27.2	1.78
	16	4.2	0.45	5.7	0.56	8.1	0.71	10.8	0.87	14.2	1.05	20.5	1.38	27.2	1.80
	18	4.2	0.46	5.7	0.57	8.1	0.72	10.8	0.88	14.2	1.06	20.5	1.40	27.2	1.82
	20	4.2	0.46	5.7	0.58	8.1	0.72	10.8	0.89	14.2	1.07	20.5	1.41	27.2	1.84
	21	4.2	0.46	5.7	0.60	10.1	0.93	12.7	1.07	16.2	1.28	22.2	1.55	28.7	2.02
	23	4.2	0.49	9.1	1.02	13.9	1.39	18.0	1.66	20.5	1.88	25.6	2.30	31.6	2.78
	25	7.6	0.90	12.5	1.50	17.8	1.95	23.8	2.70	25.2	2.75	29.0	3.23	34.6	3.93
	27	10.9	1.29	15.9	2.10	22.1	2.71	27.6	3.59	29.3	3.70	32.4	4.23	37.6	5.00
	29	14.3	1.69	19.2	2.71	25.6	3.49	31.0	4.46	33.4	4.78	35.8	5.24	40.5	6.31
	31	17.7	2.15	22.6	3.22	29.1	4.25	33.8	4.97	35.7	5.28	39.1	5.66	43.5	6.95
	33	21.1	3.00	26.0	3.88	32.7	4.77	35.1	5.45	37.2	5.84	42.3	6.71	46.4	7.79
	35	24.6	4.21	29.4	5.07	34.1	5.98	36.4	6.49	38.7	7.00	43.4	8.07	48.4	9.28
	37	24.6	4.46	29.4	5.35	34.1	6.33	36.4	6.87	38.7	7.41	43.4	8.61	48.4	9.85
	39	24.6	4.76	29.4	5.74	34.1	6.79	36.4	7.40	38.7	7.95	43.4	9.17	48.4	10.64
41	23.9	5.15	28.6	6.21	33.2	7.42	35.5	8.01	37.7	8.61	42.3	10.06	47.1	11.55	
43	23.3	5.60	27.9	6.75	32.4	8.07	34.6	8.72	36.8	9.38	41.3	10.97	46.0	12.60	
46	21.9	6.27	26.2	7.58	30.3	9.06	32.4	9.80	34.5	10.53	38.7	12.34	43.1	14.19	
48	19.4	5.46	23.1	6.61	26.8	7.90	28.7	8.55	30.5	9.19	34.2	10.78	38.1	12.40	

**Note**

1. TC: Total Capacity(kW), PI : Power Input(kW, Comp. + Outdoor fan motor)
2. Capacity tables show the average value of conditions which may occur.

# 7. Capacity Tables

## ◆ ARUM280LTE5

Cooling Capacity (28HP)

Combination (%)	Outdoor air temp. (DB, °C)	Indoor air temp. (DB/WB, °C)													
		20		23		26		27		28		30		32	
		14		16		18		19		20		22		24	
		TC	PI	TC	PI	TC	PI	TC	PI	TC	PI	TC	PI	TC	PI
130	10	11.0	1.06	15.0	1.33	20.1	1.62	28.3	1.97	37.3	2.47	53.7	3.29	71.3	4.35
	12	11.0	1.08	15.0	1.34	20.1	1.63	28.3	1.99	37.3	2.49	53.7	3.32	71.3	4.40
	14	11.0	1.09	15.0	1.36	20.1	1.65	28.3	2.01	37.3	2.52	53.7	3.36	71.3	4.45
	16	11.0	1.10	15.0	1.37	20.1	1.67	28.3	2.04	37.3	2.54	53.7	3.39	71.3	4.49
	18	11.0	1.11	15.0	1.39	20.1	1.69	28.3	2.06	37.3	2.57	53.7	3.43	71.3	4.54
	20	11.0	1.12	15.0	1.40	20.1	1.70	28.3	2.08	37.3	2.60	53.7	3.46	71.3	4.58
	21	11.0	1.13	15.3	1.44	24.8	2.13	33.0	2.47	41.7	3.19	57.2	4.35	73.5	5.16
	23	19.2	2.01	26.7	2.64	34.5	3.01	43.1	3.35	50.5	4.80	64.3	6.21	78.1	7.31
	25	28.3	3.18	34.3	3.96	44.2	4.50	53.8	5.31	59.3	6.90	71.4	9.02	82.7	10.62
	27	37.0	5.07	43.9	5.99	53.9	6.80	63.9	8.13	68.1	10.32	78.5	13.01	87.3	14.66
	29	45.7	7.05	53.4	8.26	63.6	9.99	74.2	11.76	76.9	14.02	85.7	16.82	91.9	18.72
	31	55.4	9.21	64.2	11.36	74.8	13.78	83.6	16.08	85.7	18.34	90.5	23.04	96.6	23.37
	33	65.2	11.35	76.2	14.82	85.5	17.73	90.4	23.02	92.3	22.86	95.2	23.06	101.6	23.39
	35	77.7	15.33	89.0	18.58	91.8	22.54	93.4	22.65	94.9	22.79	97.5	22.99	100.4	23.08
	37	77.7	16.34	87.7	19.49	90.6	22.24	91.8	22.36	93.4	22.49	96.0	22.69	98.8	22.78
	39	77.7	17.40	86.2	20.52	89.0	21.95	90.6	22.06	91.8	22.19	94.7	22.39	97.5	22.47
	41	75.7	18.46	82.6	21.55	85.4	21.65	86.7	21.76	88.4	21.89	91.0	22.08	93.5	22.17
	43	73.8	19.47	79.2	21.24	81.9	21.35	83.2	21.46	84.8	21.59	87.4	21.78	89.8	21.87
46	69.2	20.84	72.2	20.80	74.8	20.90	76.0	21.01	77.6	21.13	80.0	21.32	82.2	21.41	
48	61.2	20.26	62.7	20.32	65.1	20.36	66.1	20.42	67.5	20.60	69.7	20.73	71.6	20.81	
120	10	10.2	1.00	13.9	1.24	18.5	1.51	26.1	1.85	34.4	2.31	49.6	3.08	65.7	4.07
	12	10.2	1.01	13.9	1.26	18.5	1.53	26.1	1.87	34.4	2.33	49.6	3.11	65.7	4.12
	14	10.2	1.02	13.9	1.27	18.5	1.54	26.1	1.88	34.4	2.36	49.6	3.14	65.7	4.16
	16	10.2	1.03	13.9	1.28	18.5	1.56	26.1	1.90	34.4	2.38	49.6	3.17	65.7	4.20
	18	10.2	1.04	13.9	1.30	18.5	1.58	26.1	1.92	34.4	2.40	49.6	3.21	65.7	4.25
	20	10.2	1.05	13.9	1.31	18.5	1.59	26.1	1.94	34.4	2.43	49.6	3.24	65.7	4.29
	21	10.2	1.06	14.1	1.35	23.4	2.03	30.4	2.31	38.9	2.98	53.1	4.07	68.1	4.83
	23	17.7	1.88	25.3	2.51	33.3	2.89	39.7	3.13	48.2	4.49	60.3	5.81	72.8	6.84
	25	27.5	2.98	35.5	3.77	43.6	4.21	49.5	4.97	57.7	6.45	68.1	8.44	77.6	9.93
	27	38.2	4.71	48.4	5.60	54.1	6.31	58.8	7.54	67.3	9.58	75.8	12.08	82.3	13.83
	29	49.1	6.54	58.2	7.55	64.5	9.27	68.4	10.91	76.9	13.01	83.5	15.61	87.0	17.55
	31	59.4	8.28	70.1	9.98	75.0	12.29	78.7	14.46	86.8	16.50	89.2	19.84	92.2	20.21
	33	68.9	10.20	82.7	13.02	87.6	15.82	88.8	18.35	90.4	21.59	92.9	21.84	95.8	22.01
	35	70.3	13.63	83.5	17.66	88.5	19.53	89.7	23.26	91.3	23.38	93.8	23.45	96.2	23.63
	37	70.3	14.66	83.5	18.63	87.3	20.82	88.5	22.77	89.7	22.89	92.2	22.96	94.7	23.14
	39	70.3	15.78	83.3	19.69	85.7	22.09	87.0	22.31	88.2	22.42	91.0	22.48	93.5	22.66
	41	68.5	16.91	79.6	20.75	82.3	21.65	83.5	21.84	84.7	21.95	87.1	22.01	89.6	22.19
	43	66.8	18.05	76.3	20.46	78.9	21.16	80.1	21.37	81.2	21.48	83.6	21.54	86.1	21.71
46	62.6	19.40	69.6	19.97	72.1	20.50	73.1	20.67	74.3	20.77	76.5	20.83	78.8	21.00	
48	55.4	19.01	60.4	19.61	62.6	20.10	63.6	20.22	64.6	20.29	66.6	20.37	68.6	20.45	
110	10	9.3	0.94	12.7	1.17	17.0	1.42	23.9	1.73	31.5	2.17	45.4	2.89	60.2	3.83
	12	9.3	0.95	12.7	1.18	17.0	1.44	23.9	1.75	31.5	2.19	45.4	2.92	60.2	3.87
	14	9.3	0.96	12.7	1.19	17.0	1.45	23.9	1.77	31.5	2.21	45.4	2.95	60.2	3.91
	16	9.3	0.97	12.7	1.21	17.0	1.47	23.9	1.79	31.5	2.24	45.4	2.98	60.2	3.95
	18	9.3	0.98	12.7	1.22	17.0	1.48	23.9	1.81	31.5	2.26	45.4	3.01	60.2	3.99
	20	9.3	0.99	12.7	1.23	17.0	1.50	23.9	1.83	31.5	2.28	45.4	3.04	60.2	4.03
	21	9.3	0.99	12.7	1.27	21.2	1.87	28.1	2.17	35.1	2.80	49.0	3.83	63.3	4.53
	23	16.7	1.77	21.2	2.36	29.8	2.65	36.7	2.94	44.5	4.22	55.7	5.46	68.8	6.43
	25	24.0	2.80	29.8	3.54	38.3	3.96	45.3	4.67	52.8	6.07	62.2	7.93	74.2	9.33
	27	31.4	4.42	38.3	5.27	46.8	5.93	53.8	7.09	61.6	9.00	69.3	11.35	80.2	12.99
	29	38.7	6.14	46.8	7.09	55.3	8.71	62.6	10.25	70.3	12.22	76.4	14.38	84.6	15.94
	31	47.0	7.78	56.4	9.38	65.1	11.55	71.3	13.59	79.1	15.50	83.4	16.62	87.7	17.90
	33	54.5	9.59	65.1	12.24	73.8	14.87	80.4	16.61	85.5	18.64	88.1	19.16	90.4	19.19
	35	62.9	12.08	75.0	15.54	83.8	17.71	86.2	18.98	87.5	20.15	89.6	20.33	92.0	20.43
	37	62.9	12.80	75.0	16.49	83.8	18.70	85.0	20.11	85.9	21.25	88.4	21.32	90.5	21.38
	39	62.9	13.80	75.0	17.52	82.3	19.73	83.5	21.51	84.7	22.30	86.8	22.34	89.3	22.36
	41	61.3	14.80	73.1	18.56	78.8	20.81	80.0	23.26	81.1	23.26	83.4	23.45	85.5	23.63
	43	59.8	15.54	71.3	19.33	75.5	22.07	76.7	22.31	77.7	22.27	80.0	22.39	82.1	22.45
46	56.1	15.17	66.8	18.66	68.9	20.94	70.1	20.94	71.0	21.12	73.2	21.24	75.1	21.30	
48	49.6	14.73	58.1	17.98	59.8	19.92	60.9	20.06	61.7	20.15	63.6	20.21	65.3	20.29	

# 7. Capacity Tables

Cooling Capacity (28HP)

Combination (%)	Outdoor air temp. (DB, °C)	Indoor air temp. (DB/WB, °C)													
		20		23		26		27		28		30		32	
		14		16		18		19		20		22		24	
		TC	PI	TC	PI	TC	PI	TC	PI	TC	PI	TC	PI	TC	PI
100	10	8.6	0.86	11.7	1.07	15.6	1.30	22.0	1.59	28.9	1.99	41.7	2.65	55.2	3.51
	12	8.6	0.87	11.7	1.08	15.6	1.32	22.0	1.61	28.9	2.01	41.7	2.68	55.2	3.55
	14	8.6	0.88	11.7	1.09	15.6	1.33	22.0	1.62	28.9	2.03	41.7	2.71	55.2	3.59
	16	8.6	0.89	11.7	1.11	15.6	1.35	22.0	1.64	28.9	2.05	41.7	2.74	55.2	3.62
	18	8.6	0.89	11.7	1.12	15.6	1.36	22.0	1.66	28.9	2.07	41.7	2.76	55.2	3.66
	20	8.6	0.90	11.7	1.13	15.6	1.37	22.0	1.67	28.9	2.09	41.7	2.79	55.2	3.70
	21	8.6	0.91	11.7	1.16	19.4	1.72	25.8	1.99	33.0	2.57	45.0	3.51	58.1	4.16
	23	14.8	1.62	20.4	2.17	27.1	2.43	34.0	2.70	41.2	3.87	51.6	5.01	63.7	5.90
	25	21.2	2.57	27.6	3.25	34.8	3.63	42.3	4.28	49.3	5.56	58.2	7.28	69.3	8.56
	27	27.5	4.06	34.7	4.83	42.5	5.44	50.3	6.50	57.5	8.26	64.8	10.41	75.0	11.92
	29	33.8	5.64	41.8	6.51	50.2	7.99	58.5	9.41	65.7	11.21	71.4	13.46	80.6	14.63
	31	40.2	7.14	48.9	8.60	58.0	10.60	66.6	12.47	73.9	14.22	78.0	15.56	86.9	16.58
	33	46.5	8.80	56.0	11.23	65.7	13.64	74.8	15.82	82.2	17.28	84.7	17.58	86.9	17.96
	35	52.9	10.59	63.0	13.52	73.4	16.81	78.4	18.61	82.2	18.72	84.7	18.79	86.9	18.95
	37	52.9	11.35	63.0	14.51	73.4	17.81	78.4	19.50	80.8	19.59	83.1	19.67	85.1	19.85
	39	52.9	12.16	63.0	15.58	73.4	18.87	78.4	20.45	79.5	20.54	81.8	20.62	83.7	20.81
	41	52.1	12.98	62.0	16.66	72.2	19.93	75.2	21.40	76.9	21.49	78.7	21.56	81.2	21.76
43	50.3	13.74	59.9	17.66	69.7	20.88	72.1	22.22	73.0	22.30	75.2	22.37	77.2	22.58	
46	47.1	14.78	56.1	19.04	65.3	22.15	65.9	23.26	66.6	23.33	68.7	23.40	70.5	23.62	
48	41.7	12.76	49.6	16.47	56.4	18.94	57.2	19.74	57.8	19.80	59.7	19.85	61.4	20.01	
90	10	7.7	0.79	10.5	0.99	14.0	1.24	19.4	1.42	26.0	1.83	37.5	2.41	49.7	3.16
	12	7.7	0.80	10.5	1.00	14.0	1.25	19.4	1.43	26.0	1.85	37.5	2.44	49.7	3.19
	14	7.7	0.81	10.5	1.01	14.0	1.27	19.4	1.45	26.0	1.87	37.5	2.46	49.7	3.23
	16	7.7	0.81	10.5	1.02	14.0	1.28	19.4	1.46	26.0	1.89	37.5	2.49	49.7	3.26
	18	7.7	0.82	10.5	1.03	14.0	1.29	19.4	1.48	26.0	1.91	37.5	2.52	49.7	3.29
	20	7.7	0.83	10.5	1.04	14.0	1.30	19.4	1.49	26.0	1.93	37.5	2.54	49.7	3.33
	21	7.7	0.84	10.5	1.05	17.6	1.64	22.9	1.77	29.4	2.31	40.5	2.79	52.3	3.66
	23	10.4	1.30	15.4	1.80	24.5	2.33	29.7	2.54	35.9	3.40	46.6	4.14	57.6	5.03
	25	16.6	2.20	22.3	2.89	31.5	3.45	36.5	4.01	42.4	4.95	52.6	6.26	63.0	7.28
	27	22.8	3.23	29.2	4.12	38.4	5.35	43.3	5.96	49.0	7.22	58.7	8.42	68.3	9.52
	29	29.0	4.36	36.1	5.65	45.3	7.46	50.1	8.25	55.5	9.53	64.7	10.81	73.6	12.60
	31	35.2	5.45	43.0	7.26	52.3	9.34	56.9	10.52	62.0	11.88	70.8	12.59	78.9	14.65
	33	41.3	7.02	49.9	8.94	59.2	11.32	63.8	12.48	68.6	13.81	76.8	14.92	84.2	16.36
	35	47.6	8.70	56.8	11.00	66.1	13.60	70.6	15.00	75.0	16.30	82.8	17.49	84.2	17.89
	37	47.6	9.23	56.8	11.70	66.1	14.50	70.6	15.93	75.0	17.21	81.5	18.28	82.9	18.69
	39	47.6	9.77	56.8	12.44	66.1	15.34	70.6	16.95	75.0	18.10	80.2	19.28	81.6	19.51
	41	46.4	10.94	55.4	13.79	64.4	16.84	68.8	18.54	73.1	19.54	76.8	20.31	78.2	20.78
43	45.2	11.80	54.0	14.90	62.8	18.39	67.1	19.96	71.3	20.95	73.6	21.70	75.0	22.02	
46	42.4	13.29	50.6	16.97	58.8	20.96	62.8	22.63	64.8	23.27	67.2	23.40	68.5	23.62	
48	37.5	11.61	44.8	14.85	52.1	18.34	55.6	19.74	56.3	19.80	58.4	19.85	59.5	20.01	
80	10	6.6	0.70	9.0	0.87	12.0	1.10	16.9	1.26	22.3	1.62	32.1	2.13	42.5	2.79
	12	6.6	0.71	9.0	0.88	12.0	1.11	16.9	1.27	22.3	1.63	32.1	2.16	42.5	2.82
	14	6.6	0.71	9.0	0.89	12.0	1.12	16.9	1.29	22.3	1.65	32.1	2.18	42.5	2.85
	16	6.6	0.72	9.0	0.90	12.0	1.13	16.9	1.30	22.3	1.67	32.1	2.20	42.5	2.88
	18	6.6	0.73	9.0	0.91	12.0	1.14	16.9	1.31	22.3	1.69	32.1	2.22	42.5	2.91
	20	6.6	0.74	9.0	0.92	12.0	1.15	16.9	1.33	22.3	1.70	32.1	2.25	42.5	2.94
	21	6.6	0.74	9.0	0.94	15.0	1.45	20.2	1.59	25.2	2.04	34.9	2.47	45.2	3.24
	23	11.7	1.36	14.9	1.62	21.2	2.06	26.7	2.28	31.2	3.00	40.6	3.66	50.5	4.45
	25	16.8	1.98	20.8	2.60	27.4	3.05	33.2	3.61	37.2	4.38	46.3	5.53	55.8	6.43
	27	21.9	2.90	26.7	3.70	33.6	4.73	39.7	5.37	43.1	6.38	52.0	7.45	61.1	8.42
	29	27.0	3.77	32.6	5.09	39.8	6.59	46.3	7.42	49.1	8.43	57.8	9.56	66.4	11.14
	31	32.1	4.61	38.5	6.40	46.0	8.26	52.8	9.47	56.1	10.21	63.5	11.02	71.7	12.82
	33	37.2	6.07	44.5	7.88	52.2	9.70	59.4	11.23	62.8	11.74	69.2	13.06	77.0	14.43
	35	42.3	7.94	50.4	9.96	58.5	12.21	62.7	13.41	66.9	14.69	75.0	16.66	82.3	17.35
	37	42.3	8.40	50.4	10.58	58.5	12.96	62.7	14.26	66.9	15.60	75.0	17.58	80.9	18.23
	39	42.3	8.88	50.4	11.19	58.5	13.86	62.7	15.33	66.9	16.77	75.0	18.58	79.6	19.23
	41	41.2	9.82	49.1	12.40	57.0	15.21	61.1	16.81	65.2	18.42	73.1	19.91	76.3	20.36
43	40.2	10.81	47.9	13.53	55.6	16.60	59.6	18.32	63.6	20.13	71.3	21.27	73.1	21.80	
46	37.7	12.03	44.9	15.24	52.1	18.71	55.9	20.39	59.6	22.72	65.2	23.40	66.7	23.62	
48	33.3	10.51	39.7	13.33	46.1	16.36	49.4	17.81	52.7	19.80	56.6	19.85	58.0	20.01	

# 7. Capacity Tables

Cooling Capacity (28HP)

Combination (%)	Outdoor air temp. (DB, °C)	Indoor air temp. (DB/WB, °C)													
		20		23		26		27		28		30		32	
		14		16		18		19		20		22		24	
		TC	PI	TC	PI	TC	PI	TC	PI	TC	PI	TC	PI	TC	PI
70	10	5.7	0.62	7.8	0.77	10.4	0.97	14.7	1.12	19.4	1.43	27.9	1.89	37.0	2.47
	12	5.7	0.62	7.8	0.78	10.4	0.98	14.7	1.13	19.4	1.44	27.9	1.91	37.0	2.50
	14	5.7	0.63	7.8	0.79	10.4	0.99	14.7	1.15	19.4	1.46	27.9	1.93	37.0	2.52
	16	5.7	0.64	7.8	0.80	10.4	1.00	14.7	1.16	19.4	1.48	27.9	1.95	37.0	2.55
	18	5.7	0.64	7.8	0.80	10.4	1.01	14.7	1.17	19.4	1.49	27.9	1.97	37.0	2.57
	20	5.7	0.65	7.8	0.81	10.4	1.02	14.7	1.18	19.4	1.51	27.9	1.99	37.0	2.60
	21	5.7	0.65	9.1	0.95	13.5	1.34	18.2	1.48	22.4	1.81	30.8	2.18	39.8	2.86
	23	8.2	0.98	14.1	1.56	18.9	1.96	24.5	2.13	28.4	2.65	36.6	3.24	45.4	3.93
	25	13.0	1.62	19.1	2.30	24.3	2.70	30.8	3.36	34.4	3.87	42.3	4.89	50.9	5.69
	27	17.8	2.36	24.1	3.27	29.7	3.98	37.1	4.99	40.5	5.64	48.1	6.58	56.4	7.44
	29	22.6	3.00	29.1	4.33	35.0	5.41	43.4	6.79	46.5	7.45	53.9	8.45	61.9	9.85
	31	27.4	3.69	34.1	5.38	40.4	6.77	49.7	8.53	52.5	9.03	59.7	9.74	67.4	11.33
	33	32.2	4.96	39.1	6.54	45.8	7.86	54.9	9.91	58.5	10.37	65.5	11.54	72.8	12.76
	35	37.0	6.79	44.2	8.46	51.2	10.23	54.9	11.19	58.5	12.22	65.5	14.39	72.8	15.78
	37	37.0	7.21	44.2	8.96	51.2	10.87	54.9	11.90	58.5	13.00	65.5	15.31	72.8	16.65
	39	37.0	7.66	44.2	9.55	51.2	11.62	54.9	12.80	58.5	14.05	65.5	16.39	72.8	17.95
	41	36.0	8.47	43.1	10.46	49.9	12.75	53.5	14.04	57.0	15.27	63.8	18.00	70.9	19.35
43	35.1	9.22	42.0	11.40	48.7	13.91	52.2	15.31	55.6	16.67	62.3	19.66	69.2	20.92	
46	32.9	10.24	39.4	12.82	45.6	15.67	48.9	17.06	52.1	18.80	58.4	22.18	64.8	23.33	
48	29.1	8.94	34.9	11.20	40.4	13.70	43.2	14.91	46.1	16.44	51.6	19.41	57.4	20.01	
60	10	5.0	0.55	6.8	0.68	9.0	0.86	12.7	1.00	16.8	1.27	24.2	1.67	32.0	2.19
	12	5.0	0.55	6.8	0.69	9.0	0.87	12.7	1.01	16.8	1.28	24.2	1.69	32.0	2.21
	14	5.0	0.56	6.8	0.70	9.0	0.88	12.7	1.02	16.8	1.29	24.2	1.71	32.0	2.24
	16	5.0	0.56	6.8	0.70	9.0	0.89	12.7	1.03	16.8	1.31	24.2	1.73	32.0	2.26
	18	5.0	0.57	6.8	0.71	9.0	0.89	12.7	1.04	16.8	1.32	24.2	1.74	32.0	2.28
	20	5.0	0.58	6.8	0.72	9.0	0.90	12.7	1.05	16.8	1.33	24.2	1.76	32.0	2.31
	21	5.0	0.58	6.8	0.75	11.3	1.16	15.0	1.28	19.2	1.60	26.2	1.94	34.1	2.54
	23	5.0	0.64	11.2	1.35	15.9	1.74	20.7	1.85	24.2	2.35	30.5	2.87	38.1	3.49
	25	9.4	1.22	15.6	2.04	20.6	2.39	26.7	3.17	29.2	3.43	35.5	4.25	42.2	5.04
	27	13.8	1.78	20.1	2.90	25.3	3.52	32.2	4.41	34.2	4.92	39.9	5.63	46.2	6.49
	29	18.3	2.31	24.5	3.72	29.9	4.70	38.0	5.79	39.2	6.28	44.2	7.06	50.3	8.30
	31	22.7	2.93	29.0	4.45	34.6	5.72	42.6	6.95	44.2	7.29	49.5	7.82	54.3	9.56
	33	27.1	4.09	33.4	5.41	39.2	6.42	46.0	7.79	49.3	8.34	53.5	9.26	58.4	10.89
	35	31.6	5.76	37.8	7.04	44.0	8.44	47.0	9.19	50.1	9.97	56.3	11.66	62.4	13.44
	37	31.6	6.08	37.8	7.43	44.0	8.94	47.0	9.76	50.1	10.58	56.3	12.37	62.4	14.30
	39	31.6	6.46	37.8	7.91	44.0	9.65	47.0	10.47	50.1	11.39	56.3	13.26	62.4	15.32
	41	30.8	7.01	36.8	8.66	42.8	10.48	45.8	11.44	48.8	12.36	54.8	14.56	60.8	16.65
43	30.1	7.62	35.9	9.43	41.8	11.42	44.7	12.47	47.6	13.48	53.5	15.89	59.3	18.19	
46	28.2	8.53	33.7	10.59	39.2	12.85	41.9	14.01	44.6	15.17	50.1	17.90	55.6	20.72	
48	24.9	7.43	29.8	9.24	34.6	11.22	37.1	12.24	39.5	13.26	44.3	15.66	49.2	18.13	
50	10	4.5	0.49	6.2	0.61	8.7	0.76	11.6	0.93	15.3	1.12	22.1	1.48	29.3	1.93
	12	4.5	0.49	6.2	0.61	8.7	0.77	11.6	0.94	15.3	1.14	22.1	1.50	29.3	1.95
	14	4.5	0.50	6.2	0.62	8.7	0.78	11.6	0.95	15.3	1.15	22.1	1.51	29.3	1.97
	16	4.5	0.50	6.2	0.62	8.7	0.79	11.6	0.96	15.3	1.16	22.1	1.53	29.3	1.99
	18	4.5	0.51	6.2	0.63	8.7	0.79	11.6	0.97	15.3	1.17	22.1	1.55	29.3	2.01
	20	4.5	0.51	6.2	0.64	8.7	0.80	11.6	0.98	15.3	1.18	22.1	1.56	29.3	2.03
	21	4.5	0.51	6.2	0.66	10.8	1.03	13.7	1.18	17.4	1.42	24.0	1.72	30.9	2.24
	23	4.5	0.55	9.8	1.12	15.0	1.54	19.4	1.84	22.1	2.09	27.6	2.54	34.1	3.08
	25	8.1	1.00	13.4	1.66	19.2	2.16	25.6	2.98	27.1	3.04	31.2	3.58	37.3	4.35
	27	11.8	1.43	17.1	2.33	23.8	3.00	29.7	3.98	31.5	4.10	34.9	4.69	40.5	5.53
	29	15.4	1.87	20.7	3.00	27.6	3.86	33.4	4.93	36.0	5.29	38.5	5.81	43.7	6.99
	31	19.1	2.38	24.4	3.57	31.4	4.71	36.4	5.50	38.5	5.85	42.1	6.27	46.9	7.69
	33	22.8	3.32	28.0	4.30	35.2	5.28	37.8	6.03	40.1	6.46	45.5	7.43	50.0	8.63
	35	26.5	4.78	31.6	5.76	36.7	6.80	39.2	7.38	41.7	7.95	46.8	9.17	52.1	10.54
	37	26.5	5.07	31.6	6.08	36.7	7.20	39.2	7.81	41.7	8.42	46.8	9.79	52.1	11.19
	39	26.5	5.41	31.6	6.52	36.7	7.71	39.2	8.40	41.7	9.03	46.8	10.42	52.1	12.08
	41	25.8	5.85	30.8	7.05	35.7	8.43	38.2	9.10	40.7	9.79	45.6	11.43	50.7	13.12
43	25.1	6.36	30.1	7.67	34.9	9.17	37.3	9.91	39.6	10.66	44.4	12.46	49.5	14.32	
46	23.6	7.12	28.2	8.61	32.7	10.29	34.9	11.13	37.2	11.96	41.6	14.02	46.4	16.12	
48	20.8	6.21	24.9	7.51	28.9	8.98	30.9	9.71	32.9	10.44	36.8	12.25	41.0	14.09	

**Note**

1. TC: Total Capacity(kW), PI : Power Input(kW, Comp. + Outdoor fan motor)
2. Capacity tables show the average value of conditions which may occur.

# 7. Capacity Tables

◆ ARUM300LTE5

Cooling Capacity (30HP)

Combination (%)	Outdoor air temp. (DB, °C)	Indoor air temp. (DB/WB, °C)													
		20		23		26		27		28		30		32	
		14	16	16	18	18	19	20	20	22	22	24	24		
		TC	PI	TC	PI	TC	PI	TC	PI	TC	PI	TC	PI	TC	PI
130	10	11.8	1.07	16.1	1.34	21.5	1.63	30.3	1.99	40.0	2.48	57.6	3.31	76.4	4.39
	12	11.8	1.08	16.1	1.35	21.5	1.65	30.3	2.01	40.0	2.51	57.6	3.35	76.4	4.43
	14	11.8	1.09	16.1	1.37	21.5	1.66	30.3	2.03	40.0	2.54	57.6	3.38	76.4	4.48
	16	11.8	1.11	16.1	1.38	21.5	1.68	30.3	2.05	40.0	2.56	57.6	3.42	76.4	4.52
	18	11.8	1.12	16.1	1.39	21.5	1.70	30.3	2.07	40.0	2.59	57.6	3.45	76.4	4.57
	20	11.8	1.13	16.1	1.41	21.5	1.71	30.3	2.09	40.0	2.61	57.6	3.49	76.4	4.62
	21	11.8	1.14	16.4	1.45	26.6	2.14	35.4	2.49	44.7	3.21	61.3	4.38	78.8	5.19
	23	20.5	2.02	28.6	2.66	37.0	3.03	46.2	3.37	54.1	4.83	68.9	6.25	83.7	7.36
	25	30.4	3.21	36.8	3.99	47.4	4.53	57.6	5.34	63.6	6.95	76.5	9.09	88.6	10.69
	27	39.6	5.11	47.0	6.03	57.8	6.85	68.4	8.19	73.0	10.39	84.1	13.10	93.5	14.76
	29	48.9	7.09	57.3	8.32	68.1	10.06	79.6	11.84	82.4	14.11	91.8	16.94	98.4	18.85
	31	59.4	9.27	68.8	11.44	80.1	13.87	89.6	16.20	91.8	18.47	96.9	23.20	103.5	23.53
	33	69.8	11.43	81.6	14.92	91.6	17.86	96.8	23.18	98.9	23.02	102.0	23.23	108.9	23.55
	35	83.2	15.43	95.3	18.71	98.4	22.70	100.1	22.81	101.7	22.95	104.5	23.15	107.5	23.25
	37	83.2	16.46	94.0	19.63	97.1	22.40	98.4	22.51	100.1	22.65	102.8	22.85	105.9	22.94
	39	83.2	17.52	92.3	20.66	95.3	22.10	97.1	22.21	98.4	22.34	101.4	22.54	104.5	22.63
	41	81.1	18.59	88.5	21.70	91.5	21.80	92.9	21.91	94.7	22.04	97.5	22.24	100.2	22.32
	43	79.1	19.61	84.8	21.39	87.8	21.50	89.1	21.61	90.9	21.74	93.7	21.93	96.2	22.02
46	74.1	20.99	77.4	20.94	80.2	21.05	81.4	21.16	83.1	21.28	85.7	21.47	88.1	21.56	
48	65.5	20.40	67.2	20.46	69.7	20.51	70.8	20.56	72.3	20.74	74.6	20.87	76.7	20.95	
120	10	10.9	1.00	14.9	1.25	19.8	1.52	28.0	1.86	36.9	2.32	53.1	3.10	70.4	4.10
	12	10.9	1.01	14.9	1.27	19.8	1.54	28.0	1.88	36.9	2.35	53.1	3.13	70.4	4.15
	14	10.9	1.02	14.9	1.28	19.8	1.56	28.0	1.90	36.9	2.37	53.1	3.16	70.4	4.19
	16	10.9	1.03	14.9	1.29	19.8	1.57	28.0	1.92	36.9	2.40	53.1	3.20	70.4	4.23
	18	10.9	1.05	14.9	1.30	19.8	1.59	28.0	1.94	36.9	2.42	53.1	3.23	70.4	4.28
	20	10.9	1.06	14.9	1.32	19.8	1.60	28.0	1.96	36.9	2.45	53.1	3.26	70.4	4.32
	21	10.9	1.07	15.1	1.36	25.1	2.04	32.6	2.33	41.7	3.00	56.9	4.10	73.0	4.86
	23	18.9	1.89	27.2	2.53	35.7	2.91	42.6	3.15	51.6	4.52	64.6	5.85	78.0	6.89
	25	29.5	3.00	38.1	3.79	46.7	4.24	53.1	5.00	61.9	6.50	72.9	8.50	83.1	10.00
	27	41.0	4.74	51.8	5.64	58.0	6.35	63.0	7.60	72.1	9.64	81.2	12.16	88.2	13.92
	29	52.6	6.58	62.4	7.60	69.1	9.33	73.3	10.99	82.4	13.10	89.5	15.72	93.3	17.68
	31	63.7	8.34	75.1	10.05	80.4	12.38	84.4	14.56	93.0	16.61	95.5	19.98	98.7	20.35
	33	73.8	10.27	88.6	13.11	93.9	15.93	95.2	18.48	96.8	21.74	99.5	21.99	102.6	22.17
	35	75.3	13.73	89.5	17.78	94.8	19.67	96.2	23.43	97.8	23.54	100.5	23.61	103.1	23.80
	37	75.3	14.76	89.5	18.76	93.5	20.97	94.8	22.93	96.2	23.05	98.8	23.12	101.5	23.30
	39	75.3	15.89	89.2	19.83	91.9	22.24	93.2	22.46	94.5	22.57	97.5	22.64	100.1	22.82
	41	73.4	17.02	85.3	20.90	88.2	21.80	89.4	21.99	90.7	22.10	93.4	22.17	96.0	22.34
	43	71.5	18.17	81.7	20.60	84.6	21.31	85.8	21.52	87.1	21.63	89.6	21.69	92.2	21.86
46	67.0	19.54	74.5	20.11	77.2	20.64	78.4	20.81	79.6	20.92	82.0	20.98	84.4	21.15	
48	59.3	19.14	64.7	19.75	67.1	20.24	68.1	20.36	69.2	20.43	71.3	20.51	73.5	20.59	
110	10	10.0	0.94	13.6	1.18	18.2	1.43	25.6	1.75	33.8	2.18	48.6	2.91	64.5	3.85
	12	10.0	0.95	13.6	1.19	18.2	1.45	25.6	1.76	33.8	2.21	48.6	2.94	64.5	3.90
	14	10.0	0.96	13.6	1.20	18.2	1.46	25.6	1.78	33.8	2.23	48.6	2.97	64.5	3.94
	16	10.0	0.97	13.6	1.21	18.2	1.48	25.6	1.80	33.8	2.25	48.6	3.00	64.5	3.98
	18	10.0	0.98	13.6	1.23	18.2	1.49	25.6	1.82	33.8	2.28	48.6	3.03	64.5	4.02
	20	10.0	0.99	13.6	1.24	18.2	1.51	25.6	1.84	33.8	2.30	48.6	3.06	64.5	4.06
	21	10.0	1.00	13.6	1.28	22.8	1.88	30.1	2.19	37.6	2.82	52.5	3.85	67.8	4.57
	23	17.9	1.78	22.8	2.38	31.9	2.67	39.3	2.96	47.6	4.25	59.7	5.50	73.7	6.47
	25	25.7	2.82	31.9	3.57	41.0	3.98	48.5	4.70	56.6	6.11	66.7	7.99	79.5	9.40
	27	33.6	4.46	41.0	5.30	50.1	5.97	57.7	7.14	66.0	9.06	74.3	11.43	85.9	13.08
	29	41.5	6.19	50.1	7.14	59.3	8.77	67.0	10.33	75.3	12.31	81.8	14.48	90.7	16.06
	31	50.3	7.83	60.4	9.44	69.7	11.63	76.4	13.69	84.7	15.61	89.4	16.74	94.0	18.02
	33	58.3	9.65	69.7	12.32	79.0	14.97	86.2	16.73	91.6	18.77	94.4	19.29	96.8	19.32
	35	67.4	12.16	80.4	15.65	89.8	17.84	92.4	19.11	93.7	20.29	96.0	20.47	98.6	20.57
	37	67.4	12.89	80.4	16.61	89.8	18.83	91.1	20.25	92.1	21.40	94.7	21.47	96.9	21.53
	39	67.4	13.90	80.4	17.65	88.2	19.87	89.5	21.66	90.8	22.46	93.0	22.49	95.7	22.52
	41	65.7	14.90	78.3	18.69	84.4	20.95	85.7	23.43	86.8	23.43	89.4	23.61	91.6	23.80
	43	64.1	15.65	76.4	19.47	80.9	22.22	82.2	22.47	83.3	22.42	85.8	22.55	87.9	22.61
46	60.1	15.27	71.6	18.79	73.8	21.09	75.1	21.09	76.1	21.27	78.4	21.39	80.4	21.44	
48	53.1	14.83	62.2	18.11	64.1	20.06	65.3	20.20	66.1	20.30	68.2	20.35	70.0	20.43	

# 7. Capacity Tables

Cooling Capacity (30HP)

Combination (%)	Outdoor air temp. (DB, °C)	Indoor air temp. (DB/WB, °C)													
		20		23		26		27		28		30		32	
		14		16		18		19		20		22		24	
		TC	PI	TC	PI	TC	PI	TC	PI	TC	PI	TC	PI	TC	PI
100	10	9.2	0.86	12.5	1.08	16.7	1.31	23.5	1.60	31.0	2.00	44.6	2.67	59.2	3.54
	12	9.2	0.87	12.5	1.09	16.7	1.33	23.5	1.62	31.0	2.02	44.6	2.70	59.2	3.57
	14	9.2	0.88	12.5	1.10	16.7	1.34	23.5	1.64	31.0	2.05	44.6	2.73	59.2	3.61
	16	9.2	0.89	12.5	1.11	16.7	1.36	23.5	1.65	31.0	2.07	44.6	2.76	59.2	3.65
	18	9.2	0.90	12.5	1.12	16.7	1.37	23.5	1.67	31.0	2.09	44.6	2.78	59.2	3.69
	20	9.2	0.91	12.5	1.14	16.7	1.38	23.5	1.69	31.0	2.11	44.6	2.81	59.2	3.72
	21	9.2	0.92	12.5	1.17	20.8	1.73	27.6	2.01	35.3	2.59	48.2	3.53	62.2	4.19
	23	15.9	1.63	21.9	2.18	29.0	2.45	36.4	2.72	44.1	3.90	55.3	5.04	68.3	5.94
	25	22.7	2.59	29.5	3.27	37.3	3.66	45.4	4.31	52.9	5.60	62.3	7.33	74.3	8.62
	27	29.5	4.09	37.2	4.87	45.6	5.48	53.9	6.55	61.6	8.31	69.4	10.48	80.3	12.00
	29	36.3	5.68	44.8	6.55	53.8	8.04	62.6	9.47	70.4	11.29	76.5	13.55	86.3	14.73
	31	43.0	7.19	52.4	8.66	62.1	10.67	71.4	12.56	79.2	14.32	83.5	15.67	93.1	16.70
	33	49.8	8.86	60.0	11.31	70.4	13.74	80.1	15.93	88.0	17.40	90.8	17.70	93.1	18.09
	35	56.7	10.67	67.5	13.62	78.6	16.93	84.0	18.74	88.0	18.85	90.8	18.93	93.1	19.08
	37	56.7	11.42	67.5	14.61	78.6	17.93	84.0	19.63	86.6	19.73	89.1	19.81	91.2	19.99
	39	56.7	12.25	67.5	15.69	78.6	19.00	84.0	20.59	85.1	20.68	87.7	20.76	89.7	20.95
	41	55.8	13.07	66.4	16.78	77.4	20.07	80.6	21.55	82.4	21.64	84.3	21.71	87.0	21.92
43	53.9	13.84	64.1	17.78	74.7	21.03	77.3	22.38	78.2	22.46	80.6	22.53	82.7	22.74	
46	50.5	14.88	60.1	19.17	70.0	22.31	70.6	23.43	71.3	23.49	73.6	23.56	75.6	23.79	
48	44.7	12.85	53.2	16.59	60.4	19.07	61.3	19.88	62.0	19.94	64.0	19.99	65.7	20.15	
90	10	8.2	0.80	11.2	0.99	15.0	1.25	20.7	1.43	27.9	1.84	40.2	2.43	53.3	3.18
	12	8.2	0.80	11.2	1.00	15.0	1.26	20.7	1.44	27.9	1.86	40.2	2.46	53.3	3.22
	14	8.2	0.81	11.2	1.01	15.0	1.27	20.7	1.46	27.9	1.88	40.2	2.48	53.3	3.25
	16	8.2	0.82	11.2	1.02	15.0	1.29	20.7	1.47	27.9	1.90	40.2	2.51	53.3	3.28
	18	8.2	0.83	11.2	1.03	15.0	1.30	20.7	1.49	27.9	1.92	40.2	2.53	53.3	3.32
	20	8.2	0.84	11.2	1.05	15.0	1.31	20.7	1.50	27.9	1.94	40.2	2.56	53.3	3.35
	21	8.2	0.85	11.2	1.06	18.8	1.66	24.6	1.78	31.4	2.33	43.4	2.81	56.1	3.69
	23	11.2	1.31	16.5	1.81	26.3	2.35	31.9	2.56	38.5	3.42	49.9	4.17	61.8	5.07
	25	17.8	2.21	23.9	2.91	33.7	3.47	39.1	4.04	45.5	4.99	56.4	6.30	67.5	7.33
	27	24.4	3.25	31.3	4.14	41.1	5.39	46.4	6.01	52.5	7.27	62.8	8.48	73.1	9.59
	29	31.0	4.39	38.7	5.69	48.6	7.51	53.7	8.30	59.5	9.60	69.3	10.89	78.8	12.69
	31	37.7	5.49	46.1	7.31	56.0	9.40	61.0	10.60	66.5	11.96	75.8	12.68	84.5	14.75
	33	44.3	7.07	53.5	9.00	63.5	11.40	68.3	12.57	73.5	13.90	82.3	15.02	90.3	16.47
	35	51.0	8.76	60.9	11.07	70.8	13.69	75.6	15.10	80.4	16.42	88.7	17.61	90.3	18.02
	37	51.0	9.29	60.9	11.78	70.8	14.60	75.6	16.04	80.4	17.33	87.3	18.41	88.8	18.82
	39	51.0	9.84	60.9	12.53	70.8	15.45	75.6	17.07	80.4	18.22	85.9	19.41	87.4	19.64
	41	49.7	11.01	59.3	13.89	69.0	16.96	73.7	18.67	78.3	19.67	82.3	20.46	83.8	20.92
43	48.5	11.89	57.9	15.01	67.3	18.52	71.8	20.10	76.4	21.10	78.9	21.85	80.3	22.17	
46	45.4	13.38	54.2	17.09	63.1	21.10	67.3	22.79	69.4	23.44	72.0	23.56	73.4	23.79	
48	40.2	11.69	48.0	14.95	55.8	18.47	59.6	19.88	60.3	19.94	62.6	19.99	63.8	20.15	
80	10	7.1	0.70	9.6	0.88	12.8	1.10	18.1	1.27	23.9	1.63	34.4	2.15	45.6	2.81
	12	7.1	0.71	9.6	0.89	12.8	1.11	18.1	1.28	23.9	1.65	34.4	2.17	45.6	2.84
	14	7.1	0.72	9.6	0.90	12.8	1.13	18.1	1.30	23.9	1.66	34.4	2.19	45.6	2.87
	16	7.1	0.73	9.6	0.91	12.8	1.14	18.1	1.31	23.9	1.68	34.4	2.22	45.6	2.90
	18	7.1	0.73	9.6	0.91	12.8	1.15	18.1	1.32	23.9	1.70	34.4	2.24	45.6	2.93
	20	7.1	0.74	9.6	0.92	12.8	1.16	18.1	1.34	23.9	1.71	34.4	2.26	45.6	2.96
	21	7.1	0.74	9.6	0.95	16.1	1.46	21.6	1.60	27.0	2.06	37.4	2.49	48.5	3.26
	23	12.5	1.37	16.0	1.63	22.7	2.07	28.6	2.30	33.4	3.02	43.5	3.69	54.1	4.48
	25	18.0	1.99	22.3	2.62	29.4	3.07	35.6	3.64	39.8	4.41	49.6	5.57	59.8	6.48
	27	23.4	2.92	28.6	3.73	36.0	4.77	42.6	5.41	46.2	6.43	55.8	7.50	65.5	8.48
	29	28.9	3.79	35.0	5.12	42.7	6.64	49.6	7.47	52.6	8.49	61.9	9.63	71.2	11.22
	31	34.4	4.65	41.3	6.45	49.3	8.31	56.6	9.54	60.1	10.29	68.0	11.10	76.8	12.91
	33	39.8	6.11	47.6	7.94	55.9	9.77	63.6	11.31	67.3	11.82	74.2	13.15	82.5	14.53
	35	45.3	8.00	54.0	10.02	62.7	12.30	67.2	13.51	71.7	14.79	80.4	16.78	88.2	17.48
	37	45.3	8.46	54.0	10.66	62.7	13.05	67.2	14.36	71.7	15.71	80.4	17.71	86.7	18.36
	39	45.3	8.94	54.0	11.27	62.7	13.96	67.2	15.44	71.7	16.89	80.4	18.71	85.3	19.36
	41	44.1	9.89	52.6	12.49	61.1	15.32	65.5	16.92	69.9	18.55	78.3	20.05	81.7	20.51
43	43.0	10.89	51.3	13.63	59.6	16.72	63.9	18.44	68.1	20.28	76.4	21.42	78.3	21.95	
46	40.3	12.11	48.1	15.35	55.8	18.84	59.8	20.53	63.9	22.88	69.9	23.56	71.5	23.79	
48	35.7	10.58	42.5	13.42	49.4	16.48	52.9	17.93	56.5	19.94	60.7	19.99	62.1	20.15	

# 7. Capacity Tables

Cooling Capacity (30HP)

Combination (%)	Outdoor air temp. (DB, °C)	Indoor air temp. (DB/WB, °C)													
		20		23		26		27		28		30		32	
		14		16		18		19		20		22		24	
		TC	PI	TC	PI	TC	PI	TC	PI	TC	PI	TC	PI	TC	PI
70	10	6.1	0.62	8.4	0.78	11.2	0.98	15.8	1.13	20.8	1.44	29.9	1.90	39.7	2.49
	12	6.1	0.63	8.4	0.78	11.2	0.99	15.8	1.14	20.8	1.46	29.9	1.92	39.7	2.51
	14	6.1	0.63	8.4	0.79	11.2	1.00	15.8	1.15	20.8	1.47	29.9	1.94	39.7	2.54
	16	6.1	0.64	8.4	0.80	11.2	1.01	15.8	1.17	20.8	1.49	29.9	1.96	39.7	2.57
	18	6.1	0.65	8.4	0.81	11.2	1.02	15.8	1.18	20.8	1.50	29.9	1.98	39.7	2.59
	20	6.1	0.65	8.4	0.82	11.2	1.03	15.8	1.19	20.8	1.52	29.9	2.00	39.7	2.62
	21	6.1	0.66	9.8	0.96	14.5	1.35	19.5	1.49	24.0	1.82	33.0	2.20	42.7	2.88
	23	8.8	0.99	15.1	1.57	20.3	1.97	26.3	2.14	30.5	2.67	39.2	3.26	48.6	3.96
	25	13.9	1.63	20.5	2.32	26.0	2.71	33.0	3.38	36.9	3.90	45.4	4.92	54.5	5.73
	27	19.1	2.38	25.8	3.30	31.8	4.00	39.8	5.03	43.4	5.68	51.6	6.63	60.4	7.49
	29	24.2	3.02	31.2	4.36	37.5	5.44	46.5	6.84	49.8	7.50	57.8	8.51	66.3	9.92
	31	29.4	3.71	36.6	5.42	43.3	6.82	53.3	8.59	56.3	9.09	64.0	9.81	72.2	11.41
	33	34.5	4.99	41.9	6.59	49.1	7.92	58.8	9.97	62.7	10.45	70.2	11.62	78.0	12.84
	35	39.6	6.83	47.4	8.52	54.9	10.30	58.8	11.27	62.7	12.31	70.2	14.49	78.0	15.89
	37	39.6	7.26	47.4	9.02	54.9	10.95	58.8	11.98	62.7	13.09	70.2	15.42	78.0	16.77
	39	39.6	7.71	47.4	9.62	54.9	11.71	58.8	12.89	62.7	14.14	70.2	16.50	78.0	18.07
41	38.6	8.53	46.2	10.53	53.5	12.84	57.3	14.14	61.1	15.38	68.4	18.12	76.0	19.48	
43	37.6	9.28	45.0	11.48	52.2	14.01	55.9	15.42	59.6	16.79	66.7	19.80	74.1	21.07	
46	35.3	10.31	42.2	12.91	48.9	15.78	52.4	17.18	55.8	18.93	62.5	22.33	69.5	23.50	
48	31.2	9.00	37.3	11.28	43.3	13.79	46.3	15.01	49.4	16.56	55.3	19.54	61.5	20.15	
60	10	5.4	0.57	7.2	0.71	9.7	0.89	13.6	1.03	18.0	1.31	25.9	1.73	34.3	2.26
	12	5.4	0.57	7.2	0.71	9.7	0.90	13.6	1.05	18.0	1.32	25.9	1.75	34.3	2.29
	14	5.4	0.58	7.2	0.72	9.7	0.91	13.6	1.06	18.0	1.34	25.9	1.76	34.3	2.31
	16	5.4	0.58	7.2	0.73	9.7	0.92	13.6	1.07	18.0	1.35	25.9	1.78	34.3	2.33
	18	5.4	0.59	7.2	0.74	9.7	0.92	13.6	1.08	18.0	1.37	25.9	1.80	34.3	2.36
	20	5.4	0.60	7.2	0.74	9.7	0.93	13.6	1.09	18.0	1.38	25.9	1.82	34.3	2.38
	21	5.4	0.60	7.2	0.77	12.1	1.20	16.0	1.32	20.6	1.66	28.1	2.00	36.5	2.62
	23	5.4	0.66	12.0	1.40	17.1	1.79	22.2	1.92	26.0	2.43	32.7	2.96	40.9	3.61
	25	10.1	1.26	16.8	2.11	22.1	2.47	28.6	3.27	31.3	3.55	38.0	4.39	45.2	5.21
	27	14.8	1.84	21.5	3.00	27.1	3.64	34.5	4.55	36.7	5.09	42.7	5.82	49.5	6.71
	29	19.6	2.38	26.3	3.84	32.1	4.86	40.7	5.98	42.1	6.49	47.4	7.30	53.9	8.58
	31	24.3	3.03	31.0	4.60	37.0	5.91	45.7	7.18	47.4	7.54	53.1	8.08	58.2	9.88
	33	29.1	4.22	35.8	5.59	42.0	6.64	49.3	8.05	52.8	8.62	57.3	9.57	62.5	11.26
	35	33.9	5.80	40.5	7.09	47.1	8.50	50.4	9.25	53.7	10.04	60.3	11.74	66.9	13.54
	37	33.9	6.12	40.5	7.48	47.1	9.00	50.4	9.83	53.7	10.66	60.3	12.46	66.9	14.40
	39	33.9	6.51	40.5	7.97	47.1	9.71	50.4	10.54	53.7	11.47	60.3	13.36	66.9	15.43
41	33.0	7.06	39.5	8.72	45.9	10.55	49.1	11.52	52.3	12.45	58.8	14.66	65.2	16.77	
43	32.2	7.67	38.5	9.49	44.8	11.50	47.9	12.55	51.0	13.57	57.3	16.00	63.6	18.32	
46	30.2	8.59	36.1	10.66	41.9	12.94	44.9	14.11	47.8	15.27	53.7	18.03	59.6	20.87	
48	26.7	7.49	31.9	9.30	37.1	11.30	39.7	12.32	42.3	13.35	47.5	15.77	52.7	18.26	
50	10	4.9	0.52	6.6	0.64	9.3	0.81	12.5	0.99	16.4	1.19	23.7	1.57	31.4	2.05
	12	4.9	0.52	6.6	0.65	9.3	0.82	12.5	1.00	16.4	1.21	23.7	1.59	31.4	2.07
	14	4.9	0.53	6.6	0.66	9.3	0.83	12.5	1.01	16.4	1.22	23.7	1.61	31.4	2.09
	16	4.9	0.53	6.6	0.66	9.3	0.83	12.5	1.02	16.4	1.23	23.7	1.62	31.4	2.12
	18	4.9	0.54	6.6	0.67	9.3	0.84	12.5	1.03	16.4	1.24	23.7	1.64	31.4	2.14
	20	4.9	0.54	6.6	0.68	9.3	0.85	12.5	1.04	16.4	1.26	23.7	1.66	31.4	2.16
	21	4.9	0.55	6.6	0.70	11.6	1.09	14.7	1.25	18.7	1.51	25.7	1.82	33.1	2.38
	23	4.9	0.58	10.5	1.19	16.1	1.63	20.8	1.95	23.6	2.22	29.6	2.70	36.5	3.27
	25	8.7	1.06	14.4	1.76	20.6	2.29	27.5	3.17	29.1	3.23	33.5	3.80	39.9	4.62
	27	12.6	1.51	18.3	2.47	25.5	3.19	31.8	4.22	33.8	4.35	37.4	4.97	43.4	5.87
	29	16.5	1.99	22.2	3.19	29.6	4.10	35.8	5.24	38.5	5.61	41.3	6.16	46.8	7.42
	31	20.5	2.53	26.1	3.79	33.6	4.99	39.0	6.14	41.2	6.21	45.1	6.66	50.2	8.16
	33	24.4	3.52	30.0	4.56	37.7	5.61	40.5	6.40	43.0	6.86	48.8	7.89	53.6	9.16
	35	28.4	4.82	33.9	5.80	39.3	6.85	42.0	7.43	44.7	8.01	50.1	9.24	55.8	10.61
	37	28.4	5.11	33.9	6.12	39.3	7.25	42.0	7.86	44.7	8.48	50.1	9.85	55.8	11.27
	39	28.4	5.45	33.9	6.56	39.3	7.76	42.0	8.46	44.7	9.10	50.1	10.50	55.8	12.17
41	27.6	5.89	33.0	7.10	38.3	8.49	40.9	9.17	43.6	9.86	48.8	11.51	54.4	13.22	
43	26.9	6.40	32.2	7.73	37.3	9.24	39.9	9.98	42.5	10.73	47.6	12.55	53.0	14.42	
46	25.2	7.17	30.2	8.67	35.0	10.36	37.4	11.21	39.8	12.05	44.6	14.12	49.7	16.23	
48	22.3	6.25	26.7	7.56	31.0	9.04	33.1	9.78	35.2	10.51	39.5	12.34	44.0	14.19	

**Note**

1. TC: Total Capacity(kW), PI : Power Input(kW, Comp. + Outdoor fan motor)
2. Capacity tables show the average value of conditions which may occur.



# 7. Capacity Tables

◆ ARUM320LTE5

Cooling Capacity (32HP)

Combination (%)	Outdoor air temp. (DB, °C)	Indoor air temp. (DB/WB, °C)													
		20		23		26		27		28		30		32	
		14	PI	16	PI	18	PI	19	PI	20	PI	22	PI	24	PI
130	10	12.6	1.17	17.2	1.46	22.9	1.78	32.4	2.17	42.7	2.71	61.4	3.62	81.4	4.79
	12	12.6	1.18	17.2	1.48	22.9	1.80	32.4	2.19	42.7	2.74	61.4	3.66	81.4	4.84
	14	12.6	1.20	17.2	1.49	22.9	1.82	32.4	2.22	42.7	2.77	61.4	3.69	81.4	4.89
	16	12.6	1.21	17.2	1.51	22.9	1.84	32.4	2.24	42.7	2.80	61.4	3.73	81.4	4.94
	18	12.6	1.22	17.2	1.52	22.9	1.85	32.4	2.26	42.7	2.83	61.4	3.77	81.4	4.99
	20	12.6	1.23	17.2	1.54	22.9	1.87	32.4	2.28	42.7	2.86	61.4	3.81	81.4	5.04
	21	12.6	1.24	17.5	1.59	28.4	2.34	37.7	2.72	47.7	3.51	65.4	4.79	84.0	5.67
	23	21.9	2.21	30.5	2.91	39.5	3.31	49.3	3.68	57.7	5.28	73.5	6.83	89.3	8.04
	25	32.4	3.50	39.2	4.36	50.5	4.95	61.4	5.84	67.8	7.59	81.6	9.92	94.5	11.68
	27	42.3	5.58	50.2	6.59	61.6	7.48	73.0	8.94	77.9	11.35	89.7	14.31	99.7	16.13
	29	52.2	7.75	61.1	9.09	72.7	10.98	84.9	12.93	87.9	15.42	97.9	18.50	105.0	20.59
	31	63.3	10.13	73.4	12.49	85.4	15.15	95.6	17.69	98.0	20.18	103.4	25.35	110.4	25.71
	33	74.5	12.48	87.0	16.30	97.7	19.50	103.3	25.32	105.5	25.15	108.8	25.37	116.1	25.73
	35	88.7	16.86	101.7	20.43	105.0	24.79	106.8	24.92	108.5	25.07	111.5	25.29	114.7	25.39
	37	88.7	17.98	100.3	21.44	103.5	24.47	105.0	24.59	106.8	24.74	109.7	24.96	112.9	25.06
	39	88.7	19.14	98.5	22.57	101.7	24.14	103.5	24.26	105.0	24.41	108.2	24.62	111.5	24.72
41	86.5	20.31	94.4	23.70	97.6	23.81	99.1	23.93	101.0	24.07	104.0	24.29	106.8	24.39	
43	84.3	21.42	90.5	23.37	93.6	23.48	95.0	23.60	96.9	23.74	99.9	23.96	102.6	24.05	
46	79.0	22.92	82.5	22.88	85.5	22.99	86.9	23.11	88.7	23.25	91.5	23.46	94.0	23.55	
48	69.9	22.29	71.7	22.35	74.4	22.40	75.5	22.46	77.2	22.65	79.6	22.80	81.8	22.89	
120	10	11.6	1.10	15.9	1.37	21.2	1.66	29.9	2.03	39.3	2.54	56.6	3.38	75.1	4.48
	12	11.6	1.11	15.9	1.38	21.2	1.68	29.9	2.05	39.3	2.56	56.6	3.42	75.1	4.53
	14	11.6	1.12	15.9	1.40	21.2	1.70	29.9	2.07	39.3	2.59	56.6	3.46	75.1	4.58
	16	11.6	1.13	15.9	1.41	21.2	1.72	29.9	2.09	39.3	2.62	56.6	3.49	75.1	4.62
	18	11.6	1.14	15.9	1.43	21.2	1.73	29.9	2.12	39.3	2.64	56.6	3.53	75.1	4.67
	20	11.6	1.15	15.9	1.44	21.2	1.75	29.9	2.14	39.3	2.67	56.6	3.56	75.1	4.72
	21	11.6	1.16	16.1	1.48	26.8	2.23	34.8	2.54	44.5	3.28	60.6	4.48	77.9	5.31
	23	20.2	2.07	29.0	2.76	38.1	3.18	45.4	3.45	55.0	4.94	69.0	6.39	83.2	7.52
	25	31.4	3.28	40.6	4.14	49.9	4.63	56.6	5.46	66.0	7.10	77.8	9.28	88.6	10.92
	27	43.7	5.18	55.3	6.17	61.9	6.94	67.2	8.30	76.9	10.53	86.6	13.28	94.0	15.21
	29	56.1	7.19	66.5	8.30	73.7	10.19	78.2	12.00	87.9	14.31	95.4	17.17	99.5	19.31
	31	67.9	9.10	80.1	10.98	85.7	13.52	90.0	15.91	99.2	18.14	101.9	21.82	105.3	22.23
	33	78.7	11.22	94.5	14.33	100.2	17.40	101.5	20.19	103.3	23.75	106.1	24.02	109.4	24.21
	35	80.3	14.99	95.5	19.42	101.2	21.48	102.6	25.59	104.3	25.72	107.2	25.79	110.0	26.00
	37	80.3	16.13	95.5	20.49	99.7	22.90	101.2	25.05	102.6	25.17	105.4	25.25	108.2	25.45
	39	80.3	17.36	95.1	21.66	98.0	24.29	99.4	24.53	100.8	24.66	104.0	24.73	106.8	24.93
41	78.3	18.60	91.0	22.83	94.1	23.81	95.4	24.02	96.8	24.14	99.6	24.21	102.4	24.40	
43	76.3	19.85	87.2	22.50	90.2	23.28	91.5	23.51	92.9	23.62	95.6	23.69	98.4	23.88	
46	71.5	21.34	79.5	21.96	82.4	22.55	83.6	22.73	84.9	22.85	87.4	22.92	90.0	23.10	
48	63.3	20.91	69.0	21.57	71.6	22.11	72.7	22.24	73.8	22.31	76.1	22.40	78.4	22.49	
110	10	10.7	1.03	14.5	1.29	19.4	1.56	27.3	1.91	36.0	2.38	51.9	3.18	68.8	4.21
	12	10.7	1.04	14.5	1.30	19.4	1.58	27.3	1.93	36.0	2.41	51.9	3.21	68.8	4.26
	14	10.7	1.05	14.5	1.31	19.4	1.60	27.3	1.95	36.0	2.43	51.9	3.25	68.8	4.30
	16	10.7	1.06	14.5	1.33	19.4	1.61	27.3	1.97	36.0	2.46	51.9	3.28	68.8	4.34
	18	10.7	1.07	14.5	1.34	19.4	1.63	27.3	1.99	36.0	2.49	51.9	3.31	68.8	4.39
	20	10.7	1.08	14.5	1.35	19.4	1.65	27.3	2.01	36.0	2.51	51.9	3.35	68.8	4.43
	21	10.7	1.09	14.5	1.39	24.3	2.06	32.1	2.39	40.1	3.08	56.0	4.21	72.3	4.99
	23	19.1	1.94	24.3	2.60	34.0	2.91	41.9	3.24	50.8	4.64	63.7	6.00	78.6	7.07
	25	27.5	3.08	34.0	3.89	43.7	4.35	51.8	5.13	60.3	6.67	71.1	8.72	84.8	10.26
	27	35.8	4.87	43.7	5.79	53.5	6.52	61.5	7.80	70.4	9.90	79.2	12.48	91.7	14.29
	29	44.2	6.76	53.5	7.80	63.2	9.58	71.5	11.28	80.4	13.44	87.3	15.81	96.7	17.54
	31	53.7	8.56	64.5	10.31	74.4	12.71	81.5	14.95	90.4	17.05	95.4	18.28	100.3	19.68
	33	62.2	10.54	74.4	13.46	84.3	16.35	91.9	18.27	97.7	20.51	100.7	21.07	103.3	21.10
	35	71.9	13.28	85.8	17.09	95.8	19.49	98.5	20.88	100.0	22.16	102.4	22.36	105.1	22.47
	37	71.9	14.08	85.8	18.14	95.8	20.57	97.2	22.12	98.2	23.37	101.0	23.45	103.4	23.52
	39	71.9	15.18	85.8	19.28	94.1	21.70	95.4	23.66	96.8	24.53	99.2	24.57	102.0	24.59
41	70.1	16.28	83.6	20.41	90.0	22.89	91.4	25.59	92.6	25.59	95.3	25.79	97.7	26.00	
43	68.4	17.09	81.5	21.27	86.3	24.27	87.7	24.54	88.8	24.49	91.5	24.63	93.8	24.70	
46	64.1	16.68	76.4	20.53	78.7	23.03	80.1	23.03	81.1	23.23	83.6	23.36	85.8	23.42	
48	56.7	16.20	66.4	19.78	68.4	21.92	69.6	22.06	70.5	22.17	72.7	22.23	74.6	22.32	

# 7. Capacity Tables

Cooling Capacity (32HP)

Combination (%)	Outdoor air temp. (DB, °C)	Indoor air temp. (DB/WB, °C)													
		20		23		26		27		28		30		32	
		14	16	18	19	20	22	24	TC	PI	TC	PI	TC	PI	
100	10	9.8	0.94	13.3	1.18	17.8	1.43	25.1	1.75	33.1	2.19	47.6	2.92	63.1	3.86
	12	9.8	0.95	13.3	1.19	17.8	1.45	25.1	1.77	33.1	2.21	47.6	2.95	63.1	3.90
	14	9.8	0.96	13.3	1.20	17.8	1.47	25.1	1.79	33.1	2.23	47.6	2.98	63.1	3.94
	16	9.8	0.97	13.3	1.22	17.8	1.48	25.1	1.81	33.1	2.26	47.6	3.01	63.1	3.98
	18	9.8	0.98	13.3	1.23	17.8	1.50	25.1	1.82	33.1	2.28	47.6	3.04	63.1	4.03
	20	9.8	0.99	13.3	1.24	17.8	1.51	25.1	1.84	33.1	2.30	47.6	3.07	63.1	4.07
	21	9.8	1.00	13.3	1.28	22.1	1.89	29.5	2.19	37.7	2.83	51.4	3.86	66.4	4.58
	23	17.0	1.78	23.4	2.38	31.0	2.67	38.8	2.97	47.0	4.26	58.9	5.51	72.8	6.49
	25	24.2	2.82	31.5	3.57	39.8	3.99	48.4	4.71	56.4	6.12	66.5	8.00	79.2	9.42
	27	31.4	4.47	39.6	5.31	48.6	5.98	57.5	7.15	65.7	9.08	74.0	11.45	85.7	13.11
	29	38.7	6.20	47.8	7.16	57.4	8.79	66.8	10.35	75.1	12.33	81.6	14.80	92.1	16.09
	31	45.9	7.85	55.9	9.46	66.2	11.66	76.2	13.71	84.5	15.64	89.1	17.12	99.3	18.24
	33	53.2	9.67	64.0	12.35	75.0	15.00	85.5	17.40	93.9	19.00	96.8	19.33	99.3	19.76
	35	60.5	11.65	72.0	14.88	83.8	18.49	89.6	20.47	93.9	20.59	96.8	20.67	99.3	20.84
	37	60.5	12.48	72.0	15.96	83.8	19.59	89.6	21.44	92.4	21.55	95.0	21.64	97.3	21.84
	39	60.5	13.38	72.0	17.14	83.8	20.75	89.6	22.49	90.8	22.59	93.5	22.68	95.7	22.89
	41	59.5	14.28	70.9	18.32	82.5	21.92	86.0	23.54	87.9	23.63	89.9	23.72	92.8	23.94
	43	57.5	15.11	68.4	19.43	79.7	22.97	82.4	24.44	83.4	24.53	86.0	24.61	88.2	24.84
46	53.9	16.26	64.1	20.94	74.7	24.36	75.3	25.59	76.1	25.66	78.5	25.74	80.6	25.98	
48	47.6	14.04	56.7	18.12	64.5	20.83	65.4	21.71	66.1	21.78	68.3	21.83	70.1	22.00	
90	10	8.8	0.87	12.0	1.08	16.0	1.36	22.1	1.56	29.8	2.01	42.8	2.65	56.8	3.48
	12	8.8	0.88	12.0	1.10	16.0	1.38	22.1	1.57	29.8	2.03	42.8	2.68	56.8	3.51
	14	8.8	0.89	12.0	1.11	16.0	1.39	22.1	1.59	29.8	2.06	42.8	2.71	56.8	3.55
	16	8.8	0.90	12.0	1.12	16.0	1.41	22.1	1.61	29.8	2.08	42.8	2.74	56.8	3.59
	18	8.8	0.91	12.0	1.13	16.0	1.42	22.1	1.62	29.8	2.10	42.8	2.77	56.8	3.62
	20	8.8	0.91	12.0	1.14	16.0	1.43	22.1	1.64	29.8	2.12	42.8	2.79	56.8	3.66
	21	8.8	0.92	12.0	1.15	20.1	1.81	26.2	1.94	33.5	2.54	46.3	3.07	59.8	4.03
	23	11.9	1.43	17.7	1.98	28.0	2.56	34.0	2.79	41.0	3.74	53.2	4.55	65.9	5.54
	25	19.0	2.42	25.5	3.18	35.9	3.79	41.8	4.41	48.5	5.45	60.1	6.88	71.9	8.00
	27	26.1	3.55	33.4	4.53	43.9	5.89	49.5	6.56	56.0	7.94	67.0	9.26	78.0	10.47
	29	33.1	4.79	41.3	6.22	51.8	8.20	57.3	9.07	63.4	10.49	74.0	11.90	84.1	13.86
	31	40.2	6.00	49.2	7.99	59.8	10.27	65.1	11.57	70.9	13.06	80.9	13.85	90.2	16.11
	33	47.2	7.73	57.1	9.83	67.7	12.45	72.9	13.73	78.4	15.19	87.8	16.41	96.3	17.99
	35	54.4	9.57	65.0	12.10	75.5	14.95	80.6	16.49	85.8	17.93	94.7	19.24	96.3	19.68
	37	54.4	10.15	65.0	12.87	75.5	15.95	80.6	17.52	85.8	18.93	93.1	20.11	94.8	20.56
	39	54.4	10.75	65.0	13.68	75.5	16.88	80.6	18.65	85.8	19.91	91.6	21.20	93.2	21.46
	41	53.0	12.03	63.3	15.17	73.6	18.52	78.6	20.39	83.6	21.49	87.8	22.34	89.4	22.86
	43	51.7	12.98	61.7	16.39	71.8	20.23	76.6	21.96	81.5	23.04	84.2	23.87	85.7	24.22
46	48.4	14.61	57.9	18.67	67.3	23.05	71.8	24.90	74.1	25.60	76.8	25.74	78.3	25.98	
48	42.9	12.77	51.2	16.33	59.5	20.17	63.5	21.71	64.3	21.78	66.8	21.83	68.0	22.00	
80	10	7.5	0.77	10.3	0.96	13.7	1.20	19.3	1.39	25.5	1.78	36.7	2.35	48.6	3.07
	12	7.5	0.78	10.3	0.97	13.7	1.22	19.3	1.40	25.5	1.80	36.7	2.37	48.6	3.11
	14	7.5	0.78	10.3	0.98	13.7	1.23	19.3	1.42	25.5	1.82	36.7	2.40	48.6	3.14
	16	7.5	0.79	10.3	0.99	13.7	1.24	19.3	1.43	25.5	1.84	36.7	2.42	48.6	3.17
	18	7.5	0.80	10.3	1.00	13.7	1.26	19.3	1.44	25.5	1.85	36.7	2.45	48.6	3.20
	20	7.5	0.81	10.3	1.01	13.7	1.27	19.3	1.46	25.5	1.87	36.7	2.47	48.6	3.24
	21	7.5	0.81	10.3	1.04	17.2	1.60	23.1	1.75	28.9	2.25	39.9	2.72	51.7	3.56
	23	13.4	1.50	17.0	1.78	24.3	2.27	30.5	2.51	35.7	3.30	46.4	4.03	57.7	4.90
	25	19.2	2.17	23.8	2.86	31.3	3.35	38.0	3.97	42.5	4.82	52.9	6.08	63.8	7.08
	27	25.0	3.19	30.5	4.07	38.4	5.21	45.4	5.90	49.3	7.02	59.5	8.19	69.9	9.26
	29	30.8	4.14	37.3	5.60	45.5	7.25	52.9	8.16	56.1	9.27	66.0	10.52	75.9	12.26
	31	36.6	5.08	44.1	7.04	52.6	9.08	60.3	10.42	64.2	11.23	72.6	12.12	82.0	14.10
	33	42.5	6.68	50.8	8.67	59.7	10.67	67.8	12.35	71.8	12.91	79.1	14.36	88.0	15.87
	35	48.3	8.74	57.6	10.95	66.9	13.44	71.7	14.76	76.5	16.15	85.8	18.33	94.0	19.09
	37	48.3	9.24	57.6	11.64	66.9	14.25	71.7	15.69	76.5	17.16	85.8	19.34	92.5	20.05
	39	48.3	9.77	57.6	12.31	66.9	15.24	71.7	16.87	76.5	18.44	85.8	20.43	91.0	21.15
	41	47.1	10.80	56.1	13.64	65.2	16.73	69.8	18.49	74.5	20.27	83.6	21.90	87.2	22.40
	43	45.9	11.89	54.7	14.88	63.6	18.26	68.1	20.15	72.7	22.15	81.5	23.39	83.6	23.97
46	43.0	13.23	51.3	16.77	59.6	20.58	63.8	22.42	68.1	24.99	74.5	25.74	76.3	25.98	
48	38.1	11.56	45.4	14.66	52.7	18.00	56.5	19.59	60.3	21.78	64.7	21.83	66.3	22.00	

# 7. Capacity Tables

Cooling Capacity (32HP)

Combination (%)	Outdoor air temp. (DB, °C)	Indoor air temp. (DB/WB, °C)													
		20		23		26		27		28		30		32	
		14	16	18	19	20	22	24	TC	PI	TC	PI	TC	PI	
70	10	6.6	0.68	8.9	0.85	11.9	1.07	16.8	1.23	22.2	1.57	31.9	2.07	42.3	2.72
	12	6.6	0.69	8.9	0.86	11.9	1.08	16.8	1.25	22.2	1.59	31.9	2.10	42.3	2.75
	14	6.6	0.69	8.9	0.87	11.9	1.09	16.8	1.26	22.2	1.61	31.9	2.12	42.3	2.77
	16	6.6	0.70	8.9	0.87	11.9	1.10	16.8	1.27	22.2	1.62	31.9	2.14	42.3	2.80
	18	6.6	0.71	8.9	0.88	11.9	1.11	16.8	1.29	22.2	1.64	31.9	2.16	42.3	2.83
	20	6.6	0.71	8.9	0.89	11.9	1.12	16.8	1.30	22.2	1.66	31.9	2.18	42.3	2.86
	21	6.6	0.72	10.4	1.05	15.5	1.47	20.8	1.63	25.6	1.99	35.2	2.40	45.5	3.15
	23	9.4	1.08	16.1	1.71	21.6	2.15	28.0	2.34	32.5	2.92	41.8	3.56	51.8	4.33
	25	14.9	1.78	21.8	2.53	27.8	2.96	35.2	3.69	39.4	4.26	48.4	5.38	58.1	6.25
	27	20.4	2.60	27.6	3.60	33.9	4.37	42.4	5.49	46.2	6.21	55.0	7.24	64.4	8.18
	29	25.8	3.30	33.3	4.76	40.1	5.95	49.6	7.47	53.1	8.19	61.6	9.30	70.8	10.83
	31	31.3	4.05	39.0	5.92	46.2	7.45	56.8	9.38	60.0	9.93	68.2	10.71	77.1	12.46
	33	36.8	5.45	44.7	7.19	52.3	8.65	62.7	10.90	66.9	11.41	74.9	12.70	83.2	14.03
	35	42.2	7.46	50.6	9.30	58.6	11.25	62.7	12.31	66.9	13.44	74.9	15.83	83.2	17.35
	37	42.2	7.93	50.6	9.85	58.6	11.96	62.7	13.09	66.9	14.30	74.9	16.84	83.2	18.31
	39	42.2	8.42	50.6	10.50	58.6	12.79	62.7	14.08	66.9	15.45	74.9	18.03	83.2	19.74
41	41.2	9.31	49.3	11.51	57.1	14.02	61.1	15.45	65.2	16.80	73.0	19.80	81.1	21.28	
43	40.1	10.14	48.0	12.54	55.7	15.30	59.6	16.85	63.6	18.34	71.2	21.63	79.1	23.02	
46	37.6	11.27	45.0	14.10	52.2	17.23	55.9	18.76	59.6	20.68	66.7	24.39	74.1	25.67	
48	33.3	9.83	39.8	12.32	46.1	15.07	49.4	16.40	52.7	18.09	59.0	21.35	65.5	22.00	
60	10	5.8	0.62	7.7	0.77	10.3	0.97	14.6	1.13	19.2	1.43	27.6	1.89	36.6	2.48
	12	5.8	0.63	7.7	0.78	10.3	0.98	14.6	1.14	19.2	1.45	27.6	1.91	36.6	2.50
	14	5.8	0.63	7.7	0.79	10.3	0.99	14.6	1.16	19.2	1.46	27.6	1.93	36.6	2.53
	16	5.8	0.64	7.7	0.80	10.3	1.00	14.6	1.17	19.2	1.48	27.6	1.95	36.6	2.55
	18	5.8	0.64	7.7	0.81	10.3	1.01	14.6	1.18	19.2	1.49	27.6	1.97	36.6	2.58
	20	5.8	0.65	7.7	0.81	10.3	1.02	14.6	1.19	19.2	1.51	27.6	1.99	36.6	2.61
	21	5.8	0.66	7.7	0.84	12.9	1.31	17.1	1.45	22.0	1.81	30.0	2.19	39.0	2.87
	23	5.8	0.72	12.8	1.53	18.2	1.96	23.7	2.10	27.7	2.66	34.9	3.24	43.6	3.94
	25	10.7	1.38	17.9	2.31	23.5	2.70	30.5	3.58	33.4	3.88	40.6	4.81	48.2	5.70
	27	15.8	2.01	22.9	3.28	28.9	3.99	36.8	4.98	39.1	5.57	45.5	6.37	52.8	7.34
	29	20.9	2.61	28.0	4.21	34.2	5.31	43.4	6.55	44.9	7.10	50.5	7.98	57.5	9.38
	31	25.9	3.32	33.1	5.03	39.5	6.47	48.7	7.86	50.6	8.25	56.6	8.84	62.1	10.81
	33	31.0	4.62	38.2	6.12	44.8	7.26	52.6	8.81	56.3	9.44	61.1	10.47	66.7	12.32
	35	36.2	6.33	43.2	7.75	50.2	9.28	53.8	10.11	57.3	10.97	64.3	12.82	71.4	14.79
	37	36.2	6.69	43.2	8.18	50.2	9.83	53.8	10.74	57.3	11.64	64.3	13.61	71.4	15.73
	39	36.2	7.11	43.2	8.71	50.2	10.61	53.8	11.52	57.3	12.53	64.3	14.59	71.4	16.86
41	35.2	7.71	42.1	9.53	49.0	11.52	52.4	12.58	55.8	13.60	62.7	16.01	69.5	18.32	
43	34.4	8.38	41.1	10.37	47.7	12.56	51.1	13.71	54.4	14.83	61.1	17.48	67.8	20.01	
46	32.2	9.38	38.5	11.65	44.7	14.13	47.9	15.41	51.0	16.69	57.3	19.69	63.6	22.79	
48	28.5	8.18	34.0	10.16	39.6	12.34	42.4	13.46	45.1	14.58	50.7	17.22	56.2	19.94	
50	10	5.2	0.56	7.1	0.70	10.0	0.89	13.3	1.09	17.5	1.31	25.2	1.72	33.5	2.25
	12	5.2	0.57	7.1	0.71	10.0	0.89	13.3	1.10	17.5	1.32	25.2	1.74	33.5	2.27
	14	5.2	0.58	7.1	0.72	10.0	0.90	13.3	1.11	17.5	1.34	25.2	1.76	33.5	2.30
	16	5.2	0.58	7.1	0.73	10.0	0.91	13.3	1.12	17.5	1.35	25.2	1.78	33.5	2.32
	18	5.2	0.59	7.1	0.73	10.0	0.92	13.3	1.13	17.5	1.36	25.2	1.80	33.5	2.34
	20	5.2	0.59	7.1	0.74	10.0	0.93	13.3	1.14	17.5	1.38	25.2	1.82	33.5	2.37
	21	5.2	0.60	7.1	0.77	12.4	1.20	15.7	1.37	19.9	1.65	27.4	2.00	35.3	2.60
	23	5.2	0.64	11.2	1.31	17.2	1.79	22.1	2.14	25.2	2.43	31.5	2.96	38.9	3.58
	25	9.3	1.16	15.4	1.93	22.0	2.51	29.3	3.47	31.0	3.54	35.7	4.16	42.6	5.06
	27	13.5	1.66	19.5	2.71	27.2	3.50	34.0	4.63	36.1	4.77	39.9	5.45	46.2	6.44
	29	17.7	2.18	23.7	3.49	31.5	4.49	38.2	5.74	41.1	6.15	44.0	6.76	49.9	8.13
	31	21.8	2.77	27.8	4.15	35.9	5.47	41.6	6.40	44.0	6.81	48.1	7.30	53.6	8.95
	33	26.0	3.86	32.0	5.00	40.2	6.15	43.2	7.02	45.8	7.52	52.0	8.64	57.1	10.04
	35	30.2	5.26	36.2	6.33	41.9	7.48	44.8	8.11	47.7	8.75	53.4	10.09	59.5	11.59
	37	30.2	5.58	36.2	6.69	41.9	7.91	44.8	8.59	47.7	9.26	53.4	10.76	59.5	12.31
	39	30.2	5.95	36.2	7.17	41.9	8.48	44.8	9.24	47.7	9.94	53.4	11.46	59.5	13.29
41	29.5	6.44	35.2	7.76	40.8	9.27	43.7	10.01	46.5	10.77	52.1	12.57	58.0	14.44	
43	28.7	6.99	34.4	8.44	39.8	10.09	42.6	10.90	45.3	11.72	50.8	13.70	56.6	15.75	
46	26.9	7.83	32.2	9.47	37.3	11.32	39.9	12.24	42.5	13.16	47.6	15.42	53.0	17.73	
48	23.8	6.83	28.5	8.26	33.0	9.87	35.3	10.68	37.6	11.48	42.1	13.47	46.9	15.50	

**Note**

1. TC: Total Capacity(kW), PI : Power Input(kW, Comp. + Outdoor fan motor)
2. Capacity tables show the average value of conditions which may occur.

# 7. Capacity Tables

◆ ARUM340LTE5

Cooling Capacity (34HP)

Combination (%)	Outdoor air temp. (DB, °C)	Indoor air temp. (DB/WB, °C)													
		20		23		26		27		28		30		32	
		14	PI	16	PI	18	PI	19	PI	20	PI	22	PI	24	PI
130	10	13.4	1.35	18.3	1.69	24.4	2.05	34.4	2.51	45.3	3.13	65.2	4.18	86.5	5.53
	12	13.4	1.37	18.3	1.71	24.4	2.08	34.4	2.53	45.3	3.16	65.2	4.22	86.5	5.59
	14	13.4	1.38	18.3	1.72	24.4	2.10	34.4	2.56	45.3	3.20	65.2	4.26	86.5	5.65
	16	13.4	1.39	18.3	1.74	24.4	2.12	34.4	2.58	45.3	3.23	65.2	4.31	86.5	5.70
	18	13.4	1.41	18.3	1.76	24.4	2.14	34.4	2.61	45.3	3.26	65.2	4.35	86.5	5.76
	20	13.4	1.42	18.3	1.78	24.4	2.16	34.4	2.64	45.3	3.30	65.2	4.40	86.5	5.82
	21	13.4	1.44	18.6	1.83	30.2	2.70	40.1	3.14	50.7	4.05	69.5	5.53	89.3	6.55
	23	23.3	2.55	32.4	3.35	41.9	3.82	52.4	4.25	61.4	6.10	78.1	7.88	94.8	9.29
	25	34.4	4.04	41.7	5.03	53.7	5.72	65.3	6.74	72.0	8.76	86.7	11.46	100.4	13.48
	27	44.9	6.44	53.3	7.61	65.5	8.63	77.6	10.32	82.7	13.10	95.3	16.52	106.0	18.62
	29	55.4	8.95	64.9	10.49	77.2	12.68	90.2	14.93	93.4	17.80	104.0	21.36	111.6	23.77
	31	67.3	11.69	78.0	14.42	90.8	17.49	101.5	20.42	104.1	23.29	109.8	29.26	117.3	29.67
	33	79.1	14.41	92.5	18.82	103.8	22.52	109.7	29.23	112.1	29.03	115.6	29.29	123.4	29.70
	35	94.3	19.46	108.1	23.59	111.5	28.62	113.4	28.77	115.3	28.94	118.4	29.20	121.9	29.31
	37	94.3	20.75	106.5	24.75	110.0	28.24	111.5	28.39	113.4	28.56	116.5	28.81	120.0	28.92
	39	94.3	22.10	104.7	26.06	108.1	27.87	110.0	28.01	111.5	28.17	115.0	28.43	118.4	28.54
	41	91.9	23.44	100.3	27.36	103.7	27.49	105.2	27.63	107.3	27.79	110.5	28.04	113.5	28.15
	43	89.6	24.72	96.1	26.97	99.5	27.11	101.0	27.25	103.0	27.41	106.2	27.65	109.1	27.76
46	84.0	26.46	87.7	26.41	90.9	26.54	92.3	26.68	94.2	26.84	97.2	27.08	99.9	27.18	
48	74.3	25.73	76.2	25.80	79.0	25.86	80.3	25.93	82.0	26.15	84.6	26.32	87.0	26.42	
120	10	12.4	1.26	16.9	1.58	22.5	1.92	31.7	2.34	41.8	2.93	60.2	3.91	79.8	5.17
	12	12.4	1.28	16.9	1.60	22.5	1.94	31.7	2.37	41.8	2.96	60.2	3.95	79.8	5.23
	14	12.4	1.29	16.9	1.61	22.5	1.96	31.7	2.39	41.8	2.99	60.2	3.99	79.8	5.28
	16	12.4	1.30	16.9	1.63	22.5	1.98	31.7	2.42	41.8	3.02	60.2	4.03	79.8	5.34
	18	12.4	1.32	16.9	1.65	22.5	2.00	31.7	2.44	41.8	3.05	60.2	4.07	79.8	5.39
	20	12.4	1.33	16.9	1.66	22.5	2.02	31.7	2.47	41.8	3.08	60.2	4.11	79.8	5.45
	21	12.4	1.34	17.1	1.71	28.5	2.58	36.9	2.94	47.2	3.79	64.4	5.17	82.7	6.13
	23	21.4	2.39	30.8	3.19	40.5	3.67	48.2	3.98	58.5	5.70	73.3	7.37	88.5	8.69
	25	33.4	3.78	43.2	4.78	53.0	5.35	60.1	6.30	70.1	8.20	82.6	10.72	94.2	12.61
	27	46.4	5.98	58.7	7.12	65.7	8.01	71.5	9.58	81.7	12.16	92.0	15.33	99.9	17.56
	29	59.6	8.30	70.7	9.59	78.4	11.77	83.1	13.86	93.4	16.51	101.4	19.82	105.7	22.29
	31	72.1	10.51	85.2	12.67	91.1	15.61	95.6	18.37	105.4	20.94	108.3	25.19	111.9	25.66
	33	83.6	12.95	100.4	16.54	106.4	20.09	107.9	23.30	109.8	27.42	112.7	27.73	116.3	27.95
	35	85.3	17.31	101.5	22.42	107.5	24.80	109.0	29.54	110.9	29.69	113.9	29.77	116.9	30.01
	37	85.3	18.62	101.5	23.66	106.0	26.44	107.5	28.92	109.0	29.06	112.0	29.15	115.0	29.38
	39	85.3	20.04	101.1	25.00	104.1	28.04	105.6	28.32	107.1	28.46	110.5	28.55	113.5	28.78
	41	83.1	21.47	96.7	26.35	99.9	27.49	101.4	27.73	102.8	27.87	105.8	27.95	108.8	28.17
	43	81.1	22.91	92.6	25.97	95.8	26.87	97.2	27.13	98.7	27.27	101.6	27.35	104.5	27.57
46	76.0	24.64	84.5	25.35	87.5	26.03	88.8	26.24	90.2	26.37	92.9	26.45	95.6	26.66	
48	67.2	24.13	73.3	24.90	76.1	25.52	77.2	25.68	78.4	25.76	80.8	25.86	83.3	25.96	
110	10	11.3	1.19	15.4	1.48	20.6	1.81	29.1	2.20	38.3	2.75	55.1	3.67	73.1	4.86
	12	11.3	1.20	15.4	1.50	20.6	1.82	29.1	2.23	38.3	2.78	55.1	3.71	73.1	4.91
	14	11.3	1.21	15.4	1.51	20.6	1.84	29.1	2.25	38.3	2.81	55.1	3.75	73.1	4.96
	16	11.3	1.23	15.4	1.53	20.6	1.86	29.1	2.27	38.3	2.84	55.1	3.79	73.1	5.01
	18	11.3	1.24	15.4	1.55	20.6	1.88	29.1	2.29	38.3	2.87	55.1	3.83	73.1	5.07
	20	11.3	1.25	15.4	1.56	20.6	1.90	29.1	2.32	38.3	2.90	55.1	3.86	73.1	5.12
	21	11.3	1.26	15.4	1.61	25.8	2.37	34.1	2.76	42.6	3.56	59.5	4.86	76.9	5.76
	23	20.3	2.24	25.8	3.00	36.1	3.36	44.5	3.74	54.0	5.36	67.6	6.93	83.5	8.16
	25	29.2	3.55	36.1	4.50	46.5	5.02	55.0	5.92	64.1	7.70	75.6	10.07	90.1	11.85
	27	38.1	5.62	46.5	6.69	56.8	7.53	65.3	9.00	74.7	11.43	84.2	14.41	97.4	16.50
	29	47.0	7.80	56.8	9.01	67.2	11.06	76.0	13.02	85.4	15.52	92.7	18.25	102.7	20.24
	31	57.0	9.88	68.5	11.91	79.0	14.67	86.6	17.26	96.0	19.68	101.3	21.11	106.5	22.72
	33	66.1	12.17	79.0	15.54	89.6	18.88	97.6	21.09	103.8	23.67	107.0	24.33	109.7	24.36
	35	76.4	15.33	91.1	19.73	101.8	22.49	104.7	24.10	106.2	25.58	108.8	25.82	111.7	25.94
	37	76.4	16.25	91.1	20.94	101.8	23.75	103.2	25.53	104.3	26.98	107.3	27.07	109.9	27.15
	39	76.4	17.52	91.1	22.25	99.9	25.05	101.4	27.31	102.9	28.32	105.5	28.36	108.4	28.39
	41	74.5	18.79	88.8	23.56	95.7	26.42	97.2	29.54	98.4	29.54	101.3	29.77	103.8	30.01
	43	72.6	19.73	86.6	24.55	91.7	28.02	93.2	28.33	94.4	28.27	97.2	28.43	99.7	28.51
46	68.1	19.26	81.1	23.70	83.6	26.59	85.1	26.59	86.2	26.82	88.8	26.97	91.2	27.04	
48	60.2	18.70	70.5	22.83	72.7	25.30	74.0	25.47	74.9	25.59	77.3	25.66	79.3	25.77	

# 7. Capacity Tables

Cooling Capacity (34HP)

Combination (%)	Outdoor air temp. (DB, °C)	Indoor air temp. (DB/WB, °C)													
		20		23		26		27		28		30		32	
		14		16		18		19		20		22		24	
		TC	PI	TC	PI	TC	PI	TC	PI	TC	PI	TC	PI	TC	PI
100	10	10.4	1.09	14.2	1.36	18.9	1.66	26.7	2.02	35.1	2.53	50.6	3.37	67.1	4.46
	12	10.4	1.10	14.2	1.38	18.9	1.67	26.7	2.04	35.1	2.55	50.6	3.40	67.1	4.51
	14	10.4	1.11	14.2	1.39	18.9	1.69	26.7	2.06	35.1	2.58	50.6	3.44	67.1	4.55
	16	10.4	1.12	14.2	1.40	18.9	1.71	26.7	2.08	35.1	2.61	50.6	3.47	67.1	4.60
	18	10.4	1.14	14.2	1.42	18.9	1.73	26.7	2.11	35.1	2.63	50.6	3.51	67.1	4.65
	20	10.4	1.15	14.2	1.43	18.9	1.74	26.7	2.13	35.1	2.66	50.6	3.55	67.1	4.69
	21	10.4	1.16	14.2	1.48	23.5	2.18	31.3	2.53	40.0	3.27	54.6	4.46	70.5	5.28
	23	18.0	2.06	24.8	2.75	32.9	3.08	41.2	3.43	50.0	4.92	62.6	6.36	77.4	7.49
	25	25.7	3.26	33.5	4.12	42.3	4.61	51.4	5.43	59.9	7.07	70.6	9.24	84.2	10.87
	27	33.4	5.15	42.1	6.14	51.6	6.91	61.1	8.26	69.9	10.48	78.7	13.22	91.0	15.14
	29	41.1	7.16	50.8	8.26	61.0	10.14	71.0	11.94	79.8	14.24	86.7	17.09	97.9	18.57
	31	48.8	9.06	59.4	10.92	70.4	13.46	80.9	15.83	89.7	18.06	94.7	19.76	105.5	21.06
	33	56.5	11.17	68.0	14.26	79.7	17.32	90.8	20.09	99.8	21.94	102.9	22.32	105.5	22.81
	35	64.3	13.45	76.5	17.17	89.1	21.34	95.2	23.63	99.8	23.77	102.9	23.86	105.5	24.06
	37	64.3	14.41	76.5	18.42	89.1	22.61	95.2	24.76	98.1	24.88	101.0	24.98	103.4	25.21
	39	64.3	15.44	76.5	19.79	89.1	23.96	95.2	25.96	96.5	26.08	99.3	26.18	101.7	26.42
	41	63.2	16.48	75.3	21.15	87.7	25.31	91.3	27.17	93.4	27.28	95.5	27.38	98.6	27.64
43	61.1	17.45	72.7	22.43	84.7	26.52	87.6	28.21	88.6	28.31	91.3	28.41	93.7	28.67	
46	57.2	18.76	68.1	24.18	79.3	28.13	80.0	29.54	80.8	29.62	83.4	29.71	85.7	29.99	
48	50.6	16.20	60.3	20.92	68.5	24.04	69.5	25.06	70.2	25.14	72.5	25.20	74.5	25.40	
90	10	9.3	1.00	12.7	1.25	17.0	1.57	23.5	1.80	31.6	2.32	45.5	3.06	60.4	4.01
	12	9.3	1.01	12.7	1.27	17.0	1.59	23.5	1.82	31.6	2.35	45.5	3.10	60.4	4.06
	14	9.3	1.02	12.7	1.28	17.0	1.61	23.5	1.84	31.6	2.37	45.5	3.13	60.4	4.10
	16	9.3	1.03	12.7	1.29	17.0	1.62	23.5	1.85	31.6	2.40	45.5	3.16	60.4	4.14
	18	9.3	1.05	12.7	1.31	17.0	1.64	23.5	1.87	31.6	2.42	45.5	3.19	60.4	4.18
	20	9.3	1.06	12.7	1.32	17.0	1.66	23.5	1.89	31.6	2.45	45.5	3.23	60.4	4.22
	21	9.3	1.07	12.7	1.33	21.3	2.09	27.8	2.24	35.6	2.93	49.2	3.55	63.5	4.65
	23	12.7	1.65	18.8	2.29	29.8	2.96	36.1	3.22	43.6	4.31	56.5	5.26	70.0	6.39
	25	20.2	2.79	27.1	3.67	38.2	4.38	44.4	5.09	51.5	6.29	63.9	7.95	76.4	9.24
	27	27.7	4.10	35.5	5.23	46.6	6.80	52.6	7.57	59.5	9.17	71.2	10.70	82.9	12.09
	29	35.2	5.53	43.9	7.18	55.1	9.47	60.9	10.47	67.4	12.11	78.6	13.73	89.4	16.00
	31	42.7	6.93	52.3	9.22	63.5	11.86	69.2	13.36	75.3	15.08	85.9	15.99	95.8	18.60
	33	50.2	8.92	60.6	11.35	71.9	14.37	77.4	15.84	83.3	17.53	93.3	18.94	102.3	20.77
	35	57.8	11.04	69.0	13.96	80.2	17.26	85.7	19.04	91.1	20.70	100.6	22.21	102.3	22.72
	37	57.8	11.72	69.0	14.85	80.2	18.41	85.7	20.23	91.1	21.85	99.0	23.21	100.7	23.74
	39	57.8	12.41	69.0	15.80	80.2	19.48	85.7	21.52	91.1	22.98	97.3	24.47	99.1	24.77
	41	56.3	13.88	67.3	17.51	78.2	21.38	83.5	23.54	88.8	24.81	93.3	25.79	94.9	26.38
43	54.9	14.99	65.6	18.92	76.3	23.36	81.4	25.35	86.6	26.60	89.4	27.56	91.1	27.95	
46	51.5	16.87	61.5	21.55	71.5	26.61	76.3	28.74	78.7	29.55	81.6	29.71	83.2	29.99	
48	45.5	14.74	54.4	18.85	63.2	23.28	67.5	25.06	68.3	25.14	71.0	25.20	72.3	25.40	
80	10	8.0	0.89	10.9	1.11	14.5	1.39	20.5	1.60	27.1	2.05	38.9	2.71	51.7	3.55
	12	8.0	0.90	10.9	1.12	14.5	1.41	20.5	1.62	27.1	2.08	38.9	2.74	51.7	3.59
	14	8.0	0.91	10.9	1.13	14.5	1.42	20.5	1.63	27.1	2.10	38.9	2.77	51.7	3.62
	16	8.0	0.91	10.9	1.14	14.5	1.43	20.5	1.65	27.1	2.12	38.9	2.79	51.7	3.66
	18	8.0	0.92	10.9	1.15	14.5	1.45	20.5	1.67	27.1	2.14	38.9	2.82	51.7	3.70
	20	8.0	0.93	10.9	1.17	14.5	1.46	20.5	1.68	27.1	2.16	38.9	2.85	51.7	3.73
	21	8.0	0.94	10.9	1.20	18.3	1.84	24.5	2.02	30.7	2.59	42.3	3.14	54.9	4.11
	23	14.2	1.73	18.1	2.06	25.8	2.62	32.4	2.90	37.9	3.81	49.3	4.65	61.3	5.65
	25	20.4	2.51	25.3	3.30	33.3	3.87	40.3	4.58	45.1	5.56	56.2	7.02	67.8	8.17
	27	26.6	3.69	32.5	4.70	40.8	6.01	48.3	6.82	52.4	8.11	63.2	9.45	74.2	10.69
	29	32.7	4.78	39.6	6.46	48.3	8.37	56.2	9.42	59.6	10.70	70.1	12.14	80.7	14.15
	31	38.9	5.86	46.8	8.13	55.9	10.48	64.1	12.02	68.2	12.97	77.1	13.99	87.1	16.28
	33	45.1	7.71	54.0	10.01	63.4	12.32	72.1	14.26	76.3	14.90	84.0	16.58	93.5	18.32
	35	51.3	10.09	61.2	12.64	71.1	15.51	76.2	17.03	81.3	18.65	91.1	21.16	99.9	22.04
	37	51.3	10.67	61.2	13.44	71.1	16.45	76.2	18.11	81.3	19.81	91.1	22.33	98.3	23.15
	39	51.3	11.27	61.2	14.21	71.1	17.60	76.2	19.47	81.3	21.29	91.1	23.59	96.7	24.42
	41	50.0	12.47	59.6	15.74	69.2	19.31	74.2	21.34	79.2	23.39	88.8	25.28	92.6	25.86
43	48.8	13.73	58.2	17.18	67.5	21.08	72.4	23.26	77.2	25.57	86.6	27.00	88.8	27.68	
46	45.7	15.28	54.5	19.35	63.3	23.75	67.8	25.88	72.4	28.85	79.2	29.71	81.1	29.99	
48	40.4	13.34	48.2	16.92	56.0	20.77	60.0	22.61	64.0	25.14	68.8	25.20	70.4	25.40	

# 7. Capacity Tables

Cooling Capacity (34HP)

Combination (%)	Outdoor air temp. (DB, °C)	Indoor air temp. (DB/WB, °C)													
		20		23		26		27		28		30		32	
		14		16		18		19		20		22		24	
		TC	PI	TC	PI	TC	PI	TC	PI	TC	PI	TC	PI	TC	PI
70	10	7.0	0.78	9.5	0.98	12.7	1.23	17.9	1.42	23.5	1.82	33.9	2.40	44.9	3.14
	12	7.0	0.79	9.5	0.99	12.7	1.24	17.9	1.44	23.5	1.83	33.9	2.42	44.9	3.17
	14	7.0	0.80	9.5	1.00	12.7	1.26	17.9	1.45	23.5	1.85	33.9	2.45	44.9	3.20
	16	7.0	0.81	9.5	1.01	12.7	1.27	17.9	1.47	23.5	1.87	33.9	2.47	44.9	3.24
	18	7.0	0.82	9.5	1.02	12.7	1.28	17.9	1.48	23.5	1.89	33.9	2.50	44.9	3.27
	20	7.0	0.83	9.5	1.03	12.7	1.29	17.9	1.50	23.5	1.91	33.9	2.52	44.9	3.30
	21	7.0	0.83	11.1	1.21	16.4	1.70	22.1	1.88	27.2	2.29	37.4	2.77	48.4	3.63
	23	10.0	1.25	17.1	1.98	23.0	2.48	29.8	2.70	34.5	3.37	44.4	4.11	55.1	5.00
	25	15.8	2.06	23.2	2.92	29.5	3.42	37.4	4.26	41.8	4.91	51.4	6.21	61.8	7.22
	27	21.6	3.00	29.3	4.16	36.0	5.05	45.1	6.34	49.1	7.17	58.4	8.36	68.5	9.45
	29	27.5	3.80	35.4	5.49	42.6	6.87	52.7	8.62	56.4	9.46	65.5	10.73	75.2	12.51
	31	33.3	4.68	41.4	6.83	49.1	8.60	60.4	10.83	63.8	11.46	72.5	12.37	81.9	14.39
	33	39.1	6.29	47.5	8.31	55.6	9.98	66.6	12.58	71.1	13.17	79.6	14.66	88.4	16.20
	35	44.9	8.62	53.7	10.74	62.2	12.99	66.6	14.21	71.1	15.52	79.6	18.27	88.4	20.03
	37	44.9	9.16	53.7	11.37	62.2	13.80	66.6	15.11	71.1	16.51	79.6	19.44	88.4	21.14
	39	44.9	9.72	53.7	12.13	62.2	14.76	66.6	16.26	71.1	17.83	79.6	20.81	88.4	22.79
	41	43.7	10.75	52.3	13.28	60.6	16.19	64.9	17.83	69.2	19.39	77.5	22.85	86.1	24.56
43	42.7	11.70	51.1	14.48	59.1	17.67	63.3	19.45	67.5	21.17	75.6	24.97	84.0	26.57	
46	40.0	13.00	47.8	16.28	55.4	19.89	59.3	21.66	63.3	23.87	70.9	28.16	78.7	29.63	
48	35.4	11.35	42.3	14.22	49.0	17.39	52.5	18.93	56.0	20.88	62.7	24.64	69.6	25.40	
60	10	6.1	0.68	8.2	0.85	11.0	1.07	15.5	1.25	20.4	1.58	29.3	2.09	38.9	2.74
	12	6.1	0.69	8.2	0.86	11.0	1.08	15.5	1.26	20.4	1.60	29.3	2.11	38.9	2.76
	14	6.1	0.70	8.2	0.87	11.0	1.09	15.5	1.28	20.4	1.62	29.3	2.13	38.9	2.79
	16	6.1	0.71	8.2	0.88	11.0	1.11	15.5	1.29	20.4	1.63	29.3	2.15	38.9	2.82
	18	6.1	0.71	8.2	0.89	11.0	1.12	15.5	1.30	20.4	1.65	29.3	2.18	38.9	2.85
	20	6.1	0.72	8.2	0.90	11.0	1.13	15.5	1.32	20.4	1.67	29.3	2.20	38.9	2.88
	21	6.1	0.72	8.2	0.93	13.7	1.45	18.2	1.60	23.4	2.00	31.9	2.42	41.4	3.17
	23	6.1	0.80	13.6	1.69	19.4	2.17	25.2	2.32	29.4	2.94	37.1	3.58	46.3	4.36
	25	11.4	1.52	19.0	2.55	25.0	2.98	32.4	3.95	35.5	4.29	43.1	5.31	51.2	6.30
	27	16.8	2.22	24.4	3.63	30.7	4.40	39.1	5.50	41.6	6.15	48.4	7.03	56.1	8.11
	29	22.2	2.88	29.8	4.65	36.3	5.87	46.1	7.23	47.7	7.84	53.7	8.82	61.0	10.36
	31	27.6	3.66	35.2	5.56	42.0	7.15	51.8	8.68	53.7	9.11	60.2	9.76	66.0	11.94
	33	33.0	5.10	40.5	6.76	47.6	8.02	55.9	9.73	59.9	10.42	64.9	11.57	70.9	13.60
	35	38.4	7.31	45.9	8.94	53.4	10.71	57.1	11.67	60.9	12.67	68.3	14.80	75.8	17.07
	37	38.4	7.72	45.9	9.44	53.4	11.35	57.1	12.39	60.9	13.44	68.3	15.71	75.8	18.16
	39	38.4	8.21	45.9	10.05	53.4	12.25	57.1	13.30	60.9	14.46	68.3	16.84	75.8	19.46
	41	37.4	8.90	44.7	11.00	52.0	13.30	55.7	14.52	59.3	15.70	66.6	18.48	73.9	21.14
43	36.5	9.67	43.6	11.97	50.7	14.50	54.3	15.83	57.8	17.12	64.9	20.18	72.1	23.10	
46	34.2	10.83	40.9	13.44	47.5	16.31	50.9	17.79	54.2	19.26	60.9	22.73	67.5	26.31	
48	30.3	9.44	36.2	11.73	42.1	14.25	45.0	15.54	47.9	16.83	53.8	19.88	59.7	23.02	
50	10	5.5	0.60	7.5	0.74	10.6	0.94	14.1	1.15	18.6	1.38	26.8	1.82	35.6	2.37
	12	5.5	0.60	7.5	0.75	10.6	0.95	14.1	1.16	18.6	1.40	26.8	1.84	35.6	2.40
	14	5.5	0.61	7.5	0.76	10.6	0.95	14.1	1.17	18.6	1.41	26.8	1.86	35.6	2.42
	16	5.5	0.61	7.5	0.77	10.6	0.96	14.1	1.18	18.6	1.42	26.8	1.88	35.6	2.45
	18	5.5	0.62	7.5	0.78	10.6	0.97	14.1	1.20	18.6	1.44	26.8	1.90	35.6	2.47
	20	5.5	0.63	7.5	0.78	10.6	0.98	14.1	1.21	18.6	1.45	26.8	1.92	35.6	2.50
	21	5.5	0.63	7.5	0.81	13.2	1.26	16.7	1.45	21.2	1.74	29.1	2.11	37.5	2.75
	23	5.5	0.67	11.9	1.38	18.2	1.89	23.5	2.26	26.8	2.56	33.5	3.12	41.4	3.78
	25	9.9	1.22	16.3	2.04	23.3	2.65	31.1	3.67	32.9	3.74	37.9	4.40	45.2	5.34
	27	14.3	1.75	20.7	2.86	28.9	3.69	36.1	4.89	38.3	5.04	42.3	5.76	49.1	6.80
	29	18.8	2.30	25.2	3.69	33.5	4.75	40.6	6.06	43.7	6.50	46.8	7.13	53.0	8.59
	31	23.2	2.93	29.6	4.38	38.1	5.78	44.2	6.76	46.7	7.19	51.1	7.70	56.9	9.45
	33	27.6	4.08	34.0	5.28	42.7	6.49	45.9	7.41	48.7	7.94	55.3	9.13	60.7	10.60
	35	32.1	6.08	38.4	7.31	44.5	8.63	47.6	9.36	50.7	10.10	56.8	11.65	63.2	13.38
	37	32.1	6.44	38.4	7.72	44.5	9.14	47.6	9.91	50.7	10.69	56.8	12.43	63.2	14.21
	39	32.1	6.87	38.4	8.28	44.5	9.79	47.6	10.67	50.7	11.47	56.8	13.23	63.2	15.34
	41	31.3	7.43	37.4	8.96	43.4	10.70	46.4	11.56	49.4	12.43	55.3	14.51	61.6	16.66
43	30.5	8.07	36.5	9.74	42.3	11.65	45.2	12.58	48.1	13.53	54.0	15.82	60.1	18.18	
46	28.6	9.04	34.2	10.93	39.7	13.06	42.4	14.13	45.1	15.19	50.6	17.80	56.3	20.47	
48	25.3	7.88	30.3	9.53	35.1	11.40	37.5	12.33	39.9	13.26	44.7	15.55	49.8	17.89	

**Note**

1. TC: Total Capacity(kW), PI : Power Input(kW, Comp. + Outdoor fan motor)
2. Capacity tables show the average value of conditions which may occur.

# 7. Capacity Tables

◆ ARUM360LTE5

Cooling Capacity (36HP)

Combination (%)	Outdoor air temp. (DB, °C)	Indoor air temp. (DB/WB, °C)													
		20		23		26		27		28		30		32	
		14	16	16	18	18	19	20	20	22	22	24	24		
		TC	PI	TC	PI	TC	PI	TC	PI	TC	PI	TC	PI	TC	PI
130	10	14.2	1.44	19.3	1.79	25.8	2.18	36.4	2.66	48.0	3.33	69.1	4.44	91.6	5.88
	12	14.2	1.45	19.3	1.81	25.8	2.21	36.4	2.69	48.0	3.36	69.1	4.49	91.6	5.94
	14	14.2	1.47	19.3	1.83	25.8	2.23	36.4	2.72	48.0	3.40	69.1	4.53	91.6	6.00
	16	14.2	1.48	19.3	1.85	25.8	2.25	36.4	2.75	48.0	3.43	69.1	4.58	91.6	6.06
	18	14.2	1.50	19.3	1.87	25.8	2.28	36.4	2.78	48.0	3.47	69.1	4.63	91.6	6.13
	20	14.2	1.51	19.3	1.89	25.8	2.30	36.4	2.80	48.0	3.50	69.1	4.67	91.6	6.19
	21	14.2	1.53	19.6	1.95	31.9	2.87	42.4	3.34	53.7	4.30	73.6	5.87	94.5	6.96
	23	24.7	2.71	34.3	3.57	44.4	4.06	55.4	4.52	65.0	6.48	82.7	8.38	100.4	9.87
	25	36.4	4.30	44.2	5.35	56.9	6.08	69.1	7.16	76.3	9.31	91.8	12.18	106.3	14.33
	27	47.6	6.85	56.4	8.09	69.3	9.18	82.1	10.97	87.6	13.93	100.9	17.56	112.2	19.79
	29	58.7	9.51	68.7	11.16	81.8	13.48	95.5	15.87	98.9	18.92	110.1	22.71	118.1	25.27
	31	71.2	12.43	82.6	15.33	96.1	18.60	107.5	21.71	110.2	24.76	116.3	31.10	124.2	31.54
	33	83.8	15.31	97.9	20.00	109.9	23.94	116.2	31.08	118.7	30.86	122.4	31.13	130.6	31.57
	35	99.8	20.69	114.4	25.07	118.1	30.43	120.1	30.58	122.1	30.76	125.4	31.04	129.0	31.16
	37	99.8	22.06	112.8	26.31	116.5	30.02	118.1	30.18	120.1	30.36	123.4	30.63	127.0	30.75
	39	99.8	23.49	110.8	27.70	114.4	29.62	116.5	29.77	118.1	29.95	121.7	30.22	125.4	30.34
	41	97.3	24.92	106.2	29.08	109.8	29.22	111.4	29.37	113.6	29.54	117.0	29.81	120.2	29.93
	43	94.9	26.28	101.8	28.67	105.3	28.82	106.9	28.96	109.1	29.14	112.4	29.40	115.5	29.51
46	88.9	28.13	92.8	28.07	96.2	28.22	97.7	28.36	99.8	28.53	102.9	28.78	105.7	28.90	
48	78.7	27.35	80.6	27.43	83.6	27.49	85.0	27.56	86.8	27.80	89.6	27.98	92.1	28.09	
120	10	13.1	1.34	17.8	1.68	23.8	2.04	33.6	2.49	44.3	3.11	63.7	4.15	84.5	5.50
	12	13.1	1.36	17.8	1.70	23.8	2.06	33.6	2.52	44.3	3.15	63.7	4.20	84.5	5.56
	14	13.1	1.37	17.8	1.71	23.8	2.09	33.6	2.54	44.3	3.18	63.7	4.24	84.5	5.61
	16	13.1	1.39	17.8	1.73	23.8	2.11	33.6	2.57	44.3	3.21	63.7	4.28	84.5	5.67
	18	13.1	1.40	17.8	1.75	23.8	2.13	33.6	2.60	44.3	3.25	63.7	4.33	84.5	5.73
	20	13.1	1.42	17.8	1.77	23.8	2.15	33.6	2.62	44.3	3.28	63.7	4.37	84.5	5.79
	21	13.1	1.43	18.1	1.82	30.1	2.74	39.1	3.12	50.0	4.03	68.2	5.49	87.6	6.51
	23	22.7	2.54	32.6	3.39	42.8	3.90	51.1	4.23	61.9	6.06	77.6	7.84	93.7	9.23
	25	35.4	4.02	45.7	5.09	56.1	5.68	63.7	6.70	74.2	8.71	87.5	11.39	99.7	13.40
	27	49.2	6.36	62.2	7.57	69.6	8.52	75.7	10.18	86.5	12.93	97.4	16.30	105.8	18.66
	29	63.1	8.82	74.9	10.19	83.0	12.51	87.9	14.73	98.9	17.56	107.4	21.07	111.9	23.69
	31	76.4	11.17	90.2	13.47	96.5	16.59	101.2	19.52	111.6	22.27	114.6	26.78	118.5	27.28
	33	88.5	13.77	106.3	17.58	112.7	21.36	114.2	24.77	116.2	29.14	119.4	29.48	123.1	29.71
	35	90.3	18.40	107.4	23.83	113.8	26.36	115.4	31.40	117.4	31.56	120.6	31.65	123.7	31.90
	37	90.3	19.79	107.4	25.15	112.2	28.11	113.8	30.74	115.4	30.89	118.6	30.99	121.8	31.23
	39	90.3	21.31	107.0	26.58	110.2	29.81	111.8	30.11	113.4	30.26	117.0	30.35	120.2	30.59
	41	88.0	22.82	102.4	28.01	105.8	29.22	107.3	29.48	108.9	29.62	112.0	29.71	115.2	29.95
	43	85.9	24.36	98.1	27.61	101.5	28.57	102.9	28.85	104.5	28.99	107.5	29.08	110.6	29.31
46	80.5	26.19	89.4	26.95	92.7	27.67	94.0	27.90	95.5	28.04	98.4	28.12	101.3	28.34	
48	71.2	25.66	77.6	26.47	80.5	27.13	81.8	27.30	83.0	27.38	85.6	27.49	88.2	27.60	
110	10	12.0	1.26	16.3	1.58	21.8	1.92	30.8	2.34	40.5	2.93	58.4	3.90	77.4	5.17
	12	12.0	1.28	16.3	1.59	21.8	1.94	30.8	2.37	40.5	2.96	58.4	3.94	77.4	5.22
	14	12.0	1.29	16.3	1.61	21.8	1.96	30.8	2.39	40.5	2.99	58.4	3.98	77.4	5.28
	16	12.0	1.30	16.3	1.63	21.8	1.98	30.8	2.41	40.5	3.02	58.4	4.03	77.4	5.33
	18	12.0	1.32	16.3	1.64	21.8	2.00	30.8	2.44	40.5	3.05	58.4	4.07	77.4	5.38
	20	12.0	1.33	16.3	1.66	21.8	2.02	30.8	2.46	40.5	3.08	58.4	4.11	77.4	5.44
	21	12.0	1.34	16.3	1.71	27.3	2.52	36.1	2.93	45.1	3.78	63.0	5.16	81.4	6.12
	23	21.5	2.38	27.3	3.19	38.3	3.57	47.1	3.97	57.2	5.70	71.6	7.37	88.5	8.68
	25	30.9	3.78	38.3	4.78	49.2	5.34	58.2	6.30	67.9	8.19	80.0	10.71	95.4	12.60
	27	40.3	5.97	49.2	7.11	60.2	8.00	69.2	9.57	79.1	12.15	89.1	15.32	103.1	17.54
	29	49.8	8.29	60.1	9.57	71.1	11.75	80.4	13.84	90.4	16.50	98.2	19.40	108.8	21.52
	31	60.4	10.50	72.5	12.66	83.7	15.59	91.7	18.35	101.7	20.92	107.3	22.44	112.8	24.16
	33	70.0	12.94	83.7	16.52	94.9	20.07	103.4	22.42	109.9	25.17	113.3	25.86	116.2	25.90
	35	80.9	16.30	96.5	20.97	107.8	23.91	110.9	25.62	112.4	27.19	115.2	27.44	118.3	27.58
	37	80.9	17.28	96.5	22.26	107.8	25.24	109.3	27.14	110.5	28.68	113.6	28.78	116.3	28.86
	39	80.9	18.63	96.5	23.65	105.8	26.63	107.4	29.03	108.9	30.10	111.7	30.15	114.8	30.18
	41	78.9	19.98	94.0	25.05	101.3	28.09	102.9	31.40	104.2	31.40	107.3	31.65	109.9	31.90
	43	76.9	20.98	91.7	26.10	97.1	29.78	98.7	30.12	99.9	30.06	102.9	30.23	105.5	30.31
46	72.1	20.47	85.9	25.19	88.6	28.27	90.1	28.27	91.3	28.51	94.1	28.67	96.5	28.75	
48	63.8	19.88	74.7	24.27	76.9	26.89	78.3	27.07	79.4	27.21	81.8	27.28	84.0	27.39	

# 7. Capacity Tables

Cooling Capacity (36HP)

Combination (%)	Outdoor air temp. (DB, °C)	Indoor air temp. (DB/WB, °C)													
		20		23		26		27		28		30		32	
		14		16		18		19		20		22		24	
		TC	PI	TC	PI	TC	PI	TC	PI	TC	PI	TC	PI	TC	PI
100	10	11.0	1.16	15.0	1.45	20.0	1.76	28.2	2.15	37.2	2.68	53.6	3.58	71.0	4.74
	12	11.0	1.17	15.0	1.46	20.0	1.78	28.2	2.17	37.2	2.71	53.6	3.62	71.0	4.79
	14	11.0	1.18	15.0	1.48	20.0	1.80	28.2	2.19	37.2	2.74	53.6	3.66	71.0	4.84
	16	11.0	1.20	15.0	1.49	20.0	1.82	28.2	2.22	37.2	2.77	53.6	3.69	71.0	4.89
	18	11.0	1.21	15.0	1.51	20.0	1.83	28.2	2.24	37.2	2.80	53.6	3.73	71.0	4.94
	20	11.0	1.22	15.0	1.52	20.0	1.85	28.2	2.26	37.2	2.83	53.6	3.77	71.0	4.99
	21	11.0	1.23	15.0	1.57	24.9	2.32	33.2	2.69	42.4	3.47	57.8	4.74	74.7	5.62
	23	19.1	2.19	26.3	2.92	34.8	3.28	43.7	3.64	52.9	5.23	66.3	6.76	81.9	7.96
	25	27.2	3.47	35.4	4.38	44.8	4.90	54.4	5.78	63.4	7.51	74.8	9.82	89.1	11.56
	27	35.4	5.48	44.6	6.52	54.7	7.34	64.7	8.78	74.0	11.14	83.3	14.05	96.4	16.09
	29	43.5	7.61	53.7	8.78	64.6	10.78	75.2	12.70	84.5	15.13	91.8	18.17	103.6	19.74
	31	51.6	9.63	62.9	11.61	74.5	14.31	85.7	16.83	95.0	19.19	100.3	21.00	111.7	22.38
	33	59.8	11.87	72.0	15.15	84.4	18.41	96.2	21.36	105.6	23.32	108.9	23.73	111.7	24.24
	35	68.0	14.30	81.0	18.26	94.3	22.69	100.8	25.12	105.6	25.27	108.9	25.37	111.7	25.57
	37	68.0	15.31	81.0	19.58	94.3	24.03	100.8	26.32	103.9	26.45	106.9	26.55	109.4	26.80
	39	68.0	16.42	81.0	21.03	94.3	25.47	100.8	27.60	102.2	27.72	105.2	27.83	107.6	28.09
	41	67.0	17.52	79.7	22.49	92.8	26.90	96.7	28.89	98.8	29.00	101.2	29.11	104.5	29.38
43	64.7	18.55	77.0	23.84	89.6	28.19	92.7	29.99	93.8	30.10	96.7	30.20	99.2	30.48	
46	60.6	19.95	72.1	25.70	84.0	29.90	84.7	31.40	85.6	31.49	88.3	31.58	90.7	31.88	
48	53.6	17.22	63.8	22.24	72.5	25.56	73.6	26.64	74.3	26.73	76.8	26.79	78.9	27.00	
90	10	9.9	1.07	13.5	1.33	18.0	1.67	24.9	1.91	33.5	2.47	48.2	3.26	63.9	4.27
	12	9.9	1.08	13.5	1.35	18.0	1.69	24.9	1.93	33.5	2.50	48.2	3.29	63.9	4.31
	14	9.9	1.09	13.5	1.36	18.0	1.71	24.9	1.95	33.5	2.52	48.2	3.33	63.9	4.36
	16	9.9	1.10	13.5	1.37	18.0	1.73	24.9	1.97	33.5	2.55	48.2	3.36	63.9	4.40
	18	9.9	1.11	13.5	1.39	18.0	1.74	24.9	1.99	33.5	2.57	48.2	3.40	63.9	4.45
	20	9.9	1.12	13.5	1.40	18.0	1.76	24.9	2.01	33.5	2.60	48.2	3.43	63.9	4.49
	21	9.9	1.13	13.5	1.42	22.6	2.22	29.5	2.38	37.7	3.12	52.1	3.77	67.3	4.94
	23	13.4	1.75	19.9	2.43	31.5	3.15	38.2	3.43	46.1	4.59	59.9	5.59	74.1	6.80
	25	21.4	2.96	28.7	3.90	40.4	4.66	47.0	5.42	54.6	6.68	67.6	8.45	80.9	9.82
	27	29.3	4.36	37.6	5.56	49.4	7.23	55.7	8.05	63.0	9.75	75.4	11.37	87.8	12.85
	29	37.3	5.88	46.5	7.63	58.3	10.07	64.5	11.13	71.4	12.87	83.2	14.60	94.6	17.01
	31	45.2	7.36	55.3	9.80	67.2	12.60	73.2	14.20	79.8	16.03	91.0	16.99	101.4	19.77
	33	53.1	9.48	64.2	12.06	76.2	15.28	82.0	16.84	88.2	18.64	98.8	20.14	108.3	22.08
	35	61.2	11.74	73.1	14.84	85.0	18.35	90.7	20.24	96.5	22.01	106.5	23.61	108.3	24.15
	37	61.2	12.46	73.1	15.79	85.0	19.57	90.7	21.50	96.5	23.23	104.8	24.68	106.6	25.23
	39	61.2	13.19	73.1	16.79	85.0	20.71	90.7	22.88	96.5	24.43	103.1	26.02	104.9	26.33
	41	59.6	14.76	71.2	18.62	82.8	22.73	88.4	25.02	94.0	26.37	98.8	27.42	100.5	28.05
43	58.2	15.93	69.4	20.12	80.7	24.83	86.2	26.95	91.7	28.28	94.7	29.29	96.4	29.72	
46	54.5	17.93	65.1	22.91	75.7	28.29	80.8	30.55	83.3	31.42	86.4	31.58	88.1	31.88	
48	48.2	15.67	57.6	20.04	66.9	24.75	71.5	26.64	72.3	26.73	75.1	26.79	76.6	27.00	
80	10	8.5	0.94	11.5	1.18	15.4	1.48	21.7	1.70	28.6	2.18	41.2	2.88	54.7	3.77
	12	8.5	0.95	11.5	1.19	15.4	1.49	21.7	1.72	28.6	2.21	41.2	2.91	54.7	3.81
	14	8.5	0.96	11.5	1.20	15.4	1.51	21.7	1.74	28.6	2.23	41.2	2.94	54.7	3.85
	16	8.5	0.97	11.5	1.21	15.4	1.53	21.7	1.75	28.6	2.25	41.2	2.97	54.7	3.89
	18	8.5	0.98	11.5	1.23	15.4	1.54	21.7	1.77	28.6	2.28	41.2	3.00	54.7	3.93
	20	8.5	0.99	11.5	1.24	15.4	1.56	21.7	1.79	28.6	2.30	41.2	3.03	54.7	3.97
	21	8.5	1.00	11.5	1.27	19.3	1.96	25.9	2.15	32.5	2.76	44.8	3.33	58.1	4.37
	23	15.0	1.84	19.2	2.19	27.3	2.78	34.3	3.08	40.1	4.05	52.2	4.94	65.0	6.01
	25	21.6	2.67	26.8	3.51	35.3	4.12	42.7	4.87	47.8	5.91	59.6	7.47	71.8	8.68
	27	28.1	3.92	34.4	5.00	43.2	6.39	51.1	7.25	55.4	8.62	66.9	10.05	78.6	11.36
	29	34.7	5.08	42.0	6.87	51.2	8.90	59.5	10.02	63.1	11.38	74.3	12.90	85.4	15.04
	31	41.2	6.23	49.6	8.64	59.1	11.14	67.9	12.78	72.2	13.79	81.6	14.87	92.2	17.30
	33	47.8	8.19	57.2	10.64	67.1	13.10	76.3	15.16	80.8	15.84	89.0	17.62	99.0	19.48
	35	54.4	10.72	64.8	13.44	75.2	16.49	80.6	18.11	86.0	19.82	96.5	22.49	105.8	23.43
	37	54.4	11.34	64.8	14.29	75.2	17.49	80.6	19.25	86.0	21.06	96.5	23.74	104.1	24.61
	39	54.4	11.99	64.8	15.10	75.2	18.71	80.6	20.70	86.0	22.63	96.5	25.08	102.4	25.96
	41	53.0	13.26	63.1	16.74	73.3	20.53	78.6	22.69	83.8	24.87	94.0	26.87	98.1	27.49
43	51.7	14.60	61.6	18.27	71.5	22.41	76.6	24.72	81.8	27.18	91.7	28.71	94.0	29.42	
46	48.4	16.24	57.7	20.57	67.0	25.25	71.8	27.52	76.6	30.67	83.8	31.58	85.8	31.88	
48	42.8	14.18	51.1	17.99	59.3	22.08	63.5	24.04	67.8	26.73	72.8	26.79	74.6	27.00	



# 7. Capacity Tables

Cooling Capacity (36HP)

Combination (%)	Outdoor air temp. (DB, °C)	Indoor air temp. (DB/WB, °C)													
		20		23		26		27		28		30		32	
		14		16		18		19		20		22		24	
		TC	PI	TC	PI	TC	PI	TC	PI	TC	PI	TC	PI	TC	PI
70	10	7.4	0.83	10.0	1.04	13.4	1.31	18.9	1.51	24.9	1.93	35.9	2.55	47.6	3.33
	12	7.4	0.84	10.0	1.05	13.4	1.32	18.9	1.53	24.9	1.95	35.9	2.57	47.6	3.37
	14	7.4	0.85	10.0	1.06	13.4	1.33	18.9	1.55	24.9	1.97	35.9	2.60	47.6	3.40
	16	7.4	0.86	10.0	1.07	13.4	1.35	18.9	1.56	24.9	1.99	35.9	2.63	47.6	3.44
	18	7.4	0.87	10.0	1.08	13.4	1.36	18.9	1.58	24.9	2.01	35.9	2.65	47.6	3.47
	20	7.4	0.88	10.0	1.10	13.4	1.38	18.9	1.59	24.9	2.03	35.9	2.68	47.6	3.51
	21	7.4	0.88	11.7	1.29	17.4	1.80	23.4	2.00	28.8	2.44	39.6	2.95	51.2	3.86
	23	10.6	1.33	18.1	2.10	24.3	2.64	31.5	2.87	36.5	3.58	47.0	4.37	58.3	5.31
	25	16.7	2.19	24.6	3.10	31.2	3.64	39.6	4.53	44.3	5.22	54.4	6.60	65.4	7.68
	27	22.9	3.19	31.0	4.42	38.1	5.37	47.7	6.74	52.0	7.62	61.9	8.88	72.5	10.04
	29	29.1	4.04	37.4	5.84	45.1	7.30	55.8	9.17	59.8	10.06	69.3	11.41	79.6	13.29
	31	35.2	4.97	43.9	7.26	52.0	9.14	63.9	11.52	67.5	12.19	76.7	13.15	86.7	15.29
	33	41.4	6.69	50.3	8.83	58.9	10.61	70.6	13.37	75.2	14.00	84.2	15.58	93.6	17.22
	35	47.5	9.16	56.9	11.42	65.9	13.81	70.6	15.11	75.2	16.50	84.2	19.42	93.6	21.29
	37	47.5	9.73	56.9	12.09	65.9	14.67	70.6	16.06	75.2	17.55	84.2	20.67	93.6	22.47
	39	47.5	10.34	56.9	12.89	65.9	15.69	70.6	17.28	75.2	18.96	84.2	22.12	93.6	24.23
41	46.3	11.43	55.4	14.12	64.2	17.21	68.8	18.96	73.3	20.61	82.1	24.30	91.2	26.11	
43	45.2	12.44	54.1	15.39	62.6	18.78	67.1	20.67	71.5	22.51	80.1	26.54	88.9	28.24	
46	42.3	13.82	50.7	17.31	58.7	21.15	62.8	23.03	67.0	25.37	75.0	29.93	83.4	31.50	
48	37.4	12.06	44.8	15.12	51.9	18.49	55.6	20.12	59.3	22.20	66.4	26.20	73.7	27.00	
60	10	6.5	0.71	8.7	0.89	11.6	1.12	16.4	1.30	21.6	1.65	31.1	2.17	41.2	2.85
	12	6.5	0.72	8.7	0.90	11.6	1.13	16.4	1.31	21.6	1.66	31.1	2.20	41.2	2.88
	14	6.5	0.73	8.7	0.91	11.6	1.14	16.4	1.33	21.6	1.68	31.1	2.22	41.2	2.91
	16	6.5	0.73	8.7	0.92	11.6	1.15	16.4	1.34	21.6	1.70	31.1	2.24	41.2	2.94
	18	6.5	0.74	8.7	0.93	11.6	1.16	16.4	1.36	21.6	1.72	31.1	2.26	41.2	2.96
	20	6.5	0.75	8.7	0.93	11.6	1.17	16.4	1.37	21.6	1.73	31.1	2.29	41.2	2.99
	21	6.5	0.75	8.7	0.97	14.5	1.51	19.2	1.66	24.7	2.08	33.7	2.52	43.8	3.29
	23	6.5	0.83	14.4	1.76	20.5	2.25	26.6	2.41	31.2	3.06	39.2	3.73	49.0	4.53
	25	12.1	1.58	20.1	2.65	26.5	3.10	34.3	4.11	37.6	4.46	45.6	5.52	54.2	6.55
	27	17.8	2.31	25.8	3.77	32.5	4.58	41.4	5.72	44.0	6.40	51.2	7.31	59.4	8.43
	29	23.5	3.00	31.5	4.83	38.5	6.10	48.9	7.52	50.5	8.15	56.9	9.17	64.6	10.78
	31	29.2	3.81	37.2	5.78	44.5	7.43	54.8	9.02	56.9	9.47	63.7	10.15	69.8	12.42
	33	34.9	5.31	42.9	7.03	50.4	8.35	59.1	10.12	63.4	10.84	68.8	12.03	75.0	14.15
	35	40.7	7.77	48.6	9.51	56.5	11.39	60.5	12.40	64.4	13.46	72.4	15.73	80.3	18.15
	37	40.7	8.20	48.6	10.03	56.5	12.06	60.5	13.17	64.4	14.28	72.4	16.70	80.3	19.30
	39	40.7	8.72	48.6	10.68	56.5	13.02	60.5	14.13	64.4	15.37	72.4	17.90	80.3	20.69
41	39.6	9.46	47.4	11.69	55.1	14.14	58.9	15.44	62.8	16.69	70.5	19.65	78.2	22.48	
43	38.7	10.28	46.2	12.73	53.7	15.42	57.5	16.83	61.2	18.20	68.8	21.45	76.3	24.55	
46	36.2	11.52	43.3	14.29	50.3	17.34	53.9	18.91	57.4	20.48	64.4	24.17	71.5	27.97	
48	32.0	10.03	38.3	12.47	44.5	15.15	47.6	16.52	50.8	17.89	57.0	21.14	63.2	24.47	
50	10	5.8	0.61	7.9	0.76	11.2	0.95	15.0	1.17	19.7	1.41	28.4	1.86	37.6	2.42
	12	5.8	0.61	7.9	0.77	11.2	0.96	15.0	1.18	19.7	1.42	28.4	1.87	37.6	2.44
	14	5.8	0.62	7.9	0.77	11.2	0.97	15.0	1.19	19.7	1.44	28.4	1.89	37.6	2.47
	16	5.8	0.63	7.9	0.78	11.2	0.98	15.0	1.21	19.7	1.45	28.4	1.91	37.6	2.49
	18	5.8	0.63	7.9	0.79	11.2	0.99	15.0	1.22	19.7	1.47	28.4	1.93	37.6	2.52
	20	5.8	0.64	7.9	0.80	11.2	1.00	15.0	1.23	19.7	1.48	28.4	1.95	37.6	2.55
	21	5.8	0.64	7.9	0.83	13.9	1.29	17.6	1.48	22.4	1.78	30.8	2.15	39.7	2.80
	23	5.8	0.68	12.6	1.41	19.3	1.92	24.9	2.30	28.4	2.61	35.5	3.18	43.8	3.85
	25	10.5	1.25	17.3	2.07	24.7	2.70	33.0	3.73	34.9	3.81	40.2	4.48	47.9	5.44
	27	15.2	1.79	22.0	2.91	30.6	3.76	38.2	4.98	40.6	5.13	44.8	5.86	52.0	6.92
	29	19.9	2.35	26.6	3.76	35.5	4.83	43.0	6.17	46.2	6.62	49.5	7.27	56.1	8.75
	31	24.6	2.98	31.3	4.47	40.3	5.89	46.8	6.89	49.5	7.32	54.1	7.85	60.2	9.62
	33	29.3	4.15	36.0	5.38	45.2	6.61	48.6	7.55	51.6	8.09	58.5	9.30	64.3	10.80
	35	34.0	6.46	40.7	7.77	47.2	9.18	50.4	9.96	53.6	10.73	60.1	12.38	67.0	14.23
	37	34.0	6.85	40.7	8.21	47.2	9.71	50.4	10.54	53.6	11.36	60.1	13.21	67.0	15.10
	39	34.0	7.30	40.7	8.80	47.2	10.41	50.4	11.34	53.6	12.19	60.1	14.07	67.0	16.31
41	33.1	7.90	39.6	9.52	46.0	11.38	49.1	12.29	52.3	13.21	58.6	15.42	65.2	17.71	
43	32.3	8.58	38.7	10.36	44.8	12.38	47.9	13.38	51.0	14.38	57.1	16.82	63.6	19.32	
46	30.3	9.61	36.2	11.62	42.0	13.89	44.9	15.02	47.8	16.15	53.5	18.92	59.6	21.76	
48	26.8	8.38	32.0	10.13	37.2	12.11	39.7	13.11	42.3	14.09	47.4	16.54	52.8	19.02	

**Note**

1. TC: Total Capacity(kW), PI : Power Input(kW, Comp. + Outdoor fan motor)
2. Capacity tables show the average value of conditions which may occur.

# 7. Capacity Tables

◆ ARUM380LTE5

Cooling Capacity (38HP)

Combination (%)	Outdoor air temp. (DB, °C)	Indoor air temp. (DB/WB, °C)													
		20		23		26		27		28		30		32	
		14	PI	16	PI	18	PI	19	PI	20	PI	22	PI	24	PI
130	10	15.0	1.49	20.4	1.86	27.2	2.27	38.4	2.77	50.7	3.46	72.9	4.61	96.7	6.10
	12	15.0	1.51	20.4	1.88	27.2	2.29	38.4	2.79	50.7	3.49	72.9	4.66	96.7	6.17
	14	15.0	1.52	20.4	1.90	27.2	2.31	38.4	2.82	50.7	3.53	72.9	4.71	96.7	6.23
	16	15.0	1.54	20.4	1.92	27.2	2.34	38.4	2.85	50.7	3.57	72.9	4.75	96.7	6.30
	18	15.0	1.55	20.4	1.94	27.2	2.36	38.4	2.88	50.7	3.60	72.9	4.80	96.7	6.36
	20	15.0	1.57	20.4	1.96	27.2	2.39	38.4	2.91	50.7	3.64	72.9	4.85	96.7	6.42
	21	15.0	1.59	20.7	2.02	33.7	2.98	44.8	3.47	56.6	4.47	77.7	6.10	99.8	7.23
	23	26.0	2.82	36.3	3.70	46.9	4.22	58.5	4.69	68.6	6.73	87.3	8.70	106.0	10.25
	25	38.5	4.46	46.6	5.55	60.0	6.31	73.0	7.44	80.5	9.67	96.9	12.64	112.2	14.88
	27	50.2	7.11	59.6	8.40	73.2	9.53	86.7	11.39	92.5	14.46	106.5	18.23	118.4	20.55
	29	62.0	9.87	72.5	11.58	86.3	13.99	100.8	16.48	104.4	19.64	116.2	23.57	124.7	26.24
	31	75.2	12.90	87.2	15.91	101.5	19.31	113.5	22.54	116.3	25.71	122.8	32.29	131.1	32.75
	33	88.4	15.90	103.4	20.77	116.0	24.85	122.6	32.26	125.3	32.04	129.2	32.32	137.9	32.78
	35	105.4	21.48	120.8	26.03	124.6	31.59	126.8	31.75	128.9	31.94	132.4	32.22	136.2	32.35
	37	105.4	22.90	119.1	27.32	122.9	31.17	124.6	31.33	126.8	31.52	130.2	31.80	134.1	31.92
	39	105.4	24.39	117.0	28.76	120.8	30.75	122.9	30.91	124.6	31.09	128.5	31.37	132.4	31.50
41	102.7	25.87	112.1	30.19	115.9	30.34	117.6	30.49	119.9	30.67	123.5	30.95	126.9	31.07	
43	100.2	27.29	107.4	29.77	111.2	29.92	112.9	30.07	115.1	30.25	118.7	30.52	121.9	30.64	
46	93.9	29.21	98.0	29.15	101.6	29.29	103.1	29.44	105.3	29.62	108.6	29.88	111.6	30.00	
48	83.0	28.39	85.1	28.48	88.3	28.54	89.7	28.62	91.6	28.86	94.6	29.05	97.2	29.16	
120	10	13.8	1.40	18.8	1.74	25.1	2.12	35.5	2.59	46.7	3.23	67.3	4.31	89.2	5.71
	12	13.8	1.41	18.8	1.76	25.1	2.14	35.5	2.61	46.7	3.27	67.3	4.36	89.2	5.77
	14	13.8	1.43	18.8	1.78	25.1	2.17	35.5	2.64	46.7	3.30	67.3	4.40	89.2	5.83
	16	13.8	1.44	18.8	1.80	25.1	2.19	35.5	2.67	46.7	3.34	67.3	4.45	89.2	5.89
	18	13.8	1.45	18.8	1.82	25.1	2.21	35.5	2.70	46.7	3.37	67.3	4.49	89.2	5.95
	20	13.8	1.47	18.8	1.83	25.1	2.23	35.5	2.72	46.7	3.40	67.3	4.54	89.2	6.01
	21	13.8	1.48	19.2	1.89	31.8	2.84	41.3	3.24	52.8	4.18	72.0	5.70	92.5	6.76
	23	24.0	2.63	34.4	3.52	45.2	4.05	53.9	4.39	65.4	6.29	81.9	8.14	98.9	9.59
	25	37.3	4.17	48.2	5.28	59.2	5.90	67.2	6.96	78.4	9.05	92.4	11.83	105.3	13.92
	27	51.9	6.60	65.6	7.85	73.5	8.84	79.9	10.57	91.3	13.42	102.9	16.92	111.7	19.38
	29	66.6	9.16	79.0	10.58	87.6	12.99	92.8	15.29	104.3	18.23	113.3	21.88	118.1	24.60
	31	80.6	11.60	95.2	13.99	101.8	17.23	106.9	20.27	117.8	23.12	121.0	27.80	125.1	28.32
	33	93.5	14.30	112.3	18.25	118.9	22.17	120.6	25.72	122.7	30.26	126.0	30.60	130.0	30.85
	35	95.4	19.10	113.4	24.74	120.1	27.37	121.8	32.60	123.9	32.76	127.3	32.86	130.6	33.12
	37	95.4	20.55	113.4	26.11	118.4	29.18	120.1	31.91	121.8	32.07	125.2	32.17	128.5	32.43
	39	95.4	22.12	113.0	27.60	116.4	30.95	118.0	31.26	119.7	31.42	123.5	31.51	126.8	31.76
41	92.9	23.69	108.1	29.08	111.7	30.34	113.3	30.60	114.9	30.76	118.3	30.85	121.6	31.09	
43	90.6	25.29	103.5	28.67	107.1	29.66	108.7	29.95	110.3	30.10	113.5	30.19	116.8	30.43	
46	84.9	27.19	94.4	27.98	97.8	28.73	99.3	28.96	100.8	29.11	103.8	29.20	106.9	29.43	
48	75.1	26.64	82.0	27.49	85.0	28.17	86.3	28.34	87.6	28.43	90.3	28.54	93.0	28.66	
110	10	12.7	1.31	17.3	1.64	23.0	1.99	32.5	2.43	42.8	3.04	61.6	4.05	81.7	5.36
	12	12.7	1.33	17.3	1.65	23.0	2.01	32.5	2.46	42.8	3.07	61.6	4.09	81.7	5.42
	14	12.7	1.34	17.3	1.67	23.0	2.03	32.5	2.48	42.8	3.10	61.6	4.14	81.7	5.48
	16	12.7	1.35	17.3	1.69	23.0	2.06	32.5	2.51	42.8	3.13	61.6	4.18	81.7	5.53
	18	12.7	1.37	17.3	1.71	23.0	2.08	32.5	2.53	42.8	3.17	61.6	4.22	81.7	5.59
	20	12.7	1.38	17.3	1.72	23.0	2.10	32.5	2.56	42.8	3.20	61.6	4.26	81.7	5.65
	21	12.7	1.39	17.3	1.78	28.8	2.62	38.1	3.05	47.6	3.93	66.5	5.36	85.9	6.36
	23	22.7	2.47	28.8	3.31	40.4	3.71	49.8	4.12	60.3	5.91	75.6	7.65	93.4	9.01
	25	32.6	3.92	40.4	4.96	51.9	5.55	61.5	6.54	71.7	8.50	84.5	11.12	100.7	13.08
	27	42.6	6.20	51.9	7.38	63.5	8.31	73.0	9.94	83.5	12.61	94.1	15.90	108.9	18.21
	29	52.5	8.61	63.5	9.94	75.1	12.20	84.9	14.37	95.4	17.13	103.6	20.15	114.8	22.34
	31	63.7	10.90	76.5	13.14	88.3	16.19	96.8	19.05	107.3	21.72	113.2	23.29	119.1	25.08
	33	73.9	13.43	88.3	17.15	100.1	20.84	109.1	23.28	116.0	26.13	119.6	26.85	122.7	26.89
	35	85.4	16.92	101.8	21.77	113.8	24.83	117.0	26.60	118.7	28.23	121.6	28.49	124.9	28.63
	37	85.4	17.94	101.8	23.11	113.8	26.21	115.4	28.18	116.6	29.78	119.9	29.88	122.8	29.96
	39	85.4	19.34	101.8	24.56	111.7	27.65	113.3	30.14	115.0	31.25	117.9	31.30	121.2	31.34
41	83.2	20.74	99.2	26.01	106.9	29.16	108.6	32.60	110.0	32.60	113.2	32.86	116.0	33.12	
43	81.2	21.78	96.8	27.09	102.5	30.92	104.1	31.27	105.5	31.20	108.6	31.38	111.4	31.47	
46	76.1	21.26	90.7	26.16	93.5	29.35	95.1	29.35	96.4	29.60	99.3	29.76	101.9	29.84	
48	67.3	20.64	78.8	25.20	81.2	27.92	82.7	28.11	83.8	28.24	86.4	28.32	88.6	28.44	

# 7. Capacity Tables

Cooling Capacity (38HP)

Combination (%)	Outdoor air temp. (DB, °C)	Indoor air temp. (DB/WB, °C)													
		20		23		26		27		28		30		32	
		14		16		18		19		20		22		24	
		TC	PI	TC	PI	TC	PI	TC	PI	TC	PI	TC	PI	TC	PI
100	10	11.6	1.20	15.8	1.50	21.1	1.83	29.8	2.23	39.3	2.79	56.5	3.72	75.0	4.92
	12	11.6	1.22	15.8	1.52	21.1	1.85	29.8	2.25	39.3	2.82	56.5	3.76	75.0	4.97
	14	11.6	1.23	15.8	1.53	21.1	1.87	29.8	2.28	39.3	2.85	56.5	3.80	75.0	5.03
	16	11.6	1.24	15.8	1.55	21.1	1.89	29.8	2.30	39.3	2.88	56.5	3.83	75.0	5.08
	18	11.6	1.25	15.8	1.57	21.1	1.90	29.8	2.32	39.3	2.90	56.5	3.87	75.0	5.13
	20	11.6	1.27	15.8	1.58	21.1	1.92	29.8	2.35	39.3	2.93	56.5	3.91	75.0	5.18
	21	11.6	1.28	15.8	1.63	26.3	2.40	35.0	2.80	44.8	3.60	61.0	4.92	78.8	5.83
	23	20.1	2.27	27.7	3.03	36.8	3.40	46.1	3.78	55.9	5.43	70.0	7.02	86.5	8.26
	25	28.7	3.60	37.4	4.55	47.2	5.09	57.5	6.00	67.0	7.80	78.9	10.20	94.1	12.00
	27	37.3	5.69	47.1	6.77	57.7	7.62	68.3	9.12	78.1	11.57	87.9	14.59	101.7	16.70
	29	45.9	7.90	56.7	9.12	68.2	11.20	79.3	13.18	89.2	15.71	96.9	18.86	109.4	20.50
	31	54.5	10.00	66.4	12.06	78.7	14.85	90.4	17.47	100.3	19.93	105.8	21.81	117.9	23.24
	33	63.1	12.33	76.0	15.73	89.1	19.12	101.5	22.17	111.5	24.21	115.0	24.63	117.9	25.17
	35	71.8	14.85	85.5	18.95	99.6	23.56	106.4	26.08	111.5	26.24	115.0	26.34	117.9	26.55
	37	71.8	15.90	85.5	20.33	99.6	24.95	106.4	27.32	109.7	27.46	112.8	27.57	115.5	27.82
	39	71.8	17.05	85.5	21.84	99.6	26.44	106.4	28.66	107.8	28.78	111.0	28.89	113.6	29.16
	41	70.7	18.19	84.1	23.35	98.0	27.93	102.1	29.99	104.3	30.11	106.8	30.22	110.3	30.50
43	68.3	19.25	81.3	24.75	94.6	29.27	97.9	31.14	99.0	31.25	102.1	31.35	104.7	31.65	
46	64.0	20.71	76.1	26.68	88.7	31.04	89.4	32.60	90.3	32.70	93.2	32.79	95.7	33.10	
48	56.6	17.88	67.4	23.08	76.5	26.54	77.7	27.66	78.5	27.75	81.1	27.81	83.3	28.04	
90	10	10.4	1.11	14.2	1.38	19.0	1.74	26.3	1.98	35.3	2.56	50.9	3.38	67.5	4.43
	12	10.4	1.12	14.2	1.40	19.0	1.75	26.3	2.01	35.3	2.59	50.9	3.42	67.5	4.48
	14	10.4	1.13	14.2	1.41	19.0	1.77	26.3	2.03	35.3	2.62	50.9	3.45	67.5	4.52
	16	10.4	1.14	14.2	1.43	19.0	1.79	26.3	2.05	35.3	2.65	50.9	3.49	67.5	4.57
	18	10.4	1.15	14.2	1.44	19.0	1.81	26.3	2.07	35.3	2.67	50.9	3.53	67.5	4.62
	20	10.4	1.17	14.2	1.45	19.0	1.83	26.3	2.09	35.3	2.70	50.9	3.56	67.5	4.66
	21	10.4	1.18	14.2	1.47	23.8	2.30	31.1	2.48	39.8	3.24	55.0	3.92	71.0	5.13
	23	14.2	1.82	21.0	2.53	33.3	3.27	40.3	3.56	48.7	4.76	63.2	5.80	78.2	7.06
	25	22.6	3.08	30.3	4.05	42.7	4.83	49.6	5.62	57.6	6.94	71.4	8.77	85.4	10.20
	27	30.9	4.52	39.7	5.77	52.1	7.50	58.8	8.36	66.5	10.12	79.6	11.80	92.7	13.34
	29	39.3	6.11	49.1	7.92	61.5	10.45	68.1	11.56	75.3	13.36	87.8	15.16	99.9	17.66
	31	47.7	7.64	58.4	10.17	71.0	13.09	77.3	14.75	84.2	16.64	96.0	17.64	107.1	20.53
	33	56.1	9.84	67.8	12.52	80.4	15.86	86.5	17.49	93.1	19.35	104.3	20.91	114.3	22.93
	35	64.6	12.19	77.1	15.41	89.7	19.05	95.8	21.01	101.8	22.85	112.4	24.51	114.3	25.07
	37	64.6	12.94	77.1	16.39	89.7	20.32	95.8	22.32	101.8	24.12	110.6	25.62	112.5	26.20
	39	64.6	13.70	77.1	17.43	89.7	21.50	95.8	23.75	101.8	25.36	108.8	27.01	110.7	27.34
	41	62.9	15.32	75.2	19.33	87.4	23.60	93.3	25.98	99.2	27.38	104.2	28.47	106.1	29.12
43	61.4	16.54	73.3	20.89	85.2	25.78	91.0	27.98	96.8	29.36	100.0	30.41	101.8	30.85	
46	57.5	18.62	68.7	23.79	79.9	29.37	85.3	31.72	87.9	32.62	91.3	32.79	93.0	33.10	
48	50.9	16.27	60.8	20.81	70.7	25.70	75.4	27.66	76.4	27.75	79.3	27.81	80.8	28.04	
80	10	8.9	0.98	12.2	1.22	16.3	1.54	22.9	1.77	30.2	2.27	43.5	2.99	57.7	3.92
	12	8.9	0.99	12.2	1.23	16.3	1.55	22.9	1.78	30.2	2.29	43.5	3.02	57.7	3.96
	14	8.9	1.00	12.2	1.25	16.3	1.57	22.9	1.80	30.2	2.31	43.5	3.05	57.7	4.00
	16	8.9	1.01	12.2	1.26	16.3	1.58	22.9	1.82	30.2	2.34	43.5	3.08	57.7	4.04
	18	8.9	1.02	12.2	1.27	16.3	1.60	22.9	1.84	30.2	2.36	43.5	3.12	57.7	4.08
	20	8.9	1.03	12.2	1.29	16.3	1.62	22.9	1.86	30.2	2.39	43.5	3.15	57.7	4.12
	21	8.9	1.04	12.2	1.32	20.4	2.04	27.4	2.23	34.3	2.86	47.3	3.46	61.4	4.53
	23	15.9	1.91	20.2	2.27	28.8	2.89	36.2	3.20	42.3	4.21	55.1	5.13	68.6	6.24
	25	22.8	2.77	28.2	3.65	37.2	4.27	45.1	5.06	50.4	6.14	62.9	7.75	75.8	9.01
	27	29.7	4.07	36.3	5.19	45.6	6.63	53.9	7.52	58.5	8.95	70.6	10.43	82.9	11.80
	29	36.6	5.28	44.3	7.13	54.0	9.24	62.8	10.40	66.6	11.81	78.4	13.40	90.1	15.61
	31	43.5	6.47	52.3	8.97	62.4	11.57	71.6	13.27	76.2	14.31	86.2	15.44	97.3	17.96
	33	50.4	8.51	60.3	11.04	70.8	13.60	80.6	15.74	85.3	16.45	93.9	18.30	104.5	20.22
	35	57.4	11.13	68.4	13.95	79.4	17.12	85.1	18.80	90.8	20.58	101.8	23.35	111.7	24.32
	37	57.4	11.77	68.4	14.83	79.4	18.16	85.1	19.99	90.8	21.87	101.8	24.64	109.9	25.55
	39	57.4	12.44	68.4	15.68	79.4	19.42	85.1	21.49	90.8	23.50	101.8	26.04	108.0	26.95
	41	55.9	13.77	66.6	17.38	77.4	21.32	82.9	23.55	88.5	25.82	99.2	27.90	103.5	28.54
43	54.5	15.15	65.0	18.96	75.5	23.27	80.9	25.67	86.3	28.22	96.8	29.80	99.2	30.54	
46	51.1	16.86	60.9	21.36	70.7	26.22	75.8	28.57	80.9	31.84	88.5	32.79	90.6	33.10	
48	45.2	14.72	53.9	18.68	62.6	22.93	67.1	24.96	71.6	27.75	76.9	27.81	78.7	28.04	

# 7. Capacity Tables

Cooling Capacity (38HP)

Combination (%)	Outdoor air temp. (DB, °C)	Indoor air temp. (DB/WB, °C)													
		20		23		26		27		28		30		32	
		14		16		18		19		20		22		24	
		TC	PI	TC	PI	TC	PI	TC	PI	TC	PI	TC	PI	TC	PI
70	10	7.8	0.87	10.6	1.08	14.1	1.36	20.0	1.57	26.3	2.00	37.9	2.64	50.2	3.46
	12	7.8	0.87	10.6	1.09	14.1	1.37	20.0	1.59	26.3	2.02	37.9	2.67	50.2	3.50
	14	7.8	0.88	10.6	1.10	14.1	1.39	20.0	1.61	26.3	2.05	37.9	2.70	50.2	3.53
	16	7.8	0.89	10.6	1.11	14.1	1.40	20.0	1.62	26.3	2.07	37.9	2.73	50.2	3.57
	18	7.8	0.90	10.6	1.13	14.1	1.41	20.0	1.64	26.3	2.09	37.9	2.75	50.2	3.61
	20	7.8	0.91	10.6	1.14	14.1	1.43	20.0	1.65	26.3	2.11	37.9	2.78	50.2	3.64
	21	7.8	0.92	12.4	1.34	18.4	1.87	24.7	2.08	30.4	2.53	41.8	3.06	54.1	4.01
	23	11.2	1.38	19.2	2.18	25.7	2.74	33.3	2.98	38.6	3.72	49.6	4.53	61.6	5.51
	25	17.7	2.27	25.9	3.22	33.0	3.78	41.8	4.71	46.7	5.42	57.5	6.85	69.0	7.97
	27	24.2	3.31	32.7	4.59	40.3	5.57	50.4	7.00	54.9	7.91	65.3	9.22	76.5	10.43
	29	30.7	4.20	39.5	6.06	47.6	7.58	58.9	9.52	63.1	10.44	73.2	11.84	84.0	13.80
	31	37.2	5.17	46.3	7.54	54.9	9.49	67.5	11.96	71.3	12.65	81.0	13.65	91.5	15.88
	33	43.7	6.95	53.1	9.17	62.2	11.02	74.5	13.88	79.4	14.54	88.9	16.18	98.8	17.88
	35	50.2	9.51	60.0	11.85	69.5	14.34	74.5	15.68	79.4	17.13	88.9	20.16	98.8	22.11
	37	50.2	10.11	60.0	12.55	69.5	15.23	74.5	16.68	79.4	18.22	88.9	21.46	98.8	23.33
	39	50.2	10.73	60.0	13.38	69.5	16.29	74.5	17.94	79.4	19.68	88.9	22.97	98.8	25.15
	41	48.9	11.87	58.5	14.66	67.8	17.87	72.6	19.68	77.4	21.40	86.6	25.22	96.3	27.11
43	47.7	12.92	57.1	15.98	66.1	19.50	70.8	21.46	75.5	23.37	84.5	27.56	93.9	29.32	
46	44.7	14.35	53.5	17.97	61.9	21.96	66.3	23.91	70.7	26.34	79.2	31.08	88.0	32.70	
48	39.5	12.53	47.3	15.69	54.8	19.20	58.7	20.89	62.6	23.04	70.1	27.20	77.8	28.04	
60	10	6.9	0.75	9.2	0.93	12.2	1.17	17.3	1.37	22.8	1.73	32.8	2.28	43.5	2.99
	12	6.9	0.75	9.2	0.94	12.2	1.18	17.3	1.38	22.8	1.75	32.8	2.31	43.5	3.02
	14	6.9	0.76	9.2	0.95	12.2	1.20	17.3	1.40	22.8	1.77	32.8	2.33	43.5	3.05
	16	6.9	0.77	9.2	0.96	12.2	1.21	17.3	1.41	22.8	1.78	32.8	2.35	43.5	3.08
	18	6.9	0.78	9.2	0.97	12.2	1.22	17.3	1.42	22.8	1.80	32.8	2.38	43.5	3.11
	20	6.9	0.79	9.2	0.98	12.2	1.23	17.3	1.44	22.8	1.82	32.8	2.40	43.5	3.15
	21	6.9	0.79	9.2	1.02	15.3	1.58	20.3	1.74	26.1	2.19	35.6	2.64	46.3	3.46
	23	6.9	0.87	15.2	1.84	21.6	2.37	28.1	2.53	32.9	3.21	41.4	3.91	51.8	4.76
	25	12.7	1.66	21.2	2.78	28.0	3.26	36.2	4.32	39.7	4.68	48.2	5.80	57.2	6.88
	27	18.8	2.43	27.2	3.96	34.3	4.81	43.7	6.01	46.5	6.72	54.1	7.68	62.7	8.86
	29	24.8	3.15	33.3	5.08	40.6	6.41	51.6	7.90	53.3	8.56	60.0	9.63	68.2	11.32
	31	30.8	4.00	39.3	6.07	46.9	7.81	57.9	9.48	60.1	9.95	67.2	10.66	73.7	13.05
	33	36.8	5.57	45.3	7.38	53.2	8.77	62.4	10.63	66.9	11.39	72.6	12.64	79.2	14.86
	35	42.9	8.07	51.3	9.87	59.7	11.82	63.8	12.88	68.0	13.98	76.4	16.33	84.7	18.84
	37	42.9	8.52	51.3	10.42	59.7	12.53	63.8	13.68	68.0	14.83	76.4	17.34	84.7	20.04
	39	42.9	9.06	51.3	11.09	59.7	13.52	63.8	14.68	68.0	15.96	76.4	18.59	84.7	21.48
	41	41.8	9.82	50.0	12.14	58.1	14.68	62.2	16.03	66.3	17.32	74.4	20.40	82.6	23.34
43	40.8	10.68	48.8	13.21	56.7	16.01	60.7	17.47	64.6	18.89	72.6	22.27	80.5	25.49	
46	38.2	11.96	45.7	14.84	53.1	18.00	56.9	19.64	60.6	21.26	68.0	25.09	75.5	29.04	
48	33.8	10.42	40.4	12.95	47.0	15.73	50.3	17.15	53.6	18.58	60.2	21.94	66.8	25.41	
50	10	6.2	0.65	8.4	0.81	11.8	1.01	15.8	1.24	20.8	1.50	30.0	1.97	39.7	2.57
	12	6.2	0.65	8.4	0.81	11.8	1.02	15.8	1.26	20.8	1.51	30.0	1.99	39.7	2.60
	14	6.2	0.66	8.4	0.82	11.8	1.03	15.8	1.27	20.8	1.53	30.0	2.01	39.7	2.63
	16	6.2	0.67	8.4	0.83	11.8	1.04	15.8	1.28	20.8	1.54	30.0	2.04	39.7	2.65
	18	6.2	0.67	8.4	0.84	11.8	1.06	15.8	1.30	20.8	1.56	30.0	2.06	39.7	2.68
	20	6.2	0.68	8.4	0.85	11.8	1.07	15.8	1.31	20.8	1.57	30.0	2.08	39.7	2.71
	21	6.2	0.68	8.4	0.88	14.7	1.37	18.6	1.57	23.7	1.89	32.5	2.28	41.9	2.98
	23	6.2	0.73	13.3	1.50	20.4	2.05	26.3	2.45	30.0	2.78	37.5	3.38	46.2	4.10
	25	11.0	1.33	18.2	2.20	26.1	2.87	34.8	3.97	36.8	4.05	42.4	4.76	50.6	5.79
	27	16.0	1.90	23.2	3.10	32.3	4.00	40.3	5.29	42.8	5.46	47.3	6.23	54.9	7.36
	29	21.0	2.49	28.1	4.00	37.4	5.14	45.4	6.57	48.8	7.04	52.3	7.73	59.3	9.30
	31	25.9	3.17	33.1	4.75	42.6	6.26	49.4	7.32	52.2	7.78	57.1	8.34	63.6	10.23
	33	30.9	4.42	38.0	5.72	47.7	7.03	51.3	8.03	54.4	8.60	61.8	9.89	67.9	11.48
	35	35.9	6.71	42.9	8.07	49.8	9.53	53.2	10.34	56.6	11.14	63.5	12.86	70.7	14.77
	37	35.9	7.11	42.9	8.52	49.8	10.08	53.2	10.94	56.6	11.80	63.5	13.71	70.7	15.68
	39	35.9	7.58	42.9	9.13	49.8	10.80	53.2	11.78	56.6	12.66	63.5	14.61	70.7	16.94
	41	35.0	8.20	41.8	9.89	48.5	11.81	51.8	12.76	55.2	13.72	61.8	16.01	68.9	18.39
43	34.1	8.91	40.8	10.75	47.3	12.85	50.6	13.89	53.8	14.93	60.3	17.46	67.2	20.06	
46	32.0	9.98	38.2	12.06	44.3	14.42	47.4	15.60	50.4	16.76	56.5	19.65	62.9	22.59	
48	28.3	8.70	33.8	10.52	39.2	12.58	41.9	13.61	44.6	14.63	50.0	17.17	55.7	19.74	

**Note**

1. TC: Total Capacity(kW), PI : Power Input(kW, Comp. + Outdoor fan motor)
2. Capacity tables show the average value of conditions which may occur.

# 7. Capacity Tables

◆ ARUM400LTE5

Cooling Capacity (40HP)

Combination (%)	Outdoor air temp. (DB, °C)	Indoor air temp. (DB/WB, °C)													
		20		23		26		27		28		30		32	
		14	16	18	19	20	22	24	TC	PI	TC	PI	TC	PI	
130	10	15.8	1.62	21.5	2.02	28.7	2.46	40.5	3.00	53.3	3.75	76.8	5.00	101.8	6.62
	12	15.8	1.64	21.5	2.04	28.7	2.49	40.5	3.03	53.3	3.79	76.8	5.06	101.8	6.69
	14	15.8	1.65	21.5	2.06	28.7	2.51	40.5	3.06	53.3	3.83	76.8	5.11	101.8	6.76
	16	15.8	1.67	21.5	2.09	28.7	2.54	40.5	3.10	53.3	3.87	76.8	5.16	101.8	6.83
	18	15.8	1.69	21.5	2.11	28.7	2.56	40.5	3.13	53.3	3.91	76.8	5.21	101.8	6.90
	20	15.8	1.70	21.5	2.13	28.7	2.59	40.5	3.16	53.3	3.95	76.8	5.27	101.8	6.97
	21	15.8	1.72	21.8	2.19	35.5	3.24	47.2	3.76	59.6	4.85	81.7	6.62	105.0	7.85
	23	27.4	3.06	38.2	4.02	49.3	4.58	61.6	5.09	72.2	7.30	91.9	9.44	111.6	11.12
	25	40.5	4.84	49.1	6.03	63.2	6.85	76.8	8.07	84.8	10.50	102.0	13.73	118.1	16.15
	27	52.9	7.72	62.7	9.11	77.0	10.34	91.2	12.37	97.3	15.70	112.1	19.79	124.7	22.30
	29	65.2	10.72	76.3	12.57	90.9	15.19	106.1	17.89	109.9	21.32	122.4	25.59	131.2	28.48
	31	79.1	14.00	91.8	17.28	106.8	20.96	119.4	24.47	122.5	27.91	129.2	35.05	138.0	35.55
	33	93.1	17.26	108.8	22.54	122.1	26.98	129.1	35.02	131.9	34.78	136.0	35.09	145.2	35.58
	35	110.9	23.31	127.1	28.26	131.2	34.29	133.5	34.46	135.6	34.67	139.3	34.98	143.4	35.12
	37	110.9	24.86	125.3	29.66	129.4	33.84	131.2	34.01	133.5	34.21	137.1	34.52	141.2	34.65
	39	110.9	26.47	123.1	31.22	127.1	33.38	129.4	33.55	131.2	33.75	135.3	34.06	139.3	34.19
41	108.1	28.09	118.0	32.78	122.0	32.93	123.8	33.10	126.2	33.30	130.1	33.59	133.6	33.73	
43	105.4	29.62	113.1	32.32	117.0	32.48	118.8	32.64	121.2	32.84	124.9	33.13	128.3	33.26	
46	98.8	31.70	103.2	31.64	106.9	31.80	108.6	31.96	110.8	32.15	114.3	32.44	117.5	32.57	
48	87.4	30.82	89.6	30.91	92.9	30.98	94.4	31.06	96.4	31.33	99.5	31.53	102.3	31.65	
120	10	14.5	1.52	19.8	1.89	26.4	2.30	37.3	2.81	49.2	3.51	70.8	4.68	93.9	6.20
	12	14.5	1.53	19.8	1.91	26.4	2.33	37.3	2.84	49.2	3.55	70.8	4.73	93.9	6.26
	14	14.5	1.55	19.8	1.93	26.4	2.35	37.3	2.87	49.2	3.58	70.8	4.78	93.9	6.33
	16	14.5	1.56	19.8	1.95	26.4	2.37	37.3	2.90	49.2	3.62	70.8	4.83	93.9	6.39
	18	14.5	1.58	19.8	1.97	26.4	2.40	37.3	2.93	49.2	3.66	70.8	4.88	93.9	6.46
	20	14.5	1.59	19.8	1.99	26.4	2.42	37.3	2.96	49.2	3.69	70.8	4.93	93.9	6.52
	21	14.5	1.61	20.2	2.05	33.5	3.09	43.5	3.52	55.6	4.54	75.8	6.19	97.3	7.34
	23	25.2	2.86	36.2	3.82	47.6	4.39	56.8	4.77	68.8	6.83	86.2	8.84	104.1	10.41
	25	39.3	4.53	50.8	5.73	62.3	6.41	70.8	7.55	82.5	9.82	97.2	12.84	110.8	15.11
	27	54.6	7.16	69.1	8.53	77.3	9.60	84.1	11.48	96.2	14.57	108.3	18.37	117.5	21.03
	29	70.1	9.95	83.2	11.48	92.2	14.10	97.7	16.60	109.8	19.79	119.3	23.75	124.3	26.70
	31	84.9	12.59	100.2	15.18	107.2	18.70	112.5	22.00	124.0	25.09	127.4	30.18	131.7	30.74
	33	98.4	15.52	118.2	19.81	125.2	24.07	126.9	27.92	129.1	32.85	132.6	33.22	136.8	33.49
	35	100.4	20.74	119.4	26.86	126.5	29.71	128.2	35.39	130.4	35.56	134.0	35.67	137.5	35.95
	37	100.4	22.30	119.4	28.34	124.7	31.68	126.5	34.64	128.2	34.82	131.8	34.92	135.3	35.20
	39	100.4	24.01	118.9	29.96	122.5	33.60	124.2	33.93	126.0	34.10	130.0	34.20	133.5	34.47
41	97.8	25.72	113.7	31.57	117.6	32.93	119.2	33.22	121.0	33.39	124.5	33.49	128.0	33.75	
43	95.4	27.45	109.0	31.12	112.8	32.20	114.4	32.51	116.1	32.67	119.5	32.77	122.9	33.03	
46	89.4	29.52	99.4	30.37	103.0	31.19	104.5	31.44	106.1	31.60	109.3	31.69	112.5	31.94	
48	79.1	28.91	86.3	29.84	89.5	30.58	90.8	30.76	92.2	30.86	95.1	30.98	97.9	31.11	
110	10	13.3	1.42	18.2	1.78	24.2	2.16	34.2	2.64	45.1	3.30	64.9	4.40	86.0	5.82
	12	13.3	1.44	18.2	1.80	24.2	2.19	34.2	2.67	45.1	3.33	64.9	4.44	86.0	5.88
	14	13.3	1.45	18.2	1.81	24.2	2.21	34.2	2.69	45.1	3.37	64.9	4.49	86.0	5.95
	16	13.3	1.47	18.2	1.83	24.2	2.23	34.2	2.72	45.1	3.40	64.9	4.54	86.0	6.01
	18	13.3	1.48	18.2	1.85	24.2	2.25	34.2	2.75	45.1	3.44	64.9	4.58	86.0	6.07
	20	13.3	1.50	18.2	1.87	24.2	2.28	34.2	2.78	45.1	3.47	64.9	4.63	86.0	6.13
	21	13.3	1.51	18.2	1.93	30.4	2.84	40.2	3.31	50.1	4.26	70.0	5.82	90.4	6.90
	23	23.8	2.69	30.3	3.59	42.5	4.03	52.4	4.48	63.5	6.42	79.6	8.30	98.3	9.78
	25	34.3	4.26	42.5	5.39	54.7	6.02	64.7	7.10	75.4	9.23	88.9	12.07	106.0	14.19
	27	44.8	6.73	54.7	8.01	66.8	9.02	76.9	10.78	87.9	13.69	99.0	17.26	114.6	19.76
	29	55.3	9.35	66.8	10.79	79.0	13.25	89.4	15.60	100.4	18.59	109.1	21.87	120.9	24.25
	31	67.1	11.83	80.6	14.27	93.0	17.57	101.9	20.67	113.0	23.58	119.2	25.29	125.3	27.22
	33	77.8	14.58	93.0	18.62	105.4	22.62	114.9	25.27	122.1	28.36	125.9	29.15	129.1	29.19
	35	89.9	18.37	107.2	23.64	119.8	26.95	123.2	28.87	124.9	30.65	128.0	30.93	131.4	31.08
	37	89.9	19.47	107.2	25.09	119.8	28.45	121.5	30.59	122.8	32.32	126.2	32.43	129.3	32.53
	39	89.9	20.99	107.2	26.66	117.6	30.02	119.3	32.72	121.1	33.92	124.1	33.98	127.5	34.01
41	87.6	22.51	104.5	28.23	112.5	31.65	114.3	35.39	115.8	35.39	119.2	35.67	122.1	35.95	
43	85.5	23.64	101.9	29.41	107.9	33.57	109.6	33.95	111.0	33.87	114.4	34.06	117.2	34.16	
46	80.1	23.07	95.5	28.39	98.4	31.86	100.1	31.86	101.4	32.13	104.5	32.31	107.2	32.40	
48	70.8	22.41	83.0	27.35	85.5	30.31	87.0	30.51	88.2	30.66	90.9	30.75	93.3	30.87	

# 7. Capacity Tables

Cooling Capacity (40HP)

Combination (%)	Outdoor air temp. (DB, °C)	Indoor air temp. (DB/WB, °C)													
		20		23		26		27		28		30		32	
		14		16		18		19		20		22		24	
		TC	PI	TC	PI	TC	PI	TC	PI	TC	PI	TC	PI	TC	PI
100	10	12.2	1.31	16.7	1.63	22.2	1.98	31.4	2.42	41.3	3.03	59.5	4.03	78.9	5.34
	12	12.2	1.32	16.7	1.65	22.2	2.01	31.4	2.45	41.3	3.06	59.5	4.08	78.9	5.40
	14	12.2	1.33	16.7	1.67	22.2	2.03	31.4	2.47	41.3	3.09	59.5	4.12	78.9	5.46
	16	12.2	1.35	16.7	1.68	22.2	2.05	31.4	2.50	41.3	3.12	59.5	4.16	78.9	5.51
	18	12.2	1.36	16.7	1.70	22.2	2.07	31.4	2.52	41.3	3.15	59.5	4.20	78.9	5.57
	20	12.2	1.37	16.7	1.72	22.2	2.09	31.4	2.55	41.3	3.18	59.5	4.25	78.9	5.62
	21	12.2	1.39	16.7	1.77	27.7	2.61	36.8	3.03	47.1	3.91	64.2	5.34	83.0	6.33
	23	21.2	2.46	29.2	3.29	38.7	3.69	48.5	4.11	58.8	5.89	73.7	7.62	91.0	8.97
	25	30.2	3.91	39.4	4.94	49.7	5.52	60.5	6.51	70.5	8.46	83.1	11.07	99.0	13.02
	27	39.3	6.18	49.5	7.35	60.7	8.28	71.8	9.89	82.2	12.56	92.5	15.84	107.1	18.13
	29	48.3	8.57	59.7	9.90	71.8	12.15	83.5	14.31	93.9	17.06	102.0	20.47	115.1	22.25
	31	57.4	10.86	69.9	13.09	82.8	16.12	95.2	18.97	105.6	21.63	111.4	23.67	124.1	25.23
	33	66.4	13.38	80.0	17.08	93.8	20.75	106.9	24.07	117.4	26.28	121.0	26.74	124.1	27.32
	35	75.6	16.12	90.0	20.57	104.8	25.57	112.0	28.31	117.4	28.48	121.0	28.59	124.1	28.82
	37	75.6	17.26	90.0	22.07	104.8	27.09	112.0	29.66	115.4	29.80	118.8	29.92	121.6	30.20
	39	75.6	18.50	90.0	23.71	104.8	28.70	112.0	31.11	113.5	31.25	116.9	31.36	119.6	31.65
	41	74.4	19.75	88.6	25.34	103.1	30.32	107.5	32.56	109.8	32.69	112.4	32.80	116.1	33.11
43	71.8	20.90	85.5	26.87	99.6	31.77	103.0	33.80	104.2	33.92	107.4	34.03	110.3	34.35	
46	67.3	22.48	80.2	28.96	93.3	33.70	94.1	35.39	95.1	35.49	98.1	35.59	100.8	35.93	
48	59.6	19.41	70.9	25.06	80.6	28.81	81.8	30.03	82.6	30.12	85.3	30.19	87.7	30.43	
90	10	11.0	1.20	15.0	1.50	20.0	1.89	27.7	2.15	37.2	2.78	53.6	3.67	71.0	4.81
	12	11.0	1.21	15.0	1.52	20.0	1.90	27.7	2.18	37.2	2.81	53.6	3.71	71.0	4.86
	14	11.0	1.23	15.0	1.53	20.0	1.92	27.7	2.20	37.2	2.84	53.6	3.75	71.0	4.91
	16	11.0	1.24	15.0	1.55	20.0	1.94	27.7	2.22	37.2	2.87	53.6	3.79	71.0	4.96
	18	11.0	1.25	15.0	1.56	20.0	1.96	27.7	2.24	37.2	2.90	53.6	3.83	71.0	5.01
	20	11.0	1.26	15.0	1.58	20.0	1.98	27.7	2.27	37.2	2.93	53.6	3.87	71.0	5.06
	21	11.0	1.28	15.0	1.60	25.1	2.50	32.7	2.69	41.9	3.52	57.9	4.25	74.7	5.57
	23	14.9	1.98	22.1	2.74	35.0	3.54	42.5	3.86	51.3	5.17	66.5	6.30	82.3	7.66
	25	23.7	3.34	31.9	4.40	44.9	5.25	52.2	6.10	60.6	7.53	75.2	9.52	89.9	11.07
	27	32.6	4.91	41.8	6.26	54.9	8.14	61.9	9.07	70.0	10.99	83.8	12.81	97.5	14.48
	29	41.4	6.63	51.6	8.60	64.8	11.35	71.6	12.54	79.3	14.50	92.4	16.45	105.1	19.17
	31	50.2	8.30	61.5	11.04	74.7	14.21	81.4	16.01	88.6	18.07	101.1	19.15	112.7	22.28
	33	59.0	10.69	71.3	13.59	84.6	17.22	91.1	18.98	98.0	21.00	109.7	22.70	120.3	24.89
	35	68.0	13.23	81.2	16.73	94.4	20.68	100.8	22.81	107.2	24.80	118.3	26.61	120.3	27.22
	37	68.0	14.04	81.2	17.79	94.4	22.05	100.8	24.23	107.2	26.18	116.4	27.81	118.4	28.44
	39	68.0	14.87	81.2	18.92	94.4	23.34	100.8	25.79	107.2	27.53	114.5	29.32	116.5	29.67
	41	66.3	16.63	79.1	20.98	92.0	25.62	98.2	28.20	104.5	29.72	109.7	30.90	111.7	31.61
43	64.6	17.96	77.2	22.67	89.7	27.98	95.8	30.37	101.9	31.87	105.2	33.01	107.1	33.49	
46	60.6	20.21	72.3	25.82	84.1	31.88	89.8	34.43	92.6	35.41	96.1	35.59	97.9	35.93	
48	53.6	17.66	64.0	22.59	74.4	27.90	79.4	30.03	80.4	30.12	83.5	30.19	85.1	30.43	
80	10	9.4	1.06	12.8	1.33	17.1	1.67	24.1	1.92	31.8	2.46	45.8	3.25	60.8	4.25
	12	9.4	1.07	12.8	1.34	17.1	1.68	24.1	1.94	31.8	2.49	45.8	3.28	60.8	4.30
	14	9.4	1.08	12.8	1.35	17.1	1.70	24.1	1.96	31.8	2.51	45.8	3.31	60.8	4.34
	16	9.4	1.10	12.8	1.37	17.1	1.72	24.1	1.98	31.8	2.54	45.8	3.35	60.8	4.38
	18	9.4	1.11	12.8	1.38	17.1	1.74	24.1	2.00	31.8	2.56	45.8	3.38	60.8	4.43
	20	9.4	1.12	12.8	1.40	17.1	1.75	24.1	2.02	31.8	2.59	45.8	3.42	60.8	4.47
	21	9.4	1.12	12.8	1.44	21.5	2.21	28.8	2.42	36.1	3.11	49.8	3.76	64.6	4.92
	23	16.7	2.08	21.3	2.47	30.3	3.13	38.1	3.48	44.6	4.57	58.0	5.57	72.2	6.77
	25	24.0	3.01	29.7	3.96	39.2	4.64	47.5	5.49	53.1	6.66	66.2	8.42	79.7	9.79
	27	31.2	4.42	38.2	5.63	48.0	7.20	56.8	8.17	61.6	9.71	74.3	11.33	87.3	12.80
	29	38.5	5.73	46.6	7.74	56.9	10.03	66.1	11.29	70.1	12.82	82.5	14.54	94.9	16.95
	31	45.8	7.02	55.1	9.74	65.7	12.56	75.4	14.41	80.2	15.54	90.7	16.76	102.5	19.50
	33	53.1	9.23	63.5	11.99	74.6	14.76	84.8	17.08	89.8	17.85	98.9	19.86	110.0	21.95
	35	60.4	12.08	72.0	15.14	83.6	18.58	89.6	20.41	95.6	22.34	107.2	25.35	117.5	26.40
	37	60.4	12.78	72.0	16.10	83.6	19.71	89.6	21.70	95.6	23.74	107.2	26.75	115.6	27.73
	39	60.4	13.51	72.0	17.02	83.6	21.08	89.6	23.32	95.6	25.51	107.2	28.26	113.7	29.25
	41	58.9	14.94	70.2	18.86	81.5	23.14	87.3	25.57	93.2	28.03	104.5	30.28	109.0	30.98
43	57.4	16.45	68.4	20.59	79.4	25.26	85.1	27.86	90.9	30.63	101.9	32.35	104.5	33.16	
46	53.8	18.30	64.1	23.19	74.5	28.46	79.8	31.01	85.1	34.56	93.2	35.59	95.4	35.93	
48	47.6	15.98	56.7	20.27	65.9	24.89	70.6	27.09	75.3	30.12	80.9	30.19	82.9	30.43	

# 7. Capacity Tables

Cooling Capacity (40HP)

Combination (%)	Outdoor air temp. (DB, °C)	Indoor air temp. (DB/WB, °C)													
		20		23		26		27		28		30		32	
		14		16		18		19		20		22		24	
		TC	PI	TC	PI	TC	PI	TC	PI	TC	PI	TC	PI	TC	PI
70	10	8.2	0.94	11.2	1.17	14.9	1.47	21.0	1.71	27.7	2.18	39.9	2.87	52.9	3.76
	12	8.2	0.95	11.2	1.18	14.9	1.49	21.0	1.72	27.7	2.20	39.9	2.90	52.9	3.80
	14	8.2	0.96	11.2	1.20	14.9	1.50	21.0	1.74	27.7	2.22	39.9	2.93	52.9	3.84
	16	8.2	0.97	11.2	1.21	14.9	1.52	21.0	1.76	27.7	2.24	39.9	2.96	52.9	3.88
	18	8.2	0.98	11.2	1.22	14.9	1.54	21.0	1.78	27.7	2.27	39.9	2.99	52.9	3.92
	20	8.2	0.99	11.2	1.23	14.9	1.55	21.0	1.80	27.7	2.29	39.9	3.02	52.9	3.96
	21	8.2	0.99	13.0	1.45	19.3	2.03	26.0	2.25	32.0	2.75	43.9	3.32	56.9	4.35
	23	11.7	1.49	20.2	2.37	27.0	2.98	35.0	3.23	40.6	4.04	52.2	4.92	64.8	5.98
	25	18.6	2.47	27.3	3.50	34.7	4.10	44.0	5.11	49.2	5.89	60.5	7.44	72.7	8.65
	27	25.4	3.59	34.5	4.98	42.4	6.05	53.0	7.59	57.8	8.59	68.7	10.01	80.6	11.32
	29	32.3	4.56	41.6	6.58	50.1	8.23	62.0	10.33	66.4	11.33	77.0	12.86	88.4	14.98
	31	39.2	5.61	48.7	8.18	57.7	10.30	71.0	12.98	75.0	13.74	85.3	14.82	96.3	17.24
	33	46.0	7.54	55.9	9.95	65.4	11.96	78.4	15.07	83.6	15.78	93.6	17.56	104.0	19.40
	35	52.8	10.32	63.2	12.87	73.2	15.56	78.4	17.02	83.6	18.59	93.6	21.89	104.0	24.00
	37	52.8	10.97	63.2	13.63	73.2	16.54	78.4	18.10	83.6	19.78	93.6	23.29	104.0	25.33
	39	52.8	11.65	63.2	14.53	73.2	17.68	78.4	19.48	83.6	21.37	93.6	24.93	104.0	27.30
	41	51.4	12.88	61.6	15.91	71.3	19.40	76.4	21.37	81.5	23.23	91.2	27.38	101.3	29.43
	43	50.2	14.02	60.1	17.35	69.6	21.16	74.5	23.30	79.4	25.37	88.9	29.91	98.8	31.83
46	47.0	15.58	56.3	19.50	65.2	23.83	69.8	25.95	74.5	28.59	83.4	33.74	92.6	35.50	
48	41.6	13.60	49.8	17.04	57.7	20.84	61.8	22.68	65.9	25.01	73.7	29.52	81.9	30.43	
60	10	7.2	0.81	9.7	1.01	12.9	1.26	18.2	1.47	24.0	1.87	34.5	2.46	45.8	3.23
	12	7.2	0.81	9.7	1.02	12.9	1.28	18.2	1.49	24.0	1.89	34.5	2.49	45.8	3.26
	14	7.2	0.82	9.7	1.03	12.9	1.29	18.2	1.51	24.0	1.91	34.5	2.52	45.8	3.29
	16	7.2	0.83	9.7	1.04	12.9	1.30	18.2	1.52	24.0	1.93	34.5	2.54	45.8	3.33
	18	7.2	0.84	9.7	1.05	12.9	1.32	18.2	1.54	24.0	1.95	34.5	2.57	45.8	3.36
	20	7.2	0.85	9.7	1.06	12.9	1.33	18.2	1.55	24.0	1.97	34.5	2.59	45.8	3.40
	21	7.2	0.85	9.7	1.10	16.1	1.71	21.4	1.88	27.5	2.36	37.5	2.85	48.7	3.74
	23	7.2	0.94	16.0	1.99	22.8	2.56	29.6	2.73	34.6	3.47	43.6	4.23	54.5	5.14
	25	13.4	1.80	22.3	3.00	29.4	3.52	38.1	4.66	41.8	5.05	50.7	6.26	60.3	7.43
	27	19.8	2.62	28.7	4.28	36.1	5.19	46.0	6.49	48.9	7.25	56.9	8.29	66.0	9.56
	29	26.1	3.40	35.0	5.48	42.7	6.92	54.3	8.53	56.1	9.25	63.2	10.40	71.8	12.22
	31	32.4	4.32	41.4	6.55	49.4	8.43	60.9	10.23	63.2	10.74	70.8	11.51	77.6	14.09
	33	38.8	6.02	47.7	7.97	56.0	9.46	65.7	11.47	70.4	12.29	76.4	13.64	83.4	16.04
	35	45.2	8.76	54.0	10.71	62.8	12.84	67.2	13.98	71.6	15.17	80.4	17.73	89.2	20.45
	37	45.2	9.25	54.0	11.31	62.8	13.60	67.2	14.85	71.6	16.10	80.4	18.82	89.2	21.75
	39	45.2	9.83	54.0	12.04	62.8	14.68	67.2	15.93	71.6	17.32	80.4	20.18	89.2	23.31
	41	44.0	10.67	52.6	13.17	61.2	15.94	65.5	17.40	69.8	18.81	78.3	22.14	86.9	25.33
	43	43.0	11.59	51.3	14.34	59.7	17.37	63.9	18.96	68.0	20.51	76.4	24.17	84.8	27.67
46	40.3	12.98	48.1	16.11	55.9	19.54	59.8	21.32	63.8	23.08	71.6	27.24	79.4	31.53	
48	35.6	11.31	42.5	14.06	49.5	17.07	52.9	18.62	56.4	20.16	63.3	23.82	70.3	27.58	
50	10	6.5	0.69	8.8	0.86	12.4	1.09	16.6	1.33	21.9	1.60	31.5	2.12	41.8	2.76
	12	6.5	0.70	8.8	0.87	12.4	1.10	16.6	1.35	21.9	1.62	31.5	2.14	41.8	2.79
	14	6.5	0.71	8.8	0.88	12.4	1.11	16.6	1.36	21.9	1.64	31.5	2.16	41.8	2.82
	16	6.5	0.71	8.8	0.89	12.4	1.12	16.6	1.38	21.9	1.66	31.5	2.18	41.8	2.85
	18	6.5	0.72	8.8	0.90	12.4	1.13	16.6	1.39	21.9	1.67	31.5	2.21	41.8	2.88
	20	6.5	0.73	8.8	0.91	12.4	1.14	16.6	1.40	21.9	1.69	31.5	2.23	41.8	2.90
	21	6.5	0.73	8.8	0.94	15.5	1.47	19.6	1.68	24.9	2.03	34.2	2.45	44.1	3.19
	23	6.5	0.78	14.0	1.61	21.5	2.20	27.7	2.63	31.5	2.98	39.4	3.63	48.7	4.39
	25	11.6	1.42	19.2	2.36	27.4	3.08	36.6	4.26	38.8	4.34	44.6	5.11	53.2	6.21
	27	16.8	2.04	24.4	3.33	34.0	4.29	42.5	5.68	45.1	5.85	49.8	6.69	57.8	7.90
	29	22.1	2.68	29.6	4.29	39.4	5.52	47.8	7.04	51.4	7.55	55.0	8.29	62.4	9.98
	31	27.3	3.40	34.8	5.09	44.8	6.72	52.0	7.86	55.0	8.35	60.1	8.95	66.9	10.98
	33	32.5	4.74	40.0	6.13	50.2	7.54	54.0	8.61	57.3	9.22	65.0	10.61	71.4	12.32
	35	37.8	7.28	45.2	8.76	52.4	10.34	56.0	11.22	59.6	12.10	66.8	13.96	74.4	16.04
	37	37.8	7.72	45.2	9.25	52.4	10.95	56.0	11.88	59.6	12.81	66.8	14.89	74.4	17.02
	39	37.8	8.23	45.2	9.91	52.4	11.73	56.0	12.78	59.6	13.74	66.8	15.86	74.4	18.38
	41	36.8	8.90	44.0	10.73	51.1	12.82	54.6	13.85	58.1	14.89	65.1	17.38	72.5	19.96
	43	35.9	9.67	43.0	11.67	49.8	13.95	53.2	15.08	56.6	16.21	63.5	18.95	70.7	21.78
46	33.7	10.83	40.3	13.09	46.7	15.65	49.9	16.93	53.1	18.20	59.5	21.33	66.3	24.52	
48	29.8	9.44	35.6	11.42	41.3	13.65	44.1	14.78	47.0	15.88	52.6	18.63	58.6	21.43	

**Note**

1. TC: Total Capacity(kW), PI : Power Input(kW, Comp. + Outdoor fan motor)
2. Capacity tables show the average value of conditions which may occur.

# 7. Capacity Tables

◆ ARUM420LTE5

Cooling Capacity (42HP)

Combination (%)	Outdoor air temp. (DB, °C)	Indoor air temp. (DB/WB, °C)													
		20		23		26		27		28		30		32	
		14	16	16	18	19	20	22	24						
130	10	16.6	1.63	22.6	2.03	30.1	2.47	42.5	3.02	56.0	3.77	80.6	5.03	106.9	6.66
	12	16.6	1.64	22.6	2.05	30.1	2.50	42.5	3.05	56.0	3.81	80.6	5.08	106.9	6.73
	14	16.6	1.66	22.6	2.07	30.1	2.52	42.5	3.08	56.0	3.85	80.6	5.13	106.9	6.80
	16	16.6	1.68	22.6	2.10	30.1	2.55	42.5	3.11	56.0	3.89	80.6	5.19	106.9	6.87
	18	16.6	1.70	22.6	2.12	30.1	2.58	42.5	3.14	56.0	3.93	80.6	5.24	106.9	6.94
	20	16.6	1.71	22.6	2.14	30.1	2.60	42.5	3.17	56.0	3.97	80.6	5.29	106.9	7.01
	21	16.6	1.73	22.9	2.20	37.3	3.25	49.5	3.78	62.6	4.87	85.8	6.65	110.3	7.88
	23	28.8	3.07	40.1	4.04	51.8	4.60	64.7	5.12	75.8	7.34	96.5	9.49	117.2	11.18
	25	42.5	4.87	51.5	6.06	66.3	6.88	80.7	8.11	89.0	10.54	107.1	13.79	124.0	16.22
	27	55.5	7.75	65.8	9.16	80.9	10.39	95.8	12.42	102.2	15.77	117.7	19.88	130.9	22.41
	29	68.5	10.77	80.2	12.63	95.4	15.26	111.4	17.97	115.4	21.42	128.5	25.71	137.8	28.61
	31	83.1	14.07	96.4	17.36	112.1	21.06	125.4	24.58	128.6	28.03	135.7	35.21	144.9	35.71
	33	97.7	17.34	114.2	22.65	128.2	27.10	135.5	35.18	138.5	34.94	142.8	35.25	152.4	35.74
	35	116.5	23.42	133.5	28.39	137.8	34.45	140.1	34.62	142.4	34.83	146.3	35.14	150.5	35.28
	37	116.5	24.98	131.6	29.79	135.9	33.99	137.8	34.16	140.1	34.37	144.0	34.68	148.2	34.81
	39	116.5	26.59	129.3	31.36	133.5	33.54	135.9	33.71	137.8	33.91	142.0	34.21	146.3	34.35
41	113.5	28.21	123.9	32.93	128.1	33.08	130.0	33.25	132.5	33.45	136.6	33.75	140.2	33.88	
43	110.7	29.76	118.7	32.46	122.9	32.63	124.7	32.79	127.2	32.99	131.1	33.28	134.7	33.41	
46	103.7	31.85	108.3	31.78	112.2	31.95	114.0	32.11	116.4	32.30	120.0	32.59	123.4	32.72	
48	91.8	30.96	94.1	31.05	97.6	31.12	99.1	31.21	101.3	31.47	104.5	31.67	107.4	31.80	
120	10	15.3	1.52	20.8	1.90	27.8	2.31	39.2	2.82	51.6	3.53	74.3	4.70	98.6	6.23
	12	15.3	1.54	20.8	1.92	27.8	2.34	39.2	2.85	51.6	3.56	74.3	4.75	98.6	6.29
	14	15.3	1.55	20.8	1.94	27.8	2.36	39.2	2.88	51.6	3.60	74.3	4.80	98.6	6.36
	16	15.3	1.57	20.8	1.96	27.8	2.39	39.2	2.91	51.6	3.64	74.3	4.85	98.6	6.42
	18	15.3	1.59	20.8	1.98	27.8	2.41	39.2	2.94	51.6	3.67	74.3	4.90	98.6	6.49
	20	15.3	1.60	20.8	2.00	27.8	2.43	39.2	2.97	51.6	3.71	74.3	4.95	98.6	6.55
	21	15.3	1.62	21.2	2.06	35.2	3.10	45.6	3.54	58.4	4.56	79.6	6.22	102.2	7.38
	23	26.5	2.87	38.0	3.84	50.0	4.41	59.6	4.79	72.2	6.86	90.5	8.88	109.3	10.45
	25	41.3	4.55	53.3	5.76	65.4	6.44	74.3	7.59	86.6	9.86	102.1	12.90	116.3	15.18
	27	57.3	7.20	72.5	8.57	81.2	9.64	88.3	11.53	101.0	14.64	113.7	18.45	123.4	21.13
	29	73.6	9.99	87.3	11.54	96.8	14.16	102.6	16.68	115.3	19.88	125.3	23.86	130.6	26.82
	31	89.1	12.65	105.2	15.25	112.5	18.79	118.1	22.10	130.2	25.21	133.7	30.32	138.2	30.88
	33	103.3	15.59	124.1	19.90	131.5	24.18	133.3	28.05	135.6	33.00	139.3	33.37	143.6	33.64
	35	105.4	20.83	125.3	26.98	132.8	29.85	134.6	35.55	137.0	35.73	140.7	35.83	144.4	36.12
	37	105.4	22.41	125.3	28.47	130.9	31.82	132.8	34.80	134.6	34.98	138.3	35.08	142.1	35.36
	39	105.4	24.12	124.9	30.09	128.6	33.75	130.4	34.09	132.3	34.26	136.5	34.36	140.2	34.63
41	102.7	25.84	119.4	31.71	123.5	33.09	125.2	33.37	127.0	33.54	130.7	33.64	134.4	33.91	
43	100.2	27.58	114.4	31.26	118.4	32.34	120.1	32.66	121.9	32.82	125.5	32.92	129.1	33.18	
46	93.9	29.65	104.3	30.51	108.1	31.33	109.7	31.59	111.4	31.74	114.7	31.84	118.1	32.09	
48	83.0	29.05	90.6	29.97	94.0	30.72	95.4	30.90	96.9	31.00	99.8	31.13	102.8	31.25	
110	10	14.0	1.43	19.1	1.79	25.4	2.17	35.9	2.65	47.3	3.31	68.1	4.42	90.3	5.85
	12	14.0	1.45	19.1	1.80	25.4	2.20	35.9	2.68	47.3	3.35	68.1	4.46	90.3	5.91
	14	14.0	1.46	19.1	1.82	25.4	2.22	35.9	2.71	47.3	3.38	68.1	4.51	90.3	5.97
	16	14.0	1.48	19.1	1.84	25.4	2.24	35.9	2.73	47.3	3.42	68.1	4.56	90.3	6.03
	18	14.0	1.49	19.1	1.86	25.4	2.26	35.9	2.76	47.3	3.45	68.1	4.60	90.3	6.10
	20	14.0	1.51	19.1	1.88	25.4	2.29	35.9	2.79	47.3	3.49	68.1	4.65	90.3	6.16
	21	14.0	1.52	19.1	1.94	31.9	2.86	42.2	3.32	52.6	4.28	73.5	5.85	94.9	6.93
	23	25.0	2.70	31.9	3.61	44.6	4.05	55.0	4.50	66.7	6.45	83.5	8.34	103.2	9.82
	25	36.0	4.28	44.6	5.41	57.4	6.05	67.9	7.13	79.2	9.27	93.4	12.12	111.3	14.26
	27	47.1	6.76	57.4	8.05	70.2	9.06	80.7	10.83	92.3	13.75	104.0	17.34	120.3	19.86
	29	58.1	9.39	70.2	10.84	83.0	13.31	93.8	15.67	105.5	18.68	114.6	21.97	126.9	24.37
	31	70.4	11.89	84.6	14.33	97.6	17.65	107.0	20.77	118.6	23.69	125.2	25.40	131.6	27.35
	33	81.7	14.65	97.6	18.70	110.7	22.72	120.6	25.39	128.2	28.49	132.2	29.28	135.6	29.32
	35	94.4	18.46	112.6	23.74	125.7	27.07	129.3	29.00	131.2	30.79	134.4	31.07	138.0	31.22
	37	94.4	19.56	112.6	25.20	125.7	28.58	127.5	30.73	128.9	32.47	132.6	32.58	135.7	32.67
	39	94.4	21.09	112.6	26.78	123.5	30.15	125.3	32.87	127.1	34.08	130.3	34.14	133.9	34.17
41	92.0	22.62	109.7	28.36	118.2	31.80	120.0	35.55	121.6	35.55	125.1	35.83	128.2	36.12	
43	89.7	23.75	107.0	29.54	113.2	33.72	115.1	34.10	116.6	34.03	120.1	34.22	123.1	34.31	
46	84.1	23.18	100.2	28.52	103.3	32.00	105.1	32.00	106.5	32.28	109.8	32.46	112.6	32.54	
48	74.4	22.51	87.1	27.48	89.8	30.45	91.4	30.65	92.6	30.80	95.5	30.89	98.0	31.01	



# 7. Capacity Tables

Cooling Capacity (42HP)

Combination (%)	Outdoor air temp. (DB, °C)	Indoor air temp. (DB/WB, °C)													
		20		23		26		27		28		30		32	
		14		16		18		19		20		22		24	
		TC	PI	TC	PI	TC	PI	TC	PI	TC	PI	TC	PI	TC	PI
100	10	12.8	1.31	17.5	1.64	23.3	1.99	32.9	2.43	43.4	3.04	62.5	4.05	82.9	5.37
	12	12.8	1.33	17.5	1.66	23.3	2.01	32.9	2.46	43.4	3.07	62.5	4.10	82.9	5.42
	14	12.8	1.34	17.5	1.67	23.3	2.04	32.9	2.48	43.4	3.10	62.5	4.14	82.9	5.48
	16	12.8	1.35	17.5	1.69	23.3	2.06	32.9	2.51	43.4	3.14	62.5	4.18	82.9	5.54
	18	12.8	1.37	17.5	1.71	23.3	2.08	32.9	2.53	43.4	3.17	62.5	4.22	82.9	5.59
	20	12.8	1.38	17.5	1.72	23.3	2.10	32.9	2.56	43.4	3.20	62.5	4.27	82.9	5.65
	21	12.8	1.39	17.5	1.78	29.1	2.62	38.7	3.05	49.5	3.93	67.5	5.36	87.1	6.36
	23	22.2	2.48	30.7	3.31	40.6	3.71	50.9	4.13	61.7	5.92	77.4	7.65	95.6	9.01
	25	31.8	3.92	41.3	4.96	52.2	5.55	63.5	6.54	74.0	8.50	87.3	11.12	104.0	13.08
	27	41.3	6.20	52.0	7.38	63.8	8.31	75.4	9.94	86.3	12.62	97.2	15.91	112.4	18.22
	29	50.8	8.61	62.7	9.95	75.4	12.21	87.7	14.38	98.6	17.13	107.1	20.57	120.9	22.35
	31	60.3	10.91	73.4	13.15	86.9	16.20	100.0	19.05	110.8	21.73	117.0	23.78	130.3	25.34
	33	69.8	13.44	84.0	17.16	98.5	20.85	112.2	24.18	123.2	26.40	127.1	26.86	130.3	27.45
	35	79.4	16.19	94.5	20.67	110.0	25.69	117.6	28.44	123.2	28.61	127.1	28.72	130.3	28.95
	37	79.4	17.34	94.5	22.17	110.0	27.21	117.6	29.79	121.2	29.94	124.7	30.06	127.7	30.34
	39	79.4	18.59	94.5	23.81	110.0	28.83	117.6	31.25	119.2	31.39	122.7	31.51	125.6	31.80
41	78.1	19.84	93.0	25.46	108.3	30.46	112.8	32.71	115.3	32.84	118.0	32.95	121.9	33.26	
43	75.4	21.00	89.8	26.99	104.6	31.91	108.2	33.96	109.4	34.08	112.8	34.19	115.8	34.51	
46	70.7	22.58	84.2	29.10	98.0	33.85	98.8	35.55	99.9	35.65	103.1	35.76	105.8	36.10	
48	62.5	19.50	74.4	25.17	84.6	28.94	85.8	30.16	86.7	30.26	89.6	30.33	92.0	30.57	
90	10	11.5	1.21	15.7	1.51	21.0	1.89	29.0	2.16	39.1	2.80	56.2	3.69	74.6	4.83
	12	11.5	1.22	15.7	1.52	21.0	1.91	29.0	2.19	39.1	2.83	56.2	3.73	74.6	4.88
	14	11.5	1.23	15.7	1.54	21.0	1.93	29.0	2.21	39.1	2.86	56.2	3.77	74.6	4.93
	16	11.5	1.25	15.7	1.55	21.0	1.95	29.0	2.23	39.1	2.88	56.2	3.81	74.6	4.98
	18	11.5	1.26	15.7	1.57	21.0	1.97	29.0	2.26	39.1	2.91	56.2	3.84	74.6	5.03
	20	11.5	1.27	15.7	1.59	21.0	1.99	29.0	2.28	39.1	2.94	56.2	3.88	74.6	5.08
	21	11.5	1.28	15.7	1.60	26.3	2.51	34.4	2.70	44.0	3.53	60.8	4.27	78.5	5.59
	23	15.7	1.99	23.2	2.75	36.8	3.56	44.6	3.88	53.8	5.19	69.8	6.33	86.5	7.69
	25	24.9	3.36	33.5	4.42	47.2	5.27	54.8	6.13	63.6	7.57	78.9	9.56	94.4	11.12
	27	34.2	4.93	43.9	6.29	57.6	8.18	65.0	9.11	73.5	11.04	88.0	12.87	102.4	14.55
	29	43.5	6.66	54.2	8.64	68.0	11.40	75.2	12.60	83.3	14.57	97.1	16.53	110.4	19.26
	31	52.7	8.34	64.6	11.10	78.4	14.27	85.4	16.08	93.1	18.15	106.1	19.24	118.4	22.38
	33	62.0	10.73	74.9	13.65	88.9	17.30	95.6	19.07	102.9	21.10	115.2	22.80	126.4	25.00
	35	71.4	13.29	85.3	16.80	99.1	20.78	105.8	22.92	112.6	24.91	124.2	26.73	126.4	27.34
	37	71.4	14.11	85.3	17.87	99.1	22.15	105.8	24.34	112.6	26.30	122.2	27.94	124.4	28.57
	39	71.4	14.93	85.3	19.01	99.1	23.45	105.8	25.90	112.6	27.66	120.2	29.46	122.4	29.81
41	69.6	16.71	83.1	21.08	96.6	25.74	103.1	28.33	109.7	29.86	115.2	31.04	117.3	31.76	
43	67.9	18.04	81.0	22.78	94.2	28.11	100.6	30.51	107.0	32.01	110.5	33.16	112.5	33.64	
46	63.6	20.30	75.9	25.94	88.3	32.03	94.3	34.59	97.2	35.57	100.9	35.76	102.7	36.10	
48	56.3	17.75	67.2	22.69	78.1	28.02	83.4	30.16	84.4	30.26	87.6	30.33	89.3	30.57	
80	10	9.9	1.07	13.5	1.33	18.0	1.67	25.4	1.93	33.4	2.47	48.1	3.26	63.8	4.27
	12	9.9	1.08	13.5	1.35	18.0	1.69	25.4	1.95	33.4	2.50	48.1	3.30	63.8	4.31
	14	9.9	1.09	13.5	1.36	18.0	1.71	25.4	1.97	33.4	2.52	48.1	3.33	63.8	4.36
	16	9.9	1.10	13.5	1.37	18.0	1.73	25.4	1.99	33.4	2.55	48.1	3.36	63.8	4.40
	18	9.9	1.11	13.5	1.39	18.0	1.74	25.4	2.01	33.4	2.58	48.1	3.40	63.8	4.45
	20	9.9	1.12	13.5	1.40	18.0	1.76	25.4	2.03	33.4	2.60	48.1	3.43	63.8	4.49
	21	9.9	1.13	13.5	1.44	22.6	2.22	30.3	2.43	37.9	3.12	52.3	3.78	67.8	4.94
	23	17.5	2.08	22.4	2.48	31.8	3.15	40.0	3.49	46.8	4.59	60.9	5.59	75.8	6.80
	25	25.2	3.02	31.2	3.98	41.1	4.66	49.8	5.52	55.7	6.69	69.5	8.45	83.7	9.83
	27	32.8	4.44	40.1	5.66	50.4	7.23	59.6	8.20	64.7	9.76	78.1	11.38	91.7	12.86
	29	40.5	5.76	49.0	7.78	59.7	10.08	69.4	11.34	73.6	12.88	86.6	14.61	99.6	17.03
	31	48.1	7.05	57.8	9.79	69.0	12.62	79.2	14.47	84.2	15.61	95.2	16.84	107.6	19.59
	33	55.7	9.27	66.7	12.04	78.3	14.83	89.0	17.16	94.2	17.93	103.8	19.95	115.5	22.05
	35	63.4	12.14	75.6	15.21	87.8	18.67	94.1	20.50	100.4	22.44	112.6	25.46	123.4	26.52
	37	63.4	12.84	75.6	16.17	87.8	19.80	94.1	21.80	100.4	23.85	112.6	26.87	121.4	27.86
	39	63.4	13.57	75.6	17.10	87.8	21.18	94.1	23.43	100.4	25.63	112.6	28.39	119.4	29.39
41	61.8	15.01	73.7	18.95	85.5	23.24	91.7	25.68	97.8	28.16	109.7	30.42	114.4	31.12	
43	60.3	16.52	71.8	20.68	83.4	25.37	89.4	27.99	95.4	30.77	107.0	32.50	109.7	33.31	
46	56.5	18.38	67.3	23.29	78.2	28.59	83.8	31.15	89.4	34.72	97.8	35.76	100.1	36.10	
48	50.0	16.06	59.6	20.37	69.2	25.00	74.1	27.21	79.1	30.26	85.0	30.33	87.0	30.57	

# 7. Capacity Tables

Cooling Capacity (42HP)

Combination (%)	Outdoor air temp. (DB, °C)	Indoor air temp. (DB/WB, °C)													
		20		23		26		27		28		30		32	
		14		16		18		19		20		22		24	
		TC	PI	TC	PI	TC	PI	TC	PI	TC	PI	TC	PI	TC	PI
70	10	8.6	0.94	11.7	1.18	15.6	1.48	22.1	1.71	29.1	2.19	41.9	2.88	55.5	3.77
	12	8.6	0.95	11.7	1.19	15.6	1.50	22.1	1.73	29.1	2.21	41.9	2.91	55.5	3.81
	14	8.6	0.96	11.7	1.20	15.6	1.51	22.1	1.75	29.1	2.23	41.9	2.94	55.5	3.85
	16	8.6	0.97	11.7	1.21	15.6	1.53	22.1	1.77	29.1	2.25	41.9	2.97	55.5	3.89
	18	8.6	0.98	11.7	1.23	15.6	1.54	22.1	1.79	29.1	2.28	41.9	3.00	55.5	3.93
	20	8.6	0.99	11.7	1.24	15.6	1.56	22.1	1.80	29.1	2.30	41.9	3.03	55.5	3.97
	21	8.6	1.00	13.7	1.46	20.3	2.04	27.3	2.26	33.6	2.76	46.1	3.34	59.8	4.37
	23	12.3	1.50	21.2	2.38	28.4	2.99	36.8	3.25	42.6	4.06	54.8	4.94	68.0	6.01
	25	19.5	2.48	28.7	3.52	36.4	4.12	46.2	5.13	51.7	5.91	63.5	7.47	76.3	8.69
	27	26.7	3.61	36.2	5.00	44.5	6.08	55.7	7.63	60.7	8.63	72.2	10.06	84.6	11.37
	29	33.9	4.58	43.7	6.61	52.6	8.26	65.1	10.38	69.7	11.39	80.9	12.92	92.9	15.05
	31	41.1	5.63	51.2	8.22	60.6	10.34	74.6	13.04	78.8	13.80	89.5	14.89	101.1	17.32
	33	48.3	7.58	58.7	10.00	68.7	12.01	82.3	15.14	87.8	15.85	98.3	17.64	109.2	19.49
	35	55.4	10.37	66.4	12.93	76.9	15.64	82.3	17.10	87.8	18.68	98.3	21.99	109.2	24.11
	37	55.4	11.02	66.4	13.69	76.9	16.61	82.3	18.19	87.8	19.87	98.3	23.40	109.2	25.44
	39	55.4	11.70	66.4	14.59	76.9	17.76	82.3	19.57	87.8	21.47	98.3	25.04	109.2	27.43
41	54.0	12.94	64.7	15.99	74.9	19.49	80.2	21.46	85.5	23.34	95.8	27.51	106.4	29.56	
43	52.7	14.08	63.1	17.42	73.0	21.26	78.2	23.40	83.4	25.48	93.4	30.05	103.8	31.98	
46	49.4	15.65	59.1	19.59	68.5	23.94	73.3	26.07	78.2	28.73	87.5	33.89	97.3	35.66	
48	43.7	13.66	52.3	17.11	60.6	20.93	64.9	22.78	69.2	25.13	77.4	29.66	86.0	30.57	
60	10	7.6	0.82	10.1	1.03	13.5	1.29	19.1	1.51	25.2	1.91	36.2	2.52	48.1	3.30
	12	7.6	0.83	10.1	1.04	13.5	1.31	19.1	1.52	25.2	1.93	36.2	2.55	48.1	3.33
	14	7.6	0.84	10.1	1.05	13.5	1.32	19.1	1.54	25.2	1.95	36.2	2.57	48.1	3.37
	16	7.6	0.85	10.1	1.06	13.5	1.33	19.1	1.56	25.2	1.97	36.2	2.60	48.1	3.40
	18	7.6	0.86	10.1	1.07	13.5	1.35	19.1	1.57	25.2	1.99	36.2	2.63	48.1	3.44
	20	7.6	0.87	10.1	1.08	13.5	1.36	19.1	1.59	25.2	2.01	36.2	2.65	48.1	3.47
	21	7.6	0.87	10.1	1.12	16.9	1.75	22.4	1.93	28.9	2.41	39.3	2.92	51.1	3.82
	23	7.6	0.96	16.8	2.04	23.9	2.61	31.1	2.79	36.4	3.55	45.8	4.32	57.2	5.26
	25	14.1	1.84	23.5	3.07	30.9	3.60	40.0	4.77	43.9	5.17	53.2	6.40	63.3	7.60
	27	20.7	2.68	30.1	4.37	37.9	5.31	48.3	6.64	51.4	7.42	59.8	8.48	69.3	9.78
	29	27.4	3.48	36.8	5.60	44.9	7.08	57.0	8.72	58.9	9.46	66.3	10.64	75.4	12.50
	31	34.1	4.42	43.4	6.70	51.9	8.62	64.0	10.47	66.4	10.98	74.3	11.77	81.5	14.41
	33	40.7	6.15	50.1	8.15	58.8	9.68	69.0	11.73	73.9	12.57	80.2	13.95	87.5	16.41
	35	47.5	8.80	56.7	10.76	65.9	12.89	70.6	14.04	75.2	15.24	84.4	17.81	93.7	20.54
	37	47.5	9.29	56.7	11.36	65.9	13.66	70.6	14.92	75.2	16.17	84.4	18.90	93.7	21.85
	39	47.5	9.88	56.7	12.09	65.9	14.74	70.6	16.00	75.2	17.40	84.4	20.27	93.7	23.42
41	46.2	10.71	55.2	13.24	64.3	16.01	68.8	17.48	73.3	18.89	82.3	22.25	91.3	25.45	
43	45.1	11.64	53.9	14.41	62.7	17.45	67.1	19.05	71.4	20.60	80.2	24.28	89.0	27.80	
46	42.3	13.04	50.5	16.18	58.7	19.63	62.8	21.41	67.0	23.18	75.2	27.36	83.4	31.67	
48	37.4	11.36	44.7	14.12	51.9	17.15	55.6	18.70	59.2	20.26	66.5	23.93	73.8	27.71	
50	10	6.8	0.72	9.3	0.90	13.1	1.13	17.5	1.39	23.0	1.67	33.1	2.21	43.9	2.88
	12	6.8	0.73	9.3	0.91	13.1	1.15	17.5	1.41	23.0	1.69	33.1	2.23	43.9	2.91
	14	6.8	0.74	9.3	0.92	13.1	1.16	17.5	1.42	23.0	1.71	33.1	2.25	43.9	2.94
	16	6.8	0.75	9.3	0.93	13.1	1.17	17.5	1.43	23.0	1.73	33.1	2.28	43.9	2.97
	18	6.8	0.75	9.3	0.94	13.1	1.18	17.5	1.45	23.0	1.74	33.1	2.30	43.9	3.00
	20	6.8	0.76	9.3	0.95	13.1	1.19	17.5	1.46	23.0	1.76	33.1	2.32	43.9	3.03
	21	6.8	0.76	9.3	0.98	16.3	1.53	20.6	1.76	26.2	2.11	35.9	2.56	46.3	3.33
	23	6.8	0.81	14.7	1.67	22.5	2.29	29.1	2.74	33.1	3.11	41.4	3.79	51.1	4.58
	25	12.2	1.48	20.2	2.47	28.8	3.21	38.5	4.44	40.7	4.53	46.9	5.33	55.9	6.47
	27	17.7	2.12	25.6	3.47	35.7	4.47	44.6	5.92	47.3	6.10	52.3	6.98	60.7	8.24
	29	23.2	2.79	31.1	4.47	41.4	5.75	50.2	7.35	53.9	7.87	57.8	8.65	65.5	10.41
	31	28.6	3.55	36.5	5.31	47.1	7.01	54.6	8.19	57.7	8.71	63.1	9.34	70.3	11.45
	33	34.1	4.94	42.0	6.40	52.8	7.87	56.7	8.98	60.2	9.62	68.3	11.06	75.0	12.85
	35	39.7	7.31	47.5	8.80	55.0	10.39	58.8	11.27	62.6	12.15	70.1	14.02	78.1	16.11
	37	39.7	7.75	47.5	9.29	55.0	11.00	58.8	11.93	62.6	12.87	70.1	14.95	78.1	17.10
	39	39.7	8.27	47.5	9.96	55.0	11.78	58.8	12.84	62.6	13.80	70.1	15.93	78.1	18.47
41	38.7	8.94	46.2	10.78	53.6	12.88	57.3	13.91	61.0	14.96	68.3	17.46	76.1	20.06	
43	37.7	9.72	45.1	11.73	52.3	14.02	55.9	15.15	59.5	16.28	66.7	19.04	74.2	21.88	
46	35.3	10.88	42.3	13.15	49.0	15.72	52.4	17.01	55.7	18.28	62.5	21.42	69.6	24.63	
48	31.3	9.49	37.4	11.47	43.3	13.72	46.3	14.84	49.3	15.95	55.3	18.72	61.5	21.53	

**Note**

1. TC: Total Capacity(kW), PI : Power Input(kW, Comp. + Outdoor fan motor)
2. Capacity tables show the average value of conditions which may occur.

# 7. Capacity Tables

◆ ARUM440LTE5

Cooling Capacity (44HP)

Combination (%)	Outdoor air temp. (DB, °C)	Indoor air temp. (DB/WB, °C)													
		20		23		26		27		28		30		32	
		14	16	18	19	20	22	24	TC	PI	TC	PI	TC	PI	
130	10	17.3	1.73	23.6	2.16	31.5	2.62	44.5	3.20	58.7	4.00	84.4	5.33	112.0	7.06
	12	17.3	1.74	23.6	2.18	31.5	2.65	44.5	3.23	58.7	4.04	84.4	5.39	112.0	7.13
	14	17.3	1.76	23.6	2.20	31.5	2.68	44.5	3.27	58.7	4.08	84.4	5.44	112.0	7.21
	16	17.3	1.78	23.6	2.22	31.5	2.71	44.5	3.30	58.7	4.12	84.4	5.50	112.0	7.28
	18	17.3	1.80	23.6	2.25	31.5	2.73	44.5	3.33	58.7	4.17	84.4	5.56	112.0	7.36
	20	17.3	1.82	23.6	2.27	31.5	2.76	44.5	3.37	58.7	4.21	84.4	5.61	112.0	7.43
	21	17.3	1.83	24.0	2.34	39.0	3.45	51.9	4.01	65.6	5.17	89.9	7.05	115.5	8.36
	23	30.1	3.26	42.0	4.28	54.3	4.88	67.8	5.43	79.4	7.78	101.0	10.07	122.7	11.86
	25	44.5	5.16	54.0	6.42	69.5	7.30	84.5	8.60	93.2	11.19	112.2	14.63	129.9	17.21
	27	58.1	8.23	69.0	9.71	84.7	11.02	100.4	13.18	107.0	16.73	123.3	21.09	137.1	23.77
	29	71.7	11.42	84.0	13.40	100.0	16.19	116.7	19.06	120.9	22.72	134.6	27.27	144.4	30.35
	31	87.0	14.92	101.0	18.41	117.5	22.34	131.4	26.08	134.7	29.74	142.1	37.36	151.8	37.89
	33	102.4	18.39	119.7	24.03	134.4	28.75	142.0	37.32	145.1	37.06	149.6	37.39	159.7	37.92
	35	122.0	24.85	139.8	30.12	144.3	36.54	146.8	36.73	149.2	36.95	153.2	37.28	157.7	37.42
	37	122.0	26.49	137.9	31.60	142.3	36.06	144.3	36.24	146.8	36.46	150.8	36.79	155.3	36.93
	39	122.0	28.21	135.4	33.27	139.8	35.58	142.3	35.76	144.3	35.97	148.8	36.29	153.2	36.44
41	118.9	29.93	129.8	34.93	134.2	35.09	136.2	35.27	138.9	35.48	143.1	35.80	146.9	35.94	
43	116.0	31.57	124.4	34.44	128.7	34.61	130.7	34.79	133.3	34.99	137.4	35.31	141.1	35.45	
46	108.7	33.79	113.5	33.72	117.6	33.89	119.4	34.06	121.9	34.26	125.8	34.57	129.2	34.71	
48	96.1	32.85	98.6	32.94	102.2	33.01	103.9	33.10	106.1	33.39	109.5	33.60	112.5	33.73	
120	10	16.0	1.61	21.8	2.02	29.1	2.45	41.1	2.99	54.1	3.74	77.9	4.99	103.3	6.60
	12	16.0	1.63	21.8	2.04	29.1	2.48	41.1	3.02	54.1	3.78	77.9	5.04	103.3	6.67
	14	16.0	1.65	21.8	2.06	29.1	2.50	41.1	3.06	54.1	3.82	77.9	5.09	103.3	6.74
	16	16.0	1.67	21.8	2.08	29.1	2.53	41.1	3.09	54.1	3.86	77.9	5.15	103.3	6.81
	18	16.0	1.68	21.8	2.10	29.1	2.56	41.1	3.12	54.1	3.90	77.9	5.20	103.3	6.88
	20	16.0	1.70	21.8	2.12	29.1	2.58	41.1	3.15	54.1	3.94	77.9	5.25	103.3	6.95
	21	16.0	1.72	22.2	2.19	36.8	3.29	47.8	3.75	61.1	4.84	83.4	6.60	107.0	7.82
	23	27.7	3.05	39.8	4.07	52.4	4.68	62.4	5.08	75.7	7.28	94.8	9.42	114.5	11.09
	25	43.2	4.83	55.9	6.11	68.6	6.83	77.8	8.05	90.7	10.46	107.0	13.68	121.9	16.10
	27	60.1	7.63	76.0	9.09	85.1	10.23	92.5	12.23	105.8	15.53	119.1	19.58	129.3	22.42
	29	77.1	10.60	91.5	12.24	101.4	15.02	107.5	17.69	120.8	21.09	131.2	25.31	136.8	28.46
	31	93.4	13.42	110.2	16.18	117.9	19.93	123.7	23.45	136.4	26.74	140.1	32.16	144.8	32.76
	33	108.2	16.54	130.0	21.11	137.7	25.65	139.6	29.75	142.0	35.00	145.9	35.40	150.5	35.69
	35	110.4	22.10	131.3	28.62	139.1	31.66	141.0	37.71	143.5	37.90	147.4	38.01	151.2	38.32
	37	110.4	23.77	131.3	30.20	137.1	33.76	139.1	36.92	141.0	37.10	144.9	37.22	148.8	37.51
	39	110.4	25.59	130.8	31.92	134.7	35.80	136.7	36.16	138.6	36.34	143.0	36.45	146.9	36.74
41	107.6	27.41	125.1	33.64	129.3	35.10	131.2	35.40	133.1	35.58	136.9	35.69	140.8	35.97	
43	104.9	29.25	119.9	33.16	124.0	34.31	125.8	34.64	127.7	34.82	131.4	34.92	135.2	35.20	
46	98.3	31.46	109.3	32.37	113.3	33.23	114.9	33.51	116.7	33.67	120.2	33.77	123.8	34.04	
48	87.0	30.81	94.9	31.80	98.4	32.59	99.9	32.78	101.5	32.89	104.6	33.02	107.7	33.15	
110	10	14.7	1.52	20.0	1.89	26.6	2.31	37.6	2.81	49.6	3.51	71.3	4.69	94.6	6.21
	12	14.7	1.53	20.0	1.91	26.6	2.33	37.6	2.84	49.6	3.55	71.3	4.74	94.6	6.27
	14	14.7	1.55	20.0	1.93	26.6	2.35	37.6	2.87	49.6	3.59	71.3	4.79	94.6	6.34
	16	14.7	1.57	20.0	1.95	26.6	2.38	37.6	2.90	49.6	3.63	71.3	4.84	94.6	6.40
	18	14.7	1.58	20.0	1.97	26.6	2.40	37.6	2.93	49.6	3.66	71.3	4.88	94.6	6.47
	20	14.7	1.60	20.0	1.99	26.6	2.43	37.6	2.96	49.6	3.70	71.3	4.93	94.6	6.53
	21	14.7	1.61	20.0	2.05	33.4	3.03	44.2	3.52	55.1	4.54	77.0	6.20	99.5	7.35
	23	26.2	2.86	33.4	3.83	46.8	4.29	57.6	4.77	69.9	6.84	87.5	8.85	108.1	10.42
	25	37.8	4.54	46.8	5.74	60.1	6.42	71.2	7.56	83.0	9.83	97.8	12.86	116.6	15.13
	27	49.3	7.17	60.1	8.54	73.5	9.61	84.6	11.49	96.7	14.59	108.9	18.39	126.0	21.06
	29	60.8	9.96	73.5	11.50	86.9	14.12	98.3	16.62	110.5	19.81	120.0	23.31	133.0	25.85
	31	73.8	12.61	88.6	15.20	102.3	18.73	112.1	22.03	124.3	25.13	131.1	26.95	137.9	29.01
	33	85.6	15.54	102.3	19.84	115.9	24.10	126.4	26.93	134.3	30.23	138.5	31.06	142.0	31.10
	35	98.9	19.58	117.9	25.19	131.7	28.72	135.5	30.77	137.4	32.66	140.7	32.96	144.6	33.12
	37	98.9	20.75	117.9	26.73	131.7	30.32	133.6	32.60	135.0	34.45	138.9	34.57	142.2	34.66
	39	98.9	22.37	117.9	28.41	129.3	31.99	131.2	34.87	133.2	36.15	136.5	36.21	140.3	36.25
41	96.4	23.99	114.9	30.08	123.8	33.73	125.7	37.71	127.4	37.71	131.1	38.01	134.4	38.32	
43	94.0	25.19	112.1	31.34	118.6	35.77	120.6	36.18	122.2	36.10	125.8	36.30	129.0	36.40	
46	88.1	24.59	105.0	30.26	108.2	33.95	110.1	33.95	111.6	34.24	115.0	34.43	118.0	34.52	
48	77.9	23.88	91.3	29.15	94.0	32.30	95.7	32.52	97.0	32.67	100.0	32.77	102.6	32.90	

# 7. Capacity Tables

Cooling Capacity (44HP)

Combination (%)	Outdoor air temp. (DB, °C)	Indoor air temp. (DB/WB, °C)													
		20		23		26		27		28		30		32	
		14		16		18		19		20		22		24	
		TC	PI	TC	PI	TC	PI	TC	PI	TC	PI	TC	PI	TC	PI
100	10	13.4	1.39	18.3	1.74	24.4	2.11	34.5	2.58	45.5	3.22	65.5	4.30	86.8	5.69
	12	13.4	1.41	18.3	1.76	24.4	2.14	34.5	2.61	45.5	3.26	65.5	4.35	86.8	5.75
	14	13.4	1.42	18.3	1.77	24.4	2.16	34.5	2.63	45.5	3.29	65.5	4.39	86.8	5.81
	16	13.4	1.44	18.3	1.79	24.4	2.18	34.5	2.66	45.5	3.33	65.5	4.44	86.8	5.87
	18	13.4	1.45	18.3	1.81	24.4	2.20	34.5	2.69	45.5	3.36	65.5	4.48	86.8	5.93
	20	13.4	1.47	18.3	1.83	24.4	2.23	34.5	2.72	45.5	3.39	65.5	4.53	86.8	5.99
	21	13.4	1.48	18.3	1.88	30.5	2.78	40.5	3.23	51.8	4.17	70.7	5.69	91.3	6.74
	23	23.3	2.63	32.1	3.51	42.6	3.94	53.4	4.38	64.7	6.28	81.0	8.12	100.1	9.56
	25	33.3	4.16	43.3	5.27	54.7	5.89	66.5	6.94	77.5	9.02	91.4	11.80	108.9	13.88
	27	43.2	6.58	54.5	7.83	66.8	8.82	79.0	10.54	90.4	13.38	101.8	16.88	117.8	19.32
	29	53.2	9.14	65.7	10.55	78.9	12.95	91.9	15.25	103.3	18.18	112.2	21.82	126.6	23.71
	31	63.1	11.57	76.9	13.95	91.1	17.18	104.7	20.21	116.1	23.05	122.5	25.23	136.5	26.88
	33	73.1	14.26	88.1	18.20	103.2	22.11	117.5	25.65	129.1	28.01	133.1	28.50	136.5	29.12
	35	83.2	17.17	99.0	21.93	115.3	27.25	123.2	30.17	129.1	30.35	133.1	30.47	136.5	30.71
	37	83.2	18.39	99.0	23.52	115.3	28.87	123.2	31.61	127.0	31.76	130.7	31.89	133.8	32.18
	39	83.2	19.72	99.0	25.26	115.3	30.59	123.2	33.15	124.9	33.30	128.6	33.42	131.6	33.73
	41	81.8	21.05	97.4	27.01	113.5	32.31	118.2	34.70	120.8	34.83	123.6	34.96	127.7	35.28
43	79.0	22.27	94.1	28.63	109.6	33.86	113.3	36.02	114.6	36.15	118.2	36.27	121.3	36.61	
46	74.1	23.96	88.2	30.87	102.7	35.91	103.5	37.71	104.6	37.82	108.0	37.93	110.9	38.29	
48	65.5	20.69	78.0	26.71	88.6	30.70	89.9	32.00	90.9	32.10	93.9	32.17	96.4	32.43	
90	10	12.1	1.28	16.5	1.60	22.0	2.01	30.4	2.30	40.9	2.97	58.9	3.91	78.1	5.12
	12	12.1	1.29	16.5	1.62	22.0	2.03	30.4	2.32	40.9	3.00	58.9	3.95	78.1	5.18
	14	12.1	1.31	16.5	1.63	22.0	2.05	30.4	2.34	40.9	3.03	58.9	4.00	78.1	5.23
	16	12.1	1.32	16.5	1.65	22.0	2.07	30.4	2.37	40.9	3.06	58.9	4.04	78.1	5.29
	18	12.1	1.33	16.5	1.67	22.0	2.09	30.4	2.39	40.9	3.09	58.9	4.08	78.1	5.34
	20	12.1	1.35	16.5	1.68	22.0	2.11	30.4	2.42	40.9	3.12	58.9	4.12	78.1	5.39
	21	12.1	1.36	16.5	1.70	27.6	2.66	36.0	2.86	46.1	3.75	63.6	4.53	82.2	5.93
	23	16.4	2.11	24.3	2.92	38.5	3.78	46.7	4.12	56.4	5.51	73.2	6.71	90.6	8.16
	25	26.1	3.56	35.1	4.69	49.4	5.59	57.4	6.50	66.7	8.03	82.7	10.14	98.9	11.80
	27	35.8	5.23	46.0	6.67	60.3	8.68	68.1	9.67	77.0	11.71	92.2	13.66	107.3	15.44
	29	45.5	7.07	56.8	9.17	71.3	12.09	78.8	13.37	87.2	15.46	101.7	17.53	115.6	20.43
	31	55.2	8.84	67.6	11.77	82.2	15.14	89.5	17.06	97.5	19.25	111.2	20.41	124.0	23.74
	33	65.0	11.39	78.5	14.49	93.1	18.35	100.2	20.23	107.8	22.38	120.7	24.19	132.4	26.52
	35	74.8	14.10	89.3	17.83	103.8	22.04	110.9	24.31	117.9	26.43	130.2	28.35	132.4	29.00
	37	74.8	14.96	89.3	18.96	103.8	23.50	110.9	25.82	117.9	27.90	128.1	29.64	130.3	30.30
	39	74.8	15.84	89.3	20.17	103.8	24.87	110.9	27.48	117.9	29.34	126.0	31.25	128.2	31.62
	41	72.9	17.73	87.0	22.36	101.2	27.30	108.0	30.05	114.9	31.67	120.7	32.93	122.9	33.69
43	71.1	19.14	84.9	24.16	98.7	29.82	105.4	32.37	112.1	33.96	115.7	35.18	117.8	35.69	
46	66.6	21.54	79.5	27.52	92.5	33.98	98.7	36.70	101.8	37.73	105.7	37.93	107.6	38.29	
48	58.9	18.82	70.4	24.07	81.8	29.73	87.4	32.00	88.4	32.10	91.8	32.17	93.6	32.43	
80	10	10.4	1.13	14.1	1.41	18.8	1.78	26.6	2.04	35.0	2.62	50.4	3.46	66.8	4.53
	12	10.4	1.14	14.1	1.43	18.8	1.79	26.6	2.06	35.0	2.65	50.4	3.50	66.8	4.58
	14	10.4	1.16	14.1	1.44	18.8	1.81	26.6	2.09	35.0	2.68	50.4	3.53	66.8	4.63
	16	10.4	1.17	14.1	1.46	18.8	1.83	26.6	2.11	35.0	2.71	50.4	3.57	66.8	4.67
	18	10.4	1.18	14.1	1.47	18.8	1.85	26.6	2.13	35.0	2.73	50.4	3.60	66.8	4.72
	20	10.4	1.19	14.1	1.49	18.8	1.87	26.6	2.15	35.0	2.76	50.4	3.64	66.8	4.77
	21	10.4	1.20	14.1	1.53	23.6	2.36	31.7	2.58	39.7	3.31	54.8	4.01	71.1	5.25
	23	18.4	2.21	23.4	2.63	33.4	3.34	41.9	3.70	49.0	4.87	63.8	5.93	79.4	7.21
	25	26.4	3.20	32.7	4.22	43.1	4.94	52.2	5.85	58.4	7.10	72.8	8.97	87.7	10.43
	27	34.4	4.71	42.0	6.01	52.8	7.67	62.5	8.70	67.8	10.35	81.8	12.07	96.0	13.64
	29	42.4	6.11	51.3	8.25	62.6	10.69	72.7	12.03	77.1	13.66	90.8	15.50	104.4	18.06
	31	50.4	7.48	60.6	10.38	72.3	13.38	83.0	15.35	88.2	16.56	99.8	17.86	112.7	20.78
	33	58.4	9.84	69.9	12.78	82.0	15.73	93.3	18.21	98.7	19.03	108.8	21.17	121.0	23.39
	35	66.4	12.88	79.2	16.14	92.0	19.80	98.6	21.75	105.2	23.81	117.9	27.01	129.3	28.13
	37	66.4	13.62	79.2	17.16	92.0	21.00	98.6	23.12	105.2	25.30	117.9	28.51	127.2	29.55
	39	66.4	14.40	79.2	18.14	92.0	22.47	98.6	24.86	105.2	27.18	117.9	30.12	125.1	31.18
	41	64.7	15.92	77.2	20.10	89.6	24.66	96.0	27.25	102.5	29.87	114.9	32.27	119.9	33.01
43	63.1	17.53	75.3	21.94	87.4	26.92	93.7	29.69	99.9	32.64	112.1	34.48	114.9	35.33	
46	59.2	19.50	70.5	24.71	81.9	30.33	87.8	33.05	93.7	36.83	102.5	37.93	104.9	38.29	
48	52.3	17.03	62.4	21.61	72.4	26.52	77.6	28.87	82.8	32.10	89.0	32.17	91.1	32.43	

# 7. Capacity Tables

Cooling Capacity (44HP)

Combination (%)	Outdoor air temp. (DB, °C)	Indoor air temp. (DB/WB, °C)													
		20		23		26		27		28		30		32	
		14	16	18	19	20	22	24	TC	PI	TC	PI	TC	PI	
70	10	9.0	1.00	12.3	1.25	16.4	1.57	23.1	1.82	30.5	2.32	43.9	3.06	58.2	4.00
	12	9.0	1.01	12.3	1.26	16.4	1.59	23.1	1.84	30.5	2.34	43.9	3.09	58.2	4.05
	14	9.0	1.02	12.3	1.28	16.4	1.60	23.1	1.86	30.5	2.37	43.9	3.12	58.2	4.09
	16	9.0	1.03	12.3	1.29	16.4	1.62	23.1	1.88	30.5	2.39	43.9	3.15	58.2	4.13
	18	9.0	1.04	12.3	1.30	16.4	1.64	23.1	1.90	30.5	2.42	43.9	3.19	58.2	4.17
	20	9.0	1.05	12.3	1.32	16.4	1.65	23.1	1.91	30.5	2.44	43.9	3.22	58.2	4.22
	21	9.0	1.06	14.3	1.55	21.3	2.17	28.6	2.40	35.2	2.93	48.3	3.54	62.6	4.64
	23	12.9	1.59	22.2	2.52	29.7	3.17	38.5	3.45	44.7	4.30	57.4	5.25	71.3	6.38
	25	20.5	2.63	30.0	3.73	38.2	4.37	48.4	5.44	54.1	6.27	66.5	7.93	79.9	9.22
	27	28.0	3.83	37.9	5.31	46.6	6.44	58.3	8.09	63.6	9.15	75.6	10.67	88.6	12.06
	29	35.5	4.86	45.8	7.01	55.1	8.77	68.2	11.01	73.0	12.08	84.7	13.70	97.3	15.97
	31	43.1	5.98	53.6	8.72	63.5	10.97	78.1	13.83	82.5	14.64	93.8	15.79	106.0	18.37
	33	50.6	8.04	61.5	10.60	72.0	12.74	86.2	16.06	92.0	16.82	103.0	18.71	114.4	20.68
	35	58.1	11.00	69.5	13.71	80.5	16.59	86.2	18.14	92.0	19.81	103.0	23.33	114.4	25.57
	37	58.1	11.69	69.5	14.52	80.5	17.62	86.2	19.29	92.0	21.08	103.0	24.82	114.4	26.99
	39	58.1	12.42	69.5	15.48	80.5	18.84	86.2	20.76	92.0	22.77	103.0	26.57	114.4	29.10
41	56.6	13.73	67.7	16.96	78.5	20.67	84.0	22.77	89.6	24.75	100.3	29.18	111.5	31.36	
43	55.2	14.94	66.1	18.48	76.5	22.55	82.0	24.83	87.4	27.03	97.8	31.88	108.7	33.92	
46	51.7	16.60	61.9	20.78	71.7	25.40	76.8	27.65	81.9	30.47	91.7	35.95	101.9	37.83	
48	45.8	14.49	54.8	18.15	63.4	22.21	67.9	24.17	72.4	26.66	81.1	31.46	90.1	32.43	
60	10	7.9	0.88	10.6	1.10	14.2	1.38	20.0	1.61	26.4	2.03	38.0	2.68	50.4	3.51
	12	7.9	0.89	10.6	1.11	14.2	1.39	20.0	1.62	26.4	2.05	38.0	2.71	50.4	3.55
	14	7.9	0.90	10.6	1.12	14.2	1.41	20.0	1.64	26.4	2.08	38.0	2.74	50.4	3.59
	16	7.9	0.91	10.6	1.13	14.2	1.42	20.0	1.66	26.4	2.10	38.0	2.77	50.4	3.62
	18	7.9	0.91	10.6	1.14	14.2	1.44	20.0	1.67	26.4	2.12	38.0	2.80	50.4	3.66
	20	7.9	0.92	10.6	1.15	14.2	1.45	20.0	1.69	26.4	2.14	38.0	2.82	50.4	3.70
	21	7.9	0.93	10.6	1.20	17.7	1.86	23.5	2.05	30.2	2.57	41.2	3.11	53.6	4.07
	23	7.9	1.03	17.6	2.17	25.1	2.78	32.5	2.97	38.1	3.78	47.9	4.60	59.9	5.59
	25	14.8	1.96	24.6	3.27	32.4	3.83	41.9	5.08	46.0	5.50	55.8	6.82	66.3	8.09
	27	21.7	2.85	31.6	4.66	39.7	5.65	50.6	7.07	53.8	7.90	62.6	9.03	72.6	10.41
	29	28.7	3.70	38.5	5.97	47.0	7.54	59.7	9.28	61.7	10.07	69.5	11.32	79.0	13.31
	31	35.7	4.71	45.5	7.13	54.3	9.18	67.0	11.14	69.5	11.69	77.9	12.54	85.4	15.34
	33	42.7	6.55	52.5	8.68	61.6	10.30	72.3	12.49	77.5	13.38	84.0	14.85	91.7	17.47
	35	49.7	9.33	59.4	11.42	69.1	13.68	73.9	14.90	78.8	16.17	88.4	18.89	98.1	21.79
	37	49.7	9.85	59.4	12.05	69.1	14.49	73.9	15.82	78.8	17.16	88.4	20.05	98.1	23.18
	39	49.7	10.48	59.4	12.83	69.1	15.64	73.9	16.98	78.8	18.46	88.4	21.50	98.1	24.84
41	48.4	11.37	57.9	14.04	67.3	16.98	72.0	18.54	76.7	20.04	86.2	23.60	95.6	27.00	
43	47.2	12.35	56.4	15.29	65.6	18.52	70.2	20.21	74.8	21.85	84.0	25.76	93.2	29.49	
46	44.3	13.83	52.9	17.16	61.5	20.83	65.8	22.72	70.1	24.59	78.8	29.03	87.4	33.60	
48	39.2	12.05	46.8	14.98	54.4	18.19	58.2	19.84	62.0	21.49	69.7	25.39	77.3	29.39	
50	10	7.1	0.77	9.7	0.96	13.7	1.21	18.3	1.49	24.1	1.79	34.7	2.36	46.0	3.07
	12	7.1	0.78	9.7	0.97	13.7	1.22	18.3	1.50	24.1	1.81	34.7	2.38	46.0	3.11
	14	7.1	0.79	9.7	0.98	13.7	1.24	18.3	1.52	24.1	1.83	34.7	2.41	46.0	3.14
	16	7.1	0.80	9.7	0.99	13.7	1.25	18.3	1.53	24.1	1.84	34.7	2.43	46.0	3.17
	18	7.1	0.80	9.7	1.00	13.7	1.26	18.3	1.55	24.1	1.86	34.7	2.46	46.0	3.20
	20	7.1	0.81	9.7	1.01	13.7	1.27	18.3	1.56	24.1	1.88	34.7	2.48	46.0	3.24
	21	7.1	0.82	9.7	1.05	17.0	1.64	21.6	1.88	27.4	2.26	37.6	2.73	48.5	3.56
	23	7.1	0.87	15.4	1.79	23.6	2.45	30.5	2.93	34.7	3.32	43.4	4.05	53.5	4.90
	25	12.8	1.59	21.1	2.64	30.2	3.43	40.3	4.75	42.6	4.84	49.1	5.69	58.6	6.92
	27	18.5	2.27	26.8	3.71	37.4	4.78	46.7	6.33	49.6	6.52	54.8	7.45	63.6	8.80
	29	24.3	2.98	32.6	4.78	43.3	6.15	52.5	7.85	56.5	8.41	60.5	9.24	68.6	11.12
	31	30.0	3.79	38.3	5.68	49.3	7.49	57.2	8.76	60.5	9.31	66.1	9.98	73.6	12.24
	33	35.8	5.28	44.0	6.84	55.3	8.40	59.4	9.60	63.0	10.28	71.5	11.82	78.6	13.73
	35	41.6	7.76	49.7	9.33	57.6	11.02	61.6	11.96	65.6	12.89	73.5	14.87	81.8	17.09
	37	41.6	8.22	49.7	9.86	57.6	11.66	61.6	12.66	65.6	13.65	73.5	15.86	81.8	18.14
	39	41.6	8.77	49.7	10.57	57.6	12.50	61.6	13.62	65.6	14.64	73.5	16.90	81.8	19.59
41	40.5	9.49	48.4	11.44	56.2	13.67	60.0	14.76	63.9	15.87	71.6	18.52	79.7	21.28	
43	39.5	10.31	47.2	12.44	54.8	14.87	58.5	16.07	62.3	17.27	69.8	20.20	77.8	23.21	
46	37.0	11.55	44.3	13.95	51.3	16.68	54.9	18.04	58.4	19.39	65.4	22.73	72.9	26.13	
48	32.8	10.06	39.2	12.17	45.4	14.55	48.5	15.75	51.6	16.93	57.9	19.86	64.5	22.84	

**Note**

1. TC: Total Capacity(kW), PI : Power Input(kW, Comp. + Outdoor fan motor)
2. Capacity tables show the average value of conditions which may occur.

# 7. Capacity Tables

◆ ARUM460LTE5

Cooling Capacity (46HP)

Combination (%)	Outdoor air temp. (DB, °C)	Indoor air temp. (DB/WB, °C)													
		20		23		26		27		28		30		32	
		14	PI	16	PI	18	PI	19	PI	20	PI	22	PI	24	PI
130	10	18.1	1.91	24.7	2.38	33.0	2.90	46.5	3.53	61.3	4.42	88.3	5.89	117.1	7.80
	12	18.1	1.93	24.7	2.41	33.0	2.93	46.5	3.57	61.3	4.46	88.3	5.95	117.1	7.88
	14	18.1	1.95	24.7	2.43	33.0	2.96	46.5	3.61	61.3	4.51	88.3	6.01	117.1	7.96
	16	18.1	1.97	24.7	2.46	33.0	2.99	46.5	3.65	61.3	4.56	88.3	6.08	117.1	8.05
	18	18.1	1.99	24.7	2.48	33.0	3.02	46.5	3.68	61.3	4.60	88.3	6.14	117.1	8.13
	20	18.1	2.01	24.7	2.51	33.0	3.05	46.5	3.72	61.3	4.65	88.3	6.20	117.1	8.21
	21	18.1	2.03	25.1	2.58	40.8	3.81	54.2	4.43	68.6	5.71	94.0	7.79	120.8	9.24
	23	31.5	3.60	43.9	4.73	56.7	5.39	70.8	6.00	83.0	8.60	105.6	11.12	128.3	13.10
	25	46.6	5.70	56.4	7.10	72.7	8.06	88.3	9.51	97.5	12.36	117.3	16.16	135.8	19.01
	27	60.8	9.09	72.1	10.73	88.6	12.18	104.9	14.56	111.9	18.48	128.9	23.30	143.4	26.26
	29	75.0	12.62	87.8	14.80	104.5	17.88	122.0	21.06	126.4	25.10	140.7	30.13	150.9	33.53
	31	91.0	16.49	105.5	20.34	122.8	24.68	137.4	28.81	140.8	32.85	148.6	41.27	158.8	41.85
	33	107.1	20.32	125.1	26.54	140.5	31.76	148.4	41.23	151.7	40.94	156.4	41.31	166.9	41.89
	35	127.6	27.45	146.2	33.27	150.9	40.37	153.5	40.57	156.0	40.82	160.2	41.18	164.9	41.34
	37	127.6	29.27	144.1	34.91	148.8	39.84	150.9	40.04	153.5	40.28	157.7	40.64	162.3	40.80
	39	127.6	31.17	141.6	36.75	146.2	39.30	148.8	39.50	150.9	39.74	155.5	40.09	160.2	40.25
41	124.3	33.07	135.7	38.59	140.3	38.77	142.4	38.97	145.2	39.20	149.6	39.55	153.6	39.71	
43	121.2	34.87	130.1	38.05	134.6	38.24	136.6	38.43	139.3	38.66	143.6	39.01	147.5	39.16	
46	113.6	37.33	118.6	37.25	122.9	37.44	124.9	37.63	127.5	37.85	131.5	38.19	135.1	38.34	
48	100.5	36.29	103.0	36.39	106.9	36.47	108.6	36.57	110.9	36.89	114.5	37.12	117.6	37.27	
120	10	16.7	1.78	22.8	2.23	30.4	2.71	42.9	3.31	56.6	4.13	81.4	5.51	108.0	7.30
	12	16.7	1.80	22.8	2.25	30.4	2.74	42.9	3.34	56.6	4.18	81.4	5.57	108.0	7.37
	14	16.7	1.82	22.8	2.27	30.4	2.77	42.9	3.38	56.6	4.22	81.4	5.63	108.0	7.45
	16	16.7	1.84	22.8	2.30	30.4	2.80	42.9	3.41	56.6	4.26	81.4	5.68	108.0	7.53
	18	16.7	1.86	22.8	2.32	30.4	2.82	42.9	3.44	56.6	4.31	81.4	5.74	108.0	7.60
	20	16.7	1.88	22.8	2.34	30.4	2.85	42.9	3.48	56.6	4.35	81.4	5.80	108.0	7.68
	21	16.7	1.90	23.2	2.42	38.5	3.63	50.0	4.14	63.9	5.34	87.2	7.29	111.9	8.64
	23	29.0	3.37	41.6	4.50	54.7	5.17	65.3	5.61	79.1	8.04	99.1	10.40	119.7	12.25
	25	45.2	5.34	58.4	6.75	71.7	7.54	81.4	8.89	94.8	11.56	111.8	15.12	127.4	17.78
	27	62.8	8.43	79.4	10.04	88.9	11.30	96.7	13.51	110.6	17.15	124.5	21.63	135.2	24.76
	29	80.6	11.71	95.6	13.52	106.0	16.60	112.4	19.54	126.3	23.29	137.2	27.96	143.0	31.44
	31	97.6	14.82	115.2	17.87	123.2	22.02	129.4	25.90	142.6	29.54	146.5	35.53	151.4	36.19
	33	113.1	18.27	135.9	23.33	144.0	28.34	146.0	32.87	148.5	38.67	152.5	39.11	157.3	39.42
	35	115.4	24.41	137.3	31.62	145.4	34.98	147.4	41.66	150.0	41.87	154.1	42.00	158.1	42.33
	37	115.4	26.26	137.3	33.37	143.4	37.29	145.4	40.79	147.4	40.99	151.5	41.11	155.6	41.44
	39	115.4	28.27	136.8	35.27	140.9	39.55	142.9	39.95	144.9	40.15	149.5	40.27	153.5	40.59
41	112.5	30.28	130.8	37.17	135.2	38.77	137.1	39.11	139.1	39.31	143.2	39.42	147.2	39.74	
43	109.7	32.32	125.3	36.63	129.7	37.90	131.5	38.27	133.5	38.46	137.4	38.58	141.4	38.89	
46	102.8	34.75	114.3	35.76	118.4	36.72	120.2	37.02	122.0	37.20	125.7	37.31	129.4	37.61	
48	90.9	34.04	99.2	35.13	102.9	36.00	104.5	36.22	106.1	36.33	109.3	36.48	112.6	36.62	
110	10	15.3	1.68	20.9	2.09	27.9	2.55	39.3	3.11	51.8	3.88	74.6	5.18	98.9	6.86
	12	15.3	1.69	20.9	2.11	27.9	2.57	39.3	3.14	51.8	3.92	74.6	5.23	98.9	6.93
	14	15.3	1.71	20.9	2.14	27.9	2.60	39.3	3.17	51.8	3.96	74.6	5.29	98.9	7.00
	16	15.3	1.73	20.9	2.16	27.9	2.63	39.3	3.20	51.8	4.01	74.6	5.34	98.9	7.07
	18	15.3	1.75	20.9	2.18	27.9	2.65	39.3	3.24	51.8	4.05	74.6	5.40	98.9	7.14
	20	15.3	1.76	20.9	2.20	27.9	2.68	39.3	3.27	51.8	4.09	74.6	5.45	98.9	7.22
	21	15.3	1.78	20.9	2.27	34.9	3.35	46.2	3.89	57.7	5.02	80.5	6.85	104.0	8.12
	23	27.4	3.16	34.9	4.23	48.9	4.74	60.2	5.27	73.0	7.56	91.5	9.77	113.0	11.51
	25	39.5	5.01	48.9	6.34	62.9	7.09	74.4	8.36	86.7	10.86	102.3	14.20	121.9	16.71
	27	51.5	7.92	62.9	9.43	76.9	10.62	88.4	12.70	101.1	16.12	113.9	20.32	131.8	23.27
	29	63.6	11.00	76.9	12.70	90.9	15.59	102.8	18.36	115.5	21.89	125.5	25.75	139.0	28.55
	31	77.2	13.93	92.7	16.80	106.9	20.69	117.1	24.34	129.9	27.76	137.1	29.77	144.1	32.05
	33	89.5	17.17	106.9	21.92	121.2	26.63	132.1	29.75	140.4	33.39	144.8	34.31	148.5	34.36
	35	103.4	21.63	123.3	27.83	137.7	31.73	141.7	33.99	143.7	36.08	147.1	36.41	151.1	36.59
	37	103.4	22.92	123.3	29.53	137.7	33.49	139.7	36.01	141.2	38.05	145.2	38.19	148.6	38.29
	39	103.4	24.71	123.3	31.38	135.2	35.34	137.2	38.52	139.2	39.94	142.7	40.01	146.7	40.05
41	100.8	26.51	120.1	33.23	129.4	37.27	131.5	41.66	133.2	41.66	137.1	42.00	140.5	42.33	
43	98.3	27.83	117.2	34.62	124.0	39.52	126.1	39.96	127.7	39.88	131.5	40.10	134.8	40.21	
46	92.1	27.17	109.8	33.43	113.2	37.51	115.1	37.50	116.6	37.83	120.2	38.04	123.3	38.14	
48	81.5	26.38	95.4	32.20	98.3	35.68	100.1	35.92	101.4	36.10	104.5	36.20	107.3	36.34	

# 7. Capacity Tables

Cooling Capacity (46HP)

Combination (%)	Outdoor air temp. (DB, °C)	Indoor air temp. (DB/WB, °C)													
		20		23		26		27		28		30		32	
		14		16		18		19		20		22		24	
		TC	PI	TC	PI	TC	PI	TC	PI	TC	PI	TC	PI	TC	PI
100	10	14.1	1.54	19.2	1.92	25.6	2.34	36.1	2.85	47.5	3.56	68.4	4.75	90.8	6.29
	12	14.1	1.55	19.2	1.94	25.6	2.36	36.1	2.88	47.5	3.60	68.4	4.80	90.8	6.36
	14	14.1	1.57	19.2	1.96	25.6	2.39	36.1	2.91	47.5	3.64	68.4	4.85	90.8	6.42
	16	14.1	1.59	19.2	1.98	25.6	2.41	36.1	2.94	47.5	3.67	68.4	4.90	90.8	6.49
	18	14.1	1.60	19.2	2.00	25.6	2.43	36.1	2.97	47.5	3.71	68.4	4.95	90.8	6.55
	20	14.1	1.62	19.2	2.02	25.6	2.46	36.1	3.00	47.5	3.75	68.4	5.00	90.8	6.62
	21	14.1	1.63	19.2	2.08	31.8	3.07	42.4	3.57	54.2	4.61	73.9	6.29	95.4	7.45
	23	24.4	2.90	33.6	3.88	44.5	4.35	55.8	4.84	67.6	6.93	84.7	8.97	104.7	10.56
	25	34.8	4.60	45.3	5.82	57.2	6.50	69.6	7.67	81.1	9.97	95.6	13.03	113.9	15.33
	27	45.2	7.27	57.0	8.65	69.9	9.74	82.6	11.65	94.5	14.79	106.4	18.64	123.1	21.35
	29	55.6	10.09	68.7	11.66	82.5	14.31	96.0	16.85	108.0	20.08	117.3	24.10	132.4	26.20
	31	66.0	12.78	80.4	15.41	95.2	18.98	109.5	22.33	121.4	25.47	128.1	27.87	142.7	29.70
	33	76.4	15.75	92.1	20.11	107.9	24.43	122.9	28.34	135.0	30.94	139.2	31.48	142.7	32.17
	35	86.9	18.97	103.5	24.22	120.5	30.10	128.8	33.33	135.0	33.53	139.2	33.66	142.7	33.93
	37	86.9	20.32	103.5	25.98	120.5	31.89	128.8	34.92	132.8	35.09	136.6	35.23	139.8	35.56
	39	86.9	21.79	103.5	27.91	120.5	33.79	128.8	36.62	130.6	36.79	134.4	36.92	137.5	37.27
	41	85.6	23.25	101.9	29.84	118.6	35.69	123.6	38.33	126.3	38.48	129.3	38.62	133.5	38.98
43	82.6	24.61	98.4	31.63	114.5	37.40	118.5	39.80	119.9	39.94	123.6	40.07	126.8	40.45	
46	77.4	26.47	92.2	34.10	107.3	39.67	108.2	41.66	109.4	41.78	112.9	41.91	115.9	42.30	
48	68.5	22.85	81.5	29.50	92.7	33.91	94.0	35.35	95.0	35.46	98.1	35.54	100.8	35.83	
90	10	12.6	1.41	17.2	1.77	23.0	2.22	31.8	2.54	42.8	3.28	61.6	4.32	81.7	5.66
	12	12.6	1.43	17.2	1.78	23.0	2.24	31.8	2.56	42.8	3.31	61.6	4.37	81.7	5.72
	14	12.6	1.44	17.2	1.80	23.0	2.27	31.8	2.59	42.8	3.35	61.6	4.41	81.7	5.78
	16	12.6	1.46	17.2	1.82	23.0	2.29	31.8	2.62	42.8	3.38	61.6	4.46	81.7	5.84
	18	12.6	1.47	17.2	1.84	23.0	2.31	31.8	2.64	42.8	3.42	61.6	4.50	81.7	5.90
	20	12.6	1.49	17.2	1.86	23.0	2.34	31.8	2.67	42.8	3.45	61.6	4.55	81.7	5.96
	21	12.6	1.50	17.2	1.88	28.9	2.94	37.7	3.16	48.2	4.14	66.5	5.01	86.0	6.55
	23	17.2	2.33	25.4	3.23	40.3	4.17	48.8	4.55	59.0	6.08	76.5	7.42	94.7	9.02
	25	27.3	3.93	36.7	5.18	51.7	6.18	60.0	7.19	69.7	8.87	86.4	11.21	103.4	13.03
	27	37.5	5.78	48.0	7.37	63.1	9.59	71.2	10.68	80.4	12.94	96.4	15.09	112.2	17.05
	29	47.6	7.81	59.4	10.13	74.5	13.36	82.4	14.77	91.2	17.07	106.3	19.37	120.9	22.57
	31	57.8	9.77	70.7	13.00	85.9	16.72	93.6	18.85	101.9	21.27	116.3	22.55	129.6	26.23
	33	67.9	12.58	82.0	16.00	97.3	20.27	104.7	22.35	112.7	24.73	126.2	26.72	138.4	29.30
	35	78.2	15.58	93.4	19.69	108.6	24.35	115.9	26.86	123.3	29.20	136.1	31.32	138.4	32.04
	37	78.2	16.53	93.4	20.95	108.6	25.96	115.9	28.53	123.3	30.82	133.9	32.74	136.2	33.48
	39	78.2	17.50	93.4	22.28	108.6	27.48	115.9	30.36	123.3	32.41	131.7	34.52	134.0	34.94
	41	76.2	19.58	91.0	24.70	105.8	30.16	113.0	33.20	120.1	34.99	126.2	36.38	128.5	37.22
43	74.3	21.14	88.7	26.69	103.2	32.94	110.2	35.76	117.2	37.52	121.0	38.87	123.2	39.43	
46	69.6	23.79	83.2	30.40	96.7	37.54	103.2	40.54	106.4	41.68	110.5	41.91	112.5	42.30	
48	61.6	20.80	73.6	26.59	85.5	32.84	91.3	35.35	92.4	35.46	96.0	35.54	97.8	35.83	
80	10	10.8	1.25	14.8	1.56	19.7	1.96	27.8	2.26	36.6	2.90	52.7	3.82	69.9	5.00
	12	10.8	1.26	14.8	1.58	19.7	1.98	27.8	2.28	36.6	2.93	52.7	3.86	69.9	5.06
	14	10.8	1.28	14.8	1.59	19.7	2.00	27.8	2.30	36.6	2.96	52.7	3.90	69.9	5.11
	16	10.8	1.29	14.8	1.61	19.7	2.02	27.8	2.33	36.6	2.99	52.7	3.94	69.9	5.16
	18	10.8	1.30	14.8	1.63	19.7	2.04	27.8	2.35	36.6	3.02	52.7	3.98	69.9	5.21
	20	10.8	1.32	14.8	1.64	19.7	2.07	27.8	2.38	36.6	3.05	52.7	4.02	69.9	5.27
	21	10.8	1.32	14.8	1.69	24.7	2.60	33.1	2.85	41.5	3.66	57.3	4.42	74.3	5.79
	23	19.2	2.44	24.5	2.90	34.9	3.69	43.9	4.09	51.3	5.38	66.7	6.56	83.0	7.97
	25	27.6	3.54	34.2	4.66	45.1	5.46	54.6	6.47	61.1	7.84	76.1	9.91	91.7	11.52
	27	35.9	5.20	43.9	6.63	55.2	8.48	65.3	9.61	70.8	11.44	85.5	13.34	100.4	15.07
	29	44.3	6.75	53.6	9.11	65.4	11.81	76.0	13.29	80.6	15.09	94.9	17.12	109.1	19.95
	31	52.7	8.26	63.3	11.47	75.6	14.78	86.7	16.96	92.2	18.29	104.3	19.73	117.8	22.96
	33	61.1	10.87	73.0	14.11	85.8	17.38	97.5	20.11	103.2	21.02	113.7	23.39	126.5	25.84
	35	69.5	14.23	82.8	17.83	96.1	21.88	103.0	24.03	109.9	26.30	123.3	29.84	135.2	31.08
	37	69.5	15.05	82.8	18.96	96.1	23.20	103.0	25.54	109.9	27.95	123.3	31.49	133.0	32.65
	39	69.5	15.90	82.8	20.04	96.1	24.82	103.0	27.46	109.9	30.03	123.3	33.27	130.8	34.44
	41	67.7	17.59	80.7	22.21	93.7	27.24	100.4	30.10	107.1	33.00	120.1	35.65	125.3	36.47
43	66.0	19.37	78.7	24.24	91.4	29.74	97.9	32.80	104.5	36.06	117.2	38.09	120.1	39.04	
46	61.9	21.55	73.7	27.30	85.6	33.50	91.8	36.51	97.9	40.69	107.1	41.91	109.7	42.30	
48	54.7	18.82	65.2	23.87	75.7	29.30	81.2	31.89	86.6	35.46	93.0	35.54	95.3	35.83	

# 7. Capacity Tables

Cooling Capacity (46HP)

Combination (%)	Outdoor air temp. (DB, °C)	Indoor air temp. (DB/WB, °C)													
		20		23		26		27		28		30		32	
		14		16		18		19		20		22		24	
		TC	PI	TC	PI	TC	PI	TC	PI	TC	PI	TC	PI	TC	PI
70	10	9.4	1.11	12.8	1.38	17.1	1.73	24.2	2.01	31.8	2.56	45.8	3.38	60.8	4.42
	12	9.4	1.12	12.8	1.39	17.1	1.75	24.2	2.03	31.8	2.59	45.8	3.41	60.8	4.47
	14	9.4	1.13	12.8	1.41	17.1	1.77	24.2	2.05	31.8	2.61	45.8	3.45	60.8	4.52
	16	9.4	1.14	12.8	1.42	17.1	1.79	24.2	2.07	31.8	2.64	45.8	3.48	60.8	4.56
	18	9.4	1.15	12.8	1.44	17.1	1.81	24.2	2.09	31.8	2.67	45.8	3.52	60.8	4.61
	20	9.4	1.16	12.8	1.45	17.1	1.83	24.2	2.11	31.8	2.70	45.8	3.56	60.8	4.66
	21	9.4	1.17	15.0	1.71	22.2	2.39	29.9	2.65	36.8	3.23	50.5	3.91	65.4	5.12
	23	13.5	1.76	23.2	2.79	31.1	3.50	40.3	3.81	46.7	4.75	60.0	5.79	74.5	7.05
	25	21.4	2.90	31.4	4.12	39.9	4.83	50.6	6.01	56.6	6.93	69.6	8.76	83.6	10.18
	27	29.3	4.23	39.6	5.86	48.7	7.12	61.0	8.94	66.5	10.11	79.1	11.79	92.6	13.33
	29	37.1	5.37	47.8	7.75	57.6	9.68	71.3	12.16	76.4	13.34	88.6	15.14	101.7	17.64
	31	45.0	6.60	56.1	9.63	66.4	12.12	81.7	15.28	86.3	16.17	98.1	17.44	110.8	20.29
	33	52.9	8.88	64.3	11.72	75.2	14.08	90.2	17.74	96.1	18.58	107.6	20.67	119.6	22.84
	35	60.7	12.15	72.7	15.15	84.2	18.32	90.2	20.04	96.1	21.89	107.6	25.77	119.6	28.25
	37	60.7	12.92	72.7	16.04	84.2	19.47	90.2	21.32	96.1	23.29	107.6	27.42	119.6	29.82
	39	60.7	13.72	72.7	17.10	84.2	20.82	90.2	22.93	96.1	25.16	107.6	29.35	119.6	32.15
	41	59.2	15.16	70.8	18.74	82.0	22.84	87.9	25.15	93.7	27.35	104.9	32.24	116.5	34.65
43	57.7	16.51	69.1	20.42	80.0	24.92	85.7	27.43	91.4	29.86	102.3	35.22	113.7	37.47	
46	54.1	18.34	64.7	22.96	75.0	28.06	80.3	30.55	85.6	33.66	95.9	39.72	106.5	41.79	
48	47.8	16.01	57.3	20.06	66.3	24.53	71.0	26.70	75.7	29.45	84.8	34.76	94.2	35.83	
60	10	8.3	0.94	11.1	1.18	14.8	1.48	20.9	1.72	27.6	2.18	39.7	2.88	52.6	3.77
	12	8.3	0.95	11.1	1.19	14.8	1.49	20.9	1.74	27.6	2.21	39.7	2.91	52.6	3.81
	14	8.3	0.96	11.1	1.20	14.8	1.51	20.9	1.76	27.6	2.23	39.7	2.94	52.6	3.85
	16	8.3	0.97	11.1	1.21	14.8	1.53	20.9	1.78	27.6	2.25	39.7	2.97	52.6	3.89
	18	8.3	0.98	11.1	1.23	14.8	1.54	20.9	1.80	27.6	2.28	39.7	3.00	52.6	3.93
	20	8.3	0.99	11.1	1.24	14.8	1.56	20.9	1.81	27.6	2.30	39.7	3.03	52.6	3.97
	21	8.3	1.00	11.1	1.28	18.5	2.00	24.6	2.20	31.6	2.76	43.1	3.33	56.0	4.37
	23	8.3	1.10	18.4	2.33	26.2	2.99	34.0	3.19	39.8	4.05	50.1	4.94	62.6	6.01
	25	15.4	2.10	25.7	3.51	33.8	4.11	43.8	5.45	48.0	5.91	58.3	7.32	69.3	8.68
	27	22.7	3.06	33.0	5.00	41.5	6.07	52.9	7.59	56.3	8.48	65.5	9.69	75.9	11.18
	29	30.0	3.97	40.3	6.41	49.2	8.09	62.4	9.97	64.5	10.81	72.7	12.16	82.6	14.29
	31	37.3	5.05	47.6	7.66	56.8	9.85	70.1	11.96	72.7	12.55	81.4	13.46	89.2	16.47
	33	44.6	7.03	54.9	9.31	64.5	11.06	75.6	13.41	81.0	14.37	87.9	15.95	95.9	18.76
	35	52.0	10.31	62.1	12.61	72.2	15.11	77.3	16.46	82.3	17.86	92.5	20.87	102.6	24.08
	37	52.0	10.89	62.1	13.31	72.2	16.01	77.3	17.48	82.3	18.95	92.5	22.15	102.6	25.61
	39	52.0	11.58	62.1	14.17	72.2	17.28	77.3	18.75	82.3	20.40	92.5	23.75	102.6	27.45
	41	50.6	12.56	60.5	15.51	70.4	18.76	75.3	20.49	80.2	22.14	90.1	26.07	100.0	29.82
43	49.4	13.64	59.0	16.89	68.6	20.45	73.4	22.32	78.2	24.14	87.9	28.46	97.5	32.58	
46	46.3	15.28	55.3	18.96	64.3	23.01	68.8	25.10	73.3	27.17	82.3	32.07	91.4	37.12	
48	41.0	13.31	48.9	16.55	56.9	20.10	60.9	21.92	64.9	23.74	72.8	28.04	80.8	32.47	
50	10	7.4	0.80	10.2	1.00	14.3	1.26	19.1	1.55	25.2	1.86	36.3	2.46	48.1	3.20
	12	7.4	0.81	10.2	1.01	14.3	1.27	19.1	1.56	25.2	1.88	36.3	2.48	48.1	3.23
	14	7.4	0.82	10.2	1.02	14.3	1.29	19.1	1.58	25.2	1.90	36.3	2.51	48.1	3.27
	16	7.4	0.83	10.2	1.04	14.3	1.30	19.1	1.60	25.2	1.92	36.3	2.53	48.1	3.30
	18	7.4	0.84	10.2	1.05	14.3	1.31	19.1	1.61	25.2	1.94	36.3	2.56	48.1	3.34
	20	7.4	0.85	10.2	1.06	14.3	1.33	19.1	1.63	25.2	1.96	36.3	2.58	48.1	3.37
	21	7.4	0.85	10.2	1.09	17.8	1.70	22.5	1.95	28.6	2.35	39.4	2.84	50.7	3.71
	23	7.4	0.90	16.1	1.86	24.7	2.55	31.8	3.05	36.3	3.46	45.3	4.21	56.0	5.10
	25	13.4	1.65	22.1	2.74	31.6	3.57	42.1	4.94	44.6	5.04	51.3	5.93	61.2	7.20
	27	19.4	2.36	28.1	3.86	39.1	4.98	48.8	6.59	51.8	6.79	57.3	7.76	66.5	9.17
	29	25.4	3.10	34.0	4.97	45.3	6.40	54.9	8.17	59.1	8.76	63.3	9.62	71.7	11.58
	31	31.4	3.95	40.0	5.91	51.5	7.79	59.8	9.11	63.2	9.69	69.1	10.38	77.0	12.74
	33	37.4	5.50	46.0	7.12	57.8	8.75	62.1	9.99	65.9	10.70	74.8	12.31	82.1	14.29
	35	43.5	8.57	52.0	10.31	60.3	12.18	64.4	13.21	68.5	14.24	76.8	16.43	85.6	18.88
	37	43.5	9.09	52.0	10.89	60.3	12.89	64.4	13.98	68.5	15.08	76.8	17.53	85.6	20.04
	39	43.5	9.69	52.0	11.67	60.3	13.81	64.4	15.05	68.5	16.18	76.8	18.67	85.6	21.64
	41	42.4	10.48	50.6	12.64	58.7	15.10	62.8	16.30	66.8	17.53	74.9	20.46	83.4	23.50
43	41.3	11.39	49.4	13.74	57.3	16.43	61.2	17.75	65.1	19.08	73.0	22.31	81.3	25.64	
46	38.7	12.76	46.3	15.41	53.7	18.43	57.4	19.93	61.0	21.43	68.4	25.11	76.2	28.87	
48	34.2	11.12	41.0	13.44	47.5	16.07	50.7	17.40	54.0	18.70	60.5	21.94	67.4	25.23	

**Note**

1. TC: Total Capacity(kW), PI : Power Input(kW, Comp. + Outdoor fan motor)
2. Capacity tables show the average value of conditions which may occur.



# 7. Capacity Tables

◆ ARUM480LTE5

Cooling Capacity (48HP)

Combination (%)	Outdoor air temp. (DB, °C)	Indoor air temp. (DB/WB, °C)													
		20		23		26		27		28		30		32	
		14	16	16	18	18	19	20	20	22	22	24	24		
		TC	PI	TC	PI	TC	PI	TC	PI	TC	PI	TC	PI	TC	PI
130	10	18.9	1.99	25.8	2.49	34.4	3.03	48.5	3.69	64.0	4.61	92.1	6.15	122.2	8.15
	12	18.9	2.01	25.8	2.51	34.4	3.06	48.5	3.73	64.0	4.66	92.1	6.22	122.2	8.23
	14	18.9	2.03	25.8	2.54	34.4	3.09	48.5	3.77	64.0	4.71	92.1	6.28	122.2	8.32
	16	18.9	2.05	25.8	2.57	34.4	3.12	48.5	3.81	64.0	4.76	92.1	6.35	122.2	8.41
	18	18.9	2.08	25.8	2.59	34.4	3.15	48.5	3.85	64.0	4.81	92.1	6.41	122.2	8.49
	20	18.9	2.10	25.8	2.62	34.4	3.19	48.5	3.89	64.0	4.86	92.1	6.48	122.2	8.58
	21	18.9	2.12	26.2	2.70	42.6	3.98	56.6	4.63	71.5	5.97	98.1	8.14	126.0	9.65
	23	32.9	3.76	45.8	4.94	59.2	5.63	73.9	6.26	86.6	8.98	110.2	11.62	133.9	13.68
	25	48.6	5.96	58.9	7.41	75.8	8.42	92.2	9.93	101.7	12.91	122.4	16.88	141.7	19.86
	27	63.4	9.49	75.2	11.21	92.4	12.72	109.5	15.21	116.8	19.31	134.5	24.35	149.6	27.43
	29	78.3	13.18	91.6	15.46	109.0	18.68	127.3	22.00	131.9	26.22	146.8	31.48	157.5	35.03
	31	95.0	17.22	110.1	21.25	128.2	25.78	143.3	30.09	147.0	34.32	155.1	43.11	165.7	43.73
	33	111.7	21.23	130.6	27.73	146.6	33.18	154.9	43.08	158.2	42.77	163.2	43.16	174.2	43.76
	35	133.1	28.68	152.6	34.76	157.4	42.18	160.2	42.39	162.8	42.64	167.2	43.02	172.1	43.19
	37	133.1	30.58	150.4	36.47	155.3	41.62	157.4	41.83	160.2	42.08	164.5	42.45	169.4	42.62
	39	133.1	32.56	147.7	38.39	152.6	41.06	155.3	41.27	157.4	41.52	162.3	41.89	167.2	42.05
41	129.7	34.54	141.6	40.31	146.4	40.50	148.6	40.71	151.5	40.95	156.1	41.32	160.3	41.48	
43	126.5	36.43	135.7	39.75	140.4	39.95	142.6	40.15	145.4	40.39	149.9	40.75	154.0	40.91	
46	118.6	39.00	123.8	38.91	128.3	39.11	130.3	39.31	133.0	39.54	137.2	39.90	141.0	40.05	
48	104.9	37.91	107.5	38.02	111.5	38.10	113.3	38.21	115.7	38.54	119.4	38.78	122.8	38.93	
120	10	17.5	1.86	23.8	2.33	31.7	2.83	44.8	3.45	59.0	4.32	85.0	5.76	112.7	7.62
	12	17.5	1.88	23.8	2.35	31.7	2.86	44.8	3.49	59.0	4.36	85.0	5.82	112.7	7.70
	14	17.5	1.90	23.8	2.38	31.7	2.89	44.8	3.53	59.0	4.41	85.0	5.88	112.7	7.78
	16	17.5	1.92	23.8	2.40	31.7	2.92	44.8	3.56	59.0	4.45	85.0	5.94	112.7	7.86
	18	17.5	1.94	23.8	2.42	31.7	2.95	44.8	3.60	59.0	4.50	85.0	6.00	112.7	7.94
	20	17.5	1.96	23.8	2.45	31.7	2.98	44.8	3.64	59.0	4.54	85.0	6.06	112.7	8.02
	21	17.5	1.98	24.2	2.52	40.2	3.80	52.2	4.33	66.7	5.58	91.0	7.62	116.8	9.03
	23	30.3	3.52	43.4	4.70	57.1	5.40	68.1	5.86	82.6	8.40	103.4	10.87	124.9	12.80
	25	47.2	5.57	60.9	7.05	74.8	7.88	84.9	9.29	99.0	12.08	116.7	15.79	133.0	18.58
	27	65.5	8.81	82.9	10.49	92.8	11.81	100.9	14.12	115.4	17.92	129.9	22.59	141.1	25.87
	29	84.1	12.23	99.8	14.12	110.6	17.34	117.3	20.42	131.8	24.34	143.2	29.21	149.2	32.84
	31	101.9	15.49	120.2	18.67	128.6	23.00	135.0	27.06	148.8	30.86	152.8	37.12	158.0	37.81
	33	118.0	19.09	141.8	24.37	150.2	29.61	152.3	34.34	155.0	40.40	159.2	40.86	164.2	41.19
	35	120.5	25.50	143.2	33.04	151.7	36.54	153.8	43.53	156.5	43.74	160.8	43.87	165.0	44.22
	37	120.5	27.43	143.2	34.86	149.6	38.96	151.7	42.61	153.8	42.82	158.1	42.95	162.4	43.29
	39	120.5	29.53	142.7	36.84	147.0	41.32	149.1	41.73	151.2	41.94	156.0	42.07	160.2	42.40
41	117.4	31.63	136.5	38.83	141.1	40.51	143.1	40.86	145.2	41.06	149.4	41.19	153.6	41.51	
43	114.5	33.76	130.8	38.27	135.3	39.60	137.3	39.98	139.3	40.18	143.4	40.30	147.5	40.62	
46	107.3	36.31	119.2	37.36	123.6	38.36	125.4	38.67	127.3	38.86	131.1	38.98	135.0	39.29	
48	94.9	35.56	103.5	36.70	107.4	37.61	109.0	37.84	110.7	37.96	114.1	38.11	117.5	38.26	
110	10	16.0	1.75	21.8	2.19	29.1	2.66	41.0	3.25	54.1	4.06	77.8	5.41	103.2	7.16
	12	16.0	1.77	21.8	2.21	29.1	2.69	41.0	3.28	54.1	4.10	77.8	5.47	103.2	7.24
	14	16.0	1.79	21.8	2.23	29.1	2.72	41.0	3.31	54.1	4.14	77.8	5.52	103.2	7.31
	16	16.0	1.81	21.8	2.26	29.1	2.74	41.0	3.35	54.1	4.18	77.8	5.58	103.2	7.39
	18	16.0	1.82	21.8	2.28	29.1	2.77	41.0	3.38	54.1	4.23	77.8	5.64	103.2	7.46
	20	16.0	1.84	21.8	2.30	29.1	2.80	41.0	3.42	54.1	4.27	77.8	5.69	103.2	7.54
	21	16.0	1.86	21.8	2.37	36.4	3.50	48.2	4.07	60.2	5.25	84.0	7.16	108.5	8.48
	23	28.6	3.30	36.4	4.42	51.0	4.95	62.9	5.51	76.2	7.90	95.5	10.21	117.9	12.03
	25	41.2	5.24	51.0	6.62	65.6	7.40	77.7	8.73	90.5	11.35	106.7	14.84	127.2	17.46
	27	53.8	8.28	65.6	9.85	80.2	11.09	92.3	13.27	105.5	16.84	118.8	21.23	137.5	24.31
	29	66.4	11.49	80.2	13.27	94.8	16.29	107.2	19.19	120.5	22.87	130.9	26.90	145.1	29.83
	31	80.5	14.55	96.7	17.55	111.6	21.61	122.2	25.43	135.6	29.00	143.0	31.10	150.4	33.48
	33	93.3	17.94	111.6	22.90	126.5	27.82	137.8	31.08	146.5	34.88	151.1	35.85	154.9	35.90
	35	107.9	22.60	128.6	29.07	143.7	33.15	147.8	35.51	149.9	37.69	153.5	38.04	157.7	38.23
	37	107.9	23.95	128.6	30.85	143.7	34.99	145.8	37.62	147.3	39.75	151.5	39.89	155.1	40.00
	39	107.9	25.82	128.6	32.79	141.1	36.92	143.1	40.24	145.3	41.72	148.9	41.79	153.0	41.84
41	105.1	27.69	125.3	34.72	135.0	38.93	137.2	43.53	138.9	43.53	143.0	43.87	146.6	44.22	
43	102.5	29.08	122.2	36.17	129.4	41.29	131.5	41.75	133.3	41.66	137.2	41.90	140.7	42.01	
46	96.1	28.38	114.6	34.92	118.1	39.18	120.1	39.18	121.7	39.52	125.4	39.74	128.7	39.85	
48	85.0	27.56	99.6	33.64	102.6	37.28	104.4	37.53	105.8	37.71	109.1	37.82	112.0	37.97	

# 7. Capacity Tables

Cooling Capacity (48HP)

Combination (%)	Outdoor air temp. (DB, °C)	Indoor air temp. (DB/WB, °C)													
		20		23		26		27		28		30		32	
		14		16		18		19		20		22		24	
		TC	PI	TC	PI	TC	PI	TC	PI	TC	PI	TC	PI	TC	PI
100	10	14.7	1.61	20.0	2.01	26.7	2.44	37.6	2.98	49.6	3.72	71.4	4.96	94.7	6.57
	12	14.7	1.62	20.0	2.03	26.7	2.47	37.6	3.01	49.6	3.76	71.4	5.02	94.7	6.64
	14	14.7	1.64	20.0	2.05	26.7	2.49	37.6	3.04	49.6	3.80	71.4	5.07	94.7	6.71
	16	14.7	1.66	20.0	2.07	26.7	2.52	37.6	3.07	49.6	3.84	71.4	5.12	94.7	6.78
	18	14.7	1.67	20.0	2.09	26.7	2.54	37.6	3.10	49.6	3.88	71.4	5.17	94.7	6.85
	20	14.7	1.69	20.0	2.11	26.7	2.57	37.6	3.13	49.6	3.92	71.4	5.22	94.7	6.92
	21	14.7	1.71	20.0	2.18	33.2	3.21	44.2	3.73	56.5	4.81	77.1	6.57	99.6	7.78
	23	25.4	3.03	35.0	4.05	46.4	4.54	58.2	5.05	70.6	7.24	88.4	9.37	109.2	11.03
	25	36.3	4.81	47.2	6.08	59.7	6.79	72.6	8.01	84.6	10.41	99.7	13.61	118.8	16.02
	27	47.1	7.60	59.4	9.04	72.9	10.18	86.2	12.17	98.6	15.45	111.0	19.48	128.5	22.30
	29	58.0	10.55	71.6	12.18	86.1	14.95	100.2	17.60	112.7	20.98	122.4	25.18	138.1	27.37
	31	68.9	13.35	83.9	16.10	99.3	19.83	114.2	23.33	126.7	26.61	133.7	29.12	148.9	31.03
	33	79.7	16.46	96.1	21.01	112.6	25.52	128.2	29.60	140.9	32.33	145.2	32.89	148.9	33.60
	35	90.7	19.82	108.0	25.31	125.8	31.45	134.4	34.82	140.9	35.03	145.2	35.17	148.9	35.45
	37	90.7	21.23	108.0	27.14	125.8	33.31	134.4	36.48	138.5	36.66	142.5	36.80	145.9	37.14
	39	90.7	22.76	108.0	29.16	125.8	35.30	134.4	38.26	136.2	38.43	140.2	38.57	143.5	38.93
	41	89.3	24.29	106.3	31.17	123.8	37.29	129.0	40.04	131.8	40.20	134.9	40.34	139.3	40.72
43	86.2	25.71	102.6	33.04	119.5	39.07	123.6	41.58	125.1	41.72	128.9	41.86	132.3	42.25	
46	80.8	27.65	96.2	35.62	112.0	41.44	112.9	43.53	114.1	43.65	117.8	43.78	120.9	44.19	
48	71.5	23.88	85.1	30.82	96.7	35.43	98.1	36.93	99.1	37.05	102.4	37.13	105.2	37.43	
90	10	13.2	1.48	18.0	1.85	24.0	2.32	33.2	2.65	44.6	3.42	64.3	4.52	85.2	5.91
	12	13.2	1.49	18.0	1.86	24.0	2.34	33.2	2.68	44.6	3.46	64.3	4.56	85.2	5.98
	14	13.2	1.51	18.0	1.88	24.0	2.37	33.2	2.71	44.6	3.50	64.3	4.61	85.2	6.04
	16	13.2	1.52	18.0	1.90	24.0	2.39	33.2	2.73	44.6	3.53	64.3	4.66	85.2	6.10
	18	13.2	1.54	18.0	1.92	24.0	2.42	33.2	2.76	44.6	3.57	64.3	4.71	85.2	6.16
	20	13.2	1.56	18.0	1.94	24.0	2.44	33.2	2.79	44.6	3.60	64.3	4.75	85.2	6.23
	21	13.2	1.57	18.0	1.96	30.1	3.08	39.3	3.31	50.3	4.32	69.4	5.23	89.7	6.85
	23	17.9	2.43	26.5	3.37	42.0	4.36	51.0	4.75	61.5	6.36	79.8	7.75	98.8	9.42
	25	28.5	4.11	38.3	5.41	53.9	6.45	62.6	7.51	72.7	9.27	90.2	11.71	107.9	13.61
	27	39.1	6.04	50.1	7.70	65.8	10.02	74.3	11.16	83.9	13.51	100.6	15.76	117.0	17.81
	29	49.7	8.16	62.0	10.58	77.7	13.96	86.0	15.43	95.2	17.84	110.9	20.23	126.1	23.58
	31	60.3	10.21	73.8	13.58	89.6	17.47	97.6	19.69	106.4	22.22	121.3	23.56	135.3	27.40
	33	70.9	13.14	85.6	16.72	101.6	21.18	109.3	23.35	117.6	25.83	131.7	27.92	144.4	30.61
	35	81.6	16.27	97.4	20.57	113.3	25.44	121.0	28.06	128.6	30.50	142.0	32.72	144.4	33.47
	37	81.6	17.27	97.4	21.88	113.3	27.12	121.0	29.80	128.6	32.20	139.7	34.21	142.1	34.98
	39	81.6	18.29	97.4	23.28	113.3	28.71	121.0	31.72	128.6	33.86	137.4	36.06	139.8	36.50
	41	79.5	20.46	94.9	25.81	110.4	31.51	117.9	34.69	125.3	36.56	131.7	38.01	134.0	38.88
43	77.5	22.09	92.6	27.89	107.7	34.42	115.0	37.36	122.2	39.20	126.3	40.60	128.6	41.19	
46	72.7	24.86	86.8	31.76	100.9	39.21	107.7	42.35	111.1	43.55	115.3	43.78	117.4	44.19	
48	64.3	21.73	76.8	27.78	89.2	34.31	95.3	36.93	96.5	37.05	100.2	37.13	102.1	37.43	
80	10	11.3	1.31	15.4	1.63	20.5	2.05	29.0	2.36	38.2	3.03	55.0	3.99	72.9	5.23
	12	11.3	1.32	15.4	1.65	20.5	2.07	29.0	2.38	38.2	3.06	55.0	4.03	72.9	5.28
	14	11.3	1.33	15.4	1.67	20.5	2.09	29.0	2.41	38.2	3.09	55.0	4.08	72.9	5.34
	16	11.3	1.35	15.4	1.68	20.5	2.11	29.0	2.43	38.2	3.12	55.0	4.12	72.9	5.39
	18	11.3	1.36	15.4	1.70	20.5	2.14	29.0	2.46	38.2	3.15	55.0	4.16	72.9	5.45
	20	11.3	1.38	15.4	1.72	20.5	2.16	29.0	2.48	38.2	3.19	55.0	4.20	72.9	5.50
	21	11.3	1.38	15.4	1.77	25.8	2.72	34.6	2.97	43.3	3.82	59.8	4.62	77.5	6.05
	23	20.0	2.55	25.5	3.03	36.4	3.85	45.8	4.28	53.5	5.62	69.6	6.85	86.6	8.33
	25	28.8	3.70	35.7	4.87	47.0	5.70	56.9	6.76	63.7	8.19	79.4	10.35	95.7	12.04
	27	37.5	5.43	45.8	6.93	57.6	8.85	68.1	10.04	73.9	11.95	89.2	13.93	104.8	15.75
	29	46.2	7.05	56.0	9.52	68.2	12.34	79.3	13.88	84.1	15.77	99.0	17.89	113.9	20.85
	31	55.0	8.63	66.1	11.98	78.9	15.45	90.5	17.72	96.2	19.11	108.8	20.62	122.9	23.98
	33	63.7	11.36	76.2	14.75	89.5	18.16	101.7	21.01	107.7	21.96	118.6	24.43	132.0	27.00
	35	72.5	14.86	86.4	18.63	100.3	22.85	107.5	25.10	114.7	27.48	128.6	31.17	141.1	32.47
	37	72.5	15.72	86.4	19.80	100.3	24.24	107.5	26.68	114.7	29.19	128.6	32.90	138.8	34.11
	39	72.5	16.61	86.4	20.94	100.3	25.93	107.5	28.69	114.7	31.37	128.6	34.76	136.5	35.98
	41	70.6	18.38	84.2	23.20	97.8	28.46	104.8	31.45	111.8	34.47	125.3	37.25	130.8	38.10
43	68.9	20.23	82.1	25.32	95.3	31.06	102.2	34.27	109.0	37.67	122.2	39.79	125.4	40.78	
46	64.5	22.51	76.9	28.52	89.3	35.00	95.8	38.14	102.2	42.51	111.8	43.78	114.4	44.19	
48	57.1	19.66	68.1	24.94	79.0	30.61	84.7	33.32	90.4	37.05	97.1	37.13	99.4	37.43	

# 7. Capacity Tables

Cooling Capacity (48HP)

Combination (%)	Outdoor air temp. (DB, °C)	Indoor air temp. (DB/WB, °C)													
		20		23		26		27		28		30		32	
		14		16		18		19		20		22		24	
		TC	PI	TC	PI	TC	PI	TC	PI	TC	PI	TC	PI	TC	PI
70	10	9.8	1.15	13.4	1.44	17.9	1.81	25.2	2.10	33.2	2.68	47.8	3.53	63.5	4.62
	12	9.8	1.17	13.4	1.46	17.9	1.83	25.2	2.12	33.2	2.70	47.8	3.57	63.5	4.67
	14	9.8	1.18	13.4	1.47	17.9	1.85	25.2	2.14	33.2	2.73	47.8	3.60	63.5	4.72
	16	9.8	1.19	13.4	1.49	17.9	1.87	25.2	2.17	33.2	2.76	47.8	3.64	63.5	4.77
	18	9.8	1.20	13.4	1.50	17.9	1.89	25.2	2.19	33.2	2.79	47.8	3.68	63.5	4.82
	20	9.8	1.22	13.4	1.52	17.9	1.91	25.2	2.21	33.2	2.82	47.8	3.71	63.5	4.86
	21	9.8	1.22	15.6	1.78	23.2	2.50	31.2	2.77	38.4	3.38	52.7	4.09	68.3	5.35
	23	14.1	1.84	24.2	2.91	32.4	3.66	42.0	3.98	48.7	4.97	62.7	6.05	77.8	7.36
	25	22.3	3.03	32.8	4.30	41.6	5.04	52.8	6.28	59.0	7.24	72.6	9.15	87.2	10.64
	27	30.5	4.42	41.3	6.13	50.9	7.44	63.6	9.34	69.4	10.56	82.5	12.32	96.7	13.92
	29	38.8	5.61	49.9	8.09	60.1	10.12	74.4	12.70	79.7	13.94	92.4	15.81	106.1	18.43
	31	47.0	6.90	58.5	10.06	69.3	12.67	85.2	15.96	90.0	16.89	102.3	18.22	115.6	21.20
	33	55.2	9.27	67.1	12.24	78.5	14.71	94.1	18.53	100.3	19.41	112.3	21.60	124.8	23.87
	35	63.4	12.70	75.8	15.83	87.8	19.14	94.1	20.94	100.3	22.87	112.3	26.92	124.8	29.52
	37	63.4	13.49	75.8	16.76	87.8	20.34	94.1	22.27	100.3	24.33	112.3	28.65	124.8	31.15
	39	63.4	14.33	75.8	17.87	87.8	21.75	94.1	23.96	100.3	26.28	112.3	30.66	124.8	33.58
	41	61.7	15.84	73.9	19.57	85.6	23.86	91.7	26.28	97.8	28.57	109.4	33.68	121.6	36.20
43	60.2	17.24	72.1	21.33	83.5	26.03	89.4	28.65	95.3	31.20	106.7	36.79	118.6	39.15	
46	56.4	19.16	67.5	23.99	78.2	29.31	83.8	31.92	89.3	35.17	100.0	41.49	111.1	43.66	
48	49.9	16.72	59.7	20.95	69.2	25.63	74.1	27.89	79.0	30.77	88.5	36.31	98.3	37.43	
60	10	8.7	0.97	11.6	1.21	15.5	1.52	21.8	1.77	28.8	2.25	41.4	2.96	54.9	3.88
	12	8.7	0.98	11.6	1.22	15.5	1.54	21.8	1.79	28.8	2.27	41.4	3.00	54.9	3.92
	14	8.7	0.99	11.6	1.24	15.5	1.55	21.8	1.81	28.8	2.29	41.4	3.03	54.9	3.96
	16	8.7	1.00	11.6	1.25	15.5	1.57	21.8	1.83	28.8	2.32	41.4	3.06	54.9	4.00
	18	8.7	1.01	11.6	1.26	15.5	1.59	21.8	1.85	28.8	2.34	41.4	3.09	54.9	4.04
	20	8.7	1.02	11.6	1.27	15.5	1.60	21.8	1.87	28.8	2.37	41.4	3.12	54.9	4.09
	21	8.7	1.03	11.6	1.32	19.4	2.06	25.6	2.26	33.0	2.84	45.0	3.43	58.4	4.49
	23	8.7	1.13	19.2	2.39	27.3	3.07	35.5	3.29	41.6	4.17	52.3	5.08	65.4	6.18
	25	16.1	2.16	26.8	3.61	35.3	4.24	45.7	5.61	50.1	6.08	60.8	7.53	72.3	8.93
	27	23.7	3.15	34.4	5.15	43.3	6.25	55.2	7.81	58.7	8.73	68.3	9.98	79.2	11.51
	29	31.3	4.09	42.0	6.59	51.3	8.33	65.1	10.26	67.3	11.12	75.8	12.51	86.2	14.71
	31	38.9	5.20	49.6	7.88	59.3	10.14	73.1	12.31	75.9	12.92	84.9	13.85	93.1	16.95
	33	46.5	7.24	57.2	9.59	67.3	11.38	78.9	13.80	84.5	14.79	91.7	16.41	100.0	19.30
	35	54.2	10.77	64.8	13.18	75.4	15.79	80.6	17.19	85.9	18.66	96.5	21.81	107.0	25.15
	37	54.2	11.37	64.8	13.91	75.4	16.72	80.6	18.26	85.9	19.80	96.5	23.15	107.0	26.76
	39	54.2	12.09	64.8	14.81	75.4	18.05	80.6	19.59	85.9	21.31	96.5	24.82	107.0	28.67
	41	52.9	13.12	63.1	16.20	73.4	19.60	78.6	21.40	83.7	23.13	94.0	27.24	104.3	31.16
43	51.5	14.25	61.6	17.64	71.6	21.37	76.6	23.32	81.7	25.22	91.7	29.73	101.7	34.03	
46	48.3	15.96	57.7	19.81	67.1	24.03	71.8	26.22	76.5	28.38	85.9	33.50	95.3	38.77	
48	42.7	13.91	51.1	17.29	59.4	21.00	63.5	22.90	67.7	24.80	76.0	29.30	84.3	33.93	
50	10	7.8	0.81	10.6	1.02	14.9	1.28	19.9	1.57	26.3	1.89	37.8	2.49	50.2	3.24
	12	7.8	0.82	10.6	1.03	14.9	1.29	19.9	1.58	26.3	1.91	37.8	2.52	50.2	3.28
	14	7.8	0.83	10.6	1.04	14.9	1.30	19.9	1.60	26.3	1.93	37.8	2.54	50.2	3.31
	16	7.8	0.84	10.6	1.05	14.9	1.32	19.9	1.62	26.3	1.95	37.8	2.57	50.2	3.35
	18	7.8	0.85	10.6	1.06	14.9	1.33	19.9	1.63	26.3	1.97	37.8	2.59	50.2	3.38
	20	7.8	0.86	10.6	1.07	14.9	1.35	19.9	1.65	26.3	1.99	37.8	2.62	50.2	3.42
	21	7.8	0.86	10.6	1.11	18.6	1.73	23.5	1.98	29.9	2.38	41.1	2.88	52.9	3.76
	23	7.8	0.92	16.8	1.89	25.8	2.58	33.2	3.09	37.8	3.50	47.3	4.27	58.4	5.17
	25	14.0	1.67	23.0	2.78	32.9	3.62	44.0	5.01	46.5	5.11	53.5	6.01	63.9	7.30
	27	20.2	2.40	29.3	3.91	40.8	5.04	51.0	6.68	54.1	6.88	59.8	7.87	69.4	9.29
	29	26.5	3.15	35.5	5.04	47.3	6.49	57.3	8.28	61.6	8.88	66.0	9.75	74.8	11.74
	31	32.7	4.00	41.8	5.99	53.8	7.90	62.4	9.24	66.0	9.82	72.1	10.53	80.3	12.91
	33	39.0	5.57	48.0	7.21	60.3	8.87	64.8	10.13	68.8	10.85	78.0	12.47	85.7	14.49
	35	45.4	8.95	54.2	10.77	62.9	12.72	67.2	13.80	71.5	14.88	80.2	17.17	89.3	19.72
	37	45.4	9.49	54.2	11.38	62.9	13.46	67.2	14.61	71.5	15.75	80.2	18.31	89.3	20.93
	39	45.4	10.12	54.2	12.19	62.9	14.42	67.2	15.72	71.5	16.90	80.2	19.50	89.3	22.61
	41	44.2	10.95	52.9	13.20	61.3	15.77	65.5	17.03	69.7	18.31	78.1	21.38	87.0	24.55
43	43.1	11.90	51.5	14.36	59.8	17.16	63.9	18.54	68.0	19.94	76.2	23.31	84.8	26.79	
46	40.4	13.33	48.3	16.10	56.0	19.25	59.8	20.82	63.7	22.38	71.4	26.23	79.5	30.16	
48	35.7	11.61	42.7	14.04	49.5	16.79	52.9	18.18	56.3	19.53	63.2	22.92	70.3	26.36	

**Note**

1. TC: Total Capacity(kW), PI : Power Input(kW, Comp. + Outdoor fan motor)
2. Capacity tables show the average value of conditions which may occur.

# 7. Capacity Tables

## ◆ ARUM500LTE5

Cooling Capacity (50HP)

Combination (%)	Outdoor air temp. (DB, °C)	Indoor air temp. (DB/WB, °C)													
		20		23		26		27		28		30		32	
		14	16	18	19	20	22	24	TC	PI	TC	PI			
130	10	19.7	1.93	26.9	2.41	35.8	2.94	50.6	3.58	66.6	4.48	95.9	5.97	127.3	7.91
	12	19.7	1.95	26.9	2.44	35.8	2.97	50.6	3.62	66.6	4.53	95.9	6.03	127.3	7.99
	14	19.7	1.97	26.9	2.46	35.8	3.00	50.6	3.66	66.6	4.57	95.9	6.10	127.3	8.07
	16	19.7	1.99	26.9	2.49	35.8	3.03	50.6	3.70	66.6	4.62	95.9	6.16	127.3	8.16
	18	19.7	2.01	26.9	2.52	35.8	3.06	50.6	3.73	66.6	4.67	95.9	6.22	127.3	8.24
	20	19.7	2.03	26.9	2.54	35.8	3.09	50.6	3.77	66.6	4.71	95.9	6.29	127.3	8.32
	21	19.7	2.06	27.3	2.62	44.4	3.86	58.9	4.49	74.5	5.79	102.2	7.90	131.3	9.37
	23	34.2	3.65	47.7	4.80	61.7	5.47	77.0	6.08	90.2	8.72	114.8	11.27	139.5	13.28
	25	50.6	5.78	61.3	7.20	79.0	8.17	96.0	9.64	105.9	12.53	127.5	16.38	147.6	19.27
	27	66.1	9.21	78.4	10.88	96.3	12.35	114.1	14.76	121.6	18.74	140.1	23.63	155.8	26.62
	29	81.5	12.79	95.4	15.01	113.6	18.13	132.6	21.35	137.4	25.45	152.9	30.54	164.1	34.00
	31	98.9	16.71	114.7	20.62	133.5	25.02	149.3	29.20	153.1	33.31	161.5	41.84	172.6	42.43
	33	116.4	20.60	136.0	26.91	152.7	32.20	161.4	41.80	164.8	41.51	170.0	41.88	181.5	42.47
	35	138.7	27.83	158.9	33.73	164.0	40.93	166.8	41.13	169.5	41.38	174.1	41.75	179.2	41.91
	37	138.7	29.67	156.7	35.40	161.8	40.39	164.0	40.59	166.8	40.83	171.4	41.20	176.4	41.36
	39	138.7	31.60	153.9	37.26	158.9	39.85	161.8	40.05	164.0	40.29	169.1	40.65	174.1	40.81
41	135.1	33.52	147.5	39.12	152.5	39.31	154.8	39.50	157.8	39.74	162.6	40.10	167.0	40.25	
43	131.8	35.35	141.4	38.57	146.3	38.77	148.5	38.96	151.5	39.19	156.1	39.54	160.4	39.70	
46	123.5	37.84	129.0	37.76	133.6	37.95	135.7	38.15	138.5	38.37	142.9	38.72	146.8	38.87	
48	109.2	36.79	112.0	36.90	116.2	36.98	118.0	37.08	120.6	37.40	124.4	37.63	127.9	37.78	
120	10	18.2	1.81	24.8	2.26	33.1	2.75	46.6	3.35	61.5	4.19	88.5	5.59	117.4	7.40
	12	18.2	1.83	24.8	2.28	33.1	2.78	46.6	3.39	61.5	4.23	88.5	5.65	117.4	7.47
	14	18.2	1.85	24.8	2.31	33.1	2.81	46.6	3.42	61.5	4.28	88.5	5.70	117.4	7.55
	16	18.2	1.87	24.8	2.33	33.1	2.83	46.6	3.46	61.5	4.32	88.5	5.76	117.4	7.63
	18	18.2	1.88	24.8	2.35	33.1	2.86	46.6	3.49	61.5	4.37	88.5	5.82	117.4	7.71
	20	18.2	1.90	24.8	2.38	33.1	2.89	46.6	3.53	61.5	4.41	88.5	5.88	117.4	7.79
	21	18.2	1.92	25.2	2.45	41.9	3.68	54.3	4.20	69.5	5.42	94.8	7.39	121.6	8.76
	23	31.5	3.41	45.3	4.56	59.5	5.24	70.9	5.69	86.0	8.15	107.7	10.55	130.1	12.42
	25	49.1	5.41	63.5	6.84	77.9	7.65	88.5	9.02	103.1	11.72	121.5	15.33	138.5	18.03
	27	68.3	8.55	86.4	10.18	96.7	11.46	105.1	13.70	120.2	17.39	135.3	21.92	146.9	25.11
	29	87.6	11.87	104.0	13.71	115.2	16.83	122.1	19.81	137.3	23.62	149.1	28.34	155.4	31.87
	31	106.1	15.03	125.2	18.12	134.0	22.32	140.6	26.26	155.0	29.95	159.2	36.02	164.6	36.69
	33	123.0	18.52	147.7	23.65	156.5	28.73	158.7	33.32	161.4	39.20	165.8	39.65	171.0	39.97
	35	125.5	24.75	149.2	32.06	158.1	35.46	160.3	42.24	163.0	42.45	167.5	42.58	171.9	42.91
	37	125.5	26.62	149.2	33.83	155.8	37.81	158.1	41.35	160.3	41.56	164.7	41.68	169.1	42.01
	39	125.5	28.66	148.7	35.75	153.1	40.10	155.3	40.50	157.5	40.70	162.5	40.82	166.9	41.15
41	122.3	30.70	142.2	37.68	147.0	39.31	149.1	39.65	151.2	39.85	155.6	39.97	160.0	40.29	
43	119.2	32.76	136.2	37.14	140.9	38.43	143.0	38.80	145.1	39.00	149.4	39.11	153.7	39.42	
46	111.7	35.23	124.2	36.25	128.7	37.22	130.6	37.53	132.6	37.71	136.6	37.83	140.6	38.13	
48	98.9	34.51	107.8	35.61	111.9	36.49	113.6	36.72	115.3	36.83	118.9	36.98	122.4	37.13	
110	10	16.7	1.70	22.7	2.12	30.3	2.58	42.7	3.15	56.3	3.94	81.1	5.25	107.5	6.95
	12	16.7	1.72	22.7	2.14	30.3	2.61	42.7	3.18	56.3	3.98	81.1	5.30	107.5	7.02
	14	16.7	1.73	22.7	2.17	30.3	2.64	42.7	3.22	56.3	4.02	81.1	5.36	107.5	7.10
	16	16.7	1.75	22.7	2.19	30.3	2.66	42.7	3.25	56.3	4.06	81.1	5.42	107.5	7.17
	18	16.7	1.77	22.7	2.21	30.3	2.69	42.7	3.28	56.3	4.10	81.1	5.47	107.5	7.24
	20	16.7	1.79	22.7	2.23	30.3	2.72	42.7	3.31	56.3	4.14	81.1	5.53	107.5	7.32
	21	16.7	1.81	22.7	2.30	37.9	3.39	50.2	3.95	62.7	5.09	87.5	6.95	113.0	8.23
	23	29.8	3.21	37.9	4.29	53.1	4.81	65.5	5.34	79.4	7.66	99.5	9.91	122.9	11.67
	25	42.9	5.08	53.1	6.43	68.3	7.19	80.9	8.47	94.3	11.01	111.2	14.40	132.5	16.94
	27	56.0	8.03	68.3	9.56	83.6	10.77	96.1	12.87	109.9	16.34	123.8	20.60	143.2	23.59
	29	69.1	11.15	83.5	12.88	98.8	15.81	111.7	18.62	125.6	22.19	136.4	26.10	151.1	28.95
	31	83.9	14.12	100.7	17.03	116.2	20.98	127.3	24.68	141.2	28.14	149.0	30.18	156.7	32.49
	33	97.2	17.41	116.2	22.22	131.7	27.00	143.6	30.16	152.6	33.85	157.4	34.79	161.4	34.83
	35	112.4	21.93	134.0	28.21	149.7	32.16	154.0	34.46	156.2	36.58	159.9	36.92	164.3	37.10
	37	112.4	23.24	134.0	29.94	149.7	33.96	151.8	36.51	153.5	38.58	157.8	38.71	161.6	38.82
	39	112.4	25.06	134.0	31.82	147.0	35.83	149.1	39.05	151.3	40.49	155.1	40.56	159.4	40.60
41	109.5	26.87	130.6	33.69	140.7	37.78	142.9	42.24	144.7	42.24	149.0	42.58	152.7	42.91	
43	106.8	28.22	127.3	35.10	134.8	40.06	137.0	40.52	138.8	40.43	142.9	40.66	146.6	40.77	
46	100.1	27.54	119.3	33.89	123.0	38.02	125.2	38.02	126.8	38.35	130.7	38.56	134.0	38.67	
48	88.6	26.75	103.7	32.65	106.8	36.18	108.8	36.42	110.2	36.59	113.6	36.70	116.6	36.84	

# 7. Capacity Tables

Cooling Capacity (50HP)

Combination (%)	Outdoor air temp. (DB, °C)	Indoor air temp. (DB/WB, °C)													
		20		23		26		27		28		30		32	
		14		16		18		19		20		22		24	
		TC	PI	TC	PI	TC	PI	TC	PI	TC	PI	TC	PI	TC	PI
100	10	15.3	1.56	20.8	1.95	27.8	2.37	39.2	2.89	51.7	3.61	74.4	4.82	98.7	6.38
	12	15.3	1.58	20.8	1.97	27.8	2.39	39.2	2.92	51.7	3.65	74.4	4.87	98.7	6.44
	14	15.3	1.59	20.8	1.99	27.8	2.42	39.2	2.95	51.7	3.69	74.4	4.92	98.7	6.51
	16	15.3	1.61	20.8	2.01	27.8	2.44	39.2	2.98	51.7	3.73	74.4	4.97	98.7	6.58
	18	15.3	1.62	20.8	2.03	27.8	2.47	39.2	3.01	51.7	3.76	74.4	5.02	98.7	6.65
	20	15.3	1.64	20.8	2.05	27.8	2.49	39.2	3.04	51.7	3.80	74.4	5.07	98.7	6.71
	21	15.3	1.66	20.8	2.11	34.6	3.11	46.0	3.62	58.9	4.67	80.3	6.37	103.7	7.55
	23	26.5	2.94	36.5	3.93	48.4	4.41	60.6	4.90	73.5	7.03	92.1	9.09	113.8	10.71
	25	37.8	4.66	49.2	5.90	62.2	6.59	75.6	7.77	88.1	10.10	103.9	13.21	123.8	15.54
	27	49.1	7.37	61.9	8.77	75.9	9.88	89.8	11.81	102.7	14.99	115.7	18.90	133.9	21.64
	29	60.4	10.23	74.6	11.82	89.7	14.50	104.4	17.08	117.3	20.36	127.5	24.44	143.9	26.56
	31	71.7	12.96	87.3	15.62	103.5	19.24	119.0	22.64	132.0	25.82	139.2	28.25	155.1	30.11
	33	83.0	15.97	100.1	20.39	117.3	24.77	133.6	28.73	146.7	31.37	151.3	31.91	155.1	32.61
	35	94.5	19.24	112.5	24.56	131.0	30.52	140.0	33.79	146.7	33.99	151.3	34.13	155.1	34.40
	37	94.5	20.60	112.5	26.34	131.0	32.33	140.0	35.40	144.3	35.57	148.5	35.72	152.0	36.05
	39	94.5	22.09	112.5	28.29	131.0	34.26	140.0	37.13	141.9	37.29	146.1	37.43	149.5	37.78
41	93.0	23.57	110.7	30.25	128.9	36.19	134.3	38.86	137.3	39.01	140.5	39.15	145.1	39.52	
43	89.8	24.95	106.9	32.07	124.5	37.92	128.8	40.35	130.3	40.49	134.3	40.62	137.8	41.00	
46	84.2	26.83	100.2	34.57	116.7	40.22	117.6	42.24	118.9	42.36	122.7	42.49	126.0	42.89	
48	74.4	23.17	88.6	29.91	100.7	34.38	102.2	35.84	103.3	35.95	106.7	36.04	109.6	36.32	
90	10	13.7	1.43	18.7	1.79	25.0	2.25	34.6	2.57	46.5	3.32	66.9	4.38	88.8	5.74
	12	13.7	1.45	18.7	1.81	25.0	2.27	34.6	2.60	46.5	3.36	66.9	4.43	88.8	5.80
	14	13.7	1.46	18.7	1.83	25.0	2.30	34.6	2.63	46.5	3.39	66.9	4.47	88.8	5.86
	16	13.7	1.48	18.7	1.85	25.0	2.32	34.6	2.65	46.5	3.43	66.9	4.52	88.8	5.92
	18	13.7	1.49	18.7	1.87	25.0	2.34	34.6	2.68	46.5	3.46	66.9	4.57	88.8	5.98
	20	13.7	1.51	18.7	1.88	25.0	2.37	34.6	2.71	46.5	3.50	66.9	4.61	88.8	6.04
	21	13.7	1.52	18.7	1.90	31.4	2.98	40.9	3.21	52.4	4.20	72.3	5.07	93.4	6.65
	23	18.6	2.36	27.6	3.27	43.8	4.23	53.1	4.61	64.1	6.17	83.1	7.52	102.9	9.14
	25	29.7	3.99	39.9	5.25	56.2	6.26	65.2	7.28	75.8	8.99	93.9	11.36	112.4	13.21
	27	40.7	5.86	52.2	7.47	68.6	9.72	77.4	10.83	87.4	13.11	104.7	15.29	121.9	17.29
	29	51.7	7.91	64.5	10.27	81.0	13.54	89.5	14.97	99.1	17.31	115.6	19.64	131.4	22.88
	31	62.8	9.90	76.9	13.18	93.4	16.96	101.7	19.11	110.8	21.56	126.4	22.86	140.9	26.59
	33	73.8	12.75	89.2	16.22	105.8	20.55	113.8	22.66	122.5	25.07	137.2	27.09	150.4	29.70
	35	85.0	15.79	101.5	19.97	118.0	24.69	126.0	27.23	134.0	29.60	147.9	31.76	150.4	32.48
	37	85.0	16.76	101.5	21.24	118.0	26.32	126.0	28.92	134.0	31.25	145.5	33.20	148.1	33.94
	39	85.0	17.74	101.5	22.59	118.0	27.86	126.0	30.78	134.0	32.86	143.2	35.00	145.7	35.42
41	82.8	19.85	98.9	25.04	115.0	30.58	122.8	33.66	130.6	35.47	137.2	36.88	139.6	37.73	
43	80.8	21.43	96.5	27.06	112.1	33.40	119.7	36.25	127.3	38.04	131.5	39.40	133.9	39.97	
46	75.7	24.12	90.4	30.82	105.1	38.05	112.2	41.10	115.7	42.26	120.1	42.49	122.3	42.89	
48	67.0	21.08	80.0	26.96	93.0	33.30	99.3	35.84	100.5	35.95	104.3	36.04	106.3	36.32	
80	10	11.8	1.27	16.0	1.58	21.4	1.99	30.2	2.29	39.8	2.94	57.3	3.87	76.0	5.07
	12	11.8	1.28	16.0	1.60	21.4	2.01	30.2	2.31	39.8	2.97	57.3	3.91	76.0	5.13
	14	11.8	1.29	16.0	1.62	21.4	2.03	30.2	2.34	39.8	3.00	57.3	3.96	76.0	5.18
	16	11.8	1.31	16.0	1.63	21.4	2.05	30.2	2.36	39.8	3.03	57.3	4.00	76.0	5.23
	18	11.8	1.32	16.0	1.65	21.4	2.07	30.2	2.38	39.8	3.06	57.3	4.04	76.0	5.29
	20	11.8	1.33	16.0	1.67	21.4	2.09	30.2	2.41	39.8	3.09	57.3	4.08	76.0	5.34
	21	11.8	1.34	16.0	1.71	26.9	2.64	36.0	2.89	45.1	3.71	62.3	4.49	80.8	5.87
	23	20.9	2.48	26.6	2.95	37.9	3.74	47.7	4.15	55.7	5.45	72.5	6.65	90.2	8.08
	25	30.0	3.59	37.2	4.72	49.0	5.54	59.3	6.56	66.4	7.95	82.7	10.04	99.7	11.68
	27	39.1	5.27	47.7	6.73	60.0	8.59	71.0	9.75	77.0	11.59	92.9	13.52	109.1	15.28
	29	48.2	6.84	58.3	9.24	71.1	11.97	82.6	13.47	87.6	15.30	103.2	17.36	118.6	20.23
	31	57.3	8.38	68.8	11.63	82.2	14.99	94.3	17.19	100.2	18.55	113.4	20.01	128.1	23.27
	33	66.4	11.02	79.4	14.31	93.2	17.62	106.0	20.39	112.2	21.31	123.6	23.71	137.5	26.20
	35	75.5	14.42	90.0	18.08	104.5	22.18	112.0	24.36	119.5	26.66	134.0	30.25	146.9	31.51
	37	75.5	15.26	90.0	19.22	104.5	23.52	112.0	25.90	119.5	28.33	134.0	31.93	144.6	33.10
	39	75.5	16.12	90.0	20.32	104.5	25.16	112.0	27.84	119.5	30.45	134.0	33.73	142.2	34.92
41	73.6	17.83	87.7	22.51	101.8	27.62	109.1	30.52	116.4	33.45	130.6	36.15	136.2	36.97	
43	71.7	19.63	85.5	24.57	99.3	30.15	106.4	33.26	113.6	36.56	127.3	38.61	130.6	39.57	
46	67.2	21.84	80.2	27.67	93.1	33.97	99.7	37.01	106.4	41.25	116.5	42.49	119.2	42.89	
48	59.5	19.08	70.9	24.20	82.3	29.71	88.2	32.33	94.1	35.95	101.1	36.04	103.6	36.32	

# 7. Capacity Tables

Cooling Capacity (50HP)

Combination (%)	Outdoor air temp. (DB, °C)	Indoor air temp. (DB/WB, °C)													
		20		23		26		27		28		30		32	
		14	16	18	19	20	22	24	TC	PI	TC	PI	TC	PI	
70	10	10.2	1.12	14.0	1.40	18.6	1.76	26.3	2.04	34.6	2.60	49.8	3.42	66.1	4.48
	12	10.2	1.13	14.0	1.41	18.6	1.78	26.3	2.06	34.6	2.62	49.8	3.46	66.1	4.53
	14	10.2	1.14	14.0	1.43	18.6	1.80	26.3	2.08	34.6	2.65	49.8	3.50	66.1	4.58
	16	10.2	1.16	14.0	1.44	18.6	1.81	26.3	2.10	34.6	2.68	49.8	3.53	66.1	4.63
	18	10.2	1.17	14.0	1.46	18.6	1.83	26.3	2.12	34.6	2.71	49.8	3.57	66.1	4.67
	20	10.2	1.18	14.0	1.47	18.6	1.85	26.3	2.14	34.6	2.73	49.8	3.61	66.1	4.72
	21	10.2	1.19	16.3	1.73	24.2	2.43	32.5	2.69	40.0	3.28	54.9	3.97	71.1	5.19
	23	14.7	1.78	25.2	2.83	33.8	3.55	43.8	3.86	50.8	4.82	65.3	5.87	81.0	7.14
	25	23.2	2.94	34.1	4.18	43.4	4.89	55.0	6.10	61.5	7.03	75.6	8.88	90.8	10.32
	27	31.8	4.29	43.1	5.95	53.0	7.22	66.3	9.06	72.3	10.25	85.9	11.95	100.7	13.51
	29	40.4	5.44	52.0	7.85	62.6	9.82	77.5	12.33	83.0	13.53	96.3	15.34	110.6	17.88
	31	48.9	6.69	60.9	9.77	72.2	12.29	88.8	15.49	93.8	16.39	106.6	17.69	120.4	20.57
	33	57.5	9.00	69.9	11.88	81.8	14.27	98.0	17.98	104.5	18.84	117.0	20.96	130.0	23.16
	35	66.0	12.32	79.0	15.36	91.5	18.58	98.0	20.32	104.5	22.19	117.0	26.12	130.0	28.64
	37	66.0	13.09	79.0	16.26	91.5	19.74	98.0	21.61	104.5	23.61	117.0	27.80	130.0	30.23
	39	66.0	13.91	79.0	17.34	91.5	21.11	98.0	23.25	104.5	25.50	117.0	29.75	130.0	32.59
41	64.3	15.37	77.0	19.00	89.2	23.15	95.5	25.50	101.8	27.72	114.0	32.68	126.7	35.13	
43	62.7	16.73	75.1	20.70	87.0	25.26	93.1	27.81	99.3	30.28	111.2	35.70	123.5	37.99	
46	58.8	18.60	70.4	23.28	81.5	28.45	87.3	30.97	93.1	34.13	104.2	40.27	115.8	42.37	
48	52.0	16.23	62.2	20.33	72.1	24.87	77.2	27.07	82.3	29.86	92.2	35.24	102.4	36.32	
60	10	9.0	0.97	12.1	1.21	16.1	1.53	22.7	1.78	30.0	2.25	43.1	2.97	57.2	3.89
	12	9.0	0.98	12.1	1.23	16.1	1.54	22.7	1.80	30.0	2.28	43.1	3.00	57.2	3.93
	14	9.0	0.99	12.1	1.24	16.1	1.56	22.7	1.82	30.0	2.30	43.1	3.04	57.2	3.97
	16	9.0	1.00	12.1	1.25	16.1	1.57	22.7	1.84	30.0	2.32	43.1	3.07	57.2	4.02
	18	9.0	1.01	12.1	1.27	16.1	1.59	22.7	1.85	30.0	2.35	43.1	3.10	57.2	4.06
	20	9.0	1.02	12.1	1.28	16.1	1.61	22.7	1.87	30.0	2.37	43.1	3.13	57.2	4.10
	21	9.0	1.03	12.1	1.33	20.2	2.06	26.7	2.27	34.4	2.85	46.8	3.44	60.9	4.51
	23	9.0	1.14	20.0	2.40	28.5	3.08	37.0	3.30	43.3	4.18	54.5	5.10	68.1	6.20
	25	16.8	2.17	27.9	3.63	36.8	4.25	47.6	5.63	52.2	6.10	63.4	7.55	75.3	8.96
	27	24.7	3.16	35.9	5.16	45.1	6.27	57.5	7.83	61.2	8.75	71.2	10.01	82.5	11.54
	29	32.6	4.10	43.8	6.61	53.4	8.35	67.9	10.29	70.1	11.16	79.0	12.55	89.8	14.75
	31	40.5	5.22	51.7	7.91	61.7	10.17	76.2	12.35	79.0	12.96	88.5	13.89	97.0	17.00
	33	48.5	7.26	59.6	9.62	70.1	11.42	82.1	13.85	88.0	14.83	95.5	16.46	104.2	19.36
	35	56.5	10.45	67.5	12.79	78.5	15.32	84.0	16.68	89.5	18.11	100.5	21.16	111.5	24.41
	37	56.5	11.04	67.5	13.50	78.5	16.23	84.0	17.72	89.5	19.21	100.5	22.46	111.5	25.97
	39	56.5	11.74	67.5	14.37	78.5	17.52	84.0	19.01	89.5	20.68	100.5	24.08	111.5	27.82
41	55.1	12.73	65.8	15.72	76.5	19.02	81.9	20.77	87.2	22.45	97.9	26.43	108.6	30.24	
43	53.7	13.83	64.1	17.12	74.6	20.74	79.8	22.63	85.1	24.48	95.5	28.85	106.0	33.03	
46	50.3	15.49	60.1	19.22	69.9	23.32	74.8	25.44	79.7	27.54	89.5	32.51	99.3	37.63	
48	44.5	13.50	53.2	16.78	61.8	20.38	66.2	22.22	70.5	24.07	79.2	28.43	87.8	32.92	
50	10	8.1	0.85	11.0	1.06	15.6	1.33	20.8	1.63	27.4	1.96	39.4	2.58	52.3	3.37
	12	8.1	0.85	11.0	1.07	15.6	1.34	20.8	1.64	27.4	1.98	39.4	2.61	52.3	3.40
	14	8.1	0.86	11.0	1.08	15.6	1.35	20.8	1.66	27.4	2.00	39.4	2.64	52.3	3.44
	16	8.1	0.87	11.0	1.09	15.6	1.37	20.8	1.68	27.4	2.02	39.4	2.67	52.3	3.47
	18	8.1	0.88	11.0	1.10	15.6	1.38	20.8	1.70	27.4	2.04	39.4	2.69	52.3	3.51
	20	8.1	0.89	11.0	1.11	15.6	1.40	20.8	1.71	27.4	2.06	39.4	2.72	52.3	3.55
	21	8.1	0.89	11.0	1.15	19.3	1.79	24.5	2.05	31.1	2.47	42.8	2.99	55.1	3.90
	23	8.1	0.95	17.5	1.96	26.8	2.68	34.6	3.21	39.4	3.64	49.3	4.43	60.8	5.36
	25	14.5	1.74	24.0	2.89	34.3	3.76	45.8	5.20	48.5	5.30	55.8	6.24	66.5	7.58
	27	21.1	2.49	30.5	4.06	42.5	5.24	53.1	6.93	56.3	7.14	62.3	8.16	72.3	9.64
	29	27.6	3.27	37.0	5.23	49.3	6.73	59.7	8.60	64.2	9.21	68.8	10.12	78.0	12.18
	31	34.1	4.15	43.5	6.22	56.0	8.20	65.0	9.59	68.7	10.19	75.1	10.93	83.7	13.40
	33	40.6	5.78	50.0	7.49	62.8	9.21	67.5	10.51	71.6	11.26	81.3	12.95	89.3	15.04
	35	47.3	8.69	56.5	10.45	65.5	12.35	70.0	13.39	74.5	14.44	83.5	16.66	93.0	19.14
	37	47.3	9.21	56.5	11.04	65.5	13.06	70.0	14.18	74.5	15.29	83.5	17.77	93.0	20.32
	39	47.3	9.82	56.5	11.83	65.5	14.00	70.0	15.26	74.5	16.40	83.5	18.93	93.0	21.94
41	46.0	10.62	55.1	12.81	63.8	15.31	68.2	16.53	72.6	17.77	81.4	20.75	90.6	23.83	
43	44.9	11.55	53.7	13.93	62.2	16.65	66.5	17.99	70.8	19.35	79.4	22.62	88.4	25.99	
46	42.1	12.93	50.3	15.63	58.3	18.68	62.3	20.21	66.3	21.72	74.4	25.45	82.8	29.26	
48	37.2	11.27	44.5	13.63	51.6	16.30	55.1	17.64	58.7	18.96	65.8	22.24	73.3	25.58	

**Note**

1. TC: Total Capacity(kW), PI : Power Input(kW, Comp. + Outdoor fan motor)
2. Capacity tables show the average value of conditions which may occur.

# 7. Capacity Tables

◆ ARUM520LTE5

Cooling Capacity (52HP)

Combination (%)	Outdoor air temp. (DB, °C)	Indoor air temp. (DB/WB, °C)													
		20		23		26		27		28		30		32	
		14	16	18	19	20	22	24	TC	PI	TC	PI			
130	10	20.5	2.06	27.9	2.57	37.3	3.13	52.6	3.82	69.3	4.77	99.8	6.37	132.3	8.43
	12	20.5	2.08	27.9	2.60	37.3	3.16	52.6	3.86	69.3	4.82	99.8	6.43	132.3	8.52
	14	20.5	2.10	27.9	2.63	37.3	3.20	52.6	3.90	69.3	4.87	99.8	6.50	132.3	8.61
	16	20.5	2.13	27.9	2.65	37.3	3.23	52.6	3.94	69.3	4.92	99.8	6.57	132.3	8.70
	18	20.5	2.15	27.9	2.68	37.3	3.26	52.6	3.98	69.3	4.97	99.8	6.63	132.3	8.78
	20	20.5	2.17	27.9	2.71	37.3	3.30	52.6	4.02	69.3	5.02	99.8	6.70	132.3	8.87
	21	20.5	2.19	28.4	2.79	46.1	4.12	61.3	4.79	77.5	6.17	106.3	8.42	136.5	9.99
	23	35.6	3.89	49.6	5.11	64.1	5.83	80.1	6.48	93.8	9.29	119.4	12.02	145.0	14.15
	25	52.6	6.16	63.8	7.67	82.1	8.71	99.9	10.27	110.2	13.35	132.6	17.46	153.5	20.55
	27	68.7	9.82	81.5	11.60	100.1	13.16	118.6	15.74	126.5	19.98	145.7	25.18	162.1	28.38
	29	84.8	13.64	99.2	16.00	118.1	19.33	137.9	22.76	142.8	27.13	159.1	32.56	170.6	36.24
	31	102.9	17.82	119.3	21.98	138.8	26.67	155.3	31.13	159.2	35.51	168.0	44.60	179.5	45.23
	33	121.0	21.96	141.4	28.68	158.8	34.32	167.8	44.56	171.4	44.25	176.7	44.64	188.7	45.27
	35	144.2	29.66	165.3	35.96	170.5	43.63	173.5	43.85	176.3	44.11	181.1	44.51	186.4	44.68
	37	144.2	31.63	162.9	37.73	168.2	43.05	170.5	43.27	173.5	43.53	178.2	43.92	183.5	44.09
	39	144.2	33.68	160.1	39.72	165.3	42.48	168.2	42.69	170.5	42.95	175.8	43.33	181.1	43.50
41	140.5	35.73	153.4	41.70	158.6	41.90	161.0	42.11	164.1	42.36	169.1	42.74	173.6	42.91	
43	137.0	37.69	147.0	41.12	152.1	41.32	154.4	41.53	157.5	41.78	162.4	42.15	166.8	42.32	
46	128.4	40.34	134.1	40.26	139.0	40.46	141.1	40.66	144.1	40.91	148.6	41.27	152.7	41.44	
48	113.6	39.21	116.5	39.33	120.8	39.42	122.8	39.52	125.4	39.86	129.4	40.12	133.0	40.27	
120	10	18.9	1.93	25.8	2.41	34.4	2.93	48.5	3.57	63.9	4.47	92.0	5.96	122.1	7.89
	12	18.9	1.95	25.8	2.43	34.4	2.96	48.5	3.61	63.9	4.51	92.0	6.02	122.1	7.97
	14	18.9	1.97	25.8	2.46	34.4	2.99	48.5	3.65	63.9	4.56	92.0	6.08	122.1	8.05
	16	18.9	1.99	25.8	2.48	34.4	3.02	48.5	3.69	63.9	4.61	92.0	6.14	122.1	8.13
	18	18.9	2.01	25.8	2.51	34.4	3.05	48.5	3.72	63.9	4.65	92.0	6.21	122.1	8.22
	20	18.9	2.03	25.8	2.53	34.4	3.08	48.5	3.76	63.9	4.70	92.0	6.27	122.1	8.30
	21	18.9	2.05	26.2	2.61	43.5	3.93	56.5	4.48	72.3	5.77	98.5	7.88	126.5	9.34
	23	32.8	3.64	47.1	4.86	61.9	5.59	73.8	6.06	89.4	8.69	112.1	11.24	135.3	13.24
	25	51.1	5.77	66.0	7.29	81.0	8.15	92.0	9.61	107.2	12.49	126.4	16.34	144.0	19.22
	27	71.0	9.11	89.8	10.85	100.5	12.21	109.3	14.60	125.0	18.54	140.7	23.37	152.8	26.76
	29	91.1	12.65	108.1	14.61	119.8	17.94	127.0	21.12	142.8	25.17	155.1	30.22	161.6	33.97
	31	110.3	16.02	130.2	19.32	139.3	23.80	146.2	27.99	161.2	31.93	165.6	38.40	171.1	39.12
	33	127.9	19.75	153.6	25.21	162.8	30.63	165.0	35.52	167.9	41.79	172.4	42.27	177.8	42.61
	35	130.5	26.38	155.2	34.17	164.4	37.80	166.7	45.03	169.6	45.25	174.2	45.39	178.7	45.75
	37	130.5	28.38	155.2	36.06	162.1	40.30	164.4	44.08	166.7	44.30	171.3	44.43	175.9	44.78
	39	130.5	30.55	154.6	38.11	159.2	42.75	161.5	43.17	163.8	43.39	169.0	43.52	173.6	43.86
41	127.2	32.72	147.9	40.16	152.9	41.90	155.0	42.27	157.3	42.48	161.8	42.61	166.4	42.94	
43	124.0	34.93	141.7	39.59	146.6	40.96	148.7	41.36	150.9	41.57	155.3	41.69	159.8	42.02	
46	116.2	37.56	129.2	38.65	133.9	39.68	135.8	40.00	137.9	40.20	142.1	40.32	146.3	40.64	
48	102.8	36.79	112.2	37.96	116.3	38.90	118.1	39.14	119.9	39.26	123.6	39.42	127.3	39.58	
110	10	17.3	1.81	23.6	2.26	31.5	2.75	44.4	3.36	58.6	4.20	84.3	5.60	111.8	7.41
	12	17.3	1.83	23.6	2.29	31.5	2.78	44.4	3.39	58.6	4.24	84.3	5.65	111.8	7.49
	14	17.3	1.85	23.6	2.31	31.5	2.81	44.4	3.43	58.6	4.28	84.3	5.71	111.8	7.57
	16	17.3	1.87	23.6	2.33	31.5	2.84	44.4	3.46	58.6	4.33	84.3	5.77	111.8	7.64
	18	17.3	1.89	23.6	2.36	31.5	2.87	44.4	3.50	58.6	4.37	84.3	5.83	111.8	7.72
	20	17.3	1.91	23.6	2.38	31.5	2.90	44.4	3.53	58.6	4.42	84.3	5.89	111.8	7.80
	21	17.3	1.93	23.6	2.45	39.5	3.62	52.2	4.21	65.2	5.43	91.0	7.40	117.6	8.78
	23	31.0	3.42	39.4	4.57	55.3	5.12	68.1	5.70	82.6	8.17	103.4	10.56	127.8	12.44
	25	44.6	5.42	55.3	6.85	71.1	7.66	84.1	9.03	98.1	11.74	115.6	15.35	137.8	18.06
	27	58.3	8.56	71.1	10.19	86.9	11.48	99.9	13.72	114.3	17.42	128.7	21.96	149.0	25.15
	29	71.9	11.89	86.9	13.73	102.7	16.85	116.2	19.85	130.6	23.65	141.8	27.82	157.1	30.86
	31	87.2	15.05	104.7	18.15	120.9	22.36	132.4	26.31	146.8	30.00	155.0	32.17	162.9	34.64
	33	101.1	18.56	120.9	23.69	137.0	28.78	149.3	32.15	158.8	36.09	163.7	37.08	167.8	37.13
	35	116.9	23.38	139.4	30.07	155.7	34.29	160.1	36.73	162.4	38.99	166.3	39.35	170.9	39.55
	37	116.9	24.77	139.4	31.92	155.7	36.20	157.9	38.92	159.6	41.12	164.1	41.27	168.0	41.38
	39	116.9	26.71	139.4	33.92	152.8	38.19	155.1	41.63	157.4	43.16	161.3	43.23	165.8	43.28
41	113.9	28.64	135.8	35.92	146.3	40.27	148.6	45.03	150.5	45.03	154.9	45.39	158.8	45.75	
43	111.1	30.08	132.4	37.42	140.2	42.71	142.5	43.19	144.4	43.10	148.7	43.34	152.4	43.46	
46	104.1	29.36	124.1	36.12	127.9	40.53	130.2	40.53	131.9	40.88	135.9	41.11	139.4	41.22	
48	92.1	28.51	107.9	34.80	111.1	38.56	113.1	38.82	114.6	39.01	118.2	39.12	121.3	39.28	

# 7. Capacity Tables

Cooling Capacity (52HP)

Combination (%)	Outdoor air temp. (DB, °C)	Indoor air temp. (DB/WB, °C)													
		20		23		26		27		28		30		32	
		14		16		18		19		20		22		24	
		TC	PI	TC	PI	TC	PI	TC	PI	TC	PI	TC	PI	TC	PI
100	10	15.9	1.66	21.7	2.07	28.9	2.52	40.8	3.08	53.7	3.85	77.4	5.13	102.6	6.80
	12	15.9	1.68	21.7	2.10	28.9	2.55	40.8	3.11	53.7	3.89	77.4	5.19	102.6	6.87
	14	15.9	1.70	21.7	2.12	28.9	2.58	40.8	3.14	53.7	3.93	77.4	5.24	102.6	6.94
	16	15.9	1.71	21.7	2.14	28.9	2.60	40.8	3.18	53.7	3.97	77.4	5.30	102.6	7.01
	18	15.9	1.73	21.7	2.16	28.9	2.63	40.8	3.21	53.7	4.01	77.4	5.35	102.6	7.08
	20	15.9	1.75	21.7	2.18	28.9	2.66	40.8	3.24	53.7	4.05	77.4	5.40	102.6	7.16
	21	15.9	1.77	21.7	2.25	36.0	3.32	47.9	3.86	61.2	4.98	83.5	6.79	107.8	8.05
	23	27.5	3.14	38.0	4.19	50.3	4.70	63.1	5.23	76.4	7.49	95.8	9.69	118.3	11.41
	25	39.3	4.97	51.2	6.29	64.6	7.03	78.6	8.28	91.6	10.77	108.0	14.08	128.8	16.57
	27	51.1	7.86	64.4	9.35	79.0	10.53	93.4	12.59	106.8	15.98	120.3	20.15	139.2	23.07
	29	62.8	10.91	77.6	12.60	93.3	15.46	108.6	18.21	122.0	21.70	132.6	26.05	149.7	28.31
	31	74.6	13.81	90.8	16.65	107.6	20.51	123.8	24.13	137.2	27.52	144.8	30.12	161.3	32.10
	33	86.4	17.02	104.1	21.73	122.0	26.40	138.9	30.62	152.6	33.44	157.3	34.02	161.3	34.76
	35	98.3	20.50	117.0	26.18	136.2	32.53	145.6	36.02	152.6	36.24	157.3	36.38	161.3	36.67
	37	98.3	21.96	117.0	28.08	136.2	34.46	145.6	37.74	150.1	37.92	154.4	38.07	158.1	38.43
	39	98.3	23.54	117.0	30.16	136.2	36.52	145.6	39.58	147.6	39.75	151.9	39.90	155.5	40.28
	41	96.7	25.13	115.1	32.25	134.1	38.58	139.7	41.42	142.8	41.59	146.1	41.73	150.9	42.13
43	93.4	26.59	111.2	34.18	129.5	40.42	134.0	43.01	135.5	43.16	139.7	43.30	143.3	43.71	
46	87.5	28.60	104.2	36.85	121.3	42.87	122.3	45.03	123.6	45.16	127.6	45.29	131.0	45.72	
48	77.4	24.70	92.2	31.88	104.8	36.65	106.3	38.20	107.4	38.33	110.9	38.41	114.0	38.72	
90	10	14.3	1.53	19.5	1.91	26.0	2.40	36.0	2.74	48.4	3.54	69.6	4.67	92.3	6.12
	12	14.3	1.54	19.5	1.93	26.0	2.42	36.0	2.77	48.4	3.58	69.6	4.72	92.3	6.18
	14	14.3	1.56	19.5	1.95	26.0	2.45	36.0	2.80	48.4	3.62	69.6	4.77	92.3	6.25
	16	14.3	1.58	19.5	1.97	26.0	2.47	36.0	2.83	48.4	3.65	69.6	4.82	92.3	6.31
	18	14.3	1.59	19.5	1.99	26.0	2.50	36.0	2.86	48.4	3.69	69.6	4.87	92.3	6.38
	20	14.3	1.61	19.5	2.01	26.0	2.52	36.0	2.89	48.4	3.73	69.6	4.92	92.3	6.44
	21	14.3	1.63	19.5	2.03	32.6	3.18	42.6	3.42	54.5	4.47	75.2	5.41	97.2	7.08
	23	19.4	2.51	28.7	3.49	45.5	4.51	55.2	4.91	66.7	6.58	86.5	8.01	107.0	9.74
	25	30.9	4.25	41.5	5.60	58.4	6.68	67.8	7.77	78.8	9.59	97.7	12.11	116.9	14.08
	27	42.3	6.25	54.3	7.97	71.3	10.36	80.5	11.54	90.9	13.98	108.9	16.30	126.8	18.43
	29	53.8	8.44	67.1	10.94	84.2	14.44	93.1	15.96	103.1	18.45	120.2	20.93	136.7	24.39
	31	65.3	10.56	79.9	14.05	97.1	18.07	105.8	20.37	115.2	22.99	131.4	24.37	146.5	28.35
	33	76.8	13.60	92.7	17.29	110.0	21.91	118.4	24.15	127.4	26.72	142.7	28.88	156.4	31.66
	35	88.4	16.83	105.6	21.28	122.7	26.31	131.0	29.02	139.4	31.56	153.8	33.85	156.4	34.63
	37	88.4	17.87	105.6	22.64	122.7	28.06	131.0	30.83	139.4	33.31	151.4	35.39	154.0	36.18
	39	88.4	18.92	105.6	24.08	122.7	29.70	131.0	32.81	139.4	35.03	148.9	37.31	151.5	37.76
	41	86.1	21.17	102.9	26.70	119.6	32.59	127.7	35.88	135.8	37.82	142.7	39.32	145.2	40.22
43	84.0	22.85	100.3	28.85	116.6	35.60	124.5	38.64	132.4	40.55	136.8	42.00	139.3	42.61	
46	78.7	25.71	94.0	32.85	109.3	40.56	116.7	43.81	120.3	45.05	124.9	45.29	127.2	45.72	
48	69.6	22.47	83.2	28.74	96.7	35.49	103.2	38.20	104.5	38.33	108.5	38.41	110.6	38.72	
80	10	12.2	1.35	16.7	1.69	22.2	2.12	31.4	2.44	41.4	3.13	59.6	4.13	79.0	5.41
	12	12.2	1.37	16.7	1.71	22.2	2.14	31.4	2.47	41.4	3.16	59.6	4.17	79.0	5.47
	14	12.2	1.38	16.7	1.72	22.2	2.16	31.4	2.49	41.4	3.20	59.6	4.22	79.0	5.52
	16	12.2	1.39	16.7	1.74	22.2	2.19	31.4	2.52	41.4	3.23	59.6	4.26	79.0	5.58
	18	12.2	1.41	16.7	1.76	22.2	2.21	31.4	2.54	41.4	3.26	59.6	4.30	79.0	5.64
	20	12.2	1.42	16.7	1.78	22.2	2.23	31.4	2.57	41.4	3.30	59.6	4.35	79.0	5.69
	21	12.2	1.43	16.7	1.83	27.9	2.81	37.5	3.08	46.9	3.95	64.8	4.78	84.0	6.26
	23	21.7	2.64	27.7	3.14	39.4	3.99	49.6	4.42	57.9	5.81	75.4	7.08	93.8	8.61
	25	31.2	3.82	38.7	5.04	50.9	5.90	61.7	6.99	69.0	8.47	86.0	10.71	103.7	12.45
	27	40.6	5.62	49.6	7.17	62.4	9.16	73.8	10.39	80.1	12.36	96.6	14.41	113.5	16.29
	29	50.1	7.29	60.6	9.85	73.9	12.76	85.9	14.36	91.1	16.31	107.3	18.50	123.4	21.56
	31	59.6	8.93	71.6	12.39	85.4	15.98	98.0	18.33	104.3	19.77	117.9	21.33	133.2	24.81
	33	69.0	11.75	82.6	15.25	96.9	18.78	110.2	21.74	116.7	22.71	128.5	25.27	143.0	27.93
	35	78.5	15.37	93.6	19.27	108.7	23.64	116.5	25.96	124.3	28.42	139.4	32.25	152.8	33.59
	37	78.5	16.26	93.6	20.49	108.7	25.08	116.5	27.60	124.3	30.20	139.4	34.04	150.3	35.28
	39	78.5	17.19	93.6	21.66	108.7	26.83	116.5	29.68	124.3	32.46	139.4	35.96	147.9	37.22
	41	76.5	19.01	91.2	24.00	105.9	29.44	113.5	32.53	121.1	35.66	135.8	38.53	141.7	39.41
43	74.6	20.93	88.9	26.19	103.3	32.14	110.7	35.45	118.1	38.97	132.4	41.16	135.8	42.19	
46	69.9	23.28	83.4	29.50	96.8	36.21	103.7	39.46	110.7	43.98	121.1	45.29	124.0	45.72	
48	61.9	20.33	73.7	25.80	85.6	31.67	91.8	34.47	97.9	38.33	105.2	38.41	107.7	38.72	



# 7. Capacity Tables

Cooling Capacity (52HP)

Combination (%)	Outdoor air temp. (DB, °C)	Indoor air temp. (DB/WB, °C)													
		20		23		26		27		28		30		32	
		14		16		18		19		20		22		24	
		TC	PI	TC	PI	TC	PI	TC	PI	TC	PI	TC	PI	TC	PI
70	10	10.6	1.19	14.5	1.49	19.4	1.87	27.3	2.17	36.0	2.77	51.8	3.65	68.7	4.78
	12	10.6	1.21	14.5	1.51	19.4	1.89	27.3	2.19	36.0	2.80	51.8	3.69	68.7	4.83
	14	10.6	1.22	14.5	1.52	19.4	1.91	27.3	2.22	36.0	2.83	51.8	3.73	68.7	4.88
	16	10.6	1.23	14.5	1.54	19.4	1.93	27.3	2.24	36.0	2.86	51.8	3.77	68.7	4.93
	18	10.6	1.25	14.5	1.55	19.4	1.95	27.3	2.26	36.0	2.88	51.8	3.80	68.7	4.98
	20	10.6	1.26	14.5	1.57	19.4	1.97	27.3	2.29	36.0	2.91	51.8	3.84	68.7	5.03
	21	10.6	1.26	16.9	1.84	25.1	2.59	33.8	2.87	41.6	3.50	57.1	4.23	74.0	5.54
	23	15.3	1.90	26.2	3.01	35.1	3.79	45.5	4.11	52.8	5.14	67.9	6.26	84.2	7.61
	25	24.2	3.14	35.5	4.45	45.1	5.22	57.2	6.50	64.0	7.49	78.6	9.47	94.5	11.01
	27	33.1	4.57	44.8	6.34	55.1	7.69	68.9	9.66	75.1	10.92	89.4	12.74	104.7	14.40
	29	42.0	5.80	54.1	8.37	65.1	10.47	80.6	13.14	86.3	14.42	100.1	16.36	115.0	19.06
	31	50.9	7.13	63.4	10.41	75.1	13.10	92.3	16.51	97.5	17.48	110.9	18.85	125.2	21.93
	33	59.8	9.59	72.7	12.66	85.1	15.21	101.9	19.17	108.7	20.08	121.7	22.34	135.2	24.69
	35	68.6	13.13	82.2	16.37	95.2	19.80	101.9	21.66	108.7	23.65	121.7	27.85	135.2	30.53
	37	68.6	13.96	82.2	17.34	95.2	21.04	101.9	23.04	108.7	25.17	121.7	29.64	135.2	32.22
	39	68.6	14.82	82.2	18.48	95.2	22.50	101.9	24.78	108.7	27.19	121.7	31.72	135.2	34.74
	41	66.9	16.39	80.1	20.25	92.7	24.68	99.3	27.18	105.9	29.55	118.6	34.84	131.7	37.44
43	65.2	17.84	78.1	22.07	90.4	26.93	96.9	29.64	103.3	32.27	115.6	38.06	128.5	40.50	
46	61.1	19.82	73.2	24.81	84.7	30.32	90.8	33.02	96.8	36.38	108.4	42.92	120.4	45.16	
48	54.1	17.30	64.7	21.67	75.0	26.51	80.3	28.85	85.6	31.83	95.9	37.56	106.5	38.72	
60	10	9.4	1.03	12.6	1.29	16.8	1.62	23.6	1.89	31.2	2.39	44.9	3.15	59.5	4.13
	12	9.4	1.04	12.6	1.30	16.8	1.64	23.6	1.91	31.2	2.42	44.9	3.19	59.5	4.17
	14	9.4	1.05	12.6	1.32	16.8	1.65	23.6	1.93	31.2	2.44	44.9	3.22	59.5	4.22
	16	9.4	1.06	12.6	1.33	16.8	1.67	23.6	1.95	31.2	2.47	44.9	3.25	59.5	4.26
	18	9.4	1.08	12.6	1.34	16.8	1.69	23.6	1.97	31.2	2.49	44.9	3.29	59.5	4.30
	20	9.4	1.09	12.6	1.36	16.8	1.70	23.6	1.99	31.2	2.52	44.9	3.32	59.5	4.35
	21	9.4	1.09	12.6	1.41	21.0	2.19	27.8	2.41	35.7	3.02	48.7	3.65	63.3	4.78
	23	9.4	1.21	20.8	2.55	29.6	3.27	38.5	3.50	45.0	4.44	56.7	5.41	70.8	6.58
	25	17.4	2.30	29.0	3.85	38.3	4.51	49.5	5.97	54.3	6.47	65.9	8.01	78.3	9.51
	27	25.7	3.35	37.3	5.48	46.9	6.65	59.8	8.31	63.6	9.29	74.0	10.62	85.8	12.25
	29	33.9	4.35	45.5	7.02	55.6	8.86	70.6	10.92	72.9	11.84	82.1	13.32	93.4	15.65
	31	42.2	5.53	53.8	8.39	64.2	10.79	79.2	13.10	82.2	13.75	92.0	14.74	100.9	18.04
	33	50.4	7.70	62.0	10.20	72.9	12.12	85.4	14.69	91.6	15.74	99.3	17.47	108.4	20.54
	35	58.8	11.14	70.2	13.63	81.6	16.33	87.4	17.78	93.1	19.31	104.5	22.56	116.0	26.02
	37	58.8	11.76	70.2	14.39	81.6	17.30	87.4	18.89	93.1	20.48	104.5	23.94	116.0	27.68
	39	58.8	12.51	70.2	15.32	81.6	18.67	87.4	20.27	93.1	22.04	104.5	25.67	116.0	29.66
	41	57.3	13.57	68.4	16.76	79.6	20.28	85.1	22.14	90.7	23.93	101.8	28.17	113.0	32.23
43	55.8	14.74	66.7	18.25	77.6	22.11	83.0	24.13	88.5	26.09	99.3	30.75	110.2	35.21	
46	52.3	16.51	62.5	20.49	72.7	24.86	77.8	27.12	82.9	29.36	93.1	34.65	103.3	40.11	
48	46.3	14.39	55.3	17.88	64.3	21.72	68.8	23.69	73.3	25.66	82.3	30.31	91.4	35.09	
50	10	8.4	0.89	11.5	1.11	16.2	1.40	21.6	1.72	28.5	2.07	41.0	2.73	54.4	3.56
	12	8.4	0.90	11.5	1.13	16.2	1.41	21.6	1.74	28.5	2.09	41.0	2.76	54.4	3.59
	14	8.4	0.91	11.5	1.14	16.2	1.43	21.6	1.75	28.5	2.11	41.0	2.78	54.4	3.63
	16	8.4	0.92	11.5	1.15	16.2	1.44	21.6	1.77	28.5	2.13	41.0	2.81	54.4	3.67
	18	8.4	0.93	11.5	1.16	16.2	1.46	21.6	1.79	28.5	2.15	41.0	2.84	54.4	3.70
	20	8.4	0.94	11.5	1.17	16.2	1.47	21.6	1.81	28.5	2.18	41.0	2.87	54.4	3.74
	21	8.4	0.94	11.5	1.22	20.1	1.89	25.5	2.17	32.4	2.61	44.5	3.16	57.3	4.12
	23	8.4	1.00	18.2	2.07	27.9	2.83	36.0	3.39	41.0	3.84	51.3	4.68	63.3	5.66
	25	15.1	1.83	25.0	3.05	35.7	3.97	47.6	5.49	50.4	5.60	58.0	6.58	69.2	8.00
	27	21.9	2.62	31.7	4.28	44.2	5.53	55.2	7.32	58.6	7.54	64.8	8.62	75.1	10.18
	29	28.7	3.45	38.5	5.52	51.2	7.11	62.1	9.08	66.8	9.73	71.5	10.68	81.1	12.86
	31	35.5	4.38	45.2	6.56	58.3	8.66	67.6	10.12	71.5	10.76	78.2	11.53	87.0	14.15
	33	42.3	6.10	52.0	7.90	65.3	9.72	70.2	11.09	74.5	11.89	84.5	13.67	92.8	15.87
	35	49.1	9.26	58.8	11.14	68.1	13.16	72.8	14.27	77.5	15.39	86.8	17.76	96.7	20.40
	37	49.1	9.82	58.8	11.77	68.1	13.93	72.8	15.11	77.5	16.29	86.8	18.94	96.7	21.66
	39	49.1	10.47	58.8	12.61	68.1	14.92	72.8	16.27	77.5	17.48	86.8	20.17	96.7	23.39
	41	47.9	11.33	57.3	13.66	66.4	16.32	70.9	17.62	75.5	18.94	84.6	22.11	94.2	25.40
43	46.7	12.31	55.8	14.85	64.7	17.75	69.2	19.18	73.6	20.62	82.5	24.11	91.9	27.71	
46	43.8	13.78	52.3	16.66	60.7	19.91	64.8	21.54	69.0	23.15	77.3	27.13	86.1	31.20	
48	38.7	12.01	46.3	14.53	53.7	17.37	57.4	18.80	61.0	20.21	68.4	23.71	76.2	27.27	

**Note**

1. TC: Total Capacity(kW), PI : Power Input(kW, Comp. + Outdoor fan motor)
2. Capacity tables show the average value of conditions which may occur.

# 7. Capacity Tables

◆ ARUM540LTE5

Cooling Capacity (54HP)

Combination (%)	Outdoor air temp. (DB, °C)	Indoor air temp. (DB/WB, °C)													
		20		23		26		27		28		30		32	
		14	16	16	18	18	19	19	20	20	22	22	24	24	
		TC	PI	TC	PI	TC	PI	TC	PI	TC	PI	TC	PI	TC	PI
130	10	21.3	2.07	29.0	2.58	38.7	3.14	54.6	3.83	72.0	4.79	103.6	6.39	137.4	8.46
	12	21.3	2.09	29.0	2.61	38.7	3.18	54.6	3.87	72.0	4.84	103.6	6.46	137.4	8.55
	14	21.3	2.11	29.0	2.64	38.7	3.21	54.6	3.91	72.0	4.89	103.6	6.52	137.4	8.64
	16	21.3	2.13	29.0	2.66	38.7	3.24	54.6	3.95	72.0	4.94	103.6	6.59	137.4	8.73
	18	21.3	2.16	29.0	2.69	38.7	3.27	54.6	3.99	72.0	4.99	103.6	6.66	137.4	8.82
	20	21.3	2.18	29.0	2.72	38.7	3.31	54.6	4.03	72.0	5.04	103.6	6.73	137.4	8.90
	21	21.3	2.20	29.5	2.80	47.9	4.13	63.7	4.80	80.5	6.19	110.3	8.45	141.8	10.02
	23	37.0	3.90	51.5	5.13	66.6	5.85	83.2	6.50	97.4	9.33	124.0	12.06	150.6	14.20
	25	54.7	6.19	66.2	7.70	85.3	8.74	103.7	10.31	114.4	13.40	137.7	17.53	159.5	20.62
	27	71.4	9.86	84.6	11.64	104.0	13.21	123.2	15.79	131.4	20.05	151.4	25.28	168.3	28.48
	29	88.0	13.69	103.1	16.05	122.7	19.40	143.2	22.84	148.3	27.23	165.2	32.68	177.2	36.37
	31	106.8	17.88	123.9	22.06	144.2	26.76	161.2	31.24	165.3	35.63	174.4	44.76	186.4	45.40
	33	125.7	22.04	146.9	28.79	164.9	34.45	174.3	44.72	178.0	44.41	183.5	44.80	196.0	45.43
	35	149.8	29.77	171.6	36.08	177.1	43.79	180.2	44.01	183.1	44.27	188.1	44.67	193.6	44.84
	37	149.8	31.75	169.2	37.87	174.7	43.21	177.1	43.42	180.2	43.69	185.1	44.08	190.6	44.25
	39	149.8	33.80	166.2	39.86	171.6	42.63	174.7	42.84	177.1	43.10	182.6	43.49	188.1	43.66
41	145.9	35.86	159.3	41.85	164.7	42.05	167.2	42.26	170.4	42.52	175.6	42.90	180.3	43.07	
43	142.3	37.82	152.7	41.26	158.0	41.47	160.4	41.68	163.6	41.93	168.6	42.31	173.2	42.47	
46	133.4	40.49	139.3	40.40	144.3	40.61	146.6	40.81	149.6	41.05	154.3	41.42	158.6	41.58	
48	118.0	39.36	121.0	39.47	125.5	39.56	127.5	39.67	130.2	40.01	134.4	40.26	138.1	40.42	
120	10	19.6	1.93	26.8	2.42	35.7	2.94	50.4	3.59	66.4	4.48	95.6	5.98	126.8	7.91
	12	19.6	1.95	26.8	2.44	35.7	2.97	50.4	3.62	66.4	4.53	95.6	6.04	126.8	8.00
	14	19.6	1.98	26.8	2.47	35.7	3.00	50.4	3.66	66.4	4.58	95.6	6.10	126.8	8.08
	16	19.6	2.00	26.8	2.49	35.7	3.03	50.4	3.70	66.4	4.62	95.6	6.17	126.8	8.16
	18	19.6	2.02	26.8	2.52	35.7	3.06	50.4	3.74	66.4	4.67	95.6	6.23	126.8	8.25
	20	19.6	2.04	26.8	2.54	35.7	3.09	50.4	3.77	66.4	4.72	95.6	6.29	126.8	8.33
	21	19.6	2.06	27.2	2.62	45.2	3.94	58.7	4.49	75.0	5.80	102.3	7.91	131.4	9.37
	23	34.0	3.65	48.9	4.88	64.3	5.61	76.6	6.08	92.9	8.72	116.4	11.28	140.5	13.29
	25	53.1	5.79	68.6	7.32	84.1	8.18	95.5	9.64	111.3	12.54	131.3	16.40	149.6	19.29
	27	73.7	9.15	93.3	10.89	104.4	12.26	113.5	14.66	129.8	18.60	146.2	23.46	158.7	26.86
	29	94.6	12.70	112.3	14.66	124.4	18.00	131.9	21.20	148.3	25.26	161.1	30.32	167.9	34.10
	31	114.6	16.08	135.2	19.39	144.7	23.88	151.9	28.10	167.3	32.04	171.9	38.54	177.7	39.26
	33	132.8	19.82	159.5	25.30	169.0	30.74	171.3	35.65	174.3	41.94	179.1	42.42	184.7	42.76
	35	135.5	26.48	161.1	34.30	170.7	37.94	173.1	45.19	176.1	45.41	180.9	45.55	185.6	45.91
	37	135.5	28.48	161.1	36.19	168.3	40.45	170.7	44.24	173.1	44.46	177.9	44.59	182.7	44.95
	39	135.5	30.66	160.6	38.25	165.4	42.90	167.7	43.33	170.1	43.55	175.5	43.68	180.2	44.02
41	132.0	32.84	153.6	40.31	158.7	42.06	161.0	42.42	163.3	42.63	168.1	42.76	172.8	43.10	
43	128.8	35.05	147.1	39.73	152.2	41.11	154.4	41.51	156.7	41.72	161.3	41.84	166.0	42.18	
46	120.7	37.69	134.1	38.79	139.0	39.82	141.1	40.15	143.2	40.35	147.5	40.47	151.9	40.79	
48	106.8	36.92	116.5	38.10	120.8	39.04	122.6	39.28	124.5	39.41	128.4	39.56	132.2	39.72	
110	10	18.0	1.82	24.5	2.27	32.7	2.76	46.1	3.37	60.8	4.21	87.6	5.62	116.1	7.44
	12	18.0	1.84	24.5	2.29	32.7	2.79	46.1	3.40	60.8	4.26	87.6	5.68	116.1	7.51
	14	18.0	1.86	24.5	2.32	32.7	2.82	46.1	3.44	60.8	4.30	87.6	5.73	116.1	7.59
	16	18.0	1.88	24.5	2.34	32.7	2.85	46.1	3.48	60.8	4.34	87.6	5.79	116.1	7.67
	18	18.0	1.89	24.5	2.37	32.7	2.88	46.1	3.51	60.8	4.39	87.6	5.85	116.1	7.75
	20	18.0	1.91	24.5	2.39	32.7	2.91	46.1	3.55	60.8	4.43	87.6	5.91	116.1	7.83
	21	18.0	1.93	24.5	2.46	41.0	3.63	54.2	4.22	67.7	5.45	94.5	7.43	122.1	8.81
	23	32.2	3.43	41.0	4.59	57.4	5.14	70.7	5.72	85.7	8.20	107.4	10.60	132.7	12.49
	25	46.3	5.44	57.4	6.88	73.8	7.69	87.4	9.06	101.8	11.78	120.0	15.41	143.1	18.13
	27	60.5	8.59	73.8	10.23	90.2	11.52	103.8	13.77	118.7	17.48	133.7	22.04	154.7	25.24
	29	74.6	11.93	90.2	13.78	106.7	16.91	120.6	19.92	135.6	23.74	147.3	27.92	163.2	30.97
	31	90.6	15.11	108.8	18.22	125.5	22.44	137.5	26.40	152.5	30.11	160.9	32.29	169.2	34.76
	33	105.0	18.62	125.5	23.77	142.3	28.88	155.1	32.27	164.9	36.22	170.0	37.22	174.3	37.27
	35	121.4	23.46	144.7	30.18	161.7	34.41	166.3	36.87	168.7	39.13	172.7	39.49	177.4	39.69
	37	121.4	24.86	144.7	32.03	161.7	36.33	164.0	39.06	165.7	41.27	170.4	41.42	174.5	41.53
	39	121.4	26.81	144.7	34.04	158.7	38.33	161.0	41.78	163.4	43.32	167.5	43.39	172.2	43.43
41	118.3	28.75	141.0	36.05	151.9	40.42	154.3	45.19	156.3	45.19	160.9	45.55	164.9	45.91	
43	115.4	30.19	137.5	37.55	145.6	42.86	148.0	43.35	149.9	43.25	154.4	43.50	158.3	43.62	
46	108.1	29.46	128.9	36.26	132.8	40.68	135.2	40.68	136.9	41.03	141.1	41.26	144.8	41.37	
48	95.6	28.62	112.0	34.93	115.4	38.70	117.5	38.96	119.0	39.15	122.7	39.26	126.0	39.42	

# 7. Capacity Tables

Cooling Capacity (54HP)

Combination (%)	Outdoor air temp. (DB, °C)	Indoor air temp. (DB/WB, °C)													
		20		23		26		27		28		30		32	
		14		16		18		19		20		22		24	
		TC	PI	TC	PI	TC	PI	TC	PI	TC	PI	TC	PI	TC	PI
100	10	16.5	1.67	22.5	2.08	30.0	2.53	42.3	3.09	55.8	3.86	80.3	5.15	106.5	6.82
	12	16.5	1.69	22.5	2.10	30.0	2.56	42.3	3.12	55.8	3.90	80.3	5.21	106.5	6.89
	14	16.5	1.70	22.5	2.13	30.0	2.59	42.3	3.16	55.8	3.94	80.3	5.26	106.5	6.97
	16	16.5	1.72	22.5	2.15	30.0	2.61	42.3	3.19	55.8	3.99	80.3	5.32	106.5	7.04
	18	16.5	1.74	22.5	2.17	30.0	2.64	42.3	3.22	55.8	4.03	80.3	5.37	106.5	7.11
	20	16.5	1.76	22.5	2.19	30.0	2.67	42.3	3.25	55.8	4.07	80.3	5.42	106.5	7.18
	21	16.5	1.77	22.5	2.26	37.4	3.33	49.7	3.87	63.6	5.00	86.7	6.82	112.0	8.08
	23	28.6	3.15	39.4	4.21	52.3	4.72	65.5	5.25	79.4	7.52	99.5	9.73	122.9	11.46
	25	40.8	4.99	53.1	6.31	67.1	7.05	81.6	8.31	95.2	10.81	112.2	14.13	133.7	16.63
	27	53.0	7.89	66.9	9.39	82.0	10.57	97.0	12.63	111.0	16.04	124.9	20.22	144.6	23.15
	29	65.3	10.95	80.6	12.64	96.9	15.52	112.7	18.27	126.7	21.78	137.7	26.14	155.4	28.41
	31	77.5	13.86	94.3	16.71	111.8	20.59	128.5	24.22	142.5	27.62	150.4	30.23	167.5	32.21
	33	89.7	17.08	108.1	21.81	126.6	26.50	144.3	30.73	158.5	33.56	163.4	34.14	167.5	34.89
	35	102.1	20.58	121.5	26.27	141.5	32.65	151.2	36.15	158.5	36.37	163.4	36.51	167.5	36.80
	37	102.1	22.04	121.5	28.18	141.5	34.59	151.2	37.87	155.9	38.06	160.3	38.21	164.2	38.56
	39	102.1	23.63	121.5	30.27	141.5	36.65	151.2	39.72	153.3	39.90	157.8	40.05	161.5	40.42
	41	100.4	25.22	119.6	32.36	139.2	38.71	145.1	41.57	148.3	41.74	151.8	41.89	156.7	42.28
43	97.0	26.69	115.5	34.31	134.5	40.57	139.1	43.16	140.7	43.32	145.1	43.46	148.8	43.87	
46	90.9	28.71	108.2	36.98	126.0	43.03	127.0	45.19	128.4	45.32	132.5	45.45	136.1	45.88	
48	80.4	24.79	95.7	32.00	108.8	36.78	110.4	38.34	111.5	38.47	115.2	38.55	118.3	38.86	
90	10	14.8	1.53	20.2	1.92	27.0	2.41	37.3	2.75	50.2	3.55	72.3	4.69	95.9	6.14
	12	14.8	1.55	20.2	1.94	27.0	2.43	37.3	2.78	50.2	3.59	72.3	4.74	95.9	6.20
	14	14.8	1.57	20.2	1.96	27.0	2.46	37.3	2.81	50.2	3.63	72.3	4.79	95.9	6.27
	16	14.8	1.58	20.2	1.98	27.0	2.48	37.3	2.84	50.2	3.67	72.3	4.84	95.9	6.33
	18	14.8	1.60	20.2	2.00	27.0	2.51	37.3	2.87	50.2	3.70	72.3	4.89	95.9	6.40
	20	14.8	1.62	20.2	2.02	27.0	2.53	37.3	2.90	50.2	3.74	72.3	4.94	95.9	6.46
	21	14.8	1.63	20.2	2.04	33.9	3.19	44.2	3.43	56.6	4.49	78.1	5.43	100.9	7.11
	23	20.1	2.52	29.8	3.50	47.3	4.53	57.3	4.93	69.2	6.60	89.8	8.04	111.2	9.78
	25	32.1	4.27	43.1	5.62	60.7	6.70	70.5	7.79	81.8	9.62	101.5	12.16	121.4	14.13
	27	44.0	6.27	56.4	7.99	74.1	10.40	83.6	11.59	94.4	14.03	113.1	16.36	131.7	18.49
	29	55.9	8.47	69.7	10.98	87.5	14.49	96.7	16.02	107.0	18.52	124.8	21.01	141.9	24.48
	31	67.8	10.60	83.0	14.10	100.9	18.14	109.8	20.44	119.7	23.07	136.5	24.46	152.2	28.45
	33	79.7	13.64	96.3	17.36	114.2	21.98	123.0	24.24	132.3	26.82	148.1	28.98	162.5	31.78
	35	91.8	16.89	109.6	21.36	127.4	26.41	136.1	29.13	144.7	31.67	159.7	33.97	162.5	34.75
	37	91.8	17.93	109.6	22.72	127.4	28.16	136.1	30.94	144.7	33.43	157.2	35.51	159.9	36.31
	39	91.8	18.98	109.6	24.17	127.4	29.80	136.1	32.93	144.7	35.15	154.6	37.44	157.3	37.89
	41	89.5	21.24	106.8	26.79	124.2	32.71	132.6	36.01	141.0	37.95	148.1	39.46	150.8	40.36
43	87.2	22.93	104.2	28.95	121.1	35.73	129.3	38.78	137.5	40.69	142.0	42.15	144.6	42.77	
46	81.8	25.81	97.6	32.97	113.5	40.71	121.2	43.97	125.0	45.21	129.7	45.45	132.1	45.88	
48	72.3	22.56	86.4	28.84	100.4	35.62	107.2	38.34	108.5	38.47	112.7	38.55	114.8	38.86	
80	10	12.7	1.36	17.3	1.69	23.1	2.13	32.6	2.45	43.0	3.14	61.9	4.14	82.0	5.43
	12	12.7	1.37	17.3	1.71	23.1	2.15	32.6	2.47	43.0	3.18	61.9	4.19	82.0	5.48
	14	12.7	1.38	17.3	1.73	23.1	2.17	32.6	2.50	43.0	3.21	61.9	4.23	82.0	5.54
	16	12.7	1.40	17.3	1.75	23.1	2.20	32.6	2.53	43.0	3.24	61.9	4.28	82.0	5.60
	18	12.7	1.41	17.3	1.76	23.1	2.22	32.6	2.55	43.0	3.27	61.9	4.32	82.0	5.66
	20	12.7	1.43	17.3	1.78	23.1	2.24	32.6	2.58	43.0	3.31	61.9	4.36	82.0	5.71
	21	12.7	1.44	17.3	1.83	29.0	2.82	38.9	3.09	48.7	3.97	67.3	4.80	87.2	6.28
	23	22.5	2.65	28.7	3.15	40.9	4.00	51.5	4.44	60.2	5.83	78.3	7.11	97.4	8.65
	25	32.4	3.84	40.1	5.05	52.9	5.92	64.1	7.01	71.7	8.50	89.3	10.75	107.7	12.50
	27	42.2	5.64	51.5	7.20	64.8	9.19	76.6	10.43	83.2	12.40	100.4	14.46	117.9	16.35
	29	52.0	7.32	62.9	9.88	76.8	12.81	89.2	14.42	94.7	16.37	111.4	18.57	128.1	21.64
	31	61.8	8.96	74.3	12.44	88.7	16.04	101.8	18.40	108.3	19.84	122.4	21.40	138.3	24.90
	33	71.7	11.79	85.7	15.31	100.7	18.85	114.5	21.81	121.2	22.80	133.5	25.36	148.5	28.03
	35	81.5	15.43	97.2	19.34	112.9	23.73	121.0	26.06	129.1	28.53	144.7	32.36	158.7	33.71
	37	81.5	16.32	97.2	20.56	112.9	25.17	121.0	27.70	129.1	30.31	144.7	34.16	156.1	35.41
	39	81.5	17.25	97.2	21.74	112.9	26.92	121.0	29.78	129.1	32.57	144.7	36.09	153.5	37.35
	41	79.5	19.08	94.7	24.09	110.0	29.55	117.9	32.65	125.8	35.79	141.0	38.67	147.1	39.56
43	77.5	21.00	92.4	26.29	107.3	32.25	115.0	35.58	122.6	39.11	137.5	41.31	141.0	42.34	
46	72.6	23.37	86.6	29.61	100.5	36.34	107.7	39.60	114.9	44.13	125.8	45.45	128.7	45.88	
48	64.2	20.41	76.6	25.89	88.9	31.78	95.3	34.59	101.7	38.47	109.2	38.55	111.9	38.86	

# 7. Capacity Tables

Cooling Capacity (54HP)

Combination (%)	Outdoor air temp. (DB, °C)	Indoor air temp. (DB/WB, °C)													
		20		23		26		27		28		30		32	
		14		16		18		19		20		22		24	
		TC	PI	TC	PI	TC	PI	TC	PI	TC	PI	TC	PI	TC	PI
70	10	11.1	1.20	15.1	1.50	20.1	1.88	28.4	2.18	37.4	2.78	53.8	3.66	71.4	4.80
	12	11.1	1.21	15.1	1.51	20.1	1.90	28.4	2.20	37.4	2.81	53.8	3.70	71.4	4.85
	14	11.1	1.22	15.1	1.53	20.1	1.92	28.4	2.22	37.4	2.84	53.8	3.74	71.4	4.90
	16	11.1	1.24	15.1	1.54	20.1	1.94	28.4	2.25	37.4	2.87	53.8	3.78	71.4	4.95
	18	11.1	1.25	15.1	1.56	20.1	1.96	28.4	2.27	37.4	2.89	53.8	3.82	71.4	5.00
	20	11.1	1.26	15.1	1.58	20.1	1.98	28.4	2.29	37.4	2.92	53.8	3.86	71.4	5.05
	21	11.1	1.27	17.6	1.85	26.1	2.60	35.1	2.88	43.2	3.51	59.3	4.24	76.8	5.56
	23	15.8	1.91	27.2	3.02	36.5	3.80	47.3	4.13	54.8	5.16	70.5	6.28	87.5	7.64
	25	25.1	3.15	36.9	4.47	46.8	5.24	59.4	6.52	66.4	7.52	81.6	9.50	98.1	11.05
	27	34.4	4.59	46.5	6.36	57.2	7.72	71.6	9.70	78.0	10.96	92.8	12.79	108.8	14.45
	29	43.6	5.82	56.2	8.40	67.6	10.50	83.7	13.19	89.6	14.47	104.0	16.42	119.4	19.13
	31	52.9	7.16	65.8	10.45	78.0	13.15	95.9	16.57	101.3	17.54	115.1	18.92	130.0	22.01
	33	62.1	9.63	75.4	12.71	88.3	15.27	105.8	19.24	112.9	20.15	126.4	22.42	140.4	24.78
	35	71.3	13.18	85.3	16.43	98.8	19.88	105.8	21.74	112.9	23.74	126.4	27.95	140.4	30.64
	37	71.3	14.01	85.3	17.40	98.8	21.12	105.8	23.12	112.9	25.26	126.4	29.74	140.4	32.34
	39	71.3	14.88	85.3	18.55	98.8	22.58	105.8	24.87	112.9	27.28	126.4	31.83	140.4	34.87
	41	69.5	16.45	83.1	20.32	96.3	24.77	103.1	27.28	110.0	29.66	123.1	34.96	136.8	37.58
	43	67.7	17.90	81.1	22.15	93.9	27.03	100.6	29.75	107.3	32.39	120.1	38.19	133.4	40.64
46	63.5	19.89	76.0	24.90	88.0	30.43	94.3	33.14	100.5	36.51	112.5	43.08	125.0	45.33	
48	56.2	17.36	67.2	21.75	77.9	26.61	83.4	28.96	88.9	31.94	99.5	37.70	110.6	38.86	
60	10	9.7	1.05	13.0	1.31	17.4	1.65	24.6	1.92	32.4	2.43	46.6	3.21	61.8	4.20
	12	9.7	1.06	13.0	1.33	17.4	1.67	24.6	1.94	32.4	2.46	46.6	3.24	61.8	4.25
	14	9.7	1.07	13.0	1.34	17.4	1.68	24.6	1.96	32.4	2.49	46.6	3.28	61.8	4.29
	16	9.7	1.08	13.0	1.35	17.4	1.70	24.6	1.98	32.4	2.51	46.6	3.31	61.8	4.34
	18	9.7	1.09	13.0	1.37	17.4	1.72	24.6	2.00	32.4	2.54	46.6	3.35	61.8	4.38
	20	9.7	1.11	13.0	1.38	17.4	1.73	24.6	2.02	32.4	2.56	46.6	3.38	61.8	4.43
	21	9.7	1.11	13.0	1.43	21.8	2.23	28.8	2.45	37.1	3.07	50.6	3.72	65.7	4.87
	23	9.7	1.23	21.6	2.59	30.8	3.33	39.9	3.56	46.8	4.52	58.8	5.51	73.5	6.70
	25	18.1	2.34	30.2	3.91	39.7	4.59	51.4	6.08	56.4	6.59	68.4	8.16	81.3	9.68
	27	26.7	3.41	38.7	5.57	48.7	6.77	62.1	8.46	66.0	9.45	76.9	10.81	89.1	12.46
	29	35.2	4.43	47.3	7.14	57.7	9.02	73.3	11.11	75.7	12.05	85.3	13.55	96.9	15.93
	31	43.8	5.63	55.8	8.54	66.7	10.98	82.3	13.33	85.3	14.00	95.5	15.00	104.8	18.36
	33	52.3	7.84	64.4	10.38	75.7	12.33	88.7	14.95	95.1	16.02	103.1	17.78	112.6	20.91
	35	61.0	11.18	72.9	13.68	84.8	16.39	90.7	17.85	96.7	19.38	108.5	22.64	120.4	26.11
	37	61.0	11.81	72.9	14.44	84.8	17.36	90.7	18.96	96.7	20.56	108.5	24.03	120.4	27.78
	39	61.0	12.56	72.9	15.37	84.8	18.74	90.7	20.34	96.7	22.12	108.5	25.76	120.4	29.77
	41	59.5	13.62	71.0	16.82	82.6	20.35	88.4	22.22	94.2	24.01	105.8	28.28	117.3	32.35
	43	58.0	14.80	69.3	18.32	80.6	22.19	86.2	24.21	91.9	26.19	103.1	30.87	114.4	35.33
46	54.3	16.57	64.9	20.57	75.5	24.95	80.8	27.22	86.1	29.47	96.7	34.78	107.2	40.26	
48	48.1	14.44	57.4	17.95	66.8	21.80	71.5	23.77	76.2	25.75	85.5	30.42	94.9	35.22	
50	10	8.7	0.92	11.9	1.15	16.8	1.45	22.4	1.78	29.6	2.14	42.6	2.82	56.5	3.67
	12	8.7	0.93	11.9	1.16	16.8	1.46	22.4	1.79	29.6	2.16	42.6	2.85	56.5	3.71
	14	8.7	0.94	11.9	1.18	16.8	1.48	22.4	1.81	29.6	2.18	42.6	2.88	56.5	3.75
	16	8.7	0.95	11.9	1.19	16.8	1.49	22.4	1.83	29.6	2.20	42.6	2.91	56.5	3.79
	18	8.7	0.96	11.9	1.20	16.8	1.51	22.4	1.85	29.6	2.23	42.6	2.94	56.5	3.83
	20	8.7	0.97	11.9	1.21	16.8	1.52	22.4	1.87	29.6	2.25	42.6	2.97	56.5	3.87
	21	8.7	0.98	11.9	1.26	20.9	1.95	26.5	2.24	33.6	2.70	46.2	3.26	59.5	4.25
	23	8.7	1.04	18.9	2.14	29.0	2.92	37.4	3.50	42.6	3.97	53.2	4.83	65.7	5.85
	25	15.7	1.89	25.9	3.15	37.0	4.10	49.4	5.67	52.3	5.78	60.2	6.80	71.9	8.27
	27	22.7	2.71	32.9	4.43	45.9	5.71	57.3	7.56	60.8	7.79	67.3	8.91	78.0	10.52
	29	29.8	3.56	40.0	5.71	53.2	7.34	64.5	9.38	69.3	10.05	74.3	11.04	84.2	13.29
	31	36.8	4.53	47.0	6.78	60.5	8.94	70.2	10.46	74.2	11.12	81.2	11.92	90.4	14.62
	33	43.9	6.31	54.0	8.17	67.8	10.04	72.9	11.47	77.3	12.28	87.8	14.12	96.4	16.40
	35	51.0	9.29	61.0	11.18	70.7	13.21	75.6	14.33	80.5	15.44	90.2	17.82	100.4	20.48
	37	51.0	9.85	61.0	11.81	70.7	13.98	75.6	15.17	80.5	16.35	90.2	19.01	100.4	21.73
	39	51.0	10.51	61.0	12.66	70.7	14.98	75.6	16.32	80.5	17.55	90.2	20.25	100.4	23.48
	41	49.7	11.37	59.5	13.70	68.9	16.38	73.7	17.68	78.4	19.01	87.9	22.19	97.9	25.49
	43	48.5	12.35	58.0	14.91	67.2	17.82	71.8	19.25	76.5	20.70	85.7	24.20	95.4	27.81
46	45.4	13.83	54.3	16.72	63.0	19.99	67.3	21.62	71.7	23.24	80.3	27.23	89.5	31.31	
48	40.2	12.06	48.1	14.58	55.7	17.43	59.6	18.87	63.4	20.28	71.0	23.80	79.1	27.37	

**Note**

1. TC: Total Capacity(kW), PI : Power Input(kW, Comp. + Outdoor fan motor)
2. Capacity tables show the average value of conditions which may occur.

# 7. Capacity Tables

◆ ARUM560LTE5

Cooling Capacity (56HP)

Combination (%)	Outdoor air temp. (DB, °C)	Indoor air temp. (DB/WB, °C)													
		20		23		26		27		28		30		32	
		14	PI	16	PI	18	PI	19	PI	20	PI	22	PI	24	PI
130	10	22.1	2.17	30.1	2.71	40.1	3.29	56.6	4.02	74.6	5.02	107.5	6.69	142.5	8.86
	12	22.1	2.19	30.1	2.73	40.1	3.33	56.6	4.06	74.6	5.07	107.5	6.77	142.5	8.96
	14	22.1	2.21	30.1	2.76	40.1	3.36	56.6	4.10	74.6	5.13	107.5	6.84	142.5	9.05
	16	22.1	2.24	30.1	2.79	40.1	3.40	56.6	4.14	74.6	5.18	107.5	6.91	142.5	9.14
	18	22.1	2.26	30.1	2.82	40.1	3.43	56.6	4.19	74.6	5.23	107.5	6.98	142.5	9.24
	20	22.1	2.28	30.1	2.85	40.1	3.47	56.6	4.23	74.6	5.28	107.5	7.05	142.5	9.33
	21	22.1	2.30	30.6	2.93	49.7	4.33	66.0	5.03	83.5	6.49	114.4	8.86	147.0	10.50
	23	38.4	4.09	53.4	5.38	69.1	6.13	86.2	6.82	101.1	9.77	128.6	12.64	156.2	14.88
	25	56.7	6.48	68.7	8.07	88.5	9.16	107.5	10.80	118.7	14.04	142.8	18.37	165.4	21.61
	27	74.0	10.33	87.8	12.20	107.8	13.84	127.7	16.55	136.2	21.01	157.0	26.49	174.5	29.84
	29	91.3	14.34	106.9	16.82	127.2	20.33	148.5	23.94	153.8	28.53	171.3	34.24	183.7	38.11
	31	110.8	18.74	128.5	23.12	149.5	28.04	167.2	32.74	171.4	37.34	180.9	46.90	193.3	47.57
	33	130.3	23.09	152.3	30.17	171.0	36.09	180.7	46.86	184.6	46.53	190.3	46.95	203.2	47.61
	35	155.3	31.20	178.0	37.81	183.7	45.88	186.9	46.11	189.9	46.39	195.0	46.80	200.7	46.99
	37	155.3	33.27	175.5	39.68	181.2	45.28	183.7	45.50	186.9	45.78	191.9	46.19	197.6	46.37
	39	155.3	35.42	172.4	41.77	178.0	44.67	181.2	44.89	183.7	45.16	189.4	45.57	195.0	45.75
41	151.3	37.58	165.2	43.86	170.8	44.06	173.3	44.29	176.7	44.55	182.1	44.95	187.0	45.13	
43	147.6	39.63	158.3	43.24	163.8	43.46	166.3	43.68	169.6	43.94	174.9	44.33	179.6	44.51	
46	138.3	42.42	144.4	42.33	149.7	42.55	152.0	42.76	155.2	43.02	160.1	43.40	164.5	43.57	
48	122.4	41.24	125.4	41.36	130.1	41.45	132.2	41.56	135.0	41.92	139.3	42.19	143.2	42.35	
120	10	20.4	2.03	27.8	2.53	37.0	3.08	52.2	3.76	68.9	4.70	99.1	6.26	131.5	8.29
	12	20.4	2.05	27.8	2.56	37.0	3.11	52.2	3.80	68.9	4.75	99.1	6.33	131.5	8.38
	14	20.4	2.07	27.8	2.58	37.0	3.14	52.2	3.84	68.9	4.80	99.1	6.39	131.5	8.47
	16	20.4	2.09	27.8	2.61	37.0	3.18	52.2	3.88	68.9	4.84	99.1	6.46	131.5	8.55
	18	20.4	2.11	27.8	2.64	37.0	3.21	52.2	3.92	68.9	4.89	99.1	6.53	131.5	8.64
	20	20.4	2.13	27.8	2.66	37.0	3.24	52.2	3.95	68.9	4.94	99.1	6.59	131.5	8.73
	21	20.4	2.16	28.2	2.75	46.9	4.13	60.9	4.71	77.8	6.07	106.1	8.29	136.2	9.82
	23	35.3	3.83	50.7	5.11	66.6	5.88	79.5	6.38	96.3	9.14	120.7	11.82	145.7	13.92
	25	55.0	6.06	71.1	7.67	87.3	8.57	99.1	10.11	115.5	13.14	136.1	17.18	155.1	20.21
	27	76.5	9.58	96.7	11.41	108.3	12.84	117.7	15.36	134.6	19.49	151.6	24.58	164.6	28.14
	29	98.1	13.31	116.4	15.37	129.1	18.86	136.8	22.21	153.8	26.47	167.0	31.78	174.1	35.73
	31	118.8	16.85	140.3	20.31	150.0	25.02	157.5	29.44	173.5	33.58	178.3	40.38	184.3	41.14
	33	137.7	20.77	165.4	26.51	175.3	32.21	177.7	37.36	180.8	43.95	185.7	44.45	191.5	44.81
	35	140.5	27.75	167.1	35.94	177.0	39.75	179.5	47.35	182.6	47.59	187.6	47.73	192.5	48.11
	37	140.5	29.84	167.1	37.92	174.5	42.38	177.0	46.35	179.5	46.59	184.5	46.73	189.4	47.10
	39	140.5	32.13	166.5	40.08	171.5	44.95	173.9	45.40	176.4	45.63	182.0	45.77	186.9	46.13
41	136.9	34.41	159.2	42.24	164.6	44.07	166.9	44.45	169.4	44.67	174.3	44.81	179.2	45.16	
43	133.6	36.73	152.6	41.64	157.9	43.08	160.1	43.50	162.5	43.72	167.3	43.85	172.1	44.19	
46	125.2	39.50	139.1	40.64	144.2	41.73	146.3	42.07	148.5	42.28	153.0	42.41	157.5	42.74	
48	110.7	38.69	120.8	39.92	125.3	40.91	127.2	41.16	129.1	41.29	133.1	41.46	137.1	41.62	
110	10	18.7	1.90	25.4	2.38	33.9	2.89	47.9	3.53	63.1	4.41	90.8	5.88	120.4	7.79
	12	18.7	1.92	25.4	2.40	33.9	2.92	47.9	3.57	63.1	4.46	90.8	5.95	120.4	7.87
	14	18.7	1.94	25.4	2.43	33.9	2.96	47.9	3.60	63.1	4.51	90.8	6.01	120.4	7.96
	16	18.7	1.97	25.4	2.45	33.9	2.99	47.9	3.64	63.1	4.55	90.8	6.07	120.4	8.04
	18	18.7	1.99	25.4	2.48	33.9	3.02	47.9	3.68	63.1	4.60	90.8	6.13	120.4	8.12
	20	18.7	2.01	25.4	2.50	33.9	3.05	47.9	3.72	63.1	4.65	90.8	6.19	120.4	8.20
	21	18.7	2.03	25.4	2.58	42.5	3.81	56.2	4.43	70.2	5.71	98.0	7.79	126.6	9.23
	23	33.4	3.59	42.5	4.80	59.5	5.39	73.3	5.99	88.9	8.59	111.4	11.11	137.6	13.08
	25	48.1	5.70	59.5	7.21	76.5	8.05	90.6	9.50	105.6	12.35	124.5	16.14	148.4	18.99
	27	62.7	9.01	76.5	10.72	93.6	12.07	107.6	14.43	123.1	18.32	138.6	23.10	160.4	26.45
	29	77.4	12.50	93.6	14.44	110.6	17.72	125.1	20.87	140.6	24.88	152.7	29.26	169.2	32.45
	31	93.9	15.83	112.8	19.09	130.2	23.51	142.6	27.66	158.1	31.55	166.9	33.83	175.5	36.42
	33	108.9	19.51	130.2	24.91	147.6	30.26	160.8	33.81	171.0	37.95	176.3	39.00	180.8	39.05
	35	125.9	24.58	150.1	31.63	167.7	36.06	172.5	38.63	174.9	41.01	179.1	41.38	184.0	41.59
	37	125.9	26.05	150.1	33.57	167.7	38.07	170.1	40.93	171.9	43.25	176.7	43.40	181.0	43.52
	39	125.9	28.09	150.1	35.67	164.6	40.16	167.0	43.78	169.5	45.39	173.7	45.47	178.6	45.51
41	122.7	30.12	146.2	37.77	157.6	42.35	160.0	47.35	162.1	47.35	166.8	47.73	171.0	48.11	
43	119.6	31.63	142.6	39.35	151.0	44.91	153.5	45.42	155.5	45.32	160.1	45.58	164.1	45.70	
46	112.1	30.87	133.7	37.99	137.8	42.63	140.2	42.62	142.0	42.99	146.3	43.23	150.1	43.35	
48	99.2	29.98	116.2	36.60	119.7	40.56	121.8	40.83	123.4	41.02	127.3	41.14	130.6	41.30	

# 7. Capacity Tables

Cooling Capacity (56HP)

Combination (%)	Outdoor air temp. (DB, °C)	Indoor air temp. (DB/WB, °C)													
		20		23		26		27		28		30		32	
		14		16		18		19		20		22		24	
		TC	PI	TC	PI	TC	PI	TC	PI	TC	PI	TC	PI	TC	PI
100	10	17.1	1.75	23.3	2.18	31.1	2.66	43.9	3.24	57.9	4.05	83.3	5.40	110.5	7.15
	12	17.1	1.77	23.3	2.20	31.1	2.68	43.9	3.27	57.9	4.09	83.3	5.46	110.5	7.22
	14	17.1	1.78	23.3	2.23	31.1	2.71	43.9	3.31	57.9	4.13	83.3	5.51	110.5	7.30
	16	17.1	1.80	23.3	2.25	31.1	2.74	43.9	3.34	57.9	4.18	83.3	5.57	110.5	7.37
	18	17.1	1.82	23.3	2.27	31.1	2.77	43.9	3.38	57.9	4.22	83.3	5.63	110.5	7.45
	20	17.1	1.84	23.3	2.30	31.1	2.79	43.9	3.41	57.9	4.26	83.3	5.68	110.5	7.52
	21	17.1	1.86	23.3	2.37	38.8	3.49	51.6	4.06	66.0	5.24	89.9	7.14	116.1	8.47
	23	29.7	3.30	40.9	4.41	54.2	4.94	67.9	5.50	82.3	7.88	103.1	10.19	127.4	12.00
	25	42.3	5.23	55.1	6.61	69.6	7.39	84.7	8.71	98.7	11.33	116.3	14.81	138.7	17.42
	27	55.0	8.26	69.4	9.83	85.0	11.07	100.6	13.24	115.1	16.81	129.5	21.19	149.9	24.26
	29	67.7	11.47	83.6	13.25	100.5	16.26	116.9	19.15	131.4	22.82	142.8	27.39	161.2	29.77
	31	80.3	14.52	97.8	17.51	115.9	21.57	133.3	25.38	147.8	28.94	156.0	31.67	173.7	33.75
	33	93.0	17.90	112.1	22.85	131.3	27.76	149.6	32.20	164.3	35.17	169.4	35.78	173.7	36.56
	35	105.8	21.56	126.0	27.53	146.7	34.21	156.8	37.88	164.3	38.11	169.4	38.26	173.7	38.56
	37	105.8	23.09	126.0	29.53	146.7	36.24	156.8	39.68	161.6	39.88	166.3	40.04	170.2	40.41
	39	105.8	24.76	126.0	31.72	146.7	38.40	156.8	41.62	158.9	41.81	163.6	41.96	167.4	42.35
41	104.2	26.42	124.0	33.91	144.4	40.57	150.4	43.56	153.8	43.74	157.4	43.89	162.5	44.30	
43	100.6	27.97	119.7	35.95	139.4	42.51	144.3	45.23	145.9	45.39	150.4	45.54	154.4	45.97	
46	94.3	30.08	112.2	38.75	130.7	45.09	131.7	47.35	133.1	47.49	137.4	47.63	141.1	48.08	
48	83.4	25.97	99.3	33.53	112.8	38.54	114.5	40.18	115.6	40.31	119.5	40.40	122.7	40.72	
90	10	15.4	1.61	21.0	2.01	28.0	2.52	38.7	2.88	52.1	3.72	75.0	4.91	99.4	6.43
	12	15.4	1.62	21.0	2.03	28.0	2.55	38.7	2.91	52.1	3.76	75.0	4.96	99.4	6.50
	14	15.4	1.64	21.0	2.05	28.0	2.58	38.7	2.94	52.1	3.80	75.0	5.02	99.4	6.57
	16	15.4	1.66	21.0	2.07	28.0	2.60	38.7	2.97	52.1	3.84	75.0	5.07	99.4	6.64
	18	15.4	1.68	21.0	2.09	28.0	2.63	38.7	3.00	52.1	3.88	75.0	5.12	99.4	6.70
	20	15.4	1.69	21.0	2.11	28.0	2.66	38.7	3.03	52.1	3.92	75.0	5.17	99.4	6.77
	21	15.4	1.71	21.0	2.13	35.1	3.35	45.8	3.60	58.7	4.70	81.0	5.69	104.6	7.45
	23	20.9	2.64	30.9	3.67	49.0	4.74	59.5	5.17	71.8	6.91	93.1	8.43	115.3	10.25
	25	33.2	4.47	44.7	5.88	62.9	7.02	73.1	8.17	84.9	10.08	105.2	12.74	125.9	14.81
	27	45.6	6.57	58.5	8.38	76.8	10.90	86.7	12.14	97.9	14.70	117.3	17.14	136.5	19.38
	29	58.0	8.87	72.3	11.51	90.7	15.18	100.3	16.78	111.0	19.41	129.4	22.01	147.2	25.65
	31	70.3	11.10	86.1	14.78	104.6	19.01	113.9	21.42	124.1	24.17	141.5	25.63	157.8	29.81
	33	82.7	14.30	99.9	18.19	118.5	23.04	127.5	25.40	137.2	28.10	153.6	30.37	168.5	33.30
	35	95.2	17.70	113.7	22.38	132.2	27.67	141.1	30.52	150.1	33.18	165.7	35.60	168.5	36.42
	37	95.2	18.79	113.7	23.81	132.2	29.51	141.1	32.42	150.1	35.03	163.0	37.21	165.8	38.05
	39	95.2	19.89	113.7	25.32	132.2	31.23	141.1	34.50	150.1	36.84	160.3	39.23	163.2	39.71
41	92.8	22.26	110.8	28.07	128.8	34.28	137.5	37.73	146.2	39.77	153.6	41.35	156.4	42.30	
43	90.5	24.03	108.0	30.34	125.6	37.44	134.1	40.64	142.6	42.64	147.3	44.17	150.0	44.81	
46	84.8	27.04	101.2	34.55	117.7	42.66	125.7	46.07	129.6	47.37	134.5	47.63	137.0	48.08	
48	75.0	23.64	89.6	30.22	104.1	37.33	111.2	40.18	112.5	40.31	116.9	40.40	119.1	40.72	
80	10	13.2	1.42	18.0	1.77	24.0	2.23	33.8	2.57	44.6	3.29	64.1	4.34	85.1	5.69
	12	13.2	1.44	18.0	1.79	24.0	2.25	33.8	2.59	44.6	3.33	64.1	4.39	85.1	5.75
	14	13.2	1.45	18.0	1.81	24.0	2.28	33.8	2.62	44.6	3.36	64.1	4.43	85.1	5.81
	16	13.2	1.47	18.0	1.83	24.0	2.30	33.8	2.65	44.6	3.40	64.1	4.48	85.1	5.87
	18	13.2	1.48	18.0	1.85	24.0	2.32	33.8	2.67	44.6	3.43	64.1	4.53	85.1	5.93
	20	13.2	1.50	18.0	1.87	24.0	2.35	33.8	2.70	44.6	3.47	64.1	4.57	85.1	5.99
	21	13.2	1.50	18.0	1.92	30.1	2.96	40.3	3.24	50.5	4.16	69.7	5.03	90.4	6.59
	23	23.4	2.78	29.8	3.30	42.5	4.19	53.4	4.65	62.4	6.11	81.2	7.45	101.0	9.06
	25	33.6	4.02	41.6	5.30	54.8	6.21	66.4	7.35	74.3	8.91	92.6	11.26	111.6	13.09
	27	43.7	5.91	53.5	7.54	67.2	9.63	79.5	10.93	86.2	13.00	104.1	15.16	122.2	17.13
	29	53.9	7.67	65.3	10.36	79.6	13.42	92.5	15.11	98.2	17.15	115.5	19.46	132.8	22.68
	31	64.1	9.39	77.1	13.03	92.0	16.80	105.6	19.28	112.3	20.79	127.0	22.43	143.4	26.09
	33	74.3	12.35	88.9	16.04	104.4	19.75	118.7	22.86	125.7	23.89	138.4	26.58	154.0	29.37
	35	84.6	16.17	100.8	20.26	117.0	24.86	125.4	27.30	133.8	29.89	150.1	33.91	164.6	35.32
	37	84.6	17.10	100.8	21.54	117.0	26.37	125.4	29.03	133.8	31.76	150.1	35.79	161.9	37.11
	39	84.6	18.07	100.8	22.78	117.0	28.21	125.4	31.21	133.8	34.13	150.1	37.82	159.2	39.14
41	82.4	19.99	98.2	25.24	114.0	30.96	122.2	34.21	130.4	37.50	146.2	40.52	152.6	41.45	
43	80.4	22.01	95.8	27.54	111.2	33.79	119.2	37.28	127.2	40.98	142.6	43.29	146.3	44.36	
46	75.3	24.49	89.8	31.02	104.2	38.08	111.7	41.49	119.2	46.25	130.4	47.63	133.5	48.08	
48	66.6	21.38	79.4	27.13	92.2	33.30	98.8	36.25	105.4	40.31	113.3	40.40	116.0	40.72	

# 7. Capacity Tables

Cooling Capacity (56HP)

Combination (%)	Outdoor air temp. (DB, °C)	Indoor air temp. (DB/WB, °C)													
		20		23		26		27		28		30		32	
		14	16	18	19	20	22	24	TC	PI	TC	PI	TC	PI	
70	10	11.5	1.26	15.6	1.57	20.8	1.97	29.4	2.28	38.8	2.91	55.8	3.84	74.0	5.03
	12	11.5	1.27	15.6	1.59	20.8	1.99	29.4	2.31	38.8	2.94	55.8	3.88	74.0	5.08
	14	11.5	1.28	15.6	1.60	20.8	2.01	29.4	2.33	38.8	2.97	55.8	3.92	74.0	5.13
	16	11.5	1.30	15.6	1.62	20.8	2.03	29.4	2.36	38.8	3.00	55.8	3.96	74.0	5.19
	18	11.5	1.31	15.6	1.63	20.8	2.05	29.4	2.38	38.8	3.03	55.8	4.00	74.0	5.24
	20	11.5	1.32	15.6	1.65	20.8	2.07	29.4	2.40	38.8	3.06	55.8	4.04	74.0	5.29
	21	11.5	1.33	18.2	1.94	27.1	2.72	36.4	3.02	44.8	3.68	61.5	4.45	79.7	5.82
	23	16.4	2.00	28.2	3.17	37.8	3.98	49.0	4.33	56.8	5.40	73.1	6.59	90.7	8.01
	25	26.0	3.30	38.2	4.68	48.6	5.49	61.6	6.84	68.9	7.88	84.7	9.95	101.7	11.57
	27	35.6	4.81	48.2	6.67	59.3	8.09	74.2	10.16	80.9	11.49	96.2	13.40	112.8	15.14
	29	45.2	6.10	58.2	8.80	70.1	11.01	86.8	13.82	93.0	15.16	107.8	17.20	123.8	20.05
	31	54.8	7.50	68.2	10.95	80.8	13.78	99.4	17.37	105.0	18.38	119.4	19.83	134.9	23.06
	33	64.4	10.09	78.2	13.31	91.6	16.00	109.8	20.16	117.0	21.12	131.0	23.49	145.6	25.96
	35	73.9	13.81	88.5	17.22	102.5	20.83	109.8	22.78	117.0	24.88	131.0	29.29	145.6	32.11
	37	73.9	14.68	88.5	18.23	102.5	22.13	109.8	24.23	117.0	26.47	131.0	31.17	145.6	33.89
	39	73.9	15.59	88.5	19.44	102.5	23.66	109.8	26.06	117.0	28.59	131.0	33.36	145.6	36.53
	41	72.0	17.23	86.2	21.29	99.9	25.95	107.0	28.59	114.0	31.08	127.7	36.64	141.9	39.38
43	70.2	18.76	84.1	23.21	97.4	28.32	104.3	31.17	111.2	33.94	124.5	40.02	138.4	42.59	
46	65.8	20.85	78.8	26.10	91.3	31.89	97.8	34.72	104.2	38.26	116.7	45.14	129.7	47.50	
48	58.2	18.19	69.7	22.79	80.7	27.88	86.5	30.34	92.2	33.47	103.2	39.50	114.7	40.72	
60	10	10.1	1.10	13.5	1.38	18.0	1.73	25.5	2.02	33.6	2.56	48.3	3.37	64.1	4.42
	12	10.1	1.12	13.5	1.39	18.0	1.75	25.5	2.04	33.6	2.58	48.3	3.41	64.1	4.46
	14	10.1	1.13	13.5	1.41	18.0	1.77	25.5	2.06	33.6	2.61	48.3	3.44	64.1	4.51
	16	10.1	1.14	13.5	1.42	18.0	1.79	25.5	2.08	33.6	2.64	48.3	3.48	64.1	4.56
	18	10.1	1.15	13.5	1.44	18.0	1.80	25.5	2.10	33.6	2.66	48.3	3.52	64.1	4.60
	20	10.1	1.16	13.5	1.45	18.0	1.82	25.5	2.13	33.6	2.69	48.3	3.55	64.1	4.65
	21	10.1	1.17	13.5	1.50	22.6	2.34	29.9	2.58	38.5	3.23	52.5	3.91	68.2	5.11
	23	10.1	1.29	22.4	2.72	31.9	3.50	41.4	3.74	48.5	4.75	61.0	5.79	76.3	7.04
	25	18.8	2.46	31.3	4.11	41.2	4.82	53.3	6.39	58.5	6.92	71.0	8.57	84.4	10.17
	27	27.7	3.59	40.2	5.86	50.5	7.11	64.4	8.89	68.5	9.93	79.7	11.35	92.4	13.09
	29	36.5	4.65	49.0	7.50	59.8	9.48	76.0	11.68	78.5	12.66	88.4	14.24	100.5	16.74
	31	45.4	5.92	57.9	8.97	69.1	11.54	85.3	14.01	88.5	14.71	99.1	15.76	108.6	19.29
	33	54.3	8.24	66.8	10.91	78.5	12.96	92.0	15.71	98.6	16.83	106.9	18.68	116.7	21.97
	35	63.3	11.72	75.6	14.34	87.9	17.17	94.1	18.70	100.2	20.30	112.6	23.72	124.9	27.36
	37	63.3	12.37	75.6	15.13	87.9	18.19	94.1	19.87	100.2	21.54	112.6	25.18	124.9	29.11
	39	63.3	13.16	75.6	16.11	87.9	19.64	94.1	21.31	100.2	23.18	112.6	27.00	124.9	31.19
	41	61.7	14.27	73.7	17.63	85.7	21.32	91.7	23.28	97.7	25.16	109.7	29.63	121.7	33.90
43	60.1	15.51	71.8	19.19	83.6	23.25	89.4	25.37	95.3	27.44	107.0	32.34	118.7	37.02	
46	56.4	17.37	67.3	21.55	78.3	26.15	83.8	28.52	89.3	30.88	100.2	36.44	111.2	42.18	
48	49.9	15.13	59.6	18.81	69.3	22.84	74.1	24.91	79.0	26.98	88.7	31.87	98.4	36.91	
50	10	9.1	0.97	12.4	1.21	17.4	1.52	23.3	1.87	30.7	2.25	44.1	2.97	58.6	3.87
	12	9.1	0.98	12.4	1.23	17.4	1.54	23.3	1.89	30.7	2.27	44.1	3.00	58.6	3.91
	14	9.1	0.99	12.4	1.24	17.4	1.56	23.3	1.91	30.7	2.30	44.1	3.03	58.6	3.95
	16	9.1	1.00	12.4	1.25	17.4	1.57	23.3	1.93	30.7	2.32	44.1	3.06	58.6	3.99
	18	9.1	1.01	12.4	1.26	17.4	1.59	23.3	1.95	30.7	2.35	44.1	3.09	58.6	4.03
	20	9.1	1.02	12.4	1.28	17.4	1.60	23.3	1.97	30.7	2.37	44.1	3.13	58.6	4.07
	21	9.1	1.03	12.4	1.32	21.7	2.06	27.4	2.36	34.9	2.84	47.9	3.44	61.7	4.48
	23	9.1	1.09	19.6	2.25	30.0	3.08	38.8	3.69	44.1	4.18	55.2	5.09	68.1	6.17
	25	16.3	2.00	26.9	3.32	38.4	4.32	51.3	5.98	54.3	6.09	62.5	7.17	74.5	8.71
	27	23.6	2.86	34.2	4.67	47.6	6.02	59.4	7.96	63.1	8.21	69.7	9.38	80.9	11.08
	29	30.9	3.75	41.4	6.01	55.2	7.74	66.9	9.88	71.9	10.59	77.0	11.63	87.3	14.00
	31	38.2	4.77	48.7	7.15	62.8	9.42	72.8	11.02	77.0	11.72	84.2	12.56	93.7	15.40
	33	45.5	6.65	56.0	8.60	70.3	10.58	75.6	12.08	80.2	12.94	91.0	14.88	100.0	17.28
	35	52.9	9.74	63.3	11.72	73.4	13.84	78.4	15.01	83.4	16.18	93.5	18.67	104.2	21.46
	37	52.9	10.33	63.3	12.38	73.4	14.65	78.4	15.89	83.4	17.14	93.5	19.92	104.2	22.77
	39	52.9	11.01	63.3	13.27	73.4	15.69	78.4	17.11	83.4	18.39	93.5	21.22	104.2	24.60
	41	51.6	11.91	61.7	14.36	71.5	17.16	76.4	18.53	81.3	19.92	91.1	23.26	101.5	26.71
43	50.3	12.94	60.1	15.62	69.7	18.67	74.5	20.17	79.3	21.69	88.9	25.36	99.0	29.14	
46	47.1	14.50	56.4	17.52	65.3	20.94	69.8	22.65	74.3	24.35	83.3	28.53	92.8	32.81	
48	41.7	12.63	49.9	15.28	57.8	18.27	61.8	19.77	65.7	21.25	73.7	24.93	82.1	28.68	

**Note**

1. TC: Total Capacity(kW), PI : Power Input(kW, Comp. + Outdoor fan motor)
2. Capacity tables show the average value of conditions which may occur.

# 7. Capacity Tables

## ◆ ARUM580LTE5

Cooling Capacity (58HP)

Combination (%)	Outdoor air temp. (DB, °C)	Indoor air temp. (DB/WB, °C)													
		20		23		26		27		28		30		32	
		14	16	16	18	18	19	20	20	22	22	24	24		
		TC	PI	TC	PI	TC	PI	TC	PI	TC	PI	TC	PI	TC	PI
130	10	22.9	2.35	31.2	2.93	41.6	3.57	58.7	4.35	77.3	5.44	111.3	7.25	147.6	9.60
	12	22.9	2.37	31.2	2.96	41.6	3.60	58.7	4.40	77.3	5.50	111.3	7.33	147.6	9.70
	14	22.9	2.40	31.2	2.99	41.6	3.64	58.7	4.44	77.3	5.55	111.3	7.41	147.6	9.81
	16	22.9	2.42	31.2	3.02	41.6	3.68	58.7	4.49	77.3	5.61	111.3	7.48	147.6	9.91
	18	22.9	2.45	31.2	3.05	41.6	3.72	58.7	4.53	77.3	5.67	111.3	7.56	147.6	10.01
	20	22.9	2.47	31.2	3.09	41.6	3.75	58.7	4.58	77.3	5.73	111.3	7.63	147.6	10.11
	21	22.9	2.50	31.7	3.18	51.5	4.69	68.4	5.45	86.4	7.03	118.5	9.60	152.3	11.38
	23	39.7	4.43	55.3	5.83	71.5	6.64	89.3	7.38	104.7	10.59	133.2	13.69	161.8	16.13
	25	58.7	7.02	71.1	8.74	91.6	9.93	111.4	11.70	122.9	15.22	147.9	19.90	171.3	23.41
	27	76.6	11.19	90.9	13.21	111.7	15.00	132.3	17.93	141.1	22.76	162.6	28.69	180.8	32.33
	29	94.6	15.54	110.7	18.23	131.8	22.02	153.8	25.93	159.3	30.91	177.4	37.10	190.3	41.29
	31	114.7	20.30	133.1	25.04	154.9	30.38	173.2	35.47	177.6	40.45	187.4	50.82	200.2	51.54
	33	135.0	25.02	157.8	32.68	177.1	39.10	187.2	50.77	191.2	50.41	197.1	50.86	210.5	51.58
	35	160.9	33.80	184.3	40.97	190.2	49.71	193.5	49.96	196.7	50.26	202.0	50.71	207.9	50.91
	37	160.9	36.04	181.7	42.99	187.6	49.05	190.2	49.30	193.5	49.59	198.8	50.04	204.7	50.24
	39	160.9	38.38	178.5	45.25	184.3	48.40	187.6	48.64	190.2	48.93	196.1	49.37	202.0	49.56
	41	156.7	40.71	171.1	47.52	176.9	47.74	179.5	47.98	183.0	48.27	188.6	48.70	193.7	48.89
	43	152.9	42.94	164.0	46.85	169.7	47.08	172.3	47.32	175.7	47.60	181.1	48.03	186.0	48.22
46	143.3	45.96	149.6	45.87	155.0	46.10	157.4	46.33	160.7	46.61	165.8	47.02	170.3	47.21	
48	126.7	44.68	129.9	44.81	134.8	44.91	136.9	45.03	139.8	45.42	144.3	45.71	148.3	45.89	
120	10	21.1	2.20	28.8	2.74	38.3	3.34	54.1	4.07	71.3	5.09	102.7	6.79	136.2	8.98
	12	21.1	2.22	28.8	2.77	38.3	3.37	54.1	4.11	71.3	5.14	102.7	6.86	136.2	9.08
	14	21.1	2.24	28.8	2.80	38.3	3.41	54.1	4.16	71.3	5.20	102.7	6.93	136.2	9.17
	16	21.1	2.27	28.8	2.83	38.3	3.44	54.1	4.20	71.3	5.25	102.7	7.00	136.2	9.27
	18	21.1	2.29	28.8	2.86	38.3	3.48	54.1	4.24	71.3	5.30	102.7	7.07	136.2	9.36
	20	21.1	2.31	28.8	2.89	38.3	3.51	54.1	4.28	71.3	5.36	102.7	7.14	136.2	9.46
	21	21.1	2.34	29.2	2.97	48.6	4.48	63.0	5.10	80.6	6.58	109.9	8.98	141.1	10.64
	23	36.6	4.14	52.5	5.54	69.0	6.37	82.3	6.91	99.8	9.90	125.0	12.81	150.9	15.09
	25	57.0	6.57	73.6	8.31	90.4	9.29	102.6	10.95	119.6	14.23	141.0	18.61	160.7	21.90
	27	79.2	10.38	100.2	12.36	112.1	13.92	121.9	16.64	139.4	21.12	157.0	26.63	170.4	30.49
	29	101.6	14.42	120.6	16.65	133.7	20.44	141.7	24.06	159.3	28.68	173.0	34.43	180.3	38.71
	31	123.1	18.25	145.3	22.01	155.4	27.11	163.1	31.90	179.7	36.38	184.7	43.75	190.9	44.57
	33	142.6	22.50	171.3	28.72	181.5	34.89	184.0	40.47	187.2	47.62	192.3	48.16	198.4	48.54
	35	145.6	30.06	173.1	38.94	183.4	43.07	185.9	51.30	189.1	51.56	194.3	51.71	199.3	52.12
	37	145.6	32.33	173.1	41.09	180.8	45.92	183.4	50.22	185.9	50.47	191.0	50.62	196.2	51.03
	39	145.6	34.81	172.5	43.43	177.6	48.70	180.1	49.19	182.7	49.44	188.5	49.58	193.6	49.98
	41	141.8	37.28	164.9	45.76	170.5	47.74	172.9	48.16	175.4	48.40	180.5	48.54	185.6	48.93
	43	138.3	39.79	158.0	45.11	163.5	46.67	165.8	47.13	168.3	47.36	173.3	47.50	178.3	47.88
46	129.6	42.79	144.1	44.03	149.3	45.21	151.5	45.58	153.8	45.81	158.5	45.94	163.2	46.31	
48	114.7	41.92	125.1	43.25	129.8	44.33	131.7	44.59	133.8	44.74	137.9	44.92	142.0	45.10	
110	10	19.3	2.06	26.3	2.58	35.1	3.14	49.6	3.82	65.3	4.78	94.0	6.38	124.7	8.44
	12	19.3	2.09	26.3	2.60	35.1	3.17	49.6	3.86	65.3	4.83	94.0	6.44	124.7	8.53
	14	19.3	2.11	26.3	2.63	35.1	3.20	49.6	3.91	65.3	4.88	94.0	6.51	124.7	8.62
	16	19.3	2.13	26.3	2.66	35.1	3.23	49.6	3.95	65.3	4.93	94.0	6.58	124.7	8.71
	18	19.3	2.15	26.3	2.69	35.1	3.27	49.6	3.99	65.3	4.98	94.0	6.64	124.7	8.80
	20	19.3	2.17	26.3	2.71	35.1	3.30	49.6	4.03	65.3	5.03	94.0	6.71	124.7	8.89
	21	19.3	2.19	26.3	2.79	44.0	4.12	58.2	4.79	72.7	6.18	101.5	8.44	131.1	10.00
	23	34.6	3.89	44.0	5.21	61.6	5.84	76.0	6.49	92.1	9.31	115.4	12.04	142.5	14.18
	25	49.8	6.17	61.6	7.81	79.3	8.73	93.8	10.29	109.4	13.38	128.9	17.49	153.7	20.58
	27	65.0	9.76	79.3	11.61	96.9	13.08	111.5	15.63	127.5	19.85	143.6	25.02	166.1	28.65
	29	80.2	13.55	96.9	15.64	114.6	19.20	129.6	22.61	145.7	26.95	158.2	31.70	175.3	35.16
	31	97.3	17.15	116.8	20.68	134.8	25.48	147.7	29.97	163.8	34.18	172.8	36.66	181.7	39.46
	33	112.8	21.14	134.8	26.99	152.8	32.79	166.6	36.64	177.1	41.12	182.6	42.25	187.2	42.31
	35	130.4	26.63	155.4	34.26	173.6	39.07	178.6	41.85	181.2	44.43	185.5	44.84	190.6	45.06
	37	130.4	28.23	155.4	36.37	173.6	41.24	176.1	44.34	178.0	46.86	183.0	47.02	187.4	47.15
	39	130.4	30.43	155.4	38.64	170.5	43.51	173.0	47.43	175.5	49.18	179.9	49.26	184.9	49.31
	41	127.0	32.64	151.5	40.92	163.2	45.89	165.7	51.30	167.9	51.30	172.8	51.71	177.1	52.12
	43	123.9	34.27	147.7	42.63	156.4	48.66	159.0	49.21	161.0	49.10	165.8	49.38	170.0	49.52
46	116.1	33.45	138.4	41.16	142.7	46.18	145.2	46.18	147.1	46.58	151.6	46.84	155.5	46.96	
48	102.7	32.49	120.3	39.65	123.9	43.94	126.2	44.23	127.8	44.45	131.8	44.57	135.3	44.75	



# 7. Capacity Tables

Cooling Capacity (58HP)

Combination (%)	Outdoor air temp. (DB, °C)	Indoor air temp. (DB/WB, °C)													
		20		23		26		27		28		30		32	
		14		16		18		19		20		22		24	
		TC	PI	TC	PI	TC	PI	TC	PI	TC	PI	TC	PI	TC	PI
100	10	17.7	1.89	24.2	2.36	32.2	2.88	45.5	3.51	59.9	4.39	86.3	5.85	114.4	7.74
	12	17.7	1.91	24.2	2.39	32.2	2.91	45.5	3.55	59.9	4.43	86.3	5.91	114.4	7.83
	14	17.7	1.93	24.2	2.41	32.2	2.94	45.5	3.58	59.9	4.48	86.3	5.97	114.4	7.91
	16	17.7	1.95	24.2	2.44	32.2	2.97	45.5	3.62	59.9	4.52	86.3	6.03	114.4	7.99
	18	17.7	1.97	24.2	2.46	32.2	3.00	45.5	3.66	59.9	4.57	86.3	6.10	114.4	8.07
	20	17.7	1.99	24.2	2.49	32.2	3.03	45.5	3.69	59.9	4.62	86.3	6.16	114.4	8.15
	21	17.7	2.01	24.2	2.56	40.1	3.78	53.4	4.40	68.3	5.67	93.2	7.74	120.3	9.17
	23	30.7	3.57	42.3	4.78	56.1	5.36	70.3	5.95	85.3	8.54	106.8	11.04	132.0	13.01
	25	43.8	5.66	57.1	7.16	72.1	8.01	87.7	9.44	102.2	12.27	120.5	16.05	143.6	18.88
	27	57.0	8.95	71.8	10.66	88.1	12.00	104.2	14.34	119.2	18.21	134.2	22.96	155.3	26.29
	29	70.1	12.43	86.6	14.35	104.1	17.62	121.1	20.75	136.1	24.73	147.8	29.68	166.9	32.26
	31	83.2	15.74	101.3	18.97	120.0	23.37	138.0	27.50	153.1	31.36	161.5	34.32	179.9	36.57
	33	96.3	19.40	116.1	24.76	136.0	30.08	154.9	34.89	170.2	38.10	175.5	38.76	179.9	39.61
	35	109.6	23.36	130.5	29.83	152.0	37.07	162.4	41.04	170.2	41.29	175.5	41.45	179.9	41.78
	37	109.6	25.02	130.5	31.99	152.0	39.27	162.4	42.99	167.4	43.21	172.2	43.38	176.3	43.78
	39	109.6	26.82	130.5	34.37	152.0	41.61	162.4	45.10	164.6	45.30	169.5	45.46	173.4	45.89
41	107.9	28.63	128.4	36.74	149.6	43.95	155.8	47.20	159.3	47.38	163.0	47.55	168.3	48.00	
43	104.2	30.30	124.0	38.95	144.4	46.05	149.4	49.00	151.1	49.18	155.8	49.34	159.9	49.80	
46	97.6	32.59	116.2	41.99	135.3	48.85	136.4	51.30	137.9	51.45	142.3	51.60	146.1	52.09	
48	86.4	28.14	102.8	36.33	116.8	41.76	118.6	43.53	119.8	43.67	123.7	43.77	127.1	44.12	
90	10	15.9	1.74	21.7	2.17	29.0	2.73	40.1	3.12	53.9	4.04	77.6	5.32	103.0	6.97
	12	15.9	1.76	21.7	2.20	29.0	2.76	40.1	3.16	53.9	4.08	77.6	5.38	103.0	7.04
	14	15.9	1.78	21.7	2.22	29.0	2.79	40.1	3.19	53.9	4.12	77.6	5.43	103.0	7.12
	16	15.9	1.80	21.7	2.24	29.0	2.82	40.1	3.22	53.9	4.16	77.6	5.49	103.0	7.19
	18	15.9	1.82	21.7	2.27	29.0	2.85	40.1	3.25	53.9	4.21	77.6	5.55	103.0	7.26
	20	15.9	1.83	21.7	2.29	29.0	2.88	40.1	3.29	53.9	4.25	77.6	5.60	103.0	7.34
	21	15.9	1.85	21.7	2.31	36.4	3.62	47.5	3.90	60.8	5.10	83.9	6.16	108.4	8.07
	23	21.6	2.87	32.0	3.97	50.8	5.14	61.6	5.60	74.3	7.49	96.4	9.13	119.4	11.10
	25	34.4	4.84	46.3	6.38	65.2	7.61	75.7	8.85	87.9	10.92	109.0	13.80	130.4	16.05
	27	47.2	7.12	60.6	9.08	79.5	11.81	89.8	13.15	101.4	15.93	121.5	18.58	141.4	21.00
	29	60.0	9.61	74.9	12.47	93.9	16.45	103.9	18.18	115.0	21.02	134.0	23.85	152.4	27.79
	31	72.8	12.03	89.2	16.01	108.3	20.59	118.0	23.20	128.5	26.19	146.6	27.77	163.4	32.30
	33	85.6	15.49	103.4	19.70	122.7	24.96	132.1	27.52	142.1	30.45	159.1	32.90	174.5	36.08
	35	98.6	19.18	117.7	24.25	136.9	29.98	146.2	33.07	155.4	35.95	171.6	38.57	174.5	39.45
	37	98.6	20.36	117.7	25.79	136.9	31.97	146.2	35.13	155.4	37.95	168.8	40.32	171.7	41.22
	39	98.6	21.55	117.7	27.43	136.9	33.84	146.2	37.38	155.4	39.91	166.1	42.51	169.0	43.02
41	96.1	24.12	114.7	30.42	133.4	37.14	142.4	40.88	151.5	43.09	159.1	44.80	162.0	45.82	
43	93.7	26.03	111.9	32.87	130.1	40.57	138.9	44.03	147.7	46.20	152.6	47.86	155.3	48.55	
46	87.8	29.30	104.9	37.43	121.9	46.22	130.2	49.92	134.2	51.33	139.3	51.60	141.9	52.09	
48	77.7	25.61	92.8	32.74	107.8	40.44	115.1	43.53	116.6	43.67	121.0	43.77	123.3	44.12	
80	10	13.6	1.54	18.6	1.92	24.8	2.42	35.0	2.78	46.1	3.57	66.4	4.71	88.1	6.16
	12	13.6	1.56	18.6	1.94	24.8	2.44	35.0	2.81	46.1	3.60	66.4	4.75	88.1	6.23
	14	13.6	1.57	18.6	1.96	24.8	2.47	35.0	2.84	46.1	3.64	66.4	4.80	88.1	6.29
	16	13.6	1.59	18.6	1.98	24.8	2.49	35.0	2.87	46.1	3.68	66.4	4.85	88.1	6.36
	18	13.6	1.60	18.6	2.00	24.8	2.52	35.0	2.90	46.1	3.72	66.4	4.90	88.1	6.42
	20	13.6	1.62	18.6	2.02	24.8	2.54	35.0	2.93	46.1	3.75	66.4	4.95	88.1	6.49
	21	13.6	1.63	18.6	2.08	31.1	3.20	41.8	3.51	52.3	4.51	72.2	5.45	93.7	7.13
	23	24.2	3.01	30.9	3.58	44.0	4.54	55.3	5.04	64.6	6.62	84.1	8.07	104.7	9.81
	25	34.8	4.36	43.1	5.74	56.8	6.72	68.8	7.96	77.0	9.65	95.9	12.20	115.6	14.19
	27	45.3	6.41	55.4	8.17	69.6	10.44	82.3	11.84	89.3	14.08	107.8	16.42	126.6	18.56
	29	55.9	8.31	67.6	11.22	82.5	14.54	95.8	16.37	101.7	18.59	119.7	21.08	137.6	24.57
	31	66.4	10.18	79.9	14.12	95.3	18.20	109.3	20.88	116.3	22.52	131.5	24.30	148.6	28.27
	33	77.0	13.38	92.1	17.38	108.1	21.40	122.9	24.77	130.1	25.88	143.4	28.79	159.5	31.82
	35	87.6	17.52	104.4	21.95	121.2	26.94	129.9	29.58	138.6	32.39	155.4	36.74	170.4	38.27
	37	87.6	18.53	104.4	23.34	121.2	28.57	129.9	31.45	138.6	34.41	155.4	38.78	167.7	40.20
	39	87.6	19.58	104.4	24.68	121.2	30.56	129.9	33.81	138.6	36.98	155.4	40.97	164.9	42.41
41	85.3	21.66	101.7	27.35	118.1	33.54	126.6	37.06	135.1	40.63	151.5	43.90	158.0	44.91	
43	83.2	23.85	99.2	29.84	115.2	36.61	123.5	40.39	131.7	44.40	147.7	46.90	151.5	48.07	
46	78.0	26.53	93.0	33.61	108.0	41.25	115.7	44.96	123.5	50.10	135.1	51.60	138.3	52.09	
48	69.0	23.17	82.2	29.39	95.5	36.08	102.4	39.27	109.2	43.67	117.3	43.77	120.1	44.12	

# 7. Capacity Tables

Cooling Capacity (58HP)

Combination (%)	Outdoor air temp. (DB, °C)	Indoor air temp. (DB/WB, °C)													
		20		23		26		27		28		30		32	
		14		16		18		19		20		22		24	
		TC	PI	TC	PI	TC	PI	TC	PI	TC	PI	TC	PI	TC	PI
70	10	11.9	1.36	16.2	1.70	21.6	2.14	30.5	2.47	40.2	3.15	57.8	4.16	76.7	5.45
	12	11.9	1.38	16.2	1.72	21.6	2.16	30.5	2.50	40.2	3.19	57.8	4.20	76.7	5.50
	14	11.9	1.39	16.2	1.74	21.6	2.18	30.5	2.53	40.2	3.22	57.8	4.25	76.7	5.56
	16	11.9	1.40	16.2	1.75	21.6	2.20	30.5	2.55	40.2	3.25	57.8	4.29	76.7	5.62
	18	11.9	1.42	16.2	1.77	21.6	2.23	30.5	2.58	40.2	3.29	57.8	4.33	76.7	5.68
	20	11.9	1.43	16.2	1.79	21.6	2.25	30.5	2.60	40.2	3.32	57.8	4.38	76.7	5.73
	21	11.9	1.44	18.9	2.10	28.0	2.95	37.7	3.27	46.4	3.98	63.7	4.82	82.5	6.31
	23	17.0	2.17	29.2	3.43	39.2	4.32	50.8	4.69	58.9	5.85	75.7	7.14	93.9	8.68
	25	27.0	3.57	39.6	5.07	50.3	5.94	63.8	7.41	71.3	8.53	87.7	10.78	105.4	12.54
	27	36.9	5.21	50.0	7.22	61.5	8.77	76.9	11.01	83.8	12.45	99.7	14.52	116.8	16.41
	29	46.8	6.61	60.3	9.54	72.6	11.92	89.9	14.97	96.3	16.43	111.7	18.64	128.2	21.72
	31	56.8	8.13	70.7	11.86	83.7	14.93	103.0	18.81	108.8	19.91	123.7	21.48	139.7	24.99
	33	66.7	10.93	81.0	14.42	94.9	17.34	113.7	21.84	121.2	22.88	135.7	25.45	150.8	28.13
	35	76.6	14.96	91.6	18.65	106.1	22.56	113.7	24.68	121.2	26.95	135.7	31.73	150.8	34.79
	37	76.6	15.90	91.6	19.75	106.1	23.97	113.7	26.25	121.2	28.67	135.7	33.77	150.8	36.72
	39	76.6	16.89	91.6	21.06	106.1	25.63	113.7	28.24	121.2	30.97	135.7	36.14	150.8	39.58
41	74.6	18.67	89.3	23.07	103.4	28.12	110.8	30.97	118.1	33.67	132.2	39.69	146.9	42.66	
43	72.8	20.32	87.1	25.14	100.9	30.68	108.0	33.77	115.2	36.77	129.0	43.36	143.3	46.14	
46	68.2	22.59	81.6	28.27	94.5	34.55	101.2	37.62	108.0	41.45	120.9	48.91	134.3	51.46	
48	60.3	19.71	72.2	24.70	83.6	30.21	89.6	32.87	95.5	36.26	106.9	42.80	118.8	44.12	
60	10	10.5	1.17	14.0	1.46	18.7	1.83	26.4	2.14	34.8	2.71	50.0	3.57	66.4	4.68
	12	10.5	1.18	14.0	1.47	18.7	1.85	26.4	2.16	34.8	2.74	50.0	3.61	66.4	4.72
	14	10.5	1.19	14.0	1.49	18.7	1.87	26.4	2.18	34.8	2.76	50.0	3.65	66.4	4.77
	16	10.5	1.21	14.0	1.51	18.7	1.89	26.4	2.21	34.8	2.79	50.0	3.68	66.4	4.82
	18	10.5	1.22	14.0	1.52	18.7	1.91	26.4	2.23	34.8	2.82	50.0	3.72	66.4	4.87
	20	10.5	1.23	14.0	1.54	18.7	1.93	26.4	2.25	34.8	2.85	50.0	3.76	66.4	4.92
	21	10.5	1.24	14.0	1.59	23.4	2.48	31.0	2.73	39.9	3.42	54.3	4.13	70.6	5.41
	23	10.5	1.37	23.2	2.88	33.0	3.70	42.9	3.96	50.2	5.03	63.2	6.12	79.0	7.45
	25	19.5	2.60	32.4	4.35	42.7	5.10	55.2	6.76	60.6	7.33	73.5	9.07	87.4	10.76
	27	28.6	3.80	41.6	6.20	52.3	7.53	66.7	9.41	70.9	10.52	82.6	12.02	95.8	13.86
	29	37.8	4.93	50.8	7.94	62.0	10.03	78.7	12.36	81.3	13.40	91.6	15.07	104.1	17.72
	31	47.0	6.27	60.0	9.50	71.6	12.22	88.3	14.83	91.7	15.57	102.6	16.69	112.5	20.42
	33	56.2	8.72	69.2	11.55	81.3	13.72	95.3	16.63	102.1	17.81	110.8	19.77	120.9	23.26
	35	65.5	12.69	78.3	15.53	91.1	18.61	97.4	20.26	103.8	22.00	116.6	25.70	129.3	29.64
	37	65.5	13.40	78.3	16.39	91.1	19.71	97.4	21.52	103.8	23.34	116.6	27.28	129.3	31.54
	39	65.5	14.25	78.3	17.45	91.1	21.28	97.4	23.09	103.8	25.11	116.6	29.25	129.3	33.79
41	63.9	15.46	76.3	19.10	88.7	23.10	94.9	25.23	101.2	27.26	113.6	32.10	126.0	36.72	
43	62.3	16.80	74.4	20.79	86.5	25.19	92.6	27.49	98.7	29.73	110.8	35.04	122.9	40.11	
46	58.4	18.81	69.7	23.35	81.1	28.33	86.8	30.90	92.5	33.45	103.8	39.48	115.2	45.70	
48	51.6	16.39	61.7	20.38	71.7	24.75	76.8	26.99	81.8	29.23	91.8	34.53	101.9	39.99	
50	10	9.4	1.00	12.8	1.25	18.0	1.57	24.1	1.93	31.8	2.32	45.7	3.07	60.7	4.00
	12	9.4	1.01	12.8	1.27	18.0	1.59	24.1	1.95	31.8	2.35	45.7	3.10	60.7	4.04
	14	9.4	1.02	12.8	1.28	18.0	1.61	24.1	1.97	31.8	2.37	45.7	3.13	60.7	4.08
	16	9.4	1.04	12.8	1.29	18.0	1.62	24.1	1.99	31.8	2.40	45.7	3.16	60.7	4.12
	18	9.4	1.05	12.8	1.31	18.0	1.64	24.1	2.01	31.8	2.42	45.7	3.20	60.7	4.17
	20	9.4	1.06	12.8	1.32	18.0	1.66	24.1	2.03	31.8	2.45	45.7	3.23	60.7	4.21
	21	9.4	1.06	12.8	1.37	22.4	2.13	28.4	2.44	36.1	2.94	49.6	3.55	63.9	4.63
	23	9.4	1.13	20.3	2.33	31.1	3.18	40.1	3.81	45.7	4.32	57.2	5.26	70.6	6.37
	25	16.9	2.06	27.9	3.43	39.8	4.46	53.1	6.17	56.2	6.29	64.7	7.40	77.2	8.99
	27	24.4	2.95	35.4	4.82	49.3	6.21	61.6	8.22	65.3	8.48	72.2	9.69	83.8	11.45
	29	32.0	3.88	42.9	6.21	57.1	7.99	69.3	10.21	74.5	10.93	79.8	12.01	90.4	14.46
	31	39.6	4.93	50.5	7.38	65.0	9.73	75.4	11.38	79.7	12.10	87.2	12.97	97.1	15.91
	33	47.1	6.86	58.0	8.89	72.9	10.93	78.3	12.47	83.1	13.36	94.3	15.37	103.6	17.85
	35	54.8	10.55	65.5	12.69	76.0	15.00	81.2	16.26	86.4	17.53	96.9	20.23	107.9	23.25
	37	54.8	11.19	65.5	13.41	76.0	15.87	81.2	17.22	86.4	18.57	96.9	21.58	107.9	24.67
	39	54.8	11.93	65.5	14.37	76.0	17.00	81.2	18.53	86.4	19.92	96.9	22.99	107.9	26.65
41	53.4	12.90	63.9	15.56	74.0	18.59	79.1	20.07	84.2	21.58	94.4	25.20	105.1	28.94	
43	52.1	14.02	62.3	16.92	72.2	20.23	77.2	21.86	82.1	23.50	92.0	27.48	102.5	31.57	
46	48.8	15.71	58.4	18.98	67.7	22.69	72.3	24.54	77.0	26.38	86.3	30.91	96.1	35.54	
48	43.2	13.69	51.6	16.55	59.9	19.79	64.0	21.42	68.1	23.02	76.3	27.01	85.0	31.07	

**Note**

1. TC: Total Capacity(kW), PI : Power Input(kW, Comp. + Outdoor fan motor)
2. Capacity tables show the average value of conditions which may occur.

## 7. Capacity Tables

## ◆ ARUM600LTE5

Cooling Capacity (60HP)

Combination (%)	Outdoor air temp. (DB, °C)	Indoor air temp. (DB/WB, °C)													
		20		23		26		27		28		30		32	
		14	16	16	18	18	19	20	20	22	22	24	24		
		TC	PI	TC	PI	TC	PI	TC	PI	TC	PI	TC	PI	TC	PI
130	10	23.6	2.43	32.2	3.04	43.0	3.70	60.7	4.51	80.0	5.64	115.1	7.52	152.7	9.95
	12	23.6	2.46	32.2	3.07	43.0	3.74	60.7	4.56	80.0	5.70	115.1	7.60	152.7	10.06
	14	23.6	2.48	32.2	3.10	43.0	3.77	60.7	4.60	80.0	5.75	115.1	7.67	152.7	10.16
	16	23.6	2.51	32.2	3.13	43.0	3.81	60.7	4.65	80.0	5.81	115.1	7.75	152.7	10.27
	18	23.6	2.54	32.2	3.17	43.0	3.85	60.7	4.70	80.0	5.87	115.1	7.83	152.7	10.37
	20	23.6	2.56	32.2	3.20	43.0	3.89	60.7	4.75	80.0	5.93	115.1	7.91	152.7	10.48
	21	23.6	2.59	32.7	3.29	53.2	4.86	70.7	5.65	89.4	7.29	122.6	9.94	157.6	11.79
	23	41.1	4.59	57.2	6.04	74.0	6.88	92.4	7.65	108.3	10.97	137.8	14.19	167.4	16.71
	25	60.7	7.28	73.6	9.06	94.8	10.29	115.2	12.13	127.1	15.77	153.0	20.62	177.2	24.26
	27	79.3	11.60	94.0	13.69	115.5	15.54	136.9	18.58	146.0	23.59	168.2	29.74	187.0	33.51
	29	97.8	16.10	114.5	18.89	136.3	22.82	159.1	26.87	164.8	32.03	183.5	38.44	196.9	42.79
	31	118.7	21.04	137.7	25.95	160.2	31.49	179.2	36.76	183.7	41.92	193.8	52.66	207.1	53.41
	33	139.6	25.93	163.2	33.87	183.2	40.52	193.6	52.61	197.8	52.24	203.9	52.71	217.7	53.45
	35	166.4	35.02	190.7	42.45	196.8	51.51	200.2	51.77	203.4	52.08	209.0	52.55	215.1	52.76
	37	166.4	37.35	188.0	44.55	194.1	50.83	196.8	51.09	200.2	51.40	205.6	51.86	211.7	52.06
	39	166.4	39.77	184.7	46.90	190.7	50.15	194.1	50.41	196.8	50.71	202.9	51.16	209.0	51.36
	41	162.1	42.19	177.0	49.24	183.0	49.47	185.7	49.72	189.3	50.02	195.1	50.47	200.3	50.67
	43	158.1	44.50	169.6	48.55	175.5	48.79	178.2	49.04	181.8	49.33	187.3	49.77	192.4	49.97
46	148.2	47.63	154.7	47.53	160.4	47.77	162.9	48.01	166.3	48.30	171.5	48.73	176.2	48.92	
48	131.1	46.30	134.4	46.44	139.4	46.54	141.6	46.67	144.7	47.07	149.3	47.37	153.4	47.55	
120	10	21.8	2.28	29.7	2.84	39.7	3.46	56.0	4.22	73.8	5.27	106.2	7.03	140.9	9.31
	12	21.8	2.30	29.7	2.87	39.7	3.49	56.0	4.26	73.8	5.33	106.2	7.11	140.9	9.41
	14	21.8	2.32	29.7	2.90	39.7	3.53	56.0	4.31	73.8	5.38	106.2	7.18	140.9	9.51
	16	21.8	2.35	29.7	2.93	39.7	3.57	56.0	4.35	73.8	5.44	106.2	7.25	140.9	9.60
	18	21.8	2.37	29.7	2.96	39.7	3.60	56.0	4.40	73.8	5.49	106.2	7.33	140.9	9.70
	20	21.8	2.40	29.7	2.99	39.7	3.64	56.0	4.44	73.8	5.55	106.2	7.40	140.9	9.80
	21	21.8	2.42	30.2	3.08	50.2	4.64	65.2	5.29	83.4	6.82	113.7	9.30	146.0	11.03
	23	37.8	4.30	54.3	5.74	71.4	6.60	85.1	7.16	103.2	10.26	129.3	13.27	156.1	15.63
	25	59.0	6.81	76.2	8.61	93.5	9.62	106.1	11.35	123.7	14.75	145.8	19.29	166.2	22.69
	27	81.9	10.76	103.6	12.81	116.0	14.42	126.1	17.24	144.2	21.89	162.4	27.60	176.3	31.60
	29	105.1	14.94	124.8	17.25	138.3	21.18	146.6	24.94	164.8	29.72	178.9	35.68	186.5	40.11
	31	127.3	18.92	150.3	22.81	160.8	28.10	168.7	33.05	185.9	37.70	191.0	45.34	197.5	46.18
	33	147.6	23.32	177.2	29.76	187.8	36.16	190.4	41.94	193.7	49.34	199.0	49.91	205.2	50.31
	35	150.6	31.15	179.0	40.35	189.7	44.63	192.3	53.16	195.6	53.43	201.0	53.59	206.2	54.01
	37	150.6	33.51	179.0	42.58	187.0	47.59	189.7	52.04	192.3	52.31	197.6	52.46	203.0	52.88
	39	150.6	36.07	178.4	45.00	183.7	50.47	186.3	50.98	189.0	51.23	195.0	51.38	200.3	51.79
	41	146.7	38.64	170.6	47.42	176.4	49.48	178.9	49.91	181.5	50.16	186.7	50.31	192.0	50.70
	43	143.1	41.24	163.5	46.75	169.1	48.37	171.6	48.84	174.1	49.08	179.2	49.23	184.4	49.62
46	134.1	44.34	149.0	45.63	154.5	46.85	156.7	47.23	159.1	47.47	163.9	47.61	168.8	47.99	
48	118.6	43.44	129.4	44.82	134.2	45.93	136.3	46.21	138.4	46.36	142.6	46.55	146.9	46.73	
110	10	20.0	2.14	27.2	2.67	36.3	3.25	51.3	3.96	67.6	4.95	97.3	6.61	129.0	8.75
	12	20.0	2.16	27.2	2.70	36.3	3.28	51.3	4.01	67.6	5.01	97.3	6.68	129.0	8.84
	14	20.0	2.18	27.2	2.73	36.3	3.32	51.3	4.05	67.6	5.06	97.3	6.75	129.0	8.93
	16	20.0	2.21	27.2	2.75	36.3	3.35	51.3	4.09	67.6	5.11	97.3	6.82	129.0	9.02
	18	20.0	2.23	27.2	2.78	36.3	3.39	51.3	4.13	67.6	5.16	97.3	6.89	129.0	9.12
	20	20.0	2.25	27.2	2.81	36.3	3.42	51.3	4.17	67.6	5.22	97.3	6.96	129.0	9.21
	21	20.0	2.27	27.2	2.90	45.5	4.27	60.2	4.97	75.2	6.41	105.0	8.74	135.6	10.36
	23	35.8	4.04	45.5	5.39	63.8	6.05	78.6	6.73	95.3	9.64	119.4	12.47	147.4	14.69
	25	51.5	6.40	63.8	8.09	82.0	9.04	97.1	10.66	113.1	13.86	133.4	18.13	159.0	21.32
	27	67.2	10.11	82.0	12.04	100.3	13.55	115.3	16.20	131.9	20.57	148.5	25.93	171.9	29.69
	29	82.9	14.04	100.2	16.21	118.5	19.90	134.0	23.43	150.7	27.93	163.7	32.85	181.3	36.44
	31	100.6	17.78	120.9	21.43	139.5	26.40	152.8	31.06	169.4	35.42	178.8	37.99	188.0	40.90
	33	116.7	21.91	139.5	27.97	158.1	33.98	172.3	37.97	183.2	42.61	188.9	43.79	193.7	43.85
	35	134.9	27.60	160.8	35.51	179.6	40.48	184.8	43.37	187.4	46.04	191.9	46.46	197.1	46.69
	37	134.9	29.25	160.8	37.69	179.6	42.74	182.2	45.95	184.1	48.56	189.4	48.73	193.9	48.86
	39	134.9	31.54	160.8	40.05	176.4	45.09	178.9	49.15	181.6	50.96	186.1	51.05	191.3	51.10
	41	131.4	33.82	156.7	42.41	168.8	47.55	171.5	53.16	173.7	53.16	178.8	53.59	183.2	54.01
	43	128.2	35.51	152.8	44.18	161.8	50.43	164.4	51.00	166.6	50.89	171.5	51.17	175.9	51.32
46	120.1	34.66	143.2	42.65	147.6	47.86	150.2	47.86	152.1	48.27	156.8	48.54	160.9	48.67	
48	106.3	33.67	124.5	41.09	128.2	45.53	130.6	45.84	132.3	46.06	136.4	46.19	140.0	46.37	

# 7. Capacity Tables

Cooling Capacity (60HP)

Combination (%)	Outdoor air temp. (DB, °C)	Indoor air temp. (DB/WB, °C)													
		20		23		26		27		28		30		32	
		14		16		18		19		20		22		24	
		TC	PI	TC	PI	TC	PI	TC	PI	TC	PI	TC	PI	TC	PI
100	10	18.3	1.96	25.0	2.45	33.3	2.98	47.0	3.64	62.0	4.55	89.3	6.06	118.4	8.03
	12	18.3	1.98	25.0	2.48	33.3	3.01	47.0	3.67	62.0	4.59	89.3	6.13	118.4	8.11
	14	18.3	2.00	25.0	2.50	33.3	3.04	47.0	3.71	62.0	4.64	89.3	6.19	118.4	8.20
	16	18.3	2.02	25.0	2.53	33.3	3.08	47.0	3.75	62.0	4.69	89.3	6.25	118.4	8.28
	18	18.3	2.04	25.0	2.55	33.3	3.11	47.0	3.79	62.0	4.74	89.3	6.32	118.4	8.36
	20	18.3	2.07	25.0	2.58	33.3	3.14	47.0	3.83	62.0	4.78	89.3	6.38	118.4	8.45
	21	18.3	2.09	25.0	2.66	41.5	3.92	55.3	4.56	70.7	5.88	96.4	8.02	124.4	9.51
	23	31.8	3.70	43.8	4.95	58.1	5.55	72.8	6.17	88.2	8.85	110.5	11.44	136.5	13.48
	25	45.4	5.87	59.1	7.42	74.6	8.30	90.7	9.78	105.7	12.72	124.7	16.63	148.6	19.56
	27	58.9	9.28	74.3	11.04	91.1	12.43	107.8	14.86	123.3	18.87	138.8	23.79	160.6	27.24
	29	72.5	12.88	89.6	14.87	107.7	18.26	125.3	21.50	140.8	25.62	152.9	30.76	172.7	33.43
	31	86.1	16.31	104.8	19.66	124.2	24.22	142.8	28.50	158.4	32.50	167.1	35.56	186.1	37.90
	33	99.7	20.10	120.1	25.66	140.7	31.17	160.3	36.16	176.1	39.48	181.5	40.17	186.1	41.05
	35	113.4	24.21	135.0	30.91	157.2	38.41	168.0	42.53	176.1	42.79	181.5	42.95	186.1	43.30
	37	113.4	25.93	135.0	33.15	157.2	40.69	168.0	44.55	173.2	44.77	178.2	44.95	182.4	45.37
	39	113.4	27.80	135.0	35.61	157.2	43.12	168.0	46.73	170.3	46.94	175.3	47.12	179.4	47.55
	41	111.6	29.67	132.9	38.07	154.7	45.55	161.2	48.91	164.7	49.11	168.6	49.28	174.1	49.74
43	107.8	31.40	128.3	40.36	149.4	47.73	154.6	50.78	156.3	50.96	161.2	51.13	165.4	51.61	
46	101.0	33.77	120.2	43.51	140.0	50.62	141.1	53.16	142.6	53.32	147.2	53.47	151.2	53.98	
48	89.3	29.16	106.4	37.65	120.9	43.28	122.6	45.11	123.9	45.25	128.0	45.36	131.5	45.72	
90	10	16.5	1.81	22.5	2.25	30.0	2.83	41.5	3.24	55.8	4.18	80.3	5.52	106.5	7.22
	12	16.5	1.82	22.5	2.28	30.0	2.86	41.5	3.27	55.8	4.23	80.3	5.57	106.5	7.30
	14	16.5	1.84	22.5	2.30	30.0	2.89	41.5	3.30	55.8	4.27	80.3	5.63	106.5	7.38
	16	16.5	1.86	22.5	2.33	30.0	2.92	41.5	3.34	55.8	4.31	80.3	5.69	106.5	7.45
	18	16.5	1.88	22.5	2.35	30.0	2.95	41.5	3.37	55.8	4.36	80.3	5.75	106.5	7.53
	20	16.5	1.90	22.5	2.37	30.0	2.98	41.5	3.41	55.8	4.40	80.3	5.81	106.5	7.60
	21	16.5	1.92	22.5	2.40	37.6	3.76	49.1	4.04	62.9	5.28	86.8	6.39	112.1	8.36
	23	22.4	2.97	33.1	4.12	52.5	5.33	63.7	5.80	76.9	7.76	99.8	9.46	123.5	11.51
	25	35.6	5.02	47.9	6.61	67.4	7.88	78.3	9.17	90.9	11.32	112.7	14.30	134.9	16.63
	27	48.9	7.38	62.7	9.41	82.3	12.23	92.9	13.63	104.9	16.51	125.7	19.25	146.3	21.76
	29	62.1	9.96	77.4	12.92	97.2	17.05	107.5	18.84	118.9	21.79	138.7	24.71	157.7	28.80
	31	75.3	12.47	92.2	16.59	112.1	21.34	122.0	24.05	133.0	27.14	151.6	28.77	169.1	33.47
	33	88.6	16.05	107.0	20.42	126.9	25.87	136.6	28.52	147.0	31.55	164.6	34.10	180.5	37.39
	35	102.0	19.88	121.8	25.13	141.6	31.07	151.2	34.27	160.8	37.26	177.5	39.97	180.5	40.89
	37	102.0	21.09	121.8	26.73	141.6	33.13	151.2	36.40	160.8	39.33	174.6	41.78	177.7	42.72
	39	102.0	22.33	121.8	28.43	141.6	35.06	151.2	38.74	160.8	41.36	171.8	44.05	174.8	44.58
	41	99.4	24.99	118.7	31.52	138.0	38.49	147.3	42.37	156.7	44.65	164.6	46.42	167.5	47.49
43	96.9	26.98	115.7	34.06	134.6	42.04	143.7	45.63	152.8	47.88	157.8	49.59	160.7	50.31	
46	90.8	30.36	108.5	38.79	126.1	47.90	134.7	51.73	138.8	53.19	144.1	53.47	146.8	53.98	
48	80.4	26.54	96.0	33.93	111.6	41.91	119.1	45.11	120.6	45.25	125.2	45.36	127.6	45.72	
80	10	14.1	1.60	19.2	1.99	25.7	2.50	36.2	2.88	47.7	3.70	68.7	4.88	91.2	6.39
	12	14.1	1.61	19.2	2.01	25.7	2.53	36.2	2.91	47.7	3.74	68.7	4.93	91.2	6.45
	14	14.1	1.63	19.2	2.03	25.7	2.56	36.2	2.94	47.7	3.77	68.7	4.98	91.2	6.52
	16	14.1	1.65	19.2	2.06	25.7	2.58	36.2	2.97	47.7	3.81	68.7	5.03	91.2	6.59
	18	14.1	1.66	19.2	2.08	25.7	2.61	36.2	3.00	47.7	3.85	68.7	5.08	91.2	6.65
	20	14.1	1.68	19.2	2.10	25.7	2.64	36.2	3.03	47.7	3.89	68.7	5.13	91.2	6.72
	21	14.1	1.69	19.2	2.16	32.2	3.32	43.2	3.63	54.1	4.67	74.7	5.65	96.9	7.39
	23	25.0	3.12	31.9	3.71	45.5	4.71	57.2	5.22	66.9	6.86	87.0	8.36	108.3	10.17
	25	36.0	4.52	44.6	5.95	58.8	6.97	71.2	8.25	79.6	10.00	99.3	12.64	119.6	14.70
	27	46.9	6.64	57.3	8.47	72.0	10.82	85.2	12.27	92.4	14.59	111.5	17.02	131.0	19.23
	29	57.8	8.61	69.9	11.63	85.3	15.07	99.1	16.96	105.2	19.26	123.8	21.85	142.3	25.46
	31	68.7	10.55	82.6	14.63	98.6	18.87	113.1	21.64	120.3	23.34	136.0	25.18	153.7	29.29
	33	79.6	13.87	95.3	18.01	111.9	22.18	127.2	25.67	134.6	26.82	148.3	29.84	165.0	32.98
	35	90.6	18.15	108.0	22.75	125.4	27.91	134.4	30.66	143.4	33.56	160.8	38.08	176.3	39.66
	37	90.6	19.20	108.0	24.19	125.4	29.61	134.4	32.59	143.4	35.66	160.8	40.19	173.5	41.66
	39	90.6	20.29	108.0	25.57	125.4	31.67	134.4	35.04	143.4	38.32	160.8	42.46	170.6	43.95
	41	88.3	22.45	105.2	28.34	122.2	34.76	131.0	38.41	139.7	42.11	156.7	45.50	163.5	46.54
43	86.1	24.71	102.6	30.93	119.2	37.94	127.7	41.86	136.3	46.01	152.8	48.60	156.7	49.81	
46	80.7	27.49	96.2	34.83	111.7	42.75	119.7	46.59	127.7	51.92	139.7	53.47	143.0	53.98	
48	71.4	24.01	85.1	30.46	98.8	37.39	105.9	40.70	113.0	45.25	121.4	45.36	124.3	45.72	

# 7. Capacity Tables

Cooling Capacity (60HP)

Combination (%)	Outdoor air temp. (DB, °C)	Indoor air temp. (DB/WB, °C)													
		20		23		26		27		28		30		32	
		14		16		18		19		20		22		24	
		TC	PI	TC	PI	TC	PI	TC	PI	TC	PI	TC	PI	TC	PI
70	10	12.3	1.41	16.7	1.76	22.3	2.21	31.5	2.56	41.5	3.27	59.8	4.31	79.3	5.64
	12	12.3	1.43	16.7	1.78	22.3	2.24	31.5	2.59	41.5	3.30	59.8	4.36	79.3	5.70
	14	12.3	1.44	16.7	1.80	22.3	2.26	31.5	2.62	41.5	3.34	59.8	4.40	79.3	5.76
	16	12.3	1.46	16.7	1.82	22.3	2.28	31.5	2.64	41.5	3.37	59.8	4.45	79.3	5.82
	18	12.3	1.47	16.7	1.84	22.3	2.31	31.5	2.67	41.5	3.41	59.8	4.49	79.3	5.88
	20	12.3	1.48	16.7	1.85	22.3	2.33	31.5	2.70	41.5	3.44	59.8	4.54	79.3	5.94
	21	12.3	1.49	19.5	2.18	29.0	3.05	39.0	3.39	48.0	4.13	65.9	4.99	85.4	6.54
	23	17.6	2.24	30.2	3.56	40.5	4.47	52.5	4.86	60.9	6.07	78.3	7.39	97.2	8.99
	25	27.9	3.70	41.0	5.26	52.0	6.16	66.0	7.67	73.8	8.84	90.7	11.18	109.0	13.00
	27	38.2	5.40	51.7	7.48	63.6	9.08	79.5	11.41	86.7	12.90	103.1	15.04	120.8	17.00
	29	48.5	6.85	62.4	9.88	75.1	12.36	93.0	15.52	99.6	17.03	115.5	19.31	132.7	22.51
	31	58.7	8.42	73.1	12.29	86.6	15.47	106.5	19.50	112.5	20.63	127.9	22.26	144.5	25.90
	33	69.0	11.33	83.8	14.95	98.1	17.96	117.6	22.64	125.4	23.71	140.4	26.38	156.0	29.15
	35	79.2	15.51	94.8	19.33	109.8	23.38	117.6	25.57	125.4	27.93	140.4	32.88	156.0	36.05
	37	79.2	16.48	94.8	20.47	109.8	24.84	117.6	27.20	125.4	29.72	140.4	34.99	156.0	38.05
	39	79.2	17.50	94.8	21.82	109.8	26.56	117.6	29.26	125.4	32.10	140.4	37.45	156.0	41.02
	41	77.2	19.35	92.4	23.91	107.0	29.14	114.6	32.10	122.2	34.90	136.8	41.13	152.0	44.21
43	75.3	21.06	90.1	26.06	104.3	31.79	111.8	35.00	119.2	38.11	133.4	44.94	148.2	47.82	
46	70.5	23.41	84.4	29.30	97.8	35.80	104.7	38.98	111.7	42.96	125.0	50.68	138.9	53.33	
48	62.4	20.43	74.7	25.59	86.5	31.30	92.6	34.07	98.8	37.58	110.6	44.35	122.9	45.72	
60	10	10.8	1.20	14.5	1.49	19.3	1.88	27.3	2.19	36.0	2.77	51.8	3.65	68.7	4.79
	12	10.8	1.21	14.5	1.51	19.3	1.90	27.3	2.21	36.0	2.80	51.8	3.69	68.7	4.84
	14	10.8	1.22	14.5	1.52	19.3	1.92	27.3	2.23	36.0	2.83	51.8	3.73	68.7	4.89
	16	10.8	1.23	14.5	1.54	19.3	1.94	27.3	2.26	36.0	2.86	51.8	3.77	68.7	4.94
	18	10.8	1.25	14.5	1.56	19.3	1.96	27.3	2.28	36.0	2.89	51.8	3.81	68.7	4.99
	20	10.8	1.26	14.5	1.57	19.3	1.98	27.3	2.30	36.0	2.92	51.8	3.85	68.7	5.04
	21	10.8	1.27	14.5	1.63	24.2	2.53	32.0	2.79	41.2	3.50	56.2	4.23	73.0	5.54
	23	10.8	1.40	24.0	2.95	34.2	3.79	44.4	4.05	51.9	5.14	65.4	6.27	81.7	7.62
	25	20.1	2.66	33.5	4.46	44.2	5.22	57.2	6.92	62.7	7.50	76.0	9.29	90.4	11.02
	27	29.6	3.89	43.0	6.34	54.1	7.70	69.0	9.63	73.4	10.76	85.4	12.30	99.1	14.19
	29	39.1	5.04	52.5	8.13	64.1	10.27	81.4	12.65	84.1	13.72	94.8	15.43	107.7	18.13
	31	48.7	6.41	62.0	9.72	74.1	12.50	91.4	15.18	94.8	15.93	106.2	17.08	116.4	20.90
	33	58.2	8.93	71.6	11.82	84.1	14.04	98.6	17.02	105.6	18.23	114.6	20.24	125.1	23.80
	35	67.8	13.15	81.0	16.10	94.2	19.28	100.8	21.00	107.4	22.80	120.6	26.64	133.8	30.72
	37	67.8	13.89	81.0	16.99	94.2	20.43	100.8	22.31	107.4	24.18	120.6	28.27	133.8	32.68
	39	67.8	14.77	81.0	18.09	94.2	22.05	100.8	23.93	107.4	26.03	120.6	30.31	133.8	35.02
	41	66.1	16.02	78.9	19.79	91.8	23.94	98.2	26.14	104.7	28.25	117.5	33.27	130.4	38.06
43	64.4	17.41	77.0	21.55	89.5	26.10	95.8	28.49	102.1	30.81	114.6	36.31	127.2	41.57	
46	60.4	19.50	72.1	24.20	83.9	29.36	89.8	32.02	95.6	34.67	107.4	40.92	119.2	47.36	
48	53.4	16.99	63.8	21.12	74.2	25.65	79.4	27.97	84.6	30.29	95.0	35.79	105.4	41.44	
50	10	9.7	1.01	13.2	1.27	18.7	1.59	24.9	1.95	32.9	2.35	47.3	3.10	62.7	4.04
	12	9.7	1.03	13.2	1.28	18.7	1.61	24.9	1.97	32.9	2.37	47.3	3.13	62.7	4.08
	14	9.7	1.04	13.2	1.29	18.7	1.62	24.9	1.99	32.9	2.40	47.3	3.16	62.7	4.13
	16	9.7	1.05	13.2	1.31	18.7	1.64	24.9	2.01	32.9	2.42	47.3	3.20	62.7	4.17
	18	9.7	1.06	13.2	1.32	18.7	1.66	24.9	2.03	32.9	2.45	47.3	3.23	62.7	4.21
	20	9.7	1.07	13.2	1.33	18.7	1.68	24.9	2.06	32.9	2.47	47.3	3.26	62.7	4.25
	21	9.7	1.07	13.2	1.38	23.2	2.15	29.4	2.47	37.4	2.97	51.3	3.59	66.1	4.68
	23	9.7	1.14	21.0	2.35	32.2	3.22	41.5	3.85	47.3	4.36	59.1	5.32	73.0	6.44
	25	17.4	2.08	28.8	3.46	41.2	4.51	54.9	6.24	58.1	6.36	66.9	7.48	79.9	9.09
	27	25.3	2.98	36.6	4.87	51.0	6.28	63.7	8.31	67.6	8.57	74.7	9.80	86.7	11.57
	29	33.1	3.92	44.4	6.28	59.1	8.08	71.7	10.32	77.1	11.05	82.5	12.14	93.6	14.61
	31	40.9	4.98	52.2	7.46	67.2	9.84	78.0	11.51	82.5	12.23	90.2	13.11	100.4	16.08
	33	48.8	6.94	60.0	8.98	75.4	11.04	81.0	12.61	85.9	13.51	97.5	15.53	107.1	18.04
	35	56.7	10.94	67.8	13.16	78.6	15.54	84.0	16.85	89.4	18.17	100.2	20.97	111.6	24.09
	37	56.7	11.59	67.8	13.90	78.6	16.44	84.0	17.84	89.4	19.24	100.2	22.36	111.6	25.57
	39	56.7	12.37	67.8	14.89	78.6	17.62	84.0	19.20	89.4	20.64	100.2	23.82	111.6	27.62
	41	55.2	13.37	66.1	16.12	76.6	19.27	81.9	20.80	87.1	22.37	97.6	26.11	108.7	29.99
43	53.9	14.53	64.4	17.54	74.7	20.96	79.8	22.65	85.0	24.35	95.2	28.47	106.1	32.72	
46	50.5	16.28	60.4	19.67	70.0	23.51	74.8	25.43	79.6	27.34	89.2	32.04	99.4	36.83	
48	44.7	14.18	53.4	17.15	61.9	20.51	66.2	22.20	70.4	23.86	78.9	28.00	87.9	32.20	

**Note**

1. TC: Total Capacity(kW), PI : Power Input(kW, Comp. + Outdoor fan motor)
2. Capacity tables show the average value of conditions which may occur.

# 7. Capacity Tables

## ◆ ARUM620LTE5

Cooling Capacity (62HP)

Combination (%)	Outdoor air temp. (DB, °C)	Indoor air temp. (DB/WB, °C)													
		20		23		26		27		28		30		32	
		14	PI	16	PI	18	PI	19	PI	20	PI	22	PI	24	PI
130	10	24.4	2.49	33.3	3.11	44.4	3.78	62.7	4.61	82.6	5.76	119.0	7.69	157.8	10.18
	12	24.4	2.51	33.3	3.14	44.4	3.82	62.7	4.66	82.6	5.82	119.0	7.77	157.8	10.28
	14	24.4	2.54	33.3	3.17	44.4	3.86	62.7	4.71	82.6	5.88	119.0	7.85	157.8	10.39
	16	24.4	2.57	33.3	3.20	44.4	3.90	62.7	4.76	82.6	5.95	119.0	7.93	157.8	10.50
	18	24.4	2.59	33.3	3.24	44.4	3.94	62.7	4.80	82.6	6.01	119.0	8.01	157.8	10.61
	20	24.4	2.62	33.3	3.27	44.4	3.98	62.7	4.85	82.6	6.07	119.0	8.09	157.8	10.71
	21	24.4	2.65	33.8	3.37	55.0	4.97	73.1	5.78	92.4	7.45	126.7	10.17	162.8	12.06
	23	42.5	4.69	59.1	6.17	76.5	7.04	95.5	7.82	111.9	11.22	142.4	14.51	172.9	17.09
	25	62.8	7.44	76.0	9.26	97.9	10.52	119.1	12.40	131.4	16.12	158.1	21.09	183.1	24.81
	27	81.9	11.86	97.2	14.00	119.4	15.89	141.4	19.00	150.8	24.12	173.8	30.41	193.2	34.26
	29	101.1	16.46	118.3	19.31	140.8	23.34	164.4	27.48	170.3	32.75	189.7	39.31	203.4	43.75
	31	122.7	21.51	142.3	26.54	165.5	32.20	185.1	37.59	189.8	42.87	200.3	53.85	214.0	54.61
	33	144.3	26.51	168.6	34.63	189.3	41.44	200.1	53.80	204.4	53.42	210.7	53.90	225.0	54.66
	35	171.9	35.82	197.0	43.41	203.3	52.68	206.9	52.94	210.2	53.26	215.9	53.74	222.2	53.95
	37	171.9	38.19	194.3	45.56	200.6	51.98	203.3	52.24	206.9	52.56	212.5	53.03	218.8	53.23
	39	171.9	40.67	190.8	47.95	197.0	51.29	200.6	51.54	203.3	51.85	209.6	52.32	215.9	52.52
41	167.5	43.14	182.9	50.35	189.1	50.59	191.9	50.84	195.7	51.15	201.6	51.61	207.0	51.81	
43	163.4	45.50	175.3	49.64	181.4	49.89	184.1	50.14	187.8	50.45	193.6	50.90	198.9	51.10	
46	153.1	48.71	159.9	48.60	165.7	48.85	168.3	49.10	171.8	49.39	177.2	49.83	182.1	50.03	
48	135.5	47.35	138.9	47.49	144.1	47.59	146.4	47.72	149.5	48.13	154.3	48.44	158.6	48.63	
120	10	22.5	2.33	30.7	2.91	41.0	3.54	57.8	4.31	76.2	5.39	109.7	7.19	145.6	9.52
	12	22.5	2.35	30.7	2.94	41.0	3.57	57.8	4.36	76.2	5.45	109.7	7.27	145.6	9.62
	14	22.5	2.38	30.7	2.97	41.0	3.61	57.8	4.40	76.2	5.51	109.7	7.34	145.6	9.72
	16	22.5	2.40	30.7	3.00	41.0	3.65	57.8	4.45	76.2	5.56	109.7	7.42	145.6	9.82
	18	22.5	2.43	30.7	3.03	41.0	3.68	57.8	4.49	76.2	5.62	109.7	7.49	145.6	9.92
	20	22.5	2.45	30.7	3.06	41.0	3.72	57.8	4.54	76.2	5.68	109.7	7.57	145.6	10.02
	21	22.5	2.47	31.3	3.15	51.9	4.74	67.4	5.41	86.2	6.97	117.5	9.51	150.8	11.28
	23	39.1	4.39	56.1	5.87	73.8	6.75	88.0	7.32	106.6	10.50	133.6	13.57	161.3	15.99
	25	60.9	6.96	78.7	8.81	96.6	9.84	109.7	11.60	127.8	15.08	150.7	19.73	171.7	23.21
	27	84.6	11.00	107.1	13.10	119.9	14.75	130.3	17.63	149.0	22.38	167.8	28.22	182.2	32.31
	29	108.6	15.28	128.9	17.64	142.9	21.66	151.5	25.50	170.2	30.39	184.9	36.48	192.7	41.02
	31	131.6	19.34	155.3	23.32	166.1	28.73	174.4	33.80	192.1	38.55	197.4	46.36	204.1	47.23
	33	152.5	23.84	183.2	30.44	194.0	36.98	196.7	42.89	200.1	50.46	205.6	51.03	212.0	51.44
	35	155.6	31.85	185.0	41.26	196.0	45.64	198.7	54.36	202.2	54.63	207.7	54.80	213.1	55.23
	37	155.6	34.26	185.0	43.54	193.2	48.66	196.0	53.22	198.7	53.49	204.2	53.65	209.7	54.07
	39	155.6	36.89	184.3	46.02	189.8	51.61	192.6	52.13	195.3	52.39	201.5	52.54	206.9	52.96
41	151.6	39.51	176.3	48.49	182.2	50.59	184.8	51.03	187.5	51.29	193.0	51.44	198.4	51.85	
43	147.9	42.17	168.9	47.80	174.8	49.46	177.3	49.94	179.9	50.19	185.2	50.34	190.6	50.74	
46	138.6	45.35	154.0	46.66	159.6	47.91	162.0	48.30	164.4	48.54	169.4	48.69	174.4	49.07	
48	122.6	44.42	133.7	45.83	138.7	46.97	140.8	47.26	143.0	47.41	147.4	47.60	151.8	47.79	
110	10	20.6	2.19	28.2	2.73	37.5	3.32	53.0	4.05	69.8	5.07	100.5	6.76	133.3	8.95
	12	20.6	2.21	28.2	2.76	37.5	3.36	53.0	4.10	69.8	5.12	100.5	6.83	133.3	9.04
	14	20.6	2.23	28.2	2.79	37.5	3.39	53.0	4.14	69.8	5.17	100.5	6.90	133.3	9.13
	16	20.6	2.26	28.2	2.82	37.5	3.43	53.0	4.18	69.8	5.23	100.5	6.97	133.3	9.23
	18	20.6	2.28	28.2	2.85	37.5	3.46	53.0	4.22	69.8	5.28	100.5	7.04	133.3	9.32
	20	20.6	2.30	28.2	2.87	37.5	3.50	53.0	4.27	69.8	5.33	100.5	7.11	133.3	9.42
	21	20.6	2.33	28.2	2.96	47.0	4.37	62.2	5.08	77.7	6.55	108.5	8.94	140.2	10.60
	23	37.0	4.13	47.0	5.52	65.9	6.19	81.2	6.88	98.4	9.86	123.3	12.75	152.3	15.02
	25	53.2	6.54	65.9	8.27	84.8	9.25	100.3	10.90	116.9	14.17	137.8	18.54	164.3	21.81
	27	69.5	10.34	84.7	12.31	103.6	13.86	119.2	16.57	136.3	21.03	153.5	26.52	177.6	30.36
	29	85.7	14.36	103.6	16.58	122.5	20.35	138.5	23.96	155.7	28.56	169.1	33.59	187.4	37.26
	31	104.0	18.18	124.9	21.91	144.1	27.00	157.9	31.76	175.1	36.22	184.7	38.84	194.3	41.82
	33	120.6	22.40	144.1	28.60	163.4	34.75	178.1	38.82	189.3	43.57	195.2	44.77	200.1	44.83
	35	139.4	28.22	166.2	36.31	185.6	41.40	190.9	44.35	193.7	47.08	198.3	47.51	203.7	47.75
	37	139.4	29.91	166.2	38.54	185.6	43.70	188.3	46.99	190.3	49.65	195.7	49.83	200.3	49.97
	39	139.4	32.25	166.2	40.95	182.2	46.11	184.9	50.26	187.6	52.11	192.3	52.20	197.7	52.25
41	135.8	34.59	161.9	43.37	174.4	48.63	177.2	54.36	179.5	54.36	184.7	54.80	189.3	55.23	
43	132.5	36.32	157.9	45.18	167.2	51.57	169.9	52.15	172.1	52.03	177.2	52.33	181.7	52.47	
46	124.1	35.45	148.0	43.62	152.5	48.94	155.2	48.94	157.2	49.36	162.0	49.63	166.2	49.77	
48	109.8	34.43	128.6	42.02	132.5	46.56	134.9	46.87	136.7	47.10	140.9	47.23	144.6	47.42	

# 7. Capacity Tables

Cooling Capacity (62HP)

Combination (%)	Outdoor air temp. (DB, °C)	Indoor air temp. (DB/WB, °C)													
		20		23		26		27		28		30		32	
		14		16		18		19		20		22		24	
		TC	PI	TC	PI	TC	PI	TC	PI	TC	PI	TC	PI	TC	PI
100	10	18.9	2.01	25.8	2.51	34.4	3.05	48.6	3.72	64.1	4.65	92.2	6.20	122.3	8.21
	12	18.9	2.03	25.8	2.53	34.4	3.08	48.6	3.76	64.1	4.70	92.2	6.26	122.3	8.29
	14	18.9	2.05	25.8	2.56	34.4	3.11	48.6	3.80	64.1	4.75	92.2	6.33	122.3	8.38
	16	18.9	2.07	25.8	2.58	34.4	3.14	48.6	3.84	64.1	4.79	92.2	6.39	122.3	8.47
	18	18.9	2.09	25.8	2.61	34.4	3.18	48.6	3.87	64.1	4.84	92.2	6.46	122.3	8.55
	20	18.9	2.11	25.8	2.64	34.4	3.21	48.6	3.91	64.1	4.89	92.2	6.52	122.3	8.64
	21	18.9	2.13	25.8	2.72	42.9	4.01	57.1	4.66	73.0	6.01	99.6	8.20	128.6	9.72
	23	32.8	3.79	45.3	5.06	60.0	5.68	75.2	6.31	91.1	9.05	114.2	11.70	141.1	13.78
	25	46.9	6.00	61.0	7.59	77.1	8.48	93.7	10.00	109.3	13.00	128.8	17.00	153.5	20.01
	27	60.9	9.49	76.8	11.29	94.2	12.71	111.4	15.20	127.4	19.29	143.4	24.33	166.0	27.86
	29	74.9	13.17	92.5	15.21	111.2	18.67	129.5	21.98	145.5	26.20	158.0	31.45	178.4	34.18
	31	89.0	16.68	108.3	20.11	128.3	24.77	147.6	29.14	163.6	33.23	172.7	36.36	192.3	38.75
	33	103.0	20.55	124.1	26.24	145.4	31.88	165.6	36.97	181.9	40.38	187.6	41.08	192.3	41.97
	35	117.2	24.76	139.5	31.61	162.4	39.28	173.6	43.49	181.9	43.75	187.6	43.92	192.3	44.27
	37	117.2	26.51	139.5	33.90	162.4	41.61	173.6	45.56	178.9	45.78	184.1	45.97	188.5	46.39
	39	117.2	28.43	139.5	36.42	162.4	44.09	173.6	47.79	176.0	48.00	181.2	48.18	185.4	48.63
	41	115.3	30.34	137.3	38.93	159.9	46.58	166.6	50.01	170.2	50.21	174.2	50.39	179.9	50.86
	43	111.4	32.11	132.6	41.27	154.4	48.80	159.7	51.93	161.5	52.11	166.5	52.28	170.9	52.77
46	104.4	34.54	124.2	44.49	144.7	51.76	145.8	54.36	147.4	54.52	152.1	54.68	156.2	55.20	
48	92.3	29.82	109.9	38.50	124.9	44.25	126.7	46.13	128.0	46.28	132.3	46.38	135.9	46.75	
90	10	17.0	1.85	23.2	2.30	31.0	2.90	42.9	3.31	57.7	4.28	83.0	5.64	110.1	7.39
	12	17.0	1.87	23.2	2.33	31.0	2.93	42.9	3.34	57.7	4.32	83.0	5.70	110.1	7.46
	14	17.0	1.88	23.2	2.35	31.0	2.96	42.9	3.38	57.7	4.37	83.0	5.76	110.1	7.54
	16	17.0	1.90	23.2	2.38	31.0	2.99	42.9	3.41	57.7	4.41	83.0	5.82	110.1	7.62
	18	17.0	1.92	23.2	2.40	31.0	3.02	42.9	3.45	57.7	4.46	83.0	5.88	110.1	7.70
	20	17.0	1.94	23.2	2.43	31.0	3.05	42.9	3.48	57.7	4.50	83.0	5.94	110.1	7.78
	21	17.0	1.96	23.2	2.45	38.9	3.84	50.8	4.13	65.0	5.40	89.7	6.53	115.9	8.55
	23	23.1	3.04	34.2	4.21	54.3	5.45	65.8	5.93	79.5	7.94	103.1	9.68	127.6	11.77
	25	36.8	5.13	49.5	6.76	69.6	8.06	80.9	9.38	94.0	11.57	116.5	14.62	139.4	17.00
	27	50.5	7.54	64.8	9.62	85.0	12.51	96.0	13.94	108.4	16.88	129.9	19.68	151.2	22.25
	29	64.2	10.19	80.0	13.21	100.4	17.43	111.0	19.27	122.9	22.28	143.3	25.27	162.9	29.45
	31	77.8	12.75	95.3	16.97	115.8	21.82	126.1	24.59	137.4	27.75	156.7	29.42	174.7	34.23
	33	91.5	16.42	110.6	20.88	131.2	26.45	141.2	29.16	151.9	32.26	170.1	34.87	186.5	38.23
	35	105.4	20.32	125.9	25.70	146.3	31.77	156.2	35.04	166.2	38.10	183.4	40.87	186.5	41.81
	37	105.4	21.57	125.9	27.33	146.3	33.88	156.2	37.23	166.2	40.22	180.5	42.73	183.6	43.68
	39	105.4	22.84	125.9	29.07	146.3	35.86	156.2	39.61	166.2	42.29	177.5	45.04	180.6	45.59
	41	102.7	25.55	122.6	32.23	142.6	39.35	152.2	43.32	161.9	45.66	170.1	47.47	173.1	48.56
	43	100.2	27.59	119.6	34.83	139.1	42.99	148.5	46.66	157.9	48.96	163.1	50.71	166.0	51.45
46	93.9	31.05	112.1	39.66	130.3	48.98	139.1	52.90	143.5	54.39	148.9	54.68	151.7	55.20	
48	83.0	27.14	99.2	34.70	115.3	42.85	123.1	46.13	124.6	46.28	129.4	46.38	131.8	46.75	
80	10	14.6	1.63	19.9	2.04	26.5	2.56	37.4	2.95	49.3	3.78	71.0	4.99	94.2	6.53
	12	14.6	1.65	19.9	2.06	26.5	2.59	37.4	2.98	49.3	3.82	71.0	5.04	94.2	6.60
	14	14.6	1.67	19.9	2.08	26.5	2.61	37.4	3.01	49.3	3.86	71.0	5.09	94.2	6.67
	16	14.6	1.68	19.9	2.10	26.5	2.64	37.4	3.04	49.3	3.90	71.0	5.14	94.2	6.74
	18	14.6	1.70	19.9	2.12	26.5	2.67	37.4	3.07	49.3	3.94	71.0	5.20	94.2	6.80
	20	14.6	1.72	19.9	2.14	26.5	2.69	37.4	3.10	49.3	3.98	71.0	5.25	94.2	6.87
	21	14.6	1.73	19.9	2.21	33.3	3.40	44.7	3.72	55.9	4.77	77.2	5.77	100.1	7.56
	23	25.9	3.19	33.0	3.79	47.0	4.81	59.1	5.34	69.1	7.02	89.9	8.55	111.9	10.40
	25	37.2	4.62	46.1	6.08	60.7	7.13	73.6	8.44	82.3	10.23	102.6	12.93	123.6	15.03
	27	48.4	6.79	59.2	8.66	74.4	11.06	88.0	12.54	95.5	14.92	115.2	17.40	135.3	19.67
	29	59.7	8.80	72.3	11.89	88.2	15.41	102.4	17.34	108.7	19.69	127.9	22.34	147.1	26.04
	31	71.0	10.78	85.4	14.96	101.9	19.29	116.9	22.13	124.3	23.87	140.6	25.75	158.8	29.95
	33	82.3	14.18	98.4	18.42	115.6	22.68	131.4	26.24	139.1	27.43	153.3	30.51	170.5	33.72
	35	93.6	18.56	111.6	23.26	129.6	28.54	138.9	31.35	148.2	34.32	166.2	38.94	182.2	40.56
	37	93.6	19.63	111.6	24.73	129.6	30.28	138.9	33.33	148.2	36.46	166.2	41.09	179.2	42.60
	39	93.6	20.75	111.6	26.15	129.6	32.39	138.9	35.83	148.2	39.19	166.2	43.42	176.3	44.94
	41	91.2	22.95	108.7	28.98	126.3	35.54	135.3	39.28	144.4	43.06	161.9	46.52	168.9	47.59
	43	89.0	25.27	106.1	31.62	123.1	38.80	132.0	42.80	140.8	47.05	157.9	49.70	161.9	50.93
46	83.4	28.11	99.4	35.62	115.4	43.72	123.7	47.64	132.0	53.10	144.4	54.68	147.8	55.20	
48	73.8	24.55	87.9	31.15	102.1	38.23	109.4	41.61	116.7	46.28	125.4	46.38	128.4	46.75	

# 7. Capacity Tables

Cooling Capacity (62HP)

Combination (%)	Outdoor air temp. (DB, °C)	Indoor air temp. (DB/WB, °C)													
		20		23		26		27		28		30		32	
		14		16		18		19		20		22		24	
		TC	PI	TC	PI	TC	PI	TC	PI	TC	PI	TC	PI	TC	PI
70	10	12.7	1.44	17.3	1.80	23.1	2.26	32.6	2.62	42.9	3.34	61.8	4.41	82.0	5.77
	12	12.7	1.46	17.3	1.82	23.1	2.29	32.6	2.65	42.9	3.38	61.8	4.45	82.0	5.83
	14	12.7	1.47	17.3	1.84	23.1	2.31	32.6	2.68	42.9	3.41	61.8	4.50	82.0	5.89
	16	12.7	1.49	17.3	1.86	23.1	2.33	32.6	2.70	42.9	3.45	61.8	4.55	82.0	5.95
	18	12.7	1.50	17.3	1.88	23.1	2.36	32.6	2.73	42.9	3.48	61.8	4.59	82.0	6.02
	20	12.7	1.52	17.3	1.90	23.1	2.38	32.6	2.76	42.9	3.52	61.8	4.64	82.0	6.08
	21	12.7	1.53	20.2	2.23	30.0	3.12	40.3	3.46	49.6	4.22	68.1	5.10	88.2	6.68
	23	18.2	2.30	31.2	3.64	41.9	4.57	54.3	4.97	62.9	6.20	80.9	7.56	100.4	9.19
	25	28.8	3.79	42.3	5.38	53.8	6.30	68.2	7.85	76.3	9.04	93.7	11.43	112.6	13.29
	27	39.4	5.52	53.4	7.65	65.7	9.29	82.2	11.67	89.6	13.19	106.6	15.38	124.9	17.39
	29	50.1	7.00	64.5	10.11	77.6	12.64	96.1	15.87	102.9	17.41	119.4	19.75	137.1	23.02
	31	60.7	8.61	75.6	12.57	89.5	15.82	110.1	19.94	116.3	21.10	132.2	22.76	149.3	26.48
	33	71.3	11.58	86.6	15.29	101.4	18.37	121.5	23.15	129.6	24.24	145.1	26.97	161.2	29.81
	35	81.8	15.86	98.0	19.77	113.5	23.91	121.5	26.15	129.6	28.56	145.1	33.62	161.2	36.86
	37	81.8	16.85	98.0	20.93	113.5	25.41	121.5	27.81	129.6	30.39	145.1	35.78	161.2	38.91
	39	81.8	17.90	98.0	22.32	113.5	27.16	121.5	29.92	129.6	32.82	145.1	38.30	161.2	41.94
	41	79.7	19.79	95.5	24.45	110.6	29.80	118.4	32.82	126.3	35.68	141.4	42.06	157.1	45.21
43	77.8	21.54	93.1	26.65	107.8	32.51	115.5	35.79	123.1	38.97	137.9	45.95	153.2	48.90	
46	72.9	23.93	87.2	29.96	101.0	36.61	108.2	39.86	115.4	43.93	129.2	51.83	143.6	54.53	
48	64.5	20.89	77.2	26.17	89.4	32.01	95.7	34.84	102.1	38.43	114.3	45.35	127.0	46.75	
60	10	11.2	1.23	15.0	1.54	20.0	1.93	28.2	2.25	37.2	2.85	53.5	3.76	70.9	4.93
	12	11.2	1.24	15.0	1.55	20.0	1.95	28.2	2.28	37.2	2.88	53.5	3.80	70.9	4.98
	14	11.2	1.26	15.0	1.57	20.0	1.97	28.2	2.30	37.2	2.91	53.5	3.84	70.9	5.03
	16	11.2	1.27	15.0	1.59	20.0	1.99	28.2	2.32	37.2	2.94	53.5	3.88	70.9	5.08
	18	11.2	1.28	15.0	1.60	20.0	2.01	28.2	2.35	37.2	2.97	53.5	3.92	70.9	5.14
	20	11.2	1.30	15.0	1.62	20.0	2.03	28.2	2.37	37.2	3.00	53.5	3.96	70.9	5.19
	21	11.2	1.30	15.0	1.68	25.0	2.61	33.1	2.88	42.6	3.60	58.1	4.36	75.5	5.71
	23	11.2	1.44	24.8	3.04	35.3	3.91	45.9	4.17	53.7	5.30	67.6	6.46	84.4	7.85
	25	20.8	2.74	34.6	4.59	45.6	5.38	59.1	7.13	64.8	7.72	78.6	9.56	93.4	11.35
	27	30.6	4.00	44.5	6.53	55.9	7.93	71.3	9.92	75.8	11.08	88.3	12.67	102.4	14.61
	29	40.4	5.19	54.3	8.37	66.2	10.57	84.1	13.03	86.9	14.13	97.9	15.89	111.3	18.68
	31	50.3	6.60	64.1	10.01	76.6	12.88	94.4	15.63	98.0	16.41	109.7	17.59	120.3	21.52
	33	60.1	9.19	73.9	12.17	86.9	14.46	101.9	17.53	109.2	18.78	118.4	20.84	129.2	24.51
	35	70.1	13.45	83.7	16.46	97.3	19.72	104.2	21.47	111.0	23.31	124.6	27.24	138.3	31.41
	37	70.1	14.20	83.7	17.37	97.3	20.89	104.2	22.81	111.0	24.73	124.6	28.91	138.3	33.42
	39	70.1	15.10	83.7	18.50	97.3	22.55	104.2	24.47	111.0	26.61	124.6	31.00	138.3	35.81
	41	68.3	16.38	81.6	20.24	94.8	24.48	101.5	26.73	108.1	28.89	121.4	34.02	134.7	38.92
43	66.6	17.80	79.5	22.03	92.5	26.69	99.0	29.13	105.5	31.50	118.4	37.13	131.4	42.51	
46	62.4	19.94	74.5	24.74	86.7	30.02	92.8	32.75	98.8	35.45	111.0	41.84	123.1	48.43	
48	55.2	17.37	65.9	21.59	76.7	26.23	82.1	28.60	87.4	30.98	98.2	36.59	108.9	42.37	
50	10	10.0	1.05	13.7	1.31	19.3	1.65	25.8	2.03	34.0	2.44	48.9	3.22	64.8	4.19
	12	10.0	1.06	13.7	1.33	19.3	1.67	25.8	2.05	34.0	2.46	48.9	3.25	64.8	4.24
	14	10.0	1.08	13.7	1.34	19.3	1.69	25.8	2.07	34.0	2.49	48.9	3.29	64.8	4.28
	16	10.0	1.09	13.7	1.36	19.3	1.70	25.8	2.09	34.0	2.52	48.9	3.32	64.8	4.33
	18	10.0	1.10	13.7	1.37	19.3	1.72	25.8	2.11	34.0	2.54	48.9	3.35	64.8	4.37
	20	10.0	1.11	13.7	1.38	19.3	1.74	25.8	2.13	34.0	2.57	48.9	3.39	64.8	4.42
	21	10.0	1.11	13.7	1.43	24.0	2.23	30.4	2.56	38.6	3.08	53.1	3.73	68.3	4.86
	23	10.0	1.18	21.7	2.44	33.3	3.34	42.9	4.00	48.9	4.53	61.1	5.52	75.4	6.68
	25	18.0	2.16	29.8	3.60	42.5	4.68	56.8	6.48	60.1	6.60	69.2	7.77	82.5	9.44
	27	26.1	3.10	37.8	5.05	52.7	6.52	65.8	8.63	69.8	8.90	77.2	10.17	89.6	12.01
	29	34.2	4.07	45.9	6.52	61.1	8.38	74.0	10.71	79.6	11.47	85.3	12.60	96.7	15.17
	31	42.3	5.17	53.9	7.74	69.5	10.21	80.6	11.94	85.2	12.69	93.2	13.61	103.8	16.69
	33	50.4	7.20	62.0	9.32	77.9	11.46	83.7	13.09	88.8	14.02	100.8	16.13	110.7	18.73
	35	58.6	11.18	70.1	13.45	81.2	15.89	86.8	17.24	92.4	18.58	103.5	21.44	115.3	24.63
	37	58.6	11.85	70.1	14.21	81.2	16.82	86.8	18.24	92.4	19.67	103.5	22.87	115.3	26.15
	39	58.6	12.65	70.1	15.23	81.2	18.02	86.8	19.64	92.4	21.11	103.5	24.36	115.3	28.24
	41	57.1	13.67	68.3	16.49	79.1	19.70	84.6	21.27	90.0	22.87	100.9	26.70	112.4	30.67
43	55.7	14.86	66.6	17.93	77.2	21.43	82.5	23.16	87.8	24.90	98.4	29.12	109.6	33.46	
46	52.2	16.64	62.4	20.11	72.3	24.04	77.3	26.01	82.3	27.96	92.2	32.76	102.7	37.67	
48	46.2	14.50	55.2	17.54	64.0	20.97	68.4	22.70	72.8	24.40	81.6	28.63	90.9	32.92	

**Note**

1. TC: Total Capacity(kW), PI : Power Input(kW, Comp. + Outdoor fan motor)
2. Capacity tables show the average value of conditions which may occur.



# 7. Capacity Tables

## ◆ ARUM640LTE5

Cooling Capacity (64HP)

Combination (%)	Outdoor air temp. (DB, °C)	Indoor air temp. (DB/WB, °C)													
		20		23		26		27		28		30		32	
		14	PI	16	PI	18	PI	19	PI	20	PI	22	PI	24	PI
130	10	25.2	2.62	34.4	3.27	45.9	3.97	64.7	4.85	85.3	6.06	122.8	8.08	162.9	10.70
	12	25.2	2.64	34.4	3.30	45.9	4.02	64.7	4.90	85.3	6.12	122.8	8.17	162.9	10.81
	14	25.2	2.67	34.4	3.33	45.9	4.06	64.7	4.95	85.3	6.19	122.8	8.25	162.9	10.92
	16	25.2	2.70	34.4	3.37	45.9	4.10	64.7	5.00	85.3	6.25	122.8	8.34	162.9	11.04
	18	25.2	2.73	34.4	3.40	45.9	4.14	64.7	5.05	85.3	6.31	122.8	8.42	162.9	11.15
	20	25.2	2.75	34.4	3.44	45.9	4.18	64.7	5.10	85.3	6.38	122.8	8.51	162.9	11.26
	21	25.2	2.78	34.9	3.54	56.8	5.23	75.4	6.08	95.4	7.83	130.8	10.69	168.1	12.67
	23	43.8	4.94	61.1	6.49	78.9	7.40	98.6	8.23	115.5	11.79	147.0	15.25	178.5	17.97
	25	64.8	7.82	78.5	9.74	101.1	11.06	122.9	13.04	135.6	16.95	163.2	22.17	189.0	26.08
	27	84.6	12.47	100.3	14.72	123.2	16.71	146.0	19.97	155.7	25.35	179.4	31.97	199.4	36.02
	29	104.3	17.31	122.1	20.30	145.4	24.53	169.7	28.89	175.8	34.43	195.8	41.33	210.0	46.00
	31	126.6	22.61	146.8	27.90	170.9	33.85	191.1	39.52	195.9	45.07	206.7	56.61	220.9	57.41
	33	148.9	27.87	174.1	36.41	195.4	43.56	206.5	56.56	211.0	56.16	217.5	56.66	232.3	57.46
	35	177.5	37.65	203.4	45.64	209.9	55.38	213.5	55.66	217.0	55.99	222.9	56.49	229.4	56.71
	37	177.5	40.15	200.5	47.89	207.0	54.65	209.9	54.92	213.5	55.25	219.4	55.74	225.9	55.96
	39	177.5	42.75	197.0	50.41	203.4	53.91	207.0	54.19	209.9	54.51	216.4	55.00	222.9	55.22
41	173.0	45.36	188.8	52.93	195.2	53.18	198.1	53.45	202.0	53.77	208.1	54.25	213.7	54.47	
43	168.7	47.83	180.9	52.19	187.2	52.45	190.1	52.72	193.9	53.03	199.8	53.51	205.3	53.72	
46	158.1	51.20	165.1	51.10	171.0	51.35	173.7	51.61	177.3	51.92	182.9	52.39	188.0	52.59	
48	139.8	49.77	143.4	49.92	148.7	50.03	151.1	50.17	154.3	50.60	159.2	50.92	163.7	51.12	
120	10	23.3	2.45	31.7	3.06	42.3	3.72	59.7	4.53	78.7	5.67	113.3	7.56	150.3	10.01
	12	23.3	2.47	31.7	3.09	42.3	3.76	59.7	4.58	78.7	5.73	113.3	7.64	150.3	10.11
	14	23.3	2.50	31.7	3.12	42.3	3.80	59.7	4.63	78.7	5.79	113.3	7.72	150.3	10.22
	16	23.3	2.52	31.7	3.15	42.3	3.83	59.7	4.68	78.7	5.85	113.3	7.80	150.3	10.32
	18	23.3	2.55	31.7	3.18	42.3	3.87	59.7	4.73	78.7	5.91	113.3	7.88	150.3	10.43
	20	23.3	2.58	31.7	3.22	42.3	3.91	59.7	4.77	78.7	5.97	113.3	7.96	150.3	10.54
	21	23.3	2.60	32.3	3.31	53.6	4.99	69.5	5.68	88.9	7.33	121.3	10.00	155.7	11.86
	23	40.3	4.62	57.9	6.17	76.2	7.09	90.8	7.70	110.1	11.03	137.9	14.27	166.5	16.81
	25	62.9	7.32	81.3	9.26	99.7	10.35	113.2	12.20	132.0	15.86	155.6	20.74	177.3	24.40
	27	87.4	11.57	110.5	13.77	123.7	15.50	134.5	18.54	153.9	23.53	173.2	29.67	188.1	33.97
	29	112.1	16.06	133.1	18.55	147.5	22.77	156.3	26.81	175.7	31.95	190.9	38.35	198.9	43.12
	31	135.8	20.34	160.3	24.52	171.5	30.20	180.0	35.53	198.3	40.52	203.8	48.74	210.6	49.65
	33	157.4	25.06	189.1	32.00	200.3	38.87	203.1	45.09	206.6	53.05	212.2	53.65	218.9	54.08
	35	160.6	33.49	191.0	43.38	202.3	47.98	205.1	57.15	208.7	57.44	214.4	57.61	220.0	58.06
	37	160.6	36.02	191.0	45.77	199.4	51.16	202.3	55.95	205.1	56.23	210.8	56.40	216.5	56.84
	39	160.6	38.78	190.3	48.38	196.0	54.26	198.8	54.80	201.6	55.07	208.0	55.24	213.6	55.68
41	156.5	41.53	182.0	50.98	188.1	53.19	190.8	53.65	193.6	53.92	199.2	54.08	204.8	54.51	
43	152.6	44.33	174.4	50.25	180.4	52.00	183.0	52.50	185.7	52.76	191.2	52.92	196.7	53.34	
46	143.0	47.67	159.0	49.05	164.8	50.36	167.2	50.78	169.7	51.03	174.9	51.18	180.0	51.59	
48	126.5	46.70	138.0	48.18	143.2	49.38	145.4	49.68	147.6	49.84	152.1	50.04	156.7	50.24	
110	10	21.3	2.30	29.1	2.87	38.8	3.49	54.7	4.26	72.1	5.33	103.8	7.10	137.6	9.40
	12	21.3	2.32	29.1	2.90	38.8	3.53	54.7	4.31	72.1	5.38	103.8	7.18	137.6	9.50
	14	21.3	2.35	29.1	2.93	38.8	3.57	54.7	4.35	72.1	5.44	103.8	7.25	137.6	9.60
	16	21.3	2.37	29.1	2.96	38.8	3.60	54.7	4.40	72.1	5.49	103.8	7.33	137.6	9.70
	18	21.3	2.40	29.1	2.99	38.8	3.64	54.7	4.44	72.1	5.55	103.8	7.40	137.6	9.80
	20	21.3	2.42	29.1	3.02	38.8	3.68	54.7	4.49	72.1	5.61	103.8	7.48	137.6	9.90
	21	21.3	2.44	29.1	3.11	48.6	4.59	64.2	5.34	80.2	6.89	112.0	9.40	144.7	11.14
	23	38.2	4.34	48.5	5.80	68.0	6.50	83.8	7.23	101.6	10.37	127.3	13.41	157.2	15.79
	25	54.9	6.88	68.0	8.70	87.5	9.72	103.5	11.46	120.7	14.90	142.3	19.49	169.6	22.92
	27	71.7	10.87	87.5	12.94	106.9	14.57	123.0	17.42	140.7	22.11	158.4	27.88	183.3	31.92
	29	88.5	15.09	106.9	17.43	126.4	21.39	143.0	25.19	160.7	30.02	174.6	35.32	193.4	39.17
	31	107.3	19.11	128.9	23.04	148.8	28.38	163.0	33.39	180.7	38.08	190.7	40.84	200.5	43.96
	33	124.5	23.55	148.8	30.07	168.6	36.53	183.8	40.81	195.4	45.80	201.4	47.07	206.6	47.13
	35	143.9	29.67	171.5	38.17	191.6	43.52	197.1	46.63	199.9	49.49	204.7	49.95	210.3	50.20
	37	143.9	31.45	171.5	40.51	191.6	45.94	194.3	49.40	196.4	52.20	202.0	52.38	206.8	52.53
	39	143.9	33.90	171.5	43.05	188.1	48.48	190.9	52.84	193.7	54.79	198.5	54.88	204.1	54.93
41	140.2	36.36	167.1	45.59	180.1	51.12	182.9	57.15	185.3	57.15	190.7	57.61	195.4	58.06	
43	136.7	38.18	163.0	47.50	172.6	54.21	175.4	54.82	177.7	54.70	183.0	55.01	187.6	55.16	
46	128.1	37.26	152.8	45.85	157.5	51.45	160.2	51.45	162.3	51.89	167.2	52.18	171.6	52.32	
48	113.3	36.19	132.8	44.17	136.8	48.95	139.3	49.28	141.1	49.51	145.5	49.65	149.3	49.85	

# 7. Capacity Tables

Cooling Capacity (64HP)

Combination (%)	Outdoor air temp. (DB, °C)	Indoor air temp. (DB/WB, °C)													
		20		23		26		27		28		30		32	
		14		16		18		19		20		22		24	
		TC	PI	TC	PI	TC	PI	TC	PI	TC	PI	TC	PI	TC	PI
100	10	19.6	2.11	26.7	2.63	35.6	3.20	50.2	3.91	66.1	4.89	95.2	6.52	126.3	8.63
	12	19.6	2.13	26.7	2.66	35.6	3.24	50.2	3.95	66.1	4.94	95.2	6.58	126.3	8.72
	14	19.6	2.15	26.7	2.69	35.6	3.27	50.2	3.99	66.1	4.99	95.2	6.65	126.3	8.81
	16	19.6	2.18	26.7	2.72	35.6	3.31	50.2	4.03	66.1	5.04	95.2	6.72	126.3	8.90
	18	19.6	2.20	26.7	2.74	35.6	3.34	50.2	4.07	66.1	5.09	95.2	6.79	126.3	8.99
	20	19.6	2.22	26.7	2.77	35.6	3.37	50.2	4.11	66.1	5.14	95.2	6.86	126.3	9.08
	21	19.6	2.24	26.7	2.86	44.3	4.21	58.9	4.90	75.4	6.32	102.8	8.62	132.7	10.22
	23	33.9	3.98	46.7	5.32	61.9	5.97	77.6	6.63	94.1	9.51	117.9	12.30	145.6	14.49
	25	48.4	6.31	63.0	7.98	79.6	8.92	96.8	10.52	112.8	13.67	133.0	17.88	158.5	21.03
	27	62.9	9.97	79.3	11.87	97.2	13.36	115.0	15.98	131.5	20.28	148.1	25.57	171.3	29.28
	29	77.3	13.85	95.5	15.99	114.8	19.63	133.6	23.11	150.2	27.55	163.1	33.06	184.2	35.94
	31	91.8	17.53	111.8	21.14	132.5	26.04	152.3	30.63	168.9	34.94	178.2	38.23	198.6	40.74
	33	106.3	21.61	128.1	27.58	150.1	33.51	171.0	38.87	187.8	42.45	193.6	43.18	198.6	44.12
	35	121.0	26.03	144.0	33.23	167.7	41.30	179.2	45.72	187.8	45.99	193.6	46.17	198.6	46.54
	37	121.0	27.87	144.0	35.64	167.7	43.74	179.2	47.90	184.7	48.13	190.0	48.33	194.6	48.77
	39	121.0	29.88	144.0	38.28	167.7	46.35	179.2	50.24	181.6	50.46	187.0	50.65	191.4	51.12
	41	119.0	31.89	141.7	40.93	165.0	48.96	171.9	52.58	175.7	52.79	179.9	52.97	185.7	53.47
43	115.0	33.75	136.8	43.39	159.3	51.30	164.9	54.59	166.8	54.78	171.9	54.96	176.4	55.48	
46	107.7	36.31	128.2	46.78	149.3	54.42	150.5	57.15	152.2	57.32	157.0	57.49	161.3	58.03	
48	95.3	31.35	113.4	40.47	128.9	46.52	130.8	48.49	132.2	48.65	136.5	48.76	140.2	49.15	
90	10	17.6	1.94	24.0	2.42	32.0	3.04	44.3	3.48	59.5	4.50	85.7	5.93	113.6	7.77
	12	17.6	1.96	24.0	2.45	32.0	3.08	44.3	3.52	59.5	4.54	85.7	5.99	113.6	7.85
	14	17.6	1.98	24.0	2.47	32.0	3.11	44.3	3.55	59.5	4.59	85.7	6.05	113.6	7.93
	16	17.6	2.00	24.0	2.50	32.0	3.14	44.3	3.59	59.5	4.64	85.7	6.12	113.6	8.01
	18	17.6	2.02	24.0	2.52	32.0	3.17	44.3	3.63	59.5	4.68	85.7	6.18	113.6	8.09
	20	17.6	2.04	24.0	2.55	32.0	3.20	44.3	3.66	59.5	4.73	85.7	6.24	113.6	8.17
	21	17.6	2.06	24.0	2.58	40.1	4.04	52.4	4.34	67.1	5.68	92.6	6.87	119.6	8.99
	23	23.9	3.19	35.3	4.43	56.0	5.72	68.0	6.24	82.0	8.35	106.4	10.17	131.7	12.37
	25	38.0	5.39	51.1	7.10	71.9	8.47	83.5	9.86	97.0	12.17	120.2	15.37	143.9	17.88
	27	52.1	7.93	66.8	10.11	87.8	13.15	99.1	14.65	111.9	17.74	134.1	20.69	156.0	23.39
	29	66.2	10.71	82.6	13.89	103.6	18.32	114.6	20.26	126.9	23.42	147.9	26.57	168.2	30.96
	31	80.4	13.40	98.4	17.84	119.5	22.94	130.2	25.85	141.8	29.18	161.7	30.93	180.3	35.98
	33	94.5	17.26	114.2	21.95	135.4	27.81	145.7	30.66	156.8	33.92	175.6	36.65	192.6	40.19
	35	108.8	21.37	129.9	27.02	151.0	33.40	161.3	36.84	171.5	40.05	189.3	42.97	192.6	43.95
	37	108.8	22.68	129.9	28.73	151.0	35.61	161.3	39.14	171.5	42.28	186.3	44.92	189.5	45.92
	39	108.8	24.01	129.9	30.56	151.0	37.69	161.3	41.64	171.5	44.46	183.2	47.35	186.5	47.92
	41	106.0	26.86	126.6	33.88	147.2	41.37	157.2	45.54	167.1	48.00	175.6	49.91	178.7	51.05
43	103.4	29.00	123.5	36.62	143.5	45.19	153.3	49.05	163.0	51.47	168.3	53.31	171.4	54.09	
46	96.9	32.64	115.7	41.70	134.5	51.49	143.6	55.61	148.1	57.18	153.7	57.49	156.6	58.03	
48	85.7	28.53	102.4	36.47	119.0	45.05	127.1	48.49	128.6	48.65	133.6	48.76	136.1	49.15	
80	10	15.1	1.72	20.5	2.14	27.4	2.69	38.6	3.10	50.9	3.97	73.3	5.24	97.2	6.86
	12	15.1	1.73	20.5	2.16	27.4	2.72	38.6	3.13	50.9	4.02	73.3	5.30	97.2	6.94
	14	15.1	1.75	20.5	2.19	27.4	2.75	38.6	3.16	50.9	4.06	73.3	5.35	97.2	7.01
	16	15.1	1.77	20.5	2.21	27.4	2.78	38.6	3.19	50.9	4.10	73.3	5.41	97.2	7.08
	18	15.1	1.79	20.5	2.23	27.4	2.80	38.6	3.23	50.9	4.14	73.3	5.46	97.2	7.15
	20	15.1	1.81	20.5	2.25	27.4	2.83	38.6	3.26	50.9	4.18	73.3	5.52	97.2	7.23
	21	15.1	1.82	20.5	2.32	34.4	3.57	46.1	3.91	57.7	5.02	79.7	6.07	103.4	7.95
	23	26.7	3.35	34.1	3.98	48.5	5.06	61.0	5.61	71.3	7.38	92.8	8.99	115.5	10.93
	25	38.3	4.86	47.6	6.39	62.7	7.49	75.9	8.87	84.9	10.76	105.9	13.59	127.6	15.80
	27	50.0	7.14	61.1	9.10	76.8	11.63	90.8	13.19	98.6	15.69	119.0	18.29	139.7	20.68
	29	61.6	9.25	74.6	12.50	91.0	16.20	105.7	18.23	112.2	20.70	132.0	23.49	151.8	27.37
	31	73.3	11.34	88.1	15.73	105.2	20.28	120.7	23.27	128.3	25.09	145.1	27.07	163.9	31.49
	33	84.9	14.91	101.6	19.36	119.3	23.84	135.7	27.59	143.6	28.83	158.2	32.08	176.0	35.45
	35	96.6	19.51	115.2	24.46	133.8	30.01	143.4	32.96	153.0	36.08	171.5	40.93	188.1	42.64
	37	96.6	20.64	115.2	26.00	133.8	31.83	143.4	35.04	153.0	38.33	171.5	43.20	185.0	44.78
	39	96.6	21.82	115.2	27.49	133.8	34.05	143.4	37.67	153.0	41.20	171.5	45.64	182.0	47.24
	41	94.2	24.13	112.3	30.46	130.3	37.37	139.7	41.29	149.0	45.27	167.1	48.91	174.4	50.03
43	91.8	26.56	109.5	33.24	127.1	40.79	136.2	45.00	145.4	49.47	163.0	52.25	167.1	53.55	
46	86.1	29.55	102.6	37.45	119.1	45.96	127.7	50.08	136.2	55.82	149.1	57.49	152.6	58.03	
48	76.1	25.81	90.8	32.74	105.4	40.19	112.9	43.75	120.5	48.65	129.5	48.76	132.6	49.15	

# 7. Capacity Tables

Cooling Capacity (64HP)

Combination (%)	Outdoor air temp. (DB, °C)	Indoor air temp. (DB/WB, °C)													
		20		23		26		27		28		30		32	
		14		16		18		19		20		22		24	
		TC	PI	TC	PI	TC	PI	TC	PI	TC	PI	TC	PI	TC	PI
70	10	13.1	1.52	17.9	1.89	23.8	2.38	33.6	2.76	44.3	3.51	63.8	4.63	84.6	6.07
	12	13.1	1.53	17.9	1.91	23.8	2.40	33.6	2.78	44.3	3.55	63.8	4.68	84.6	6.13
	14	13.1	1.55	17.9	1.93	23.8	2.43	33.6	2.81	44.3	3.59	63.8	4.73	84.6	6.20
	16	13.1	1.56	17.9	1.95	23.8	2.45	33.6	2.84	44.3	3.62	63.8	4.78	84.6	6.26
	18	13.1	1.58	17.9	1.97	23.8	2.48	33.6	2.87	44.3	3.66	63.8	4.83	84.6	6.32
	20	13.1	1.60	17.9	1.99	23.8	2.50	33.6	2.90	44.3	3.70	63.8	4.88	84.6	6.39
	21	13.1	1.60	20.8	2.34	30.9	3.28	41.6	3.64	51.2	4.44	70.3	5.37	91.1	7.03
	23	18.8	2.41	32.3	3.83	43.2	4.81	56.0	5.22	65.0	6.52	83.5	7.95	103.7	9.67
	25	29.7	3.98	43.7	5.65	55.5	6.62	70.4	8.25	78.7	9.51	96.8	12.01	116.3	13.97
	27	40.7	5.80	55.1	8.04	67.8	9.77	84.8	12.26	92.5	13.87	110.0	16.17	128.9	18.28
	29	51.7	7.36	66.6	10.63	80.1	13.28	99.2	16.68	106.2	18.30	123.2	20.76	141.5	24.20
	31	62.6	9.05	78.0	13.22	92.4	16.63	113.6	20.96	120.0	22.18	136.4	23.93	154.1	27.84
	33	73.6	12.18	89.4	16.07	104.7	19.31	125.4	24.33	133.8	25.49	149.8	28.36	166.4	31.34
	35	84.5	16.67	101.1	20.78	117.1	25.14	125.4	27.49	133.8	30.02	149.8	35.35	166.4	38.76
	37	84.5	17.72	101.1	22.00	117.1	26.71	125.4	29.24	133.8	31.94	149.8	37.62	166.4	40.90
	39	84.5	18.81	101.1	23.46	117.1	28.56	125.4	31.46	133.8	34.51	149.8	40.26	166.4	44.10
	41	82.3	20.80	98.5	25.70	114.1	31.32	122.2	34.50	130.3	37.51	145.9	44.22	162.1	47.53
43	80.3	22.64	96.1	28.01	111.3	34.18	119.2	37.62	127.1	40.96	142.3	48.31	158.1	51.40	
46	75.2	25.16	90.1	31.50	104.3	38.49	111.7	41.91	119.1	46.18	133.4	54.48	148.2	57.33	
48	66.6	21.96	79.7	27.51	92.3	33.65	98.8	36.62	105.4	40.40	118.0	47.68	131.1	49.15	
60	10	11.5	1.29	15.5	1.61	20.6	2.03	29.1	2.36	38.4	2.99	55.2	3.95	73.2	5.17
	12	11.5	1.30	15.5	1.63	20.6	2.05	29.1	2.39	38.4	3.02	55.2	3.99	73.2	5.22
	14	11.5	1.32	15.5	1.65	20.6	2.07	29.1	2.41	38.4	3.05	55.2	4.03	73.2	5.28
	16	11.5	1.33	15.5	1.66	20.6	2.09	29.1	2.44	38.4	3.09	55.2	4.07	73.2	5.33
	18	11.5	1.35	15.5	1.68	20.6	2.11	29.1	2.46	38.4	3.12	55.2	4.11	73.2	5.38
	20	11.5	1.36	15.5	1.70	20.6	2.13	29.1	2.49	38.4	3.15	55.2	4.15	73.2	5.44
	21	11.5	1.37	15.5	1.76	25.8	2.74	34.2	3.02	44.0	3.78	60.0	4.57	77.9	5.98
	23	11.5	1.51	25.6	3.19	36.4	4.09	47.3	4.37	55.4	5.55	69.7	6.77	87.2	8.23
	25	21.5	2.88	35.8	4.81	47.1	5.64	61.0	7.47	66.8	8.09	81.1	10.02	96.4	11.89
	27	31.6	4.20	45.9	6.85	57.7	8.32	73.6	10.39	78.3	11.62	91.1	13.28	105.7	15.32
	29	41.8	5.44	56.0	8.78	68.4	11.08	86.9	13.66	89.7	14.81	101.1	16.66	114.9	19.58
	31	51.9	6.92	66.2	10.49	79.0	13.50	97.5	16.39	101.1	17.20	113.2	18.44	124.1	22.56
	33	62.0	9.64	76.3	12.76	89.7	15.16	105.1	18.37	112.7	19.68	122.2	21.85	133.4	25.70
	35	72.3	14.14	86.4	17.30	100.5	20.73	107.5	22.57	114.6	24.51	128.6	28.63	142.7	33.03
	37	72.3	14.93	86.4	18.26	100.5	21.96	107.5	23.98	114.6	26.00	128.6	30.39	142.7	35.13
	39	72.3	15.88	86.4	19.44	100.5	23.70	107.5	25.73	114.6	27.98	128.6	32.59	142.7	37.65
	41	70.5	17.22	84.2	21.28	97.9	25.74	104.8	28.10	111.6	30.37	125.3	35.76	139.1	40.91
43	68.7	18.72	82.1	23.16	95.5	28.06	102.2	30.62	108.9	33.12	122.2	39.04	135.6	44.69	
46	64.4	20.96	76.9	26.01	89.5	31.56	95.8	34.43	102.0	37.27	114.6	43.99	127.1	50.91	
48	57.0	18.26	68.1	22.70	79.2	27.57	84.7	30.07	90.3	32.57	101.3	38.47	112.4	44.55	
50	10	10.4	1.10	14.1	1.37	19.9	1.73	26.6	2.12	35.0	2.55	50.5	3.36	66.9	4.38
	12	10.4	1.11	14.1	1.39	19.9	1.74	26.6	2.14	35.0	2.57	50.5	3.40	66.9	4.43
	14	10.4	1.12	14.1	1.40	19.9	1.76	26.6	2.16	35.0	2.60	50.5	3.43	66.9	4.47
	16	10.4	1.13	14.1	1.42	19.9	1.78	26.6	2.18	35.0	2.63	50.5	3.47	66.9	4.52
	18	10.4	1.15	14.1	1.43	19.9	1.80	26.6	2.21	35.0	2.66	50.5	3.50	66.9	4.57
	20	10.4	1.16	14.1	1.45	19.9	1.82	26.6	2.23	35.0	2.68	50.5	3.54	66.9	4.61
	21	10.4	1.16	14.1	1.50	24.8	2.33	31.3	2.67	39.9	3.22	54.8	3.89	70.6	5.07
	23	10.4	1.24	22.4	2.55	34.3	3.49	44.3	4.17	50.4	4.73	63.1	5.77	77.9	6.98
	25	18.6	2.26	30.7	3.76	43.9	4.89	58.6	6.77	62.0	6.90	71.4	8.11	85.2	9.86
	27	27.0	3.23	39.0	5.28	54.4	6.81	67.9	9.02	72.1	9.29	79.7	10.62	92.5	12.55
	29	35.3	4.25	47.4	6.81	63.0	8.76	76.4	11.19	82.2	11.99	88.0	13.16	99.8	15.85
	31	43.7	5.40	55.7	8.09	71.7	10.67	83.1	12.48	88.0	13.26	96.2	14.21	107.1	17.43
	33	52.0	7.52	64.0	9.74	80.4	11.98	86.4	13.67	91.7	14.65	104.1	16.84	114.3	19.56
	35	60.5	11.76	72.3	14.14	83.8	16.71	89.6	18.12	95.4	19.53	106.9	22.54	119.0	25.90
	37	60.5	12.46	72.3	14.94	83.8	17.68	89.6	19.18	95.4	20.68	106.9	24.04	119.0	27.49
	39	60.5	13.29	72.3	16.01	83.8	18.94	89.6	20.65	95.4	22.19	106.9	25.61	119.0	29.69
	41	58.9	14.37	70.5	17.33	81.7	20.71	87.3	22.36	92.9	24.04	104.1	28.07	116.0	32.24
43	57.5	15.62	68.7	18.85	79.7	22.53	85.1	24.35	90.6	26.18	101.6	30.61	113.1	35.17	
46	53.9	17.50	64.4	21.14	74.7	25.28	79.8	27.34	84.9	29.39	95.2	34.44	106.0	39.60	
48	47.6	15.25	57.0	18.44	66.1	22.05	70.6	23.86	75.1	25.65	84.2	30.10	93.8	34.61	

**Note**

1. TC: Total Capacity(kW), PI : Power Input(kW, Comp. + Outdoor fan motor)
2. Capacity tables show the average value of conditions which may occur.

# 7. Capacity Tables

## ◆ ARUM660LTE5

Cooling Capacity (66HP)

Combination (%)	Outdoor air temp. (DB, °C)	Indoor air temp. (DB/WB, °C)													
		20		23		26		27		28		30		32	
		14	16	18	19	20	22	24	TC	PI	TC	PI	TC	PI	
130	10	26.0	2.62	35.5	3.28	47.3	3.99	66.7	4.86	88.0	6.08	126.6	8.10	168.0	10.73
	12	26.0	2.65	35.5	3.31	47.3	4.03	66.7	4.91	88.0	6.14	126.6	8.19	168.0	10.84
	14	26.0	2.68	35.5	3.34	47.3	4.07	66.7	4.96	88.0	6.20	126.6	8.27	168.0	10.96
	16	26.0	2.71	35.5	3.38	47.3	4.11	66.7	5.01	88.0	6.27	126.6	8.36	168.0	11.07
	18	26.0	2.73	35.5	3.41	47.3	4.15	66.7	5.07	88.0	6.33	126.6	8.44	168.0	11.18
	20	26.0	2.76	35.5	3.45	47.3	4.19	66.7	5.12	88.0	6.40	126.6	8.53	168.0	11.29
	21	26.0	2.79	36.0	3.55	58.6	5.24	77.8	6.09	98.4	7.86	134.9	10.72	173.3	12.71
	23	45.2	4.95	63.0	6.51	81.4	7.42	101.6	8.25	119.1	11.83	151.6	15.30	184.1	18.02
	25	66.8	7.85	80.9	9.76	104.2	11.09	126.7	13.08	139.8	17.00	168.3	22.23	194.9	26.15
	27	87.2	12.50	103.5	14.76	127.1	16.75	150.6	20.03	160.6	25.43	185.0	32.06	205.7	36.12
	29	107.6	17.36	126.0	20.36	149.9	24.60	175.0	28.97	181.3	34.53	201.9	41.45	216.5	46.13
	31	130.6	22.68	151.4	27.98	176.2	33.95	197.1	39.63	202.1	45.19	213.2	56.77	227.8	57.58
	33	153.6	27.95	179.5	36.51	201.5	43.69	213.0	56.72	217.6	56.32	224.3	56.83	239.5	57.63
	35	183.0	37.76	209.8	45.77	216.5	55.54	220.2	55.81	223.8	56.15	229.9	56.65	236.6	56.87
	37	183.0	40.26	206.8	48.03	213.5	54.80	216.5	55.08	220.2	55.41	226.2	55.90	232.9	56.12
	39	183.0	42.88	203.1	50.56	209.8	54.07	213.5	54.34	216.5	54.67	223.2	55.15	229.9	55.37
41	178.4	45.49	194.7	53.08	201.3	53.33	204.3	53.60	208.3	53.92	214.6	54.41	220.4	54.62	
43	173.9	47.97	186.6	52.34	193.1	52.60	196.0	52.87	199.9	53.18	206.1	53.66	211.7	53.87	
46	163.0	51.35	170.2	51.24	176.4	51.50	179.2	51.76	182.9	52.07	188.6	52.54	193.8	52.74	
48	144.2	49.92	147.8	50.07	153.4	50.17	155.8	50.31	159.1	50.74	164.2	51.06	168.8	51.26	
120	10	24.0	2.45	32.7	3.06	43.6	3.73	61.6	4.55	81.2	5.68	116.8	7.58	155.0	10.04
	12	24.0	2.48	32.7	3.10	43.6	3.77	61.6	4.60	81.2	5.74	116.8	7.66	155.0	10.14
	14	24.0	2.51	32.7	3.13	43.6	3.81	61.6	4.64	81.2	5.80	116.8	7.74	155.0	10.25
	16	24.0	2.53	32.7	3.16	43.6	3.85	61.6	4.69	81.2	5.86	116.8	7.82	155.0	10.35
	18	24.0	2.56	32.7	3.19	43.6	3.88	61.6	4.74	81.2	5.92	116.8	7.90	155.0	10.46
	20	24.0	2.58	32.7	3.22	43.6	3.92	61.6	4.79	81.2	5.98	116.8	7.98	155.0	10.57
	21	24.0	2.61	33.3	3.32	55.3	5.00	71.7	5.70	91.7	7.35	125.1	10.03	160.6	11.89
	23	41.6	4.63	59.7	6.19	78.5	7.11	93.6	7.72	113.5	11.07	142.2	14.31	171.7	16.85
	25	64.9	7.34	83.8	9.28	102.8	10.38	116.8	12.23	136.1	15.90	160.4	20.80	182.8	24.47
	27	90.1	11.60	114.0	13.81	127.6	15.55	138.7	18.59	158.7	23.60	178.6	29.75	193.9	34.07
	29	115.7	16.11	137.2	18.60	152.1	22.83	161.2	26.89	181.2	32.04	196.8	38.46	205.2	43.25
	31	140.0	20.39	165.3	24.59	176.8	30.29	185.6	35.63	204.5	40.64	210.1	48.88	217.2	49.79
	33	162.3	25.14	195.0	32.09	206.6	38.98	209.4	45.22	213.1	53.20	218.9	53.80	225.7	54.23
	35	165.6	33.58	196.9	43.50	208.7	48.12	211.5	57.31	215.2	57.60	221.1	57.77	226.8	58.23
	37	165.6	36.12	196.9	45.90	205.7	51.30	208.7	56.11	211.5	56.39	217.4	56.56	223.3	57.01
	39	165.6	38.89	196.2	48.51	202.1	54.41	205.0	54.95	207.9	55.23	214.5	55.39	220.3	55.83
41	161.4	41.65	187.7	51.13	194.0	53.34	196.8	53.80	199.6	54.07	205.4	54.23	211.2	54.66	
43	157.4	44.46	179.8	50.40	186.0	52.14	188.7	52.65	191.5	52.91	197.2	53.07	202.9	53.49	
46	147.5	47.81	164.0	49.19	169.9	50.51	172.4	50.92	175.0	51.18	180.3	51.33	185.7	51.74	
48	130.5	46.83	142.4	48.32	147.7	49.52	149.9	49.82	152.2	49.98	156.9	50.18	161.6	50.38	
110	10	22.0	2.31	30.0	2.88	40.0	3.50	56.4	4.27	74.3	5.34	107.0	7.12	141.9	9.43
	12	22.0	2.33	30.0	2.91	40.0	3.54	56.4	4.32	74.3	5.40	107.0	7.20	141.9	9.53
	14	22.0	2.35	30.0	2.94	40.0	3.58	56.4	4.36	74.3	5.45	107.0	7.27	141.9	9.63
	16	22.0	2.38	30.0	2.97	40.0	3.61	56.4	4.41	74.3	5.51	107.0	7.35	141.9	9.73
	18	22.0	2.40	30.0	3.00	40.0	3.65	56.4	4.45	74.3	5.57	107.0	7.42	141.9	9.83
	20	22.0	2.43	30.0	3.03	40.0	3.69	56.4	4.50	74.3	5.62	107.0	7.50	141.9	9.93
	21	22.0	2.45	30.0	3.12	50.1	4.61	66.3	5.36	82.7	6.91	115.5	9.42	149.2	11.17
	23	39.3	4.35	50.1	5.82	70.2	6.52	86.4	7.25	104.8	10.40	131.3	13.45	162.2	15.84
	25	56.6	6.90	70.1	8.72	90.2	9.75	106.8	11.49	124.5	14.94	146.7	19.54	174.9	22.99
	27	73.9	10.90	90.2	12.98	110.3	14.61	126.8	17.47	145.1	22.17	163.4	27.95	189.1	32.01
	29	91.2	15.14	110.3	17.48	130.4	21.45	147.5	25.26	165.7	30.11	180.0	35.42	199.5	39.28
	31	110.7	19.16	132.9	23.10	153.4	28.46	168.1	33.48	186.4	38.19	196.7	40.95	206.8	44.09
	33	128.3	23.62	153.4	30.15	173.9	36.63	189.5	40.93	201.5	45.93	207.7	47.20	213.0	47.27
	35	148.4	29.75	176.9	38.28	197.6	43.64	203.2	46.76	206.2	49.63	211.1	50.09	216.9	50.34
	37	148.4	31.53	176.9	40.63	197.6	46.07	200.4	49.54	202.6	52.35	208.3	52.53	213.3	52.68
	39	148.4	34.00	176.9	43.17	194.0	48.61	196.8	52.99	199.7	54.94	204.7	55.03	210.4	55.09
41	144.6	36.46	172.4	45.72	185.7	51.26	188.6	57.31	191.1	57.31	196.6	57.77	201.5	58.23	
43	141.0	38.29	168.1	47.63	178.0	54.36	180.9	54.98	183.2	54.86	188.7	55.17	193.5	55.32	
46	132.1	37.37	157.5	45.98	162.4	51.59	165.2	51.59	167.4	52.04	172.5	52.33	176.9	52.47	
48	116.9	36.29	136.9	44.30	141.0	49.09	143.6	49.42	145.5	49.66	150.0	49.80	154.0	49.99	

# 7. Capacity Tables

Cooling Capacity (66HP)

Combination (%)	Outdoor air temp. (DB, °C)	Indoor air temp. (DB/WB, °C)													
		20		23		26		27		28		30		32	
		14		16		18		19		20		22		24	
		TC	PI	TC	PI	TC	PI	TC	PI	TC	PI	TC	PI	TC	PI
100	10	20.2	2.12	27.5	2.64	36.7	3.21	51.7	3.92	68.2	4.90	98.2	6.53	130.2	8.65
	12	20.2	2.14	27.5	2.67	36.7	3.25	51.7	3.96	68.2	4.95	98.2	6.60	130.2	8.74
	14	20.2	2.16	27.5	2.70	36.7	3.28	51.7	4.00	68.2	5.00	98.2	6.67	130.2	8.83
	16	20.2	2.18	27.5	2.72	36.7	3.32	51.7	4.04	68.2	5.05	98.2	6.74	130.2	8.93
	18	20.2	2.20	27.5	2.75	36.7	3.35	51.7	4.09	68.2	5.11	98.2	6.81	130.2	9.02
	20	20.2	2.23	27.5	2.78	36.7	3.38	51.7	4.13	68.2	5.16	98.2	6.88	130.2	9.11
	21	20.2	2.25	27.5	2.86	45.7	4.23	60.8	4.91	77.7	6.34	106.0	8.65	136.9	10.25
	23	35.0	3.99	48.2	5.34	63.9	5.98	80.0	6.65	97.0	9.54	121.6	12.34	150.2	14.53
	25	49.9	6.33	65.0	8.00	82.1	8.94	99.8	10.55	116.3	13.71	137.1	17.93	163.4	21.09
	27	64.8	10.00	81.7	11.90	100.2	13.40	118.5	16.02	135.6	20.34	152.7	25.65	176.7	29.37
	29	79.8	13.89	98.5	16.03	118.4	19.68	137.8	23.18	154.9	27.62	168.2	33.16	190.0	36.04
	31	94.7	17.58	115.3	21.20	136.6	26.11	157.1	30.72	174.2	35.03	183.8	38.34	204.8	40.86
	33	109.6	21.67	132.1	27.66	154.8	33.61	176.3	38.98	193.7	42.57	199.7	43.31	204.8	44.25
	35	124.7	26.10	148.5	33.32	172.9	41.41	184.8	45.85	193.7	46.13	199.7	46.31	204.8	46.68
	37	124.7	27.95	148.5	35.74	172.9	43.87	184.8	48.03	190.5	48.27	196.0	48.46	200.6	48.91
	39	124.7	29.97	148.5	38.39	172.9	46.49	184.8	50.38	187.3	50.60	192.8	50.79	197.3	51.27
	41	122.8	31.98	146.1	41.05	170.2	49.10	177.3	52.73	181.2	52.94	185.5	53.12	191.5	53.62
43	118.5	33.85	141.1	43.51	164.3	51.45	170.0	54.74	172.0	54.94	177.3	55.12	181.9	55.64	
46	111.1	36.41	132.3	46.91	154.0	54.57	155.2	57.31	156.9	57.48	161.9	57.65	166.3	58.19	
48	98.3	31.44	117.0	40.58	133.0	46.65	134.9	48.63	136.3	48.79	140.8	48.90	144.6	49.29	
90	10	18.1	1.95	24.7	2.43	33.0	3.05	45.6	3.49	61.4	4.51	88.4	5.95	117.2	7.79
	12	18.1	1.97	24.7	2.46	33.0	3.09	45.6	3.53	61.4	4.56	88.4	6.01	117.2	7.87
	14	18.1	1.99	24.7	2.48	33.0	3.12	45.6	3.56	61.4	4.60	88.4	6.07	117.2	7.95
	16	18.1	2.01	24.7	2.51	33.0	3.15	45.6	3.60	61.4	4.65	88.4	6.13	117.2	8.03
	18	18.1	2.03	24.7	2.53	33.0	3.18	45.6	3.64	61.4	4.70	88.4	6.20	117.2	8.12
	20	18.1	2.05	24.7	2.56	33.0	3.21	45.6	3.67	61.4	4.75	88.4	6.26	117.2	8.20
	21	18.1	2.07	24.7	2.58	41.4	4.05	54.0	4.35	69.2	5.69	95.5	6.89	123.3	9.02
	23	24.6	3.20	36.4	4.44	57.8	5.74	70.1	6.26	84.6	8.37	109.7	10.20	135.9	12.40
	25	39.2	5.41	52.7	7.12	74.1	8.50	86.1	9.88	100.0	12.20	124.0	15.42	148.4	17.93
	27	53.7	7.95	68.9	10.14	90.5	13.19	102.2	14.69	115.4	17.79	138.3	20.75	160.9	23.46
	29	68.3	10.74	85.2	13.93	106.9	18.38	118.2	20.31	130.8	23.49	152.5	26.64	173.5	31.05
	31	82.9	13.44	101.5	17.89	123.3	23.01	134.2	25.92	146.3	29.26	166.8	31.02	186.0	36.08
	33	97.4	17.31	117.7	22.01	139.6	27.88	150.3	30.74	161.7	34.02	181.1	36.76	198.6	40.31
	35	112.2	21.43	134.0	27.09	155.8	33.50	166.3	36.94	176.9	40.17	195.2	43.09	198.6	44.08
	37	112.2	22.74	134.0	28.82	155.8	35.72	166.3	39.25	176.9	42.40	192.1	45.04	195.4	46.05
	39	112.2	24.08	134.0	30.65	155.8	37.80	166.3	41.76	176.9	44.59	189.0	47.49	192.3	48.06
	41	109.3	26.94	130.6	33.98	151.8	41.49	162.1	45.67	172.4	48.14	181.1	50.05	184.3	51.19
43	106.6	29.08	127.3	36.72	148.0	45.32	158.1	49.19	168.1	51.61	173.6	53.47	176.8	54.24	
46	99.9	32.73	119.3	41.82	138.7	51.64	148.1	55.77	152.7	57.34	158.5	57.65	161.5	58.19	
48	88.4	28.61	105.6	36.58	122.7	45.18	131.0	48.63	132.6	48.79	137.7	48.90	140.3	49.29	
80	10	15.5	1.72	21.2	2.15	28.2	2.70	39.8	3.11	52.5	3.99	75.6	5.26	100.3	6.88
	12	15.5	1.74	21.2	2.17	28.2	2.73	39.8	3.14	52.5	4.03	75.6	5.31	100.3	6.96
	14	15.5	1.76	21.2	2.19	28.2	2.76	39.8	3.17	52.5	4.07	75.6	5.37	100.3	7.03
	16	15.5	1.77	21.2	2.22	28.2	2.78	39.8	3.20	52.5	4.11	75.6	5.42	100.3	7.10
	18	15.5	1.79	21.2	2.24	28.2	2.81	39.8	3.24	52.5	4.15	75.6	5.48	100.3	7.17
	20	15.5	1.81	21.2	2.26	28.2	2.84	39.8	3.27	52.5	4.19	75.6	5.53	100.3	7.25
	21	15.5	1.82	21.2	2.32	35.4	3.58	47.5	3.92	59.5	5.03	82.2	6.09	106.6	7.97
	23	27.5	3.36	35.1	4.00	50.0	5.08	62.9	5.63	73.6	7.40	95.7	9.02	119.1	10.96
	25	39.5	4.87	49.1	6.41	64.6	7.51	78.3	8.90	87.6	10.79	109.2	13.63	131.6	15.85
	27	51.6	7.16	63.0	9.13	79.2	11.66	93.7	13.23	101.6	15.73	122.7	18.34	144.1	20.74
	29	63.6	9.28	76.9	12.54	93.8	16.25	109.1	18.28	115.7	20.76	136.2	23.55	156.6	27.45
	31	75.6	11.37	90.9	15.78	108.4	20.34	124.4	23.33	132.3	25.16	149.7	27.15	169.1	31.58
	33	87.6	14.95	104.8	19.42	123.0	23.91	139.9	27.67	148.1	28.91	163.1	32.17	181.5	35.55
	35	99.7	19.57	118.8	24.53	137.9	30.09	147.8	33.05	157.7	36.18	176.9	41.05	193.9	42.76
	37	99.7	20.70	118.8	26.08	137.9	31.92	147.8	35.14	157.7	38.44	176.9	43.32	190.8	44.91
	39	99.7	21.88	118.8	27.57	137.9	34.15	147.8	37.78	157.7	41.31	176.9	45.77	187.7	47.38
	41	97.1	24.20	115.8	30.55	134.4	37.47	144.1	41.41	153.7	45.39	172.4	49.05	179.8	50.17
43	94.7	26.64	112.9	33.34	131.1	40.91	140.5	45.13	149.9	49.61	168.1	52.40	172.4	53.70	
46	88.8	29.64	105.8	37.55	122.8	46.09	131.7	50.23	140.5	55.98	153.7	57.65	157.3	58.19	
48	78.5	25.88	93.6	32.84	108.7	40.31	116.5	43.87	124.3	48.79	133.5	48.90	136.7	49.29	

# 7. Capacity Tables

Cooling Capacity (66HP)

Combination (%)	Outdoor air temp. (DB, °C)	Indoor air temp. (DB/WB, °C)													
		20		23		26		27		28		30		32	
		14		16		18		19		20		22		24	
		TC	PI	TC	PI	TC	PI	TC	PI	TC	PI	TC	PI	TC	PI
70	10	13.5	1.52	18.4	1.90	24.6	2.39	34.7	2.76	45.7	3.52	65.8	4.65	87.2	6.09
	12	13.5	1.54	18.4	1.92	24.6	2.41	34.7	2.79	45.7	3.56	65.8	4.70	87.2	6.15
	14	13.5	1.55	18.4	1.94	24.6	2.44	34.7	2.82	45.7	3.60	65.8	4.74	87.2	6.21
	16	13.5	1.57	18.4	1.96	24.6	2.46	34.7	2.85	45.7	3.63	65.8	4.79	87.2	6.28
	18	13.5	1.58	18.4	1.98	24.6	2.49	34.7	2.88	45.7	3.67	65.8	4.84	87.2	6.34
	20	13.5	1.60	18.4	2.00	24.6	2.51	34.7	2.91	45.7	3.71	65.8	4.89	87.2	6.41
	21	13.5	1.61	21.5	2.35	31.9	3.29	42.9	3.65	52.8	4.45	72.5	5.38	93.9	7.05
	23	19.4	2.42	33.3	3.84	44.6	4.82	57.8	5.24	67.0	6.54	86.2	7.97	106.9	9.69
	25	30.7	3.99	45.1	5.67	57.3	6.64	72.6	8.27	81.2	9.53	99.8	12.05	119.9	14.01
	27	42.0	5.82	56.8	8.07	69.9	9.79	87.5	12.30	95.4	13.91	113.4	16.22	132.9	18.33
	29	53.3	7.38	68.6	10.66	82.6	13.32	102.3	16.73	109.6	18.35	127.1	20.82	145.9	24.27
	31	64.6	9.08	80.4	13.25	95.3	16.68	117.2	21.02	123.8	22.25	140.7	24.00	158.9	27.92
	33	75.9	12.21	92.2	16.12	108.0	19.37	129.4	24.40	137.9	25.56	154.4	28.44	171.6	31.43
	35	87.1	16.72	104.3	20.84	120.8	25.21	129.4	27.57	137.9	30.11	154.4	35.45	171.6	38.87
	37	87.1	17.77	104.3	22.07	120.8	26.78	129.4	29.32	137.9	32.04	154.4	37.72	171.6	41.02
	39	87.1	18.87	104.3	23.53	120.8	28.64	129.4	31.55	137.9	34.61	154.4	40.37	171.6	44.22
	41	84.9	20.86	101.6	25.78	117.7	31.41	126.0	34.60	134.4	37.62	150.5	44.35	167.2	47.66
43	82.8	22.71	99.1	28.09	114.8	34.28	122.9	37.73	131.1	41.08	146.8	48.44	163.1	51.55	
46	77.6	25.23	92.9	31.59	107.6	38.60	115.2	42.03	122.8	46.31	137.5	54.64	152.8	57.49	
48	68.6	22.02	82.2	27.59	95.2	33.75	101.9	36.73	108.7	40.51	121.7	47.81	135.2	49.29	
60	10	11.9	1.31	15.9	1.64	21.3	2.05	30.0	2.40	39.6	3.03	56.9	4.00	75.5	5.24
	12	11.9	1.32	15.9	1.65	21.3	2.08	30.0	2.42	39.6	3.07	56.9	4.04	75.5	5.30
	14	11.9	1.34	15.9	1.67	21.3	2.10	30.0	2.45	39.6	3.10	56.9	4.09	75.5	5.35
	16	11.9	1.35	15.9	1.69	21.3	2.12	30.0	2.47	39.6	3.13	56.9	4.13	75.5	5.41
	18	11.9	1.36	15.9	1.70	21.3	2.14	30.0	2.50	39.6	3.16	56.9	4.17	75.5	5.46
	20	11.9	1.38	15.9	1.72	21.3	2.16	30.0	2.52	39.6	3.19	56.9	4.21	75.5	5.52
	21	11.9	1.39	15.9	1.78	26.6	2.77	35.3	3.06	45.3	3.83	61.8	4.63	80.4	6.07
	23	11.9	1.53	26.4	3.23	37.6	4.15	48.8	4.44	57.1	5.63	71.9	6.86	89.9	8.35
	25	22.1	2.92	36.9	4.88	48.6	5.72	62.9	7.58	68.9	8.21	83.7	10.17	99.4	12.06
	27	32.6	4.26	47.3	6.95	59.5	8.43	75.9	10.54	80.7	11.78	93.9	13.47	109.0	15.53
	29	43.1	5.52	57.8	8.90	70.5	11.24	89.6	13.85	92.5	15.02	104.2	16.89	118.5	19.85
	31	53.5	7.02	68.2	10.64	81.5	13.69	100.5	16.62	104.3	17.45	116.8	18.70	128.0	22.88
	33	64.0	9.77	78.7	12.94	92.5	15.37	108.4	18.64	116.2	19.96	126.0	22.16	137.6	26.06
	35	74.6	14.18	89.1	17.35	103.6	20.79	110.9	22.64	118.1	24.58	132.7	28.72	147.2	33.12
	37	74.6	14.97	89.1	18.31	103.6	22.02	110.9	24.05	118.1	26.07	132.7	30.48	147.2	35.23
	39	74.6	15.92	89.1	19.50	103.6	23.77	110.9	25.80	118.1	28.06	132.7	32.68	147.2	37.76
	41	72.7	17.27	86.8	21.34	101.0	25.81	108.0	28.18	115.1	30.46	129.3	35.86	143.4	41.03
43	70.9	18.77	84.7	23.23	98.5	28.14	105.4	30.71	112.3	33.21	126.1	39.15	139.9	44.81	
46	66.4	21.02	79.4	26.08	92.3	31.65	98.7	34.52	105.2	37.37	118.1	44.11	131.1	51.06	
48	58.8	18.32	70.2	22.76	81.6	27.65	87.4	30.15	93.1	32.66	104.5	38.58	116.0	44.67	
50	10	10.7	1.13	14.6	1.41	20.5	1.77	27.4	2.17	36.1	2.62	52.0	3.45	69.0	4.50
	12	10.7	1.14	14.6	1.43	20.5	1.79	27.4	2.20	36.1	2.64	52.0	3.49	69.0	4.55
	14	10.7	1.15	14.6	1.44	20.5	1.81	27.4	2.22	36.1	2.67	52.0	3.52	69.0	4.59
	16	10.7	1.17	14.6	1.46	20.5	1.83	27.4	2.24	36.1	2.70	52.0	3.56	69.0	4.64
	18	10.7	1.18	14.6	1.47	20.5	1.85	27.4	2.27	36.1	2.73	52.0	3.60	69.0	4.69
	20	10.7	1.19	14.6	1.48	20.5	1.87	27.4	2.29	36.1	2.75	52.0	3.63	69.0	4.74
	21	10.7	1.20	14.6	1.54	25.5	2.39	32.3	2.75	41.1	3.31	56.5	4.00	72.8	5.21
	23	10.7	1.27	23.1	2.62	35.4	3.58	45.7	4.29	52.0	4.86	65.0	5.92	80.3	7.17
	25	19.2	2.32	31.7	3.86	45.3	5.02	60.4	6.95	64.0	7.08	73.6	8.33	87.8	10.12
	27	27.8	3.32	40.3	5.42	56.1	7.00	70.1	9.26	74.4	9.55	82.2	10.91	95.4	12.89
	29	36.4	4.36	48.8	6.99	65.0	9.00	78.8	11.49	84.8	12.31	90.8	13.52	102.9	16.28
	31	45.0	5.55	57.4	8.31	74.0	10.96	85.7	12.81	90.7	13.62	99.2	14.60	110.5	17.91
	33	53.6	7.73	66.0	10.00	82.9	12.30	89.1	14.04	94.5	15.05	107.3	17.30	117.8	20.09
	35	62.4	11.79	74.6	14.18	86.5	16.75	92.4	18.17	98.3	19.59	110.2	22.60	122.8	25.97
	37	62.4	12.50	74.6	14.98	86.5	17.73	92.4	19.23	98.3	20.74	110.2	24.11	122.8	27.57
	39	62.4	13.33	74.6	16.06	86.5	18.99	92.4	20.70	98.3	22.26	110.2	25.68	122.8	29.77
	41	60.8	14.42	72.7	17.38	84.2	20.77	90.0	22.42	95.8	24.11	107.4	28.15	119.6	32.33
43	59.3	15.67	70.9	18.91	82.2	22.60	87.8	24.42	93.5	26.25	104.7	30.70	116.7	35.27	
46	55.5	17.55	66.4	21.21	77.0	25.35	82.3	27.42	87.6	29.47	98.2	34.54	109.3	39.71	
48	49.1	15.29	58.8	18.49	68.1	22.11	72.8	23.93	77.5	25.72	86.8	30.18	96.7	34.71	

**Note**

1. TC: Total Capacity(kW), PI : Power Input(kW, Comp. + Outdoor fan motor)
2. Capacity tables show the average value of conditions which may occur.

# 7. Capacity Tables

◆ ARUM680LTE5

Cooling Capacity (68HP)

Combination (%)	Outdoor air temp. (DB, °C)	Indoor air temp. (DB/WB, °C)													
		20		23		26		27		28		30		32	
		14	16	18	19	20	22	24	TC	PI	TC	PI	TC	PI	
130	10	26.8	2.72	36.5	3.40	48.7	4.14	68.8	5.04	90.6	6.31	130.5	8.41	173.1	11.13
	12	26.8	2.75	36.5	3.43	48.7	4.18	68.8	5.10	90.6	6.37	130.5	8.50	173.1	11.25
	14	26.8	2.78	36.5	3.47	48.7	4.22	68.8	5.15	90.6	6.44	130.5	8.59	173.1	11.37
	16	26.8	2.81	36.5	3.51	48.7	4.27	68.8	5.20	90.6	6.50	130.5	8.67	173.1	11.49
	18	26.8	2.84	36.5	3.54	48.7	4.31	68.8	5.26	90.6	6.57	130.5	8.76	173.1	11.60
	20	26.8	2.87	36.5	3.58	48.7	4.35	68.8	5.31	90.6	6.64	130.5	8.85	173.1	11.72
	21	26.8	2.89	37.1	3.69	60.3	5.44	80.2	6.32	101.3	8.15	139.0	11.13	178.6	13.19
	23	46.6	5.14	64.9	6.75	83.9	7.70	104.7	8.56	122.7	12.27	156.2	15.87	189.7	18.70
	25	68.8	8.14	83.4	10.13	107.4	11.51	130.6	13.57	144.1	17.64	173.4	23.07	200.8	27.14
	27	89.8	12.97	106.6	15.32	130.9	17.39	155.1	20.79	165.4	26.39	190.6	33.27	211.9	37.48
	29	110.9	18.01	129.8	21.13	154.5	25.53	180.3	30.06	186.8	35.83	208.0	43.01	223.1	47.87
	31	134.5	23.53	156.0	29.04	181.6	35.23	203.0	41.12	208.2	46.90	219.7	58.91	234.7	59.75
	33	158.3	29.01	185.0	37.89	207.6	45.34	219.4	58.86	224.2	58.45	231.1	58.97	246.8	59.80
	35	188.6	39.18	216.1	47.49	223.0	57.63	226.9	57.92	230.6	58.27	236.8	58.79	243.7	59.02
	37	188.6	41.78	213.1	49.84	220.0	56.87	223.0	57.16	226.9	57.50	233.1	58.01	240.0	58.24
	39	188.6	44.49	209.3	52.46	216.1	56.11	220.0	56.39	223.0	56.73	229.9	57.24	236.8	57.46
41	183.8	47.20	200.6	55.09	207.4	55.35	210.5	55.63	214.6	55.96	221.1	56.46	227.1	56.68	
43	179.2	49.78	192.3	54.31	198.9	54.59	202.0	54.86	206.0	55.19	212.3	55.68	218.1	55.90	
46	168.0	53.29	175.4	53.18	181.7	53.44	184.6	53.71	188.4	54.03	194.4	54.52	199.7	54.73	
48	148.6	51.80	152.3	51.95	158.0	52.07	160.5	52.21	163.9	52.66	169.2	52.99	173.9	53.20	
120	10	24.7	2.55	33.7	3.18	45.0	3.87	63.4	4.72	83.6	5.90	120.4	7.87	159.7	10.42
	12	24.7	2.57	33.7	3.21	45.0	3.91	63.4	4.77	83.6	5.96	120.4	7.95	159.7	10.53
	14	24.7	2.60	33.7	3.25	45.0	3.95	63.4	4.82	83.6	6.02	120.4	8.03	159.7	10.64
	16	24.7	2.63	33.7	3.28	45.0	3.99	63.4	4.87	83.6	6.09	120.4	8.11	159.7	10.74
	18	24.7	2.65	33.7	3.31	45.0	4.03	63.4	4.92	83.6	6.15	120.4	8.20	159.7	10.85
	20	24.7	2.68	33.7	3.35	45.0	4.07	63.4	4.97	83.6	6.21	120.4	8.28	159.7	10.96
	21	24.7	2.71	34.3	3.45	56.9	5.19	73.9	5.92	94.5	7.63	128.9	10.41	165.4	12.34
	23	42.9	4.81	61.6	6.42	80.9	7.38	96.5	8.01	117.0	11.48	146.5	14.85	176.9	17.49
	25	66.8	7.62	86.3	9.63	106.0	10.77	120.3	12.69	140.2	16.50	165.3	21.58	188.4	25.39
	27	92.8	12.04	117.4	14.33	131.5	16.13	142.9	19.29	163.5	24.49	184.1	30.87	199.8	35.35
	29	119.2	16.72	141.4	19.30	156.7	23.69	166.1	27.90	186.7	33.25	202.8	39.91	211.4	44.88
	31	144.3	21.16	170.3	25.52	182.2	31.43	191.2	36.98	210.7	42.17	216.5	50.72	223.8	51.67
	33	167.2	26.08	200.9	33.30	212.8	40.45	215.8	46.92	219.5	55.20	225.5	55.83	232.6	56.28
	35	170.6	34.85	202.9	45.14	215.0	49.93	218.0	59.48	221.7	59.77	227.8	59.95	233.7	60.43
	37	170.6	37.49	202.9	47.64	211.9	53.24	215.0	58.22	218.0	58.52	224.0	58.69	230.0	59.16
	39	170.6	40.36	202.2	50.35	208.2	56.47	211.2	57.03	214.2	57.31	221.0	57.48	227.0	57.94
41	166.3	43.22	193.4	53.06	199.9	55.35	202.7	55.83	205.7	56.11	211.6	56.28	217.6	56.73	
43	162.2	46.14	185.3	52.30	191.7	54.11	194.4	54.64	197.3	54.91	203.1	55.07	209.0	55.51	
46	152.0	49.61	168.9	51.05	175.1	52.41	177.6	52.84	180.3	53.11	185.8	53.26	191.3	53.69	
48	134.4	48.60	146.7	50.14	152.1	51.39	154.4	51.70	156.8	51.87	161.6	52.07	166.5	52.28	
110	10	22.6	2.39	30.9	2.99	41.2	3.64	58.1	4.43	76.6	5.54	110.3	7.39	146.2	9.79
	12	22.6	2.42	30.9	3.02	41.2	3.67	58.1	4.48	76.6	5.60	110.3	7.47	146.2	9.89
	14	22.6	2.44	30.9	3.05	41.2	3.71	58.1	4.53	76.6	5.66	110.3	7.55	146.2	9.99
	16	22.6	2.47	30.9	3.08	41.2	3.75	58.1	4.57	76.6	5.72	110.3	7.63	146.2	10.10
	18	22.6	2.49	30.9	3.11	41.2	3.79	58.1	4.62	76.6	5.78	110.3	7.70	146.2	10.20
	20	22.6	2.52	30.9	3.14	41.2	3.83	58.1	4.67	76.6	5.83	110.3	7.78	146.2	10.30
	21	22.6	2.54	30.9	3.24	51.6	4.78	68.3	5.56	85.2	7.17	119.0	9.78	153.7	11.59
	23	40.5	4.52	51.6	6.04	72.3	6.77	89.1	7.53	108.0	10.79	135.3	13.95	167.1	16.43
	25	58.4	7.16	72.3	9.05	93.0	10.12	110.0	11.93	128.2	15.51	151.2	20.28	180.2	23.86
	27	76.2	11.31	92.9	13.47	113.6	15.16	130.7	18.13	149.5	23.01	168.3	29.01	194.8	33.22
	29	94.0	15.71	113.6	18.14	134.3	22.26	151.9	26.22	170.8	31.25	185.5	36.75	205.5	40.76
	31	114.1	19.89	137.0	23.98	158.1	29.54	173.2	34.75	192.0	39.63	202.6	42.50	213.1	45.75
	33	132.2	24.51	158.1	31.29	179.2	38.01	195.3	42.47	207.6	47.67	214.0	48.98	219.5	49.05
	35	152.9	30.88	182.2	39.73	203.6	45.29	209.4	48.52	212.4	51.51	217.5	51.98	223.4	52.24
	37	152.9	32.72	182.2	42.16	203.6	47.81	206.5	51.41	208.7	54.32	214.6	54.51	219.7	54.66
	39	152.9	35.28	182.2	44.80	199.9	50.45	202.8	54.99	205.8	57.02	210.9	57.11	216.8	57.17
41	149.0	37.84	177.6	47.44	191.3	53.20	194.3	59.48	196.8	59.48	202.6	59.95	207.6	60.43	
43	145.3	39.73	173.2	49.43	183.4	56.42	186.4	57.05	188.8	56.93	194.4	57.25	199.3	57.41	
46	136.1	38.78	162.3	47.72	167.3	53.54	170.2	53.54	172.4	54.00	177.7	54.30	182.3	54.45	
48	120.4	37.66	141.1	45.97	145.3	50.94	148.0	51.28	149.9	51.53	154.5	51.67	158.6	51.88	

# 7. Capacity Tables

Cooling Capacity (68HP)

Combination (%)	Outdoor air temp. (DB, °C)	Indoor air temp. (DB/WB, °C)													
		20		23		26		27		28		30		32	
		14		16		18		19		20		22		24	
		TC	PI	TC	PI	TC	PI	TC	PI	TC	PI	TC	PI	TC	PI
100	10	20.8	2.20	28.3	2.74	37.8	3.34	53.3	4.07	70.3	5.09	101.2	6.78	134.2	8.98
	12	20.8	2.22	28.3	2.77	37.8	3.37	53.3	4.11	70.3	5.14	101.2	6.85	134.2	9.07
	14	20.8	2.24	28.3	2.80	37.8	3.41	53.3	4.15	70.3	5.19	101.2	6.92	134.2	9.17
	16	20.8	2.26	28.3	2.83	37.8	3.44	53.3	4.20	70.3	5.25	101.2	7.00	134.2	9.26
	18	20.8	2.29	28.3	2.86	37.8	3.48	53.3	4.24	70.3	5.30	101.2	7.07	134.2	9.36
	20	20.8	2.31	28.3	2.89	37.8	3.51	53.3	4.28	70.3	5.35	101.2	7.14	134.2	9.45
	21	20.8	2.33	28.3	2.97	47.1	4.39	62.6	5.10	80.1	6.58	109.2	8.97	141.0	10.64
	23	36.0	4.14	49.6	5.54	65.8	6.21	82.5	6.90	100.0	9.90	125.2	12.80	154.7	15.08
	25	51.4	6.57	66.9	8.30	84.5	9.28	102.8	10.94	119.8	14.23	141.3	18.60	168.4	21.89
	27	66.8	10.38	84.2	12.35	103.3	13.91	122.1	16.63	139.7	21.11	157.3	26.61	182.0	30.47
	29	82.2	14.41	101.5	16.64	122.0	20.42	142.0	24.05	159.6	28.67	173.3	34.41	195.7	37.40
	31	97.6	18.24	118.8	22.00	140.7	27.10	161.8	31.88	179.5	36.36	189.4	39.78	211.0	42.40
	33	112.9	22.49	136.1	28.71	159.5	34.87	181.7	40.45	199.5	44.17	205.7	44.94	211.0	45.92
	35	128.5	27.09	153.0	34.58	178.2	42.98	190.4	47.58	199.5	47.87	205.7	48.05	211.0	48.44
	37	128.5	29.01	153.0	37.09	178.2	45.52	190.4	49.85	196.3	50.09	201.9	50.29	206.7	50.76
	39	128.5	31.10	153.0	39.84	178.2	48.24	190.4	52.28	193.0	52.51	198.7	52.71	203.3	53.20
	41	126.5	33.19	150.6	42.59	175.3	50.96	182.7	54.72	186.7	54.94	191.1	55.13	197.3	55.64
43	122.1	35.13	145.4	45.15	169.3	53.39	175.2	56.81	177.2	57.01	182.7	57.20	187.4	57.74	
46	114.5	37.78	136.3	48.68	158.7	56.63	159.9	59.48	161.7	59.65	166.9	59.82	171.3	60.39	
48	101.3	32.62	120.5	42.12	137.0	48.41	139.0	50.46	140.4	50.63	145.1	50.74	149.0	51.15	
90	10	18.7	2.02	25.5	2.52	34.0	3.17	47.0	3.62	63.2	4.68	91.0	6.17	120.7	8.08
	12	18.7	2.04	25.5	2.55	34.0	3.20	47.0	3.66	63.2	4.73	91.0	6.24	120.7	8.17
	14	18.7	2.06	25.5	2.57	34.0	3.23	47.0	3.70	63.2	4.78	91.0	6.30	120.7	8.25
	16	18.7	2.08	25.5	2.60	34.0	3.27	47.0	3.73	63.2	4.83	91.0	6.37	120.7	8.34
	18	18.7	2.10	25.5	2.63	34.0	3.30	47.0	3.77	63.2	4.88	91.0	6.43	120.7	8.42
	20	18.7	2.13	25.5	2.65	34.0	3.34	47.0	3.81	63.2	4.92	91.0	6.50	120.7	8.51
	21	18.7	2.15	25.5	2.68	42.6	4.20	55.7	4.52	71.3	5.91	98.4	7.15	127.1	9.36
	23	25.4	3.32	37.5	4.61	59.5	5.96	72.2	6.49	87.2	8.69	113.1	10.59	140.0	12.87
	25	40.4	5.61	54.3	7.39	76.4	8.82	88.7	10.26	103.0	12.66	127.8	16.00	152.9	18.60
	27	55.4	8.25	71.0	10.52	93.3	13.69	105.3	15.25	118.9	18.47	142.5	21.54	165.8	24.34
	29	70.4	11.14	87.8	14.45	110.1	19.07	121.8	21.08	134.8	24.37	157.2	27.65	178.7	32.22
	31	85.4	13.95	104.5	18.56	127.0	23.87	138.3	26.90	150.7	30.36	171.9	32.19	191.6	37.45
	33	100.4	17.96	121.3	22.84	143.9	28.94	154.8	31.90	166.6	35.30	186.6	38.15	204.6	41.83
	35	115.6	22.24	138.0	28.11	160.5	34.76	171.4	38.34	182.2	41.68	201.2	44.72	204.6	45.74
	37	115.6	23.60	138.0	29.90	160.5	37.06	171.4	40.73	182.2	44.00	197.9	46.74	201.3	47.79
	39	115.6	24.99	138.0	31.81	160.5	39.23	171.4	43.34	182.2	46.27	194.7	49.28	198.1	49.87
	41	112.6	27.96	134.5	35.26	156.4	43.05	167.0	47.40	177.6	49.95	186.5	51.94	189.9	53.13
43	109.9	30.18	131.2	38.10	152.5	47.03	162.8	51.04	173.2	53.56	178.9	55.48	182.1	56.29	
46	103.0	33.97	122.9	43.40	142.9	53.58	152.6	57.87	157.4	59.51	163.3	59.82	166.3	60.39	
48	91.1	29.69	108.8	37.96	126.4	46.88	135.0	50.46	136.7	50.63	141.9	50.74	144.6	51.15	
80	10	16.0	1.79	21.8	2.23	29.1	2.80	41.1	3.22	54.1	4.14	77.9	5.46	103.3	7.14
	12	16.0	1.80	21.8	2.25	29.1	2.83	41.1	3.26	54.1	4.18	77.9	5.51	103.3	7.22
	14	16.0	1.82	21.8	2.28	29.1	2.86	41.1	3.29	54.1	4.22	77.9	5.57	103.3	7.29
	16	16.0	1.84	21.8	2.30	29.1	2.89	41.1	3.32	54.1	4.27	77.9	5.63	103.3	7.37
	18	16.0	1.86	21.8	2.32	29.1	2.92	41.1	3.36	54.1	4.31	77.9	5.69	103.3	7.44
	20	16.0	1.88	21.8	2.35	29.1	2.95	41.1	3.39	54.1	4.35	77.9	5.74	103.3	7.52
	21	16.0	1.89	21.8	2.41	36.5	3.71	49.0	4.06	61.3	5.22	84.7	6.32	109.8	8.27
	23	28.4	3.49	36.2	4.15	51.6	5.27	64.8	5.84	75.8	7.68	98.6	9.36	122.7	11.38
	25	40.7	5.05	50.6	6.65	66.6	7.80	80.7	9.23	90.2	11.19	112.5	14.14	135.6	16.45
	27	53.1	7.43	64.9	9.47	81.6	12.10	96.5	13.72	104.7	16.32	126.4	19.04	148.4	21.52
	29	65.5	9.63	79.3	13.01	96.7	16.86	112.4	18.97	119.2	21.55	140.3	24.44	161.3	28.49
	31	77.9	11.80	93.6	16.37	111.7	21.11	128.2	24.21	136.3	26.11	154.2	28.17	174.2	32.77
	33	90.2	15.52	108.0	20.15	126.8	24.81	144.1	28.71	152.6	30.00	168.1	33.38	187.0	36.89
	35	102.7	20.31	122.4	25.45	142.1	31.23	152.3	34.30	162.5	37.55	182.2	42.60	199.8	44.37
	37	102.7	21.48	122.4	27.06	142.1	33.12	152.3	36.46	162.5	39.89	182.2	44.96	196.6	46.61
	39	102.7	22.70	122.4	28.61	142.1	35.43	152.3	39.20	162.5	42.87	182.2	47.50	193.4	49.17
	41	100.1	25.11	119.3	31.70	138.5	38.89	148.4	42.97	158.4	47.11	177.6	50.90	185.2	52.06
43	97.6	27.65	116.3	34.60	135.1	42.45	144.8	46.83	154.4	51.48	173.2	54.37	177.6	55.72	
46	91.4	30.76	109.0	38.97	126.6	47.83	135.7	52.12	144.7	58.09	158.4	59.82	162.1	60.39	
48	80.9	26.86	96.4	34.07	112.0	41.83	120.0	45.53	128.0	50.63	137.6	50.74	140.9	51.15	



# 7. Capacity Tables

Cooling Capacity (68HP)

Combination (%)	Outdoor air temp. (DB, °C)	Indoor air temp. (DB/WB, °C)													
		20		23		26		27		28		30		32	
		14		16		18		19		20		22		24	
		TC	PI	TC	PI	TC	PI	TC	PI	TC	PI	TC	PI	TC	PI
70	10	13.9	1.58	19.0	1.97	25.3	2.48	35.7	2.87	47.1	3.66	67.8	4.82	89.9	6.32
	12	13.9	1.59	19.0	1.99	25.3	2.50	35.7	2.90	47.1	3.69	67.8	4.87	89.9	6.38
	14	13.9	1.61	19.0	2.01	25.3	2.53	35.7	2.93	47.1	3.73	67.8	4.92	89.9	6.45
	16	13.9	1.63	19.0	2.03	25.3	2.55	35.7	2.96	47.1	3.77	67.8	4.97	89.9	6.51
	18	13.9	1.64	19.0	2.05	25.3	2.58	35.7	2.99	47.1	3.81	67.8	5.03	89.9	6.58
	20	13.9	1.66	19.0	2.07	25.3	2.61	35.7	3.02	47.1	3.85	67.8	5.08	89.9	6.65
	21	13.9	1.67	22.1	2.44	32.9	3.42	44.2	3.79	54.4	4.62	74.7	5.58	96.7	7.31
	23	20.0	2.51	34.3	3.98	45.9	5.00	59.5	5.43	69.0	6.79	88.8	8.27	110.1	10.06
	25	31.6	4.14	46.4	5.88	59.0	6.89	74.8	8.59	83.6	9.89	102.8	12.50	123.6	14.54
	27	43.3	6.04	58.6	8.37	72.0	10.16	90.1	12.76	98.3	14.43	116.9	16.83	137.0	19.02
	29	54.9	7.66	70.7	11.06	85.1	13.82	105.4	17.36	112.9	19.05	130.9	21.61	150.4	25.18
	31	66.6	9.42	82.9	13.75	98.2	17.31	120.7	21.81	127.5	23.08	145.0	24.90	163.8	28.97
	33	78.2	12.67	95.0	16.72	111.2	20.10	133.3	25.32	142.1	26.52	159.1	29.51	176.8	32.61
	35	89.8	17.35	107.4	21.63	124.4	26.16	133.3	28.61	142.1	31.25	159.1	36.79	176.8	40.33
	37	89.8	18.44	107.4	22.90	124.4	27.79	133.3	30.43	142.1	33.24	159.1	39.15	176.8	42.57
	39	89.8	19.58	107.4	24.42	124.4	29.72	133.3	32.74	142.1	35.91	159.1	41.90	176.8	45.89
	41	87.5	21.65	104.7	26.75	121.3	32.60	129.9	35.91	138.5	39.04	155.0	46.02	172.3	49.46
	43	85.3	23.56	102.1	29.15	118.3	35.57	126.7	39.16	135.1	42.63	151.2	50.27	168.0	53.50
46	79.9	26.19	95.7	32.78	110.8	40.06	118.7	43.61	126.6	48.06	141.7	56.70	157.5	59.66	
48	70.7	22.85	84.6	28.63	98.0	35.02	105.0	38.11	112.0	42.04	125.4	49.62	139.3	51.15	
60	10	12.3	1.36	16.4	1.70	21.9	2.14	30.9	2.49	40.8	3.16	58.7	4.16	77.8	5.45
	12	12.3	1.38	16.4	1.72	21.9	2.16	30.9	2.52	40.8	3.19	58.7	4.21	77.8	5.51
	14	12.3	1.39	16.4	1.74	21.9	2.18	30.9	2.55	40.8	3.22	58.7	4.25	77.8	5.57
	16	12.3	1.41	16.4	1.76	21.9	2.21	30.9	2.57	40.8	3.26	58.7	4.30	77.8	5.63
	18	12.3	1.42	16.4	1.77	21.9	2.23	30.9	2.60	40.8	3.29	58.7	4.34	77.8	5.68
	20	12.3	1.43	16.4	1.79	21.9	2.25	30.9	2.62	40.8	3.32	58.7	4.38	77.8	5.74
	21	12.3	1.44	16.4	1.86	27.4	2.89	36.3	3.18	46.7	3.99	63.7	4.82	82.8	6.31
	23	12.3	1.59	27.2	3.36	38.7	4.32	50.3	4.62	58.9	5.86	74.1	7.14	92.6	8.69
	25	22.8	3.04	38.0	5.08	50.0	5.95	64.8	7.88	71.0	8.54	86.2	10.58	102.4	12.55
	27	33.6	4.43	48.8	7.23	61.3	8.78	78.2	10.97	83.2	12.26	96.8	14.02	112.3	16.17
	29	44.4	5.75	59.5	9.26	72.7	11.70	92.3	14.41	95.3	15.63	107.4	17.58	122.1	20.66
	31	55.1	7.31	70.3	11.08	84.0	14.25	103.6	17.30	107.5	18.15	120.3	19.46	131.9	23.81
	33	65.9	10.17	81.1	13.47	95.3	16.00	111.7	19.39	119.7	20.78	129.9	23.06	141.7	27.12
	35	76.8	14.72	91.8	18.01	106.8	21.57	114.2	23.49	121.7	25.50	136.7	29.80	151.6	34.37
	37	76.8	15.54	91.8	19.00	106.8	22.85	114.2	24.95	121.7	27.06	136.7	31.63	151.6	36.56
	39	76.8	16.53	91.8	20.23	106.8	24.67	114.2	26.77	121.7	29.12	136.7	33.91	151.6	39.18
	41	74.9	17.92	89.5	22.14	104.0	26.79	111.3	29.25	118.6	31.61	133.2	37.22	147.8	42.58
	43	73.0	19.48	87.2	24.11	101.5	29.20	108.6	31.87	115.7	34.47	129.9	40.63	144.1	46.51
46	68.4	21.81	81.8	27.07	95.1	32.84	101.7	35.83	108.4	38.78	121.7	45.78	135.0	52.98	
48	60.5	19.01	72.3	23.62	84.1	28.69	90.0	31.29	95.9	33.89	107.7	40.03	119.5	46.36	
50	10	11.0	1.18	15.0	1.47	21.2	1.85	28.3	2.27	37.2	2.73	53.6	3.60	71.1	4.70
	12	11.0	1.19	15.0	1.49	21.2	1.87	28.3	2.29	37.2	2.76	53.6	3.64	71.1	4.75
	14	11.0	1.20	15.0	1.50	21.2	1.89	28.3	2.32	37.2	2.79	53.6	3.68	71.1	4.80
	16	11.0	1.22	15.0	1.52	21.2	1.91	28.3	2.34	37.2	2.82	53.6	3.72	71.1	4.85
	18	11.0	1.23	15.0	1.53	21.2	1.93	28.3	2.37	37.2	2.85	53.6	3.75	71.1	4.89
	20	11.0	1.24	15.0	1.55	21.2	1.95	28.3	2.39	37.2	2.88	53.6	3.79	71.1	4.94
	21	11.0	1.25	15.0	1.61	26.3	2.50	33.3	2.87	42.3	3.45	58.2	4.17	75.0	5.44
	23	11.0	1.33	23.8	2.73	36.5	3.74	47.1	4.47	53.6	5.07	67.0	6.18	82.7	7.48
	25	19.8	2.42	32.7	4.03	46.6	5.24	62.3	7.25	65.9	7.39	75.9	8.70	90.5	10.57
	27	28.6	3.47	41.5	5.66	57.8	7.30	72.2	9.67	76.6	9.96	84.7	11.39	98.3	13.45
	29	37.5	4.56	50.3	7.30	67.0	9.39	81.2	11.99	87.3	12.85	93.5	14.11	106.0	16.99
	31	46.4	5.79	59.2	8.67	76.2	11.44	88.3	13.38	93.5	14.22	102.2	15.24	113.8	18.69
	33	55.3	8.07	68.0	10.44	85.4	12.84	91.8	14.66	97.4	15.70	110.6	18.06	121.4	20.97
	35	64.3	12.23	76.8	14.72	89.1	17.38	95.2	18.86	101.3	20.33	113.6	23.46	126.5	26.95
	37	64.3	12.97	76.8	15.54	89.1	18.40	95.2	19.96	101.3	21.52	113.6	25.02	126.5	28.61
	39	64.3	13.83	76.8	16.66	89.1	19.71	95.2	21.49	101.3	23.10	113.6	26.65	126.5	30.90
	41	62.6	14.96	74.9	18.04	86.8	21.55	92.8	23.27	98.7	25.02	110.7	29.21	123.2	33.55
	43	61.1	16.26	73.0	19.62	84.7	23.45	90.5	25.34	96.3	27.24	107.9	31.85	120.2	36.60
46	57.2	18.21	68.4	22.01	79.3	26.31	84.8	28.45	90.2	30.59	101.1	35.84	112.6	41.21	
48	50.6	15.87	60.5	19.19	70.2	22.95	75.0	24.84	79.8	26.69	89.5	31.32	99.6	36.02	

**Note**

1. TC: Total Capacity(kW), PI : Power Input(kW, Comp. + Outdoor fan motor)
2. Capacity tables show the average value of conditions which may occur.

# 7. Capacity Tables

◆ ARUM700LTE5

Cooling Capacity (70HP)

Combination (%)	Outdoor air temp. (DB, °C)	Indoor air temp. (DB/WB, °C)													
		20		23		26		27		28		30		32	
		14	16	16	18	18	19	19	20	20	22	22	24	24	
		TC	PI	TC	PI	TC	PI	TC	PI	TC	PI	TC	PI	TC	PI
130	10	27.6	2.90	37.6	3.62	50.2	4.41	70.8	5.38	93.3	6.72	134.3	8.97	178.2	11.87
	12	27.6	2.93	37.6	3.66	50.2	4.46	70.8	5.44	93.3	6.80	134.3	9.06	178.2	12.00
	14	27.6	2.96	37.6	3.70	50.2	4.50	70.8	5.49	93.3	6.87	134.3	9.16	178.2	12.12
	16	27.6	2.99	37.6	3.74	50.2	4.55	70.8	5.55	93.3	6.94	134.3	9.25	178.2	12.25
	18	27.6	3.02	37.6	3.78	50.2	4.60	70.8	5.61	93.3	7.01	134.3	9.35	178.2	12.37
	20	27.6	3.06	37.6	3.82	50.2	4.64	70.8	5.66	93.3	7.08	134.3	9.44	178.2	12.50
	21	27.6	3.09	38.2	3.93	62.1	5.80	82.5	6.74	104.3	8.70	143.0	11.86	183.8	14.07
	23	47.9	5.48	66.8	7.20	86.3	8.21	107.8	9.13	126.3	13.09	160.8	16.93	195.3	19.94
	25	70.9	8.68	85.8	10.80	110.6	12.27	134.4	14.47	148.3	18.81	178.5	24.60	206.7	28.94
	27	92.5	13.83	109.7	16.34	134.8	18.54	159.7	22.17	170.3	28.14	196.2	35.48	218.1	39.97
	29	114.1	19.21	133.6	22.53	159.0	27.23	185.6	32.06	192.3	38.21	214.1	45.87	229.7	51.05
	31	138.5	25.10	160.6	30.96	186.9	37.57	209.0	43.85	214.3	50.01	226.1	62.83	241.6	63.72
	33	162.9	30.93	190.4	40.41	213.7	48.35	225.9	62.77	230.8	62.33	237.9	62.89	254.0	63.77
	35	194.1	41.79	222.5	50.65	229.6	61.46	233.6	61.77	237.4	62.14	243.8	62.69	250.9	62.94
	37	194.1	44.56	219.3	53.15	226.5	60.65	229.6	60.95	233.6	61.32	239.9	61.87	247.0	62.11
	39	194.1	47.45	215.5	55.95	222.5	59.83	226.5	60.14	229.6	60.50	236.7	61.04	243.8	61.28
41	189.2	50.34	206.5	58.75	213.5	59.02	216.7	59.32	220.9	59.68	227.6	60.21	233.7	60.45	
43	184.5	53.09	197.9	57.92	204.8	58.21	207.9	58.50	212.1	58.85	218.6	59.38	224.5	59.62	
46	172.9	56.82	180.5	56.71	187.1	56.99	190.0	57.28	194.0	57.62	200.1	58.14	205.6	58.37	
48	152.9	55.24	156.8	55.40	162.6	55.52	165.2	55.67	168.8	56.15	174.2	56.51	179.0	56.73	
120	10	25.5	2.72	34.7	3.39	46.3	4.13	65.3	5.03	86.1	6.29	123.9	8.39	164.4	11.11
	12	25.5	2.74	34.7	3.43	46.3	4.17	65.3	5.09	86.1	6.36	123.9	8.48	164.4	11.22
	14	25.5	2.77	34.7	3.46	46.3	4.21	65.3	5.14	86.1	6.42	123.9	8.57	164.4	11.34
	16	25.5	2.80	34.7	3.50	46.3	4.26	65.3	5.19	86.1	6.49	123.9	8.65	164.4	11.46
	18	25.5	2.83	34.7	3.53	46.3	4.30	65.3	5.24	86.1	6.56	123.9	8.74	164.4	11.58
	20	25.5	2.86	34.7	3.57	46.3	4.34	65.3	5.30	86.1	6.62	123.9	8.83	164.4	11.69
	21	25.5	2.89	35.3	3.68	58.6	5.53	76.1	6.31	97.3	8.13	132.7	11.10	170.3	13.16
	23	44.1	5.12	63.4	6.85	83.3	7.87	99.3	8.54	120.4	12.25	150.8	15.84	182.1	18.65
	25	68.8	8.12	88.9	10.27	109.1	11.48	123.8	13.54	144.3	17.60	170.2	23.01	193.9	27.07
	27	95.6	12.84	120.9	15.28	135.3	17.21	147.1	20.57	168.3	26.11	189.5	32.92	205.7	37.70
	29	122.7	17.83	145.5	20.58	161.3	25.27	171.0	29.75	192.2	35.46	208.8	42.56	217.6	47.86
	31	148.5	22.57	175.3	27.21	187.5	33.52	196.9	39.44	216.9	44.97	222.9	54.09	230.4	55.10
	33	172.2	27.82	206.8	35.51	219.1	43.14	222.1	50.04	226.0	58.87	232.1	59.54	239.4	60.02
	35	175.7	37.16	208.9	48.14	221.3	53.25	224.4	63.43	228.3	63.74	234.5	63.93	240.6	64.44
	37	175.7	39.98	208.9	50.80	218.1	56.77	221.3	62.09	224.4	62.40	230.6	62.59	236.8	63.09
	39	175.7	43.04	208.1	53.69	214.3	60.22	217.4	60.82	220.5	61.12	227.5	61.30	233.6	61.79
41	171.2	46.10	199.1	56.58	205.8	59.03	208.7	59.54	211.7	59.84	217.8	60.02	224.0	60.49	
43	166.9	49.20	190.7	55.77	197.3	57.70	200.2	58.26	203.1	58.56	209.1	58.73	215.1	59.20	
46	156.4	52.90	173.9	54.44	180.2	55.89	182.9	56.35	185.6	56.63	191.2	56.80	196.9	57.25	
48	138.4	51.82	151.0	53.47	156.6	54.80	159.0	55.13	161.4	55.31	166.4	55.53	171.4	55.75	
110	10	23.3	2.55	31.8	3.19	42.4	3.88	59.8	4.73	78.8	5.91	113.5	7.88	150.5	10.44
	12	23.3	2.58	31.8	3.22	42.4	3.92	59.8	4.78	78.8	5.97	113.5	7.97	150.5	10.55
	14	23.3	2.61	31.8	3.25	42.4	3.96	59.8	4.83	78.8	6.04	113.5	8.05	150.5	10.66
	16	23.3	2.63	31.8	3.29	42.4	4.00	59.8	4.88	78.8	6.10	113.5	8.13	150.5	10.77
	18	23.3	2.66	31.8	3.32	42.4	4.04	59.8	4.93	78.8	6.16	113.5	8.21	150.5	10.88
	20	23.3	2.69	31.8	3.35	42.4	4.08	59.8	4.98	78.8	6.22	113.5	8.30	150.5	10.99
	21	23.3	2.71	31.8	3.46	53.1	5.10	70.3	5.93	87.7	7.64	122.5	10.43	158.2	12.36
	23	41.7	4.81	53.1	6.44	74.4	7.22	91.7	8.02	111.1	11.51	139.2	14.88	172.0	17.53
	25	60.1	7.63	74.4	9.65	95.7	10.79	113.2	12.72	132.0	16.54	155.6	21.62	185.5	25.44
	27	78.4	12.06	95.7	14.36	117.0	16.17	134.5	19.33	153.9	24.54	173.3	30.94	200.5	35.42
	29	96.8	16.75	117.0	19.34	138.3	23.74	156.4	27.96	175.8	33.32	190.9	39.20	211.5	43.47
	31	117.4	21.21	141.0	25.57	162.7	31.50	178.3	37.06	197.7	42.26	208.6	45.32	219.3	48.79
	33	136.1	26.14	162.7	33.37	184.4	40.54	201.0	45.29	213.7	50.83	220.3	52.24	225.9	52.31
	35	157.4	32.93	187.6	42.36	209.6	48.30	215.6	51.74	218.7	54.93	223.9	55.43	230.0	55.71
	37	157.4	34.90	187.6	44.96	209.6	50.99	212.6	54.82	214.8	57.93	220.9	58.13	226.2	58.30
	39	157.4	37.62	187.6	47.78	205.8	53.80	208.8	58.64	211.8	60.80	217.1	60.90	223.2	60.96
41	153.3	40.35	182.8	50.60	196.9	56.73	200.0	63.43	202.6	63.43	208.6	63.93	213.7	64.44	
43	149.5	42.37	178.3	52.71	188.7	60.16	191.8	60.84	194.3	60.71	200.1	61.05	205.2	61.22	
46	140.1	41.36	167.1	50.89	172.2	57.10	175.2	57.10	177.5	57.59	182.9	57.91	187.7	58.06	
48	124.0	40.16	145.2	49.02	149.6	54.32	152.3	54.69	154.3	54.95	159.1	55.11	163.3	55.33	

# 7. Capacity Tables

Cooling Capacity (70HP)

Combination (%)	Outdoor air temp. (DB, °C)	Indoor air temp. (DB/WB, °C)													
		20		23		26		27		28		30		32	
		14		16		18		19		20		22		24	
		TC	PI	TC	PI	TC	PI	TC	PI	TC	PI	TC	PI	TC	PI
100	10	21.4	2.34	29.2	2.92	38.9	3.56	54.9	4.34	72.3	5.42	104.1	7.23	138.1	9.58
	12	21.4	2.37	29.2	2.95	38.9	3.59	54.9	4.38	72.3	5.48	104.1	7.31	138.1	9.68
	14	21.4	2.39	29.2	2.98	38.9	3.63	54.9	4.43	72.3	5.54	104.1	7.38	138.1	9.78
	16	21.4	2.41	29.2	3.02	38.9	3.67	54.9	4.48	72.3	5.59	104.1	7.46	138.1	9.88
	18	21.4	2.44	29.2	3.05	38.9	3.71	54.9	4.52	72.3	5.65	104.1	7.54	138.1	9.98
	20	21.4	2.46	29.2	3.08	38.9	3.74	54.9	4.57	72.3	5.71	104.1	7.61	138.1	10.08
	21	21.4	2.49	29.2	3.17	48.5	4.68	64.5	5.44	82.4	7.01	112.4	9.57	145.2	11.34
	23	37.1	4.42	51.1	5.90	67.7	6.62	84.9	7.36	102.9	10.56	128.9	13.65	159.3	16.08
	25	52.9	7.00	68.9	8.86	87.0	9.90	105.8	11.67	123.4	15.17	145.4	19.84	173.3	23.34
	27	68.8	11.07	86.7	13.17	106.3	14.83	125.7	17.73	143.8	22.51	161.9	28.38	187.4	32.50
	29	84.6	15.37	104.5	17.74	125.6	21.78	146.2	25.65	164.3	30.57	178.4	36.69	201.5	39.88
	31	100.4	19.46	122.3	23.46	144.9	28.90	166.6	34.00	184.7	38.77	194.9	42.43	217.2	45.21
	33	116.3	23.98	140.1	30.61	164.2	37.19	187.0	43.14	205.4	47.11	211.8	47.92	217.2	48.97
	35	132.3	28.88	157.5	36.88	183.4	45.83	196.0	50.74	205.4	51.04	211.8	51.24	217.2	51.65
	37	132.3	30.93	157.5	39.55	183.4	48.55	196.0	53.16	202.0	53.42	207.9	53.63	212.8	54.13
	39	132.3	33.16	157.5	42.49	183.4	51.44	196.0	55.75	198.7	56.00	204.5	56.21	209.3	56.73
	41	130.2	35.40	155.0	45.42	180.5	54.34	188.1	58.35	192.2	58.58	196.7	58.79	203.1	59.34
43	125.7	37.46	149.7	48.15	174.3	56.94	180.3	60.58	182.4	60.80	188.0	61.00	192.9	61.57	
46	117.8	40.29	140.3	51.91	163.3	60.39	164.6	63.43	166.4	63.61	171.8	63.80	176.4	64.40	
48	104.2	34.79	124.1	44.91	141.0	51.63	143.1	53.82	144.6	53.99	149.3	54.11	153.4	54.54	
90	10	19.2	2.15	26.2	2.69	35.0	3.38	48.4	3.86	65.1	4.99	93.7	6.58	124.3	8.62
	12	19.2	2.18	26.2	2.72	35.0	3.41	48.4	3.90	65.1	5.04	93.7	6.65	124.3	8.71
	14	19.2	2.20	26.2	2.75	35.0	3.45	48.4	3.94	65.1	5.09	93.7	6.72	124.3	8.80
	16	19.2	2.22	26.2	2.77	35.0	3.49	48.4	3.98	65.1	5.15	93.7	6.79	124.3	8.89
	18	19.2	2.24	26.2	2.80	35.0	3.52	48.4	4.02	65.1	5.20	93.7	6.86	124.3	8.98
	20	19.2	2.27	26.2	2.83	35.0	3.56	48.4	4.06	65.1	5.25	93.7	6.93	124.3	9.07
	21	19.2	2.29	26.2	2.86	43.9	4.48	57.3	4.82	73.4	6.30	101.3	7.62	130.8	9.98
	23	26.1	3.54	38.6	4.91	61.3	6.35	74.3	6.92	89.7	9.26	116.4	11.29	144.1	13.73
	25	41.6	5.99	55.9	7.88	78.6	9.40	91.3	10.94	106.1	13.50	131.5	17.06	157.4	19.84
	27	57.0	8.80	73.1	11.22	96.0	14.60	108.3	16.26	122.4	19.69	146.6	22.97	170.7	25.96
	29	72.4	11.89	90.4	15.41	113.4	20.34	125.4	22.48	138.8	25.99	161.8	29.49	184.0	34.36
	31	87.9	14.87	107.6	19.80	130.7	25.46	142.4	28.69	155.1	32.38	176.9	34.33	197.3	39.93
	33	103.3	19.15	124.9	24.36	148.1	30.86	159.4	34.02	171.5	37.64	192.0	40.68	210.6	44.60
	35	119.0	23.71	142.1	29.98	165.2	37.07	176.4	40.88	187.6	44.45	207.1	47.69	210.6	48.78
	37	119.0	25.17	142.1	31.89	165.2	39.52	176.4	43.43	187.6	46.92	203.7	49.85	207.3	50.97
	39	119.0	26.65	142.1	33.92	165.2	41.83	176.4	46.22	187.6	49.34	200.4	52.55	203.9	53.19
	41	116.0	29.81	138.5	37.61	161.0	45.91	171.9	50.54	182.8	53.27	192.0	55.39	195.5	56.65
43	113.1	32.18	135.0	40.64	157.0	50.15	167.6	54.43	178.3	57.12	184.1	59.17	187.5	60.03	
46	106.0	36.22	126.6	46.28	147.1	57.14	157.1	61.71	162.0	63.46	168.1	63.80	171.2	64.40	
48	93.8	31.66	112.0	40.48	130.1	50.00	139.0	53.82	140.7	53.99	146.1	54.11	148.9	54.54	
80	10	16.5	1.90	22.5	2.38	29.9	2.99	42.3	3.44	55.7	4.41	80.2	5.82	106.3	7.62
	12	16.5	1.92	22.5	2.40	29.9	3.02	42.3	3.47	55.7	4.46	80.2	5.88	106.3	7.70
	14	16.5	1.94	22.5	2.43	29.9	3.05	42.3	3.51	55.7	4.50	80.2	5.94	106.3	7.78
	16	16.5	1.96	22.5	2.45	29.9	3.08	42.3	3.54	55.7	4.55	80.2	6.00	106.3	7.86
	18	16.5	1.98	22.5	2.48	29.9	3.11	42.3	3.58	55.7	4.60	80.2	6.06	106.3	7.94
	20	16.5	2.00	22.5	2.50	29.9	3.14	42.3	3.62	55.7	4.64	80.2	6.12	106.3	8.02
	21	16.5	2.01	22.5	2.57	37.6	3.96	50.4	4.33	63.1	5.57	87.2	6.74	113.1	8.82
	23	29.2	3.72	37.3	4.42	53.1	5.62	66.7	6.23	78.0	8.19	101.5	9.98	126.3	12.13
	25	41.9	5.39	52.0	7.09	68.6	8.31	83.0	9.84	92.9	11.94	115.8	15.08	139.6	17.54
	27	54.7	7.92	66.8	10.10	84.0	12.90	99.4	14.64	107.8	17.41	130.1	20.30	152.8	22.95
	29	67.4	10.27	81.6	13.87	99.5	17.98	115.7	20.23	122.7	22.98	144.4	26.07	166.1	30.38
	31	80.2	12.58	96.4	17.46	115.0	22.51	132.0	25.82	140.3	27.85	158.7	30.04	179.3	34.95
	33	92.9	16.55	111.2	21.49	130.5	26.46	148.4	30.62	157.1	32.00	173.0	35.60	192.6	39.34
	35	105.7	21.66	126.0	27.14	146.3	33.30	156.8	36.57	167.3	40.04	187.6	45.43	205.7	47.32
	37	105.7	22.91	126.0	28.86	146.3	35.32	156.8	38.88	167.3	42.54	187.6	47.94	202.4	49.70
	39	105.7	24.21	126.0	30.51	146.3	37.79	156.8	41.80	167.3	45.72	187.6	50.65	199.0	52.43
	41	103.0	26.78	122.8	33.81	142.6	41.47	152.8	45.82	163.0	50.24	182.8	54.28	190.7	55.52
43	100.4	29.48	119.7	36.90	139.0	45.27	149.0	49.94	159.0	54.90	178.3	57.98	182.8	59.43	
46	94.1	32.80	112.2	41.56	130.3	51.01	139.6	55.58	149.0	61.95	163.0	63.80	166.9	64.40	
48	83.3	28.64	99.3	36.34	115.3	44.61	123.5	48.55	131.8	53.99	141.6	54.11	145.0	54.54	

# 7. Capacity Tables

Cooling Capacity (70HP)

Combination (%)	Outdoor air temp. (DB, °C)	Indoor air temp. (DB/WB, °C)													
		20		23		26		27		28		30		32	
		14		16		18		19		20		22		24	
		TC	PI	TC	PI	TC	PI	TC	PI	TC	PI	TC	PI	TC	PI
70	10	14.3	1.68	19.5	2.10	26.1	2.64	36.8	3.06	48.5	3.90	69.8	5.14	92.5	6.73
	12	14.3	1.70	19.5	2.12	26.1	2.67	36.8	3.09	48.5	3.94	69.8	5.20	92.5	6.81
	14	14.3	1.72	19.5	2.15	26.1	2.70	36.8	3.12	48.5	3.98	69.8	5.25	92.5	6.88
	16	14.3	1.74	19.5	2.17	26.1	2.72	36.8	3.15	48.5	4.02	69.8	5.31	92.5	6.95
	18	14.3	1.75	19.5	2.19	26.1	2.75	36.8	3.19	48.5	4.06	69.8	5.36	92.5	7.02
	20	14.3	1.77	19.5	2.21	26.1	2.78	36.8	3.22	48.5	4.10	69.8	5.41	92.5	7.09
	21	14.3	1.78	22.8	2.60	33.8	3.64	45.5	4.04	56.0	4.92	76.9	5.95	99.6	7.80
	23	20.5	2.68	35.3	4.25	47.3	5.34	61.3	5.79	71.1	7.24	91.4	8.82	113.4	10.73
	25	32.5	4.42	47.8	6.27	60.7	7.35	77.0	9.16	86.1	10.55	105.8	13.33	127.2	15.50
	27	44.5	6.44	60.3	8.93	74.2	10.84	92.8	13.61	101.2	15.39	120.3	17.95	141.0	20.29
	29	56.5	8.17	72.8	11.79	87.6	14.74	108.5	18.51	116.2	20.31	134.8	23.04	154.8	26.85
	31	68.5	10.05	85.3	14.67	101.1	18.46	124.3	23.26	131.3	24.62	149.2	26.56	168.6	30.89
	33	80.5	13.51	97.8	17.83	114.5	21.43	137.2	27.01	146.3	28.29	163.8	31.47	182.0	34.78
	35	92.4	18.50	110.6	23.06	128.1	27.90	137.2	30.51	146.3	33.32	163.8	39.23	182.0	43.01
	37	92.4	19.66	110.6	24.42	128.1	29.64	137.2	32.45	146.3	35.45	163.8	41.75	182.0	45.39
	39	92.4	20.88	110.6	26.04	128.1	31.69	137.2	34.91	146.3	38.30	163.8	44.68	182.0	48.94
	41	90.0	23.09	107.8	28.52	124.8	34.76	133.7	38.29	142.6	41.63	159.6	49.07	177.3	52.75
	43	87.8	25.13	105.1	31.09	121.7	37.93	130.4	41.76	139.0	45.46	155.7	53.61	173.0	57.05
46	82.3	27.92	98.5	34.96	114.1	42.72	122.2	46.51	130.3	51.25	145.9	60.47	162.1	63.62	
48	72.8	24.37	87.1	30.53	100.9	37.35	108.1	40.65	115.3	44.83	129.0	52.91	143.4	54.54	
60	10	12.6	1.43	16.9	1.78	22.6	2.24	31.8	2.61	42.0	3.31	60.4	4.36	80.1	5.71
	12	12.6	1.44	16.9	1.80	22.6	2.26	31.8	2.64	42.0	3.34	60.4	4.41	80.1	5.77
	14	12.6	1.46	16.9	1.82	22.6	2.29	31.8	2.67	42.0	3.38	60.4	4.45	80.1	5.83
	16	12.6	1.47	16.9	1.84	22.6	2.31	31.8	2.69	42.0	3.41	60.4	4.50	80.1	5.89
	18	12.6	1.49	16.9	1.86	22.6	2.33	31.8	2.72	42.0	3.45	60.4	4.55	80.1	5.95
	20	12.6	1.50	16.9	1.88	22.6	2.36	31.8	2.75	42.0	3.48	60.4	4.59	80.1	6.01
	21	12.6	1.51	16.9	1.94	28.2	3.02	37.4	3.33	48.1	4.18	65.6	5.05	85.2	6.61
	23	12.6	1.67	28.0	3.52	39.9	4.53	51.8	4.84	60.6	6.14	76.3	7.48	95.3	9.10
	25	23.5	3.18	39.1	5.32	51.5	6.23	66.7	8.26	73.1	8.95	88.7	11.08	105.4	13.15
	27	34.6	4.64	50.2	7.57	63.2	9.19	80.5	11.49	85.6	12.85	99.6	14.68	115.6	16.93
	29	45.7	6.02	61.3	9.70	74.8	12.25	95.0	15.10	98.1	16.37	110.6	18.41	125.7	21.64
	31	56.8	7.65	72.4	11.60	86.4	14.92	106.6	18.12	110.6	19.02	123.9	20.38	135.8	24.94
	33	67.9	10.65	83.5	14.11	98.1	16.75	115.0	20.31	123.2	21.76	133.7	24.15	145.9	28.41
	35	79.1	15.69	94.5	19.20	109.9	23.00	117.6	25.05	125.3	27.20	140.7	31.78	156.1	36.65
	37	79.1	16.57	94.5	20.27	109.9	24.37	117.6	26.61	125.3	28.85	140.7	33.73	156.1	38.99
	39	79.1	17.62	94.5	21.58	109.9	26.30	117.6	28.55	125.3	31.05	140.7	36.16	156.1	41.78
	41	77.1	19.11	92.1	23.61	107.1	28.56	114.6	31.19	122.1	33.70	137.1	39.69	152.1	45.40
	43	75.2	20.77	89.8	25.71	104.4	31.14	111.8	33.99	119.1	36.75	133.7	43.32	148.3	49.59
46	70.4	23.26	84.2	28.87	97.9	35.02	104.7	38.21	111.6	41.36	125.3	48.82	139.0	56.50	
48	62.3	20.27	74.4	25.19	86.6	30.60	92.6	33.37	98.7	36.14	110.8	42.69	123.0	49.44	
50	10	11.3	1.21	15.5	1.51	21.8	1.90	29.1	2.33	38.3	2.80	55.2	3.70	73.2	4.82
	12	11.3	1.22	15.5	1.53	21.8	1.92	29.1	2.36	38.3	2.83	55.2	3.74	73.2	4.87
	14	11.3	1.24	15.5	1.54	21.8	1.94	29.1	2.38	38.3	2.86	55.2	3.78	73.2	4.92
	16	11.3	1.25	15.5	1.56	21.8	1.96	29.1	2.40	38.3	2.89	55.2	3.82	73.2	4.98
	18	11.3	1.26	15.5	1.58	21.8	1.98	29.1	2.43	38.3	2.92	55.2	3.86	73.2	5.03
	20	11.3	1.27	15.5	1.59	21.8	2.00	29.1	2.45	38.3	2.95	55.2	3.89	73.2	5.08
	21	11.3	1.28	15.5	1.65	27.1	2.57	34.3	2.94	43.6	3.54	59.9	4.28	77.2	5.58
	23	11.3	1.36	24.5	2.81	37.6	3.84	48.4	4.59	55.2	5.21	69.0	6.35	85.2	7.68
	25	20.3	2.49	33.6	4.13	48.0	5.38	64.1	7.45	67.8	7.59	78.1	8.93	93.2	10.85
	27	29.5	3.56	42.7	5.81	59.5	7.50	74.3	9.92	78.9	10.23	87.2	11.69	101.2	13.81
	29	38.6	4.68	51.8	7.49	69.0	9.64	83.6	12.31	89.9	13.20	96.3	14.49	109.2	17.44
	31	47.7	5.95	60.9	8.91	78.4	11.74	90.9	13.73	96.2	14.60	105.2	15.65	117.1	19.19
	33	56.9	8.28	70.0	10.72	87.9	13.18	94.5	15.05	100.3	16.13	113.8	18.54	125.0	21.54
	35	66.2	13.05	79.1	15.69	91.7	18.54	98.0	20.11	104.3	21.68	116.9	25.01	130.2	28.74
	37	66.2	13.83	79.1	16.58	91.7	19.62	98.0	21.29	104.3	22.95	116.9	26.68	130.2	30.51
	39	66.2	14.75	79.1	17.77	91.7	21.02	98.0	22.91	104.3	24.63	116.9	28.42	130.2	32.95
	41	64.5	15.95	77.1	19.24	89.4	22.98	95.5	24.82	101.6	26.68	113.9	31.15	126.9	35.78
	43	62.9	17.34	75.2	20.92	87.1	25.01	93.1	27.02	99.1	29.05	111.1	33.97	123.7	39.03
46	58.9	19.42	70.4	23.47	81.7	28.05	87.3	30.34	92.9	32.62	104.1	38.22	116.0	43.94	
48	52.1	16.92	62.3	20.47	72.2	24.47	77.2	26.48	82.2	28.46	92.1	33.40	102.6	38.41	

**Note**

1. TC: Total Capacity(kW), PI : Power Input(kW, Comp. + Outdoor fan motor)
2. Capacity tables show the average value of conditions which may occur.

# 7. Capacity Tables

## ◆ ARUM720LTE5

Cooling Capacity (72HP)

Combination (%)	Outdoor air temp. (DB, °C)	Indoor air temp. (DB/WB, °C)													
		20		23		26		27		28		30		32	
		14	PI	16	PI	18	PI	19	PI	20	PI	22	PI	24	PI
130	10	28.4	2.99	38.7	3.73	51.6	4.54	72.8	5.54	96.0	6.92	138.2	9.23	183.3	12.22
	12	28.4	3.02	38.7	3.77	51.6	4.59	72.8	5.60	96.0	6.99	138.2	9.33	183.3	12.35
	14	28.4	3.05	38.7	3.81	51.6	4.64	72.8	5.65	96.0	7.07	138.2	9.43	183.3	12.48
	16	28.4	3.08	38.7	3.85	51.6	4.68	72.8	5.71	96.0	7.14	138.2	9.52	183.3	12.61
	18	28.4	3.11	38.7	3.89	51.6	4.73	72.8	5.77	96.0	7.21	138.2	9.62	183.3	12.74
	20	28.4	3.15	38.7	3.93	51.6	4.78	72.8	5.83	96.0	7.29	138.2	9.72	183.3	12.87
	21	28.4	3.18	39.3	4.05	63.9	5.97	84.9	6.94	107.3	8.95	147.1	12.21	189.1	14.48
	23	49.3	5.64	68.7	7.42	88.8	8.45	110.9	9.40	129.9	13.47	165.4	17.42	200.8	20.52
	25	72.9	8.94	88.3	11.12	113.7	12.63	138.3	14.90	152.6	19.36	183.6	25.32	212.6	29.79
	27	95.1	14.24	112.9	16.82	138.6	19.08	164.2	22.82	175.2	28.96	201.8	36.52	224.4	41.15
	29	117.4	19.77	137.4	23.20	163.6	28.03	190.9	33.00	197.8	39.34	220.2	47.21	236.2	52.55
	31	142.4	25.83	165.2	31.87	192.2	38.67	215.0	45.14	220.4	51.48	232.6	64.67	248.5	65.59
	33	167.6	31.84	195.8	41.59	219.9	49.77	232.3	64.61	237.4	64.16	244.7	64.73	261.3	65.64
	35	199.7	43.01	228.8	52.14	236.1	63.26	240.2	63.58	244.1	63.96	250.8	64.53	258.1	64.79
	37	199.7	45.87	225.6	54.71	232.9	62.43	236.1	62.74	240.2	63.12	246.8	63.68	254.1	63.93
	39	199.7	48.84	221.6	57.59	228.8	61.59	232.9	61.90	236.1	62.27	243.5	62.83	250.8	63.08
41	194.6	51.81	212.4	60.47	219.6	60.76	222.9	61.06	227.2	61.43	234.1	61.98	240.4	62.22	
43	189.8	54.65	203.6	59.62	210.6	59.92	213.8	60.22	218.1	60.58	224.8	61.12	230.9	61.37	
46	177.8	58.49	185.7	58.37	192.4	58.67	195.4	58.96	199.5	59.32	205.8	59.85	211.5	60.08	
48	157.3	56.86	161.3	57.03	167.3	57.15	170.0	57.31	173.6	57.80	179.1	58.17	184.1	58.40	
120	10	26.2	2.80	35.7	3.49	47.6	4.25	67.2	5.18	88.5	6.48	127.5	8.64	169.0	11.43
	12	26.2	2.82	35.7	3.53	47.6	4.29	67.2	5.23	88.5	6.54	127.5	8.73	169.0	11.55
	14	26.2	2.85	35.7	3.56	47.6	4.34	67.2	5.29	88.5	6.61	127.5	8.82	169.0	11.67
	16	26.2	2.88	35.7	3.60	47.6	4.38	67.2	5.34	88.5	6.68	127.5	8.91	169.0	11.79
	18	26.2	2.91	35.7	3.64	47.6	4.43	67.2	5.40	88.5	6.75	127.5	9.00	169.0	11.92
	20	26.2	2.94	35.7	3.67	47.6	4.47	67.2	5.45	88.5	6.82	127.5	9.09	169.0	12.04
	21	26.2	2.97	36.3	3.79	60.3	5.70	78.2	6.49	100.1	8.37	136.5	11.43	175.2	13.54
	23	45.4	5.27	65.2	7.05	85.7	8.10	102.2	8.79	123.8	12.61	155.2	16.30	187.3	19.20
	25	70.8	8.36	91.4	10.58	112.2	11.82	127.4	13.93	148.5	18.12	175.0	23.69	199.4	27.87
	27	98.3	13.22	124.3	15.73	139.2	17.71	151.3	21.18	173.1	26.88	194.9	33.89	211.6	38.81
	29	126.2	18.35	149.7	21.19	165.9	26.01	175.9	30.63	197.7	36.50	214.7	43.81	223.8	49.26
	31	152.8	23.23	180.3	28.01	192.9	34.50	202.5	40.59	223.1	46.30	229.2	55.68	237.0	56.72
	33	177.1	28.63	212.7	36.55	225.3	44.41	228.5	51.51	232.4	60.60	238.8	61.29	246.2	61.78
	35	180.7	38.26	214.8	49.55	227.6	54.81	230.8	65.29	234.8	65.61	241.2	65.81	247.5	66.33
	37	180.7	41.15	214.8	52.29	224.4	58.44	227.6	63.91	230.8	64.23	237.2	64.43	243.6	64.94
	39	180.7	44.30	214.1	55.27	220.5	61.98	223.6	62.60	226.8	62.91	234.0	63.10	240.3	63.60
41	176.1	47.45	204.7	58.24	211.6	60.76	214.6	61.29	217.8	61.60	224.1	61.78	230.4	62.27	
43	171.7	50.64	196.2	57.41	203.0	59.40	205.9	59.98	208.9	60.28	215.1	60.46	221.3	60.94	
46	160.9	54.46	178.9	56.04	185.3	57.53	188.1	58.01	190.9	58.30	196.7	58.47	202.5	58.93	
48	142.4	53.35	155.3	55.04	161.1	56.41	163.5	56.75	166.0	56.94	171.2	57.16	176.3	57.39	
110	10	24.0	2.63	32.7	3.28	43.6	3.99	61.5	4.87	81.1	6.08	116.7	8.11	154.8	10.74
	12	24.0	2.65	32.7	3.31	43.6	4.03	61.5	4.92	81.1	6.15	116.7	8.20	154.8	10.86
	14	24.0	2.68	32.7	3.35	43.6	4.07	61.5	4.97	81.1	6.21	116.7	8.29	154.8	10.97
	16	24.0	2.71	32.7	3.38	43.6	4.12	61.5	5.02	81.1	6.28	116.7	8.37	154.8	11.08
	18	24.0	2.74	32.7	3.42	43.6	4.16	61.5	5.07	81.1	6.34	116.7	8.46	154.8	11.20
	20	24.0	2.76	32.7	3.45	43.6	4.20	61.5	5.12	81.1	6.40	116.7	8.54	154.8	11.31
	21	24.0	2.79	32.7	3.56	54.6	5.25	72.3	6.10	90.2	7.87	126.0	10.74	162.8	12.73
	23	42.9	4.96	54.6	6.63	76.5	7.43	94.3	8.26	114.3	11.84	143.2	15.32	176.9	18.04
	25	61.8	7.86	76.5	9.94	98.4	11.11	116.5	13.09	135.8	17.02	160.1	22.26	190.8	26.19
	27	80.7	12.42	98.4	14.78	120.3	16.64	138.4	19.90	158.3	25.26	178.2	31.84	206.2	36.46
	29	99.5	17.24	120.3	19.91	142.2	24.44	160.9	28.78	180.8	34.30	196.4	40.35	217.6	44.75
	31	120.8	21.83	145.0	26.32	167.4	32.42	183.4	38.14	203.3	43.50	214.5	46.65	225.6	50.22
	33	140.0	26.91	167.4	34.35	189.7	41.73	206.8	46.62	219.8	52.33	226.6	53.77	232.4	53.84
	35	161.9	33.89	193.0	43.61	215.6	49.72	221.7	53.26	224.9	56.54	230.3	57.06	236.6	57.34
	37	161.9	35.92	193.0	46.28	215.6	52.49	218.6	56.43	221.0	59.63	227.2	59.84	232.7	60.01
	39	161.9	38.73	193.0	49.18	211.6	55.38	214.7	60.36	217.9	62.59	223.3	62.69	229.6	62.75
41	157.7	41.54	188.0	52.08	202.6	58.40	205.7	65.29	208.4	65.29	214.5	65.81	219.9	66.33	
43	153.8	43.61	183.4	54.26	194.1	61.93	197.3	62.63	199.9	62.49	205.8	62.85	211.0	63.02	
46	144.1	42.57	171.8	52.38	177.1	58.77	180.2	58.77	182.6	59.28	188.1	59.61	193.0	59.77	
48	127.5	41.34	149.4	50.46	153.9	55.92	156.7	56.29	158.7	56.57	163.6	56.72	168.0	56.95	

# 7. Capacity Tables

Cooling Capacity (72HP)

Combination (%)	Outdoor air temp. (DB, °C)	Indoor air temp. (DB/WB, °C)													
		20		23		26		27		28		30		32	
		14		16		18		19		20		22		24	
		TC	PI	TC	PI	TC	PI	TC	PI	TC	PI	TC	PI	TC	PI
100	10	22.0	2.41	30.0	3.01	40.0	3.66	56.4	4.47	74.4	5.58	107.1	7.44	142.1	9.86
	12	22.0	2.44	30.0	3.04	40.0	3.70	56.4	4.51	74.4	5.64	107.1	7.52	142.1	9.96
	14	22.0	2.46	30.0	3.07	40.0	3.74	56.4	4.56	74.4	5.70	107.1	7.60	142.1	10.06
	16	22.0	2.49	30.0	3.10	40.0	3.78	56.4	4.61	74.4	5.76	107.1	7.68	142.1	10.17
	18	22.0	2.51	30.0	3.14	40.0	3.82	56.4	4.65	74.4	5.82	107.1	7.76	142.1	10.27
	20	22.0	2.54	30.0	3.17	40.0	3.85	56.4	4.70	74.4	5.88	107.1	7.84	142.1	10.38
	21	22.0	2.56	30.0	3.26	49.8	4.81	66.3	5.60	84.8	7.22	115.6	9.85	149.3	11.68
	23	38.1	4.55	52.6	6.08	69.7	6.82	87.3	7.58	105.8	10.87	132.6	14.05	163.8	16.55
	25	54.4	7.21	70.9	9.12	89.5	10.19	108.9	12.01	126.9	15.62	149.6	20.42	178.3	24.03
	27	70.7	11.39	89.2	13.56	109.3	15.27	129.3	18.25	147.9	23.17	166.6	29.21	192.7	33.45
	29	87.0	15.82	107.5	18.26	129.2	22.42	150.3	26.40	169.0	31.47	183.5	37.77	207.2	41.05
	31	103.3	20.03	125.8	24.15	149.0	29.74	171.4	34.99	190.0	39.91	200.5	43.67	223.4	46.54
	33	119.6	24.68	144.1	31.51	168.9	38.28	192.3	44.40	211.3	48.49	217.8	49.33	223.4	50.41
	35	136.1	29.73	162.0	37.96	188.6	47.18	201.6	52.23	211.3	52.54	217.8	52.75	223.4	53.17
	37	136.1	31.84	162.0	40.71	188.6	49.97	201.6	54.72	207.8	54.99	213.8	55.21	218.9	55.72
	39	136.1	34.14	162.0	43.74	188.6	52.95	201.6	57.39	204.3	57.65	210.4	57.86	215.3	58.40
	41	133.9	36.43	159.4	46.76	185.7	55.94	193.4	60.06	197.7	60.30	202.3	60.52	208.9	61.08
43	129.3	38.56	154.0	49.57	179.3	58.61	185.5	62.36	187.6	62.58	193.4	62.79	198.5	63.38	
46	121.2	41.48	144.3	53.44	168.0	62.17	169.3	65.29	171.2	65.48	176.7	65.67	181.4	66.29	
48	107.2	35.81	127.6	46.23	145.0	53.15	147.2	55.40	148.7	55.58	153.6	55.70	157.8	56.15	
90	10	19.8	2.22	27.0	2.77	36.0	3.48	49.8	3.97	67.0	5.14	96.4	6.77	127.9	8.87
	12	19.8	2.24	27.0	2.80	36.0	3.51	49.8	4.02	67.0	5.19	96.4	6.85	127.9	8.96
	14	19.8	2.26	27.0	2.83	36.0	3.55	49.8	4.06	67.0	5.24	96.4	6.92	127.9	9.06
	16	19.8	2.29	27.0	2.86	36.0	3.59	49.8	4.10	67.0	5.30	96.4	6.99	127.9	9.15
	18	19.8	2.31	27.0	2.88	36.0	3.62	49.8	4.14	67.0	5.35	96.4	7.06	127.9	9.24
	20	19.8	2.33	27.0	2.91	36.0	3.66	49.8	4.18	67.0	5.41	96.4	7.13	127.9	9.34
	21	19.8	2.36	27.0	2.94	45.2	4.61	58.9	4.96	75.5	6.49	104.1	7.84	134.5	10.27
	23	26.9	3.65	39.7	5.06	63.0	6.54	76.4	7.13	92.3	9.53	119.7	11.62	148.2	14.13
	25	42.7	6.16	57.5	8.11	80.9	9.68	93.9	11.26	109.1	13.90	135.3	17.56	161.9	20.42
	27	58.6	9.06	75.2	11.55	98.7	15.03	111.4	16.74	125.9	20.27	150.8	23.64	175.6	26.72
	29	74.5	12.23	92.9	15.87	116.6	20.93	128.9	23.14	142.7	26.76	166.4	30.35	189.2	35.37
	31	90.4	15.31	110.7	20.38	134.5	26.21	146.4	29.53	159.5	33.33	182.0	35.34	202.9	41.11
	33	106.3	19.71	128.4	25.08	152.3	31.76	163.9	35.02	176.4	38.75	197.5	41.87	216.6	45.91
	35	122.4	24.41	146.2	30.86	169.9	38.16	181.4	42.08	193.0	45.76	213.0	49.09	216.6	50.21
	37	122.4	25.91	146.2	32.83	169.9	40.69	181.4	44.71	193.0	48.30	209.6	51.31	213.2	52.46
	39	122.4	27.43	146.2	34.91	169.9	43.06	181.4	47.57	193.0	50.79	206.1	54.10	209.8	54.75
	41	119.3	30.69	142.4	38.71	165.6	47.26	176.8	52.03	188.0	54.83	197.5	57.01	201.1	58.32
43	116.3	33.13	138.9	41.83	161.5	51.63	172.4	56.03	183.4	58.79	189.4	60.91	192.8	61.79	
46	109.0	37.29	130.2	47.64	151.3	58.82	161.6	63.53	166.6	65.32	172.9	65.67	176.1	66.29	
48	96.4	32.59	115.1	41.67	133.9	51.47	142.9	55.40	144.7	55.58	150.2	55.70	153.1	56.15	
80	10	16.9	1.96	23.1	2.45	30.8	3.07	43.5	3.54	57.3	4.54	82.5	5.99	109.4	7.84
	12	16.9	1.98	23.1	2.47	30.8	3.11	43.5	3.57	57.3	4.59	82.5	6.05	109.4	7.92
	14	16.9	2.00	23.1	2.50	30.8	3.14	43.5	3.61	57.3	4.64	82.5	6.11	109.4	8.01
	16	16.9	2.02	23.1	2.52	30.8	3.17	43.5	3.65	57.3	4.68	82.5	6.18	109.4	8.09
	18	16.9	2.04	23.1	2.55	30.8	3.20	43.5	3.69	57.3	4.73	82.5	6.24	109.4	8.17
	20	16.9	2.06	23.1	2.58	30.8	3.24	43.5	3.72	57.3	4.78	82.5	6.30	109.4	8.25
	21	16.9	2.07	23.1	2.65	38.7	4.08	51.9	4.46	64.9	5.73	89.7	6.93	116.3	9.08
	23	30.0	3.83	38.3	4.55	54.6	5.78	68.6	6.41	80.2	8.43	104.4	10.27	129.9	12.49
	25	43.1	5.55	53.5	7.30	70.5	8.56	85.4	10.13	95.6	12.29	119.1	15.53	143.5	18.05
	27	56.2	8.15	68.7	10.40	86.4	13.28	102.2	15.07	110.9	17.92	133.8	20.90	157.2	23.62
	29	69.4	10.57	83.9	14.28	102.4	18.51	119.0	20.83	126.2	23.65	148.5	26.83	170.8	31.27
	31	82.5	12.95	99.1	17.97	118.3	23.17	135.7	26.58	144.4	28.67	163.3	30.92	184.4	35.97
	33	95.6	17.03	114.3	22.12	134.2	27.24	152.6	31.52	161.6	32.94	178.0	36.65	198.1	40.50
	35	108.7	22.29	129.6	27.94	150.5	34.28	161.3	37.65	172.1	41.22	193.0	46.76	211.6	48.71
	37	108.7	23.58	129.6	29.70	150.5	36.36	161.3	40.03	172.1	43.79	193.0	49.35	208.2	51.16
	39	108.7	24.92	129.6	31.41	150.5	38.90	161.3	43.03	172.1	47.06	193.0	52.14	204.7	53.97
	41	105.9	27.57	126.3	34.80	146.6	42.69	157.2	47.17	167.7	51.71	188.0	55.87	196.1	57.15
43	103.3	30.35	123.2	37.98	143.0	46.60	153.3	51.41	163.5	56.51	183.4	59.69	188.0	61.17	
46	96.8	33.76	115.4	42.78	134.0	52.50	143.6	57.21	153.3	63.77	167.7	65.67	171.6	66.29	
48	85.7	29.49	102.1	37.40	118.6	45.92	127.1	49.98	135.6	55.58	145.6	55.70	149.1	56.15	

# 7. Capacity Tables

Cooling Capacity (72HP)

Combination (%)	Outdoor air temp. (DB, °C)	Indoor air temp. (DB/WB, °C)													
		20		23		26		27		28		30		32	
		14		16		18		19		20		22		24	
		TC	PI	TC	PI	TC	PI	TC	PI	TC	PI	TC	PI	TC	PI
70	10	14.7	1.73	20.1	2.16	26.8	2.72	37.8	3.15	49.8	4.01	71.8	5.29	95.2	6.93
	12	14.7	1.75	20.1	2.19	26.8	2.75	37.8	3.18	49.8	4.06	71.8	5.35	95.2	7.01
	14	14.7	1.77	20.1	2.21	26.8	2.78	37.8	3.21	49.8	4.10	71.8	5.41	95.2	7.08
	16	14.7	1.79	20.1	2.23	26.8	2.80	37.8	3.25	49.8	4.14	71.8	5.46	95.2	7.15
	18	14.7	1.81	20.1	2.25	26.8	2.83	37.8	3.28	49.8	4.18	71.8	5.52	95.2	7.22
	20	14.7	1.82	20.1	2.28	26.8	2.86	37.8	3.31	49.8	4.22	71.8	5.57	95.2	7.30
	21	14.7	1.83	23.4	2.67	34.8	3.75	46.8	4.16	57.6	5.07	79.1	6.13	102.4	8.03
	23	21.1	2.76	36.3	4.37	48.6	5.49	63.0	5.96	73.1	7.45	94.0	9.08	116.6	11.04
	25	33.5	4.55	49.2	6.46	62.5	7.56	79.2	9.42	88.6	10.86	108.9	13.72	130.8	15.96
	27	45.8	6.63	62.0	9.19	76.3	11.16	95.4	14.01	104.0	15.84	123.7	18.47	145.0	20.88
	29	58.1	8.41	74.9	12.14	90.1	15.17	111.6	19.06	119.5	20.91	138.6	23.72	159.2	27.64
	31	70.5	10.34	87.7	15.10	103.9	19.00	127.8	23.94	135.0	25.34	153.5	27.34	173.4	31.80
	33	82.8	13.91	100.6	18.36	117.8	22.06	141.1	27.80	150.5	29.12	168.5	32.40	187.2	35.80
	35	95.0	19.04	113.8	23.74	131.8	28.72	141.1	31.41	150.5	34.30	168.5	40.38	187.2	44.27
	37	95.0	20.24	113.8	25.14	131.8	30.51	141.1	33.40	150.5	36.49	168.5	42.97	187.2	46.73
	39	95.0	21.49	113.8	26.80	131.8	32.62	141.1	35.94	150.5	39.42	168.5	45.99	187.2	50.37
41	92.6	23.76	110.8	29.36	128.4	35.79	137.5	39.42	146.6	42.85	164.2	50.52	182.4	54.29	
43	90.3	25.87	108.1	32.00	125.2	39.05	134.1	42.98	143.0	46.80	160.1	55.18	177.9	58.72	
46	84.6	28.74	101.3	35.98	117.3	43.97	125.7	47.88	134.0	52.75	150.0	62.24	166.7	65.49	
48	74.9	25.09	89.6	31.43	103.8	38.44	111.2	41.84	118.6	46.15	132.7	54.47	147.5	56.15	
60	10	13.0	1.45	17.4	1.82	23.2	2.28	32.7	2.66	43.2	3.37	62.1	4.45	82.4	5.82
	12	13.0	1.47	17.4	1.84	23.2	2.31	32.7	2.69	43.2	3.41	62.1	4.49	82.4	5.88
	14	13.0	1.49	17.4	1.85	23.2	2.33	32.7	2.72	43.2	3.44	62.1	4.54	82.4	5.94
	16	13.0	1.50	17.4	1.87	23.2	2.35	32.7	2.75	43.2	3.48	62.1	4.59	82.4	6.01
	18	13.0	1.52	17.4	1.89	23.2	2.38	32.7	2.77	43.2	3.51	62.1	4.63	82.4	6.07
	20	13.0	1.53	17.4	1.91	23.2	2.40	32.7	2.80	43.2	3.55	62.1	4.68	82.4	6.13
	21	13.0	1.54	17.4	1.98	29.0	3.08	38.5	3.40	49.5	4.26	67.5	5.15	87.7	6.74
	23	13.0	1.70	28.8	3.59	41.0	4.61	53.3	4.93	62.3	6.26	78.5	7.63	98.1	9.27
	25	24.2	3.24	40.2	5.42	53.0	6.35	68.6	8.42	75.2	9.12	91.3	11.30	108.5	13.40
	27	35.6	4.73	51.6	7.72	65.0	9.37	82.8	11.71	88.1	13.09	102.5	14.96	118.9	17.26
	29	47.0	6.13	63.0	9.89	76.9	12.49	97.7	15.39	100.9	16.69	113.7	18.77	129.3	22.06
	31	58.4	7.80	74.5	11.82	88.9	15.21	109.7	18.47	113.8	19.38	127.4	20.78	139.7	25.42
	33	69.8	10.86	85.9	14.38	100.9	17.08	118.3	20.70	126.8	22.18	137.5	24.62	150.1	28.95
	35	81.4	16.15	97.2	19.77	113.0	23.68	121.0	25.79	128.9	27.99	144.7	32.71	160.6	37.73
	37	81.4	17.06	97.2	20.86	113.0	25.08	121.0	27.39	128.9	29.70	144.7	34.72	160.6	40.14
	39	81.4	18.14	97.2	22.21	113.0	27.08	121.0	29.39	128.9	31.96	144.7	37.23	160.6	43.01
41	79.3	19.68	94.7	24.31	110.1	29.40	117.9	32.10	125.6	34.69	141.0	40.85	156.5	46.74	
43	77.3	21.38	92.4	26.46	107.4	32.05	115.0	34.98	122.5	37.83	137.5	44.60	152.6	51.05	
46	72.5	23.94	86.6	29.71	100.7	36.05	107.7	39.33	114.8	42.57	128.9	50.25	143.0	58.16	
48	64.1	20.86	76.6	25.93	89.1	31.50	95.3	34.35	101.5	37.20	114.0	43.95	126.5	50.89	
50	10	11.7	1.22	15.9	1.53	22.4	1.92	29.9	2.35	39.4	2.83	56.8	3.73	75.3	4.87
	12	11.7	1.23	15.9	1.54	22.4	1.94	29.9	2.38	39.4	2.86	56.8	3.77	75.3	4.92
	14	11.7	1.25	15.9	1.56	22.4	1.96	29.9	2.40	39.4	2.89	56.8	3.81	75.3	4.97
	16	11.7	1.26	15.9	1.57	22.4	1.98	29.9	2.43	39.4	2.92	56.8	3.85	75.3	5.02
	18	11.7	1.27	15.9	1.59	22.4	2.00	29.9	2.45	39.4	2.95	56.8	3.89	75.3	5.07
	20	11.7	1.29	15.9	1.61	22.4	2.02	29.9	2.48	39.4	2.98	56.8	3.93	75.3	5.12
	21	11.7	1.29	15.9	1.66	27.9	2.59	35.3	2.97	44.8	3.58	61.6	4.32	79.4	5.64
	23	11.7	1.37	25.2	2.83	38.6	3.87	49.8	4.64	56.8	5.25	71.0	6.40	87.6	7.75
	25	20.9	2.51	34.6	4.17	49.4	5.43	65.9	7.52	69.8	7.66	80.3	9.01	95.8	10.95
	27	30.3	3.59	43.9	5.87	61.2	7.57	76.4	10.01	81.1	10.32	89.7	11.80	104.0	13.94
	29	39.7	4.72	53.3	7.56	70.9	9.73	86.0	12.43	92.5	13.31	99.0	14.62	112.3	17.60
	31	49.1	6.00	62.6	8.99	80.7	11.85	93.5	13.86	99.0	14.73	108.2	15.79	120.5	19.37
	33	58.5	8.36	72.0	10.82	90.4	13.30	97.2	15.19	103.1	16.27	117.1	18.71	128.6	21.73
	35	68.0	13.43	81.4	16.16	94.3	19.08	100.8	20.70	107.3	22.31	120.2	25.75	133.9	29.58
	37	68.0	14.24	81.4	17.06	94.3	20.19	100.8	21.91	107.3	23.63	120.2	27.46	133.9	31.40
	39	68.0	15.19	81.4	18.29	94.3	21.64	100.8	23.58	107.3	25.35	120.2	29.25	133.9	33.92
41	66.3	16.42	79.3	19.80	91.9	23.66	98.2	25.54	104.5	27.47	117.2	32.07	130.5	36.83	
43	64.7	17.85	77.3	21.54	89.6	25.74	95.8	27.81	101.9	29.90	114.3	34.97	127.3	40.18	
46	60.6	19.99	72.5	24.16	84.0	28.88	89.8	31.23	95.5	33.57	107.1	39.34	119.3	45.23	
48	53.6	17.42	64.1	21.07	74.3	25.19	79.4	27.26	84.5	29.30	94.7	34.38	105.5	39.54	

**Note**

1. TC: Total Capacity(kW), PI : Power Input(kW, Comp. + Outdoor fan motor)
2. Capacity tables show the average value of conditions which may occur.

# 7. Capacity Tables

◆ ARUM740LTE5

Cooling Capacity (74HP)

Combination (%)	Outdoor air temp. (DB, °C)	Indoor air temp. (DB/WB, °C)													
		20		23		26		27		28		30		32	
		14	16	16	18	19	20	22	24						
130	10	29.2	2.93	39.8	3.66	53.0	4.45	74.8	5.43	98.6	6.79	142.0	9.05	188.3	11.98
	12	29.2	2.96	39.8	3.70	53.0	4.50	74.8	5.49	98.6	6.86	142.0	9.14	188.3	12.11
	14	29.2	2.99	39.8	3.73	53.0	4.54	74.8	5.54	98.6	6.93	142.0	9.24	188.3	12.23
	16	29.2	3.02	39.8	3.77	53.0	4.59	74.8	5.60	98.6	7.00	142.0	9.33	188.3	12.36
	18	29.2	3.05	39.8	3.81	53.0	4.64	74.8	5.66	98.6	7.07	142.0	9.43	188.3	12.49
	20	29.2	3.08	39.8	3.85	53.0	4.68	74.8	5.71	98.6	7.14	142.0	9.53	188.3	12.61
	21	29.2	3.11	40.4	3.97	65.7	5.85	87.2	6.80	110.3	8.77	151.2	11.97	194.3	14.19
	23	50.7	5.53	70.6	7.27	91.3	8.28	114.0	9.21	133.5	13.21	169.9	17.08	206.4	20.12
	25	74.9	8.76	90.8	10.90	116.9	12.39	142.1	14.60	156.8	18.98	188.7	24.82	218.5	29.20
	27	97.8	13.96	116.0	16.48	142.5	18.71	168.8	22.37	180.0	28.39	207.4	35.80	230.6	40.34
	29	120.7	19.38	141.2	22.74	168.1	27.47	196.2	32.35	203.3	38.56	226.4	46.28	242.8	51.51
	31	146.4	25.33	169.8	31.24	197.6	37.91	221.0	44.25	226.6	50.47	239.1	63.39	255.4	64.29
	33	172.2	31.21	201.3	40.77	226.0	48.79	238.8	63.34	244.0	62.89	251.5	63.46	268.6	64.35
	35	205.2	42.16	235.2	51.11	242.7	62.02	246.9	62.33	250.9	62.70	257.7	63.26	265.3	63.51
	37	205.2	44.96	231.9	53.63	239.4	61.20	242.7	61.50	246.9	61.87	253.6	62.43	261.1	62.67
	39	205.2	47.88	227.8	56.46	235.2	60.38	239.4	60.68	242.7	61.04	250.2	61.59	257.7	61.83
	41	200.0	50.79	218.3	59.28	225.7	59.56	229.1	59.86	233.5	60.22	240.6	60.76	247.1	60.99
	43	195.0	53.57	209.2	58.44	216.5	58.74	219.8	59.03	224.2	59.39	231.1	59.92	237.4	60.16
46	182.8	57.34	190.9	57.22	197.8	57.51	200.9	57.80	205.0	58.15	211.5	58.67	217.3	58.90	
48	161.7	55.74	165.8	55.91	171.9	56.03	174.7	56.18	178.4	56.66	184.1	57.02	189.3	57.25	
120	10	26.9	2.74	36.7	3.42	48.9	4.16	69.0	5.08	91.0	6.35	131.0	8.47	173.7	11.21
	12	26.9	2.77	36.7	3.46	48.9	4.21	69.0	5.13	91.0	6.41	131.0	8.55	173.7	11.33
	14	26.9	2.80	36.7	3.49	48.9	4.25	69.0	5.18	91.0	6.48	131.0	8.64	173.7	11.44
	16	26.9	2.83	36.7	3.53	48.9	4.29	69.0	5.24	91.0	6.55	131.0	8.73	173.7	11.56
	18	26.9	2.86	36.7	3.57	48.9	4.34	69.0	5.29	91.0	6.61	131.0	8.82	173.7	11.68
	20	26.9	2.88	36.7	3.60	48.9	4.38	69.0	5.35	91.0	6.68	131.0	8.91	173.7	11.80
	21	26.9	2.91	37.3	3.71	62.0	5.58	80.4	6.37	102.8	8.21	140.2	11.20	180.0	13.28
	23	46.7	5.17	67.0	6.91	88.1	7.94	105.0	8.62	127.3	12.36	159.5	15.98	192.5	18.82
	25	72.7	8.20	94.0	10.37	115.3	11.59	130.9	13.66	152.6	17.76	179.9	23.22	205.0	27.32
	27	101.0	12.95	127.8	15.42	143.1	17.36	155.5	20.76	177.9	26.35	200.3	33.22	217.5	38.04
	29	129.7	17.99	153.9	20.77	170.5	25.49	180.8	30.02	203.2	35.78	220.7	42.95	230.0	48.29
	31	157.0	22.77	185.3	27.46	198.3	33.82	208.1	39.79	229.3	45.38	235.6	54.58	243.6	55.60
	33	182.0	28.07	218.6	35.83	231.6	43.53	234.8	50.49	238.9	59.40	245.4	60.08	253.1	60.56
	35	185.7	37.50	220.8	48.58	233.9	53.73	237.2	64.00	241.3	64.32	247.9	64.51	254.3	65.02
	37	185.7	40.34	220.8	51.26	230.6	57.29	233.9	62.65	237.2	62.97	243.8	63.16	250.3	63.66
	39	185.7	43.43	220.0	54.18	226.6	60.76	229.8	61.37	233.1	61.67	240.5	61.86	247.0	62.35
	41	181.0	46.51	210.4	57.09	217.5	59.56	220.6	60.08	223.8	60.38	230.3	60.56	236.8	61.04
	43	176.5	49.65	201.6	56.28	208.6	58.23	211.6	58.79	214.7	59.09	221.1	59.26	227.4	59.73
46	165.4	53.38	183.8	54.93	190.5	56.40	193.3	56.86	196.2	57.15	202.2	57.32	208.2	57.77	
48	146.3	52.29	159.6	53.96	165.6	55.30	168.1	55.63	170.7	55.81	175.9	56.04	181.2	56.26	
110	10	24.6	2.57	33.6	3.21	44.8	3.91	63.2	4.77	83.3	5.96	120.0	7.95	159.1	10.53
	12	24.6	2.60	33.6	3.25	44.8	3.95	63.2	4.82	83.3	6.03	120.0	8.04	159.1	10.64
	14	24.6	2.63	33.6	3.28	44.8	3.99	63.2	4.87	83.3	6.09	120.0	8.12	159.1	10.75
	16	24.6	2.66	33.6	3.32	44.8	4.04	63.2	4.92	83.3	6.15	120.0	8.21	159.1	10.86
	18	24.6	2.68	33.6	3.35	44.8	4.08	63.2	4.97	83.3	6.22	120.0	8.29	159.1	10.98
	20	24.6	2.71	33.6	3.38	44.8	4.12	63.2	5.02	83.3	6.28	120.0	8.37	159.1	11.09
	21	24.6	2.74	33.6	3.49	56.2	5.14	74.3	5.98	92.7	7.71	129.5	10.52	167.3	12.48
	23	44.1	4.86	56.1	6.49	78.7	7.28	96.9	8.10	117.5	11.61	147.2	15.01	181.8	17.68
	25	63.5	7.70	78.6	9.74	101.2	10.89	119.7	12.84	139.5	16.69	164.5	21.82	196.1	25.67
	27	82.9	12.17	101.1	14.49	123.7	16.31	142.2	19.51	162.7	24.76	183.2	31.22	212.0	35.75
	29	102.3	16.90	123.6	19.52	146.2	23.96	165.3	28.21	185.8	33.62	201.8	39.55	223.6	43.86
	31	124.1	21.40	149.1	25.80	172.0	31.78	188.4	37.39	209.0	42.64	220.5	45.73	231.9	49.23
	33	143.9	26.38	172.0	33.67	195.0	40.91	212.5	45.71	225.9	51.29	232.9	52.71	238.9	52.78
	35	166.4	33.23	198.3	42.75	221.5	48.74	227.9	52.21	231.1	55.42	236.7	55.94	243.1	56.21
	37	166.4	35.21	198.3	45.37	221.5	51.45	224.7	55.32	227.1	58.46	233.5	58.66	239.1	58.82
	39	166.4	37.97	198.3	48.21	217.5	54.29	220.7	59.17	223.9	61.35	229.5	61.46	235.9	61.52
	41	162.1	40.72	193.2	51.05	208.2	57.25	211.5	64.00	214.2	64.00	220.5	64.51	226.0	65.02
	43	158.1	42.75	188.5	53.19	199.5	60.71	202.8	61.39	205.4	61.26	211.5	61.61	216.9	61.78
46	148.2	41.73	176.6	51.35	182.1	57.61	185.2	57.61	187.6	58.11	193.4	58.43	198.4	58.59	
48	131.1	40.53	153.5	49.47	158.1	54.82	161.0	55.18	163.1	55.45	168.2	55.61	172.6	55.83	



# 7. Capacity Tables

Cooling Capacity (74HP)

Combination (%)	Outdoor air temp. (DB, °C)	Indoor air temp. (DB/WB, °C)													
		20		23		26		27		28		30		32	
		14		16		18		19		20		22		24	
		TC	PI	TC	PI	TC	PI	TC	PI	TC	PI	TC	PI	TC	PI
100	10	22.6	2.36	30.8	2.95	41.1	3.59	58.0	4.38	76.5	5.47	110.1	7.30	146.0	9.66
	12	22.6	2.39	30.8	2.98	41.1	3.63	58.0	4.42	76.5	5.53	110.1	7.37	146.0	9.76
	14	22.6	2.41	30.8	3.01	41.1	3.66	58.0	4.47	76.5	5.59	110.1	7.45	146.0	9.87
	16	22.6	2.44	30.8	3.04	41.1	3.70	58.0	4.52	76.5	5.64	110.1	7.53	146.0	9.97
	18	22.6	2.46	30.8	3.07	41.1	3.74	58.0	4.56	76.5	5.70	110.1	7.60	146.0	10.07
	20	22.6	2.49	30.8	3.10	41.1	3.78	58.0	4.61	76.5	5.76	110.1	7.68	146.0	10.17
	21	22.6	2.51	30.8	3.20	51.2	4.72	68.1	5.49	87.1	7.08	118.8	9.66	153.5	11.45
	23	39.2	4.46	54.0	5.96	71.6	6.68	89.7	7.43	108.8	10.65	136.3	13.77	168.4	16.22
	25	55.9	7.07	72.8	8.94	92.0	9.99	111.9	11.78	130.4	15.31	153.7	20.02	183.2	23.55
	27	72.7	11.17	91.6	13.29	112.4	14.97	132.9	17.89	152.0	22.71	171.2	28.64	198.1	32.79
	29	89.4	15.51	110.5	17.90	132.8	21.98	154.5	25.88	173.7	30.85	188.6	37.03	213.0	40.24
	31	106.2	19.63	129.3	23.67	153.2	29.16	176.1	34.30	195.3	39.12	206.1	42.81	229.6	45.62
	33	122.9	24.20	148.1	30.89	173.6	37.53	197.7	43.53	217.1	47.53	223.9	48.36	229.6	49.41
	35	139.9	29.15	166.5	37.21	193.9	46.25	207.2	51.20	217.1	51.51	223.9	51.71	229.6	52.12
	37	139.9	31.21	166.5	39.91	193.9	48.99	207.2	53.64	213.6	53.90	219.7	54.12	225.0	54.62
	39	139.9	33.47	166.5	42.87	193.9	51.91	207.2	56.26	210.0	56.51	216.2	56.72	221.3	57.25
41	137.6	35.72	163.9	45.83	190.8	54.83	198.8	58.88	203.2	59.12	208.0	59.32	214.7	59.88	
43	132.9	37.80	158.2	48.59	184.2	57.45	190.6	61.13	192.8	61.35	198.8	61.55	204.0	62.13	
46	124.6	40.66	148.3	52.38	172.7	60.94	174.0	64.00	175.9	64.19	181.6	64.38	186.4	64.98	
48	110.2	35.11	131.2	45.32	149.1	52.10	151.3	54.30	152.8	54.48	157.9	54.60	162.2	55.04	
90	10	20.3	2.17	27.7	2.71	37.0	3.41	51.2	3.90	68.8	5.03	99.1	6.64	131.4	8.70
	12	20.3	2.20	27.7	2.74	37.0	3.45	51.2	3.94	68.8	5.09	99.1	6.71	131.4	8.79
	14	20.3	2.22	27.7	2.77	37.0	3.48	51.2	3.98	68.8	5.14	99.1	6.78	131.4	8.88
	16	20.3	2.24	27.7	2.80	37.0	3.52	51.2	4.02	68.8	5.19	99.1	6.85	131.4	8.97
	18	20.3	2.26	27.7	2.83	37.0	3.55	51.2	4.06	68.8	5.25	99.1	6.92	131.4	9.06
	20	20.3	2.29	27.7	2.86	37.0	3.59	51.2	4.10	68.8	5.30	99.1	6.99	131.4	9.15
	21	20.3	2.31	27.7	2.88	46.4	4.52	60.6	4.86	77.6	6.36	107.0	7.69	138.3	10.07
	23	27.6	3.57	40.8	4.96	64.8	6.41	78.6	6.98	94.9	9.35	123.0	11.39	152.3	13.85
	25	43.9	6.04	59.1	7.95	83.1	9.49	96.6	11.04	112.1	13.62	139.0	17.22	166.4	20.02
	27	60.3	8.88	77.3	11.32	101.5	14.73	114.5	16.41	129.4	19.87	155.0	23.17	180.4	26.19
	29	76.6	11.99	95.5	15.55	119.8	20.52	132.5	22.69	146.7	26.23	171.0	29.75	194.5	34.68
	31	92.9	15.01	113.8	19.97	138.2	25.69	150.5	28.95	164.0	32.68	187.0	34.64	208.5	40.30
	33	109.2	19.33	132.0	24.58	156.6	31.14	168.5	34.33	181.3	37.98	203.0	41.05	222.6	45.01
	35	125.8	23.93	150.2	30.25	174.6	37.40	186.5	41.25	198.3	44.85	218.9	48.12	222.6	49.22
	37	125.8	25.39	150.2	32.18	174.6	39.88	186.5	43.83	198.3	47.35	215.4	50.30	219.1	51.43
	39	125.8	26.89	150.2	34.23	174.6	42.21	186.5	46.64	198.3	49.79	211.9	53.03	215.6	53.67
41	122.6	30.09	146.4	37.95	170.2	46.33	181.7	51.00	193.2	53.75	203.0	55.89	206.6	57.17	
43	119.5	32.48	142.8	41.00	166.0	50.61	177.2	54.93	188.5	57.64	194.6	59.70	198.2	60.57	
46	112.0	36.55	133.8	46.70	155.5	57.66	166.1	62.27	171.2	64.03	177.7	64.38	181.0	64.98	
48	99.1	31.95	118.3	40.85	137.6	50.45	146.9	54.30	148.7	54.48	154.4	54.60	157.4	55.04	
80	10	17.4	1.92	23.7	2.40	31.7	3.01	44.7	3.47	58.9	4.45	84.8	5.87	112.4	7.69
	12	17.4	1.94	23.7	2.42	31.7	3.05	44.7	3.50	58.9	4.50	84.8	5.93	112.4	7.77
	14	17.4	1.96	23.7	2.45	31.7	3.08	44.7	3.54	58.9	4.54	84.8	5.99	112.4	7.85
	16	17.4	1.98	23.7	2.47	31.7	3.11	44.7	3.58	58.9	4.59	84.8	6.06	112.4	7.93
	18	17.4	2.00	23.7	2.50	31.7	3.14	44.7	3.61	58.9	4.64	84.8	6.12	112.4	8.01
	20	17.4	2.02	23.7	2.52	31.7	3.17	44.7	3.65	58.9	4.68	84.8	6.18	112.4	8.09
	21	17.4	2.03	23.7	2.60	39.7	4.00	53.3	4.37	66.7	5.62	92.2	6.80	119.5	8.90
	23	30.9	3.75	39.4	4.46	56.1	5.67	70.6	6.29	82.5	8.26	107.3	10.07	133.5	12.24
	25	44.3	5.44	55.0	7.16	72.5	8.39	87.8	9.93	98.2	12.04	122.4	15.22	147.5	17.70
	27	57.8	7.99	70.6	10.19	88.8	13.02	105.0	14.77	114.0	17.57	137.5	20.49	161.5	23.16
	29	71.3	10.36	86.3	14.00	105.2	18.14	122.3	20.42	129.7	23.19	152.7	26.30	175.5	30.65
	31	84.7	12.70	101.9	17.62	121.6	22.71	139.5	26.05	148.4	28.10	167.8	30.31	189.5	35.26
	33	98.2	16.70	117.5	21.68	138.0	26.70	156.9	30.90	166.0	32.29	182.9	35.92	203.6	39.70
	35	111.7	21.85	133.2	27.39	154.7	33.60	165.8	36.91	176.9	40.40	198.3	45.84	217.5	47.75
	37	111.7	23.12	133.2	29.12	154.7	35.64	165.8	39.24	176.9	42.93	198.3	48.38	213.9	50.15
	39	111.7	24.43	133.2	30.79	154.7	38.13	165.8	42.18	176.9	46.13	198.3	51.11	210.4	52.91
41	108.9	27.02	129.8	34.11	150.7	41.85	161.5	46.24	172.3	50.69	193.2	54.77	201.6	56.02	
43	106.2	29.75	126.6	37.23	147.0	45.68	157.5	50.39	168.1	55.39	188.5	58.51	193.3	59.96	
46	99.5	33.10	118.6	41.93	137.7	51.47	147.6	56.09	157.5	62.51	172.4	64.38	176.4	64.98	
48	88.0	28.90	104.9	36.67	121.8	45.01	130.6	48.99	139.3	54.48	149.7	54.60	153.3	55.04	

# 7. Capacity Tables

Cooling Capacity (74HP)

Combination (%)	Outdoor air temp. (DB, °C)	Indoor air temp. (DB/WB, °C)													
		20		23		26		27		28		30		32	
		14		16		18		19		20		22		24	
		TC	PI	TC	PI	TC	PI	TC	PI	TC	PI	TC	PI	TC	PI
70	10	15.1	1.70	20.7	2.12	27.5	2.66	38.9	3.09	51.2	3.93	73.8	5.19	97.8	6.80
	12	15.1	1.72	20.7	2.14	27.5	2.69	38.9	3.12	51.2	3.98	73.8	5.24	97.8	6.87
	14	15.1	1.73	20.7	2.17	27.5	2.72	38.9	3.15	51.2	4.02	73.8	5.30	97.8	6.94
	16	15.1	1.75	20.7	2.19	27.5	2.75	38.9	3.18	51.2	4.06	73.8	5.35	97.8	7.01
	18	15.1	1.77	20.7	2.21	27.5	2.78	38.9	3.22	51.2	4.10	73.8	5.41	97.8	7.08
	20	15.1	1.79	20.7	2.23	27.5	2.80	38.9	3.25	51.2	4.14	73.8	5.46	97.8	7.15
	21	15.1	1.80	24.1	2.62	35.8	3.68	48.1	4.08	59.2	4.97	81.3	6.01	105.3	7.87
	23	21.7	2.70	37.3	4.28	50.0	5.38	64.8	5.85	75.1	7.30	96.6	8.90	119.9	10.82
	25	34.4	4.46	50.5	6.33	64.2	7.42	81.4	9.24	91.0	10.65	111.9	13.45	134.5	15.64
	27	47.1	6.50	63.7	9.01	78.4	10.94	98.1	13.73	106.9	15.53	127.2	18.11	149.0	20.47
	29	59.8	8.24	77.0	11.90	92.6	14.88	114.7	18.68	122.8	20.50	142.5	23.25	163.6	27.10
	31	72.4	10.14	90.2	14.80	106.8	18.62	131.4	23.47	138.8	24.84	157.8	26.80	178.2	31.17
	33	85.1	13.64	103.4	18.00	121.0	21.63	145.0	27.25	154.7	28.54	173.2	31.76	192.4	35.09
	35	97.7	18.67	116.9	23.27	135.4	28.15	145.0	30.79	154.7	33.62	173.2	39.59	192.4	43.40
	37	97.7	19.84	116.9	24.64	135.4	29.91	145.0	32.74	154.7	35.77	173.2	42.13	192.4	45.81
	39	97.7	21.07	116.9	26.27	135.4	31.98	145.0	35.23	154.7	38.64	173.2	45.08	192.4	49.38
41	95.2	23.29	113.9	28.78	132.0	35.08	141.3	38.64	150.7	42.01	168.7	49.52	187.5	53.22	
43	92.8	25.36	111.1	31.37	128.7	38.28	137.8	42.13	147.0	45.87	164.6	54.10	182.8	57.57	
46	87.0	28.18	104.1	35.27	120.6	43.10	129.2	46.93	137.7	51.71	154.2	61.01	171.3	64.20	
48	77.0	24.59	92.1	30.81	106.7	37.68	114.3	41.01	121.8	45.24	136.4	53.39	151.6	55.04	
60	10	13.3	1.46	17.9	1.82	23.8	2.29	33.6	2.67	44.3	3.38	63.8	4.45	84.7	5.83
	12	13.3	1.47	17.9	1.84	23.8	2.31	33.6	2.70	44.3	3.41	63.8	4.50	84.7	5.89
	14	13.3	1.49	17.9	1.86	23.8	2.34	33.6	2.72	44.3	3.45	63.8	4.55	84.7	5.96
	16	13.3	1.50	17.9	1.88	23.8	2.36	33.6	2.75	44.3	3.48	63.8	4.60	84.7	6.02
	18	13.3	1.52	17.9	1.90	23.8	2.38	33.6	2.78	44.3	3.52	63.8	4.64	84.7	6.08
	20	13.3	1.53	17.9	1.92	23.8	2.41	33.6	2.81	44.3	3.55	63.8	4.69	84.7	6.14
	21	13.3	1.54	17.9	1.99	29.8	3.09	39.5	3.40	50.8	4.27	69.3	5.16	90.1	6.75
	23	13.3	1.71	29.6	3.60	42.1	4.62	54.7	4.94	64.1	6.27	80.6	7.64	100.8	9.29
	25	24.8	3.25	41.3	5.43	54.5	6.37	70.5	8.43	77.3	9.14	93.8	11.32	111.5	13.43
	27	36.6	4.74	53.1	7.73	66.8	9.39	85.1	11.74	90.5	13.12	105.3	14.99	122.2	17.29
	29	48.3	6.15	64.8	9.91	79.1	12.51	100.4	15.42	103.7	16.72	116.9	18.81	132.9	22.10
	31	60.0	7.82	76.5	11.85	91.4	15.24	112.7	18.50	116.9	19.42	130.9	20.82	143.5	25.47
	33	71.7	10.88	88.2	14.41	103.7	17.11	121.6	20.75	130.3	22.23	141.3	24.67	154.2	29.01
	35	83.6	15.84	99.9	19.38	116.2	23.21	124.3	25.28	132.5	27.44	148.7	32.07	165.0	36.98
	37	83.6	16.72	99.9	20.45	116.2	24.59	124.3	26.85	132.5	29.11	148.7	34.03	165.0	39.34
	39	83.6	17.78	99.9	21.77	116.2	26.54	124.3	28.81	132.5	31.33	148.7	36.49	165.0	42.16
41	81.5	19.29	97.3	23.83	113.2	28.82	121.1	31.47	129.1	34.01	144.9	40.05	160.8	45.81	
43	79.5	20.96	94.9	25.94	110.4	31.42	118.1	34.29	125.9	37.09	141.3	43.72	156.8	50.04	
46	74.5	23.47	89.0	29.13	103.5	35.34	110.7	38.55	118.0	41.73	132.5	49.26	147.0	57.01	
48	65.9	20.45	78.7	25.42	91.5	30.88	97.9	33.67	104.4	36.47	117.2	43.08	130.0	49.88	
50	10	12.0	1.25	16.3	1.56	23.0	1.97	30.7	2.41	40.5	2.90	58.3	3.83	77.4	4.99
	12	12.0	1.27	16.3	1.58	23.0	1.99	30.7	2.44	40.5	2.93	58.3	3.87	77.4	5.04
	14	12.0	1.28	16.3	1.60	23.0	2.01	30.7	2.46	40.5	2.96	58.3	3.91	77.4	5.10
	16	12.0	1.29	16.3	1.61	23.0	2.03	30.7	2.49	40.5	2.99	58.3	3.95	77.4	5.15
	18	12.0	1.31	16.3	1.63	23.0	2.05	30.7	2.51	40.5	3.02	58.3	3.99	77.4	5.20
	20	12.0	1.32	16.3	1.65	23.0	2.07	30.7	2.54	40.5	3.05	58.3	4.03	77.4	5.25
	21	12.0	1.33	16.3	1.71	28.6	2.65	36.2	3.04	46.1	3.67	63.3	4.43	81.6	5.78
	23	12.0	1.41	25.9	2.90	39.7	3.97	51.2	4.75	58.3	5.39	72.9	6.57	90.0	7.95
	25	21.5	2.57	35.5	4.28	50.8	5.57	67.8	7.71	71.7	7.85	82.5	9.24	98.5	11.23
	27	31.2	3.68	45.1	6.01	62.9	7.76	78.5	10.27	83.4	10.59	92.2	12.10	106.9	14.29
	29	40.8	4.84	54.8	7.75	72.9	9.98	88.4	12.74	95.0	13.65	101.8	14.99	115.4	18.05
	31	50.5	6.15	64.4	9.21	82.9	12.15	96.1	14.21	101.7	15.10	111.2	16.19	123.8	19.86
	33	60.1	8.57	74.0	11.09	92.9	13.64	99.9	15.57	106.0	16.68	120.3	19.19	132.1	22.28
	35	69.9	13.16	83.6	15.84	96.9	18.71	103.6	20.29	110.3	21.87	123.6	25.24	137.6	29.00
	37	69.9	13.96	83.6	16.73	96.9	19.80	103.6	21.48	110.3	23.16	123.6	26.92	137.6	30.78
	39	69.9	14.89	83.6	17.93	96.9	21.21	103.6	23.12	110.3	24.85	123.6	28.68	137.6	33.25
41	68.1	16.10	81.5	19.41	94.5	23.19	100.9	25.04	107.4	26.93	120.4	31.43	134.1	36.11	
43	66.5	17.49	79.5	21.11	92.1	25.23	98.5	27.27	104.8	29.31	117.4	34.28	130.8	39.39	
46	62.3	19.59	74.5	23.68	86.3	28.31	92.3	30.62	98.2	32.91	110.1	38.57	122.6	44.34	
48	55.1	17.08	65.9	20.65	76.4	24.69	81.6	26.73	86.9	28.72	97.4	33.70	108.4	38.76	

**Note**

1. TC: Total Capacity(kW), PI : Power Input(kW, Comp. + Outdoor fan motor)
2. Capacity tables show the average value of conditions which may occur.

# 7. Capacity Tables

◆ ARUM760LTE5

Cooling Capacity (76HP)

Combination (%)	Outdoor air temp. (DB, °C)	Indoor air temp. (DB/WB, °C)													
		20		23		26		27		28		30		32	
		14	16	18	19	20	22	24	TC	PI	TC	PI	TC	PI	
130	10	30.0	3.06	40.8	3.82	54.5	4.64	76.9	5.66	101.3	7.08	145.8	9.44	193.4	12.50
	12	30.0	3.09	40.8	3.86	54.5	4.69	76.9	5.72	101.3	7.16	145.8	9.54	193.4	12.63
	14	30.0	3.12	40.8	3.90	54.5	4.74	76.9	5.78	101.3	7.23	145.8	9.64	193.4	12.77
	16	30.0	3.15	40.8	3.94	54.5	4.79	76.9	5.84	101.3	7.30	145.8	9.74	193.4	12.90
	18	30.0	3.19	40.8	3.98	54.5	4.84	76.9	5.90	101.3	7.38	145.8	9.84	193.4	13.03
	20	30.0	3.22	40.8	4.02	54.5	4.89	76.9	5.96	101.3	7.45	145.8	9.94	193.4	13.16
	21	30.0	3.25	41.5	4.14	67.4	6.11	89.6	7.10	113.3	9.16	155.3	12.49	199.6	14.81
	23	52.1	5.77	72.5	7.59	93.7	8.65	117.0	9.61	137.1	13.78	174.5	17.82	212.0	20.99
	25	76.9	9.14	93.2	11.38	120.0	12.93	145.9	15.24	161.0	19.81	193.8	25.91	224.4	30.48
	27	100.4	14.57	119.1	17.20	146.3	19.52	173.4	23.34	184.9	29.63	213.0	37.36	236.8	42.09
	29	123.9	20.23	145.0	23.73	172.6	28.67	201.5	33.76	208.8	40.24	232.5	48.30	249.4	53.75
	31	150.4	26.43	174.4	32.60	202.9	39.56	226.9	46.18	232.7	52.67	245.5	66.16	262.3	67.09
	33	176.9	32.57	206.7	42.55	232.1	50.91	245.3	66.10	250.6	65.63	258.3	66.22	275.8	67.15
	35	210.8	44.00	241.5	53.33	249.3	64.72	253.6	65.04	257.7	65.43	264.7	66.02	272.4	66.28
	37	210.8	46.92	238.1	55.97	245.9	63.86	249.3	64.18	253.6	64.57	260.5	65.15	268.2	65.40
	39	210.8	49.96	233.9	58.91	241.5	63.01	245.9	63.32	249.3	63.70	257.0	64.27	264.7	64.53
41	205.4	53.01	224.2	61.86	231.8	62.15	235.3	62.46	239.8	62.84	247.1	63.40	253.8	63.65	
43	200.3	55.90	214.9	60.99	222.3	61.30	225.7	61.61	230.2	61.97	237.3	62.53	243.8	62.78	
46	187.7	59.84	196.0	59.71	203.1	60.02	206.3	60.32	210.6	60.68	217.2	61.22	223.2	61.46	
48	166.1	58.17	170.2	58.34	176.6	58.47	179.4	58.63	183.2	59.13	189.1	59.51	194.4	59.74	
120	10	27.6	2.86	37.7	3.57	50.2	4.34	70.9	5.30	93.5	6.62	134.5	8.83	178.4	11.70
	12	27.6	2.89	37.7	3.61	50.2	4.39	70.9	5.35	93.5	6.69	134.5	8.93	178.4	11.82
	14	27.6	2.92	37.7	3.65	50.2	4.44	70.9	5.41	93.5	6.76	134.5	9.02	178.4	11.94
	16	27.6	2.95	37.7	3.68	50.2	4.48	70.9	5.47	93.5	6.83	134.5	9.11	178.4	12.07
	18	27.6	2.98	37.7	3.72	50.2	4.53	70.9	5.52	93.5	6.90	134.5	9.21	178.4	12.19
	20	27.6	3.01	37.7	3.76	50.2	4.57	70.9	5.58	93.5	6.97	134.5	9.30	178.4	12.31
	21	27.6	3.04	38.3	3.87	63.6	5.83	82.6	6.64	105.6	8.57	144.0	11.69	184.9	13.86
	23	47.9	5.40	68.8	7.21	90.4	8.29	107.8	8.99	130.7	12.89	163.8	16.67	197.7	19.64
	25	74.7	8.55	96.5	10.82	118.4	12.09	134.4	14.26	156.7	18.53	184.7	24.23	210.5	28.51
	27	103.8	13.52	131.3	16.09	146.9	18.12	159.7	21.66	182.7	27.50	205.7	34.67	223.3	39.70
	29	133.2	18.77	158.0	21.67	175.2	26.60	185.7	31.33	208.7	37.34	226.7	44.82	236.2	50.39
	31	161.3	23.77	190.3	28.65	203.6	35.30	213.7	41.53	235.5	47.36	242.0	56.96	250.1	58.02
	33	186.9	29.29	224.5	37.39	237.9	45.43	241.2	52.69	245.3	61.99	252.0	62.70	259.9	63.20
	35	190.7	39.13	226.8	50.69	240.3	56.07	243.6	66.79	247.8	67.12	254.6	67.32	261.2	67.86
	37	190.7	42.09	226.8	53.49	236.8	59.78	240.3	65.38	243.6	65.71	250.3	65.91	257.1	66.43
	39	190.7	45.32	226.0	56.54	232.7	63.41	236.0	64.04	239.4	64.36	247.0	64.55	253.7	65.06
41	185.8	48.54	216.1	59.58	223.4	62.16	226.6	62.70	229.9	63.01	236.5	63.20	243.2	63.70	
43	181.2	51.81	207.1	58.73	214.2	60.76	217.3	61.35	220.5	61.66	227.0	61.84	233.6	62.34	
46	169.9	55.71	188.8	57.33	195.6	58.86	198.5	59.34	201.6	59.64	207.6	59.81	213.8	60.29	
48	150.3	54.57	163.9	56.31	170.0	57.71	172.6	58.06	175.3	58.24	180.7	58.48	186.1	58.71	
110	10	25.3	2.69	34.5	3.35	46.0	4.08	64.9	4.98	85.6	6.22	123.2	8.30	163.4	10.99
	12	25.3	2.72	34.5	3.39	46.0	4.13	64.9	5.03	85.6	6.29	123.2	8.39	163.4	11.11
	14	25.3	2.74	34.5	3.43	46.0	4.17	64.9	5.08	85.6	6.36	123.2	8.48	163.4	11.22
	16	25.3	2.77	34.5	3.46	46.0	4.21	64.9	5.14	85.6	6.42	123.2	8.56	163.4	11.34
	18	25.3	2.80	34.5	3.50	46.0	4.25	64.9	5.19	85.6	6.49	123.2	8.65	163.4	11.45
	20	25.3	2.83	34.5	3.53	46.0	4.30	64.9	5.24	85.6	6.55	123.2	8.74	163.4	11.57
	21	25.3	2.86	34.5	3.64	57.7	5.37	76.3	6.24	95.2	8.05	133.0	10.98	171.8	13.02
	23	45.3	5.07	57.6	6.78	80.8	7.60	99.5	8.45	120.7	12.12	151.2	15.67	186.7	18.46
	25	65.2	8.04	80.8	10.17	103.9	11.36	123.0	13.39	143.3	17.41	169.0	22.77	201.4	26.79
	27	85.1	12.70	103.9	15.12	127.0	17.02	146.1	20.35	167.1	25.84	188.1	32.58	217.7	37.30
	29	105.1	17.64	127.0	20.37	150.1	25.00	169.8	29.44	190.9	35.09	207.3	41.27	229.7	45.78
	31	127.5	22.33	153.1	26.92	176.7	33.17	193.5	39.02	214.6	44.50	226.5	47.72	238.1	51.38
	33	147.8	27.52	176.7	35.14	200.3	42.69	218.3	47.70	232.0	53.53	239.2	55.01	245.3	55.08
	35	170.8	34.67	203.7	44.61	227.5	50.86	234.0	54.49	237.4	57.84	243.1	58.37	249.7	58.66
	37	170.8	36.75	203.7	47.34	227.5	53.69	230.8	57.73	233.3	61.00	239.9	61.21	245.6	61.39
	39	170.8	39.62	203.7	50.31	223.4	56.65	226.6	61.75	230.0	64.03	235.7	64.13	242.3	64.20
41	166.5	42.49	198.5	53.28	213.8	59.74	217.2	66.79	220.0	66.79	226.4	67.32	232.1	67.86	
43	162.4	44.62	193.6	55.51	204.9	63.35	208.3	64.07	211.0	63.93	217.3	64.29	222.8	64.47	
46	152.2	43.55	181.4	53.59	187.0	60.12	190.2	60.12	192.7	60.64	198.6	60.98	203.7	61.14	
48	134.6	42.29	157.7	51.62	162.4	57.20	165.4	57.59	167.5	57.86	172.7	58.03	177.3	58.26	

# 7. Capacity Tables

Cooling Capacity (76HP)

Combination (%)	Outdoor air temp. (DB, °C)	Indoor air temp. (DB/WB, °C)													
		20		23		26		27		28		30		32	
		14		16		18		19		20		22		24	
		TC	PI	TC	PI	TC	PI	TC	PI	TC	PI	TC	PI	TC	PI
100	10	23.2	2.47	31.7	3.08	42.2	3.75	59.6	4.57	78.5	5.71	113.1	7.62	149.9	10.08
	12	23.2	2.49	31.7	3.11	42.2	3.78	59.6	4.62	78.5	5.77	113.1	7.70	149.9	10.19
	14	23.2	2.52	31.7	3.14	42.2	3.82	59.6	4.66	78.5	5.83	113.1	7.78	149.9	10.30
	16	23.2	2.54	31.7	3.17	42.2	3.86	59.6	4.71	78.5	5.89	113.1	7.86	149.9	10.40
	18	23.2	2.57	31.7	3.21	42.2	3.90	59.6	4.76	78.5	5.95	113.1	7.94	149.9	10.51
	20	23.2	2.59	31.7	3.24	42.2	3.94	59.6	4.81	78.5	6.01	113.1	8.02	149.9	10.61
	21	23.2	2.62	31.7	3.34	52.6	4.92	70.0	5.73	89.5	7.38	122.1	10.08	157.6	11.94
	23	40.3	4.65	55.5	6.22	73.5	6.97	92.2	7.75	111.7	11.12	140.0	14.37	172.9	16.93
	25	57.5	7.37	74.8	9.33	94.5	10.42	114.9	12.29	133.9	15.98	157.9	20.89	188.2	24.58
	27	74.7	11.65	94.1	13.87	115.4	15.62	136.5	18.67	156.2	23.70	175.8	29.89	203.5	34.22
	29	91.8	16.18	113.4	18.68	136.4	22.94	158.7	27.01	178.4	32.19	193.7	38.64	218.7	42.00
	31	109.0	20.49	132.8	24.70	157.3	30.43	180.9	35.80	200.6	40.83	211.7	44.68	235.8	47.61
	33	126.2	25.25	152.1	32.23	178.2	39.16	203.0	45.42	223.0	49.60	229.9	50.46	235.8	51.57
	35	143.6	30.42	171.0	38.83	199.1	48.26	212.8	53.43	223.0	53.75	229.9	53.96	235.8	54.39
	37	143.6	32.57	171.0	41.65	199.1	51.12	212.8	55.97	219.4	56.25	225.7	56.47	231.0	57.00
	39	143.6	34.92	171.0	44.74	199.1	54.17	212.8	58.71	215.7	58.97	222.1	59.19	227.2	59.74
	41	141.4	37.27	168.3	47.83	196.0	57.22	204.2	61.44	208.7	61.69	213.6	61.91	220.5	62.49
	43	136.5	39.45	162.5	50.71	189.2	59.96	195.8	63.80	198.0	64.02	204.1	64.23	209.5	64.84
46	127.9	42.43	152.3	54.66	177.3	63.59	178.8	66.79	180.7	66.98	186.5	67.18	191.5	67.82	
48	113.2	36.64	134.7	47.29	153.1	54.37	155.3	56.67	157.0	56.85	162.1	56.98	166.5	57.44	
90	10	20.9	2.27	28.5	2.83	38.0	3.56	52.6	4.07	70.7	5.25	101.7	6.93	135.0	9.07
	12	20.9	2.29	28.5	2.86	38.0	3.60	52.6	4.11	70.7	5.31	101.7	7.00	135.0	9.17
	14	20.9	2.32	28.5	2.89	38.0	3.63	52.6	4.15	70.7	5.36	101.7	7.08	135.0	9.27
	16	20.9	2.34	28.5	2.92	38.0	3.67	52.6	4.19	70.7	5.42	101.7	7.15	135.0	9.36
	18	20.9	2.36	28.5	2.95	38.0	3.71	52.6	4.24	70.7	5.47	101.7	7.22	135.0	9.46
	20	20.9	2.39	28.5	2.98	38.0	3.75	52.6	4.28	70.7	5.53	101.7	7.29	135.0	9.55
	21	20.9	2.41	28.5	3.01	47.7	4.72	62.2	5.07	79.7	6.64	109.9	8.02	142.0	10.51
	23	28.3	3.73	41.9	5.17	66.5	6.69	80.7	7.29	97.4	9.75	126.4	11.89	156.5	14.45
	25	45.1	6.30	60.6	8.30	85.4	9.90	99.2	11.52	115.2	14.22	142.8	17.97	170.9	20.89
	27	61.9	9.27	79.4	11.82	104.2	15.37	117.6	17.12	132.9	20.74	159.2	24.18	185.3	27.34
	29	78.7	12.52	98.1	16.23	123.1	21.42	136.1	23.67	150.7	27.37	175.6	31.05	199.7	36.19
	31	95.4	15.66	116.8	20.84	141.9	26.81	154.6	30.21	168.4	34.10	192.1	36.15	214.2	42.05
	33	112.2	20.17	135.6	25.65	160.8	32.49	173.0	35.83	186.2	39.64	208.5	42.84	228.7	46.97
	35	129.2	24.97	154.3	31.57	179.4	39.03	191.5	43.05	203.7	46.81	224.8	50.21	228.7	51.37
	37	129.2	26.50	154.3	33.58	179.4	41.62	191.5	45.73	203.7	49.41	221.2	52.49	225.0	53.67
	39	129.2	28.06	154.3	35.72	179.4	44.05	191.5	48.67	203.7	51.96	217.6	55.34	221.4	56.01
	41	125.9	31.40	150.3	39.60	174.8	48.35	186.6	53.22	198.5	56.09	208.5	58.32	212.2	59.66
	43	122.8	33.89	146.6	42.79	170.4	52.81	182.0	57.32	193.6	60.15	199.9	62.30	203.5	63.21
46	115.1	38.14	137.4	48.73	159.7	60.17	170.6	64.99	175.9	66.82	182.5	67.18	185.9	67.82	
48	101.8	33.34	121.5	42.63	141.3	52.65	150.9	56.67	152.7	56.85	158.6	56.98	161.6	57.44	
80	10	17.9	2.00	24.4	2.50	32.5	3.15	45.9	3.62	60.5	4.64	87.0	6.13	115.5	8.02
	12	17.9	2.03	24.4	2.53	32.5	3.18	45.9	3.66	60.5	4.69	87.0	6.19	115.5	8.11
	14	17.9	2.05	24.4	2.56	32.5	3.21	45.9	3.69	60.5	4.74	87.0	6.26	115.5	8.19
	16	17.9	2.07	24.4	2.58	32.5	3.24	45.9	3.73	60.5	4.79	87.0	6.32	115.5	8.28
	18	17.9	2.09	24.4	2.61	32.5	3.28	45.9	3.77	60.5	4.84	87.0	6.38	115.5	8.36
	20	17.9	2.11	24.4	2.63	32.5	3.31	45.9	3.81	60.5	4.89	87.0	6.45	115.5	8.44
	21	17.9	2.12	24.4	2.71	40.8	4.17	54.8	4.56	68.5	5.87	94.7	7.09	122.7	9.29
	23	31.7	3.92	40.5	4.66	57.6	5.91	72.5	6.56	84.7	8.62	110.2	10.51	137.1	12.78
	25	45.5	5.67	56.5	7.47	74.4	8.75	90.2	10.37	100.9	12.57	125.7	15.88	151.5	18.47
	27	59.4	8.34	72.5	10.63	91.2	13.59	107.9	15.41	117.0	18.33	141.3	21.38	165.9	24.16
	29	73.2	10.81	88.6	14.61	108.1	18.93	125.6	21.31	133.2	24.20	156.8	27.45	180.3	31.99
	31	87.0	13.25	104.6	18.39	124.9	23.70	143.3	27.19	152.4	29.32	172.3	31.63	194.7	36.80
	33	100.9	17.42	120.7	22.63	141.7	27.86	161.1	32.24	170.5	33.69	187.9	37.49	209.1	41.43
	35	114.8	22.80	136.8	28.58	158.8	35.07	170.2	38.51	181.6	42.16	203.7	47.84	223.3	49.82
	37	114.8	24.12	136.8	30.39	158.8	37.20	170.2	40.95	181.6	44.80	203.7	50.49	219.7	52.34
	39	114.8	25.49	136.8	32.13	158.8	39.79	170.2	44.02	181.6	48.14	203.7	53.34	216.1	55.21
	41	111.8	28.20	133.3	35.60	154.8	43.67	165.9	48.25	177.0	52.90	198.5	57.16	207.0	58.47
	43	109.1	31.04	130.0	38.85	150.9	47.67	161.8	52.59	172.6	57.81	193.6	61.06	198.5	62.58
46	102.2	34.54	121.8	43.76	141.5	53.71	151.6	58.53	161.8	65.23	177.0	67.18	181.2	67.82	
48	90.4	30.16	107.8	38.26	125.1	46.97	134.1	51.13	143.1	56.85	153.7	56.98	157.4	57.44	

# 7. Capacity Tables

Cooling Capacity (76HP)

Combination (%)	Outdoor air temp. (DB, °C)	Indoor air temp. (DB/WB, °C)													
		20		23		26		27		28		30		32	
		14		16		18		19		20		22		24	
		TC	PI	TC	PI	TC	PI	TC	PI	TC	PI	TC	PI	TC	PI
70	10	15.6	1.77	21.2	2.21	28.3	2.78	39.9	3.22	52.6	4.11	75.7	5.42	100.5	7.09
	12	15.6	1.79	21.2	2.24	28.3	2.81	39.9	3.25	52.6	4.15	75.7	5.47	100.5	7.17
	14	15.6	1.81	21.2	2.26	28.3	2.84	39.9	3.29	52.6	4.19	75.7	5.53	100.5	7.24
	16	15.6	1.83	21.2	2.28	28.3	2.87	39.9	3.32	52.6	4.24	75.7	5.59	100.5	7.32
	18	15.6	1.85	21.2	2.31	28.3	2.90	39.9	3.36	52.6	4.28	75.7	5.64	100.5	7.39
	20	15.6	1.87	21.2	2.33	28.3	2.93	39.9	3.39	52.6	4.32	75.7	5.70	100.5	7.46
	21	15.6	1.88	24.7	2.74	36.7	3.84	49.4	4.25	60.8	5.19	83.5	6.27	108.1	8.21
	23	22.3	2.82	38.3	4.47	51.3	5.62	66.5	6.10	77.1	7.62	99.2	9.29	123.1	11.30
	25	35.3	4.65	51.9	6.60	65.9	7.74	83.6	9.64	93.5	11.11	114.9	14.04	138.1	16.33
	27	48.3	6.78	65.5	9.40	80.5	11.41	100.7	14.33	109.8	16.20	130.6	18.90	153.1	21.36
	29	61.4	8.60	79.0	12.42	95.1	15.52	117.8	19.49	126.2	21.39	146.3	24.26	168.0	28.28
	31	74.4	10.58	92.6	15.44	109.7	19.43	134.9	24.49	142.5	25.92	162.0	27.97	183.0	32.53
	33	87.4	14.23	106.2	18.78	124.3	22.57	149.0	28.44	158.8	29.78	177.8	33.14	197.6	36.62
	35	100.3	19.48	120.1	24.29	139.1	29.38	149.0	32.13	158.8	35.09	177.8	41.31	197.6	45.29
	37	100.3	20.71	120.1	25.72	139.1	31.21	149.0	34.17	158.8	37.33	177.8	43.96	197.6	47.80
	39	100.3	21.99	120.1	27.42	139.1	33.37	149.0	36.76	158.8	40.33	177.8	47.05	197.6	51.53
	41	97.8	24.31	117.0	30.04	135.5	36.61	145.1	40.32	154.8	43.84	173.3	51.68	192.5	55.54
	43	95.3	26.46	114.1	32.74	132.2	39.94	141.6	43.97	150.9	47.87	169.0	56.45	187.8	60.07
46	89.3	29.40	106.9	36.81	123.9	44.98	132.7	48.98	141.5	53.97	158.4	63.67	176.0	66.99	
48	79.0	25.66	94.6	32.15	109.6	39.33	117.4	42.80	125.1	47.21	140.1	55.72	155.7	57.44	
60	10	13.7	1.52	18.4	1.89	24.5	2.38	34.6	2.78	45.5	3.51	65.6	4.64	87.0	6.07
	12	13.7	1.53	18.4	1.91	24.5	2.41	34.6	2.80	45.5	3.55	65.6	4.68	87.0	6.13
	14	13.7	1.55	18.4	1.93	24.5	2.43	34.6	2.83	45.5	3.59	65.6	4.73	87.0	6.20
	16	13.7	1.57	18.4	1.95	24.5	2.46	34.6	2.86	45.5	3.63	65.6	4.78	87.0	6.26
	18	13.7	1.58	18.4	1.97	24.5	2.48	34.6	2.89	45.5	3.66	65.6	4.83	87.0	6.33
	20	13.7	1.60	18.4	1.99	24.5	2.51	34.6	2.92	45.5	3.70	65.6	4.88	87.0	6.39
	21	13.7	1.61	18.4	2.07	30.6	3.21	40.6	3.54	52.2	4.44	71.2	5.37	92.5	7.03
	23	13.7	1.78	30.4	3.74	43.3	4.81	56.2	5.14	65.8	6.53	82.8	7.95	103.5	9.67
	25	25.5	3.38	42.5	5.65	55.9	6.62	72.4	8.78	79.4	9.51	96.3	11.78	114.5	13.98
	27	37.5	4.93	54.5	8.05	68.6	9.77	87.4	12.21	93.0	13.65	108.2	15.60	125.5	18.00
	29	49.6	6.40	66.5	10.31	81.2	13.02	103.1	16.05	106.5	17.40	120.0	19.57	136.4	23.00
	31	61.6	8.13	78.6	12.33	93.8	15.86	115.8	19.26	120.1	20.21	134.5	21.67	147.4	26.51
	33	73.7	11.32	90.6	15.00	106.5	17.81	124.9	21.59	133.8	23.13	145.1	25.67	158.4	30.19
	35	85.9	16.53	102.6	20.22	119.3	24.22	127.7	26.38	136.0	28.64	152.8	33.46	169.5	38.59
	37	85.9	17.45	102.6	21.34	119.3	25.66	127.7	28.02	136.0	30.38	152.8	35.52	169.5	41.06
	39	85.9	18.56	102.6	22.72	119.3	27.70	127.7	30.06	136.0	32.70	152.8	38.08	169.5	44.00
	41	83.7	20.13	100.0	24.86	116.3	30.08	124.4	32.84	132.6	35.49	148.9	41.79	165.1	47.81
	43	81.6	21.87	97.5	27.07	113.4	32.79	121.3	35.79	129.3	38.70	145.2	45.62	161.1	52.22
46	76.5	24.49	91.4	30.40	106.3	36.88	113.7	40.23	121.2	43.55	136.0	51.40	150.9	59.50	
48	67.7	21.34	80.8	26.53	94.0	32.22	100.6	35.14	107.2	38.06	120.3	44.96	133.5	52.06	
50	10	12.3	1.30	16.8	1.62	23.6	2.04	31.6	2.50	41.6	3.01	59.9	3.97	79.5	5.18
	12	12.3	1.31	16.8	1.64	23.6	2.06	31.6	2.53	41.6	3.04	59.9	4.01	79.5	5.23
	14	12.3	1.33	16.8	1.66	23.6	2.08	31.6	2.55	41.6	3.07	59.9	4.06	79.5	5.29
	16	12.3	1.34	16.8	1.67	23.6	2.10	31.6	2.58	41.6	3.11	59.9	4.10	79.5	5.34
	18	12.3	1.35	16.8	1.69	23.6	2.12	31.6	2.61	41.6	3.14	59.9	4.14	79.5	5.40
	20	12.3	1.37	16.8	1.71	23.6	2.15	31.6	2.63	41.6	3.17	59.9	4.18	79.5	5.45
	21	12.3	1.38	16.8	1.77	29.4	2.75	37.2	3.16	47.3	3.80	65.0	4.60	83.8	5.99
	23	12.3	1.46	26.6	3.01	40.8	4.12	52.6	4.93	59.9	5.59	74.9	6.81	92.5	8.25
	25	22.1	2.67	36.5	4.44	52.1	5.78	69.6	7.99	73.6	8.15	84.8	9.59	101.1	11.65
	27	32.0	3.82	46.4	6.24	64.6	8.05	80.7	10.65	85.6	10.98	94.7	12.55	109.8	14.83
	29	41.9	5.02	56.2	8.04	74.9	10.35	90.8	13.22	97.6	14.16	104.5	15.55	118.5	18.73
	31	51.8	6.39	66.1	9.56	85.2	12.61	98.7	14.74	104.5	15.67	114.2	16.80	127.2	20.60
	33	61.8	8.89	76.0	11.51	95.5	14.15	102.6	16.16	108.9	17.31	123.6	19.90	135.7	23.12
	35	71.8	13.74	85.9	16.53	99.6	19.52	106.4	21.17	113.2	22.83	126.9	26.34	141.4	30.26
	37	71.8	14.56	85.9	17.46	99.6	20.66	106.4	22.41	113.2	24.17	126.9	28.10	141.4	32.12
	39	71.8	15.54	85.9	18.71	99.6	22.13	106.4	24.13	113.2	25.93	126.9	29.92	141.4	34.70
	41	70.0	16.80	83.7	20.26	97.0	24.20	103.7	26.13	110.3	28.10	123.7	32.80	137.7	37.68
	43	68.3	18.26	81.6	22.03	94.6	26.33	101.1	28.45	107.6	30.59	120.6	35.77	134.3	41.10
46	64.0	20.45	76.5	24.71	88.7	29.54	94.8	31.95	100.8	34.35	113.0	40.25	125.9	46.27	
48	56.6	17.82	67.7	21.55	78.4	25.77	83.8	27.89	89.2	29.97	100.0	35.17	111.4	40.45	

**Note**

1. TC: Total Capacity(kW), PI : Power Input(kW, Comp. + Outdoor fan motor)
2. Capacity tables show the average value of conditions which may occur.

# 7. Capacity Tables

◆ ARUM780LTE5

Cooling Capacity (78HP)

Combination (%)	Outdoor air temp. (DB, °C)	Indoor air temp. (DB/WB, °C)													
		20		23		26		27		28		30		32	
		14	16	18	19	20	22	24	TC	PI	TC	PI	TC	PI	
130	10	30.7	3.06	41.9	3.83	55.9	4.66	78.9	5.68	104.0	7.10	149.7	9.47	198.5	12.53
	12	30.7	3.10	41.9	3.87	55.9	4.70	78.9	5.74	104.0	7.17	149.7	9.57	198.5	12.67
	14	30.7	3.13	41.9	3.91	55.9	4.75	78.9	5.80	104.0	7.25	149.7	9.67	198.5	12.80
	16	30.7	3.16	41.9	3.95	55.9	4.80	78.9	5.86	104.0	7.32	149.7	9.76	198.5	12.93
	18	30.7	3.19	41.9	3.99	55.9	4.85	78.9	5.92	104.0	7.40	149.7	9.86	198.5	13.06
	20	30.7	3.23	41.9	4.03	55.9	4.90	78.9	5.98	104.0	7.47	149.7	9.96	198.5	13.19
	21	30.7	3.26	42.6	4.15	69.2	6.12	91.9	7.12	116.3	9.18	159.4	12.52	204.8	14.85
	23	53.4	5.78	74.4	7.60	96.2	8.67	120.1	9.64	140.8	13.82	179.1	17.87	217.6	21.05
	25	79.0	9.17	95.7	11.41	123.2	12.96	149.8	15.28	165.3	19.86	198.9	25.97	230.3	30.55
	27	103.1	14.60	122.3	17.24	150.2	19.57	177.9	23.40	189.8	29.70	218.6	37.45	243.1	42.20
	29	127.2	20.28	148.9	23.79	177.2	28.74	206.8	33.84	214.3	40.34	238.6	48.41	255.9	53.89
	31	154.3	26.49	179.0	32.68	208.3	39.65	232.9	46.29	238.8	52.79	252.0	66.32	269.2	67.26
	33	181.5	32.65	212.2	42.65	238.2	51.03	251.7	66.26	257.2	65.79	265.1	66.38	283.1	67.32
	35	216.3	44.11	247.9	53.46	255.8	64.87	260.3	65.20	264.5	65.59	271.7	66.18	279.6	66.44
	37	216.3	47.04	244.4	56.10	252.3	64.02	255.8	64.34	260.3	64.72	267.3	65.30	275.3	65.56
	39	216.3	50.08	240.1	59.06	247.9	63.16	252.3	63.48	255.8	63.86	263.7	64.43	271.7	64.68
	41	210.8	53.13	230.1	62.01	237.9	62.30	241.4	62.62	246.2	62.99	253.6	63.56	260.4	63.81
	43	205.6	56.04	220.5	61.14	228.2	61.45	231.7	61.76	236.3	62.13	243.6	62.68	250.2	62.93
46	192.7	59.98	201.2	59.86	208.5	60.16	211.7	60.46	216.1	60.83	222.9	61.37	229.1	61.61	
48	170.4	58.31	174.7	58.48	181.2	58.61	184.1	58.77	188.1	59.27	194.1	59.65	199.5	59.89	
120	10	28.4	2.87	38.7	3.58	51.6	4.35	72.8	5.31	95.9	6.64	138.1	8.86	183.1	11.72
	12	28.4	2.90	38.7	3.62	51.6	4.40	72.8	5.37	95.9	6.71	138.1	8.95	183.1	11.85
	14	28.4	2.93	38.7	3.65	51.6	4.45	72.8	5.42	95.9	6.78	138.1	9.04	183.1	11.97
	16	28.4	2.96	38.7	3.69	51.6	4.49	72.8	5.48	95.9	6.85	138.1	9.13	183.1	12.10
	18	28.4	2.99	38.7	3.73	51.6	4.54	72.8	5.54	95.9	6.92	138.1	9.23	183.1	12.22
	20	28.4	3.02	38.7	3.77	51.6	4.58	72.8	5.59	95.9	6.99	138.1	9.32	183.1	12.34
	21	28.4	3.05	39.3	3.88	65.3	5.84	84.8	6.66	108.4	8.59	147.8	11.72	189.8	13.89
	23	49.2	5.41	70.6	7.23	92.8	8.31	110.7	9.02	134.2	12.93	168.1	16.72	202.9	19.69
	25	76.7	8.57	99.0	10.84	121.5	12.12	138.0	14.29	160.8	18.58	189.6	24.29	216.1	28.58
	27	106.5	13.55	134.7	16.13	150.8	18.16	163.9	21.71	187.5	27.56	211.1	34.75	229.2	39.79
	29	136.7	18.82	162.2	21.73	179.8	26.67	190.5	31.41	214.2	37.43	232.6	44.93	242.5	50.52
	31	165.5	23.82	195.3	28.72	209.0	35.38	219.4	41.63	241.7	47.47	248.3	57.10	256.7	58.16
	33	191.8	29.36	230.4	37.48	244.1	45.54	247.5	52.82	251.8	62.14	258.7	62.85	266.7	63.35
	35	195.7	39.23	232.7	50.82	246.6	56.21	250.0	66.95	254.3	67.28	261.3	67.49	268.1	68.02
	37	195.7	42.20	232.7	53.62	243.1	59.93	246.6	65.54	250.0	65.87	256.9	66.07	263.9	66.59
	39	195.7	45.43	231.9	56.67	238.8	63.56	242.3	64.20	245.7	64.52	253.5	64.71	260.3	65.22
	41	190.7	48.66	221.8	59.72	229.3	62.31	232.5	62.85	235.9	63.16	242.7	63.35	249.6	63.86
	43	186.0	51.93	212.5	58.87	219.9	60.91	223.0	61.50	226.3	61.81	233.0	62.00	239.7	62.49
46	174.3	55.84	193.8	57.47	200.8	59.00	203.8	59.48	206.9	59.78	213.1	59.96	219.4	60.44	
48	154.2	54.70	168.2	56.45	174.5	57.85	177.2	58.20	179.9	58.38	185.4	58.62	191.0	58.85	
110	10	26.0	2.69	35.4	3.36	47.2	4.09	66.7	4.99	87.9	6.24	126.5	8.32	167.7	11.02
	12	26.0	2.72	35.4	3.40	47.2	4.14	66.7	5.04	87.9	6.31	126.5	8.41	167.7	11.13
	14	26.0	2.75	35.4	3.43	47.2	4.18	66.7	5.10	87.9	6.37	126.5	8.50	167.7	11.25
	16	26.0	2.78	35.4	3.47	47.2	4.22	66.7	5.15	87.9	6.44	126.5	8.58	167.7	11.37
	18	26.0	2.81	35.4	3.50	47.2	4.26	66.7	5.20	87.9	6.50	126.5	8.67	167.7	11.48
	20	26.0	2.84	35.4	3.54	47.2	4.31	66.7	5.25	87.9	6.57	126.5	8.76	167.7	11.60
	21	26.0	2.86	35.4	3.65	59.2	5.38	78.3	6.26	97.8	8.07	136.5	11.01	176.3	13.05
	23	46.5	5.08	59.2	6.79	82.9	7.62	102.2	8.47	123.8	12.15	155.2	15.71	191.6	18.50
	25	66.9	8.06	82.9	10.19	106.6	11.39	126.2	13.43	147.1	17.46	173.4	22.83	206.7	26.85
	27	87.4	12.73	106.6	15.16	130.3	17.07	149.9	20.40	171.5	25.90	193.1	32.66	223.4	37.39
	29	107.8	17.68	130.3	20.42	154.1	25.06	174.3	29.51	195.9	35.17	212.7	41.37	235.7	45.89
	31	130.8	22.39	157.1	26.99	181.3	33.25	198.6	39.11	220.3	44.61	232.4	47.84	244.4	51.50
	33	151.7	27.59	181.3	35.22	205.5	42.79	224.0	47.81	238.1	53.66	245.5	55.14	251.8	55.22
	35	175.3	34.76	209.0	44.72	233.5	50.98	240.2	54.62	243.6	57.98	249.5	58.51	256.3	58.80
	37	175.3	36.84	209.0	47.46	233.5	53.82	236.9	57.87	239.4	61.15	246.2	61.36	252.0	61.54
	39	175.3	39.72	209.0	50.43	229.3	56.79	232.6	61.90	236.1	64.18	241.9	64.29	248.7	64.35
	41	170.9	42.59	203.7	53.41	219.5	59.89	222.9	66.95	225.8	66.95	232.4	67.49	238.2	68.02
	43	166.6	44.73	198.7	55.64	210.3	63.51	213.8	64.22	216.5	64.08	223.0	64.45	228.6	64.62
46	156.2	43.65	186.2	53.72	191.9	60.27	195.2	60.27	197.8	60.79	203.8	61.12	209.1	61.29	
48	138.1	42.40	161.8	51.75	166.7	57.34	169.7	57.73	171.9	58.01	177.3	58.17	181.9	58.40	

# 7. Capacity Tables

Cooling Capacity (78HP)

Combination (%)	Outdoor air temp. (DB, °C)	Indoor air temp. (DB/WB, °C)													
		20		23		26		27		28		30		32	
		14		16		18		19		20		22		24	
		TC	PI	TC	PI	TC	PI	TC	PI	TC	PI	TC	PI	TC	PI
100	10	23.8	2.47	32.5	3.09	43.3	3.75	61.2	4.58	80.6	5.72	116.0	7.63	153.9	10.11
	12	23.8	2.50	32.5	3.12	43.3	3.79	61.2	4.63	80.6	5.78	116.0	7.71	153.9	10.21
	14	23.8	2.52	32.5	3.15	43.3	3.83	61.2	4.68	80.6	5.84	116.0	7.79	153.9	10.32
	16	23.8	2.55	32.5	3.18	43.3	3.87	61.2	4.72	80.6	5.90	116.0	7.87	153.9	10.43
	18	23.8	2.58	32.5	3.22	43.3	3.91	61.2	4.77	80.6	5.97	116.0	7.96	153.9	10.53
	20	23.8	2.60	32.5	3.25	43.3	3.95	61.2	4.82	80.6	6.03	116.0	8.04	153.9	10.64
	21	23.8	2.63	32.5	3.35	54.0	4.94	71.8	5.74	91.9	7.40	125.3	10.10	161.8	11.97
	23	41.3	4.66	56.9	6.23	75.5	6.99	94.6	7.77	114.7	11.14	143.7	14.41	177.5	16.97
	25	59.0	7.39	76.8	9.35	97.0	10.45	117.9	12.32	137.5	16.01	162.1	20.94	193.1	24.64
	27	76.6	11.68	96.6	13.91	118.5	15.66	140.1	18.72	160.3	23.76	180.4	29.96	208.8	34.31
	29	94.3	16.22	116.4	18.73	140.0	22.99	162.9	27.07	183.1	32.27	198.8	38.73	224.5	42.10
	31	111.9	20.54	136.3	24.76	161.4	30.50	185.6	35.89	205.9	40.93	217.2	44.78	242.0	47.73
	33	129.6	25.31	156.1	32.31	182.9	39.26	208.4	45.53	228.9	49.73	236.0	50.59	242.0	51.69
	35	147.4	30.49	175.5	38.93	204.4	48.38	218.4	53.56	228.9	53.88	236.0	54.09	242.0	54.52
	37	147.4	32.65	175.5	41.75	204.4	51.24	218.4	56.11	225.1	56.39	231.6	56.61	237.1	57.14
	39	147.4	35.01	175.5	44.85	204.4	54.30	218.4	58.85	221.4	59.11	227.9	59.33	233.2	59.89
	41	145.1	37.36	172.7	47.95	201.1	57.36	209.6	61.59	214.2	61.84	219.2	62.06	226.3	62.64
43	140.1	39.54	166.8	50.83	194.2	60.10	200.9	63.95	203.2	64.18	209.5	64.39	215.0	64.99	
46	131.3	42.53	156.3	54.80	182.0	63.75	183.5	66.95	185.4	67.15	191.4	67.34	196.5	67.98	
48	116.1	36.72	138.3	47.41	157.1	54.50	159.4	56.81	161.1	56.99	166.4	57.12	170.9	57.58	
90	10	21.4	2.27	29.2	2.84	39.0	3.57	53.9	4.08	72.5	5.27	104.4	6.95	138.5	9.10
	12	21.4	2.30	29.2	2.87	39.0	3.60	53.9	4.12	72.5	5.32	104.4	7.02	138.5	9.19
	14	21.4	2.32	29.2	2.90	39.0	3.64	53.9	4.16	72.5	5.38	104.4	7.09	138.5	9.29
	16	21.4	2.35	29.2	2.93	39.0	3.68	53.9	4.20	72.5	5.43	104.4	7.17	138.5	9.38
	18	21.4	2.37	29.2	2.96	39.0	3.72	53.9	4.25	72.5	5.49	104.4	7.24	138.5	9.48
	20	21.4	2.39	29.2	2.99	39.0	3.75	53.9	4.29	72.5	5.54	104.4	7.31	138.5	9.58
	21	21.4	2.42	29.2	3.02	48.9	4.73	63.9	5.08	81.8	6.65	112.8	8.04	145.8	10.53
	23	29.1	3.74	43.0	5.19	68.3	6.71	82.8	7.31	100.0	9.78	129.7	11.92	160.6	14.49
	25	46.3	6.32	62.2	8.32	87.6	9.93	101.8	11.55	118.2	14.25	146.5	18.01	175.4	20.94
	27	63.5	9.29	81.5	11.85	107.0	15.41	120.7	17.17	136.4	20.79	163.4	24.24	190.2	27.40
	29	80.7	12.55	100.7	16.27	126.3	21.47	139.7	23.73	154.6	27.44	180.3	31.12	205.0	36.27
	31	97.9	15.70	119.9	20.90	145.7	26.88	158.6	30.28	172.8	34.18	197.1	36.24	219.8	42.15
	33	115.1	20.22	139.1	25.72	165.0	32.57	177.6	35.91	191.1	39.74	214.0	42.94	234.7	47.08
	35	132.6	25.03	158.3	31.65	184.1	39.13	196.6	43.16	209.0	46.92	230.7	50.34	234.7	51.49
	37	132.6	26.57	158.3	33.66	184.1	41.72	196.6	45.85	209.0	49.53	227.0	52.62	231.0	53.80
	39	132.6	28.13	158.3	35.80	184.1	44.16	196.6	48.79	209.0	52.08	223.3	55.47	227.2	56.14
	41	129.2	31.47	154.3	39.70	179.4	48.47	191.5	53.35	203.7	56.23	214.0	58.46	217.8	59.80
43	126.0	33.97	150.5	42.89	174.9	52.94	186.8	57.46	198.7	60.29	205.2	62.46	208.9	63.36	
46	118.1	38.24	141.0	48.85	163.9	60.32	175.1	65.14	180.5	66.98	187.3	67.34	190.8	67.98	
48	104.5	33.42	124.7	42.73	145.0	52.78	154.9	56.81	156.7	56.99	162.8	57.12	165.9	57.58	
80	10	18.4	2.01	25.0	2.51	33.4	3.15	47.1	3.63	62.1	4.66	89.3	6.14	118.5	8.04
	12	18.4	2.03	25.0	2.54	33.4	3.19	47.1	3.67	62.1	4.70	89.3	6.21	118.5	8.13
	14	18.4	2.05	25.0	2.56	33.4	3.22	47.1	3.70	62.1	4.75	89.3	6.27	118.5	8.21
	16	18.4	2.07	25.0	2.59	33.4	3.25	47.1	3.74	62.1	4.80	89.3	6.33	118.5	8.30
	18	18.4	2.09	25.0	2.61	33.4	3.29	47.1	3.78	62.1	4.85	89.3	6.40	118.5	8.38
	20	18.4	2.12	25.0	2.64	33.4	3.32	47.1	3.82	62.1	4.90	89.3	6.46	118.5	8.46
	21	18.4	2.13	25.0	2.72	41.9	4.18	56.2	4.58	70.3	5.88	97.1	7.11	126.0	9.31
	23	32.5	3.93	41.5	4.67	59.1	5.93	74.4	6.58	86.9	8.64	113.1	10.53	140.7	12.81
	25	46.7	5.69	58.0	7.49	76.4	8.77	92.5	10.39	103.5	12.60	129.0	15.92	155.5	18.51
	27	60.9	8.36	74.5	10.66	93.6	13.62	110.7	15.45	120.1	18.38	145.0	21.43	170.3	24.22
	29	75.1	10.84	90.9	14.64	110.9	18.98	128.9	21.36	136.7	24.25	160.9	27.51	185.0	32.07
	31	89.3	13.28	107.4	18.43	128.2	23.76	147.0	27.26	156.4	29.40	176.9	31.71	199.8	36.89
	33	103.5	17.47	123.9	22.68	145.4	27.93	165.3	32.32	175.0	33.78	192.8	37.58	214.6	41.53
	35	117.8	22.86	140.4	28.65	163.0	35.15	174.7	38.61	186.4	42.27	209.0	47.95	229.2	49.95
	37	117.8	24.18	140.4	30.46	163.0	37.29	174.7	41.05	186.4	44.91	209.0	50.61	225.5	52.46
	39	117.8	25.56	140.4	32.21	163.0	39.89	174.7	44.13	186.4	48.26	209.0	53.47	221.8	55.35
	41	114.8	28.27	136.8	35.69	158.8	43.77	170.2	48.37	181.6	53.03	203.7	57.29	212.5	58.61
43	111.9	31.12	133.4	38.95	154.9	47.78	166.0	52.71	177.2	57.95	198.7	61.21	203.7	62.73	
46	104.9	34.62	125.0	43.87	145.2	53.84	155.6	58.67	166.0	65.39	181.7	67.34	185.9	67.98	
48	92.8	30.24	110.6	38.36	128.4	47.09	137.6	51.25	146.9	56.99	157.8	57.12	161.6	57.58	

# 7. Capacity Tables

Cooling Capacity (78HP)

Combination (%)	Outdoor air temp. (DB, °C)	Indoor air temp. (DB/WB, °C)													
		20		23		26		27		28		30		32	
		14		16		18		19		20		22		24	
		TC	PI	TC	PI	TC	PI	TC	PI	TC	PI	TC	PI	TC	PI
70	10	16.0	1.78	21.8	2.22	29.0	2.79	41.0	3.23	54.0	4.12	77.7	5.43	103.1	7.11
	12	16.0	1.80	21.8	2.24	29.0	2.82	41.0	3.26	54.0	4.16	77.7	5.49	103.1	7.18
	14	16.0	1.81	21.8	2.26	29.0	2.85	41.0	3.30	54.0	4.20	77.7	5.54	103.1	7.26
	16	16.0	1.83	21.8	2.29	29.0	2.88	41.0	3.33	54.0	4.25	77.7	5.60	103.1	7.33
	18	16.0	1.85	21.8	2.31	29.0	2.90	41.0	3.36	54.0	4.29	77.7	5.66	103.1	7.41
	20	16.0	1.87	21.8	2.33	29.0	2.93	41.0	3.40	54.0	4.33	77.7	5.71	103.1	7.48
	21	16.0	1.88	25.4	2.74	37.7	3.85	50.7	4.26	62.4	5.20	85.7	6.29	111.0	8.23
	23	22.9	2.83	39.3	4.48	52.7	5.63	68.3	6.12	79.2	7.64	101.8	9.31	126.3	11.32
	25	36.3	4.66	53.2	6.62	67.7	7.76	85.8	9.66	95.9	11.14	117.9	14.07	141.7	16.37
	27	49.6	6.80	67.2	9.42	82.6	11.44	103.4	14.37	112.7	16.24	134.1	18.94	157.1	21.41
	29	63.0	8.62	81.1	12.45	97.6	15.56	120.9	19.54	129.5	21.44	150.2	24.32	172.5	28.35
	31	76.4	10.61	95.0	15.48	112.6	19.48	138.5	24.55	146.3	25.99	166.3	28.03	187.8	32.61
	33	89.7	14.27	109.0	18.83	127.6	22.62	152.9	28.51	163.0	29.86	182.5	33.22	202.8	36.71
	35	103.0	19.53	123.2	24.34	142.7	29.45	152.9	32.21	163.0	35.17	182.5	41.41	202.8	45.40
	37	103.0	20.76	123.2	25.78	142.7	31.29	152.9	34.25	163.0	37.42	182.5	44.07	202.8	47.92
	39	103.0	22.04	123.2	27.48	142.7	33.45	152.9	36.85	163.0	40.42	182.5	47.16	202.8	51.66
41	100.3	24.37	120.1	30.11	139.1	36.70	149.0	40.42	158.8	43.95	177.8	51.80	197.6	55.68	
43	97.8	26.53	117.1	32.82	135.6	40.04	145.3	44.08	154.9	47.99	173.5	56.59	192.7	60.22	
46	91.7	29.48	109.8	36.90	127.1	45.09	136.2	49.09	145.2	54.10	162.5	63.83	180.6	67.16	
48	81.1	25.72	97.1	32.23	112.5	39.42	120.4	42.90	128.4	47.33	143.8	55.85	159.8	57.58	
60	10	14.1	1.54	18.8	1.92	25.1	2.41	35.5	2.81	46.7	3.56	67.3	4.69	89.3	6.14
	12	14.1	1.55	18.8	1.94	25.1	2.43	35.5	2.84	46.7	3.59	67.3	4.74	89.3	6.21
	14	14.1	1.57	18.8	1.96	25.1	2.46	35.5	2.87	46.7	3.63	67.3	4.79	89.3	6.27
	16	14.1	1.58	18.8	1.98	25.1	2.49	35.5	2.90	46.7	3.67	67.3	4.84	89.3	6.34
	18	14.1	1.60	18.8	2.00	25.1	2.51	35.5	2.93	46.7	3.71	67.3	4.89	89.3	6.40
	20	14.1	1.62	18.8	2.02	25.1	2.54	35.5	2.96	46.7	3.74	67.3	4.94	89.3	6.47
	21	14.1	1.63	18.8	2.09	31.4	3.25	41.7	3.59	53.6	4.49	73.1	5.43	95.0	7.11
	23	14.1	1.80	31.2	3.79	44.4	4.87	57.7	5.20	67.5	6.60	85.0	8.05	106.2	9.79
	25	26.2	3.42	43.6	5.72	57.4	6.70	74.3	8.88	81.5	9.63	98.9	11.92	117.5	14.15
	27	38.5	4.99	55.9	8.15	70.4	9.89	89.7	12.36	95.4	13.82	111.0	15.79	128.8	18.22
	29	50.9	6.47	68.3	10.44	83.3	13.18	105.9	16.24	109.3	17.61	123.2	19.81	140.0	23.28
	31	63.2	8.23	80.7	12.48	96.3	16.05	118.8	19.49	123.3	20.46	138.0	21.93	151.3	26.83
	33	75.6	11.46	93.0	15.18	109.3	18.02	128.2	21.85	137.3	23.41	149.0	25.99	162.6	30.56
	35	88.1	16.57	105.3	20.27	122.5	24.28	131.0	26.44	139.6	28.71	156.8	33.54	173.9	38.69
	37	88.1	17.49	105.3	21.39	122.5	25.72	131.0	28.09	139.6	30.46	156.8	35.60	173.9	41.16
	39	88.1	18.60	105.3	22.78	122.5	27.77	131.0	30.14	139.6	32.78	156.8	38.17	173.9	44.10
41	85.9	20.18	102.6	24.93	119.3	30.15	127.7	32.92	136.0	35.58	152.8	41.89	169.5	47.93	
43	83.8	21.92	100.1	27.14	116.4	32.87	124.5	35.88	132.7	38.80	149.0	45.73	165.3	52.35	
46	78.5	24.55	93.8	30.47	109.1	36.97	116.7	40.33	124.3	43.66	139.6	51.53	154.9	59.64	
48	69.4	21.40	83.0	26.59	96.5	32.30	103.2	35.22	110.0	38.15	123.5	45.07	137.0	52.18	
50	10	12.6	1.33	17.2	1.66	24.3	2.09	32.4	2.56	42.7	3.08	61.5	4.06	81.6	5.30
	12	12.6	1.34	17.2	1.68	24.3	2.11	32.4	2.59	42.7	3.11	61.5	4.11	81.6	5.35
	14	12.6	1.36	17.2	1.70	24.3	2.13	32.4	2.61	42.7	3.14	61.5	4.15	81.6	5.41
	16	12.6	1.37	17.2	1.71	24.3	2.15	32.4	2.64	42.7	3.18	61.5	4.19	81.6	5.46
	18	12.6	1.39	17.2	1.73	24.3	2.17	32.4	2.67	42.7	3.21	61.5	4.23	81.6	5.52
	20	12.6	1.40	17.2	1.75	24.3	2.20	32.4	2.69	42.7	3.24	61.5	4.28	81.6	5.58
	21	12.6	1.41	17.2	1.81	30.2	2.82	38.2	3.23	48.6	3.89	66.7	4.70	86.0	6.13
	23	12.6	1.50	27.3	3.08	41.8	4.22	54.0	5.04	61.5	5.72	76.9	6.97	94.9	8.44
	25	22.7	2.73	37.5	4.54	53.5	5.91	71.4	8.18	75.6	8.34	87.0	9.81	103.8	11.92
	27	32.8	3.91	47.6	6.38	66.3	8.23	82.8	10.90	87.9	11.23	97.1	12.84	112.7	15.17
	29	43.0	5.14	57.7	8.23	76.8	10.59	93.1	13.52	100.2	14.49	107.3	15.91	121.6	19.16
	31	53.2	6.53	67.9	9.78	87.4	12.89	101.3	15.08	107.2	16.03	117.2	17.18	130.5	21.08
	33	63.4	9.09	78.0	11.77	98.0	14.48	105.3	16.53	111.7	17.71	126.8	20.36	139.3	23.65
	35	73.7	13.77	88.1	16.57	102.2	19.57	109.2	21.23	116.2	22.88	130.3	26.40	145.1	30.34
	37	73.7	14.60	88.1	17.50	102.2	20.71	109.2	22.47	116.2	24.23	130.3	28.16	145.1	32.20
	39	73.7	15.57	88.1	18.76	102.2	22.19	109.2	24.19	116.2	26.00	130.3	30.00	145.1	34.78
41	71.8	16.84	85.9	20.30	99.6	24.26	106.4	26.19	113.2	28.17	126.9	32.88	141.4	37.77	
43	70.0	18.30	83.8	22.09	97.1	26.40	103.8	28.52	110.4	30.67	123.8	35.86	137.9	41.20	
46	65.6	20.50	78.5	24.77	91.0	29.61	97.3	32.03	103.5	34.43	116.0	40.35	129.2	46.39	
48	58.1	17.86	69.4	21.60	80.5	25.83	86.0	27.96	91.6	30.05	102.6	35.26	114.3	40.55	

**Note**

1. TC: Total Capacity(kW), PI : Power Input(kW, Comp. + Outdoor fan motor)
2. Capacity tables show the average value of conditions which may occur.



# 7. Capacity Tables

## ◆ ARUM800LTE5

Cooling Capacity (80HP)

Combination (%)	Outdoor air temp. (DB, °C)	Indoor air temp. (DB/WB, °C)													
		20		23		26		27		28		30		32	
		14	16	16	18	18	19	20	20	22	22	24	24		
		TC	PI	TC	PI	TC	PI	TC	PI	TC	PI	TC	PI	TC	PI
130	10	31.5	3.16	43.0	3.95	57.3	4.81	80.9	5.86	106.6	7.33	153.5	9.77	203.6	12.94
	12	31.5	3.20	43.0	3.99	57.3	4.86	80.9	5.92	106.6	7.40	153.5	9.87	203.6	13.07
	14	31.5	3.23	43.0	4.03	57.3	4.91	80.9	5.99	106.6	7.48	153.5	9.98	203.6	13.21
	16	31.5	3.26	43.0	4.07	57.3	4.96	80.9	6.05	106.6	7.56	153.5	10.08	203.6	13.35
	18	31.5	3.30	43.0	4.12	57.3	5.01	80.9	6.11	106.6	7.64	153.5	10.18	203.6	13.48
	20	31.5	3.33	43.0	4.16	57.3	5.06	80.9	6.17	106.6	7.71	153.5	10.29	203.6	13.62
	21	31.5	3.36	43.7	4.28	71.0	6.32	94.3	7.35	119.2	9.47	163.5	12.93	210.1	15.33
	23	54.8	5.97	76.3	7.85	98.7	8.95	123.2	9.95	144.4	14.26	183.7	18.45	223.1	21.73
	25	81.0	9.46	98.1	11.77	126.4	13.38	153.6	15.77	169.5	20.50	204.0	26.81	236.2	31.54
	27	105.7	15.08	125.4	17.80	154.0	20.20	182.5	24.16	194.6	30.66	224.2	38.66	249.3	43.56
	29	130.4	20.93	152.7	24.55	181.7	29.67	212.1	34.94	219.8	41.64	244.7	49.98	262.5	55.63
	31	158.3	27.35	183.6	33.74	213.6	40.93	238.9	47.79	244.9	54.50	258.4	68.46	276.1	69.43
	33	186.2	33.71	217.6	44.03	244.3	52.68	258.2	68.40	263.7	67.92	271.9	68.53	290.3	69.49
	35	221.9	45.53	254.3	55.19	262.4	66.97	266.9	67.31	271.3	67.71	278.6	68.32	286.8	68.58
	37	221.9	48.55	250.7	57.92	258.8	66.08	262.4	66.42	266.9	66.82	274.2	67.41	282.3	67.68
	39	221.9	51.70	246.2	60.97	254.3	65.20	258.8	65.53	262.4	65.92	270.5	66.51	278.6	66.77
41	216.2	54.85	236.0	64.01	244.0	64.32	247.6	64.64	252.5	65.03	260.1	65.61	267.1	65.87	
43	210.8	57.85	226.2	63.11	234.0	63.43	237.6	63.75	242.3	64.13	249.8	64.71	256.6	64.96	
46	197.6	61.92	206.3	61.79	213.8	62.10	217.2	62.42	221.7	62.79	228.6	63.35	235.0	63.60	
48	174.8	60.19	179.2	60.37	185.9	60.50	188.8	60.67	192.9	61.19	199.1	61.58	204.6	61.82	
120	10	29.1	2.96	39.7	3.69	52.9	4.50	74.6	5.48	98.4	6.85	141.6	9.14	187.8	12.10
	12	29.1	2.99	39.7	3.73	52.9	4.54	74.6	5.54	98.4	6.93	141.6	9.24	187.8	12.23
	14	29.1	3.02	39.7	3.77	52.9	4.59	74.6	5.60	98.4	7.00	141.6	9.33	187.8	12.36
	16	29.1	3.05	39.7	3.81	52.9	4.64	74.6	5.66	98.4	7.07	141.6	9.43	187.8	12.49
	18	29.1	3.08	39.7	3.85	52.9	4.68	74.6	5.71	98.4	7.14	141.6	9.53	187.8	12.61
	20	29.1	3.11	39.7	3.89	52.9	4.73	74.6	5.77	98.4	7.22	141.6	9.62	187.8	12.74
	21	29.1	3.15	40.3	4.01	67.0	6.03	86.9	6.87	111.2	8.86	151.6	12.09	194.6	14.34
	23	50.4	5.58	72.4	7.46	95.2	8.58	113.5	9.31	137.6	13.34	172.4	17.26	208.1	20.32
	25	78.6	8.85	101.6	11.19	124.7	12.51	141.5	14.75	165.0	19.18	194.5	25.08	221.6	29.50
	27	109.2	13.99	138.2	16.65	154.7	18.75	168.1	22.42	192.3	28.45	216.5	35.87	235.1	41.08
	29	140.2	19.42	166.3	22.43	184.4	27.53	195.4	32.42	219.7	38.64	238.6	46.38	248.7	52.15
	31	169.8	24.59	200.4	29.65	214.3	36.53	225.0	42.97	247.9	49.01	254.7	58.94	263.3	60.04
	33	196.7	30.31	236.3	38.69	250.4	47.01	253.8	54.53	258.3	64.15	265.3	64.88	273.6	65.40
	35	200.8	40.50	238.7	52.46	252.9	58.03	256.4	69.11	260.9	69.46	268.0	69.67	275.0	70.22
	37	200.8	43.56	238.7	55.35	249.3	61.86	252.9	67.66	256.4	68.00	263.5	68.20	270.6	68.74
	39	200.8	46.89	237.9	58.50	245.0	65.62	248.5	66.27	252.0	66.60	260.0	66.80	267.0	67.33
41	195.6	50.23	227.5	61.65	235.2	64.32	238.5	64.88	242.0	65.20	249.0	65.40	256.1	65.92	
43	190.8	53.61	217.9	60.77	225.5	62.88	228.8	63.49	232.1	63.81	239.0	64.00	245.9	64.51	
46	178.8	57.65	198.7	59.32	205.9	60.91	209.0	61.40	212.2	61.71	218.6	61.90	225.0	62.39	
48	158.2	56.47	172.5	58.27	179.0	59.72	181.7	60.08	184.5	60.27	190.2	60.51	195.9	60.75	
110	10	26.6	2.78	36.3	3.47	48.4	4.22	68.4	5.15	90.1	6.44	129.7	8.59	172.0	11.37
	12	26.6	2.81	36.3	3.51	48.4	4.27	68.4	5.21	90.1	6.51	129.7	8.68	172.0	11.49
	14	26.6	2.84	36.3	3.54	48.4	4.31	68.4	5.26	90.1	6.58	129.7	8.77	172.0	11.61
	16	26.6	2.87	36.3	3.58	48.4	4.36	68.4	5.32	90.1	6.64	129.7	8.86	172.0	11.73
	18	26.6	2.90	36.3	3.62	48.4	4.40	68.4	5.37	90.1	6.71	129.7	8.95	172.0	11.85
	20	26.6	2.93	36.3	3.65	48.4	4.45	68.4	5.42	90.1	6.78	129.7	9.04	172.0	11.97
	21	26.6	2.96	36.3	3.77	60.7	5.55	80.3	6.46	100.3	8.33	140.1	11.36	180.8	13.47
	23	47.7	5.25	60.7	7.01	85.0	7.86	104.8	8.74	127.0	12.54	159.1	16.21	196.6	19.10
	25	68.7	8.32	85.0	10.52	109.4	11.76	129.4	13.86	150.9	18.02	177.8	23.56	211.9	27.72
	27	89.6	13.15	109.3	15.65	133.7	17.62	153.8	21.06	175.9	26.74	198.0	33.71	229.2	38.60
	29	110.6	18.25	133.7	21.07	158.0	25.87	178.7	30.46	200.9	36.31	218.2	42.71	241.8	47.37
	31	134.2	23.11	161.1	27.86	186.0	34.32	203.7	40.38	225.9	46.05	238.4	49.38	250.7	53.17
	33	155.6	28.48	186.0	36.36	210.8	44.17	229.7	49.36	244.2	55.39	251.8	56.92	258.2	57.00
	35	179.8	35.88	214.4	46.16	239.5	52.63	246.4	56.38	249.9	59.85	255.9	60.40	262.9	60.70
	37	179.8	38.03	214.4	48.99	239.5	55.56	242.9	59.74	245.5	63.12	252.5	63.35	258.5	63.52
	39	179.8	41.00	214.4	52.06	235.2	58.62	238.6	63.90	242.1	66.25	248.1	66.36	255.1	66.43
41	175.2	43.97	208.9	55.13	225.1	61.82	228.6	69.11	231.6	69.11	238.4	69.67	244.3	70.22	
43	170.9	46.17	203.7	57.44	215.7	65.56	219.2	66.30	222.1	66.15	228.7	66.53	234.5	66.71	
46	160.2	45.06	190.9	55.45	196.8	62.22	200.2	62.22	202.9	62.75	209.0	63.10	214.5	63.27	
48	141.7	43.77	166.0	53.42	171.0	59.20	174.1	59.59	176.3	59.88	181.8	60.05	186.6	60.29	

# 7. Capacity Tables

Cooling Capacity (80HP)

Combination (%)	Outdoor air temp. (DB, °C)	Indoor air temp. (DB/WB, °C)													
		20		23		26		27		28		30		32	
		14		16		18		19		20		22		24	
		TC	PI	TC	PI	TC	PI	TC	PI	TC	PI	TC	PI	TC	PI
100	10	24.4	2.55	33.3	3.18	44.4	3.88	62.7	4.73	82.7	5.91	119.0	7.88	157.8	10.43
	12	24.4	2.58	33.3	3.22	44.4	3.92	62.7	4.78	82.7	5.97	119.0	7.96	157.8	10.54
	14	24.4	2.60	33.3	3.25	44.4	3.96	62.7	4.83	82.7	6.03	119.0	8.05	157.8	10.65
	16	24.4	2.63	33.3	3.29	44.4	4.00	62.7	4.88	82.7	6.10	119.0	8.13	157.8	10.76
	18	24.4	2.66	33.3	3.32	44.4	4.04	62.7	4.93	82.7	6.16	119.0	8.21	157.8	10.87
	20	24.4	2.69	33.3	3.35	44.4	4.08	62.7	4.98	82.7	6.22	119.0	8.30	157.8	10.98
	21	24.4	2.71	33.3	3.45	55.4	5.10	73.7	5.93	94.2	7.64	128.5	10.43	165.9	12.36
	23	42.4	4.81	58.4	6.43	77.4	7.21	97.0	8.02	117.6	11.50	147.3	14.88	182.0	17.52
	25	60.5	7.63	78.7	9.65	99.5	10.79	121.0	12.72	141.0	16.53	166.2	21.62	198.1	25.43
	27	78.6	12.06	99.1	14.36	121.5	16.16	143.7	19.32	164.4	24.53	185.1	30.93	214.2	35.41
	29	96.7	16.74	119.4	19.33	143.5	23.73	167.0	27.95	187.8	33.31	203.9	39.98	230.2	43.46
	31	114.8	21.20	139.8	25.56	165.6	31.49	190.4	37.04	211.1	42.25	222.8	46.23	248.2	49.27
	33	132.9	26.13	160.1	33.36	187.6	40.53	213.7	47.01	234.8	51.33	242.0	52.22	248.2	53.36
	35	151.2	31.47	180.0	40.18	209.6	49.94	224.0	55.29	234.8	55.62	242.0	55.84	248.2	56.29
	37	151.2	33.71	180.0	43.10	209.6	52.90	224.0	57.92	230.9	58.21	237.6	58.44	243.2	58.98
	39	151.2	36.14	180.0	46.30	209.6	56.06	224.0	60.75	227.0	61.02	233.7	61.25	239.2	61.82
41	148.8	38.57	177.1	49.50	206.3	59.21	214.9	63.58	219.7	63.84	224.8	64.06	232.1	64.66	
43	143.7	40.82	171.1	52.47	199.2	62.04	206.1	66.02	208.4	66.25	214.9	66.47	220.5	67.09	
46	134.7	43.91	160.3	56.57	186.7	65.81	188.2	69.11	190.2	69.32	196.3	69.52	201.6	70.18	
48	119.1	37.91	141.8	48.94	161.2	56.26	163.5	58.64	165.2	58.83	170.6	58.96	175.3	59.44	
90	10	22.0	2.35	30.0	2.93	40.0	3.68	55.3	4.21	74.4	5.44	107.1	7.17	142.1	9.39
	12	22.0	2.37	30.0	2.96	40.0	3.72	55.3	4.25	74.4	5.49	107.1	7.25	142.1	9.49
	14	22.0	2.40	30.0	2.99	40.0	3.76	55.3	4.30	74.4	5.55	107.1	7.32	142.1	9.59
	16	22.0	2.42	30.0	3.02	40.0	3.80	55.3	4.34	74.4	5.61	107.1	7.40	142.1	9.69
	18	22.0	2.45	30.0	3.05	40.0	3.84	55.3	4.38	74.4	5.67	107.1	7.47	142.1	9.79
	20	22.0	2.47	30.0	3.08	40.0	3.88	55.3	4.43	74.4	5.72	107.1	7.55	142.1	9.88
	21	22.0	2.49	30.0	3.12	50.2	4.88	65.5	5.25	83.9	6.87	115.7	8.30	149.5	10.87
	23	29.8	3.86	44.1	5.35	70.0	6.92	84.9	7.54	102.5	10.09	133.0	12.30	164.7	14.96
	25	47.5	6.52	63.8	8.59	89.9	10.25	104.4	11.92	121.2	14.71	150.3	18.59	179.9	21.62
	27	65.1	9.59	83.6	12.23	109.7	15.91	123.8	17.72	139.9	21.46	167.6	25.02	195.1	28.29
	29	82.8	12.95	103.3	16.80	129.6	22.16	143.3	24.50	158.6	28.32	184.9	32.13	210.2	37.45
	31	100.4	16.21	123.0	21.57	149.4	27.74	162.7	31.26	177.3	35.29	202.2	37.41	225.4	43.51
	33	118.1	20.87	142.7	26.55	169.3	33.63	182.2	37.07	196.0	41.02	219.5	44.33	240.7	48.60
	35	136.0	25.84	162.4	32.67	188.8	40.39	201.6	44.55	214.4	48.44	236.7	51.96	240.7	53.15
	37	136.0	27.42	162.4	34.75	188.8	43.07	201.6	47.33	214.4	51.13	232.8	54.32	236.9	55.54
	39	136.0	29.03	162.4	36.96	188.8	45.58	201.6	50.36	214.4	53.77	229.0	57.27	233.1	57.96
41	132.5	32.49	158.2	40.98	184.0	50.03	196.4	55.08	208.9	58.05	219.5	60.35	223.4	61.73	
43	129.2	35.07	154.3	44.28	179.4	54.65	191.6	59.32	203.7	62.24	210.4	64.47	214.3	65.41	
46	121.1	39.47	144.6	50.43	168.1	62.27	179.5	67.25	185.1	69.15	192.1	69.52	195.7	70.18	
48	107.1	34.50	127.9	44.11	148.7	54.48	158.8	58.64	160.8	58.83	166.9	58.96	170.1	59.44	
80	10	18.8	2.07	25.7	2.59	34.2	3.25	48.3	3.74	63.7	4.81	91.6	6.34	121.5	8.30
	12	18.8	2.10	25.7	2.62	34.2	3.29	48.3	3.78	63.7	4.86	91.6	6.41	121.5	8.39
	14	18.8	2.12	25.7	2.64	34.2	3.32	48.3	3.82	63.7	4.91	91.6	6.47	121.5	8.48
	16	18.8	2.14	25.7	2.67	34.2	3.36	48.3	3.86	63.7	4.96	91.6	6.54	121.5	8.56
	18	18.8	2.16	25.7	2.70	34.2	3.39	48.3	3.90	63.7	5.01	91.6	6.61	121.5	8.65
	20	18.8	2.18	25.7	2.73	34.2	3.43	48.3	3.94	63.7	5.06	91.6	6.67	121.5	8.74
	21	18.8	2.20	25.7	2.80	43.0	4.32	57.6	4.72	72.1	6.07	99.6	7.34	129.2	9.61
	23	33.4	4.05	42.6	4.82	60.7	6.12	76.3	6.79	89.2	8.92	116.0	10.87	144.3	13.22
	25	47.9	5.87	59.5	7.73	78.4	9.06	94.9	10.73	106.2	13.01	132.3	16.44	159.5	19.11
	27	62.5	8.63	76.4	11.01	96.1	14.06	113.5	15.95	123.2	18.97	148.7	22.12	174.6	25.01
	29	77.1	11.19	93.3	15.12	113.7	19.59	132.2	22.05	140.2	25.04	165.0	28.40	189.8	33.10
	31	91.6	13.71	110.1	19.03	131.4	24.53	150.8	28.14	160.4	30.35	181.4	32.74	204.9	38.08
	33	106.2	18.03	127.0	23.41	149.1	28.83	169.6	33.37	179.5	34.87	197.7	38.79	220.1	42.87
	35	120.8	23.60	144.0	29.58	167.2	36.29	179.2	39.85	191.2	43.63	214.4	49.50	235.1	51.56
	37	120.8	24.96	144.0	31.44	167.2	38.49	179.2	42.37	191.2	46.36	214.4	52.24	231.3	54.16
	39	120.8	26.38	144.0	33.25	167.2	41.18	179.2	45.55	191.2	49.82	214.4	55.20	227.5	57.13
41	117.7	29.18	140.3	36.84	162.9	45.19	174.6	49.93	186.3	54.74	208.9	59.14	217.9	60.50	
43	114.8	32.13	136.8	40.20	158.9	49.33	170.3	54.42	181.7	59.82	203.7	63.18	208.9	64.75	
46	107.6	35.74	128.2	45.28	148.9	55.58	159.6	60.57	170.3	67.50	186.3	69.52	190.7	70.18	
48	95.2	31.21	113.4	39.60	131.7	48.61	141.2	52.91	150.6	58.83	161.8	58.96	165.7	59.44	

# 7. Capacity Tables

Cooling Capacity (80HP)

Combination (%)	Outdoor air temp. (DB, °C)	Indoor air temp. (DB/WB, °C)													
		20		23		26		27		28		30		32	
		14		16		18		19		20		22		24	
		TC	PI	TC	PI	TC	PI	TC	PI	TC	PI	TC	PI	TC	PI
70	10	16.4	1.83	22.3	2.29	29.8	2.88	42.0	3.33	55.4	4.25	79.7	5.60	105.8	7.34
	12	16.4	1.85	22.3	2.31	29.8	2.91	42.0	3.37	55.4	4.29	79.7	5.66	105.8	7.42
	14	16.4	1.87	22.3	2.34	29.8	2.94	42.0	3.40	55.4	4.34	79.7	5.72	105.8	7.49
	16	16.4	1.89	22.3	2.36	29.8	2.97	42.0	3.44	55.4	4.38	79.7	5.78	105.8	7.57
	18	16.4	1.91	22.3	2.39	29.8	3.00	42.0	3.47	55.4	4.43	79.7	5.84	105.8	7.65
	20	16.4	1.93	22.3	2.41	29.8	3.03	42.0	3.51	55.4	4.47	79.7	5.90	105.8	7.72
	21	16.4	1.94	26.0	2.83	38.7	3.97	52.0	4.40	64.0	5.37	87.9	6.49	113.8	8.50
	23	23.5	2.92	40.3	4.63	54.0	5.81	70.0	6.31	81.2	7.89	104.4	9.61	129.6	11.69
	25	37.2	4.81	54.6	6.83	69.4	8.01	88.0	9.98	98.4	11.50	121.0	14.53	145.4	16.89
	27	50.9	7.02	68.9	9.73	84.8	11.81	106.0	14.83	115.6	16.77	137.5	19.56	161.1	22.11
	29	64.6	8.90	83.2	12.85	100.1	16.06	124.0	20.17	132.8	22.13	154.0	25.11	176.9	29.26
	31	78.3	10.95	97.5	15.98	115.5	20.11	142.0	25.35	150.0	26.83	170.6	28.94	192.7	33.66
	33	92.0	14.73	111.8	19.43	130.9	23.35	156.8	29.43	167.2	30.82	187.2	34.29	208.0	37.90
	35	105.6	20.16	126.4	25.13	146.4	30.40	156.8	33.25	167.2	36.31	187.2	42.75	208.0	46.87
	37	105.6	21.43	126.4	26.61	146.4	32.30	156.8	35.36	167.2	38.63	187.2	45.49	208.0	49.46
	39	105.6	22.75	126.4	28.37	146.4	34.53	156.8	38.04	167.2	41.73	187.2	48.69	208.0	53.33
41	102.9	25.16	123.2	31.08	142.7	37.88	152.8	41.73	162.9	45.37	182.4	53.48	202.7	57.48	
43	100.4	27.38	120.1	33.88	139.1	41.33	149.0	45.50	158.9	49.54	177.9	58.42	197.7	62.16	
46	94.0	30.43	112.6	38.09	130.4	46.55	139.6	50.68	148.9	55.84	166.7	65.89	185.2	69.32	
48	83.2	26.55	99.6	33.27	115.3	40.69	123.5	44.29	131.7	48.85	147.5	57.66	163.9	59.44	
60	10	14.4	1.59	19.3	1.98	25.8	2.49	36.4	2.91	47.9	3.68	69.0	4.86	91.5	6.36
	12	14.4	1.61	19.3	2.00	25.8	2.52	36.4	2.94	47.9	3.72	69.0	4.91	91.5	6.42
	14	14.4	1.62	19.3	2.03	25.8	2.55	36.4	2.97	47.9	3.76	69.0	4.96	91.5	6.49
	16	14.4	1.64	19.3	2.05	25.8	2.57	36.4	3.00	47.9	3.80	69.0	5.01	91.5	6.56
	18	14.4	1.66	19.3	2.07	25.8	2.60	36.4	3.03	47.9	3.84	69.0	5.06	91.5	6.63
	20	14.4	1.67	19.3	2.09	25.8	2.62	36.4	3.06	47.9	3.87	69.0	5.11	91.5	6.69
	21	14.4	1.68	19.3	2.16	32.3	3.37	42.7	3.71	55.0	4.65	75.0	5.62	97.4	7.36
	23	14.4	1.86	32.0	3.92	45.6	5.04	59.2	5.38	69.3	6.83	87.2	8.33	109.0	10.13
	25	26.8	3.54	44.7	5.92	58.9	6.94	76.2	9.19	83.6	9.96	101.4	12.34	120.5	14.64
	27	39.5	5.16	57.4	8.43	72.2	10.23	92.0	12.79	97.8	14.30	113.9	16.34	132.1	18.85
	29	52.2	6.70	70.0	10.80	85.5	13.64	108.6	16.81	112.1	18.22	126.3	20.50	143.6	24.09
	31	64.9	8.52	82.7	12.91	98.8	16.61	121.9	20.17	126.4	21.17	141.5	22.69	155.2	27.76
	33	77.5	11.86	95.4	15.70	112.1	18.65	131.4	22.61	140.9	24.22	152.8	26.89	166.7	31.62
	35	90.4	17.10	108.0	20.92	125.6	25.07	134.4	27.30	143.2	29.63	160.8	34.63	178.4	39.94
	37	90.4	18.06	108.0	22.08	125.6	26.55	134.4	29.00	143.2	31.44	160.8	36.75	178.4	42.49
	39	90.4	19.20	108.0	23.51	125.6	28.66	134.4	31.11	143.2	33.84	160.8	39.41	178.4	45.53
41	88.1	20.83	105.2	25.73	122.4	31.13	131.0	33.99	139.5	36.73	156.7	43.25	173.8	49.47	
43	85.9	22.63	102.6	28.01	119.4	33.93	127.7	37.03	136.1	40.05	152.8	47.21	169.5	54.04	
46	80.5	25.35	96.2	31.45	111.9	38.16	119.7	41.63	127.5	45.07	143.2	53.19	158.9	61.57	
48	71.2	22.09	85.1	27.45	99.0	33.34	105.9	36.36	112.8	39.38	126.7	46.52	140.5	53.87	
50	10	13.0	1.38	17.7	1.72	24.9	2.16	33.2	2.65	43.8	3.19	63.1	4.21	83.7	5.49
	12	13.0	1.39	17.7	1.74	24.9	2.19	33.2	2.68	43.8	3.23	63.1	4.26	83.7	5.55
	14	13.0	1.41	17.7	1.76	24.9	2.21	33.2	2.71	43.8	3.26	63.1	4.30	83.7	5.61
	16	13.0	1.42	17.7	1.78	24.9	2.23	33.2	2.74	43.8	3.30	63.1	4.35	83.7	5.67
	18	13.0	1.44	17.7	1.79	24.9	2.25	33.2	2.77	43.8	3.33	63.1	4.39	83.7	5.72
	20	13.0	1.45	17.7	1.81	24.9	2.28	33.2	2.79	43.8	3.36	63.1	4.44	83.7	5.78
	21	13.0	1.46	17.7	1.88	31.0	2.92	39.2	3.35	49.8	4.04	68.5	4.88	88.2	6.36
	23	13.0	1.55	28.0	3.20	42.9	4.37	55.4	5.23	63.1	5.93	78.8	7.23	97.3	8.75
	25	23.3	2.83	38.4	4.71	54.9	6.13	73.3	8.48	77.5	8.65	89.2	10.17	106.5	12.36
	27	33.7	4.06	48.8	6.62	68.0	8.54	84.9	11.30	90.1	11.65	99.6	13.32	115.6	15.73
	29	44.1	5.33	59.2	8.54	78.8	10.98	95.5	14.03	102.7	15.03	110.0	16.50	124.7	19.87
	31	54.6	6.77	69.6	10.14	89.6	13.37	103.9	15.64	110.0	16.63	120.2	17.82	133.9	21.86
	33	65.0	9.43	80.0	12.21	100.5	15.02	108.0	17.14	114.6	18.37	130.1	21.12	142.8	24.53
	35	75.6	14.22	90.4	17.10	104.8	20.20	112.0	21.91	119.2	23.62	133.6	27.26	148.8	31.32
	37	75.6	15.07	90.4	18.06	104.8	21.38	112.0	23.19	119.2	25.01	133.6	29.07	148.8	33.24
	39	75.6	16.08	90.4	19.36	104.8	22.91	112.0	24.97	119.2	26.84	133.6	30.97	148.8	35.90
41	73.7	17.38	88.1	20.96	102.1	25.05	109.1	27.04	116.1	29.08	130.2	33.94	145.0	38.99	
43	71.8	18.89	85.9	22.80	99.6	27.25	106.4	29.44	113.3	31.66	127.0	37.02	141.4	42.53	
46	67.3	21.16	80.5	25.57	93.3	30.57	99.7	33.06	106.2	35.54	119.0	41.65	132.5	47.88	
48	59.6	18.44	71.2	22.30	82.6	26.66	88.2	28.86	93.9	31.02	105.3	36.39	117.2	41.86	

**Note**

1. TC: Total Capacity(kW), PI : Power Input(kW, Comp. + Outdoor fan motor)
2. Capacity tables show the average value of conditions which may occur.

# 7. Capacity Tables

◆ ARUM820LTE5

Cooling Capacity (82HP)

Combination (%)	Outdoor air temp. (DB, °C)	Indoor air temp. (DB/WB, °C)													
		20		23		26		27		28		30		32	
		14	16	18	19	20	22	24	TC	PI	TC	PI	TC	PI	
130	10	32.3	3.34	44.1	4.18	58.8	5.08	82.9	6.20	109.3	7.75	157.4	10.33	208.7	13.68
	12	32.3	3.38	44.1	4.22	58.8	5.13	82.9	6.26	109.3	7.83	157.4	10.44	208.7	13.82
	14	32.3	3.41	44.1	4.26	58.8	5.19	82.9	6.33	109.3	7.91	157.4	10.55	208.7	13.97
	16	32.3	3.45	44.1	4.31	58.8	5.24	82.9	6.39	109.3	7.99	157.4	10.66	208.7	14.11
	18	32.3	3.48	44.1	4.35	58.8	5.29	82.9	6.46	109.3	8.07	157.4	10.77	208.7	14.25
	20	32.3	3.52	44.1	4.39	58.8	5.35	82.9	6.52	109.3	8.15	157.4	10.87	208.7	14.40
	21	32.3	3.55	44.8	4.53	72.8	6.68	96.7	7.77	122.2	10.02	167.6	13.67	215.3	16.20
	23	56.2	6.31	78.2	8.30	101.1	9.46	126.3	10.52	148.0	15.08	188.3	19.50	228.7	22.97
	25	83.0	10.00	100.6	12.45	129.5	14.14	157.5	16.67	173.7	21.67	209.1	28.34	242.1	33.34
	27	108.3	15.94	128.5	18.82	157.9	21.36	187.1	25.54	199.5	32.41	229.8	40.87	255.5	46.05
	29	133.7	22.13	156.5	25.96	186.3	31.36	217.4	36.93	225.3	44.02	250.8	52.84	269.0	58.80
	31	162.2	28.91	188.1	35.67	218.9	43.27	244.8	50.52	251.0	57.61	264.9	72.37	283.0	73.40
	33	190.8	35.63	223.0	46.55	250.4	55.69	264.6	72.31	270.3	71.80	278.7	72.44	297.6	73.46
	35	227.4	48.14	260.6	58.34	268.9	70.80	273.6	71.15	278.0	71.58	285.6	72.22	293.9	72.50
	37	227.4	51.33	256.9	61.23	265.3	69.86	268.9	70.21	273.6	70.63	281.0	71.27	289.4	71.55
	39	227.4	54.66	252.4	64.45	260.6	68.93	265.3	69.27	268.9	69.69	277.3	70.31	285.6	70.59
41	221.6	57.99	241.9	67.67	250.1	67.99	253.8	68.33	258.8	68.74	266.6	69.36	273.8	69.63	
43	216.1	61.15	231.8	66.72	239.9	67.06	243.5	67.39	248.4	67.80	256.0	68.40	263.0	68.67	
46	202.5	65.46	211.5	65.32	219.1	65.65	222.6	65.98	227.2	66.38	234.4	66.97	240.8	67.24	
48	179.2	63.63	183.7	63.82	190.5	63.96	193.6	64.13	197.7	64.69	204.0	65.10	209.7	65.35	
120	10	29.8	3.13	40.7	3.91	54.2	4.75	76.5	5.80	100.8	7.25	145.2	9.66	192.5	12.80
	12	29.8	3.16	40.7	3.95	54.2	4.80	76.5	5.86	100.8	7.32	145.2	9.77	192.5	12.93
	14	29.8	3.19	40.7	3.99	54.2	4.85	76.5	5.92	100.8	7.40	145.2	9.87	192.5	13.06
	16	29.8	3.23	40.7	4.03	54.2	4.90	76.5	5.98	100.8	7.48	145.2	9.97	192.5	13.20
	18	29.8	3.26	40.7	4.07	54.2	4.95	76.5	6.04	100.8	7.55	145.2	10.07	192.5	13.33
	20	29.8	3.29	40.7	4.11	54.2	5.00	76.5	6.10	100.8	7.63	145.2	10.17	192.5	13.47
	21	29.8	3.33	41.3	4.24	68.7	6.37	89.1	7.27	114.0	9.37	155.4	12.79	199.5	15.16
	23	51.7	5.90	74.2	7.89	97.6	9.07	116.3	9.84	141.0	14.11	176.7	18.24	213.3	21.49
	25	80.6	9.36	104.1	11.83	127.8	13.23	145.1	15.59	169.1	20.27	199.3	26.51	227.1	31.19
	27	112.0	14.79	141.6	17.60	158.5	19.82	172.3	23.70	197.1	30.08	221.9	37.93	241.0	43.43
	29	143.7	20.53	170.5	23.71	189.0	29.10	200.3	34.27	225.2	40.85	244.6	49.03	254.9	55.13
	31	174.0	26.00	205.4	31.34	219.7	38.61	230.6	45.43	254.1	51.81	261.1	62.31	269.9	63.47
	33	201.7	32.04	242.2	40.90	256.6	49.70	260.2	57.64	264.7	67.81	271.9	68.59	280.4	69.14
	35	205.8	42.81	244.7	55.46	259.2	61.34	262.8	73.06	267.4	73.43	274.7	73.65	281.8	74.23
	37	205.8	46.05	244.7	58.52	255.5	65.40	259.2	71.53	262.8	71.88	270.1	72.10	277.4	72.67
	39	205.8	49.57	243.8	61.85	251.1	69.37	254.7	70.06	258.3	70.41	266.5	70.62	273.7	71.18
41	200.5	53.10	233.2	65.18	241.0	68.00	244.5	68.59	248.0	68.93	255.2	69.14	262.5	69.69	
43	195.6	56.68	223.4	64.24	231.1	66.47	234.5	67.12	237.9	67.45	245.0	67.66	252.0	68.19	
46	183.3	60.94	203.7	62.71	211.1	64.39	214.2	64.91	217.5	65.24	224.0	65.43	230.7	65.95	
48	162.1	59.70	176.9	61.60	183.5	63.13	186.2	63.51	189.1	63.72	194.9	63.97	200.8	64.23	
110	10	27.3	2.94	37.2	3.67	49.7	4.47	70.1	5.45	92.4	6.81	133.0	9.08	176.3	12.02
	12	27.3	2.97	37.2	3.71	49.7	4.51	70.1	5.50	92.4	6.88	133.0	9.18	176.3	12.15
	14	27.3	3.00	37.2	3.75	49.7	4.56	70.1	5.56	92.4	6.95	133.0	9.27	176.3	12.28
	16	27.3	3.03	37.2	3.79	49.7	4.61	70.1	5.62	92.4	7.02	133.0	9.37	176.3	12.40
	18	27.3	3.06	37.2	3.82	49.7	4.65	70.1	5.68	92.4	7.10	133.0	9.46	176.3	12.53
	20	27.3	3.09	37.2	3.86	49.7	4.70	70.1	5.73	92.4	7.17	133.0	9.56	176.3	12.66
	21	27.3	3.12	37.2	3.98	62.2	5.87	82.3	6.83	102.8	8.80	143.6	12.01	185.4	14.24
	23	48.9	5.55	62.2	7.41	87.2	8.31	107.4	9.24	130.2	13.25	163.1	17.14	201.5	20.19
	25	70.4	8.79	87.1	11.12	112.1	12.43	132.7	14.65	154.6	19.05	182.3	24.91	217.2	29.31
	27	91.9	13.90	112.1	16.54	137.0	18.62	157.6	22.27	180.3	28.27	203.0	35.64	234.9	40.81
	29	113.4	19.29	137.0	22.28	162.0	27.35	183.2	32.21	205.9	38.38	223.7	45.15	247.8	50.08
	31	137.5	24.43	165.2	29.45	190.6	36.28	208.8	42.69	231.6	48.68	244.3	52.21	256.9	56.20
	33	159.5	30.11	190.6	38.44	216.1	46.70	235.5	52.18	250.3	58.56	258.1	60.17	264.7	60.26
	35	184.3	37.93	219.8	48.80	245.5	55.64	252.5	59.61	256.1	63.27	262.3	63.86	269.4	64.17
	37	184.3	40.20	219.8	51.79	245.5	58.74	249.0	63.15	251.7	66.73	258.8	66.97	265.0	67.15
	39	184.3	43.34	219.8	55.04	241.0	61.97	244.5	67.55	248.2	70.04	254.3	70.16	261.5	70.23
41	179.6	46.48	214.1	58.28	230.7	65.35	234.3	73.06	237.4	73.06	244.3	73.65	250.4	74.23	
43	175.2	48.81	208.8	60.72	221.1	69.30	224.7	70.09	227.6	69.93	234.4	70.33	240.4	70.52	
46	164.2	47.64	195.7	58.62	201.7	65.77	205.3	65.77	207.9	66.34	214.3	66.71	219.8	66.89	
48	145.2	46.27	170.1	56.47	175.2	62.58	178.4	63.00	180.7	63.30	186.4	63.48	191.3	63.73	

# 7. Capacity Tables

Cooling Capacity (82HP)

Combination (%)	Outdoor air temp. (DB, °C)	Indoor air temp. (DB/WB, °C)													
		20		23		26		27		28		30		32	
		14		16		18		19		20		22		24	
		TC	PI	TC	PI	TC	PI	TC	PI	TC	PI	TC	PI	TC	PI
100	10	25.1	2.70	34.2	3.37	45.6	4.10	64.3	5.00	84.7	6.25	122.0	8.33	161.8	11.03
	12	25.1	2.72	34.2	3.40	45.6	4.14	64.3	5.05	84.7	6.31	122.0	8.42	161.8	11.15
	14	25.1	2.75	34.2	3.44	45.6	4.18	64.3	5.10	84.7	6.38	122.0	8.51	161.8	11.26
	16	25.1	2.78	34.2	3.47	45.6	4.23	64.3	5.16	84.7	6.44	122.0	8.59	161.8	11.38
	18	25.1	2.81	34.2	3.51	45.6	4.27	64.3	5.21	84.7	6.51	122.0	8.68	161.8	11.49
	20	25.1	2.84	34.2	3.54	45.6	4.31	64.3	5.26	84.7	6.58	122.0	8.77	161.8	11.61
	21	25.1	2.87	34.2	3.65	56.8	5.39	75.5	6.26	96.6	8.08	131.7	11.02	170.1	13.07
	23	43.4	5.09	59.9	6.80	79.3	7.63	99.4	8.48	120.5	12.16	151.0	15.73	186.6	18.52
	25	62.0	8.07	80.7	10.20	101.9	11.40	124.0	13.44	144.5	17.48	170.4	22.85	203.0	26.89
	27	80.5	12.75	101.6	15.18	124.5	17.09	147.3	20.43	168.5	25.93	189.7	32.69	219.5	37.44
	29	99.1	17.70	122.4	20.44	147.1	25.09	171.2	29.55	192.5	35.22	209.0	42.27	236.0	45.94
	31	117.6	22.41	143.2	27.02	169.7	33.29	195.2	39.16	216.4	44.66	228.4	48.87	254.4	52.08
	33	136.2	27.62	164.1	35.26	192.3	42.84	219.1	49.69	240.6	54.26	248.1	55.21	254.4	56.41
	35	155.0	33.27	184.5	42.48	214.8	52.79	229.6	58.45	240.6	58.80	248.1	59.03	254.4	59.50
	37	155.0	35.63	184.5	45.56	214.8	55.92	229.6	61.23	236.7	61.53	243.5	61.78	249.3	62.35
	39	155.0	38.20	184.5	48.94	214.8	59.26	229.6	64.23	232.7	64.51	239.6	64.75	245.2	65.35
	41	152.5	40.77	181.6	52.33	211.4	62.60	220.3	67.22	225.1	67.49	230.4	67.72	237.9	68.36
	43	147.3	43.15	175.3	55.47	204.2	65.59	211.2	69.79	213.7	70.04	220.3	70.27	226.0	70.93
46	138.0	46.42	164.3	59.80	191.3	69.57	192.9	73.06	194.9	73.28	201.2	73.49	206.6	74.19	
48	122.1	40.08	145.4	51.74	165.2	59.47	167.6	61.99	169.3	62.19	174.9	62.33	179.7	62.83	
90	10	22.5	2.48	30.7	3.10	41.0	3.89	56.7	4.45	76.3	5.75	109.8	7.58	145.6	9.93
	12	22.5	2.51	30.7	3.13	41.0	3.93	56.7	4.49	76.3	5.81	109.8	7.66	145.6	10.03
	14	22.5	2.53	30.7	3.16	41.0	3.97	56.7	4.54	76.3	5.87	109.8	7.74	145.6	10.14
	16	22.5	2.56	30.7	3.20	41.0	4.01	56.7	4.59	76.3	5.93	109.8	7.82	145.6	10.24
	18	22.5	2.59	30.7	3.23	41.0	4.06	56.7	4.64	76.3	5.99	109.8	7.90	145.6	10.35
	20	22.5	2.61	30.7	3.26	41.0	4.10	56.7	4.68	76.3	6.05	109.8	7.98	145.6	10.45
	21	22.5	2.64	30.7	3.29	51.4	5.16	67.1	5.55	86.0	7.26	118.6	8.78	153.2	11.49
	23	30.6	4.08	45.2	5.66	71.8	7.32	87.1	7.97	105.1	10.67	136.3	13.00	168.8	15.81
	25	48.7	6.90	65.4	9.08	92.1	10.83	107.0	12.60	124.3	15.55	154.1	19.65	184.4	22.85
	27	66.8	10.14	85.6	12.93	112.5	16.81	126.9	18.73	143.4	22.69	171.8	26.46	199.9	29.90
	29	84.9	13.69	105.8	17.76	132.8	23.43	146.9	25.90	162.6	29.94	189.5	33.97	215.5	39.59
	31	103.0	17.13	126.1	22.80	153.1	29.33	166.8	33.05	181.7	37.30	207.2	39.54	231.1	46.00
	33	121.0	22.06	146.3	28.06	173.5	35.55	186.7	39.19	200.9	43.36	225.0	46.86	246.7	51.38
	35	139.4	27.32	166.5	34.54	193.5	42.70	206.6	47.10	219.8	51.21	242.6	54.93	246.7	56.19
	37	139.4	28.99	166.5	36.74	193.5	45.53	206.6	50.03	219.8	54.05	238.7	57.42	242.8	58.71
	39	139.4	30.69	166.5	39.07	193.5	48.19	206.6	53.24	219.8	56.84	234.8	60.54	238.9	61.27
	41	135.8	34.35	162.2	43.32	188.6	52.89	201.4	58.22	214.1	61.36	225.0	63.80	229.0	65.26
	43	132.5	37.07	158.2	46.81	183.9	57.77	196.4	62.71	208.8	65.80	215.7	68.16	219.6	69.15
46	124.1	41.73	148.2	53.31	172.3	65.82	184.0	71.09	189.8	73.10	196.9	73.49	200.6	74.19	
48	109.8	36.47	131.1	46.63	152.5	57.59	162.8	61.99	164.8	62.19	171.1	62.33	174.4	62.83	
80	10	19.3	2.19	26.3	2.74	35.1	3.44	49.5	3.96	65.2	5.08	93.9	6.70	124.6	8.78
	12	19.3	2.22	26.3	2.77	35.1	3.48	49.5	4.00	65.2	5.13	93.9	6.77	124.6	8.87
	14	19.3	2.24	26.3	2.80	35.1	3.51	49.5	4.04	65.2	5.19	93.9	6.84	124.6	8.96
	16	19.3	2.26	26.3	2.82	35.1	3.55	49.5	4.08	65.2	5.24	93.9	6.91	124.6	9.05
	18	19.3	2.29	26.3	2.85	35.1	3.59	49.5	4.13	65.2	5.29	93.9	6.98	124.6	9.15
	20	19.3	2.31	26.3	2.88	35.1	3.62	49.5	4.17	65.2	5.35	93.9	7.05	124.6	9.24
	21	19.3	2.32	26.3	2.96	44.0	4.56	59.1	4.99	73.9	6.42	102.1	7.76	132.4	10.16
	23	34.2	4.28	43.6	5.09	62.2	6.47	78.2	7.18	91.4	9.43	118.9	11.50	148.0	13.98
	25	49.1	6.21	61.0	8.17	80.3	9.58	97.3	11.34	108.8	13.75	135.6	17.37	163.5	20.20
	27	64.1	9.12	78.3	11.63	98.5	14.86	116.4	16.86	126.3	20.05	152.4	23.39	179.0	26.44
	29	79.0	11.83	95.6	15.98	116.6	20.71	135.5	23.31	143.7	26.47	169.2	30.03	194.5	34.99
	31	93.9	14.49	112.9	20.11	134.7	25.93	154.6	29.74	164.4	32.08	185.9	34.61	210.0	40.26
	33	108.8	19.06	130.2	24.75	152.9	30.48	173.8	35.27	184.0	36.86	202.7	41.01	225.6	45.32
	35	123.8	24.95	147.6	31.27	171.4	38.36	183.7	42.13	196.0	46.12	219.8	52.33	241.0	54.51
	37	123.8	26.39	147.6	33.24	171.4	40.69	183.7	44.79	196.0	49.01	219.8	55.23	237.1	57.25
	39	123.8	27.89	147.6	35.15	171.4	43.53	183.7	48.16	196.0	52.67	219.8	58.35	233.2	60.40
	41	120.7	30.85	143.8	38.95	167.0	47.77	179.0	52.79	191.0	57.87	214.1	62.53	223.4	63.96
	43	117.7	33.96	140.3	42.50	162.9	52.15	174.6	57.53	186.2	63.24	208.8	66.80	214.2	68.46
46	110.3	37.78	131.5	47.87	152.6	58.76	163.6	64.03	174.5	71.36	191.0	73.49	195.5	74.19	
48	97.5	33.00	116.3	41.86	135.0	51.39	144.7	55.93	154.4	62.19	165.9	62.33	169.9	62.83	

# 7. Capacity Tables

Cooling Capacity (82HP)

Combination (%)	Outdoor air temp. (DB, °C)	Indoor air temp. (DB/WB, °C)													
		20		23		26		27		28		30		32	
		14		16		18		19		20		22		24	
		TC	PI	TC	PI	TC	PI	TC	PI	TC	PI	TC	PI	TC	PI
70	10	16.8	1.94	22.9	2.42	30.5	3.04	43.1	3.52	56.8	4.49	81.7	5.92	108.4	7.76
	12	16.8	1.96	22.9	2.45	30.5	3.07	43.1	3.56	56.8	4.54	81.7	5.99	108.4	7.84
	14	16.8	1.98	22.9	2.47	30.5	3.11	43.1	3.60	56.8	4.59	81.7	6.05	108.4	7.92
	16	16.8	2.00	22.9	2.50	30.5	3.14	43.1	3.63	56.8	4.63	81.7	6.11	108.4	8.00
	18	16.8	2.02	22.9	2.52	30.5	3.17	43.1	3.67	56.8	4.68	81.7	6.17	108.4	8.08
	20	16.8	2.04	22.9	2.55	30.5	3.20	43.1	3.71	56.8	4.73	81.7	6.24	108.4	8.17
	21	16.8	2.05	26.7	2.99	39.6	4.20	53.3	4.65	65.6	5.67	90.1	6.86	116.7	8.98
	23	24.1	3.08	41.3	4.89	55.4	6.15	71.8	6.67	83.2	8.34	107.0	10.16	132.8	12.36
	25	38.1	5.09	56.0	7.22	71.1	8.47	90.2	10.55	100.9	12.15	124.0	15.36	149.0	17.86
	27	52.2	7.42	70.6	10.28	86.9	12.49	108.7	15.68	118.5	17.73	140.9	20.67	165.2	23.37
	29	66.2	9.41	85.3	13.58	102.6	16.98	127.1	21.33	136.1	23.40	157.9	26.54	181.3	30.93
	31	80.3	11.58	99.9	16.89	118.4	21.26	145.6	26.80	153.8	28.36	174.8	30.59	197.5	35.59
	33	94.3	15.57	114.6	20.54	134.1	24.69	160.7	31.11	171.4	32.58	191.9	36.25	213.2	40.06
	35	108.2	21.31	129.6	26.57	150.1	32.14	160.7	35.15	171.4	38.38	191.9	45.19	213.2	49.55
	37	108.2	22.65	129.6	28.13	150.1	34.14	160.7	37.38	171.4	40.84	191.9	48.09	213.2	52.29
	39	108.2	24.05	129.6	29.99	150.1	36.51	160.7	40.22	171.4	44.12	191.9	51.47	213.2	56.37
	41	105.5	26.59	126.2	32.86	146.2	40.05	156.6	44.11	167.0	47.96	187.0	56.53	207.7	60.76
43	102.9	28.95	123.1	35.81	142.6	43.70	152.7	48.10	162.9	52.37	182.3	61.76	202.6	65.72	
46	96.4	32.17	115.4	40.27	133.6	49.21	143.1	53.58	152.6	59.04	170.9	69.65	189.9	73.29	
48	85.3	28.07	102.1	35.17	118.2	43.02	126.6	46.82	135.0	51.65	151.2	60.95	168.0	62.83	
60	10	14.8	1.65	19.8	2.06	26.4	2.59	37.3	3.03	49.1	3.83	70.7	5.05	93.8	6.62
	12	14.8	1.67	19.8	2.09	26.4	2.62	37.3	3.06	49.1	3.87	70.7	5.11	93.8	6.69
	14	14.8	1.69	19.8	2.11	26.4	2.65	37.3	3.09	49.1	3.91	70.7	5.16	93.8	6.76
	16	14.8	1.71	19.8	2.13	26.4	2.68	37.3	3.12	49.1	3.95	70.7	5.21	93.8	6.83
	18	14.8	1.72	19.8	2.15	26.4	2.70	37.3	3.15	49.1	3.99	70.7	5.27	93.8	6.89
	20	14.8	1.74	19.8	2.17	26.4	2.73	37.3	3.18	49.1	4.03	70.7	5.32	93.8	6.96
	21	14.8	1.75	19.8	2.25	33.1	3.50	43.8	3.86	56.3	4.84	76.8	5.85	99.8	7.66
	23	14.8	1.93	32.8	4.08	46.7	5.24	60.7	5.60	71.0	7.11	89.4	8.67	111.7	10.54
	25	27.5	3.68	45.8	6.16	60.3	7.22	78.1	9.56	85.6	10.37	103.9	12.84	123.5	15.23
	27	40.5	5.37	58.8	8.77	74.0	10.65	94.3	13.31	100.3	14.88	116.7	17.01	135.4	19.61
	29	53.5	6.97	71.8	11.24	87.6	14.19	111.3	17.49	114.9	18.96	129.5	21.33	147.2	25.07
	31	66.5	8.87	84.8	13.44	101.3	17.29	124.9	20.99	129.6	22.03	145.1	23.61	159.1	28.89
	33	79.5	12.34	97.8	16.34	114.9	19.41	134.7	23.53	144.4	25.21	156.6	27.98	170.9	32.91
	35	92.7	18.08	110.7	22.12	128.7	26.50	137.8	28.86	146.8	31.33	164.8	36.61	182.9	42.22
	37	92.7	19.09	110.7	23.35	128.7	28.07	137.8	30.65	146.8	33.24	164.8	38.85	182.9	44.92
	39	92.7	20.30	110.7	24.86	128.7	30.30	137.8	32.89	146.8	35.77	164.8	41.66	182.9	48.13
	41	90.3	22.02	107.9	27.20	125.4	32.90	134.2	35.93	143.0	38.83	160.6	45.72	178.2	52.30
43	88.1	23.93	105.2	29.61	122.3	35.87	130.9	39.15	139.5	42.34	156.6	49.91	173.8	57.13	
46	82.5	26.80	98.6	33.25	114.7	40.35	122.7	44.01	130.7	47.64	146.8	56.23	162.9	65.09	
48	73.0	23.35	87.2	29.02	101.4	35.25	108.5	38.44	115.6	41.63	129.8	49.18	144.1	56.95	
50	10	13.3	1.41	18.1	1.76	25.5	2.21	34.1	2.72	44.9	3.27	64.6	4.31	85.7	5.62
	12	13.3	1.43	18.1	1.78	25.5	2.24	34.1	2.74	44.9	3.30	64.6	4.36	85.7	5.68
	14	13.3	1.44	18.1	1.80	25.5	2.26	34.1	2.77	44.9	3.34	64.6	4.40	85.7	5.74
	16	13.3	1.46	18.1	1.82	25.5	2.28	34.1	2.80	44.9	3.37	64.6	4.45	85.7	5.80
	18	13.3	1.47	18.1	1.84	25.5	2.31	34.1	2.83	44.9	3.41	64.6	4.49	85.7	5.86
	20	13.3	1.48	18.1	1.85	25.5	2.33	34.1	2.86	44.9	3.44	64.6	4.54	85.7	5.92
	21	13.3	1.49	18.1	1.92	31.7	2.99	40.2	3.43	51.1	4.13	70.2	4.99	90.4	6.51
	23	13.3	1.59	28.7	3.27	44.0	4.47	56.8	5.35	64.6	6.07	80.8	7.39	99.8	8.95
	25	23.8	2.90	39.4	4.82	56.3	6.27	75.1	8.68	79.5	8.84	91.5	10.41	109.1	12.64
	27	34.5	4.15	50.0	6.77	69.7	8.74	87.0	11.56	92.4	11.92	102.1	13.62	118.5	16.09
	29	45.2	5.45	60.7	8.73	80.8	11.23	97.9	14.35	105.3	15.37	112.8	16.88	127.9	20.32
	31	55.9	6.93	71.3	10.38	91.9	13.68	106.5	16.00	112.7	17.01	123.2	18.23	137.2	22.36
	33	66.6	9.65	82.0	12.49	103.0	15.36	110.7	17.54	117.5	18.79	133.3	21.60	146.4	25.09
	35	77.5	15.03	92.7	18.08	107.4	21.36	114.8	23.16	122.2	24.97	136.9	28.81	152.5	33.11
	37	77.5	15.93	92.7	19.10	107.4	22.60	114.8	24.52	122.2	26.44	136.9	30.73	152.5	35.14
	39	77.5	17.00	92.7	20.47	107.4	24.21	114.8	26.39	122.2	28.37	136.9	32.74	152.5	37.96
	41	75.5	18.38	90.3	22.16	104.7	26.48	111.9	28.59	119.1	30.74	133.4	35.88	148.6	41.22
43	73.6	19.97	88.1	24.10	102.1	28.81	109.1	31.13	116.1	33.47	130.1	39.13	144.9	44.96	
46	69.0	22.37	82.5	27.03	95.7	32.32	102.2	34.95	108.8	37.57	122.0	44.03	135.8	50.62	
48	61.0	19.49	73.0	23.58	84.6	28.19	90.4	30.51	96.3	32.79	107.9	38.47	120.2	44.25	

**Note**

1. TC: Total Capacity(kW), PI : Power Input(kW, Comp. + Outdoor fan motor)
2. Capacity tables show the average value of conditions which may occur.

# 7. Capacity Tables

◆ ARUM840LTE5

Cooling Capacity (84HP)

Combination (%)	Outdoor air temp. (DB, °C)	Indoor air temp. (DB/WB, °C)													
		20		23		26		27		28		30		32	
		14	PI	16	PI	18	PI	19	PI	20	PI	22	PI	24	PI
130	10	33.1	3.43	45.1	4.28	60.2	5.21	85.0	6.35	112.0	7.94	161.2	10.59	213.8	14.03
	12	33.1	3.47	45.1	4.33	60.2	5.26	85.0	6.42	112.0	8.03	161.2	10.71	213.8	14.17
	14	33.1	3.50	45.1	4.37	60.2	5.32	85.0	6.49	112.0	8.11	161.2	10.82	213.8	14.32
	16	33.1	3.54	45.1	4.42	60.2	5.37	85.0	6.56	112.0	8.19	161.2	10.93	213.8	14.47
	18	33.1	3.57	45.1	4.46	60.2	5.43	85.0	6.62	112.0	8.28	161.2	11.04	213.8	14.62
	20	33.1	3.61	45.1	4.51	60.2	5.48	85.0	6.69	112.0	8.36	161.2	11.15	213.8	14.76
	21	33.1	3.65	45.8	4.64	74.5	6.85	99.0	7.97	125.2	10.27	171.6	14.02	220.6	16.62
	23	57.5	6.47	80.1	8.51	103.6	9.70	129.4	10.78	151.6	15.46	192.9	20.00	234.3	23.55
	25	85.0	10.26	103.0	12.76	132.7	14.50	161.3	17.09	178.0	22.22	214.2	29.06	248.0	34.19
	27	111.0	16.34	131.7	19.30	161.7	21.90	191.6	26.19	204.4	33.24	235.4	41.91	261.8	47.22
	29	137.0	22.69	160.3	26.62	190.8	32.16	222.7	37.87	230.8	45.14	257.0	54.18	275.6	60.30
	31	166.2	29.65	192.7	36.58	224.3	44.38	250.8	51.81	257.2	59.08	271.4	74.22	289.9	75.27
	33	195.5	36.54	228.5	47.73	256.5	57.11	271.1	74.15	276.9	73.63	285.5	74.29	304.8	75.33
	35	233.0	49.36	267.0	59.83	275.5	72.60	280.3	72.97	284.8	73.40	292.6	74.06	301.1	74.35
	37	233.0	52.64	263.2	62.79	271.7	71.64	275.5	72.00	280.3	72.43	287.9	73.08	296.4	73.37
	39	233.0	56.05	258.6	66.09	267.0	70.68	271.7	71.04	275.5	71.47	284.0	72.10	292.6	72.39
41	227.0	59.46	247.8	69.40	256.2	69.72	260.0	70.08	265.1	70.50	273.1	71.13	280.5	71.41	
43	221.4	62.71	237.5	68.42	245.7	68.77	249.5	69.11	254.5	69.53	262.3	70.15	269.4	70.42	
46	207.5	67.13	216.6	66.99	224.5	67.33	228.0	67.67	232.8	68.07	240.1	68.68	246.7	68.95	
48	183.5	65.25	188.2	65.45	195.2	65.59	198.3	65.77	202.5	66.34	209.0	66.76	214.8	67.02	
120	10	30.5	3.21	41.6	4.01	55.5	4.87	78.4	5.94	103.3	7.43	148.7	9.91	197.2	13.12
	12	30.5	3.24	41.6	4.05	55.5	4.92	78.4	6.01	103.3	7.51	148.7	10.01	197.2	13.26
	14	30.5	3.28	41.6	4.09	55.5	4.98	78.4	6.07	103.3	7.59	148.7	10.12	197.2	13.40
	16	30.5	3.31	41.6	4.13	55.5	5.03	78.4	6.13	103.3	7.67	148.7	10.22	197.2	13.54
	18	30.5	3.34	41.6	4.17	55.5	5.08	78.4	6.20	103.3	7.74	148.7	10.33	197.2	13.67
	20	30.5	3.38	41.6	4.22	55.5	5.13	78.4	6.26	103.3	7.82	148.7	10.43	197.2	13.81
	21	30.5	3.41	42.3	4.34	70.3	6.54	91.3	7.45	116.7	9.61	159.2	13.11	204.4	15.54
	23	53.0	6.05	76.0	8.09	100.0	9.30	119.2	10.09	144.5	14.47	181.0	18.71	218.5	22.03
	25	82.6	9.60	106.6	12.14	130.9	13.56	148.6	15.99	173.2	20.79	204.2	27.19	232.7	31.98
	27	114.7	15.17	145.1	18.05	162.4	20.33	176.5	24.30	201.9	30.85	227.4	38.89	246.8	44.53
	29	147.2	21.06	174.7	24.31	193.6	29.85	205.2	35.15	230.7	41.89	250.5	50.28	261.1	56.53
	31	178.2	26.66	210.4	32.14	225.1	39.60	236.2	46.59	260.3	53.13	267.5	63.90	276.5	65.09
	33	206.6	32.86	248.1	41.95	262.9	50.96	266.5	59.11	271.2	69.54	278.6	70.34	287.3	70.90
	35	210.8	43.90	250.6	56.87	265.6	62.91	269.2	74.93	273.9	75.30	281.4	75.52	288.7	76.12
	37	210.8	47.22	250.6	60.01	261.8	67.07	265.6	73.35	269.2	73.72	276.7	73.94	284.1	74.52
	39	210.8	50.84	249.8	63.42	257.2	71.13	260.9	71.84	264.6	72.20	273.0	72.42	280.4	72.99
41	205.4	54.45	238.9	66.84	246.9	69.73	250.4	70.34	254.1	70.69	261.4	70.90	268.9	71.46	
43	200.3	58.12	228.8	65.88	236.8	68.17	240.2	68.83	243.7	69.17	250.9	69.38	258.2	69.93	
46	187.7	62.50	208.7	64.31	216.2	66.03	219.4	66.57	222.8	66.90	229.5	67.10	236.3	67.63	
48	166.1	61.22	181.2	63.17	187.9	64.74	190.8	65.13	193.7	65.34	199.7	65.60	205.7	65.86	
110	10	28.0	3.01	38.1	3.76	50.9	4.58	71.8	5.59	94.6	6.98	136.2	9.31	180.6	12.33
	12	28.0	3.05	38.1	3.80	50.9	4.63	71.8	5.64	94.6	7.06	136.2	9.41	180.6	12.46
	14	28.0	3.08	38.1	3.84	50.9	4.68	71.8	5.70	94.6	7.13	136.2	9.51	180.6	12.59
	16	28.0	3.11	38.1	3.88	50.9	4.72	71.8	5.76	94.6	7.20	136.2	9.61	180.6	12.72
	18	28.0	3.14	38.1	3.92	50.9	4.77	71.8	5.82	94.6	7.28	136.2	9.70	180.6	12.85
	20	28.0	3.17	38.1	3.96	50.9	4.82	71.8	5.88	94.6	7.35	136.2	9.80	180.6	12.98
	21	28.0	3.20	38.1	4.08	63.7	6.02	84.3	7.00	105.3	9.03	147.1	12.32	189.9	14.61
	23	50.1	5.69	63.7	7.60	89.3	8.53	110.0	9.48	133.4	13.59	167.1	17.58	206.4	20.70
	25	72.1	9.02	89.3	11.40	114.8	12.75	135.9	15.03	158.4	19.54	186.7	25.55	222.5	30.05
	27	94.1	14.25	114.8	16.96	140.4	19.10	161.4	22.83	184.7	28.99	207.9	36.54	240.6	41.85
	29	116.1	19.79	140.3	22.85	165.9	28.05	187.7	33.03	210.9	39.36	229.1	46.30	253.9	51.35
	31	140.9	25.05	169.2	30.20	195.3	37.21	213.9	43.77	237.2	49.92	250.3	53.54	263.2	57.64
	33	163.4	30.88	195.3	39.42	221.3	47.89	241.2	53.51	256.4	60.05	264.4	61.71	271.1	61.79
	35	188.8	38.90	225.1	50.04	251.5	57.06	258.7	61.13	262.4	64.89	268.7	65.48	276.0	65.81
	37	188.8	41.23	225.1	53.11	251.5	60.23	255.1	64.76	257.8	68.43	265.1	68.67	271.4	68.87
	39	188.8	44.45	225.1	56.44	246.9	63.55	250.5	69.27	254.2	71.83	260.5	71.95	267.8	72.02
41	184.0	47.67	219.4	59.77	236.3	67.02	240.0	74.93	243.2	74.93	250.3	75.52	256.5	76.12	
43	179.4	50.05	213.9	62.27	226.5	71.07	230.2	71.87	233.2	71.72	240.1	72.12	246.2	72.32	
46	168.2	48.85	200.5	60.11	206.7	67.45	210.3	67.45	213.0	68.03	219.5	68.41	225.2	68.59	
48	148.8	47.45	174.3	57.91	179.5	64.17	182.8	64.60	185.2	64.92	190.9	65.10	195.9	65.36	

# 7. Capacity Tables

Cooling Capacity (84HP)

Combination (%)	Outdoor air temp. (DB, °C)	Indoor air temp. (DB/WB, °C)													
		20		23		26		27		28		30		32	
		14		16		18		19		20		22		24	
		TC	PI	TC	PI	TC	PI	TC	PI	TC	PI	TC	PI	TC	PI
100	10	25.7	2.77	35.0	3.45	46.7	4.20	65.9	5.12	86.8	6.41	125.0	8.54	165.7	11.31
	12	25.7	2.79	35.0	3.49	46.7	4.25	65.9	5.18	86.8	6.47	125.0	8.63	165.7	11.43
	14	25.7	2.82	35.0	3.53	46.7	4.29	65.9	5.23	86.8	6.54	125.0	8.72	165.7	11.55
	16	25.7	2.85	35.0	3.56	46.7	4.33	65.9	5.29	86.8	6.61	125.0	8.81	165.7	11.67
	18	25.7	2.88	35.0	3.60	46.7	4.38	65.9	5.34	86.8	6.68	125.0	8.90	165.7	11.79
	20	25.7	2.91	35.0	3.63	46.7	4.42	65.9	5.39	86.8	6.74	125.0	8.99	165.7	11.91
	21	25.7	2.94	35.0	3.74	58.1	5.52	77.4	6.42	98.9	8.28	134.9	11.30	174.2	13.40
	23	44.5	5.22	61.3	6.98	81.3	7.82	101.9	8.70	123.5	12.47	154.7	16.13	191.1	18.99
	25	63.5	8.27	82.7	10.46	104.4	11.69	127.0	13.79	148.0	17.92	174.5	23.44	208.0	27.57
	27	82.5	13.07	104.0	15.56	127.6	17.52	150.9	20.95	172.6	26.59	194.3	33.53	224.9	38.39
	29	101.5	18.15	125.4	20.96	150.7	25.73	175.4	30.30	197.1	36.11	214.1	43.35	241.8	47.11
	31	120.5	22.98	146.7	27.71	173.9	34.14	199.9	40.16	221.7	45.80	233.9	50.12	260.6	53.41
	33	139.5	28.33	168.1	36.16	197.0	43.93	224.4	50.96	246.5	55.65	254.1	56.61	260.6	57.85
	35	158.8	34.12	189.0	43.56	220.1	54.14	235.2	59.94	246.5	60.30	254.1	60.53	260.6	61.02
	37	158.8	36.54	189.0	46.72	220.1	57.35	235.2	62.79	242.4	63.10	249.4	63.36	255.4	63.94
	39	158.8	39.18	189.0	50.19	220.1	60.77	235.2	65.86	238.4	66.15	245.4	66.40	251.2	67.02
	41	156.2	41.81	186.0	53.66	216.6	64.19	225.7	68.93	230.6	69.21	236.1	69.45	243.7	70.10
43	150.9	44.25	179.6	56.88	209.1	67.26	216.4	71.57	218.9	71.82	225.6	72.06	231.5	72.74	
46	141.4	47.60	168.3	61.32	196.0	71.34	197.6	74.93	199.7	75.14	206.1	75.36	211.6	76.08	
48	125.1	41.10	148.9	53.06	169.2	60.99	171.7	63.57	173.5	63.78	179.2	63.92	184.1	64.43	
90	10	23.1	2.54	31.5	3.18	42.0	3.99	58.1	4.56	78.1	5.89	112.5	7.77	149.2	10.18
	12	23.1	2.57	31.5	3.21	42.0	4.03	58.1	4.61	78.1	5.96	112.5	7.86	149.2	10.29
	14	23.1	2.60	31.5	3.24	42.0	4.08	58.1	4.66	78.1	6.02	112.5	7.94	149.2	10.39
	16	23.1	2.62	31.5	3.28	42.0	4.12	58.1	4.71	78.1	6.08	112.5	8.02	149.2	10.50
	18	23.1	2.65	31.5	3.31	42.0	4.16	58.1	4.75	78.1	6.14	112.5	8.10	149.2	10.61
	20	23.1	2.68	31.5	3.34	42.0	4.20	58.1	4.80	78.1	6.20	112.5	8.18	149.2	10.72
	21	23.1	2.70	31.5	3.38	52.7	5.29	68.8	5.69	88.1	7.44	121.5	9.00	157.0	11.79
	23	31.3	4.18	46.3	5.80	73.5	7.51	89.2	8.18	107.7	10.94	139.7	13.34	172.9	16.22
	25	49.9	7.07	67.0	9.31	94.4	11.11	109.6	12.92	127.3	15.95	157.8	20.16	188.9	23.44
	27	68.4	10.39	87.7	13.26	115.2	17.24	130.0	19.21	146.9	23.26	176.0	27.13	204.8	30.67
	29	86.9	14.04	108.4	18.21	136.0	24.02	150.4	26.56	166.5	30.71	194.1	34.83	220.8	40.59
	31	105.5	17.57	129.1	23.38	156.9	30.08	170.8	33.89	186.1	38.25	212.3	40.55	236.7	47.17
	33	124.0	22.62	149.8	28.78	177.7	36.45	191.3	40.19	205.8	44.47	230.4	48.05	252.7	52.69
	35	142.8	28.01	170.5	35.42	198.2	43.79	211.7	48.30	225.1	52.51	248.5	56.33	252.7	57.62
	37	142.8	29.73	170.5	37.67	198.2	46.69	211.7	51.31	225.1	55.43	244.5	58.89	248.7	60.21
	39	142.8	31.48	170.5	40.07	198.2	49.42	211.7	54.60	225.1	58.29	240.5	62.08	244.7	62.83
	41	139.1	35.22	166.2	44.42	193.2	54.24	206.3	59.71	219.4	62.93	230.4	65.43	234.6	66.93
43	135.7	38.02	162.0	48.00	188.4	59.25	201.2	64.30	213.9	67.47	220.9	69.90	225.0	70.91	
46	127.2	42.79	151.9	54.67	176.5	67.50	188.5	72.90	194.4	74.96	201.7	75.36	205.5	76.08	
48	112.5	37.40	134.3	47.82	156.2	59.06	166.8	63.57	168.8	63.78	175.3	63.92	178.6	64.43	
80	10	19.8	2.25	26.9	2.81	35.9	3.53	50.7	4.06	66.8	5.21	96.2	6.87	127.6	9.00
	12	19.8	2.27	26.9	2.84	35.9	3.57	50.7	4.10	66.8	5.26	96.2	6.94	127.6	9.09
	14	19.8	2.30	26.9	2.87	35.9	3.60	50.7	4.14	66.8	5.32	96.2	7.02	127.6	9.19
	16	19.8	2.32	26.9	2.90	35.9	3.64	50.7	4.19	66.8	5.37	96.2	7.09	127.6	9.28
	18	19.8	2.34	26.9	2.93	35.9	3.68	50.7	4.23	66.8	5.43	96.2	7.16	127.6	9.38
	20	19.8	2.37	26.9	2.96	35.9	3.71	50.7	4.27	66.8	5.48	96.2	7.23	127.6	9.47
	21	19.8	2.38	26.9	3.04	45.1	4.68	60.5	5.12	75.7	6.58	104.6	7.96	135.7	10.42
	23	35.0	4.39	44.7	5.22	63.7	6.63	80.1	7.36	93.6	9.67	121.8	11.79	151.6	14.33
	25	50.3	6.37	62.4	8.38	82.3	9.82	99.7	11.63	111.5	14.10	139.0	17.82	167.5	20.72
	27	65.6	9.36	80.2	11.93	100.9	15.24	119.2	17.29	129.4	20.56	156.1	23.98	183.4	27.11
	29	80.9	12.13	97.9	16.39	119.4	21.24	138.8	23.90	147.2	27.14	173.3	30.79	199.3	35.89
	31	96.2	14.86	115.6	20.63	138.0	26.59	158.4	30.50	168.4	32.90	190.5	35.49	215.2	41.28
	33	111.5	19.55	133.4	25.38	156.6	31.26	178.1	36.17	188.5	37.80	207.6	42.06	231.1	46.47
	35	126.8	25.58	151.2	32.06	175.6	39.34	188.2	43.21	200.8	47.30	225.1	53.66	246.8	55.90
	37	126.8	27.06	151.2	34.09	175.6	41.73	188.2	45.94	200.8	50.26	225.1	56.64	242.8	58.71
	39	126.8	28.60	151.2	36.04	175.6	44.64	188.2	49.38	200.8	54.01	225.1	59.84	238.8	61.94
	41	123.6	31.64	147.3	39.94	171.1	48.99	183.3	54.13	195.6	59.34	219.4	64.12	228.8	65.59
43	120.5	34.83	143.7	43.58	166.8	53.48	178.8	58.99	190.8	64.85	213.9	68.50	219.4	70.20	
46	113.0	38.75	134.7	49.09	156.4	60.25	167.6	65.66	178.8	73.18	195.6	75.36	200.2	76.08	
48	99.9	33.84	119.1	42.93	138.3	52.70	148.2	57.35	158.2	63.78	169.9	63.92	174.0	64.43	



# 7. Capacity Tables

Cooling Capacity (84HP)

Combination (%)	Outdoor air temp. (DB, °C)	Indoor air temp. (DB/WB, °C)													
		20		23		26		27		28		30		32	
		14	16	18	19	20	22	24	TC	PI	TC	PI	TC	PI	
70	10	17.2	1.99	23.4	2.48	31.3	3.12	44.1	3.61	58.2	4.61	83.7	6.08	111.0	7.96
	12	17.2	2.01	23.4	2.51	31.3	3.15	44.1	3.65	58.2	4.65	83.7	6.14	111.0	8.04
	14	17.2	2.03	23.4	2.53	31.3	3.18	44.1	3.69	58.2	4.70	83.7	6.20	111.0	8.12
	16	17.2	2.05	23.4	2.56	31.3	3.22	44.1	3.73	58.2	4.75	83.7	6.27	111.0	8.21
	18	17.2	2.07	23.4	2.59	31.3	3.25	44.1	3.76	58.2	4.80	83.7	6.33	111.0	8.29
	20	17.2	2.09	23.4	2.61	31.3	3.28	44.1	3.80	58.2	4.85	83.7	6.40	111.0	8.37
	21	17.2	2.10	27.3	3.07	40.6	4.31	54.6	4.77	67.2	5.82	92.3	7.03	119.5	9.21
	23	24.6	3.16	42.3	5.02	56.7	6.30	73.5	6.84	85.3	8.55	109.7	10.42	136.1	12.67
	25	39.0	5.22	57.3	7.41	72.9	8.68	92.4	10.82	103.3	12.46	127.0	15.75	152.6	18.31
	27	53.4	7.61	72.3	10.55	89.0	12.80	111.3	16.08	121.4	18.18	144.4	21.20	169.2	23.96
	29	67.8	9.65	87.4	13.93	105.1	17.41	130.2	21.87	139.5	24.00	161.7	27.22	185.7	31.72
	31	82.2	11.87	102.4	17.33	121.3	21.80	149.1	27.48	157.5	29.08	179.1	31.37	202.3	36.50
	33	96.6	15.97	117.4	21.07	137.4	25.32	164.6	31.90	175.6	33.41	196.6	37.18	218.4	41.08
	35	110.9	21.86	132.7	27.24	153.7	32.95	164.6	36.04	175.6	39.36	196.6	46.34	218.4	50.81
	37	110.9	23.23	132.7	28.85	153.7	35.01	164.6	38.33	175.6	41.88	196.6	49.32	218.4	53.62
	39	110.9	24.67	132.7	30.76	153.7	37.44	164.6	41.24	175.6	45.24	196.6	52.78	218.4	57.81
	41	108.0	27.27	129.3	33.70	149.8	41.07	160.4	45.24	171.1	49.18	191.5	57.97	212.8	62.31
43	105.4	29.69	126.1	36.72	146.1	44.81	156.5	49.33	166.8	53.71	186.8	63.33	207.5	67.39	
46	98.7	32.99	118.2	41.29	136.9	50.46	146.6	54.94	156.4	60.54	175.1	71.43	194.5	75.15	
48	87.4	28.79	104.6	36.07	121.1	44.12	129.7	48.01	138.3	52.96	154.9	62.51	172.1	64.43	
60	10	15.1	1.68	20.3	2.10	27.1	2.64	38.2	3.08	50.3	3.89	72.5	5.14	96.1	6.73
	12	15.1	1.70	20.3	2.12	27.1	2.66	38.2	3.11	50.3	3.93	72.5	5.19	96.1	6.80
	14	15.1	1.72	20.3	2.14	27.1	2.69	38.2	3.14	50.3	3.98	72.5	5.24	96.1	6.87
	16	15.1	1.73	20.3	2.17	27.1	2.72	38.2	3.17	50.3	4.02	72.5	5.30	96.1	6.94
	18	15.1	1.75	20.3	2.19	27.1	2.75	38.2	3.20	50.3	4.06	72.5	5.35	96.1	7.01
	20	15.1	1.77	20.3	2.21	27.1	2.78	38.2	3.24	50.3	4.10	72.5	5.41	96.1	7.08
	21	15.1	1.78	20.3	2.29	33.9	3.56	44.9	3.93	57.7	4.92	78.7	5.95	102.3	7.79
	23	15.1	1.97	33.6	4.15	47.8	5.33	62.1	5.70	72.7	7.23	91.5	8.81	114.4	10.71
	25	28.2	3.74	46.9	6.26	61.8	7.34	80.0	9.72	87.7	10.54	106.5	13.05	126.5	15.48
	27	41.5	5.46	60.2	8.92	75.8	10.83	96.6	13.53	102.7	15.13	119.6	17.29	138.7	19.94
	29	54.8	7.09	73.5	11.42	89.8	14.43	114.0	17.78	117.7	19.28	132.7	21.69	150.8	25.49
	31	68.1	9.01	86.9	13.66	103.7	17.57	127.9	21.34	132.7	22.39	148.6	24.00	162.9	29.37
	33	81.4	12.55	100.2	16.61	117.7	19.73	138.0	23.92	147.9	25.63	160.4	28.45	175.1	33.45
	35	94.9	18.54	113.4	22.68	131.9	27.18	141.1	29.59	150.4	32.13	168.8	37.54	187.3	43.30
	37	94.9	19.58	113.4	23.94	131.9	28.79	141.1	31.44	150.4	34.08	168.8	39.84	187.3	46.06
	39	94.9	20.82	113.4	25.49	131.9	31.07	141.1	33.73	150.4	36.68	168.8	42.72	187.3	49.36
	41	92.5	22.58	110.5	27.89	128.5	33.74	137.5	36.84	146.5	39.82	164.5	46.88	182.5	53.64
43	90.2	24.54	107.8	30.37	125.3	36.79	134.1	40.15	142.9	43.42	160.5	51.18	178.0	58.59	
46	84.5	27.48	101.0	34.10	117.5	41.37	125.7	45.13	133.9	48.86	150.4	57.67	166.8	66.75	
48	74.8	23.94	89.3	29.76	103.9	36.15	111.2	39.42	118.5	42.69	133.0	50.43	147.6	58.40	
50	10	13.6	1.42	18.5	1.78	26.1	2.23	34.9	2.74	46.0	3.29	66.2	4.34	87.8	5.66
	12	13.6	1.44	18.5	1.79	26.1	2.25	34.9	2.77	46.0	3.33	66.2	4.39	87.8	5.72
	14	13.6	1.45	18.5	1.81	26.1	2.28	34.9	2.79	46.0	3.36	66.2	4.44	87.8	5.78
	16	13.6	1.47	18.5	1.83	26.1	2.30	34.9	2.82	46.0	3.40	66.2	4.48	87.8	5.84
	18	13.6	1.48	18.5	1.85	26.1	2.32	34.9	2.85	46.0	3.43	66.2	4.53	87.8	5.90
	20	13.6	1.50	18.5	1.87	26.1	2.35	34.9	2.88	46.0	3.47	66.2	4.57	87.8	5.96
	21	13.6	1.50	18.5	1.94	32.5	3.01	41.1	3.46	52.3	4.16	71.9	5.03	92.6	6.56
	23	13.6	1.60	29.4	3.29	45.1	4.51	58.1	5.39	66.2	6.11	82.8	7.45	102.2	9.02
	25	24.4	2.92	40.3	4.85	57.6	6.32	76.9	8.74	81.4	8.91	93.7	10.49	111.8	12.74
	27	35.4	4.18	51.3	6.82	71.4	8.80	89.2	11.65	94.6	12.01	104.6	13.73	121.4	16.22
	29	46.3	5.49	62.2	8.80	82.7	11.32	100.3	14.46	107.9	15.49	115.5	17.01	131.0	20.48
	31	57.3	6.98	73.1	10.46	94.1	13.79	109.1	16.13	115.5	17.14	126.2	18.37	140.6	22.53
	33	68.3	9.72	84.0	12.59	105.5	15.48	113.4	17.67	120.3	18.93	136.6	21.77	150.0	25.29
	35	79.4	15.41	94.9	18.54	110.0	21.90	117.6	23.75	125.2	25.61	140.3	29.55	156.2	33.95
	37	79.4	16.34	94.9	19.58	110.0	23.18	117.6	25.15	125.2	27.12	140.3	31.52	156.2	36.04
	39	79.4	17.43	94.9	20.99	110.0	24.83	117.6	27.07	125.2	29.09	140.3	33.57	156.2	38.92
	41	77.3	18.85	92.5	22.72	107.2	27.15	114.6	29.32	122.0	31.52	136.7	36.80	152.2	42.27
43	75.4	20.48	90.2	24.72	104.6	29.54	111.8	31.92	118.9	34.32	133.3	40.13	148.5	46.11	
46	70.7	22.94	84.5	27.72	98.0	33.14	104.7	35.85	111.5	38.53	124.9	45.15	139.1	51.91	
48	62.5	19.99	74.8	24.18	86.7	28.91	92.6	31.29	98.6	33.63	110.5	39.46	123.1	45.38	

**Note**

1. TC: Total Capacity(kW), PI : Power Input(kW, Comp. + Outdoor fan motor)
2. Capacity tables show the average value of conditions which may occur.

# 7. Capacity Tables

◆ ARUM860LTE5

Cooling Capacity (86HP)

Combination (%)	Outdoor air temp. (DB, °C)	Indoor air temp. (DB/WB, °C)													
		20		23		26		27		28		30		32	
		14	16	18	19	20	22	24	TC	PI	TC	PI	TC	PI	
130	10	33.9	3.48	46.2	4.35	61.6	5.29	87.0	6.46	114.6	8.07	165.0	10.76	218.9	14.25
	12	33.9	3.52	46.2	4.40	61.6	5.35	87.0	6.52	114.6	8.16	165.0	10.88	218.9	14.40
	14	33.9	3.56	46.2	4.44	61.6	5.40	87.0	6.59	114.6	8.24	165.0	10.99	218.9	14.55
	16	33.9	3.59	46.2	4.49	61.6	5.46	87.0	6.66	114.6	8.33	165.0	11.10	218.9	14.70
	18	33.9	3.63	46.2	4.53	61.6	5.52	87.0	6.73	114.6	8.41	165.0	11.22	218.9	14.85
	20	33.9	3.67	46.2	4.58	61.6	5.57	87.0	6.80	114.6	8.50	165.0	11.33	218.9	15.00
	21	33.9	3.70	46.9	4.72	76.3	6.96	101.4	8.09	128.2	10.44	175.7	14.24	225.8	16.88
	23	58.9	6.57	82.0	8.65	106.1	9.85	132.4	10.96	155.2	15.71	197.5	20.32	239.9	23.93
	25	87.0	10.42	105.5	12.97	135.8	14.73	165.1	17.37	182.2	22.58	219.3	29.53	253.9	34.74
	27	113.6	16.60	134.8	19.61	165.6	22.25	196.2	26.61	209.2	33.77	241.0	42.58	268.0	47.98
	29	140.2	23.05	164.1	27.05	195.4	32.68	228.0	38.48	236.2	45.86	263.1	55.05	282.2	61.27
	31	170.1	30.12	197.3	37.16	229.6	45.09	256.8	52.64	263.3	60.03	277.8	75.41	296.8	76.47
	33	200.1	37.13	233.9	48.50	262.6	58.03	277.5	75.34	283.5	74.81	292.3	75.48	312.1	76.54
	35	238.5	50.15	273.3	60.79	282.1	73.76	287.0	74.13	291.6	74.58	299.5	75.25	308.3	75.54
	37	238.5	53.48	269.5	63.79	278.2	72.79	282.1	73.16	287.0	73.59	294.8	74.25	303.5	74.55
	39	238.5	56.95	264.7	67.15	273.3	71.82	278.2	72.18	282.1	72.61	290.8	73.26	299.5	73.55
	41	232.4	60.42	253.7	70.51	262.3	70.84	266.2	71.20	271.4	71.62	279.6	72.27	287.2	72.55
	43	226.7	63.72	243.1	69.52	251.6	69.87	255.4	70.22	260.5	70.64	268.5	71.27	275.8	71.55
46	212.4	68.20	221.8	68.06	229.8	68.41	233.4	68.75	238.3	69.16	245.8	69.78	252.6	70.06	
48	187.9	66.30	192.6	66.50	199.8	66.64	203.0	66.82	207.3	67.40	214.0	67.83	219.9	68.09	
120	10	31.3	3.26	42.6	4.07	56.9	4.95	80.2	6.04	105.7	7.55	152.2	10.07	201.9	13.33
	12	31.3	3.29	42.6	4.11	56.9	5.00	80.2	6.10	105.7	7.63	152.2	10.17	201.9	13.47
	14	31.3	3.33	42.6	4.16	56.9	5.06	80.2	6.17	105.7	7.71	152.2	10.28	201.9	13.61
	16	31.3	3.36	42.6	4.20	56.9	5.11	80.2	6.23	105.7	7.79	152.2	10.39	201.9	13.75
	18	31.3	3.40	42.6	4.24	56.9	5.16	80.2	6.29	105.7	7.87	152.2	10.49	201.9	13.89
	20	31.3	3.43	42.6	4.28	56.9	5.21	80.2	6.36	105.7	7.95	152.2	10.60	201.9	14.03
	21	31.3	3.47	43.4	4.41	72.0	6.64	93.5	7.57	119.5	9.76	163.0	13.32	209.2	15.79
	23	54.2	6.15	77.8	8.22	102.3	9.45	122.0	10.25	147.9	14.70	185.3	19.01	223.7	22.39
	25	84.5	9.75	109.2	12.33	134.0	13.78	152.1	16.25	177.3	21.12	209.0	27.62	238.2	32.50
	27	117.4	15.41	148.5	18.34	166.3	20.65	180.7	24.69	206.7	31.34	232.8	39.51	252.7	45.25
	29	150.7	21.39	178.8	24.70	198.2	30.32	210.1	35.71	236.2	42.56	256.5	51.09	267.3	57.44
	31	182.5	27.09	215.4	32.66	230.4	40.23	241.9	47.33	266.5	53.98	273.8	64.92	283.1	66.13
	33	211.5	33.39	254.0	42.62	269.2	51.78	272.9	60.06	277.6	70.66	285.2	71.46	294.1	72.03
	35	215.8	44.61	256.6	57.78	271.9	63.91	275.6	76.13	280.4	76.51	288.1	76.73	295.6	77.34
	37	215.8	47.98	256.6	60.97	268.0	68.14	271.9	74.52	275.6	74.90	283.3	75.12	290.9	75.72
	39	215.8	51.65	255.7	64.44	263.3	72.27	267.1	72.99	270.9	73.36	279.5	73.58	287.0	74.16
	41	210.3	55.33	244.6	67.91	252.8	70.85	256.4	71.46	260.1	71.82	267.6	72.03	275.3	72.61
	43	205.1	59.05	234.3	66.94	242.4	69.26	245.9	69.93	249.6	70.28	256.9	70.49	264.3	71.05
46	192.2	63.50	213.6	65.34	221.4	67.09	224.7	67.64	228.1	67.97	235.0	68.18	241.9	68.72	
48	170.0	62.20	185.5	64.18	192.4	65.78	195.3	66.17	198.3	66.39	204.4	66.65	210.6	66.92	
110	10	28.6	3.06	39.1	3.82	52.1	4.65	73.5	5.68	96.9	7.09	139.4	9.46	185.0	12.53
	12	28.6	3.09	39.1	3.86	52.1	4.70	73.5	5.74	96.9	7.17	139.4	9.56	185.0	12.66
	14	28.6	3.13	39.1	3.90	52.1	4.75	73.5	5.80	96.9	7.24	139.4	9.66	185.0	12.79
	16	28.6	3.16	39.1	3.94	52.1	4.80	73.5	5.85	96.9	7.32	139.4	9.76	185.0	12.92
	18	28.6	3.19	39.1	3.98	52.1	4.85	73.5	5.91	96.9	7.39	139.4	9.86	185.0	13.05
	20	28.6	3.22	39.1	4.03	52.1	4.90	73.5	5.97	96.9	7.47	139.4	9.96	185.0	13.19
	21	28.6	3.26	39.1	4.15	65.3	6.12	86.3	7.11	107.8	9.17	150.6	12.52	194.4	14.84
	23	51.3	5.78	65.2	7.72	91.4	8.66	112.6	9.63	136.5	13.81	171.1	17.86	211.3	21.04
	25	73.8	9.16	91.4	11.59	117.6	12.95	139.1	15.27	162.2	19.85	191.2	25.95	227.8	30.54
	27	96.3	14.48	117.5	17.23	143.7	19.40	165.3	23.20	189.1	29.45	212.9	37.13	246.3	42.52
	29	118.9	20.10	143.7	23.21	169.9	28.49	192.1	33.56	216.0	39.99	234.6	47.04	259.9	52.18
	31	144.3	25.45	173.2	30.69	199.9	37.80	219.0	44.48	242.9	50.72	256.3	54.40	269.5	58.56
	33	167.2	31.37	199.9	40.05	226.6	48.65	247.0	54.36	262.6	61.01	270.7	62.70	277.6	62.78
	35	193.3	39.52	230.5	50.85	257.5	57.97	264.8	62.11	268.6	65.92	275.1	66.53	282.6	66.86
	37	193.3	41.89	230.5	53.96	257.5	61.20	261.2	65.80	263.9	69.53	271.4	69.77	277.9	69.97
	39	193.3	45.16	230.5	57.35	252.8	64.57	256.5	70.38	260.3	72.98	266.7	73.10	274.2	73.17
	41	188.4	48.43	224.6	60.73	242.0	68.09	245.8	76.13	248.9	76.13	256.2	76.73	262.6	77.34
	43	183.7	50.85	219.0	63.27	231.9	72.21	235.7	73.02	238.8	72.86	245.9	73.28	252.1	73.48
46	172.2	49.64	205.3	61.08	211.6	68.53	215.3	68.53	218.1	69.12	224.7	69.50	230.6	69.69	
48	152.3	48.21	178.4	58.84	183.8	65.20	187.1	65.64	189.6	65.95	195.5	66.14	200.6	66.40	

# 7. Capacity Tables

Cooling Capacity (86HP)

Combination (%)	Outdoor air temp. (DB, °C)	Indoor air temp. (DB/WB, °C)													
		20		23		26		27		28		30		32	
		14		16		18		19		20		22		24	
		TC	PI	TC	PI	TC	PI	TC	PI	TC	PI	TC	PI	TC	PI
100	10	26.3	2.81	35.8	3.51	47.8	4.27	67.4	5.21	88.9	6.51	127.9	8.68	169.7	11.49
	12	26.3	2.84	35.8	3.54	47.8	4.31	67.4	5.26	88.9	6.58	127.9	8.77	169.7	11.61
	14	26.3	2.87	35.8	3.58	47.8	4.36	67.4	5.32	88.9	6.65	127.9	8.86	169.7	11.73
	16	26.3	2.90	35.8	3.62	47.8	4.40	67.4	5.37	88.9	6.71	127.9	8.95	169.7	11.86
	18	26.3	2.93	35.8	3.66	47.8	4.45	67.4	5.43	88.9	6.78	127.9	9.05	169.7	11.98
	20	26.3	2.96	35.8	3.69	47.8	4.49	67.4	5.48	88.9	6.85	127.9	9.14	169.7	12.10
	21	26.3	2.99	35.8	3.80	59.5	5.61	79.2	6.53	101.3	8.42	138.1	11.48	178.4	13.61
	23	45.6	5.30	62.8	7.09	83.2	7.95	104.3	8.84	126.4	12.67	158.4	16.38	195.7	19.30
	25	65.0	8.40	84.6	10.63	106.9	11.88	130.0	14.01	151.6	18.21	178.7	23.81	212.9	28.01
	27	84.5	13.28	106.5	15.81	130.6	17.80	154.5	21.28	176.7	27.02	198.9	34.06	230.2	39.01
	29	103.9	18.44	128.4	21.30	154.3	26.14	179.6	30.78	201.8	36.69	219.2	44.04	247.5	47.87
	31	123.4	23.35	150.2	28.15	178.0	34.68	204.7	40.80	227.0	46.53	239.5	50.92	266.8	54.27
	33	142.8	28.78	172.1	36.74	201.7	44.64	229.7	51.78	252.4	56.54	260.2	57.52	266.8	58.77
	35	162.5	34.67	193.5	44.26	225.3	55.01	240.8	60.90	252.4	61.27	260.2	61.50	266.8	62.00
	37	162.5	37.13	193.5	47.47	225.3	58.27	240.8	63.80	248.2	64.11	255.4	64.37	261.4	64.97
	39	162.5	39.81	193.5	51.00	225.3	61.74	240.8	66.92	244.1	67.21	251.3	67.47	257.1	68.09
41	160.0	42.48	190.4	54.52	221.7	65.22	231.0	70.04	236.1	70.32	241.7	70.56	249.5	71.22	
43	154.5	44.96	183.9	57.80	214.1	68.34	221.5	72.71	224.1	72.97	231.0	73.21	237.1	73.90	
46	144.8	48.36	172.3	62.31	200.7	72.49	202.3	76.13	204.5	76.35	211.0	76.57	216.7	77.30	
48	128.1	41.76	152.4	53.91	173.2	61.97	175.8	64.59	177.6	64.80	183.4	64.95	188.5	65.47	
90	10	23.6	2.58	32.2	3.23	43.0	4.06	59.5	4.63	80.0	5.99	115.1	7.90	152.7	10.34
	12	23.6	2.61	32.2	3.26	43.0	4.10	59.5	4.68	80.0	6.05	115.1	7.98	152.7	10.45
	14	23.6	2.64	32.2	3.30	43.0	4.14	59.5	4.73	80.0	6.11	115.1	8.07	152.7	10.56
	16	23.6	2.67	32.2	3.33	43.0	4.18	59.5	4.78	80.0	6.18	115.1	8.15	152.7	10.67
	18	23.6	2.69	32.2	3.36	43.0	4.23	59.5	4.83	80.0	6.24	115.1	8.23	152.7	10.78
	20	23.6	2.72	32.2	3.40	43.0	4.27	59.5	4.88	80.0	6.30	115.1	8.31	152.7	10.89
	21	23.6	2.75	32.2	3.43	53.9	5.38	70.4	5.78	90.2	7.56	124.4	9.15	160.7	11.98
	23	32.1	4.25	47.4	5.90	75.3	7.63	91.3	8.31	110.2	11.12	143.0	13.55	177.0	16.47
	25	51.0	7.19	68.6	9.46	96.6	11.29	112.2	13.13	130.3	16.21	161.6	20.48	193.4	23.81
	27	70.0	10.56	89.8	13.47	117.9	17.52	133.1	19.52	150.4	23.64	180.2	27.56	209.7	31.16
	29	89.0	14.26	111.0	18.50	139.3	24.41	154.0	26.98	170.5	31.20	198.8	35.39	226.0	41.24
	31	108.0	17.85	132.2	23.76	160.6	30.56	174.9	34.43	190.6	38.87	217.3	41.20	242.3	47.93
	33	126.9	22.99	153.4	29.24	181.9	37.04	195.8	40.83	210.7	45.18	235.9	48.82	258.7	53.54
	35	146.2	28.46	174.6	35.99	203.0	44.49	216.7	49.07	230.5	53.35	254.4	57.23	258.7	58.55
	37	146.2	30.21	174.6	38.28	203.0	47.44	216.7	52.13	230.5	56.32	250.3	59.83	254.6	61.17
	39	146.2	31.98	174.6	40.71	203.0	50.21	216.7	55.47	230.5	59.22	246.2	63.08	250.6	63.84
41	142.5	35.78	170.1	45.14	197.8	55.11	211.2	60.67	224.6	63.94	235.9	66.48	240.2	68.00	
43	138.9	38.63	165.9	48.77	192.9	60.20	206.0	65.33	219.0	68.55	226.2	71.02	230.3	72.05	
46	130.2	43.48	155.5	55.54	180.8	68.58	193.0	74.07	199.0	76.16	206.5	76.57	210.4	77.30	
48	115.2	38.00	137.5	48.59	159.9	60.01	170.7	64.59	172.8	64.80	179.5	64.95	182.9	65.47	
80	10	20.2	2.29	27.6	2.85	36.8	3.58	51.9	4.12	68.4	5.29	98.5	6.98	130.7	9.14
	12	20.2	2.31	27.6	2.88	36.8	3.62	51.9	4.17	68.4	5.35	98.5	7.06	130.7	9.24
	14	20.2	2.33	27.6	2.91	36.8	3.66	51.9	4.21	68.4	5.40	98.5	7.13	130.7	9.34
	16	20.2	2.36	27.6	2.94	36.8	3.70	51.9	4.25	68.4	5.46	98.5	7.20	130.7	9.43
	18	20.2	2.38	27.6	2.97	36.8	3.74	51.9	4.30	68.4	5.52	98.5	7.28	130.7	9.53
	20	20.2	2.41	27.6	3.00	36.8	3.77	51.9	4.34	68.4	5.57	98.5	7.35	130.7	9.62
	21	20.2	2.42	27.6	3.09	46.2	4.75	62.0	5.20	77.5	6.69	107.1	8.09	138.9	10.59
	23	35.9	4.46	45.8	5.31	65.2	6.74	82.0	7.48	95.8	9.83	124.7	11.98	155.2	14.56
	25	51.5	6.47	63.9	8.51	84.2	9.98	102.0	11.82	114.1	14.33	142.3	18.10	171.4	21.05
	27	67.2	9.50	82.1	12.12	103.3	15.49	122.1	17.57	132.4	20.89	159.8	24.37	187.7	27.54
	29	82.8	12.32	100.2	16.65	122.3	21.58	142.1	24.28	150.7	27.58	177.4	31.28	204.0	36.46
	31	98.5	15.10	118.4	20.96	141.3	27.01	162.1	30.99	172.4	33.42	195.0	36.06	220.3	41.95
	33	114.1	19.86	136.6	25.79	160.3	31.76	182.3	36.75	193.0	38.40	212.6	42.73	236.6	47.22
	35	129.9	25.99	154.8	32.58	179.7	39.97	192.6	43.90	205.5	48.06	230.5	54.52	252.7	56.79
	37	129.9	27.49	154.8	34.63	179.7	42.40	192.6	46.67	205.5	51.06	230.5	57.54	248.6	59.65
	39	129.9	29.06	154.8	36.62	179.7	45.35	192.6	50.18	205.5	54.87	230.5	60.80	244.5	62.93
41	126.5	32.14	150.8	40.58	175.1	49.77	187.7	55.00	200.3	60.29	224.6	65.15	234.3	66.64	
43	123.4	35.38	147.1	44.28	170.8	54.33	183.1	59.94	195.3	65.89	219.0	69.60	224.6	71.33	
46	115.7	39.37	137.9	49.88	160.1	61.22	171.6	66.71	183.1	74.35	200.3	76.57	205.0	77.30	
48	102.3	34.38	122.0	43.61	141.6	53.54	151.8	58.27	161.9	64.80	174.0	64.95	178.1	65.47	

# 7. Capacity Tables

Cooling Capacity (86HP)

Combination (%)	Outdoor air temp. (DB, °C)	Indoor air temp. (DB/WB, °C)													
		20		23		26		27		28		30		32	
		14		16		18		19		20		22		24	
		TC	PI	TC	PI	TC	PI	TC	PI	TC	PI	TC	PI	TC	PI
70	10	17.6	2.02	24.0	2.52	32.0	3.17	45.2	3.67	59.5	4.68	85.7	6.17	113.7	8.08
	12	17.6	2.04	24.0	2.55	32.0	3.20	45.2	3.71	59.5	4.73	85.7	6.24	113.7	8.17
	14	17.6	2.06	24.0	2.58	32.0	3.24	45.2	3.75	59.5	4.78	85.7	6.30	113.7	8.25
	16	17.6	2.08	24.0	2.60	32.0	3.27	45.2	3.79	59.5	4.83	85.7	6.37	113.7	8.34
	18	17.6	2.11	24.0	2.63	32.0	3.30	45.2	3.83	59.5	4.88	85.7	6.43	113.7	8.42
	20	17.6	2.13	24.0	2.65	32.0	3.34	45.2	3.86	59.5	4.93	85.7	6.50	113.7	8.51
	21	17.6	2.14	28.0	3.12	41.6	4.37	55.9	4.85	68.8	5.91	94.5	7.15	122.4	9.36
	23	25.2	3.21	43.3	5.10	58.1	6.40	75.3	6.95	87.3	8.69	112.3	10.59	139.3	12.87
	25	40.0	5.30	58.7	7.53	74.6	8.82	94.6	10.99	105.8	12.66	130.0	16.00	156.3	18.61
	27	54.7	7.73	74.1	10.72	91.1	13.01	114.0	16.34	124.3	18.47	147.8	21.54	173.2	24.35
	29	69.4	9.80	89.4	14.15	107.6	17.69	133.3	22.22	142.8	24.38	165.6	27.66	190.2	32.23
	31	84.2	12.06	104.8	17.60	124.2	22.15	152.7	27.92	161.3	29.55	183.3	31.87	207.1	37.08
	33	98.9	16.22	120.2	21.41	140.7	25.72	168.6	32.41	179.7	33.95	201.2	37.77	223.6	41.74
	35	113.5	22.21	135.9	27.68	157.4	33.48	168.6	36.62	179.7	39.99	201.2	47.08	223.6	51.62
	37	113.5	23.60	135.9	29.31	157.4	35.58	168.6	38.95	179.7	42.55	201.2	50.11	223.6	54.48
	39	113.5	25.06	135.9	31.25	157.4	38.04	168.6	41.90	179.7	45.96	201.2	53.63	223.6	58.74
41	110.6	27.71	132.4	34.24	153.4	41.73	164.2	45.96	175.1	49.97	196.1	58.90	217.9	63.31	
43	107.9	30.16	129.1	37.31	149.6	45.53	160.2	50.12	170.8	54.57	191.2	64.34	212.5	68.47	
46	101.1	33.52	121.0	41.95	140.2	51.27	150.1	55.82	160.1	61.51	179.2	72.57	199.1	76.36	
48	89.4	29.25	107.0	36.65	124.0	44.82	132.8	48.78	141.6	53.81	158.5	63.51	176.2	65.47	
60	10	15.5	1.72	20.8	2.14	27.7	2.69	39.1	3.14	51.5	3.98	74.2	5.25	98.4	6.87
	12	15.5	1.73	20.8	2.17	27.7	2.72	39.1	3.17	51.5	4.02	74.2	5.30	98.4	6.94
	14	15.5	1.75	20.8	2.19	27.7	2.75	39.1	3.21	51.5	4.06	74.2	5.36	98.4	7.01
	16	15.5	1.77	20.8	2.21	27.7	2.78	39.1	3.24	51.5	4.10	74.2	5.41	98.4	7.09
	18	15.5	1.79	20.8	2.23	27.7	2.81	39.1	3.27	51.5	4.14	74.2	5.47	98.4	7.16
	20	15.5	1.81	20.8	2.26	27.7	2.83	39.1	3.31	51.5	4.19	74.2	5.52	98.4	7.23
	21	15.5	1.82	20.8	2.34	34.7	3.64	45.9	4.01	59.1	5.02	80.6	6.07	104.7	7.95
	23	15.5	2.01	34.4	4.24	49.0	5.44	63.6	5.82	74.5	7.38	93.7	9.00	117.1	10.94
	25	28.8	3.82	48.0	6.40	63.3	7.50	81.9	9.93	89.8	10.76	109.0	13.33	129.6	15.81
	27	42.5	5.58	61.7	9.11	77.6	11.06	98.9	13.82	105.2	15.45	122.4	17.66	142.0	20.36
	29	56.1	7.24	75.3	11.67	91.9	14.74	116.7	18.16	120.5	19.69	135.8	22.15	154.4	26.03
	31	69.7	9.20	88.9	13.95	106.2	17.95	131.0	21.79	135.9	22.87	152.2	24.52	166.8	30.00
	33	83.4	12.81	102.6	16.97	120.5	20.15	141.3	24.43	151.4	26.17	164.2	29.05	179.3	34.17
	35	97.2	18.84	116.1	23.05	135.0	27.61	144.5	30.07	153.9	32.64	172.9	38.14	191.8	43.99
	37	97.2	19.89	116.1	24.32	135.0	29.25	144.5	31.94	153.9	34.63	172.9	40.48	191.8	46.80
	39	97.2	21.15	116.1	25.90	135.0	31.57	144.5	34.27	153.9	37.27	172.9	43.40	191.8	50.15
41	94.7	22.94	113.1	28.34	131.6	34.28	140.8	37.43	150.0	40.45	168.4	47.63	186.9	54.49	
43	92.4	24.93	110.3	30.86	128.3	37.37	137.3	40.79	146.3	44.11	164.3	52.00	182.3	59.52	
46	86.5	27.92	103.4	34.65	120.2	42.04	128.7	45.86	137.1	49.64	153.9	58.59	170.8	67.82	
48	76.6	24.33	91.5	30.24	106.4	36.73	113.8	40.05	121.3	43.38	136.2	51.24	151.1	59.34	
50	10	13.9	1.46	19.0	1.82	26.8	2.29	35.7	2.81	47.1	3.38	67.8	4.46	89.9	5.82
	12	13.9	1.48	19.0	1.84	26.8	2.31	35.7	2.84	47.1	3.42	67.8	4.51	89.9	5.88
	14	13.9	1.49	19.0	1.86	26.8	2.34	35.7	2.87	47.1	3.45	67.8	4.56	89.9	5.94
	16	13.9	1.51	19.0	1.88	26.8	2.36	35.7	2.90	47.1	3.49	67.8	4.60	89.9	6.00
	18	13.9	1.52	19.0	1.90	26.8	2.39	35.7	2.93	47.1	3.53	67.8	4.65	89.9	6.06
	20	13.9	1.54	19.0	1.92	26.8	2.41	35.7	2.96	47.1	3.56	67.8	4.70	89.9	6.12
	21	13.9	1.55	19.0	1.99	33.3	3.09	42.1	3.55	53.6	4.27	73.6	5.17	94.8	6.74
	23	13.9	1.64	30.1	3.38	46.1	4.63	59.5	5.54	67.8	6.28	84.8	7.65	104.6	9.26
	25	25.0	3.00	41.3	4.99	59.0	6.49	78.7	8.98	83.3	9.15	95.9	10.77	114.5	13.09
	27	36.2	4.29	52.5	7.01	73.1	9.04	91.3	11.97	96.9	12.34	107.1	14.10	124.3	16.66
	29	47.4	5.64	63.6	9.04	84.7	11.63	102.7	14.85	110.4	15.91	118.3	17.47	134.1	21.04
	31	58.7	7.17	74.8	10.74	96.4	14.16	111.7	16.56	118.2	17.60	129.3	18.87	143.9	23.15
	33	69.9	9.99	86.0	12.93	108.0	15.90	116.1	18.15	123.2	19.45	139.8	22.36	153.6	25.97
	35	81.3	15.66	97.2	18.84	112.7	22.25	120.4	24.14	128.1	26.02	143.6	30.02	160.0	34.50
	37	81.3	16.60	97.2	19.90	112.7	23.55	120.4	25.55	128.1	27.55	143.6	32.02	160.0	36.61
	39	81.3	17.71	97.2	21.33	112.7	25.23	120.4	27.50	128.1	29.56	143.6	34.11	160.0	39.55
41	79.2	19.15	94.7	23.09	109.8	27.59	117.3	29.78	124.9	32.03	139.9	37.39	155.9	42.95	
43	77.2	20.81	92.4	25.11	107.1	30.01	114.4	32.43	121.8	34.87	136.5	40.77	152.0	46.85	
46	72.4	23.31	86.5	28.17	100.3	33.67	107.2	36.42	114.1	39.15	127.9	45.87	142.5	52.74	
48	64.0	20.31	76.6	24.56	88.8	29.37	94.9	31.79	101.0	34.16	113.1	40.09	126.0	46.11	

**Note**

1. TC: Total Capacity(kW), PI : Power Input(kW, Comp. + Outdoor fan motor)
2. Capacity tables show the average value of conditions which may occur.

# 7. Capacity Tables

◆ ARUM880LTE5

Cooling Capacity (88HP)

Combination (%)	Outdoor air temp. (DB, °C)	Indoor air temp. (DB/WB, °C)													
		20		23		26		27		28		30		32	
		14	16	18	19	20	22	24	TC	PI	TC	PI	TC	PI	
130	10	34.7	3.61	47.3	4.51	63.1	5.49	89.0	6.69	117.3	8.37	168.9	11.16	224.0	14.77
	12	34.7	3.65	47.3	4.56	63.1	5.54	89.0	6.76	117.3	8.45	168.9	11.27	224.0	14.93
	14	34.7	3.69	47.3	4.60	63.1	5.60	89.0	6.83	117.3	8.54	168.9	11.39	224.0	15.08
	16	34.7	3.73	47.3	4.65	63.1	5.66	89.0	6.90	117.3	8.63	168.9	11.51	224.0	15.24
	18	34.7	3.76	47.3	4.70	63.1	5.72	89.0	6.97	117.3	8.72	168.9	11.63	224.0	15.39
	20	34.7	3.80	47.3	4.75	63.1	5.78	89.0	7.05	117.3	8.81	168.9	11.74	224.0	15.55
	21	34.7	3.84	48.0	4.89	78.1	7.22	103.7	8.39	131.2	10.82	179.8	14.76	231.1	17.50
	23	60.3	6.82	83.9	8.96	108.5	10.22	135.5	11.36	158.8	16.29	202.1	21.06	245.5	24.81
	25	89.1	10.80	107.9	13.44	139.0	15.27	169.0	18.00	186.5	23.41	224.4	30.61	259.9	36.01
	27	116.3	17.21	137.9	20.32	169.4	23.07	200.7	27.58	214.1	35.01	246.6	44.14	274.2	49.73
	29	143.5	23.90	167.9	28.04	199.9	33.87	233.4	39.89	241.7	47.54	269.2	57.07	288.7	63.51
	31	174.1	31.23	201.9	38.52	235.0	46.74	262.8	54.56	269.4	62.23	284.3	78.17	303.7	79.28
	33	204.8	38.49	239.4	50.27	268.7	60.15	284.0	78.10	290.1	77.55	299.1	78.24	319.4	79.34
	35	244.1	51.99	279.7	63.02	288.6	76.47	293.6	76.85	298.4	77.31	306.5	78.00	315.4	78.31
	37	244.1	55.44	275.8	66.13	284.7	75.46	288.6	75.83	293.6	76.29	301.6	76.97	310.5	77.28
	39	244.1	59.03	270.9	69.61	279.7	74.45	284.7	74.82	288.6	75.27	297.6	75.94	306.5	76.24
41	237.8	62.63	259.6	73.09	268.4	73.44	272.4	73.80	277.7	74.25	286.1	74.91	293.8	75.21	
43	231.9	66.05	248.8	72.06	257.4	72.43	261.4	72.79	266.6	73.23	274.8	73.88	282.3	74.17	
46	217.3	70.70	227.0	70.55	235.2	70.91	238.9	71.27	243.8	71.69	251.5	72.34	258.5	72.62	
48	192.3	68.73	197.1	68.93	204.5	69.08	207.7	69.27	212.2	69.87	219.0	70.31	225.1	70.59	
120	10	32.0	3.38	43.6	4.22	58.2	5.13	82.1	6.26	108.2	7.83	155.8	10.44	206.6	13.82
	12	32.0	3.41	43.6	4.26	58.2	5.19	82.1	6.33	108.2	7.91	155.8	10.55	206.6	13.97
	14	32.0	3.45	43.6	4.31	58.2	5.24	82.1	6.39	108.2	7.99	155.8	10.66	206.6	14.11
	16	32.0	3.49	43.6	4.35	58.2	5.30	82.1	6.46	108.2	8.07	155.8	10.77	206.6	14.26
	18	32.0	3.52	43.6	4.40	58.2	5.35	82.1	6.52	108.2	8.16	155.8	10.88	206.6	14.40
	20	32.0	3.56	43.6	4.44	58.2	5.40	82.1	6.59	108.2	8.24	155.8	10.99	206.6	14.55
	21	32.0	3.59	44.4	4.58	73.7	6.88	95.6	7.85	122.3	10.12	166.8	13.81	214.1	16.37
	23	55.5	6.38	79.7	8.52	104.7	9.79	124.9	10.63	151.4	15.24	189.6	19.70	228.9	23.21
	25	86.5	10.11	111.7	12.78	137.1	14.29	155.7	16.84	181.4	21.90	213.9	28.63	243.8	33.69
	27	120.1	15.97	152.0	19.01	170.1	21.41	184.9	25.59	211.5	32.49	238.2	40.96	258.6	46.90
	29	154.2	22.18	183.0	25.61	202.8	31.43	215.0	37.02	241.6	44.12	262.5	52.96	273.5	59.54
	31	186.7	28.08	220.4	33.85	235.8	41.70	247.5	49.06	272.7	55.96	280.2	67.30	289.6	68.55
	33	216.4	34.61	260.0	44.18	275.4	53.68	279.2	62.26	284.1	73.24	291.8	74.08	300.9	74.67
	35	220.8	46.24	262.6	59.90	278.2	66.25	282.1	78.91	287.0	79.31	294.8	79.54	302.5	80.18
	37	220.8	49.74	262.6	63.20	274.2	70.64	278.2	77.25	282.1	77.64	289.9	77.87	297.7	78.49
	39	220.8	53.54	261.7	66.80	269.5	74.92	273.3	75.67	277.2	76.04	286.0	76.27	293.7	76.88
41	215.2	57.35	250.2	70.39	258.7	73.44	262.3	74.08	266.2	74.45	273.9	74.67	281.7	75.26	
43	209.9	61.21	239.7	69.39	248.1	71.80	251.6	72.49	255.4	72.85	262.9	73.07	270.5	73.65	
46	196.7	65.82	218.6	67.73	226.5	69.54	229.9	70.11	233.4	70.46	240.4	70.67	247.5	71.23	
48	174.0	64.48	189.8	66.53	196.9	68.18	199.9	68.60	202.9	68.82	209.2	69.09	215.5	69.37	
110	10	29.3	3.17	40.0	3.96	53.3	4.82	75.2	5.88	99.1	7.35	142.7	9.81	189.3	12.99
	12	29.3	3.21	40.0	4.01	53.3	4.87	75.2	5.95	99.1	7.43	142.7	9.91	189.3	13.12
	14	29.3	3.24	40.0	4.05	53.3	4.92	75.2	6.01	99.1	7.51	142.7	10.01	189.3	13.26
	16	29.3	3.27	40.0	4.09	53.3	4.98	75.2	6.07	99.1	7.59	142.7	10.12	189.3	13.40
	18	29.3	3.31	40.0	4.13	53.3	5.03	75.2	6.13	99.1	7.66	142.7	10.22	189.3	13.53
	20	29.3	3.34	40.0	4.17	53.3	5.08	75.2	6.19	99.1	7.74	142.7	10.32	189.3	13.67
	21	29.3	3.38	40.0	4.30	66.8	6.34	88.3	7.37	110.3	9.51	154.1	12.98	198.9	15.38
	23	52.5	5.99	66.7	8.01	93.5	8.98	115.3	9.98	139.7	14.32	175.0	18.51	216.2	21.81
	25	75.5	9.50	93.5	12.01	120.3	13.42	142.4	15.83	165.9	20.57	195.6	26.91	233.1	31.65
	27	98.6	15.01	120.3	17.87	147.1	20.12	169.1	24.05	193.5	30.53	217.8	38.49	252.1	44.07
	29	121.6	20.84	147.0	24.06	173.8	29.54	196.6	34.78	221.0	41.46	240.0	48.77	265.9	54.09
	31	147.6	26.39	177.3	31.81	204.6	39.19	224.1	46.10	248.5	52.58	262.2	56.39	275.7	60.70
	33	171.1	32.52	204.6	41.51	231.9	50.44	252.7	56.35	268.7	63.25	277.0	64.99	284.0	65.08
	35	197.8	40.97	235.8	52.71	263.5	60.09	271.0	64.38	274.9	68.34	281.5	68.97	289.1	69.31
	37	197.8	43.42	235.8	55.94	263.5	63.44	267.2	68.21	270.1	72.08	277.7	72.33	284.4	72.53
	39	197.8	46.81	235.8	59.45	258.7	66.94	262.4	72.96	266.3	75.65	272.9	75.77	280.6	75.85
41	192.8	50.20	229.8	62.95	247.6	70.59	251.5	78.91	254.7	78.91	262.2	79.54	268.7	80.18	
43	188.0	52.72	224.1	65.58	237.3	74.85	241.2	75.70	244.3	75.53	251.6	75.96	257.9	76.17	
46	176.2	51.45	210.0	63.31	216.5	71.04	220.3	71.04	223.1	71.65	230.0	72.05	235.9	72.24	
48	155.9	49.97	182.6	60.99	188.0	67.59	191.5	68.04	194.0	68.37	200.0	68.56	205.3	68.84	

# 7. Capacity Tables

Cooling Capacity (88HP)

Combination (%)	Outdoor air temp. (DB, °C)	Indoor air temp. (DB/WB, °C)													
		20		23		26		27		28		30		32	
		14		16		18		19		20		22		24	
		TC	PI	TC	PI	TC	PI	TC	PI	TC	PI	TC	PI	TC	PI
100	10	26.9	2.91	36.7	3.64	48.9	4.42	69.0	5.40	90.9	6.75	130.9	9.00	173.6	11.91
	12	26.9	2.94	36.7	3.67	48.9	4.47	69.0	5.45	90.9	6.82	130.9	9.09	173.6	12.04
	14	26.9	2.97	36.7	3.71	48.9	4.52	69.0	5.51	90.9	6.89	130.9	9.19	173.6	12.16
	16	26.9	3.00	36.7	3.75	48.9	4.56	69.0	5.57	90.9	6.96	130.9	9.28	173.6	12.29
	18	26.9	3.04	36.7	3.79	48.9	4.61	69.0	5.62	90.9	7.03	130.9	9.38	173.6	12.42
	20	26.9	3.07	36.7	3.83	48.9	4.66	69.0	5.68	90.9	7.10	130.9	9.47	173.6	12.54
	21	26.9	3.10	36.7	3.94	60.9	5.82	81.0	6.77	103.6	8.72	141.3	11.90	182.5	14.11
	23	46.6	5.50	64.2	7.35	85.2	8.24	106.7	9.16	129.4	13.13	162.1	16.98	200.2	20.01
	25	66.5	8.71	86.6	11.02	109.4	12.32	133.1	14.52	155.1	18.88	182.8	24.68	217.9	29.04
	27	86.4	13.77	109.0	16.39	133.6	18.45	158.1	22.06	180.8	28.01	203.6	35.31	235.6	40.43
	29	106.3	19.12	131.4	22.08	157.9	27.10	183.7	31.91	206.5	38.04	224.3	45.65	253.3	49.62
	31	126.3	24.21	153.7	29.18	182.1	35.95	209.4	42.30	232.3	48.24	245.1	52.79	273.0	56.26
	33	146.2	29.84	176.1	38.09	206.4	46.27	235.1	53.67	258.2	58.61	266.2	59.63	273.0	60.93
	35	166.3	35.94	198.0	45.88	230.6	57.02	246.4	63.13	258.2	63.51	266.2	63.76	273.0	64.27
	37	166.3	38.49	198.0	49.21	230.6	60.40	246.4	66.14	254.0	66.46	261.3	66.73	267.5	67.35
	39	166.3	41.26	198.0	52.86	230.6	64.00	246.4	69.37	249.8	69.68	257.1	69.94	263.1	70.59
	41	163.7	44.04	194.9	56.51	226.9	67.61	236.4	72.60	241.6	72.89	247.3	73.15	255.3	73.83
43	158.1	46.61	188.2	59.91	219.1	70.84	226.7	75.38	229.3	75.65	236.4	75.89	242.6	76.61	
46	148.1	50.13	176.3	64.59	205.3	75.14	207.0	78.91	209.2	79.14	215.9	79.38	221.7	80.13	
48	131.0	43.29	156.0	55.88	177.3	64.24	179.9	66.96	181.7	67.17	187.7	67.32	192.8	67.86	
90	10	24.2	2.68	33.0	3.35	44.0	4.20	60.9	4.80	81.8	6.21	117.8	8.19	156.3	10.72
	12	24.2	2.71	33.0	3.38	44.0	4.25	60.9	4.85	81.8	6.27	117.8	8.27	156.3	10.84
	14	24.2	2.74	33.0	3.42	44.0	4.29	60.9	4.91	81.8	6.34	117.8	8.36	156.3	10.95
	16	24.2	2.76	33.0	3.45	44.0	4.34	60.9	4.96	81.8	6.40	117.8	8.45	156.3	11.06
	18	24.2	2.79	33.0	3.49	44.0	4.38	60.9	5.01	81.8	6.47	117.8	8.53	156.3	11.17
	20	24.2	2.82	33.0	3.52	44.0	4.42	60.9	5.06	81.8	6.53	117.8	8.62	156.3	11.29
	21	24.2	2.85	33.0	3.56	55.2	5.58	72.0	5.99	92.3	7.84	127.3	9.48	164.4	12.42
	23	32.8	4.41	48.5	6.11	77.0	7.90	93.4	8.61	112.8	11.52	146.3	14.05	181.2	17.08
	25	52.2	7.45	70.2	9.81	98.9	11.70	114.8	13.61	133.4	16.80	165.3	21.23	197.9	24.68
	27	71.7	10.95	91.9	13.96	120.7	18.16	136.2	20.23	153.9	24.50	184.4	28.57	214.6	32.30
	29	91.1	14.79	113.6	19.18	142.5	25.30	157.6	27.97	174.5	32.34	203.4	36.69	231.3	42.76
	31	110.5	18.50	135.3	24.63	164.3	31.68	179.0	35.69	195.0	40.29	222.4	42.71	248.0	49.68
	33	129.9	23.83	157.0	30.31	186.2	38.39	200.4	42.33	215.6	46.84	241.4	50.61	264.8	55.50
	35	149.6	29.50	178.6	37.30	207.7	46.12	221.8	50.87	235.8	55.31	260.3	59.33	264.8	60.69
	37	149.6	31.31	178.6	39.68	207.7	49.18	221.8	54.04	235.8	58.38	256.1	62.02	260.6	63.41
	39	149.6	33.15	178.6	42.20	207.7	52.05	221.8	57.50	235.8	61.39	251.9	65.39	256.4	66.17
	41	145.8	37.10	174.1	46.79	202.4	57.13	216.1	62.89	229.8	66.28	241.4	68.91	245.7	70.49
43	142.2	40.04	169.8	50.56	197.4	62.40	210.7	67.73	224.1	71.06	231.5	73.62	235.7	74.68	
46	133.2	45.07	159.1	57.58	185.0	71.10	197.5	76.78	203.6	78.95	211.3	79.38	215.3	80.13	
48	117.9	39.39	140.7	50.36	163.6	62.21	174.7	66.96	176.8	67.17	183.6	67.32	187.1	67.86	
80	10	20.7	2.37	28.2	2.96	37.6	3.72	53.1	4.28	70.0	5.49	100.8	7.24	133.7	9.48
	12	20.7	2.39	28.2	2.99	37.6	3.76	53.1	4.32	70.0	5.54	100.8	7.31	133.7	9.58
	14	20.7	2.42	28.2	3.02	37.6	3.79	53.1	4.37	70.0	5.60	100.8	7.39	133.7	9.68
	16	20.7	2.44	28.2	3.05	37.6	3.83	53.1	4.41	70.0	5.66	100.8	7.47	133.7	9.78
	18	20.7	2.47	28.2	3.08	37.6	3.87	53.1	4.46	70.0	5.72	100.8	7.54	133.7	9.88
	20	20.7	2.49	28.2	3.11	37.6	3.91	53.1	4.50	70.0	5.78	100.8	7.62	133.7	9.98
	21	20.7	2.51	28.2	3.20	47.3	4.93	63.4	5.39	79.3	6.93	109.6	8.38	142.1	10.98
	23	36.7	4.63	46.8	5.50	66.7	6.99	83.9	7.75	98.1	10.19	127.6	12.42	158.8	15.10
	25	52.7	6.70	65.4	8.83	86.2	10.34	104.4	12.25	116.8	14.85	145.6	18.77	175.4	21.82
	27	68.7	9.85	84.0	12.57	105.7	16.05	124.9	18.21	135.5	21.66	163.6	25.26	192.1	28.55
	29	84.8	12.78	102.6	17.26	125.1	22.37	145.4	25.17	154.2	28.59	181.5	32.43	208.8	37.80
	31	100.8	15.65	121.2	21.72	144.6	28.00	165.9	32.13	176.4	34.65	199.5	37.38	225.4	43.48
	33	116.8	20.59	139.7	26.73	164.1	32.92	186.5	38.10	197.5	39.81	217.5	44.29	242.1	48.95
	35	132.9	26.94	158.4	33.77	183.9	41.43	197.1	45.51	210.3	49.82	235.8	56.52	258.6	58.87
	37	132.9	28.50	158.4	35.90	183.9	43.95	197.1	48.38	210.3	52.93	235.8	59.65	254.4	61.84
	39	132.9	30.12	158.4	37.96	183.9	47.02	197.1	52.01	210.3	56.88	235.8	63.02	250.2	65.23
	41	129.5	33.32	154.3	42.06	179.2	51.60	192.1	57.01	204.9	62.50	229.8	67.53	239.7	69.08
43	126.3	36.68	150.5	45.90	174.8	56.32	187.3	62.13	199.9	68.30	224.1	72.14	229.8	73.94	
46	118.3	40.81	141.1	51.70	163.8	63.46	175.6	69.15	187.3	77.07	205.0	79.38	209.8	80.13	
48	104.7	35.64	124.8	45.21	144.9	55.50	155.3	60.41	165.7	67.17	178.0	67.32	182.3	67.86	

# 7. Capacity Tables

Cooling Capacity (88HP)

Combination (%)	Outdoor air temp. (DB, °C)	Indoor air temp. (DB/WB, °C)													
		20		23		26		27		28		30		32	
		14		16		18		19		20		22		24	
		TC	PI	TC	PI	TC	PI	TC	PI	TC	PI	TC	PI	TC	PI
70	10	18.0	2.09	24.6	2.61	32.8	3.29	46.2	3.81	60.9	4.85	87.7	6.40	116.3	8.38
	12	18.0	2.12	24.6	2.64	32.8	3.32	46.2	3.85	60.9	4.90	87.7	6.47	116.3	8.47
	14	18.0	2.14	24.6	2.67	32.8	3.35	46.2	3.89	60.9	4.95	87.7	6.53	116.3	8.56
	16	18.0	2.16	24.6	2.70	32.8	3.39	46.2	3.93	60.9	5.00	87.7	6.60	116.3	8.64
	18	18.0	2.18	24.6	2.72	32.8	3.42	46.2	3.97	60.9	5.05	87.7	6.67	116.3	8.73
	20	18.0	2.20	24.6	2.75	32.8	3.46	46.2	4.01	60.9	5.11	87.7	6.74	116.3	8.82
	21	18.0	2.22	28.6	3.23	42.5	4.53	57.2	5.03	70.4	6.13	96.7	7.41	125.2	9.70
	23	25.8	3.33	44.4	5.28	59.4	6.64	77.0	7.21	89.3	9.01	114.9	10.98	142.5	13.35
	25	40.9	5.50	60.1	7.80	76.3	9.14	96.8	11.39	108.2	13.13	133.1	16.59	159.9	19.29
	27	56.0	8.01	75.8	11.11	93.2	13.49	116.6	16.93	127.2	19.15	151.2	22.33	177.2	25.24
	29	71.1	10.16	91.5	14.67	110.1	18.34	136.4	23.03	146.1	25.27	169.4	28.67	194.6	33.41
	31	86.1	12.50	107.2	18.25	127.0	22.96	156.3	28.94	165.0	30.63	187.6	33.04	211.9	38.44
	33	101.2	16.82	123.0	22.19	143.9	26.67	172.5	33.60	183.9	35.19	205.9	39.16	228.8	43.27
	35	116.2	23.02	139.0	28.69	161.0	34.71	172.5	37.96	183.9	41.46	205.9	48.81	228.8	53.51
	37	116.2	24.46	139.0	30.38	161.0	36.88	172.5	40.37	183.9	44.11	205.9	51.94	228.8	56.48
	39	116.2	25.98	139.0	32.39	161.0	39.43	172.5	43.44	183.9	47.65	205.9	55.59	228.8	60.89
	41	113.2	28.72	135.5	35.49	156.9	43.25	168.1	47.64	179.2	51.80	200.7	61.06	222.9	65.63
43	110.4	31.26	132.1	38.68	153.0	47.19	163.9	51.95	174.8	56.56	195.7	66.70	217.4	70.98	
46	103.5	34.74	123.8	43.49	143.4	53.15	153.6	57.87	163.8	63.76	183.4	75.23	203.8	79.15	
48	91.5	30.32	109.5	37.99	126.9	46.47	135.9	50.57	144.9	55.78	162.2	65.83	180.3	67.86	
60	10	15.9	1.78	21.3	2.22	28.4	2.79	40.0	3.25	52.7	4.11	75.9	5.43	100.7	7.11
	12	15.9	1.79	21.3	2.24	28.4	2.82	40.0	3.28	52.7	4.16	75.9	5.48	100.7	7.18
	14	15.9	1.81	21.3	2.26	28.4	2.84	40.0	3.32	52.7	4.20	75.9	5.54	100.7	7.26
	16	15.9	1.83	21.3	2.29	28.4	2.87	40.0	3.35	52.7	4.24	75.9	5.60	100.7	7.33
	18	15.9	1.85	21.3	2.31	28.4	2.90	40.0	3.39	52.7	4.29	75.9	5.66	100.7	7.41
	20	15.9	1.87	21.3	2.33	28.4	2.93	40.0	3.42	52.7	4.33	75.9	5.71	100.7	7.48
	21	15.9	1.88	21.3	2.42	35.5	3.76	47.0	4.15	60.5	5.20	82.4	6.28	107.1	8.23
	23	15.9	2.08	35.2	4.38	50.1	5.63	65.1	6.02	76.2	7.64	95.9	9.31	119.8	11.32
	25	29.5	3.96	49.2	6.62	64.8	7.76	83.8	10.27	91.9	11.14	111.5	13.79	132.6	16.36
	27	43.5	5.77	63.1	9.42	79.4	11.44	101.2	14.30	107.6	15.98	125.3	18.27	145.3	21.07
	29	57.4	7.49	77.0	12.07	94.0	15.25	119.4	18.79	123.3	20.37	139.0	22.91	158.0	26.93
	31	71.4	9.52	91.0	14.44	108.7	18.57	134.0	22.54	139.1	23.66	155.7	25.36	170.7	31.04
	33	85.3	13.26	104.9	17.55	123.3	20.85	144.6	25.28	154.9	27.08	168.1	30.06	183.4	35.35
	35	99.4	19.53	118.8	23.89	138.2	28.62	147.8	31.17	157.5	33.84	176.9	39.54	196.2	45.60
	37	99.4	20.62	118.8	25.21	138.2	30.32	147.8	33.11	157.5	35.90	176.9	41.96	196.2	48.51
	39	99.4	21.93	118.8	26.85	138.2	32.73	147.8	35.52	157.5	38.63	176.9	44.99	196.2	51.98
	41	96.9	23.78	115.8	29.38	134.6	35.54	144.1	38.80	153.5	41.94	172.4	49.38	191.2	56.49
43	94.5	25.84	112.9	31.99	131.3	38.74	140.5	42.29	149.7	45.73	168.1	53.90	186.5	61.70	
46	88.6	28.94	105.8	35.91	123.0	43.58	131.7	47.53	140.3	51.46	157.5	60.74	174.8	70.30	
48	78.3	25.22	93.6	31.34	108.8	38.07	116.5	41.52	124.1	44.97	139.4	53.12	154.6	61.51	
50	10	14.3	1.51	19.4	1.88	27.4	2.36	36.6	2.90	48.2	3.49	69.4	4.61	92.0	6.00
	12	14.3	1.52	19.4	1.90	27.4	2.39	36.6	2.93	48.2	3.53	69.4	4.65	92.0	6.07
	14	14.3	1.54	19.4	1.92	27.4	2.41	36.6	2.96	48.2	3.56	69.4	4.70	92.0	6.13
	16	14.3	1.55	19.4	1.94	27.4	2.44	36.6	2.99	48.2	3.60	69.4	4.75	92.0	6.19
	18	14.3	1.57	19.4	1.96	27.4	2.46	36.6	3.02	48.2	3.64	69.4	4.80	92.0	6.26
	20	14.3	1.59	19.4	1.98	27.4	2.49	36.6	3.05	48.2	3.68	69.4	4.85	92.0	6.32
	21	14.3	1.60	19.4	2.05	34.1	3.19	43.1	3.66	54.8	4.41	75.3	5.33	97.0	6.95
	23	14.3	1.70	30.8	3.49	47.2	4.78	60.9	5.72	69.4	6.48	86.7	7.90	107.1	9.56
	25	25.6	3.09	42.3	5.15	60.4	6.70	80.6	9.27	85.3	9.45	98.2	11.12	117.1	13.51
	27	37.1	4.43	53.7	7.24	74.8	9.33	93.4	12.35	99.1	12.73	109.6	14.55	127.2	17.19
	29	48.5	5.82	65.1	9.33	86.7	12.00	105.1	15.33	113.0	16.42	121.0	18.04	137.2	21.71
	31	60.0	7.40	76.6	11.09	98.6	14.62	114.3	17.10	121.0	18.17	132.3	19.48	147.3	23.89
	33	71.5	10.31	88.0	13.35	110.5	16.41	118.8	18.74	126.0	20.07	143.1	23.08	157.1	26.81
	35	83.2	16.23	99.4	19.53	115.3	23.07	123.2	25.02	131.1	26.97	147.0	31.12	163.7	35.76
	37	83.2	17.21	99.4	20.63	115.3	24.41	123.2	26.48	131.1	28.56	147.0	33.20	163.7	37.96
	39	83.2	18.36	99.4	22.11	115.3	26.15	123.2	28.51	131.1	30.64	147.0	35.36	163.7	41.00
	41	81.0	19.85	96.9	23.93	112.3	28.60	120.0	30.88	127.8	33.20	143.2	38.76	159.5	44.52
43	79.0	21.57	94.5	26.03	109.6	31.11	117.1	33.62	124.6	36.14	139.7	42.26	155.5	48.56	
46	74.1	24.16	88.6	29.20	102.7	34.90	109.7	37.75	116.8	40.58	130.9	47.55	145.8	54.67	
48	65.5	21.05	78.3	25.46	90.8	30.45	97.1	32.95	103.3	35.42	115.8	41.56	129.0	47.79	

**Note**

1. TC: Total Capacity(kW), PI : Power Input(kW, Comp. + Outdoor fan motor)
2. Capacity tables show the average value of conditions which may occur.

# 7. Capacity Tables

◆ ARUM900LTE5

Cooling Capacity (90HP)

Combination (%)	Outdoor air temp. (DB, °C)	Indoor air temp. (DB/WB, °C)													
		20		23		26		27		28		30		32	
		14	16	18	19	20	22	24	TC	PI	TC	PI	TC	PI	
130	10	35.5	3.62	48.4	4.52	64.5	5.50	91.0	6.71	120.0	8.38	172.7	11.18	229.1	14.80
	12	35.5	3.66	48.4	4.57	64.5	5.56	91.0	6.78	120.0	8.47	172.7	11.30	229.1	14.96
	14	35.5	3.70	48.4	4.61	64.5	5.61	91.0	6.85	120.0	8.56	172.7	11.42	229.1	15.11
	16	35.5	3.73	48.4	4.66	64.5	5.67	91.0	6.92	120.0	8.65	172.7	11.53	229.1	15.27
	18	35.5	3.77	48.4	4.71	64.5	5.73	91.0	6.99	120.0	8.74	172.7	11.65	229.1	15.43
	20	35.5	3.81	48.4	4.76	64.5	5.79	91.0	7.06	120.0	8.82	172.7	11.77	229.1	15.58
	21	35.5	3.85	49.1	4.90	79.9	7.23	106.1	8.41	134.1	10.84	183.9	14.79	236.3	17.54
	23	61.6	6.83	85.9	8.98	111.0	10.24	138.6	11.38	162.4	16.32	206.7	21.10	251.0	24.86
	25	91.1	10.83	110.4	13.47	142.2	15.30	172.8	18.04	190.7	23.45	229.5	30.67	265.8	36.08
	27	118.9	17.25	141.1	20.37	173.3	23.12	205.3	27.64	219.0	35.08	252.3	44.23	280.5	49.84
	29	146.7	23.95	171.8	28.09	204.4	33.94	238.7	39.97	247.2	47.64	275.3	57.18	295.3	63.64
	31	178.1	31.29	206.5	38.60	240.3	46.83	268.7	54.68	275.5	62.36	290.7	78.33	310.6	79.44
	33	209.5	38.57	244.8	50.38	274.8	60.28	290.4	78.26	296.7	77.71	305.9	78.40	326.6	79.51
	35	249.6	52.10	286.0	63.15	295.2	76.62	300.3	77.01	305.2	77.47	313.5	78.16	322.6	78.47
	37	249.6	55.55	282.0	66.27	291.2	75.61	295.2	75.99	300.3	76.45	308.5	77.13	317.6	77.43
	39	249.6	59.16	277.0	69.75	286.0	74.60	291.2	74.97	295.2	75.42	304.3	76.10	313.5	76.40
41	243.2	62.76	265.5	73.24	274.5	73.59	278.6	73.96	284.0	74.40	292.6	75.07	300.5	75.36	
43	237.2	66.19	254.5	72.21	263.3	72.57	267.3	72.94	272.6	73.38	281.0	74.03	288.7	74.33	
46	222.3	70.85	232.1	70.70	240.5	71.06	244.3	71.41	249.4	71.84	257.2	72.48	264.3	72.77	
48	196.6	68.87	201.6	69.08	209.1	69.22	212.5	69.41	217.0	70.01	223.9	70.45	230.2	70.73	
120	10	32.7	3.39	44.6	4.23	59.5	5.14	84.0	6.27	110.7	7.84	159.3	10.46	211.3	13.85
	12	32.7	3.42	44.6	4.27	59.5	5.20	84.0	6.34	110.7	7.93	159.3	10.57	211.3	13.99
	14	32.7	3.46	44.6	4.32	59.5	5.25	84.0	6.41	110.7	8.01	159.3	10.68	211.3	14.14
	16	32.7	3.49	44.6	4.36	59.5	5.31	84.0	6.47	110.7	8.09	159.3	10.79	211.3	14.29
	18	32.7	3.53	44.6	4.41	59.5	5.36	84.0	6.54	110.7	8.17	159.3	10.90	211.3	14.43
	20	32.7	3.56	44.6	4.45	59.5	5.41	84.0	6.60	110.7	8.26	159.3	11.01	211.3	14.58
	21	32.7	3.60	45.4	4.58	75.3	6.90	97.8	7.86	125.1	10.14	170.6	13.84	219.0	16.41
	23	56.7	6.39	81.5	8.54	107.1	9.82	127.7	10.65	154.8	15.27	193.9	19.74	234.1	23.25
	25	88.5	10.13	114.3	12.81	140.2	14.32	159.2	16.88	185.6	21.94	218.8	28.69	249.3	33.76
	27	122.9	16.01	155.4	19.05	174.0	21.45	189.1	25.65	216.4	32.56	243.6	41.05	264.5	47.00
	29	157.7	22.22	187.1	25.66	207.4	31.50	219.9	37.09	247.1	44.21	268.4	53.07	279.8	59.67
	31	191.0	28.14	225.4	33.92	241.1	41.79	253.1	49.17	278.9	56.07	286.6	67.44	296.2	68.70
	33	221.3	34.68	265.9	44.27	281.7	53.79	285.6	62.39	290.5	73.40	298.4	74.23	307.8	74.83
	35	225.9	46.33	268.6	60.02	284.5	66.39	288.5	79.08	293.5	79.47	301.5	79.71	309.3	80.34
	37	225.9	49.84	268.6	63.33	280.5	70.78	284.5	77.41	288.5	77.80	296.5	78.03	304.4	78.65
	39	225.9	53.65	267.6	66.94	275.6	75.07	279.5	75.82	283.5	76.20	292.5	76.43	300.4	77.04
41	220.1	57.47	255.9	70.54	264.6	73.59	268.3	74.23	272.2	74.60	280.1	74.83	288.1	75.42	
43	214.6	61.34	245.2	69.53	253.7	71.94	257.4	72.64	261.2	73.00	268.9	73.22	276.6	73.80	
46	201.1	65.96	223.6	67.87	231.7	69.68	235.1	70.26	238.7	70.61	245.9	70.82	253.2	71.38	
48	177.9	64.61	194.1	66.67	201.4	68.32	204.4	68.74	207.6	68.96	213.9	69.23	220.4	69.51	
110	10	30.0	3.18	40.9	3.97	54.5	4.83	76.9	5.90	101.4	7.37	145.9	9.83	193.6	13.01
	12	30.0	3.21	40.9	4.01	54.5	4.88	76.9	5.96	101.4	7.45	145.9	9.93	193.6	13.15
	14	30.0	3.25	40.9	4.06	54.5	4.93	76.9	6.02	101.4	7.52	145.9	10.03	193.6	13.29
	16	30.0	3.28	40.9	4.10	54.5	4.99	76.9	6.08	101.4	7.60	145.9	10.14	193.6	13.42
	18	30.0	3.32	40.9	4.14	54.5	5.04	76.9	6.14	101.4	7.68	145.9	10.24	193.6	13.56
	20	30.0	3.35	40.9	4.18	54.5	5.09	76.9	6.21	101.4	7.76	145.9	10.35	193.6	13.70
	21	30.0	3.38	40.9	4.31	68.3	6.36	90.3	7.39	112.8	9.53	157.6	13.00	203.5	15.42
	23	53.7	6.00	68.3	8.02	95.7	9.00	117.9	10.01	142.9	14.35	179.0	18.55	221.1	21.85
	25	77.2	9.52	95.6	12.04	123.0	13.45	145.6	15.86	169.7	20.62	200.1	26.96	238.4	31.72
	27	100.8	15.04	123.0	17.90	150.4	20.16	173.0	24.10	197.9	30.59	222.8	38.57	257.8	44.16
	29	124.4	20.88	150.4	24.11	177.8	29.60	201.1	34.86	226.0	41.54	245.5	48.87	272.0	54.20
	31	151.0	26.44	181.3	31.88	209.2	39.27	229.2	46.20	254.2	52.69	268.2	56.50	282.0	60.83
	33	175.0	32.59	209.2	41.60	237.1	50.54	258.5	56.47	274.8	63.38	283.3	65.13	290.5	65.22
	35	202.3	41.05	241.2	52.82	269.4	60.22	277.2	64.51	281.1	68.48	287.9	69.11	295.7	69.45
	37	202.3	43.51	241.2	56.06	269.4	63.57	273.3	68.35	276.2	72.22	284.0	72.48	290.8	72.68
	39	202.3	46.91	241.2	59.57	264.5	67.07	268.4	73.11	272.4	75.80	279.1	75.93	287.0	76.01
41	197.1	50.31	235.0	63.08	253.2	70.73	257.2	79.08	260.5	79.08	268.1	79.71	274.8	80.34	
43	192.3	52.83	229.2	65.72	242.7	75.01	246.7	75.85	249.9	75.69	257.3	76.12	263.8	76.33	
46	180.2	51.56	214.8	63.44	221.4	71.18	225.3	71.18	228.2	71.80	235.2	72.19	241.3	72.39	
48	159.4	50.07	186.7	61.12	192.3	67.73	195.8	68.18	198.4	68.51	204.5	68.70	209.9	68.98	



# 7. Capacity Tables

Cooling Capacity (90HP)

Combination (%)	Outdoor air temp. (DB, °C)	Indoor air temp. (DB/WB, °C)													
		20		23		26		27		28		30		32	
		14		16		18		19		20		22		24	
		TC	PI	TC	PI	TC	PI	TC	PI	TC	PI	TC	PI	TC	PI
100	10	27.5	2.92	37.5	3.64	50.0	4.43	70.6	5.41	93.0	6.76	133.9	9.02	177.6	11.94
	12	27.5	2.95	37.5	3.68	50.0	4.48	70.6	5.47	93.0	6.83	133.9	9.11	177.6	12.06
	14	27.5	2.98	37.5	3.72	50.0	4.53	70.6	5.52	93.0	6.90	133.9	9.21	177.6	12.19
	16	27.5	3.01	37.5	3.76	50.0	4.57	70.6	5.58	93.0	6.97	133.9	9.30	177.6	12.32
	18	27.5	3.04	37.5	3.80	50.0	4.62	70.6	5.64	93.0	7.05	133.9	9.40	177.6	12.44
	20	27.5	3.07	37.5	3.84	50.0	4.67	70.6	5.69	93.0	7.12	133.9	9.49	177.6	12.57
	21	27.5	3.10	37.5	3.95	62.3	5.83	82.9	6.78	106.0	8.74	144.5	11.93	186.7	14.14
	23	47.7	5.51	65.7	7.36	87.1	8.25	109.1	9.18	132.3	13.16	165.8	17.02	204.8	20.05
	25	68.0	8.73	88.6	11.04	111.9	12.34	136.1	14.55	158.6	18.91	187.0	24.73	222.8	29.10
	27	88.4	13.80	111.5	16.42	136.7	18.49	161.7	22.11	184.9	28.07	208.2	35.38	240.9	40.52
	29	108.8	19.16	134.3	22.12	161.5	27.15	187.9	31.98	211.2	38.11	229.4	45.75	259.0	49.72
	31	129.1	24.26	157.2	29.25	186.3	36.03	214.2	42.38	237.5	48.34	250.6	52.90	279.2	56.37
	33	149.5	29.90	180.1	38.16	211.1	46.37	240.4	53.78	264.1	58.73	272.3	59.75	279.2	61.05
	35	170.1	36.01	202.5	45.97	235.8	57.14	252.0	63.26	264.1	63.64	272.3	63.89	279.2	64.40
	37	170.1	38.57	202.5	49.31	235.8	60.53	252.0	66.27	259.8	66.60	267.2	66.86	273.6	67.48
	39	170.1	41.35	202.5	52.97	235.8	64.14	252.0	69.51	255.4	69.82	263.0	70.08	269.1	70.73
	41	167.4	44.13	199.3	56.63	232.1	67.75	241.8	72.75	247.1	73.04	252.9	73.30	261.1	73.98
43	161.6	46.70	192.4	60.04	224.1	70.99	231.8	75.53	234.5	75.80	241.8	76.05	248.1	76.76	
46	151.5	50.23	180.3	64.72	210.0	75.29	211.7	79.08	214.0	79.31	220.8	79.54	226.8	80.29	
48	134.0	43.38	159.5	56.00	181.3	64.37	184.0	67.09	185.9	67.31	192.0	67.46	197.2	68.00	
90	10	24.7	2.69	33.7	3.35	45.0	4.21	62.2	4.81	83.7	6.22	120.5	8.20	159.8	10.74
	12	24.7	2.71	33.7	3.39	45.0	4.26	62.2	4.86	83.7	6.29	120.5	8.29	159.8	10.86
	14	24.7	2.74	33.7	3.42	45.0	4.30	62.2	4.92	83.7	6.35	120.5	8.38	159.8	10.97
	16	24.7	2.77	33.7	3.46	45.0	4.35	62.2	4.97	83.7	6.42	120.5	8.46	159.8	11.08
	18	24.7	2.80	33.7	3.49	45.0	4.39	62.2	5.02	83.7	6.48	120.5	8.55	159.8	11.20
	20	24.7	2.83	33.7	3.53	45.0	4.43	62.2	5.07	83.7	6.55	120.5	8.64	159.8	11.31
	21	24.7	2.85	33.7	3.56	56.4	5.59	73.7	6.00	94.3	7.86	130.2	9.50	168.2	12.44
	23	33.6	4.42	49.6	6.13	78.8	7.92	95.6	8.63	115.4	11.55	149.6	14.07	185.3	17.11
	25	53.4	7.46	71.8	9.83	101.1	11.72	117.4	13.64	136.4	16.83	169.1	21.27	202.4	24.73
	27	73.3	10.97	94.0	13.99	123.4	18.20	139.3	20.27	157.4	24.55	188.5	28.63	219.4	32.36
	29	93.1	14.82	116.2	19.22	145.8	25.35	161.2	28.03	178.4	32.41	208.0	36.76	236.5	42.84
	31	113.0	18.54	138.3	24.68	168.1	31.74	183.1	35.77	199.4	40.37	227.5	42.80	253.6	49.79
	33	132.9	23.88	160.5	30.37	190.4	38.47	204.9	42.42	220.4	46.93	246.9	50.72	270.8	55.61
	35	153.0	29.56	182.7	37.38	212.4	46.22	226.8	50.97	241.2	55.42	266.2	59.45	270.8	60.82
	37	153.0	31.38	182.7	39.76	212.4	49.28	226.8	54.15	241.2	58.50	262.0	62.15	266.5	63.54
	39	153.0	33.22	182.7	42.29	212.4	52.15	226.8	57.62	241.2	61.52	257.7	65.52	262.2	66.31
	41	149.1	37.17	178.0	46.88	207.0	57.24	221.0	63.02	235.0	66.41	246.9	69.05	251.3	70.63
43	145.4	40.12	173.6	50.66	201.8	62.53	215.5	67.87	229.2	71.21	236.7	73.77	241.0	74.84	
46	136.3	45.16	162.7	57.70	189.2	71.24	202.0	76.94	208.3	79.12	216.1	79.54	220.2	80.29	
48	120.5	39.47	143.9	50.47	167.3	62.33	178.7	67.09	180.9	67.31	187.8	67.46	191.4	68.00	
80	10	21.2	2.37	28.9	2.96	38.5	3.72	54.3	4.28	71.6	5.50	103.1	7.25	136.7	9.50
	12	21.2	2.40	28.9	2.99	38.5	3.76	54.3	4.33	71.6	5.56	103.1	7.33	136.7	9.60
	14	21.2	2.42	28.9	3.03	38.5	3.80	54.3	4.37	71.6	5.61	103.1	7.41	136.7	9.70
	16	21.2	2.45	28.9	3.06	38.5	3.84	54.3	4.42	71.6	5.67	103.1	7.48	136.7	9.80
	18	21.2	2.47	28.9	3.09	38.5	3.88	54.3	4.46	71.6	5.73	103.1	7.56	136.7	9.90
	20	21.2	2.50	28.9	3.12	38.5	3.92	54.3	4.51	71.6	5.79	103.1	7.63	136.7	10.00
	21	21.2	2.51	28.9	3.21	48.3	4.94	64.8	5.40	81.1	6.95	112.1	8.40	145.4	11.00
	23	37.5	4.64	47.9	5.51	68.2	7.00	85.8	7.77	100.3	10.21	130.5	12.44	162.4	15.13
	25	53.9	6.72	66.9	8.84	88.1	10.36	106.8	12.27	119.4	14.88	148.9	18.80	179.4	21.87
	27	70.3	9.87	85.9	12.59	108.1	16.09	127.7	18.25	138.6	21.70	167.3	25.31	196.5	28.61
	29	86.7	12.80	104.9	17.30	128.0	22.41	148.7	25.23	157.8	28.65	185.7	32.50	213.5	37.87
	31	103.1	15.69	123.9	21.77	147.9	28.06	169.7	32.19	180.4	34.72	204.1	37.45	230.5	43.57
	33	119.4	20.63	142.9	26.79	167.8	32.99	190.8	38.17	201.9	39.89	222.5	44.38	247.6	49.05
	35	135.9	27.00	162.0	33.84	188.1	41.52	201.6	45.60	215.1	49.92	241.2	56.64	264.5	58.99
	37	135.9	28.56	162.0	35.98	188.1	44.04	201.6	48.48	215.1	53.04	241.2	59.77	260.2	61.97
	39	135.9	30.18	162.0	38.04	188.1	47.11	201.6	52.12	215.1	57.00	241.2	63.15	255.9	65.37
	41	132.4	33.39	157.9	42.15	183.3	51.70	196.4	57.13	209.6	62.63	235.0	67.67	245.2	69.22
43	129.1	36.76	154.0	46.00	178.8	56.44	191.6	62.26	204.4	68.44	229.2	72.29	235.0	74.09	
46	121.0	40.89	144.3	51.81	167.5	63.59	179.5	69.30	191.6	77.23	209.6	79.54	214.6	80.29	
48	107.1	35.71	127.6	45.30	148.2	55.61	158.8	60.53	169.5	67.31	182.1	67.46	186.4	68.00	

# 7. Capacity Tables

Cooling Capacity (90HP)

Combination (%)	Outdoor air temp. (DB, °C)	Indoor air temp. (DB/WB, °C)													
		20		23		26		27		28		30		32	
		14		16		18		19		20		22		24	
		TC	PI	TC	PI	TC	PI	TC	PI	TC	PI	TC	PI	TC	PI
70	10	18.4	2.10	25.1	2.62	33.5	3.29	47.3	3.81	62.3	4.86	89.7	6.41	119.0	8.40
	12	18.4	2.12	25.1	2.65	33.5	3.33	47.3	3.85	62.3	4.91	89.7	6.48	119.0	8.48
	14	18.4	2.14	25.1	2.67	33.5	3.36	47.3	3.89	62.3	4.96	89.7	6.55	119.0	8.57
	16	18.4	2.16	25.1	2.70	33.5	3.40	47.3	3.93	62.3	5.01	89.7	6.61	119.0	8.66
	18	18.4	2.19	25.1	2.73	33.5	3.43	47.3	3.97	62.3	5.07	89.7	6.68	119.0	8.75
	20	18.4	2.21	25.1	2.76	33.5	3.47	47.3	4.01	62.3	5.12	89.7	6.75	119.0	8.84
	21	18.4	2.22	29.3	3.24	43.5	4.54	58.5	5.04	72.0	6.14	98.9	7.42	128.0	9.72
	23	26.4	3.34	45.4	5.29	60.8	6.65	78.8	7.22	91.4	9.02	117.5	11.00	145.8	13.37
	25	41.8	5.51	61.4	7.82	78.1	9.16	99.0	11.41	110.7	13.16	136.1	16.62	163.5	19.33
	27	57.3	8.03	77.5	11.13	95.4	13.51	119.3	16.97	130.1	19.19	154.7	22.37	181.3	25.29
	29	72.7	10.18	93.6	14.70	112.6	18.38	139.5	23.08	149.4	25.32	173.3	28.73	199.0	33.48
	31	88.1	12.53	109.7	18.28	129.9	23.01	159.8	29.00	168.8	30.69	191.9	33.11	216.7	38.52
	33	103.5	16.85	125.7	22.23	147.2	26.72	176.4	33.67	188.1	35.26	210.6	39.24	234.0	43.36
	35	118.8	23.07	142.2	28.75	164.7	34.78	176.4	38.04	188.1	41.54	210.6	48.91	234.0	53.62
	37	118.8	24.52	142.2	30.45	164.7	36.95	176.4	40.46	188.1	44.20	210.6	52.05	234.0	56.59
	39	118.8	26.03	142.2	32.46	164.7	39.51	176.4	43.53	188.1	47.75	210.6	55.70	234.0	61.01
	41	115.8	28.78	138.6	35.56	160.5	43.34	171.9	47.74	183.3	51.91	205.2	61.18	228.0	65.76
43	112.9	31.33	135.1	38.76	156.5	47.29	167.6	52.06	178.8	56.68	200.1	66.84	222.4	71.13	
46	105.8	34.81	126.6	43.58	146.7	53.26	157.1	57.99	167.5	63.89	187.6	75.39	208.4	79.32	
48	93.6	30.38	112.0	38.07	129.8	46.56	139.0	50.67	148.2	55.90	165.9	65.97	184.4	68.00	
60	10	16.2	1.79	21.7	2.24	29.0	2.82	40.9	3.28	53.9	4.16	77.6	5.48	103.0	7.18
	12	16.2	1.81	21.7	2.26	29.0	2.84	40.9	3.32	53.9	4.20	77.6	5.54	103.0	7.26
	14	16.2	1.83	21.7	2.29	29.0	2.87	40.9	3.35	53.9	4.24	77.6	5.60	103.0	7.33
	16	16.2	1.85	21.7	2.31	29.0	2.90	40.9	3.39	53.9	4.29	77.6	5.66	103.0	7.41
	18	16.2	1.87	21.7	2.33	29.0	2.93	40.9	3.42	53.9	4.33	77.6	5.71	103.0	7.48
	20	16.2	1.89	21.7	2.36	29.0	2.96	40.9	3.46	53.9	4.38	77.6	5.77	103.0	7.56
	21	16.2	1.90	21.7	2.44	36.3	3.80	48.1	4.19	61.8	5.25	84.3	6.35	109.6	8.31
	23	16.2	2.10	36.0	4.43	51.3	5.69	66.6	6.08	77.9	7.72	98.1	9.41	122.6	11.44
	25	30.2	4.00	50.3	6.69	66.2	7.84	85.7	10.38	94.0	11.25	114.1	13.93	135.6	16.53
	27	44.5	5.83	64.5	9.52	81.2	11.56	103.5	14.45	110.1	16.15	128.1	18.46	148.6	21.29
	29	58.7	7.57	78.8	12.20	96.2	15.40	122.1	18.98	126.2	20.58	142.1	23.15	161.6	27.21
	31	73.0	9.62	93.1	14.58	111.1	18.76	137.1	22.78	142.2	23.91	159.2	25.63	174.6	31.36
	33	87.2	13.39	107.3	17.74	126.1	21.06	147.9	25.54	158.5	27.36	171.9	30.37	187.6	35.71
	35	101.7	19.57	121.5	23.94	141.3	28.68	151.2	31.23	161.1	33.91	180.9	39.62	200.7	45.70
	37	101.7	20.66	121.5	25.27	141.3	30.38	151.2	33.18	161.1	35.97	180.9	42.05	200.7	48.61
	39	101.7	21.97	121.5	26.90	141.3	32.79	151.2	35.60	161.1	38.71	180.9	45.09	200.7	52.09
	41	99.1	23.83	118.4	29.44	137.7	35.61	147.3	38.88	157.0	42.02	176.3	49.48	195.6	56.61
43	96.6	25.90	115.5	32.05	134.3	38.82	143.7	42.37	153.1	45.82	171.9	54.01	190.7	61.83	
46	90.6	29.00	108.2	35.99	125.8	43.67	134.7	47.63	143.5	51.56	161.1	60.86	178.7	70.44	
48	80.1	25.27	95.7	31.41	111.3	38.15	119.1	41.60	126.9	45.06	142.5	53.23	158.1	61.63	
50	10	14.6	1.54	19.9	1.92	28.0	2.41	37.4	2.96	49.3	3.56	71.0	4.70	94.1	6.12
	12	14.6	1.55	19.9	1.94	28.0	2.44	37.4	2.99	49.3	3.60	71.0	4.75	94.1	6.19
	14	14.6	1.57	19.9	1.96	28.0	2.46	37.4	3.02	49.3	3.64	71.0	4.80	94.1	6.25
	16	14.6	1.59	19.9	1.98	28.0	2.49	37.4	3.05	49.3	3.67	71.0	4.85	94.1	6.32
	18	14.6	1.60	19.9	2.00	28.0	2.51	37.4	3.08	49.3	3.71	71.0	4.89	94.1	6.38
	20	14.6	1.62	19.9	2.02	28.0	2.54	37.4	3.11	49.3	3.75	71.0	4.94	94.1	6.44
	21	14.6	1.63	19.9	2.09	34.8	3.26	44.1	3.74	56.0	4.50	77.0	5.44	99.2	7.09
	23	14.6	1.73	31.5	3.56	48.3	4.87	62.3	5.83	70.9	6.61	88.7	8.06	109.5	9.75
	25	26.2	3.16	43.2	5.25	61.7	6.83	82.4	9.45	87.2	9.64	100.4	11.34	119.8	13.77
	27	37.9	4.52	54.9	7.38	76.5	9.52	95.5	12.60	101.4	12.99	112.1	14.84	130.1	17.53
	29	49.6	5.94	66.6	9.51	88.7	12.24	107.5	15.63	115.6	16.75	123.8	18.39	140.3	22.14
	31	61.4	7.55	78.3	11.31	100.9	14.91	116.9	17.43	123.7	18.53	135.3	19.86	150.6	24.36
	33	73.1	10.51	90.0	13.61	113.0	16.74	121.5	19.11	128.9	20.47	146.3	23.54	160.7	27.34
	35	85.1	16.27	101.7	19.57	117.9	23.11	126.0	25.07	134.1	27.03	150.3	31.19	167.4	35.83
	37	85.1	17.24	101.7	20.67	117.9	24.46	126.0	26.54	134.1	28.62	150.3	33.26	167.4	38.03
	39	85.1	18.39	101.7	22.15	117.9	26.21	126.0	28.57	134.1	30.71	150.3	35.43	167.4	41.08
	41	82.9	19.89	99.1	23.98	114.9	28.66	122.8	30.94	130.7	33.27	146.5	38.84	163.1	44.61
43	80.8	21.61	96.6	26.09	112.0	31.18	119.7	33.69	127.4	36.22	142.8	42.35	159.1	48.66	
46	75.7	24.21	90.6	29.26	105.0	34.98	112.2	37.83	119.4	40.66	133.9	47.65	149.1	54.79	
48	67.0	21.10	80.1	25.52	92.9	30.51	99.3	33.02	105.6	35.49	118.4	41.64	131.9	47.89	

**Note**

1. TC: Total Capacity(kW), PI : Power Input(kW, Comp. + Outdoor fan motor)
2. Capacity tables show the average value of conditions which may occur.

# 7. Capacity Tables

◆ ARUM920LTE5

Cooling Capacity (92HP)

Combination (%)	Outdoor air temp. (DB, °C)	Indoor air temp. (DB/WB, °C)													
		20		23		26		27		28		30		32	
		14	PI	16	PI	18	PI	19	PI	20	PI	22	PI	24	PI
130	10	36.3	3.72	49.4	4.64	65.9	5.65	93.0	6.89	122.6	8.61	176.5	11.49	234.2	15.21
	12	36.3	3.76	49.4	4.69	65.9	5.71	93.0	6.96	122.6	8.70	176.5	11.61	234.2	15.37
	14	36.3	3.80	49.4	4.74	65.9	5.77	93.0	7.04	122.6	8.79	176.5	11.73	234.2	15.53
	16	36.3	3.84	49.4	4.79	65.9	5.83	93.0	7.11	122.6	8.88	176.5	11.85	234.2	15.69
	18	36.3	3.87	49.4	4.84	65.9	5.89	93.0	7.18	122.6	8.98	176.5	11.97	234.2	15.85
	20	36.3	3.91	49.4	4.89	65.9	5.95	93.0	7.25	122.6	9.07	176.5	12.09	234.2	16.01
	21	36.3	3.95	50.2	5.03	81.6	7.43	108.4	8.64	137.1	11.14	188.0	15.20	241.6	18.02
	23	63.0	7.02	87.8	9.23	113.5	10.52	141.7	11.69	166.0	16.77	211.3	21.68	256.6	25.54
	25	93.1	11.12	112.8	13.84	145.3	15.72	176.7	18.54	194.9	24.10	234.6	31.51	271.7	37.07
	27	121.6	17.72	144.2	20.92	177.2	23.75	209.9	28.39	223.8	36.04	257.9	45.44	286.7	51.20
	29	150.0	24.60	175.6	28.86	209.0	34.87	244.0	41.07	252.7	48.94	281.4	58.75	301.9	65.38
	31	182.0	32.15	211.1	39.66	245.6	48.12	274.7	56.17	281.7	64.06	297.2	80.47	317.5	81.61
	33	214.1	39.62	250.2	51.76	280.9	61.93	296.9	80.40	303.3	79.83	312.7	80.55	333.9	81.68
	35	255.1	53.52	292.4	64.87	301.7	78.72	307.0	79.11	312.0	79.59	320.4	80.30	329.8	80.62
	37	255.1	57.07	288.3	68.08	297.6	77.68	301.7	78.07	307.0	78.54	315.3	79.24	324.7	79.55
	39	255.1	60.77	283.2	71.66	292.4	76.64	297.6	77.02	301.7	77.49	311.1	78.18	320.4	78.49
41	248.6	64.47	271.4	75.24	280.6	75.60	284.8	75.98	290.3	76.43	299.1	77.12	307.2	77.42	
43	242.5	68.00	260.1	74.18	269.1	74.56	273.2	74.93	278.7	75.38	287.3	76.06	295.1	76.36	
46	227.2	72.78	237.3	72.63	245.9	73.00	249.7	73.37	254.9	73.81	262.9	74.47	270.2	74.76	
48	201.0	70.75	206.1	70.96	213.8	71.12	217.2	71.31	221.8	71.92	228.9	72.38	235.3	72.67	
120	10	33.5	3.48	45.6	4.34	60.8	5.28	85.8	6.45	113.1	8.06	162.9	10.74	216.0	14.23
	12	33.5	3.51	45.6	4.39	60.8	5.34	85.8	6.51	113.1	8.14	162.9	10.86	216.0	14.38
	14	33.5	3.55	45.6	4.43	60.8	5.40	85.8	6.58	113.1	8.23	162.9	10.97	216.0	14.53
	16	33.5	3.59	45.6	4.48	60.8	5.45	85.8	6.65	113.1	8.31	162.9	11.08	216.0	14.68
	18	33.5	3.62	45.6	4.53	60.8	5.51	85.8	6.72	113.1	8.40	162.9	11.20	216.0	14.83
	20	33.5	3.66	45.6	4.57	60.8	5.56	85.8	6.78	113.1	8.48	162.9	11.31	216.0	14.98
	21	33.5	3.70	46.4	4.71	77.0	7.09	100.0	8.08	127.8	10.42	174.4	14.22	223.8	16.85
	23	58.0	6.56	83.3	8.77	109.5	10.08	130.5	10.94	158.2	15.68	198.3	20.28	239.3	23.89
	25	90.4	10.40	116.8	13.16	143.4	14.71	162.8	17.34	189.7	22.54	223.6	29.48	254.8	34.68
	27	125.6	16.44	158.9	19.57	177.9	22.04	193.3	26.35	221.2	33.45	249.0	42.17	270.4	48.29
	29	161.2	22.83	191.3	26.36	212.0	32.36	224.7	38.11	252.6	45.42	274.4	54.52	286.0	61.30
	31	195.2	28.91	230.4	34.85	246.5	42.93	258.7	50.51	285.1	57.61	292.9	69.29	302.8	70.57
	33	226.3	35.63	271.8	45.48	287.9	55.26	291.9	64.09	297.0	75.40	305.1	76.26	314.6	76.87
	35	230.9	47.60	274.5	61.66	290.9	68.21	294.9	81.24	300.0	81.64	308.2	81.89	316.2	82.54
	37	230.9	51.20	274.5	65.07	286.7	72.72	290.9	79.53	294.9	79.93	303.0	80.17	311.2	80.80
	39	230.9	55.12	273.5	68.77	281.7	77.13	285.7	77.90	289.8	78.29	299.0	78.52	307.1	79.14
41	225.0	59.04	261.6	72.47	270.4	75.61	274.3	76.26	278.3	76.64	286.3	76.87	294.5	77.48	
43	219.4	63.02	250.6	71.43	259.3	73.91	263.1	74.63	267.0	75.00	274.8	75.23	282.8	75.82	
46	205.6	67.76	228.5	69.73	236.8	71.59	240.3	72.18	244.0	72.54	251.4	72.75	258.8	73.33	
48	181.9	66.38	198.4	68.49	205.8	70.19	208.9	70.62	212.2	70.84	218.7	71.13	225.3	71.41	
110	10	30.6	3.27	41.8	4.08	55.7	4.97	78.6	6.06	103.6	7.57	149.2	10.10	197.9	13.37
	12	30.6	3.30	41.8	4.12	55.7	5.02	78.6	6.12	103.6	7.65	149.2	10.20	197.9	13.51
	14	30.6	3.34	41.8	4.17	55.7	5.07	78.6	6.18	103.6	7.73	149.2	10.31	197.9	13.65
	16	30.6	3.37	41.8	4.21	55.7	5.12	78.6	6.25	103.6	7.81	149.2	10.42	197.9	13.79
	18	30.6	3.41	41.8	4.25	55.7	5.17	78.6	6.31	103.6	7.89	149.2	10.52	197.9	13.93
	20	30.6	3.44	41.8	4.30	55.7	5.23	78.6	6.38	103.6	7.97	149.2	10.63	197.9	14.07
	21	30.6	3.47	41.8	4.43	69.8	6.53	92.3	7.59	115.3	9.79	161.1	13.36	208.0	15.84
	23	54.8	6.17	69.8	8.24	97.8	9.24	120.5	10.28	146.1	14.74	183.0	19.06	226.0	22.45
	25	79.0	9.78	97.8	12.36	125.8	13.82	148.8	16.29	173.5	21.18	204.5	27.70	243.7	32.59
	27	103.1	15.45	125.7	18.39	153.7	20.71	176.8	24.76	202.3	31.43	227.7	39.62	263.5	45.37
	29	127.2	21.45	153.7	24.77	181.7	30.41	205.5	35.81	231.0	42.68	250.9	50.20	278.0	55.68
	31	154.3	27.16	185.3	32.75	213.9	40.34	234.3	47.46	259.8	54.13	274.1	58.05	288.3	62.49
	33	178.9	33.48	213.9	42.74	242.4	51.92	264.2	58.02	280.9	65.11	289.6	66.91	297.0	67.00
	35	206.8	42.18	246.6	54.26	275.4	61.86	283.3	66.28	287.4	70.35	294.3	71.00	302.3	71.35
	37	206.8	44.70	246.6	57.59	275.4	65.31	279.4	70.22	282.4	74.20	290.4	74.46	297.3	74.67
	39	206.8	48.19	246.6	61.20	270.4	68.91	274.4	75.11	278.4	77.88	285.3	78.01	293.3	78.09
41	201.5	51.68	240.2	64.80	258.8	72.67	262.9	81.24	266.3	81.24	274.1	81.89	280.9	82.54	
43	196.5	54.27	234.3	67.51	248.1	77.06	252.1	77.93	255.4	77.76	263.0	78.20	269.7	78.41	
46	184.2	52.97	219.6	65.18	226.3	73.13	230.3	73.13	233.3	73.76	240.4	74.17	246.6	74.37	
48	162.9	51.44	190.9	62.79	196.6	69.58	200.2	70.04	202.8	70.38	209.1	70.58	214.6	70.86	

# 7. Capacity Tables

Cooling Capacity (92HP)

Combination (%)	Outdoor air temp. (DB, °C)	Indoor air temp. (DB/WB, °C)													
		20		23		26		27		28		30		32	
		14		16		18		19		20		22		24	
		TC	PI	TC	PI	TC	PI	TC	PI	TC	PI	TC	PI	TC	PI
100	10	28.1	3.00	38.3	3.74	51.1	4.56	72.1	5.56	95.1	6.95	136.9	9.26	181.5	12.26
	12	28.1	3.03	38.3	3.78	51.1	4.60	72.1	5.62	95.1	7.02	136.9	9.36	181.5	12.39
	14	28.1	3.06	38.3	3.82	51.1	4.65	72.1	5.67	95.1	7.09	136.9	9.46	181.5	12.52
	16	28.1	3.09	38.3	3.86	51.1	4.70	72.1	5.73	95.1	7.17	136.9	9.56	181.5	12.65
	18	28.1	3.12	38.3	3.90	51.1	4.75	72.1	5.79	95.1	7.24	136.9	9.65	181.5	12.78
	20	28.1	3.16	38.3	3.94	51.1	4.80	72.1	5.85	95.1	7.31	136.9	9.75	181.5	12.91
	21	28.1	3.19	38.3	4.06	63.7	5.99	84.7	6.97	108.3	8.98	147.8	12.26	190.8	14.53
	23	48.7	5.66	67.2	7.56	89.0	8.48	111.6	9.43	135.2	13.52	169.4	17.48	209.3	20.59
	25	69.6	8.97	90.5	11.34	114.4	12.68	139.1	14.95	162.1	19.43	191.1	25.41	227.8	29.90
	27	90.4	14.18	113.9	16.87	139.7	19.00	165.3	22.71	189.0	28.83	212.8	36.35	246.3	41.63
	29	111.2	19.68	137.3	22.73	165.1	27.90	192.1	32.85	215.9	39.16	234.5	47.00	264.8	51.08
	31	132.0	24.92	160.7	30.04	190.4	37.01	219.0	43.54	242.8	49.66	256.2	54.34	285.4	57.91
	33	152.8	30.71	184.1	39.21	215.8	47.64	245.8	55.25	270.0	60.34	278.3	61.38	285.4	62.72
	35	173.9	37.00	207.0	47.23	241.0	58.70	257.6	64.99	270.0	65.38	278.3	65.64	285.4	66.16
	37	173.9	39.62	207.0	50.66	241.0	62.18	257.6	68.08	265.5	68.42	273.2	68.69	279.7	69.33
	39	173.9	42.48	207.0	54.42	241.0	65.89	257.6	71.41	261.1	71.73	268.8	72.00	275.1	72.67
41	171.1	45.34	203.7	58.18	237.2	69.60	247.2	74.74	252.6	75.04	258.5	75.30	266.9	76.01	
43	165.2	47.98	196.7	61.68	229.1	72.93	237.0	77.60	239.7	77.87	247.1	78.13	253.6	78.86	
46	154.9	51.61	184.4	66.49	214.7	77.35	216.4	81.24	218.7	81.48	225.7	81.71	231.8	82.49	
48	137.0	44.56	163.1	57.53	185.3	66.13	188.0	68.93	190.0	69.15	196.2	69.31	201.6	69.86	
90	10	25.3	2.76	34.5	3.44	46.0	4.33	63.6	4.95	85.6	6.39	123.2	8.43	163.4	11.04
	12	25.3	2.79	34.5	3.48	46.0	4.37	63.6	5.00	85.6	6.46	123.2	8.52	163.4	11.15
	14	25.3	2.82	34.5	3.52	46.0	4.42	63.6	5.05	85.6	6.52	123.2	8.61	163.4	11.27
	16	25.3	2.85	34.5	3.55	46.0	4.46	63.6	5.10	85.6	6.59	123.2	8.70	163.4	11.39
	18	25.3	2.87	34.5	3.59	46.0	4.51	63.6	5.15	85.6	6.66	123.2	8.78	163.4	11.50
	20	25.3	2.90	34.5	3.63	46.0	4.56	63.6	5.21	85.6	6.73	123.2	8.87	163.4	11.62
	21	25.3	2.93	34.5	3.66	57.7	5.74	75.3	6.17	96.4	8.07	133.1	9.76	171.9	12.78
	23	34.3	4.54	50.7	6.29	80.5	8.14	97.7	8.87	117.9	11.86	153.0	14.46	189.4	17.58
	25	54.6	7.67	73.4	10.10	103.3	12.04	120.0	14.01	139.4	17.29	172.8	21.85	206.9	25.41
	27	74.9	11.27	96.1	14.37	126.2	18.70	142.4	20.83	160.9	25.22	192.7	29.42	224.3	33.25
	29	95.2	15.22	118.8	19.74	149.0	26.05	164.8	28.80	182.4	33.29	212.6	37.77	241.8	44.01
	31	115.5	19.05	141.4	25.35	171.8	32.61	187.1	36.75	203.9	41.48	232.5	43.97	259.2	51.15
	33	135.8	24.53	164.1	31.20	194.6	39.52	209.5	43.58	225.3	48.22	252.4	52.10	276.8	57.13
	35	156.4	30.37	186.8	38.40	217.1	47.48	231.8	52.37	246.6	56.93	272.2	61.08	276.8	62.48
	37	156.4	32.23	186.8	40.85	217.1	50.63	231.8	55.63	246.6	60.10	267.8	63.85	272.4	65.28
	39	156.4	34.13	186.8	43.44	217.1	53.58	231.8	59.20	246.6	63.20	263.4	67.31	268.0	68.12
41	152.4	38.19	182.0	48.17	211.6	58.81	225.9	64.74	240.3	68.23	252.4	70.94	256.9	72.57	
43	148.6	41.22	177.5	52.05	206.3	64.24	220.3	69.72	234.3	73.16	242.0	75.79	246.4	76.88	
46	139.3	46.40	166.3	59.27	193.4	73.19	206.5	79.05	212.9	81.28	220.9	81.71	225.1	82.49	
48	123.2	40.55	147.1	51.85	171.1	64.04	182.6	68.93	184.9	69.15	192.0	69.31	195.6	69.86	
80	10	21.6	2.44	29.5	3.04	39.4	3.83	55.5	4.40	73.2	5.65	105.4	7.45	139.8	9.76
	12	21.6	2.46	29.5	3.08	39.4	3.87	55.5	4.45	73.2	5.71	105.4	7.53	139.8	9.86
	14	21.6	2.49	29.5	3.11	39.4	3.91	55.5	4.49	73.2	5.77	105.4	7.61	139.8	9.96
	16	21.6	2.52	29.5	3.14	39.4	3.95	55.5	4.54	73.2	5.83	105.4	7.69	139.8	10.07
	18	21.6	2.54	29.5	3.17	39.4	3.99	55.5	4.59	73.2	5.89	105.4	7.77	139.8	10.17
	20	21.6	2.57	29.5	3.20	39.4	4.03	55.5	4.63	73.2	5.95	105.4	7.84	139.8	10.27
	21	21.6	2.58	29.5	3.30	49.4	5.07	66.3	5.55	82.9	7.14	114.6	8.63	148.6	11.30
	23	38.4	4.76	49.0	5.66	69.8	7.19	87.7	7.98	102.5	10.49	133.4	12.78	166.0	15.54
	25	55.1	6.90	68.4	9.09	90.1	10.65	109.1	12.61	122.1	15.29	152.2	19.32	183.4	22.46
	27	71.9	10.14	87.8	12.94	110.5	16.53	130.6	18.75	141.7	22.30	171.0	26.00	200.8	29.39
	29	88.6	13.15	107.2	17.77	130.8	23.03	152.0	25.92	161.3	29.43	189.8	33.39	218.2	38.91
	31	105.4	16.12	126.7	22.36	151.2	28.83	173.4	33.07	184.5	35.67	208.6	38.48	235.7	44.76
	33	122.1	21.19	146.1	27.52	171.5	33.89	195.0	39.22	206.4	40.98	227.4	45.60	253.1	50.39
	35	138.9	27.74	165.6	34.77	192.3	42.66	206.1	46.85	219.9	51.28	246.6	58.19	270.4	60.60
	37	138.9	29.34	165.6	36.96	192.3	45.24	206.1	49.81	219.9	54.49	246.6	61.41	266.0	63.66
	39	138.9	31.01	165.6	39.08	192.3	48.40	206.1	53.54	219.9	58.56	246.6	64.88	261.6	67.16
41	135.4	34.30	161.4	43.30	187.4	53.12	200.8	58.69	214.3	64.34	240.3	69.52	250.6	71.11	
43	132.0	37.76	157.4	47.26	182.7	57.98	195.8	63.96	209.0	70.31	234.3	74.27	240.3	76.12	
46	123.7	42.01	147.5	53.23	171.2	65.33	183.5	71.19	195.8	79.34	214.3	81.71	219.3	82.49	
48	109.4	36.69	130.5	46.54	151.5	57.14	162.4	62.19	173.2	69.15	186.1	69.31	190.6	69.86	

# 7. Capacity Tables

Cooling Capacity (92HP)

Combination (%)	Outdoor air temp. (DB, °C)	Indoor air temp. (DB/WB, °C)													
		20		23		26		27		28		30		32	
		14		16		18		19		20		22		24	
		TC	PI	TC	PI	TC	PI	TC	PI	TC	PI	TC	PI	TC	PI
70	10	18.8	2.16	25.7	2.69	34.2	3.38	48.3	3.92	63.7	4.99	91.7	6.59	121.6	8.63
	12	18.8	2.18	25.7	2.72	34.2	3.42	48.3	3.96	63.7	5.05	91.7	6.66	121.6	8.72
	14	18.8	2.20	25.7	2.75	34.2	3.45	48.3	4.00	63.7	5.10	91.7	6.73	121.6	8.81
	16	18.8	2.22	25.7	2.78	34.2	3.49	48.3	4.04	63.7	5.15	91.7	6.80	121.6	8.90
	18	18.8	2.25	25.7	2.80	34.2	3.52	48.3	4.08	63.7	5.20	91.7	6.86	121.6	8.99
	20	18.8	2.27	25.7	2.83	34.2	3.56	48.3	4.12	63.7	5.26	91.7	6.93	121.6	9.08
	21	18.8	2.28	29.9	3.33	44.5	4.67	59.8	5.17	73.6	6.31	101.1	7.63	130.9	9.99
	23	27.0	3.43	46.4	5.44	62.1	6.83	80.5	7.42	93.4	9.27	120.1	11.30	149.0	13.74
	25	42.8	5.66	62.8	8.03	79.8	9.41	101.2	11.73	113.2	13.51	139.1	17.08	167.2	19.86
	27	58.5	8.25	79.2	11.44	97.5	13.88	121.9	17.43	132.9	19.71	158.1	22.99	185.3	25.98
	29	74.3	10.46	95.7	15.10	115.1	18.88	142.6	23.71	152.7	26.02	177.1	29.51	203.4	34.40
	31	90.1	12.87	112.1	18.78	132.8	23.64	163.4	29.79	172.5	31.53	196.1	34.02	221.6	39.57
	33	105.8	17.31	128.5	22.84	150.5	27.45	180.3	34.59	192.3	36.23	215.3	40.31	239.2	44.54
	35	121.4	23.70	145.4	29.54	168.4	35.73	180.3	39.08	192.3	42.68	215.3	50.25	239.2	55.09
	37	121.4	25.19	145.4	31.28	168.4	37.96	180.3	41.56	192.3	45.41	215.3	53.47	239.2	58.14
	39	121.4	26.75	145.4	33.35	168.4	40.59	180.3	44.72	192.3	49.05	215.3	57.23	239.2	62.68
	41	118.3	29.57	141.6	36.53	164.1	44.53	175.7	49.05	187.4	53.32	209.8	62.86	233.1	67.56
43	115.4	32.19	138.1	39.82	160.0	48.59	171.4	53.48	182.7	58.23	204.6	68.67	227.3	73.07	
46	108.2	35.77	129.5	44.77	149.9	54.71	160.6	59.57	171.2	65.64	191.7	77.45	213.0	81.49	
48	95.7	31.21	114.5	39.11	132.6	47.83	142.1	52.06	151.5	57.43	169.6	67.77	188.4	69.86	
60	10	16.6	1.85	22.2	2.31	29.6	2.90	41.8	3.38	55.1	4.28	79.4	5.65	105.3	7.39
	12	16.6	1.87	22.2	2.33	29.6	2.93	41.8	3.42	55.1	4.33	79.4	5.71	105.3	7.47
	14	16.6	1.89	22.2	2.36	29.6	2.96	41.8	3.45	55.1	4.37	79.4	5.77	105.3	7.55
	16	16.6	1.91	22.2	2.38	29.6	2.99	41.8	3.49	55.1	4.42	79.4	5.82	105.3	7.63
	18	16.6	1.93	22.2	2.40	29.6	3.02	41.8	3.52	55.1	4.46	79.4	5.88	105.3	7.71
	20	16.6	1.94	22.2	2.43	29.6	3.05	41.8	3.56	55.1	4.51	79.4	5.94	105.3	7.78
	21	16.6	1.96	22.2	2.52	37.1	3.92	49.1	4.31	63.2	5.41	86.2	6.54	112.0	8.56
	23	16.6	2.16	36.8	4.56	52.4	5.86	68.1	6.26	79.6	7.95	100.3	9.69	125.3	11.78
	25	30.9	4.12	51.4	6.88	67.7	8.07	87.6	10.69	96.1	11.58	116.6	14.35	138.6	17.02
	27	45.4	6.00	66.0	9.80	83.0	11.90	105.8	14.88	112.5	16.63	131.0	19.00	151.9	21.92
	29	60.0	7.79	80.6	12.56	98.3	15.86	124.9	19.54	129.0	21.19	145.3	23.84	165.2	28.01
	31	74.6	9.91	95.1	15.02	113.6	19.32	140.1	23.45	145.4	24.62	162.8	26.39	178.5	32.29
	33	89.2	13.79	109.7	18.26	128.9	21.69	151.2	26.30	162.0	28.17	175.7	31.27	191.8	36.77
	35	104.0	20.10	124.2	24.60	144.4	29.47	154.6	32.09	164.7	34.83	184.9	40.70	205.2	46.94
	37	104.0	21.23	124.2	25.96	144.4	31.21	154.6	34.08	164.7	36.96	184.9	43.20	205.2	49.94
	39	104.0	22.57	124.2	27.64	144.4	33.69	154.6	36.57	164.7	39.77	184.9	46.32	205.2	53.52
	41	101.3	24.48	121.0	30.24	140.7	36.59	150.6	39.95	160.5	43.17	180.2	50.83	199.9	58.15
43	98.8	26.60	118.0	32.93	137.3	39.88	146.9	43.53	156.5	47.08	175.7	55.49	195.0	63.52	
46	92.6	29.79	110.6	36.97	128.6	44.86	137.6	48.94	146.7	52.97	164.7	62.53	182.7	72.37	
48	81.9	25.96	97.8	32.27	113.8	39.19	121.8	42.74	129.7	46.29	145.7	54.68	161.6	63.32	
50	10	14.9	1.59	20.3	1.98	28.6	2.49	38.2	3.05	50.4	3.68	72.5	4.85	96.2	6.32
	12	14.9	1.60	20.3	2.00	28.6	2.52	38.2	3.09	50.4	3.71	72.5	4.90	96.2	6.39
	14	14.9	1.62	20.3	2.02	28.6	2.54	38.2	3.12	50.4	3.75	72.5	4.95	96.2	6.45
	16	14.9	1.64	20.3	2.04	28.6	2.57	38.2	3.15	50.4	3.79	72.5	5.00	96.2	6.52
	18	14.9	1.65	20.3	2.06	28.6	2.59	38.2	3.18	50.4	3.83	72.5	5.05	96.2	6.59
	20	14.9	1.67	20.3	2.09	28.6	2.62	38.2	3.21	50.4	3.87	72.5	5.10	96.2	6.65
	21	14.9	1.68	20.3	2.16	35.6	3.36	45.1	3.86	57.3	4.64	78.7	5.61	101.4	7.32
	23	14.9	1.78	32.2	3.68	49.4	5.03	63.7	6.02	72.5	6.82	90.7	8.32	111.9	10.07
	25	26.7	3.26	44.2	5.42	63.1	7.05	84.2	9.76	89.2	9.95	102.6	11.70	122.4	14.22
	27	38.7	4.67	56.1	7.62	78.2	9.82	97.7	13.00	103.6	13.40	114.6	15.32	132.9	18.10
	29	50.7	6.13	68.1	9.82	90.6	12.63	109.9	16.13	118.1	17.29	126.5	18.99	143.5	22.86
	31	62.8	7.79	80.0	11.67	103.1	15.39	119.5	17.99	126.5	19.13	138.3	20.50	154.0	25.15
	33	74.8	10.85	92.0	14.05	115.6	17.27	124.2	19.72	131.8	21.13	149.6	24.30	164.3	28.22
	35	86.9	16.71	104.0	20.10	120.5	23.75	128.8	25.76	137.1	27.77	153.6	32.04	171.1	36.81
	37	86.9	17.72	104.0	21.23	120.5	25.13	128.8	27.26	137.1	29.40	153.6	34.17	171.1	39.07
	39	86.9	18.90	104.0	22.76	120.5	26.92	128.8	29.35	137.1	31.55	153.6	36.40	171.1	42.20
	41	84.7	20.43	101.3	24.64	117.4	29.44	125.5	31.79	133.6	34.18	149.7	39.90	166.7	45.83
43	82.6	22.21	98.8	26.80	114.5	32.03	122.4	34.61	130.3	37.21	146.0	43.51	162.6	50.00	
46	77.4	24.87	92.6	30.06	107.3	35.93	114.7	38.87	122.1	41.78	136.8	48.96	152.4	56.29	
48	68.5	21.67	81.9	26.21	94.9	31.34	101.5	33.92	108.0	36.46	121.0	42.78	134.8	49.20	

**Note**

1. TC: Total Capacity(kW), PI : Power Input(kW, Comp. + Outdoor fan motor)
2. Capacity tables show the average value of conditions which may occur.

# 7. Capacity Tables

◆ ARUM940LTE5

Cooling Capacity (94HP)

Combination (%)	Outdoor air temp. (DB, °C)	Indoor air temp. (DB/WB, °C)													
		20		23		26		27		28		30		32	
		14	PI	16	PI	18	PI	19	PI	20	PI	22	PI	24	PI
130	10	37.1	3.90	50.5	4.87	67.4	5.92	95.1	7.23	125.3	9.03	180.4	12.04	239.2	15.95
	12	37.1	3.94	50.5	4.92	67.4	5.99	95.1	7.30	125.3	9.13	180.4	12.17	239.2	16.12
	14	37.1	3.98	50.5	4.97	67.4	6.05	95.1	7.38	125.3	9.22	180.4	12.30	239.2	16.28
	16	37.1	4.02	50.5	5.02	67.4	6.11	95.1	7.45	125.3	9.32	180.4	12.42	239.2	16.45
	18	37.1	4.06	50.5	5.07	67.4	6.17	95.1	7.53	125.3	9.41	180.4	12.55	239.2	16.62
	20	37.1	4.10	50.5	5.12	67.4	6.24	95.1	7.61	125.3	9.51	180.4	12.68	239.2	16.79
	21	37.1	4.14	51.3	5.28	83.4	7.79	110.8	9.06	140.1	11.68	192.1	15.94	246.8	18.89
	23	64.4	7.36	89.7	9.68	115.9	11.03	144.8	12.26	169.6	17.58	215.9	22.74	262.2	26.78
	25	95.1	11.66	115.3	14.51	148.5	16.49	180.5	19.44	199.2	25.27	239.7	33.04	277.6	38.87
	27	124.2	18.58	147.3	21.94	181.0	24.90	214.4	29.77	228.7	37.79	263.5	47.65	292.9	53.69
	29	153.3	25.80	179.4	30.27	213.5	36.57	249.3	43.06	258.2	51.32	287.5	61.60	308.4	68.56
	31	186.0	33.71	215.7	41.59	251.0	50.45	280.7	58.90	287.8	67.18	303.7	84.38	324.4	85.58
	33	218.8	41.55	255.7	54.27	287.0	64.94	303.3	84.31	309.9	83.72	319.5	84.46	341.1	85.65
	35	260.7	56.12	298.8	68.03	308.3	82.55	313.6	82.96	318.7	83.46	327.4	84.20	336.9	84.54
	37	260.7	59.85	294.6	71.39	304.1	81.46	308.3	81.86	313.6	82.36	322.2	83.09	331.7	83.42
	39	260.7	63.73	289.3	75.15	298.8	80.37	304.1	80.77	308.3	81.25	317.8	81.98	327.4	82.30
41	254.0	67.61	277.3	78.90	286.7	79.27	291.0	79.67	296.6	80.15	305.6	80.87	313.9	81.19	
43	247.7	71.30	265.8	77.79	275.0	78.18	279.2	78.58	284.8	79.05	293.5	79.76	301.5	80.07	
46	232.2	76.32	242.4	76.16	251.2	76.55	255.2	76.93	260.5	77.40	268.7	78.09	276.1	78.40	
48	205.4	74.19	210.6	74.42	218.4	74.57	221.9	74.78	226.6	75.42	233.9	75.90	240.4	76.20	
120	10	34.2	3.65	46.6	4.55	62.1	5.54	87.7	6.76	115.6	8.45	166.4	11.27	220.7	14.92
	12	34.2	3.69	46.6	4.60	62.1	5.60	87.7	6.83	115.6	8.54	166.4	11.39	220.7	15.08
	14	34.2	3.72	46.6	4.65	62.1	5.66	87.7	6.90	115.6	8.63	166.4	11.50	220.7	15.23
	16	34.2	3.76	46.6	4.70	62.1	5.72	87.7	6.97	115.6	8.72	166.4	11.62	220.7	15.39
	18	34.2	3.80	46.6	4.75	62.1	5.77	87.7	7.04	115.6	8.80	166.4	11.74	220.7	15.55
	20	34.2	3.84	46.6	4.79	62.1	5.83	87.7	7.11	115.6	8.89	166.4	11.86	220.7	15.70
	21	34.2	3.88	47.4	4.94	78.7	7.43	102.1	8.47	130.6	10.93	178.1	14.91	228.7	17.67
	23	59.3	6.88	85.1	9.20	111.9	10.57	133.4	11.47	161.7	16.45	202.6	21.27	244.5	25.05
	25	92.4	10.91	119.3	13.80	146.5	15.42	166.3	18.18	193.8	23.64	228.5	30.91	260.4	36.36
	27	128.3	17.24	162.3	20.53	181.8	23.11	197.5	27.63	226.0	35.07	254.4	44.22	276.2	50.63
	29	164.7	23.94	195.5	27.64	216.6	33.93	229.6	39.96	258.1	47.63	280.4	57.17	292.2	64.28
	31	199.5	30.31	235.4	36.55	251.8	45.02	264.4	52.97	291.3	60.41	299.3	72.65	309.4	74.01
	33	231.2	37.36	277.7	47.69	294.2	57.94	298.3	67.21	303.5	79.07	311.7	79.97	321.5	80.61
	35	235.9	49.92	280.5	64.66	297.2	71.52	301.3	85.19	306.5	85.61	314.9	85.87	323.1	86.55
	37	235.9	53.69	280.5	68.23	292.9	76.25	297.2	83.40	301.3	83.81	309.6	84.06	318.0	84.73
	39	235.9	57.80	279.5	72.11	287.8	80.88	291.9	81.68	296.1	82.09	305.5	82.34	313.7	82.99
41	229.9	61.91	267.3	75.99	276.3	79.28	280.2	79.97	284.3	80.37	292.5	80.61	300.9	81.25	
43	224.2	66.08	256.1	74.91	265.0	77.50	268.8	78.26	272.8	78.65	280.8	78.88	288.9	79.51	
46	210.1	71.06	233.5	73.12	242.0	75.07	245.6	75.69	249.3	76.07	256.8	76.29	264.4	76.90	
48	185.8	69.61	202.7	71.82	210.3	73.61	213.5	74.05	216.8	74.29	223.4	74.59	230.2	74.88	
110	10	31.3	3.43	42.7	4.28	56.9	5.21	80.3	6.35	105.9	7.94	152.4	10.59	202.2	14.02
	12	31.3	3.46	42.7	4.32	56.9	5.26	80.3	6.42	105.9	8.02	152.4	10.70	202.2	14.17
	14	31.3	3.50	42.7	4.37	56.9	5.32	80.3	6.48	105.9	8.11	152.4	10.81	202.2	14.31
	16	31.3	3.54	42.7	4.41	56.9	5.37	80.3	6.55	105.9	8.19	152.4	10.92	202.2	14.46
	18	31.3	3.57	42.7	4.46	56.9	5.43	80.3	6.62	105.9	8.27	152.4	11.03	202.2	14.61
	20	31.3	3.61	42.7	4.50	56.9	5.48	80.3	6.69	105.9	8.36	152.4	11.14	202.2	14.76
	21	31.3	3.64	42.7	4.64	71.3	6.85	94.4	7.96	117.8	10.27	164.6	14.01	212.5	16.61
	23	56.0	6.47	71.3	8.64	99.9	9.69	123.1	10.78	149.2	15.45	187.0	19.99	231.0	23.54
	25	80.7	10.25	99.9	12.97	128.5	14.49	152.1	17.09	177.3	22.21	209.0	29.04	249.0	34.17
	27	105.3	16.20	128.5	19.29	157.1	21.71	180.7	25.96	206.7	32.96	232.7	41.55	269.3	47.58
	29	129.9	22.50	157.1	25.98	185.7	31.89	210.0	37.55	236.1	44.76	256.4	52.64	284.1	58.39
	31	157.7	28.48	189.3	34.34	218.5	42.30	239.4	49.77	265.5	56.76	280.1	60.87	294.5	65.53
	33	182.8	35.11	218.5	44.82	247.7	54.45	270.0	60.84	287.0	68.28	295.9	70.16	303.4	70.26
	35	211.3	44.23	251.9	56.90	281.4	64.87	289.5	69.50	293.6	73.77	300.7	74.45	308.9	74.82
	37	211.3	46.87	251.9	60.39	281.4	68.48	285.4	73.63	288.5	77.81	296.7	78.08	303.7	78.30
	39	211.3	50.53	251.9	64.17	276.3	72.26	280.3	78.76	284.5	81.66	291.5	81.80	299.7	81.88
41	205.9	54.20	245.5	67.96	264.5	76.20	268.6	85.19	272.1	85.19	280.1	85.87	287.0	86.55	
43	200.8	56.91	239.4	70.80	253.5	80.81	257.6	81.72	261.0	81.54	268.7	82.00	275.5	82.23	
46	188.2	55.54	224.4	68.35	231.3	76.69	235.3	76.69	238.4	77.35	245.6	77.78	252.0	77.99	
48	166.5	53.95	195.0	65.84	200.9	72.96	204.5	73.45	207.2	73.81	213.6	74.01	219.3	74.31	

# 7. Capacity Tables

Cooling Capacity (94HP)

Combination (%)	Outdoor air temp. (DB, °C)	Indoor air temp. (DB/WB, °C)													
		20		23		26		27		28		30		32	
		14		16		18		19		20		22		24	
		TC	PI	TC	PI	TC	PI	TC	PI	TC	PI	TC	PI	TC	PI
100	10	28.7	3.14	39.2	3.93	52.2	4.78	73.7	5.83	97.1	7.28	139.8	9.71	185.5	12.86
	12	28.7	3.18	39.2	3.97	52.2	4.83	73.7	5.89	97.1	7.36	139.8	9.82	185.5	13.00
	14	28.7	3.21	39.2	4.01	52.2	4.88	73.7	5.95	97.1	7.44	139.8	9.92	185.5	13.13
	16	28.7	3.24	39.2	4.05	52.2	4.93	73.7	6.01	97.1	7.51	139.8	10.02	185.5	13.27
	18	28.7	3.28	39.2	4.09	52.2	4.98	73.7	6.07	97.1	7.59	139.8	10.12	185.5	13.40
	20	28.7	3.31	39.2	4.13	52.2	5.03	73.7	6.13	97.1	7.67	139.8	10.22	185.5	13.54
	21	28.7	3.34	39.2	4.26	65.1	6.28	86.6	7.30	110.7	9.42	151.0	12.85	195.0	15.24
	23	49.8	5.93	68.6	7.93	91.0	8.89	114.0	9.89	138.2	14.18	173.1	18.34	213.9	21.60
	25	71.1	9.40	92.5	11.90	116.9	13.30	142.1	15.67	165.7	20.38	195.3	26.65	232.7	31.35
	27	92.3	14.87	116.4	17.69	142.8	19.92	168.8	23.82	193.1	30.23	217.5	38.12	251.6	43.65
	29	113.6	20.64	140.3	23.83	168.7	29.25	196.3	34.45	220.6	41.06	239.6	49.28	270.5	53.57
	31	134.9	26.13	164.2	31.51	194.6	38.81	223.7	45.66	248.1	52.07	261.8	56.98	291.6	60.73
	33	156.1	32.21	188.1	41.11	220.5	49.95	251.1	57.94	275.8	63.27	284.4	64.37	291.6	65.77
	35	177.7	38.80	211.5	49.53	246.3	61.55	263.2	68.15	275.8	68.56	284.4	68.83	291.6	69.38
	37	177.7	41.55	211.5	53.12	246.3	65.20	263.2	71.39	271.3	71.75	279.1	72.03	285.8	72.70
	39	177.7	44.54	211.5	57.07	246.3	69.09	263.2	74.88	266.8	75.22	274.6	75.50	281.1	76.20
	41	174.8	47.54	208.1	61.01	242.4	72.98	252.5	78.37	258.1	78.69	264.2	78.96	272.7	79.70
43	168.8	50.31	201.0	64.68	234.0	76.47	242.1	81.37	244.9	81.66	252.5	81.93	259.1	82.70	
46	158.2	54.12	188.4	69.72	219.3	81.11	221.1	85.19	223.5	85.44	230.7	85.69	236.8	86.50	
48	140.0	46.73	166.6	60.32	189.4	69.34	192.1	72.28	194.1	72.52	200.5	72.68	206.0	73.26	
90	10	25.8	2.89	35.2	3.61	47.0	4.54	65.0	5.19	87.4	6.70	125.8	8.84	166.9	11.57
	12	25.8	2.92	35.2	3.65	47.0	4.59	65.0	5.24	87.4	6.77	125.8	8.93	166.9	11.70
	14	25.8	2.95	35.2	3.69	47.0	4.63	65.0	5.30	87.4	6.84	125.8	9.03	166.9	11.82
	16	25.8	2.98	35.2	3.73	47.0	4.68	65.0	5.35	87.4	6.91	125.8	9.12	166.9	11.94
	18	25.8	3.01	35.2	3.76	47.0	4.73	65.0	5.40	87.4	6.98	125.8	9.21	166.9	12.06
	20	25.8	3.04	35.2	3.80	47.0	4.78	65.0	5.46	87.4	7.05	125.8	9.30	166.9	12.18
	21	25.8	3.08	35.2	3.84	59.0	6.02	77.0	6.47	98.5	8.46	136.0	10.23	175.7	13.40
	23	35.1	4.76	51.9	6.60	82.3	8.53	99.8	9.30	120.5	12.44	156.3	15.16	193.5	18.44
	25	55.8	8.04	75.0	10.59	105.6	12.63	122.7	14.69	142.4	18.14	176.6	22.92	211.3	26.65
	27	76.5	11.82	98.2	15.07	128.9	19.60	145.5	21.84	164.4	26.45	196.9	30.85	229.2	34.87
	29	97.3	15.96	121.3	20.70	152.2	27.31	168.3	30.20	186.3	34.91	217.2	39.60	247.0	46.15
	31	118.0	19.97	144.5	26.59	175.6	34.20	191.2	38.53	208.3	43.49	237.6	46.11	264.9	53.64
	33	138.8	25.72	167.7	32.72	198.9	41.45	214.0	45.70	230.2	50.56	257.9	54.64	282.8	59.91
	35	159.8	31.85	190.8	40.27	221.8	49.79	236.9	54.91	251.9	59.70	278.1	64.05	282.8	65.52
	37	159.8	33.80	190.8	42.83	221.8	53.09	236.9	58.33	251.9	63.02	273.6	66.95	278.3	68.45
	39	159.8	35.79	190.8	45.56	221.8	56.19	236.9	62.07	251.9	66.27	269.1	70.59	273.9	71.44
	41	155.7	40.04	185.9	50.51	216.2	61.67	230.8	67.89	245.5	71.55	257.9	74.39	262.5	76.09
43	151.9	43.23	181.3	54.58	210.8	67.36	225.1	73.11	239.4	76.72	247.2	79.47	251.7	80.62	
46	142.3	48.65	169.9	62.16	197.6	76.75	211.0	82.89	217.5	85.23	225.7	85.69	229.9	86.50	
48	125.9	42.52	150.3	54.37	174.8	67.15	186.6	72.28	188.9	72.52	196.2	72.68	199.9	73.26	
80	10	22.1	2.56	30.2	3.19	40.2	4.01	56.7	4.62	74.8	5.92	107.7	7.81	142.8	10.23
	12	22.1	2.58	30.2	3.23	40.2	4.05	56.7	4.66	74.8	5.99	107.7	7.90	142.8	10.34
	14	22.1	2.61	30.2	3.26	40.2	4.10	56.7	4.71	74.8	6.05	107.7	7.98	142.8	10.45
	16	22.1	2.64	30.2	3.29	40.2	4.14	56.7	4.76	74.8	6.11	107.7	8.06	142.8	10.56
	18	22.1	2.66	30.2	3.33	40.2	4.18	56.7	4.81	74.8	6.17	107.7	8.14	142.8	10.66
	20	22.1	2.69	30.2	3.36	40.2	4.22	56.7	4.86	74.8	6.24	107.7	8.23	142.8	10.77
	21	22.1	2.71	30.2	3.46	50.5	5.32	67.7	5.82	84.8	7.48	117.1	9.05	151.8	11.85
	23	39.2	5.00	50.0	5.94	71.3	7.54	89.6	8.37	104.8	11.00	136.3	13.40	169.6	16.30
	25	56.3	7.24	69.9	9.53	92.1	11.17	111.5	13.22	124.8	16.03	155.5	20.26	187.4	23.56
	27	73.4	10.64	89.7	13.56	112.9	17.33	133.4	19.66	144.8	23.38	174.7	27.27	205.2	30.82
	29	90.5	13.79	109.6	18.63	133.7	24.15	155.3	27.18	164.8	30.86	193.9	35.01	223.0	40.80
	31	107.6	16.90	129.4	23.45	154.4	30.23	177.2	34.68	188.5	37.40	213.1	40.35	240.8	46.94
	33	124.8	22.22	149.3	28.86	175.2	35.54	199.3	41.13	210.9	42.98	232.4	47.82	258.6	52.84
	35	141.9	29.09	169.2	36.46	196.5	44.73	210.6	49.12	224.7	53.78	251.9	61.01	276.2	63.55
	37	141.9	30.77	169.2	38.76	196.5	47.44	210.6	52.23	224.7	57.14	251.9	64.39	271.8	66.76
	39	141.9	32.52	169.2	40.98	196.5	50.75	210.6	56.15	224.7	61.41	251.9	68.03	267.3	70.42
	41	138.3	35.97	164.9	45.41	191.4	55.70	205.2	61.55	218.9	67.47	245.5	72.90	256.1	74.57
43	134.9	39.60	160.8	49.55	186.7	60.80	200.1	67.07	213.5	73.73	239.4	77.88	245.5	79.82	
46	126.4	44.05	150.7	55.82	175.0	68.51	187.5	74.65	200.1	83.20	218.9	85.69	224.1	86.50	
48	111.8	38.47	133.3	48.81	154.8	59.91	165.9	65.21	177.0	72.52	190.1	72.68	194.7	73.26	

# 7. Capacity Tables

Cooling Capacity (94HP)

Combination (%)	Outdoor air temp. (DB, °C)	Indoor air temp. (DB/WB, °C)													
		20		23		26		27		28		30		32	
		14		16		18		19		20		22		24	
		TC	PI	TC	PI	TC	PI	TC	PI	TC	PI	TC	PI	TC	PI
70	10	19.2	2.26	26.2	2.82	35.0	3.55	49.4	4.11	65.1	5.24	93.7	6.91	124.3	9.05
	12	19.2	2.28	26.2	2.85	35.0	3.58	49.4	4.15	65.1	5.29	93.7	6.98	124.3	9.14
	14	19.2	2.31	26.2	2.88	35.0	3.62	49.4	4.19	65.1	5.35	93.7	7.05	124.3	9.24
	16	19.2	2.33	26.2	2.91	35.0	3.66	49.4	4.24	65.1	5.40	93.7	7.13	124.3	9.33
	18	19.2	2.36	26.2	2.94	35.0	3.70	49.4	4.28	65.1	5.46	93.7	7.20	124.3	9.43
	20	19.2	2.38	26.2	2.97	35.0	3.73	49.4	4.32	65.1	5.51	93.7	7.27	124.3	9.52
	21	19.2	2.39	30.6	3.49	45.4	4.89	61.1	5.43	75.2	6.61	103.3	8.00	133.7	10.47
	23	27.6	3.60	47.4	5.70	63.5	7.17	82.3	7.78	95.4	9.72	122.7	11.85	152.3	14.41
	25	43.7	5.93	64.2	8.42	81.5	9.87	103.4	12.30	115.6	14.17	142.1	17.91	170.8	20.82
	27	59.8	8.65	81.0	11.99	99.6	14.56	124.6	18.28	135.8	20.67	161.6	24.10	189.3	27.25
	29	75.9	10.97	97.8	15.84	117.7	19.80	145.7	24.87	156.1	27.28	181.0	30.95	207.8	36.07
	31	92.0	13.50	114.5	19.70	135.7	24.79	166.9	31.24	176.3	33.06	200.4	35.67	226.4	41.49
	33	108.1	18.15	131.3	23.95	153.8	28.79	184.2	36.27	196.5	37.99	220.0	42.27	244.4	46.71
	35	124.1	24.85	148.5	30.98	172.0	37.47	184.2	40.98	196.5	44.75	220.0	52.69	244.4	57.77
	37	124.1	26.41	148.5	32.80	172.0	39.81	184.2	43.58	196.5	47.62	220.0	56.07	244.4	60.97
	39	124.1	28.05	148.5	34.97	172.0	42.57	184.2	46.89	196.5	51.44	220.0	60.01	244.4	65.73
	41	120.9	31.01	144.7	38.31	167.6	46.69	179.5	51.43	191.4	55.92	214.3	65.91	238.1	70.84
43	117.9	33.75	141.1	41.75	163.5	50.95	175.1	56.08	186.7	61.06	209.0	72.00	232.3	76.62	
46	110.5	37.51	132.3	46.95	153.2	57.37	164.1	62.47	175.0	68.83	195.9	81.21	217.7	85.45	
48	97.8	32.73	117.0	41.01	135.5	50.16	145.1	54.59	154.8	60.22	173.3	71.07	192.5	73.26	
60	10	16.9	1.91	22.7	2.39	30.3	3.00	42.7	3.50	56.3	4.43	81.1	5.84	107.6	7.65
	12	16.9	1.93	22.7	2.41	30.3	3.03	42.7	3.54	56.3	4.48	81.1	5.91	107.6	7.73
	14	16.9	1.95	22.7	2.44	30.3	3.06	42.7	3.57	56.3	4.52	81.1	5.97	107.6	7.81
	16	16.9	1.97	22.7	2.46	30.3	3.09	42.7	3.61	56.3	4.57	81.1	6.03	107.6	7.89
	18	16.9	1.99	22.7	2.49	30.3	3.13	42.7	3.65	56.3	4.62	81.1	6.09	107.6	7.97
	20	16.9	2.01	22.7	2.51	30.3	3.16	42.7	3.68	56.3	4.66	81.1	6.15	107.6	8.05
	21	16.9	2.02	22.7	2.61	37.9	4.05	50.2	4.47	64.6	5.60	88.1	6.77	114.4	8.86
	23	16.9	2.24	37.6	4.72	53.5	6.06	69.5	6.48	81.4	8.22	102.4	10.02	128.0	12.19
	25	31.5	4.26	52.5	7.13	69.2	8.35	89.5	11.06	98.2	11.99	119.1	14.85	141.6	17.62
	27	46.4	6.21	67.4	10.14	84.8	12.32	108.1	15.40	115.0	17.21	133.8	19.67	155.2	22.69
	29	61.3	8.06	82.3	13.00	100.4	16.42	127.6	20.23	131.8	21.93	148.5	24.67	168.8	28.99
	31	76.2	10.25	97.2	15.54	116.1	19.99	143.2	24.27	148.6	25.48	166.3	27.31	182.3	33.42
	33	91.1	14.27	112.1	18.90	131.7	22.45	154.4	27.22	165.5	29.15	179.5	32.36	195.9	38.06
	35	106.2	21.08	126.9	25.79	147.6	30.90	157.9	33.65	168.3	36.53	188.9	42.68	209.6	49.23
	37	106.2	22.26	126.9	27.22	147.6	32.73	157.9	35.74	168.3	38.75	188.9	45.30	209.6	52.37
	39	106.2	23.67	126.9	28.98	147.6	35.33	157.9	38.35	168.3	41.71	188.9	48.57	209.6	56.12
	41	103.5	25.67	123.7	31.71	143.8	38.37	153.9	41.89	164.0	45.27	184.1	53.31	204.3	60.98
43	100.9	27.90	120.6	34.53	140.2	41.82	150.1	45.65	159.9	49.37	179.6	58.19	199.2	66.61	
46	94.6	31.24	113.0	38.77	131.4	47.04	140.6	51.31	149.8	55.55	168.3	65.57	186.7	75.89	
48	83.7	27.22	100.0	33.84	116.3	41.10	124.4	44.82	132.6	48.54	148.9	57.34	165.1	66.40	
50	10	15.2	1.62	20.8	2.02	29.2	2.54	39.1	3.11	51.5	3.75	74.1	4.94	98.3	6.45
	12	15.2	1.64	20.8	2.04	29.2	2.57	39.1	3.15	51.5	3.79	74.1	5.00	98.3	6.51
	14	15.2	1.65	20.8	2.06	29.2	2.59	39.1	3.18	51.5	3.83	74.1	5.05	98.3	6.58
	16	15.2	1.67	20.8	2.08	29.2	2.62	39.1	3.21	51.5	3.87	74.1	5.10	98.3	6.65
	18	15.2	1.69	20.8	2.11	29.2	2.65	39.1	3.25	51.5	3.91	74.1	5.15	98.3	6.72
	20	15.2	1.70	20.8	2.13	29.2	2.67	39.1	3.28	51.5	3.95	74.1	5.20	98.3	6.78
	21	15.2	1.71	20.8	2.20	36.4	3.43	46.0	3.93	58.5	4.73	80.4	5.73	103.6	7.46
	23	15.2	1.82	32.9	3.75	50.4	5.13	65.1	6.14	74.1	6.96	92.6	8.48	114.4	10.27
	25	27.3	3.32	45.1	5.52	64.5	7.19	86.1	9.95	91.1	10.14	104.9	11.94	125.1	14.50
	27	39.6	4.76	57.4	7.77	79.9	10.02	99.8	13.26	105.9	13.67	117.1	15.63	135.8	18.46
	29	51.9	6.25	69.6	10.01	92.6	12.88	112.3	16.46	120.7	17.63	129.3	19.36	146.6	23.31
	31	64.1	7.95	81.8	11.90	105.3	15.69	122.1	18.35	129.2	19.51	141.3	20.91	157.3	25.65
	33	76.4	11.07	94.0	14.33	118.1	17.62	126.9	20.12	134.6	21.55	152.8	24.78	167.8	28.78
	35	88.8	17.52	106.2	21.08	123.1	24.90	131.6	27.01	140.1	29.12	157.0	33.60	174.8	38.60
	37	88.8	18.58	106.2	22.27	123.1	26.35	131.6	28.59	140.1	30.83	157.0	35.84	174.8	40.97
	39	88.8	19.82	106.2	23.87	123.1	28.23	131.6	30.77	140.1	33.08	157.0	38.17	174.8	44.26
	41	86.6	21.43	103.5	25.84	120.0	30.87	128.2	33.33	136.5	35.84	153.0	41.84	170.4	48.06
43	84.4	23.29	100.9	28.10	117.0	33.59	125.1	36.29	133.1	39.02	149.2	45.62	166.2	52.43	
46	79.1	26.08	94.6	31.52	109.7	37.68	117.2	40.76	124.7	43.81	139.8	51.34	155.7	59.02	
48	70.0	22.73	83.7	27.49	97.0	32.87	103.7	35.57	110.3	38.23	123.7	44.86	137.7	51.59	

**Note**

1. TC: Total Capacity(kW), PI : Power Input(kW, Comp. + Outdoor fan motor)
2. Capacity tables show the average value of conditions which may occur.



# 7. Capacity Tables

◆ ARUM960LTE5

Cooling Capacity (96HP)

Combination (%)	Outdoor air temp. (DB, °C)	Indoor air temp. (DB/WB, °C)													
		20		23		26		27		28		30		32	
		14	PI	16	PI	18	PI	19	PI	20	PI	22	PI	24	PI
130	10	37.8	3.98	51.6	4.97	68.8	6.05	97.1	7.38	128.0	9.23	184.2	12.31	244.3	16.30
	12	37.8	4.03	51.6	5.03	68.8	6.12	97.1	7.46	128.0	9.33	184.2	12.44	244.3	16.47
	14	37.8	4.07	51.6	5.08	68.8	6.18	97.1	7.54	128.0	9.42	184.2	12.57	244.3	16.64
	16	37.8	4.11	51.6	5.13	68.8	6.24	97.1	7.62	128.0	9.52	184.2	12.70	244.3	16.81
	18	37.8	4.15	51.6	5.18	68.8	6.31	97.1	7.69	128.0	9.62	184.2	12.83	244.3	16.98
	20	37.8	4.19	51.6	5.24	68.8	6.37	97.1	7.77	128.0	9.71	184.2	12.96	244.3	17.15
	21	37.8	4.24	52.4	5.40	85.2	7.96	113.2	9.25	143.1	11.93	196.2	16.28	252.1	19.31
	23	65.7	7.52	91.6	9.89	118.4	11.27	147.8	12.53	173.2	17.97	220.5	23.23	267.8	27.36
	25	97.2	11.92	117.7	14.83	151.6	16.85	184.3	19.86	203.4	25.82	244.8	33.76	283.5	39.72
	27	126.8	18.99	150.5	22.42	184.9	25.45	219.0	30.42	233.6	38.62	269.1	48.69	299.2	54.86
	29	156.5	26.36	183.2	30.93	218.1	37.37	254.6	44.00	263.7	52.45	293.7	62.95	315.0	70.06
	31	189.9	34.45	220.3	42.50	256.3	51.56	286.7	60.19	293.9	68.64	310.1	86.23	331.3	87.45
	33	223.4	42.46	261.1	55.46	293.1	66.36	309.8	86.15	316.5	85.55	326.3	86.31	348.4	87.53
	35	266.2	57.35	305.1	69.51	314.9	84.35	320.3	84.77	325.5	85.28	334.4	86.05	344.1	86.39
	37	266.2	61.16	300.8	72.95	310.6	83.24	314.9	83.65	320.3	84.16	329.0	84.91	338.8	85.24
	39	266.2	65.12	295.5	76.79	305.1	82.12	310.6	82.53	314.9	83.03	324.6	83.77	334.4	84.10
41	259.4	69.09	283.2	80.63	292.8	81.01	297.2	81.42	303.0	81.90	312.1	82.64	320.5	82.96	
43	253.0	72.86	271.4	79.49	280.8	79.89	285.1	80.30	290.8	80.78	299.8	81.50	307.9	81.82	
46	237.1	77.99	247.6	77.83	256.6	78.22	260.6	78.62	266.0	79.09	274.4	79.80	282.0	80.11	
48	209.8	75.81	215.0	76.04	223.1	76.21	226.6	76.41	231.5	77.07	238.9	77.56	245.5	77.86	
120	10	34.9	3.73	47.6	4.65	63.5	5.66	89.6	6.91	118.0	8.63	169.9	11.51	225.4	15.24
	12	34.9	3.77	47.6	4.70	63.5	5.72	89.6	6.98	118.0	8.72	169.9	11.63	225.4	15.41
	14	34.9	3.81	47.6	4.75	63.5	5.78	89.6	7.05	118.0	8.82	169.9	11.76	225.4	15.57
	16	34.9	3.84	47.6	4.80	63.5	5.84	89.6	7.13	118.0	8.91	169.9	11.88	225.4	15.73
	18	34.9	3.88	47.6	4.85	63.5	5.90	89.6	7.20	118.0	9.00	169.9	12.00	225.4	15.89
	20	34.9	3.92	47.6	4.90	63.5	5.96	89.6	7.27	118.0	9.09	169.9	12.12	225.4	16.05
	21	34.9	3.96	48.4	5.05	80.4	7.59	104.3	8.66	133.4	11.16	181.9	15.23	233.6	18.06
	23	60.5	7.03	86.9	9.40	114.2	10.80	136.2	11.72	165.1	16.81	206.9	21.73	249.7	25.60
	25	94.3	11.15	121.9	14.10	149.6	15.76	169.8	18.58	197.9	24.15	233.4	31.59	265.9	37.16
	27	131.1	17.62	165.8	20.97	185.6	23.61	201.7	28.23	230.8	35.84	259.8	45.19	282.1	51.74
	29	168.2	24.47	199.6	28.25	221.2	34.68	234.5	40.84	263.6	48.67	286.3	58.42	298.4	65.68
	31	203.7	30.98	240.4	37.35	257.2	46.01	270.0	54.12	297.5	61.73	305.7	74.24	316.0	75.62
	33	236.1	38.18	283.6	48.74	300.5	59.21	304.6	68.68	309.9	80.80	318.3	81.72	328.3	82.37
	35	240.9	51.01	286.5	66.07	303.5	73.09	307.7	87.05	313.0	87.49	321.6	87.75	330.0	88.44
	37	240.9	54.87	286.5	69.72	299.2	77.92	303.5	85.22	307.7	85.65	316.2	85.90	324.7	86.58
	39	240.9	59.07	285.4	73.69	294.0	82.65	298.2	83.47	302.4	83.89	312.0	84.14	320.4	84.80
41	234.8	63.27	273.0	77.65	282.2	81.02	286.2	81.72	290.4	82.13	298.8	82.37	307.3	83.03	
43	228.9	67.53	261.5	76.54	270.6	79.20	274.5	79.97	278.6	80.37	286.8	80.61	295.1	81.25	
46	214.6	72.61	238.5	74.72	247.1	76.71	250.8	77.34	254.6	77.73	262.3	77.96	270.0	78.58	
48	189.8	71.13	207.1	73.39	214.8	75.21	218.0	75.67	221.4	75.91	228.2	76.22	235.1	76.52	
110	10	32.0	3.50	43.6	4.37	58.1	5.32	82.0	6.49	108.1	8.11	155.7	10.82	206.5	14.32
	12	32.0	3.54	43.6	4.42	58.1	5.38	82.0	6.56	108.1	8.20	155.7	10.93	206.5	14.48
	14	32.0	3.58	43.6	4.46	58.1	5.43	82.0	6.63	108.1	8.28	155.7	11.05	206.5	14.63
	16	32.0	3.61	43.6	4.51	58.1	5.49	82.0	6.70	108.1	8.37	155.7	11.16	206.5	14.78
	18	32.0	3.65	43.6	4.56	58.1	5.54	82.0	6.76	108.1	8.45	155.7	11.27	206.5	14.93
	20	32.0	3.69	43.6	4.60	58.1	5.60	82.0	6.83	108.1	8.54	155.7	11.39	206.5	15.08
	21	32.0	3.72	43.6	4.74	72.8	7.00	96.4	8.14	120.3	10.49	168.1	14.31	217.0	16.97
	23	57.2	6.61	72.8	8.83	102.0	9.91	125.7	11.01	152.4	15.79	191.0	20.42	235.9	24.05
	25	82.4	10.48	102.0	13.25	131.2	14.81	155.3	17.46	181.0	22.70	213.4	29.68	254.3	34.92
	27	107.5	16.56	131.2	19.71	160.4	22.19	184.5	26.53	211.1	33.68	237.6	42.46	275.0	48.62
	29	132.7	22.99	160.4	26.54	189.6	32.58	214.5	38.37	241.1	45.73	261.8	53.79	290.1	59.66
	31	161.0	29.11	193.4	35.09	223.2	43.23	244.5	50.86	271.1	58.00	286.1	62.20	300.8	66.96
	33	186.7	35.87	223.2	45.80	253.0	55.64	275.7	62.17	293.1	69.77	302.2	71.70	309.9	71.79
	35	215.8	45.19	257.3	58.14	287.4	66.29	295.6	71.02	299.9	75.39	307.1	76.08	315.4	76.46
	37	215.8	47.90	257.3	61.71	287.4	69.98	291.5	75.24	294.6	79.51	303.0	79.79	310.2	80.01
	39	215.8	51.64	257.3	65.58	282.2	73.84	286.3	80.48	290.5	83.45	297.7	83.59	306.1	83.67
41	210.3	55.38	250.7	69.44	270.1	77.86	274.3	87.05	277.9	87.05	286.0	87.75	293.1	88.44	
43	205.1	58.15	244.5	72.35	258.9	82.57	263.1	83.50	266.5	83.32	274.4	83.79	281.4	84.03	
46	192.2	56.76	229.1	69.84	236.2	78.36	240.3	78.36	243.4	79.04	250.9	79.48	257.4	79.69	
48	170.0	55.13	199.2	67.28	205.1	74.56	208.9	75.06	211.6	75.42	218.2	75.63	223.9	75.93	

# 7. Capacity Tables

Cooling Capacity (96HP)

Combination (%)	Outdoor air temp. (DB, °C)	Indoor air temp. (DB/WB, °C)													
		20		23		26		27		28		30		32	
		14		16		18		19		20		22		24	
		TC	PI	TC	PI	TC	PI	TC	PI	TC	PI	TC	PI	TC	PI
100	10	29.3	3.21	40.0	4.01	53.3	4.88	75.3	5.95	99.2	7.44	142.8	9.93	189.4	13.14
	12	29.3	3.25	40.0	4.05	53.3	4.93	75.3	6.02	99.2	7.52	142.8	10.03	189.4	13.28
	14	29.3	3.28	40.0	4.10	53.3	4.98	75.3	6.08	99.2	7.60	142.8	10.13	189.4	13.42
	16	29.3	3.31	40.0	4.14	53.3	5.04	75.3	6.14	99.2	7.68	142.8	10.24	189.4	13.56
	18	29.3	3.35	40.0	4.18	53.3	5.09	75.3	6.20	99.2	7.76	142.8	10.34	189.4	13.70
	20	29.3	3.38	40.0	4.22	53.3	5.14	75.3	6.27	99.2	7.83	142.8	10.45	189.4	13.83
	21	29.3	3.42	40.0	4.35	66.4	6.42	88.4	7.46	113.1	9.62	154.2	13.13	199.1	15.57
	23	50.9	6.06	70.1	8.10	92.9	9.09	116.4	10.10	141.1	14.49	176.8	18.74	218.4	22.07
	25	72.6	9.61	94.5	12.16	119.3	13.59	145.2	16.02	169.2	20.82	199.4	27.23	237.7	32.03
	27	94.3	15.19	118.9	18.08	145.8	20.36	172.4	24.34	197.2	30.90	222.1	38.95	257.0	44.60
	29	116.0	21.09	143.3	24.35	172.2	29.89	200.4	35.20	225.3	41.96	244.7	50.36	276.3	54.74
	31	137.7	26.70	167.7	32.19	198.7	39.66	228.5	46.66	253.4	53.21	267.3	58.23	297.8	62.06
	33	159.5	32.91	192.1	42.01	225.1	51.04	256.5	59.21	281.7	64.65	290.4	65.78	297.8	67.21
	35	181.4	39.64	216.0	50.61	251.5	62.90	268.8	69.64	281.7	70.06	290.4	70.33	297.8	70.89
	37	181.4	42.46	216.0	54.28	251.5	66.63	268.8	72.96	277.1	73.31	285.1	73.61	291.8	74.29
	39	181.4	45.52	216.0	58.31	251.5	70.60	268.8	76.52	272.5	76.86	280.5	77.15	287.0	77.87
41	178.6	48.58	212.6	62.34	247.5	74.58	257.9	80.09	263.6	80.41	269.8	80.69	278.5	81.44	
43	172.4	51.41	205.3	66.09	239.0	78.15	247.3	83.15	250.1	83.45	257.9	83.72	264.6	84.51	
46	161.6	55.30	192.4	71.25	224.0	82.89	225.8	87.05	228.2	87.31	235.6	87.56	241.9	88.39	
48	142.9	47.75	170.2	61.64	193.4	70.86	196.2	73.86	198.3	74.10	204.8	74.27	210.4	74.86	
90	10	26.4	2.96	36.0	3.69	48.0	4.64	66.4	5.30	89.3	6.85	128.5	9.03	170.5	11.83
	12	26.4	2.99	36.0	3.73	48.0	4.69	66.4	5.36	89.3	6.92	128.5	9.13	170.5	11.95
	14	26.4	3.02	36.0	3.77	48.0	4.73	66.4	5.41	89.3	6.99	128.5	9.22	170.5	12.08
	16	26.4	3.05	36.0	3.81	48.0	4.78	66.4	5.47	89.3	7.06	128.5	9.32	170.5	12.20
	18	26.4	3.08	36.0	3.85	48.0	4.83	66.4	5.52	89.3	7.14	128.5	9.41	170.5	12.33
	20	26.4	3.11	36.0	3.88	48.0	4.88	66.4	5.58	89.3	7.21	128.5	9.51	170.5	12.45
	21	26.4	3.14	36.0	3.92	60.2	6.15	78.6	6.61	100.6	8.65	138.9	10.46	179.4	13.70
	23	35.8	4.86	53.0	6.74	84.0	8.72	101.9	9.50	123.1	12.71	159.6	15.49	197.6	18.84
	25	57.0	8.22	76.6	10.82	107.8	12.91	125.3	15.01	145.5	18.53	180.4	23.42	215.8	27.23
	27	78.2	12.08	100.3	15.40	131.7	20.03	148.6	22.32	167.9	27.03	201.1	31.52	234.1	35.63
	29	99.3	16.31	123.9	21.16	155.5	27.91	171.9	30.86	190.3	35.68	221.9	40.47	252.3	47.16
	31	120.5	20.41	147.6	27.17	179.3	34.94	195.3	39.38	212.7	44.44	242.6	47.11	270.5	54.81
	33	141.7	26.29	171.2	33.44	203.1	42.35	218.6	46.69	235.1	51.67	263.4	55.83	288.8	61.22
	35	163.2	32.55	194.9	41.15	226.6	50.88	241.9	56.11	257.3	61.01	284.0	65.45	288.8	66.95
	37	163.2	34.54	194.9	43.77	226.6	54.25	241.9	59.61	257.3	64.40	279.4	68.42	284.3	69.95
	39	163.2	36.57	194.9	46.55	226.6	57.41	241.9	63.43	257.3	67.72	274.8	72.13	279.7	73.00
41	159.0	40.92	189.9	51.61	220.8	63.02	235.7	69.37	250.7	73.11	263.4	76.02	268.1	77.76	
43	155.1	44.17	185.2	55.77	215.3	68.83	229.9	74.71	244.5	78.39	252.5	81.21	257.1	82.39	
46	145.3	49.72	173.6	63.51	201.8	78.43	215.5	84.70	222.2	87.09	230.5	87.56	234.8	88.39	
48	128.6	43.45	153.5	55.56	178.5	68.62	190.6	73.86	192.9	74.10	200.3	74.27	204.1	74.86	
80	10	22.6	2.61	30.8	3.26	41.1	4.10	58.0	4.72	76.4	6.05	110.0	7.98	145.8	10.46
	12	22.6	2.64	30.8	3.30	41.1	4.14	58.0	4.77	76.4	6.12	110.0	8.07	145.8	10.57
	14	22.6	2.67	30.8	3.33	41.1	4.19	58.0	4.82	76.4	6.18	110.0	8.15	145.8	10.68
	16	22.6	2.70	30.8	3.37	41.1	4.23	58.0	4.87	76.4	6.24	110.0	8.24	145.8	10.79
	18	22.6	2.72	30.8	3.40	41.1	4.27	58.0	4.91	76.4	6.31	110.0	8.32	145.8	10.90
	20	22.6	2.75	30.8	3.43	41.1	4.32	58.0	4.96	76.4	6.37	110.0	8.40	145.8	11.01
	21	22.6	2.77	30.8	3.53	51.6	5.44	69.2	5.95	86.6	7.65	119.6	9.25	155.0	12.11
	23	40.1	5.10	51.1	6.07	72.8	7.71	91.5	8.55	107.0	11.24	139.2	13.70	173.2	16.65
	25	57.5	7.40	71.4	9.74	94.0	11.41	113.9	13.51	127.4	16.38	158.8	20.70	191.4	24.07
	27	75.0	10.87	91.6	13.86	115.3	17.71	136.3	20.09	147.8	23.89	178.4	27.86	209.6	31.50
	29	92.5	14.09	111.9	19.04	136.5	24.67	158.6	27.77	168.3	31.54	198.1	35.77	227.7	41.69
	31	109.9	17.27	132.2	23.96	157.7	30.89	181.0	35.44	192.5	38.22	217.7	41.23	245.9	47.97
	33	127.4	22.71	152.4	29.49	179.0	36.32	203.5	42.02	215.4	43.92	237.3	48.86	264.1	53.99
	35	145.0	29.72	172.8	37.25	200.6	45.71	215.0	50.20	229.4	54.95	257.3	62.35	282.1	64.94
	37	145.0	31.44	172.8	39.61	200.6	48.48	215.0	53.37	229.4	58.39	257.3	65.80	277.5	68.22
	39	145.0	33.23	172.8	41.87	200.6	51.86	215.0	57.38	229.4	62.75	257.3	69.52	273.0	71.96
41	141.3	36.76	168.4	46.40	195.5	56.92	209.5	62.89	223.6	68.95	250.7	74.50	261.5	76.20	
43	137.8	40.46	164.2	50.64	190.7	62.13	204.4	68.54	218.0	75.35	244.5	79.58	250.7	81.56	
46	129.1	45.02	153.9	57.04	178.7	70.00	191.5	76.29	204.3	85.02	223.6	87.56	228.9	88.39	
48	114.2	39.31	136.1	49.87	158.1	61.22	169.4	66.64	180.8	74.10	194.2	74.27	198.8	74.86	

# 7. Capacity Tables

Cooling Capacity (96HP)

Combination (%)	Outdoor air temp. (DB, °C)	Indoor air temp. (DB/WB, °C)													
		20		23		26		27		28		30		32	
		14		16		18		19		20		22		24	
		TC	PI	TC	PI	TC	PI	TC	PI	TC	PI	TC	PI	TC	PI
70	10	19.7	2.31	26.8	2.88	35.7	3.62	50.4	4.20	66.5	5.35	95.7	7.06	126.9	9.24
	12	19.7	2.33	26.8	2.91	35.7	3.66	50.4	4.24	66.5	5.41	95.7	7.13	126.9	9.34
	14	19.7	2.36	26.8	2.94	35.7	3.70	50.4	4.29	66.5	5.46	95.7	7.21	126.9	9.44
	16	19.7	2.38	26.8	2.98	35.7	3.74	50.4	4.33	66.5	5.52	95.7	7.28	126.9	9.53
	18	19.7	2.41	26.8	3.01	35.7	3.78	50.4	4.37	66.5	5.58	95.7	7.36	126.9	9.63
	20	19.7	2.43	26.8	3.04	35.7	3.81	50.4	4.42	66.5	5.63	95.7	7.43	126.9	9.73
	21	19.7	2.44	31.2	3.57	46.4	5.00	62.4	5.54	76.8	6.76	105.5	8.17	136.6	10.70
	23	28.2	3.68	48.4	5.83	64.8	7.32	84.0	7.95	97.4	9.93	125.3	12.11	155.5	14.72
	25	44.6	6.06	65.5	8.61	83.3	10.09	105.6	12.57	118.1	14.48	145.2	18.30	174.4	21.28
	27	61.1	8.84	82.7	12.25	101.7	14.88	127.2	18.68	138.7	21.12	165.0	24.63	193.3	27.84
	29	77.5	11.21	99.8	16.18	120.2	20.23	148.9	25.41	159.4	27.88	184.8	31.62	212.3	36.86
	31	94.0	13.79	117.0	20.13	138.6	25.33	170.5	31.93	180.0	33.79	204.7	36.45	231.2	42.40
	33	110.4	18.55	134.1	24.48	157.0	29.42	188.2	37.07	200.6	38.82	224.6	43.19	249.6	47.73
	35	126.7	25.39	151.7	31.65	175.7	38.29	188.2	41.88	200.6	45.73	224.6	53.84	249.6	59.03
	37	126.7	26.99	151.7	33.52	175.7	40.68	188.2	44.54	200.6	48.66	224.6	57.30	249.6	62.30
	39	126.7	28.66	151.7	35.73	175.7	43.50	188.2	47.92	200.6	52.56	224.6	61.32	249.6	67.17
	41	123.5	31.68	147.8	39.15	171.2	47.71	183.3	52.56	195.5	57.14	218.9	67.35	243.2	72.39
	43	120.4	34.49	144.1	42.67	167.0	52.06	178.8	57.31	190.7	62.40	213.5	73.58	237.2	78.30
46	112.9	38.33	135.1	47.98	156.5	58.63	167.6	63.83	178.7	70.34	200.1	82.99	222.3	87.32	
48	99.8	33.45	119.5	41.91	138.4	51.26	148.2	55.78	158.1	61.53	177.0	72.62	196.6	74.86	
60	10	17.3	1.94	23.2	2.42	30.9	3.04	43.7	3.55	57.5	4.49	82.8	5.93	109.9	7.76
	12	17.3	1.96	23.2	2.45	30.9	3.08	43.7	3.59	57.5	4.54	82.8	5.99	109.9	7.84
	14	17.3	1.98	23.2	2.47	30.9	3.11	43.7	3.62	57.5	4.59	82.8	6.05	109.9	7.93
	16	17.3	2.00	23.2	2.50	30.9	3.14	43.7	3.66	57.5	4.64	82.8	6.11	109.9	8.01
	18	17.3	2.02	23.2	2.52	30.9	3.17	43.7	3.70	57.5	4.68	82.8	6.18	109.9	8.09
	20	17.3	2.04	23.2	2.55	30.9	3.20	43.7	3.74	57.5	4.73	82.8	6.24	109.9	8.17
	21	17.3	2.05	23.2	2.64	38.7	4.11	51.3	4.53	66.0	5.68	89.9	6.86	116.9	8.99
	23	17.3	2.27	38.4	4.79	54.7	6.15	71.0	6.57	83.1	8.34	104.6	10.17	130.7	12.36
	25	32.2	4.32	53.6	7.23	70.6	8.47	91.4	11.22	100.3	12.16	121.7	15.06	144.6	17.87
	27	47.4	6.30	68.8	10.29	86.6	12.49	110.4	15.62	117.4	17.46	136.6	19.95	158.5	23.01
	29	62.6	8.18	84.1	13.18	102.6	16.65	130.3	20.52	134.6	22.25	151.6	25.03	172.4	29.41
	31	77.8	10.40	99.3	15.77	118.5	20.28	146.2	24.62	151.7	25.84	169.9	27.70	186.2	33.90
	33	93.1	14.48	114.5	19.17	134.5	22.77	157.7	27.61	169.0	29.57	183.3	32.83	200.1	38.61
	35	108.5	21.54	129.6	26.36	150.7	31.57	161.3	34.38	171.8	37.33	193.0	43.61	214.1	50.30
	37	108.5	22.74	129.6	27.81	150.7	33.45	161.3	36.52	171.8	39.60	193.0	46.29	214.1	53.51
	39	108.5	24.19	129.6	29.62	150.7	36.10	161.3	39.19	171.8	42.62	193.0	49.63	214.1	57.35
	41	105.7	26.23	126.3	32.41	146.9	39.20	157.2	42.81	167.4	46.26	188.0	54.47	208.6	62.32
	43	103.1	28.51	123.2	35.28	143.2	42.74	153.3	46.65	163.3	50.45	183.4	59.46	203.4	68.07
46	96.6	31.93	115.4	39.62	134.2	48.07	143.6	52.44	153.0	56.76	171.8	67.00	190.7	77.55	
48	85.5	27.82	102.1	34.58	118.7	42.00	127.1	45.80	135.4	49.60	152.0	58.60	168.7	67.85	
50	10	15.5	1.63	21.2	2.03	29.9	2.56	39.9	3.14	52.6	3.77	75.7	4.98	100.4	6.49
	12	15.5	1.65	21.2	2.06	29.9	2.58	39.9	3.17	52.6	3.81	75.7	5.03	100.4	6.56
	14	15.5	1.66	21.2	2.08	29.9	2.61	39.9	3.20	52.6	3.85	75.7	5.08	100.4	6.63
	16	15.5	1.68	21.2	2.10	29.9	2.64	39.9	3.23	52.6	3.89	75.7	5.14	100.4	6.69
	18	15.5	1.70	21.2	2.12	29.9	2.66	39.9	3.27	52.6	3.93	75.7	5.19	100.4	6.76
	20	15.5	1.71	21.2	2.14	29.9	2.69	39.9	3.30	52.6	3.97	75.7	5.24	100.4	6.83
	21	15.5	1.72	21.2	2.22	37.1	3.45	47.0	3.96	59.8	4.77	82.1	5.76	105.8	7.51
	23	15.5	1.83	33.6	3.78	51.5	5.16	66.4	6.18	75.7	7.01	94.6	8.54	116.8	10.34
	25	27.9	3.35	46.1	5.56	65.9	7.24	87.9	10.02	93.0	10.21	107.1	12.02	127.8	14.60
	27	40.4	4.79	58.6	7.82	81.6	10.09	101.9	13.35	108.2	13.76	119.6	15.73	138.7	18.58
	29	53.0	6.29	71.0	10.08	94.6	12.97	114.6	16.57	123.3	17.75	132.0	19.50	149.7	23.47
	31	65.5	8.00	83.5	11.98	107.6	15.80	124.7	18.48	132.0	19.64	144.3	21.05	160.7	25.82
	33	78.0	11.14	96.0	14.43	120.6	17.74	129.6	20.25	137.5	21.70	156.1	24.95	171.4	28.97
	35	90.7	17.91	108.5	21.54	125.8	25.44	134.4	27.60	143.0	29.75	160.3	34.33	178.6	39.45
	37	90.7	18.98	108.5	22.75	125.8	26.93	134.4	29.21	143.0	31.50	160.3	36.62	178.6	41.87
	39	90.7	20.25	108.5	24.39	125.8	28.85	134.4	31.45	143.0	33.80	160.3	39.00	178.6	45.22
	41	88.4	21.90	105.7	26.40	122.5	31.55	131.0	34.06	139.4	36.62	156.2	42.75	174.0	49.11
	43	86.2	23.79	103.1	28.72	119.5	34.32	127.7	37.09	135.9	39.87	152.4	46.62	169.7	53.57
46	80.8	26.65	96.6	32.21	112.0	38.50	119.7	41.65	127.4	44.77	142.8	52.46	159.0	60.31	
48	71.5	23.23	85.5	28.09	99.1	33.59	105.9	36.35	112.7	39.07	126.3	45.84	140.7	52.72	

**Note**

1. TC: Total Capacity(kW), PI : Power Input(kW, Comp. + Outdoor fan motor)
2. Capacity tables show the average value of conditions which may occur.

# 7. Capacity Tables

## 7.2 Heating Capacity

### 7.2.1 Standard Mode

◆ ARUM080LTE5

Heating Capacity (8HP)

Combination (%)	Outdoor air temp.		Indoor air temp. °C DB											
			16		18		20		21		22		24	
	°C DB	°C WB	TC	PI	TC	PI	TC	PI	TC	PI	TC	PI	TC	PI
130	-24.8	-25	15.6	7.34	15.6	7.39	15.5	7.43	15.5	7.50	15.5	7.56	15.2	7.66
	-21.8	-22	19.0	7.44	19.0	7.49	18.9	7.53	18.9	7.60	18.9	7.66	18.5	7.76
	-19.8	-20	20.1	7.50	20.1	7.55	19.9	7.60	19.9	7.66	19.9	7.72	19.5	7.82
	-18.8	-19	20.5	7.54	20.5	7.59	20.4	7.63	20.4	7.69	20.4	7.76	20.0	7.85
	-16.7	-17	21.5	7.61	21.5	7.65	21.4	7.70	21.4	7.76	21.4	7.82	21.0	7.92
	-13.7	-15	22.9	7.70	22.9	7.75	22.8	7.79	22.8	7.86	22.8	7.92	22.3	7.57
	-11.8	-13	23.7	7.77	23.7	7.81	23.5	7.86	23.5	7.92	23.5	7.68	23.2	7.34
	-9.8	-11	24.5	7.83	24.5	7.88	24.3	7.92	24.3	7.66	24.3	7.42	24.1	7.10
	-9.5	-10	24.6	7.84	24.6	7.89	24.5	7.88	24.5	7.62	24.4	7.38	24.3	7.07
	-8.5	-9.1	25.1	7.87	25.1	7.92	24.9	7.74	24.9	7.48	24.8	7.26	24.7	6.95
	-7.0	-7.6	25.8	7.92	25.8	7.71	25.6	7.53	25.6	7.29	25.6	7.06	25.4	6.77
	-5.0	-5.6	26.7	7.64	26.7	7.43	26.5	7.26	26.5	7.02	26.5	6.81	26.3	6.53
	-3.0	-3.7	27.6	7.36	27.6	7.15	27.5	6.98	27.5	6.76	27.5	6.55	27.3	6.30
	0.0	-0.7	29.0	6.94	29.0	6.74	28.9	6.56	28.9	6.36	28.9	6.17	28.4	5.94
	3.0	2.2	30.4	6.51	30.4	6.32	30.2	6.15	30.2	5.96	30.2	5.78	28.4	5.58
	5.0	4.1	31.4	6.23	31.4	6.04	31.2	5.87	31.2	5.69	30.6	5.52	28.4	5.35
	7.0	6.0	32.3	5.95	32.3	5.76	32.1	5.59	31.7	5.43	30.6	5.27	28.4	5.11
	9.0	7.9	32.6	5.71	32.6	5.53	32.5	5.37	31.7	5.21	30.6	5.06	28.4	4.91
11.0	9.8	32.6	5.52	32.6	5.34	32.5	5.19	31.7	5.04	30.6	4.89	28.4	4.74	
13.0	11.8	32.6	5.32	32.6	5.15	32.5	5.00	31.7	4.85	30.6	4.71	28.4	4.57	
15.0	13.7	32.6	5.11	32.6	4.94	32.5	4.80	31.7	4.66	30.6	4.52	28.4	4.38	
120	-24.8	-25	15.5	7.39	15.5	7.43	15.4	7.50	15.4	7.56	15.4	7.66	15.1	7.73
	-21.8	-22	18.9	7.49	18.9	7.53	18.8	7.60	18.8	7.66	18.8	7.76	18.4	7.82
	-19.8	-20	19.9	7.55	19.9	7.60	19.8	7.66	19.8	7.72	19.8	7.82	19.4	7.89
	-18.8	-19	20.4	7.59	20.4	7.63	20.3	7.69	20.3	7.76	20.3	7.85	19.9	7.92
	-16.7	-17	21.4	7.65	21.4	7.70	21.2	7.76	21.2	7.82	21.2	7.92	20.8	7.69
	-13.7	-15	22.8	7.75	22.8	7.79	22.6	7.86	22.6	7.92	22.6	7.58	22.2	7.37
	-11.8	-13	23.5	7.81	23.5	7.86	23.4	7.92	23.4	7.68	23.4	7.36	23.1	7.16
	-9.8	-11	24.3	7.88	24.3	7.92	24.2	7.65	24.2	7.42	24.2	7.13	24.0	6.94
	-9.5	-10	24.4	7.89	24.4	7.88	24.3	7.61	24.3	7.38	24.3	7.10	24.1	6.91
	-8.5	-9.1	24.9	7.92	24.9	7.73	24.8	7.47	24.8	7.25	24.8	6.98	24.6	6.80
	-7.0	-7.6	25.6	7.70	25.6	7.51	25.4	7.27	25.4	7.06	25.4	6.81	25.2	6.64
	-5.0	-5.6	26.5	7.40	26.5	7.22	26.4	6.99	26.4	6.80	26.4	6.58	26.2	6.42
	-3.0	-3.7	27.5	7.10	27.5	6.93	27.3	6.72	27.3	6.54	27.3	6.35	26.7	6.20
	0.0	-0.7	28.8	6.66	28.8	6.49	28.7	6.31	28.7	6.15	28.7	6.00	26.7	5.87
	3.0	2.2	30.2	6.21	30.2	6.05	30.0	5.90	29.7	5.77	28.8	5.66	26.7	5.54
	5.0	4.1	31.1	5.91	31.1	5.75	30.7	5.63	29.7	5.51	28.8	5.43	26.7	5.33
	7.0	6.0	32.1	5.61	32.0	5.46	30.7	5.35	29.7	5.25	28.8	5.20	26.7	5.11
	9.0	7.9	32.3	5.38	32.0	5.23	30.7	5.13	29.7	5.03	28.8	4.99	26.7	4.90
11.0	9.8	32.3	5.19	32.0	5.05	30.7	4.95	29.7	4.86	28.8	4.81	26.7	4.72	
13.0	11.8	32.3	4.99	32.0	4.86	30.7	4.76	29.7	4.67	28.8	4.63	26.7	4.54	
15.0	13.7	32.3	4.78	32.0	4.65	30.7	4.56	29.7	4.47	28.8	4.43	26.7	4.35	
110	-24.8	-25	15.4	7.43	15.4	7.50	15.3	7.56	15.3	7.66	15.3	7.73	15.0	7.76
	-21.8	-22	18.8	7.53	18.8	7.60	18.7	7.66	18.7	7.76	18.7	7.82	18.3	7.86
	-19.8	-20	19.8	7.60	19.8	7.66	19.7	7.72	19.7	7.82	19.7	7.89	19.3	7.92
	-18.8	-19	20.3	7.63	20.3	7.69	20.2	7.76	20.2	7.85	20.2	7.92	19.7	7.80
	-16.7	-17	21.3	7.70	21.3	7.76	21.1	7.82	21.1	7.92	21.1	7.68	20.7	7.56
	-13.7	-15	22.7	7.79	22.7	7.86	22.5	7.92	22.5	7.55	22.5	7.33	22.5	7.21
	-11.8	-13	23.4	7.86	23.4	7.92	23.3	7.66	23.3	7.32	23.3	7.11	23.3	6.98
	-9.8	-11	24.2	7.92	24.2	7.62	24.0	7.38	24.0	7.07	24.0	6.88	24.0	6.75
	-9.5	-10	24.3	7.87	24.3	7.58	24.2	7.34	24.2	7.03	24.2	6.84	24.0	6.71
	-8.5	-9.1	24.8	7.71	24.8	7.43	24.6	7.20	24.6	6.91	24.6	6.73	24.0	6.59
	-7.0	-7.6	25.5	7.47	25.5	7.20	25.3	6.99	25.3	6.72	25.3	6.55	24.0	6.42
	-5.0	-5.6	26.4	7.14	26.4	6.90	26.2	6.72	26.2	6.47	25.8	6.32	24.0	6.18
	-3.0	-3.7	27.3	6.82	27.3	6.61	27.1	6.44	26.7	6.23	25.8	6.09	24.0	5.95
	0.0	-0.7	28.7	6.33	28.7	6.16	27.6	6.02	26.7	5.86	25.8	5.74	24.0	5.60
	3.0	2.2	30.1	5.84	29.4	5.71	27.6	5.61	26.7	5.49	25.8	5.39	24.0	5.24
	5.0	4.1	31.0	5.51	29.4	5.41	27.6	5.33	26.7	5.24	25.8	5.16	24.0	5.01
	7.0	6.0	31.1	5.19	29.4	5.11	27.6	5.05	26.7	4.99	25.8	4.93	24.0	4.77
	9.0	7.9	31.1	4.95	29.4	4.88	27.6	4.82	26.7	4.76	25.8	4.70	24.0	4.56
11.0	9.8	31.1	4.76	29.4	4.69	27.6	4.63	26.7	4.58	25.8	4.52	24.0	4.38	
13.0	11.8	31.1	4.55	29.4	4.48	27.6	4.43	26.7	4.38	25.8	4.32	24.0	4.19	
15.0	13.7	31.1	4.33	29.4	4.27	27.6	4.22	26.7	4.17	25.8	4.11	24.0	3.99	

# 7. Capacity Tables

Heating Capacity (8HP)

Combination (%)	Outdoor air temp.		Indoor air temp. °C DB											
			16		18		20		21		22		24	
	°C DB	°C WB	TC	PI	TC	PI	TC	PI	TC	PI	TC	PI	TC	PI
100	-24.8	-25	15.4	8.23	15.4	8.19	15.3	7.60	15.3	8.09	15.3	8.05	15.0	8.03
	-21.8	-22	18.7	8.17	18.7	8.13	18.6	7.84	18.6	8.03	18.6	8.10	18.2	7.96
	-19.8	-20	19.7	8.13	19.7	8.09	19.6	7.99	19.6	7.99	19.6	7.98	19.2	7.92
	-18.8	-19	20.2	8.11	20.1	8.07	20.1	8.03	20.1	7.97	20.1	7.92	19.7	7.78
	-16.7	-17	21.0	8.06	21.0	8.02	21.0	8.10	20.9	7.92	20.9	7.63	20.5	7.49
	-13.7	-15	22.6	8.00	22.6	7.96	22.4	7.92	22.4	7.50	22.4	7.22	22.0	7.08
	-11.8	-13	23.3	7.96	23.2	7.92	23.2	7.63	23.2	7.23	23.2	6.96	22.0	6.81
	-9.8	-11	24.0	7.92	24.0	7.60	23.9	7.33	23.9	6.95	23.6	6.68	22.0	6.54
	-9.5	-10	24.2	7.87	24.2	7.55	24.1	7.28	24.1	6.90	23.6	6.64	22.0	6.49
	-8.5	-9.1	24.6	7.70	24.6	7.38	24.5	7.13	24.4	6.76	23.6	6.51	22.0	6.36
	-7.0	-7.6	25.8	7.44	25.6	7.14	25.2	6.90	24.4	6.55	23.6	6.30	22.0	6.15
	-5.0	-5.6	26.9	7.09	26.6	6.82	25.2	6.60	24.4	6.27	23.6	6.02	22.0	5.87
	-3.0	-3.7	27.7	6.75	26.8	6.49	25.2	6.30	24.4	5.99	23.6	5.75	22.0	5.59
	0.0	-0.7	28.4	6.23	26.8	6.00	25.2	5.84	24.4	5.56	23.6	5.34	22.0	5.18
	3.0	2.2	28.4	5.71	26.8	5.51	25.2	5.39	24.4	5.14	23.6	4.93	22.0	4.76
	5.0	4.1	28.4	5.37	26.8	5.19	25.2	5.08	24.4	4.86	23.6	4.65	22.0	4.49
	7.0	6.0	28.4	5.02	26.8	4.86	25.2	4.78	24.4	4.57	23.6	4.38	22.0	4.21
	9.0	7.9	28.4	4.76	26.8	4.61	25.2	4.53	24.4	4.34	23.6	4.15	22.0	3.99
11.0	9.8	28.4	4.54	26.8	4.40	25.2	4.32	24.4	4.13	23.6	3.95	22.0	3.80	
13.0	11.8	28.4	4.30	26.8	4.17	25.2	4.10	24.4	3.92	23.6	3.75	22.0	3.61	
15.0	13.7	28.4	4.06	26.8	3.93	25.2	3.86	24.4	3.69	23.6	3.53	22.0	3.40	
90	-24.8	-25	15.3	7.31	15.3	7.41	15.2	7.48	15.2	7.51	15.2	7.58	14.9	7.68
	-21.8	-22	18.6	7.41	18.6	7.51	18.5	7.58	18.5	7.61	18.5	7.68	18.1	7.31
	-19.8	-20	19.7	7.48	19.7	7.57	19.5	7.64	19.5	7.68	19.5	7.72	19.1	7.07
	-18.8	-19	20.2	7.51	20.1	7.61	20.0	7.68	20.0	7.54	20.0	7.30	19.6	6.95
	-16.7	-17	21.0	7.58	21.0	7.68	21.0	7.40	21.0	7.27	21.0	7.03	20.1	6.69
	-13.7	-15	22.6	7.68	22.6	7.27	22.3	7.01	22.3	6.88	21.6	6.66	20.1	6.33
	-11.8	-13	23.3	7.39	23.2	7.01	23.1	6.77	22.3	6.63	21.6	6.42	20.1	6.10
	-9.8	-11	24.0	7.09	24.0	6.74	23.1	6.51	22.3	6.37	21.6	6.17	20.1	5.86
	-9.5	-10	24.2	7.05	24.2	6.69	23.1	6.47	22.3	6.33	21.6	6.13	20.1	5.82
	-8.5	-9.1	24.6	6.90	24.5	6.56	23.1	6.34	22.3	6.20	21.6	6.00	20.1	5.70
	-7.0	-7.6	25.8	6.68	24.5	6.35	23.1	6.14	22.3	6.01	21.6	5.82	20.1	5.52
	-5.0	-5.6	26.0	6.38	24.5	6.08	23.1	5.89	22.3	5.75	21.6	5.56	20.1	5.28
	-3.0	-3.7	26.0	6.08	24.5	5.81	23.1	5.63	22.3	5.49	21.6	5.31	20.1	5.04
	0.0	-0.7	26.0	5.63	24.5	5.40	23.1	5.24	22.3	5.09	21.6	4.94	20.1	4.67
	3.0	2.2	26.0	5.19	24.5	4.99	23.1	4.85	22.3	4.70	21.6	4.56	20.1	4.31
	5.0	4.1	26.0	4.89	24.5	4.72	23.1	4.59	22.3	4.44	21.6	4.31	20.1	4.07
	7.0	6.0	26.0	4.59	24.5	4.45	23.1	4.33	22.3	4.18	21.6	4.06	20.1	3.83
	9.0	7.9	26.0	4.31	24.5	4.18	23.1	4.07	22.3	3.93	21.6	3.81	20.1	3.60
11.0	9.8	26.0	4.04	24.5	3.92	23.1	3.81	22.3	3.68	21.6	3.57	20.1	3.37	
13.0	11.8	26.0	3.76	24.5	3.65	23.1	3.55	22.3	3.43	21.6	3.33	20.1	3.14	
15.0	13.7	26.0	3.49	24.5	3.38	23.1	3.29	22.3	3.18	21.6	3.08	20.1	2.91	
80	-24.8	-25	15.2	6.44	15.2	6.54	15.1	6.61	15.1	6.64	15.1	6.81	14.8	6.49
	-21.8	-22	18.4	6.54	18.4	6.64	18.4	6.71	18.4	6.81	18.4	6.49	17.9	6.18
	-19.8	-20	19.4	6.61	19.4	6.70	19.4	6.81	19.4	6.58	19.3	6.27	17.9	5.98
	-18.8	-19	19.9	6.64	19.9	6.81	19.9	6.69	19.9	6.46	19.3	6.17	17.9	5.88
	-16.7	-17	20.6	6.81	20.6	6.56	20.6	6.44	20.0	6.23	19.3	5.94	17.9	5.66
	-13.7	-15	21.6	6.44	21.1	6.21	20.6	6.10	20.0	5.88	19.3	5.62	17.9	5.36
	-11.8	-13	22.1	6.21	21.5	5.99	20.6	5.87	20.0	5.67	19.3	5.42	17.9	5.17
	-9.8	-11	22.7	5.96	21.8	5.76	20.6	5.64	20.0	5.44	19.3	5.21	17.9	4.96
	-9.5	-10	22.8	5.93	21.9	5.72	20.6	5.61	20.0	5.41	19.3	5.17	17.9	4.93
	-8.5	-9.1	23.1	5.80	22.0	5.60	20.6	5.49	20.0	5.29	19.3	5.07	17.9	4.83
	-7.0	-7.6	23.3	5.62	22.0	5.43	20.6	5.31	20.0	5.12	19.3	4.91	17.9	4.68
	-5.0	-5.6	23.3	5.38	22.0	5.20	20.6	5.08	20.0	4.90	19.3	4.69	17.9	4.48
	-3.0	-3.7	23.3	5.13	22.0	4.96	20.6	4.85	20.0	4.67	19.3	4.48	17.9	4.27
	0.0	-0.7	23.3	4.76	22.0	4.61	20.6	4.50	20.0	4.33	19.3	4.16	17.9	3.97
	3.0	2.2	23.3	4.40	22.0	4.26	20.6	4.15	20.0	3.99	19.3	3.84	17.9	3.67
	5.0	4.1	23.3	4.15	22.0	4.03	20.6	3.92	20.0	3.76	19.3	3.63	17.9	3.46
	7.0	6.0	23.3	3.91	22.0	3.80	20.6	3.68	20.0	3.53	19.3	3.41	17.9	3.26
	9.0	7.9	23.3	3.67	22.0	3.56	20.6	3.46	20.0	3.31	19.3	3.21	17.9	3.06
11.0	9.8	23.3	3.41	22.0	3.31	20.6	3.21	20.0	3.08	19.3	2.98	17.9	2.84	
13.0	11.8	23.3	3.18	22.0	3.09	20.6	3.00	20.0	2.87	19.3	2.78	17.9	2.65	
15.0	13.7	23.3	2.99	22.0	2.91	20.6	2.82	20.0	2.70	19.3	2.61	17.9	2.50	

# 7. Capacity Tables

Heating Capacity (8HP)

Combination (%)	Outdoor air temp.		Indoor air temp. °C DB													
			16		18		20		21		22		24			
	°C DB	°C WB	TC	PI	TC	PI	TC	PI	TC	PI	TC	PI	TC	PI		
70	-24.8	-25	15.2	6.45	15.2	6.48	15.1	6.55	15.1	6.65	15.1	6.65	15.1	6.30	14.8	5.99
	-21.8	-22	17.7	6.55	17.7	6.58	17.6	6.65	17.0	6.30	16.5	5.99	15.4	5.68		
	-19.8	-20	19.3	6.61	18.7	6.65	17.6	6.40	17.0	6.08	16.5	5.77	15.4	5.48		
	-18.8	-19	19.8	6.65	18.7	6.52	17.6	6.28	17.0	5.96	16.5	5.67	15.4	5.37		
	-16.7	-17	19.8	6.38	18.7	6.26	17.6	6.03	17.0	5.72	16.5	5.44	15.4	5.16		
	-13.7	-15	19.8	6.01	18.7	5.88	17.6	5.67	17.0	5.38	16.5	5.12	15.4	4.86		
	-11.8	-13	19.8	5.77	18.7	5.64	17.6	5.44	17.0	5.16	16.5	4.92	15.4	4.66		
	-9.8	-11	19.8	5.52	18.7	5.39	17.6	5.19	17.0	4.93	16.5	4.71	15.4	4.46		
	-9.5	-10	19.8	5.48	18.7	5.35	17.6	5.16	17.0	4.90	16.5	4.68	15.4	4.43		
	-8.5	-9.1	19.8	5.35	18.7	5.22	17.6	5.04	17.0	4.79	16.5	4.57	15.4	4.33		
	-7.0	-7.6	19.8	5.16	18.7	5.03	17.6	4.85	17.0	4.61	16.5	4.41	15.4	4.17		
	-5.0	-5.6	19.8	4.91	18.7	4.78	17.6	4.61	17.0	4.39	16.5	4.20	15.4	3.97		
	-3.0	-3.7	19.8	4.66	18.7	4.53	17.6	4.37	17.0	4.16	16.5	3.99	15.4	3.77		
	0.0	-0.7	19.8	4.28	18.7	4.15	17.6	4.01	17.0	3.81	16.5	3.67	15.4	3.46		
	3.0	2.2	19.8	3.91	18.7	3.77	17.6	3.64	17.0	3.47	16.5	3.35	15.4	3.16		
	5.0	4.1	19.8	3.66	18.7	3.52	17.6	3.40	17.0	3.24	16.5	3.14	15.4	2.95		
	7.0	6.0	19.8	3.40	18.7	3.27	17.6	3.16	17.0	3.01	16.5	2.92	15.4	2.75		
9.0	7.9	19.8	3.07	18.7	2.95	17.6	2.85	17.0	2.72	16.5	2.64	15.4	2.48			
11.0	9.8	19.8	2.86	18.7	2.75	17.6	2.66	17.0	2.53	16.5	2.46	15.4	2.31			
13.0	11.8	19.8	2.68	18.7	2.57	17.6	2.48	17.0	2.37	16.5	2.30	15.4	2.16			
15.0	13.7	19.8	2.52	18.7	2.42	17.6	2.34	17.0	2.24	16.5	2.17	15.4	2.04			
60	-24.8	-25	15.1	6.39	15.1	6.45	15.1	6.55	14.5	6.19	14.0	5.85	13.1	5.53		
	-21.8	-22	16.2	6.48	16.1	6.55	15.1	6.19	14.5	5.85	14.0	5.53	13.1	5.23		
	-19.8	-20	17.0	6.55	16.1	6.29	15.1	5.94	14.5	5.62	14.0	5.32	13.1	5.02		
	-18.8	-19	17.0	6.42	16.1	6.16	15.1	5.82	14.5	5.51	14.0	5.21	13.1	4.92		
	-16.7	-17	17.0	6.14	16.1	5.89	15.1	5.57	14.5	5.27	14.0	4.99	13.1	4.71		
	-13.7	-15	17.0	5.75	16.1	5.50	15.1	5.20	14.5	4.93	14.0	4.67	13.1	4.41		
	-11.8	-13	17.0	5.50	16.1	5.26	15.1	4.97	14.5	4.72	14.0	4.47	13.1	4.21		
	-9.8	-11	17.0	5.23	16.1	5.00	15.1	4.73	14.5	4.49	14.0	4.26	13.1	4.01		
	-9.5	-10	17.0	5.19	16.1	4.96	15.1	4.70	14.5	4.46	14.0	4.23	13.1	3.98		
	-8.5	-9.1	17.0	5.06	16.1	4.83	15.1	4.57	14.5	4.34	14.0	4.12	13.1	3.88		
	-7.0	-7.6	17.0	4.86	16.1	4.64	15.1	4.39	14.5	4.17	14.0	3.97	13.1	3.73		
	-5.0	-5.6	17.0	4.60	16.1	4.38	15.1	4.15	14.5	3.95	14.0	3.75	13.1	3.53		
	-3.0	-3.7	17.0	4.34	16.1	4.12	15.1	3.91	14.5	3.72	14.0	3.54	13.1	3.32		
	0.0	-0.7	17.0	3.94	16.1	3.73	15.1	3.54	14.5	3.38	14.0	3.23	13.1	3.02		
	3.0	2.2	17.0	3.55	16.1	3.35	15.1	3.18	14.5	3.04	14.0	2.91	13.1	2.72		
	5.0	4.1	17.0	3.28	16.1	3.09	15.1	2.94	14.5	2.82	14.0	2.70	13.1	2.51		
	7.0	6.0	17.0	3.02	16.1	2.83	15.1	2.70	14.5	2.59	14.0	2.49	13.1	2.31		
9.0	7.9	17.0	2.69	16.1	2.52	15.1	2.41	14.5	2.31	14.0	2.22	13.1	2.06			
11.0	9.8	17.0	2.52	16.1	2.36	15.1	2.25	14.5	2.16	14.0	2.07	13.1	1.93			
13.0	11.8	17.0	2.36	16.1	2.21	15.1	2.10	14.5	2.02	14.0	1.94	13.1	1.80			
15.0	13.7	17.0	2.23	16.1	2.09	15.1	1.99	14.5	1.91	14.0	1.83	13.1	1.71			
50	-24.8	-25	14.1	5.55	13.3	5.65	12.5	5.33	12.1	5.04	11.7	4.76	10.9	4.50		
	-21.8	-22	14.1	5.65	13.3	5.33	12.5	5.04	12.1	4.76	11.7	4.50	10.9	4.25		
	-19.8	-20	14.1	5.43	13.3	5.12	12.5	4.84	12.1	4.57	11.7	4.33	10.9	4.09		
	-18.8	-19	14.1	5.32	13.3	5.01	12.5	4.74	12.1	4.48	11.7	4.24	10.9	4.01		
	-16.7	-17	14.1	5.08	13.3	4.79	12.5	4.53	12.1	4.28	11.7	4.06	10.9	3.83		
	-13.7	-15	14.1	4.75	13.3	4.47	12.5	4.24	12.1	4.01	11.7	3.80	10.9	3.59		
	-11.8	-13	14.1	4.53	13.3	4.27	12.5	4.05	12.1	3.83	11.7	3.64	10.9	3.43		
	-9.8	-11	14.1	4.31	13.3	4.06	12.5	3.85	12.1	3.65	11.7	3.47	10.9	3.27		
	-9.5	-10	14.1	4.28	13.3	4.03	12.5	3.82	12.1	3.62	11.7	3.44	10.9	3.24		
	-8.5	-9.1	14.1	4.17	13.3	3.92	12.5	3.72	12.1	3.52	11.7	3.36	10.9	3.16		
	-7.0	-7.6	14.1	4.00	13.3	3.76	12.5	3.58	12.1	3.39	11.7	3.23	10.9	3.04		
	-5.0	-5.6	14.1	3.77	13.3	3.55	12.5	3.38	12.1	3.20	11.7	3.05	10.9	2.87		
	-3.0	-3.7	14.1	3.55	13.3	3.34	12.5	3.18	12.1	3.01	11.7	2.88	10.9	2.71		
	0.0	-0.7	14.1	3.22	13.3	3.02	12.5	2.89	12.1	2.74	11.7	2.62	10.9	2.46		
	3.0	2.2	14.1	2.88	13.3	2.70	12.5	2.59	12.1	2.46	11.7	2.37	10.9	2.22		
	5.0	4.1	14.1	2.66	13.3	2.49	12.5	2.39	12.1	2.27	11.7	2.19	10.9	2.05		
	7.0	6.0	14.1	2.44	13.3	2.28	12.5	2.20	12.1	2.09	11.7	2.02	10.9	1.89		
9.0	7.9	14.1	2.20	13.3	2.06	12.5	1.98	12.1	1.88	11.7	1.83	10.9	1.70			
11.0	9.8	14.1	2.06	13.3	1.93	12.5	1.86	12.1	1.76	11.7	1.71	10.9	1.59			
13.0	11.8	14.1	1.93	13.3	1.81	12.5	1.74	12.1	1.66	11.7	1.60	10.9	1.50			
15.0	13.7	14.1	1.83	13.3	1.71	12.5	1.65	12.1	1.57	11.7	1.52	10.9	1.42			

**Note**

1. TC: Total Capacity(kW), PI : Power Input(kW, Comp. + Outdoor fan motor)
2. Capacity tables show the average value of conditions which may occur.
3. The heating capacity table is based on the values expressed as Max. in the specification of the outdoor unit. (When measuring the Max. heating capacity, the setting status of the indoor unit is the same as that for measuring the heating capacity of the indoor unit.)

# 7. Capacity Tables

## ◆ ARUM100LTE5

Heating Capacity (10HP)

Combination (%)	Outdoor air temp.		Indoor air temp. °C DB											
			16		18		20		21		22		24	
	°C DB	°C WB	TC	PI	TC	PI	TC	PI	TC	PI	TC	PI	TC	PI
130	-24.8	-25	20.4	9.67	20.4	9.77	20.2	9.86	20.2	9.99	20.2	10.11	19.7	10.31
	-21.8	-22	24.7	9.87	24.7	9.97	24.6	10.05	24.6	10.18	24.6	10.31	24.0	10.50
	-19.8	-20	26.1	10.00	26.1	10.10	25.9	10.18	25.9	10.31	25.9	10.44	25.3	10.63
	-18.8	-19	26.6	10.07	26.6	10.16	26.4	10.25	26.4	10.38	26.4	10.50	25.7	10.70
	-16.7	-17	27.5	10.20	27.5	10.30	27.3	10.39	27.3	10.52	27.3	10.64	26.6	10.84
	-13.7	-15	28.8	10.40	28.8	10.50	28.7	10.58	28.7	10.71	28.7	10.84	27.9	10.27
	-11.8	-13	29.7	10.52	29.7	10.62	29.5	10.71	29.5	10.84	29.5	10.44	28.8	9.90
	-9.8	-11	30.5	10.65	30.5	10.75	30.3	10.84	30.3	10.40	30.3	10.02	29.6	9.52
	-9.5	-10	30.7	10.67	30.7	10.77	30.5	10.77	30.5	10.33	30.5	9.96	29.8	9.47
	-8.5	-9.1	31.3	10.74	31.3	10.84	31.1	10.53	31.1	10.11	30.9	9.75	30.2	9.28
	-7.0	-7.6	32.2	10.84	32.2	10.48	32.0	10.18	32.0	9.79	32.0	9.44	30.8	8.99
	-5.0	-5.6	33.4	10.34	33.4	10.00	33.2	9.72	33.2	9.35	33.2	9.02	31.7	8.61
	-3.0	-3.7	34.7	9.85	34.7	9.52	34.4	9.25	34.4	8.91	34.4	8.61	32.6	8.23
	0.0	-0.7	36.5	9.10	36.5	8.81	36.3	8.56	36.3	8.26	36.3	7.98	33.9	7.66
	3.0	2.2	38.3	8.36	38.3	8.09	38.1	7.86	38.1	7.60	38.1	7.36	35.2	7.09
	5.0	4.1	39.5	7.87	39.5	7.61	39.3	7.39	39.3	7.16	38.2	6.94	35.6	6.71
	7.0	6.0	40.7	7.37	40.7	7.13	40.5	6.93	39.6	6.72	38.2	6.52	35.6	6.33
9.0	7.9	40.7	6.94	40.7	6.72	40.6	6.53	39.6	6.34	38.2	6.15	35.6	5.96	
11.0	9.8	40.7	6.57	40.7	6.36	40.6	6.18	39.6	6.00	38.2	5.82	35.6	5.64	
13.0	11.8	40.7	6.18	40.7	5.98	40.6	5.81	39.6	5.64	38.2	5.47	35.6	5.31	
15.0	13.7	40.7	5.77	40.7	5.58	40.6	5.42	39.6	5.26	38.2	5.10	35.6	4.95	
120	-24.8	-25	20.2	9.77	20.2	9.86	20.1	9.99	20.1	10.11	20.1	10.31	19.6	10.44
	-21.8	-22	24.6	9.97	24.6	10.05	24.4	10.18	24.4	10.31	24.4	10.50	23.8	10.64
	-19.8	-20	25.9	10.10	25.9	10.18	25.8	10.31	25.8	10.44	25.8	10.63	25.1	10.77
	-18.8	-19	26.4	10.16	26.4	10.25	26.2	10.38	26.2	10.50	26.2	10.70	25.5	10.84
	-16.7	-17	27.3	10.30	27.3	10.39	27.1	10.52	27.1	10.64	27.1	10.84	26.4	10.47
	-13.7	-15	28.6	10.50	28.6	10.58	28.5	10.71	28.5	10.84	28.5	10.28	27.7	9.95
	-11.8	-13	29.5	10.62	29.5	10.71	29.3	10.84	29.3	10.44	29.3	9.93	28.6	9.61
	-9.8	-11	30.3	10.75	30.3	10.84	30.1	10.39	30.1	10.02	30.1	9.56	29.4	9.26
	-9.5	-10	30.5	10.77	30.5	10.76	30.3	10.32	30.3	9.96	30.3	9.50	29.5	9.21
	-8.5	-9.1	31.1	10.84	31.1	10.52	30.9	10.10	30.9	9.75	30.8	9.32	30.0	9.04
	-7.0	-7.6	32.0	10.46	32.0	10.16	31.8	9.76	31.8	9.43	31.4	9.04	30.6	8.77
	-5.0	-5.6	33.2	9.96	33.2	9.67	33.0	9.32	33.0	9.02	33.0	8.67	31.5	8.42
	-3.0	-3.7	34.4	9.46	34.4	9.19	34.2	8.87	34.2	8.60	34.2	8.30	32.3	8.07
	0.0	-0.7	36.2	8.71	36.2	8.46	36.0	8.20	36.0	7.97	35.8	7.74	33.4	7.55
	3.0	2.2	38.0	7.95	38.0	7.73	37.8	7.53	37.1	7.34	35.8	7.18	33.4	7.03
	5.0	4.1	39.3	7.45	39.3	7.25	38.4	7.08	37.1	6.92	36.0	6.81	33.4	6.68
	7.0	6.0	40.4	6.95	40.0	6.76	38.4	6.63	37.1	6.50	36.0	6.44	33.4	6.33
9.0	7.9	40.4	6.55	40.0	6.37	38.4	6.24	37.1	6.13	36.0	6.07	33.4	5.96	
11.0	9.8	40.4	6.19	40.0	6.03	38.4	5.91	37.1	5.79	36.0	5.74	33.4	5.64	
13.0	11.8	40.4	5.82	40.0	5.66	38.4	5.55	37.1	5.45	36.0	5.39	33.4	5.30	
15.0	13.7	40.4	5.43	40.0	5.28	38.4	5.18	37.1	5.08	36.0	5.03	33.4	4.94	
110	-24.8	-25	20.1	9.86	20.1	9.99	20.0	10.11	20.0	10.31	20.0	10.44	19.5	10.51
	-21.8	-22	24.4	10.05	24.4	10.18	24.3	10.31	24.3	10.50	24.3	10.64	23.7	10.71
	-19.8	-20	25.8	10.18	25.8	10.31	25.6	10.44	25.6	10.63	25.6	10.77	25.0	10.84
	-18.8	-19	26.2	10.25	26.2	10.38	26.1	10.50	26.1	10.70	26.1	10.84	25.4	10.65
	-16.7	-17	27.2	10.39	27.2	10.52	27.0	10.64	27.0	10.84	27.0	10.45	26.3	10.27
	-13.7	-15	28.5	10.58	28.5	10.71	28.3	10.84	28.3	10.25	28.3	9.90	28.3	9.72
	-11.8	-13	29.3	10.71	29.3	10.84	29.1	10.42	29.1	9.87	29.1	9.55	29.1	9.37
	-9.8	-11	30.1	10.84	30.1	10.36	30.0	9.97	30.0	9.48	30.0	9.18	29.4	9.00
	-9.5	-10	30.3	10.76	30.3	10.28	30.1	9.91	30.1	9.42	30.1	9.13	29.8	8.94
	-8.5	-9.1	30.9	10.50	30.9	10.05	30.7	9.69	30.7	9.23	30.7	8.95	30.1	8.76
	-7.0	-7.6	31.8	10.10	31.8	9.69	31.6	9.35	31.6	8.93	31.6	8.67	30.1	8.49
	-5.0	-5.6	33.0	9.58	33.0	9.21	32.8	8.91	32.8	8.54	32.2	8.30	30.1	8.12
	-3.0	-3.7	34.2	9.05	34.2	8.73	34.0	8.47	33.3	8.15	32.2	7.94	30.1	7.75
	0.0	-0.7	36.0	8.26	36.0	8.01	34.4	7.81	33.3	7.56	32.2	7.39	30.1	7.20
	3.0	2.2	37.8	7.48	36.7	7.29	34.4	7.14	33.3	6.97	32.2	6.84	30.1	6.65
	5.0	4.1	38.8	6.95	36.7	6.81	34.4	6.70	33.3	6.57	32.2	6.47	30.1	6.28
	7.0	6.0	38.8	6.43	36.7	6.33	34.4	6.26	33.3	6.18	32.2	6.10	30.1	5.91
9.0	7.9	38.8	6.03	36.7	5.94	34.4	5.87	33.3	5.80	32.2	5.73	30.1	5.55	
11.0	9.8	38.8	5.68	36.7	5.60	34.4	5.53	33.3	5.47	32.2	5.40	30.1	5.23	
13.0	11.8	38.8	5.32	36.7	5.24	34.4	5.18	33.3	5.11	32.2	5.05	30.1	4.89	
15.0	13.7	38.8	4.93	36.7	4.86	34.4	4.80	33.3	4.74	32.2	4.68	30.1	4.54	

# 7. Capacity Tables

Heating Capacity (10HP)

Combination (%)	Outdoor air temp.		Indoor air temp. °C DB											
			16		18		20		21		22		24	
	°C DB	°C WB	TC	PI	TC	PI	TC	PI	TC	PI	TC	PI	TC	PI
100	-24.8	-25	20.0	10.27	20.0	10.34	19.9	10.06	19.9	10.53	19.9	10.61	19.4	10.65
	-21.8	-22	24.3	10.38	24.3	10.46	24.2	10.37	24.2	10.64	24.2	10.78	23.6	10.76
	-19.8	-20	25.7	10.46	25.7	10.53	25.5	10.58	25.5	10.72	25.5	10.82	24.9	10.84
	-18.8	-19	26.1	10.49	25.9	10.57	25.9	10.64	25.9	10.76	25.9	10.84	25.3	10.63
	-16.7	-17	26.9	10.57	26.9	10.65	26.9	10.78	26.7	10.84	26.7	10.40	26.0	10.19
	-13.7	-15	28.3	10.69	28.3	10.76	28.2	10.84	28.2	10.18	28.2	9.77	27.5	9.56
	-11.8	-13	29.1	10.76	29.0	10.84	29.0	10.39	29.0	9.77	29.0	9.37	27.5	9.16
	-9.8	-11	30.0	10.84	30.0	10.32	29.8	9.91	29.8	9.33	29.5	8.95	27.5	8.74
	-9.5	-10	30.2	10.75	30.2	10.25	30.0	9.84	30.0	9.26	29.5	8.88	27.5	8.67
	-8.5	-9.1	30.8	10.48	30.8	9.99	30.6	9.60	30.5	9.05	29.5	8.67	27.5	8.46
	-7.0	-7.6	32.2	10.07	32.0	9.61	31.5	9.25	30.5	8.72	29.5	8.36	27.5	8.15
	-5.0	-5.6	33.6	9.52	33.3	9.10	31.5	8.77	30.5	8.28	29.5	7.94	27.5	7.73
	-3.0	-3.7	34.6	8.97	33.5	8.58	31.5	8.30	30.5	7.85	29.5	7.52	27.5	7.31
	0.0	-0.7	35.5	8.14	33.5	7.82	31.5	7.58	30.5	7.19	29.5	6.89	27.5	6.68
	3.0	2.2	35.5	7.32	33.5	7.05	31.5	6.87	30.5	6.54	29.5	6.26	27.5	6.05
	5.0	4.1	35.5	6.77	33.5	6.54	31.5	6.40	30.5	6.10	29.5	5.84	27.5	5.63
	7.0	6.0	35.5	6.22	33.5	6.02	31.5	5.92	30.5	5.66	29.5	5.42	27.5	5.21
	9.0	7.9	35.5	5.69	33.5	5.51	31.5	5.41	30.5	5.18	29.5	4.96	27.5	4.77
	11.0	9.8	35.5	5.19	33.5	5.03	31.5	4.94	30.5	4.73	29.5	4.53	27.5	4.35
	13.0	11.8	35.5	4.68	33.5	4.53	31.5	4.45	30.5	4.26	29.5	4.07	27.5	3.92
15.0	13.7	35.5	4.14	33.5	4.01	31.5	3.94	30.5	3.77	29.5	3.60	27.5	3.47	
90	-24.8	-25	19.9	9.49	19.9	9.69	19.8	9.83	19.8	9.89	19.8	10.02	19.3	10.22
	-21.8	-22	24.2	9.69	24.2	9.89	24.1	10.02	24.1	10.09	24.1	10.22	23.5	9.70
	-19.8	-20	25.6	9.82	25.6	10.02	25.4	10.15	25.4	10.22	25.4	9.86	24.8	9.36
	-18.8	-19	26.1	9.89	25.9	10.08	25.8	10.22	25.8	10.03	25.8	9.68	25.1	9.19
	-16.7	-17	26.9	10.02	26.9	10.22	26.8	9.82	26.8	9.64	26.8	9.30	25.1	8.82
	-13.7	-15	28.3	10.22	28.3	9.62	28.1	9.26	27.9	9.07	27.0	8.76	25.1	8.31
	-11.8	-13	29.1	9.80	29.0	9.25	28.8	8.90	27.9	8.72	27.0	8.42	25.1	7.98
	-9.8	-11	30.0	9.37	30.0	8.85	28.8	8.53	27.9	8.34	27.0	8.06	25.1	7.63
	-9.5	-10	30.2	9.30	30.2	8.79	28.8	8.47	27.9	8.28	27.0	8.00	25.1	7.58
	-8.5	-9.1	30.8	9.08	30.5	8.59	28.8	8.28	27.9	8.09	27.0	7.82	25.1	7.41
	-7.0	-7.6	32.2	8.75	30.6	8.29	28.8	8.00	27.9	7.81	27.0	7.55	25.1	7.15
	-5.0	-5.6	32.5	8.31	30.6	7.89	28.8	7.62	27.9	7.44	27.0	7.19	25.1	6.81
	-3.0	-3.7	32.5	7.88	30.6	7.50	28.8	7.24	27.9	7.06	27.0	6.83	25.1	6.46
	0.0	-0.7	32.5	7.22	30.6	6.90	28.8	6.68	27.9	6.50	27.0	6.29	25.1	5.94
	3.0	2.2	32.5	6.56	30.6	6.30	28.8	6.11	27.9	5.93	27.0	5.75	25.1	5.43
	5.0	4.1	32.5	6.12	30.6	5.91	28.8	5.74	27.9	5.55	27.0	5.39	25.1	5.08
	7.0	6.0	32.5	5.68	30.6	5.51	28.8	5.36	27.9	5.18	27.0	5.02	25.1	4.74
	9.0	7.9	32.5	5.29	30.6	5.12	28.8	4.98	27.9	4.81	27.0	4.67	25.1	4.41
	11.0	9.8	32.5	4.89	30.6	4.74	28.8	4.61	27.9	4.45	27.0	4.32	25.1	4.07
	13.0	11.8	32.5	4.49	30.6	4.35	28.8	4.23	27.9	4.09	27.0	3.97	25.1	3.74
15.0	13.7	32.5	4.09	30.6	3.96	28.8	3.85	27.9	3.72	27.0	3.61	25.1	3.41	
80	-24.8	-25	19.9	8.34	19.9	8.53	19.7	8.67	19.7	8.74	19.7	9.06	19.2	8.61
	-21.8	-22	24.0	8.53	24.0	8.73	24.0	8.87	24.0	9.06	24.0	8.61	22.4	8.18
	-19.8	-20	25.3	8.66	25.3	8.86	25.3	9.06	25.0	8.74	24.1	8.30	22.4	7.89
	-18.8	-19	25.7	8.73	25.7	9.06	25.7	8.89	25.0	8.57	24.1	8.15	22.4	7.74
	-16.7	-17	25.8	9.06	25.8	8.71	25.8	8.54	25.0	8.23	24.1	7.83	22.4	7.44
	-13.7	-15	27.0	8.53	26.4	8.20	25.8	8.04	25.0	7.74	24.1	7.38	22.4	7.01
	-11.8	-13	27.8	8.19	27.0	7.88	25.8	7.72	25.0	7.43	24.1	7.09	22.4	6.74
	-9.8	-11	28.5	7.83	27.3	7.54	25.8	7.38	25.0	7.11	24.1	6.78	22.4	6.45
	-9.5	-10	28.7	7.78	27.4	7.49	25.8	7.33	25.0	7.06	24.1	6.74	22.4	6.41
	-8.5	-9.1	28.9	7.60	27.5	7.32	25.8	7.16	25.0	6.90	24.1	6.58	22.4	6.26
	-7.0	-7.6	29.1	7.33	27.5	7.07	25.8	6.91	25.0	6.65	24.1	6.36	22.4	6.05
	-5.0	-5.6	29.1	6.98	27.5	6.73	25.8	6.58	25.0	6.33	24.1	6.05	22.4	5.76
	-3.0	-3.7	29.1	6.62	27.5	6.39	25.8	6.24	25.0	6.00	24.1	5.75	22.4	5.47
	0.0	-0.7	29.1	6.09	27.5	5.88	25.8	5.74	25.0	5.51	24.1	5.29	22.4	5.04
	3.0	2.2	29.1	5.55	27.5	5.38	25.8	5.23	25.0	5.02	24.1	4.84	22.4	4.61
	5.0	4.1	29.1	5.20	27.5	5.04	25.8	4.90	25.0	4.70	24.1	4.53	22.4	4.32
	7.0	6.0	29.1	4.84	27.5	4.70	25.8	4.56	25.0	4.37	24.1	4.23	22.4	4.04
	9.0	7.9	29.1	4.55	27.5	4.41	25.8	4.28	25.0	4.11	24.1	3.97	22.4	3.79
	11.0	9.8	29.1	4.22	27.5	4.10	25.8	3.98	25.0	3.81	24.1	3.69	22.4	3.52
	13.0	11.8	29.1	3.94	27.5	3.82	25.8	3.71	25.0	3.56	24.1	3.44	22.4	3.28
15.0	13.7	29.1	3.71	27.5	3.60	25.8	3.49	25.0	3.35	24.1	3.24	22.4	3.09	



# 7. Capacity Tables

Heating Capacity (10HP)

Combination (%)	Outdoor air temp.		Indoor air temp. °C DB													
			16		18		20		21		22		24			
	°C DB	°C WB	TC	PI	TC	PI	TC	PI	TC	PI	TC	PI	TC	PI		
70	-24.8	-25	19.9	8.46	19.9	8.52	19.7	8.65	19.7	8.85	19.7	8.85	19.7	8.37	19.2	7.92
	-21.8	-22	22.1	8.65	22.1	8.72	21.9	8.85	21.2	8.37	20.6	7.92	19.2	7.49		
	-19.8	-20	23.6	8.79	23.3	8.85	21.9	8.51	21.2	8.05	20.6	7.62	19.2	7.21		
	-18.8	-19	24.3	8.85	23.3	8.67	21.9	8.34	21.2	7.89	20.6	7.47	19.2	7.07		
	-16.7	-17	24.7	8.47	23.3	8.29	21.9	7.98	21.2	7.55	20.6	7.16	19.2	6.77		
	-13.7	-15	24.7	7.93	23.3	7.76	21.9	7.46	21.2	7.06	20.6	6.71	19.2	6.34		
	-11.8	-13	24.7	7.59	23.3	7.42	21.9	7.14	21.2	6.76	20.6	6.43	19.2	6.07		
	-9.8	-11	24.7	7.23	23.3	7.06	21.9	6.79	21.2	6.44	20.6	6.13	19.2	5.79		
	-9.5	-10	24.7	7.18	23.3	7.00	21.9	6.74	21.2	6.39	20.6	6.08	19.2	5.75		
	-8.5	-9.1	24.7	7.00	23.3	6.82	21.9	6.57	21.2	6.23	20.6	5.93	19.2	5.61		
	-7.0	-7.6	24.7	6.73	23.3	6.56	21.9	6.31	21.2	5.99	20.6	5.71	19.2	5.39		
	-5.0	-5.6	24.7	6.37	23.3	6.20	21.9	5.97	21.2	5.66	20.6	5.41	19.2	5.11		
	-3.0	-3.7	24.7	6.01	23.3	5.84	21.9	5.63	21.2	5.34	20.6	5.11	19.2	4.82		
	0.0	-0.7	24.7	5.47	23.3	5.30	21.9	5.11	21.2	4.86	20.6	4.67	19.2	4.40		
	3.0	2.2	24.7	4.93	23.3	4.76	21.9	4.60	21.2	4.38	20.6	4.22	19.2	3.97		
	5.0	4.1	24.7	4.58	23.3	4.40	21.9	4.25	21.2	4.06	20.6	3.92	19.2	3.69		
	7.0	6.0	24.7	4.22	23.3	4.05	21.9	3.91	21.2	3.73	20.6	3.62	19.2	3.40		
	9.0	7.9	24.7	3.81	23.3	3.65	21.9	3.53	21.2	3.37	20.6	3.27	19.2	3.07		
	11.0	9.8	24.7	3.54	23.3	3.40	21.9	3.29	21.2	3.14	20.6	3.04	19.2	2.86		
	13.0	11.8	24.7	3.32	23.3	3.18	21.9	3.08	21.2	2.94	20.6	2.85	19.2	2.68		
15.0	13.7	24.7	3.13	23.3	3.00	21.9	2.90	21.2	2.77	20.6	2.69	19.2	2.53			
60	-24.8	-25	18.9	8.33	18.9	8.46	18.8	8.65	18.2	8.15	17.6	7.69	16.4	7.25		
	-21.8	-22	20.3	8.52	20.1	8.65	18.8	8.15	18.2	7.69	17.6	7.25	16.4	6.84		
	-19.8	-20	21.2	8.65	20.1	8.30	18.8	7.82	18.2	7.38	17.6	6.96	16.4	6.56		
	-18.8	-19	21.2	8.47	20.1	8.12	18.8	7.65	18.2	7.22	17.6	6.82	16.4	6.42		
	-16.7	-17	21.2	8.09	20.1	7.74	18.8	7.30	18.2	6.89	17.6	6.51	16.4	6.13		
	-13.7	-15	21.2	7.54	20.1	7.21	18.8	6.80	18.2	6.43	17.6	6.08	16.4	5.72		
	-11.8	-13	21.2	7.19	20.1	6.87	18.8	6.48	18.2	6.13	17.6	5.80	16.4	5.46		
	-9.8	-11	21.2	6.82	20.1	6.51	18.8	6.15	18.2	5.82	17.6	5.51	16.4	5.18		
	-9.5	-10	21.2	6.77	20.1	6.45	18.8	6.10	18.2	5.77	17.6	5.47	16.4	5.14		
	-8.5	-9.1	21.2	6.58	20.1	6.28	18.8	5.93	18.2	5.62	17.6	5.32	16.4	5.00		
	-7.0	-7.6	21.2	6.31	20.1	6.01	18.8	5.68	18.2	5.39	17.6	5.11	16.4	4.80		
	-5.0	-5.6	21.2	5.94	20.1	5.65	18.8	5.35	18.2	5.08	17.6	4.82	16.4	4.52		
	-3.0	-3.7	21.2	5.57	20.1	5.29	18.8	5.01	18.2	4.76	17.6	4.53	16.4	4.24		
	0.0	-0.7	21.2	5.02	20.1	4.76	18.8	4.51	18.2	4.30	17.6	4.09	16.4	3.83		
	3.0	2.2	21.2	4.47	20.1	4.22	18.8	4.01	18.2	3.83	17.6	3.66	16.4	3.42		
	5.0	4.1	21.2	4.11	20.1	3.86	18.8	3.67	18.2	3.52	17.6	3.37	16.4	3.14		
	7.0	6.0	21.2	3.74	20.1	3.50	18.8	3.34	18.2	3.21	17.6	3.08	16.4	2.86		
	9.0	7.9	21.2	3.34	20.1	3.13	18.8	2.98	18.2	2.86	17.6	2.75	16.4	2.55		
	11.0	9.8	21.2	3.12	20.1	2.92	18.8	2.78	18.2	2.67	17.6	2.57	16.4	2.39		
	13.0	11.8	21.2	2.92	20.1	2.73	18.8	2.61	18.2	2.50	17.6	2.40	16.4	2.23		
15.0	13.7	21.2	2.76	20.1	2.58	18.8	2.46	18.2	2.37	17.6	2.27	16.4	2.11			
50	-24.8	-25	17.7	7.33	16.7	7.52	15.7	7.08	15.2	6.67	14.7	6.28	13.7	5.93		
	-21.8	-22	17.7	7.52	16.7	7.08	15.7	6.67	15.2	6.28	14.7	5.93	13.7	5.59		
	-19.8	-20	17.7	7.21	16.7	6.78	15.7	6.39	15.2	6.03	14.7	5.69	13.7	5.36		
	-18.8	-19	17.7	7.05	16.7	6.64	15.7	6.26	15.2	5.90	14.7	5.57	13.7	5.25		
	-16.7	-17	17.7	6.73	16.7	6.33	15.7	5.97	15.2	5.63	14.7	5.32	13.7	5.01		
	-13.7	-15	17.7	6.26	16.7	5.88	15.7	5.56	15.2	5.24	14.7	4.96	13.7	4.67		
	-11.8	-13	17.7	5.96	16.7	5.60	15.7	5.30	15.2	5.00	14.7	4.74	13.7	4.46		
	-9.8	-11	17.7	5.65	16.7	5.31	15.7	5.02	15.2	4.74	14.7	4.50	13.7	4.23		
	-9.5	-10	17.7	5.60	16.7	5.26	15.7	4.98	15.2	4.70	14.7	4.47	13.7	4.20		
	-8.5	-9.1	17.7	5.44	16.7	5.11	15.7	4.85	15.2	4.58	14.7	4.35	13.7	4.09		
	-7.0	-7.6	17.7	5.21	16.7	4.89	15.7	4.64	15.2	4.38	14.7	4.17	13.7	3.92		
	-5.0	-5.6	17.7	4.89	16.7	4.60	15.7	4.37	15.2	4.13	14.7	3.93	13.7	3.69		
	-3.0	-3.7	17.7	4.58	16.7	4.30	15.7	4.09	15.2	3.87	14.7	3.69	13.7	3.47		
	0.0	-0.7	17.7	4.11	16.7	3.86	15.7	3.68	15.2	3.48	14.7	3.34	13.7	3.13		
	3.0	2.2	17.7	3.64	16.7	3.42	15.7	3.27	15.2	3.10	14.7	2.98	13.7	2.79		
	5.0	4.1	17.7	3.33	16.7	3.12	15.7	2.99	15.2	2.84	14.7	2.74	13.7	2.56		
	7.0	6.0	17.7	3.02	16.7	2.82	15.7	2.72	15.2	2.58	14.7	2.50	13.7	2.34		
	9.0	7.9	17.7	2.72	16.7	2.55	15.7	2.46	15.2	2.33	14.7	2.26	13.7	2.11		
	11.0	9.8	17.7	2.55	16.7	2.39	15.7	2.30	15.2	2.18	14.7	2.12	13.7	1.97		
	13.0	11.8	17.7	2.39	16.7	2.24	15.7	2.16	15.2	2.05	14.7	1.99	13.7	1.85		
15.0	13.7	17.7	2.26	16.7	2.12	15.7	2.04	15.2	1.94	14.7	1.88	13.7	1.75			

**Note**

1. TC: Total Capacity(kW), PI : Power Input(kW, Comp. + Outdoor fan motor)
2. Capacity tables show the average value of conditions which may occur.
3. The heating capacity table is based on the values expressed as Max. in the specification of the outdoor unit. (When measuring the Max. heating capacity, the setting status of the indoor unit is the same as that for measuring the heating capacity of the indoor unit.)

# 7. Capacity Tables

## ◆ ARUM120LTE5

Heating Capacity (12HP)

Combination (%)	Outdoor air temp.		Indoor air temp. °C DB											
			16		18		20		21		22		24	
	°C DB	°C WB	TC	PI	TC	PI	TC	PI	TC	PI	TC	PI	TC	PI
130	-24.8	-25	23.9	11.43	23.9	11.64	23.8	11.83	23.8	12.11	23.8	12.39	23.7	12.82
	-21.8	-22	28.4	11.86	28.4	12.07	28.2	12.26	28.2	12.54	28.2	12.82	28.1	13.24
	-19.8	-20	29.6	12.14	29.6	12.36	29.4	12.54	29.4	12.83	29.4	13.10	29.3	13.53
	-18.8	-19	30.3	12.29	30.3	12.50	30.1	12.69	30.1	12.97	30.1	13.24	30.0	13.67
	-16.7	-17	31.8	12.59	31.8	12.80	31.6	12.99	31.6	13.27	31.6	13.54	31.4	13.97
	-13.7	-15	33.9	13.02	33.9	13.23	33.7	13.42	33.7	13.70	33.7	13.97	33.5	13.32
	-11.8	-13	35.0	13.29	35.0	13.50	34.8	13.69	34.8	13.97	34.8	13.53	34.8	12.91
	-9.8	-11	36.2	13.57	36.2	13.79	35.9	13.97	35.9	13.49	35.9	13.06	35.9	12.48
	-9.5	-10	36.4	13.62	36.4	13.83	36.2	13.90	36.2	13.41	36.1	12.99	36.1	12.41
	-8.5	-9.1	37.3	13.76	37.3	13.97	37.1	13.64	37.1	13.17	36.7	12.75	36.7	12.19
	-7.0	-7.6	38.7	13.97	38.7	13.58	38.4	13.26	38.4	12.80	38.4	12.40	38.2	11.87
	-5.0	-5.6	40.5	13.45	40.5	13.07	40.2	12.74	40.2	12.31	40.2	11.93	39.5	11.43
	-3.0	-3.7	42.3	12.92	42.3	12.55	42.0	12.23	42.0	11.82	42.0	11.46	40.9	11.00
	0.0	-0.7	44.9	12.13	44.9	11.77	44.7	11.46	44.7	11.09	44.7	10.75	42.7	10.35
	3.0	2.2	47.6	11.34	47.6	10.99	47.3	10.69	47.3	10.36	45.8	10.04	42.7	9.70
	5.0	4.1	48.9	10.81	48.9	10.47	48.7	10.18	47.5	9.87	45.8	9.57	42.7	9.26
	7.0	6.0	48.9	10.28	48.9	9.95	48.7	9.66	47.5	9.38	45.8	9.10	42.7	8.83
9.0	7.9	48.9	9.84	48.9	9.52	48.7	9.24	47.5	8.97	45.8	8.71	42.7	8.45	
11.0	9.8	48.9	9.47	48.9	9.16	48.7	8.90	47.5	8.64	45.8	8.38	42.7	8.13	
13.0	11.8	48.9	9.08	48.9	8.79	48.7	8.53	47.5	8.28	45.8	8.04	42.7	7.80	
15.0	13.7	48.9	8.67	48.9	8.39	48.7	8.14	47.5	7.91	45.8	7.67	42.7	7.44	
120	-24.8	-25	23.8	11.64	23.8	11.83	23.6	12.11	23.6	12.39	23.6	12.82	23.5	13.12
	-21.8	-22	28.2	12.07	28.2	12.26	28.0	12.54	28.0	12.82	28.0	13.24	27.9	13.54
	-19.8	-20	29.4	12.36	29.4	12.54	29.2	12.83	29.2	13.10	29.2	13.53	29.1	13.83
	-18.8	-19	30.1	12.50	30.1	12.69	29.9	12.97	29.9	13.24	29.9	13.67	29.8	13.97
	-16.7	-17	31.6	12.80	31.6	12.99	31.4	13.27	31.4	13.54	31.4	13.97	31.2	13.56
	-13.7	-15	33.6	13.23	33.6	13.42	33.4	13.70	33.4	13.97	33.4	13.34	33.3	12.96
	-11.8	-13	34.7	13.50	34.7	13.69	34.5	13.97	34.5	13.52	34.5	12.94	34.5	12.58
	-9.8	-11	35.9	13.79	35.9	13.97	35.7	13.47	35.7	13.05	35.7	12.52	35.7	12.18
	-9.5	-10	36.2	13.83	36.2	13.89	36.0	13.40	36.0	12.98	36.0	12.46	36.0	12.12
	-8.5	-9.1	37.1	13.97	37.1	13.62	36.8	13.14	36.8	12.74	36.8	12.25	36.8	11.92
	-7.0	-7.6	38.4	13.56	38.4	13.22	38.2	12.77	38.2	12.39	38.0	11.93	37.9	11.62
	-5.0	-5.6	40.2	13.01	40.2	12.68	39.9	12.27	39.9	11.91	39.9	11.51	39.3	11.22
	-3.0	-3.7	42.0	12.46	42.0	12.14	41.7	11.76	41.7	11.44	41.7	11.09	40.1	10.82
	0.0	-0.7	44.6	11.63	44.6	11.33	44.3	11.01	44.3	10.73	43.1	10.46	40.1	10.22
	3.0	2.2	47.3	10.80	47.3	10.52	46.1	10.26	44.5	10.02	43.1	9.83	40.1	9.63
	5.0	4.1	48.5	10.25	48.0	9.98	46.1	9.75	44.5	9.55	43.1	9.41	40.1	9.23
	7.0	6.0	48.5	9.70	48.0	9.44	46.1	9.25	44.5	9.07	43.1	8.99	40.1	8.83
9.0	7.9	48.5	9.26	48.0	9.01	46.1	8.84	44.5	8.67	43.1	8.59	40.1	8.43	
11.0	9.8	48.5	8.91	48.0	8.66	46.1	8.49	44.5	8.33	43.1	8.25	40.1	8.11	
13.0	11.8	48.5	8.53	48.0	8.29	46.1	8.13	44.5	7.98	43.1	7.90	40.1	7.76	
15.0	13.7	48.5	8.12	48.0	7.90	46.1	7.75	44.5	7.60	43.1	7.53	40.1	7.39	
110	-24.8	-25	23.6	11.83	23.6	12.11	23.5	12.39	23.5	12.82	23.5	13.12	23.4	13.26
	-21.8	-22	28.1	12.26	28.1	12.54	27.9	12.82	27.9	13.24	27.9	13.54	27.8	13.69
	-19.8	-20	29.2	12.54	29.2	12.83	29.1	13.10	29.1	13.53	29.1	13.83	28.9	13.97
	-18.8	-19	29.9	12.69	29.9	12.97	29.7	13.24	29.7	13.67	29.7	13.97	29.6	13.76
	-16.7	-17	31.4	12.99	31.4	13.27	31.2	13.54	31.2	13.97	31.2	13.53	31.0	13.31
	-13.7	-15	33.5	13.42	33.5	13.70	33.2	13.97	33.2	13.30	33.2	12.89	33.2	12.67
	-11.8	-13	34.6	13.69	34.6	13.97	34.3	13.49	34.3	12.87	34.3	12.49	34.3	12.27
	-9.8	-11	35.7	13.97	35.7	13.43	35.5	12.99	35.5	12.42	35.5	12.07	35.5	11.84
	-9.5	-10	36.0	13.88	36.0	13.34	35.8	12.91	35.8	12.35	35.8	12.01	35.8	11.77
	-8.5	-9.1	36.9	13.59	36.9	13.07	36.6	12.66	36.6	12.12	36.6	11.79	36.1	11.56
	-7.0	-7.6	38.2	13.14	38.2	12.66	38.0	12.28	38.0	11.78	38.0	11.48	36.1	11.24
	-5.0	-5.6	40.0	12.54	40.0	12.11	39.7	11.77	39.7	11.33	38.6	11.05	36.1	10.81
	-3.0	-3.7	41.7	11.95	41.7	11.57	41.3	11.26	40.0	10.88	38.6	10.63	36.1	10.39
	0.0	-0.7	44.4	11.05	44.0	10.75	41.3	10.50	40.0	10.20	38.6	10.00	36.1	9.75
	3.0	2.2	46.6	10.16	44.0	9.92	41.3	9.74	40.0	9.53	38.6	9.36	36.1	9.11
	5.0	4.1	46.6	9.56	44.0	9.38	41.3	9.24	40.0	9.08	38.6	8.94	36.1	8.68
	7.0	6.0	46.6	8.96	44.0	8.83	41.3	8.73	40.0	8.62	38.6	8.51	36.1	8.25
9.0	7.9	46.6	8.53	44.0	8.40	41.3	8.31	40.0	8.21	38.6	8.10	36.1	7.85	
11.0	9.8	46.6	8.16	44.0	8.04	41.3	7.95	40.0	7.85	38.6	7.75	36.1	7.51	
13.0	11.8	46.6	7.77	44.0	7.66	41.3	7.57	40.0	7.48	38.6	7.38	36.1	7.16	
15.0	13.7	46.6	7.37	44.0	7.26	41.3	7.17	40.0	7.09	38.6	7.00	36.1	6.78	

# 7. Capacity Tables

Heating Capacity (12HP)

Combination (%)	Outdoor air temp.		Indoor air temp. °C DB											
			16		18		20		21		22		24	
	°C DB	°C WB	TC	PI	TC	PI	TC	PI	TC	PI	TC	PI	TC	PI
100	-24.8	-25	23.5	13.34	23.5	13.42	23.4	12.93	23.4	13.63	23.4	13.72	23.3	13.76
	-21.8	-22	27.9	13.47	27.9	13.55	27.8	13.34	27.8	13.76	27.8	14.06	27.6	13.89
	-19.8	-20	29.1	13.55	29.1	13.63	28.9	13.61	28.9	13.84	28.9	14.00	28.8	13.97
	-18.8	-19	29.8	13.59	29.6	13.68	29.6	13.76	29.6	13.88	29.6	13.97	29.5	13.72
	-16.7	-17	31.1	13.68	31.1	13.77	31.1	14.06	30.9	13.97	30.9	13.45	30.7	13.20
	-13.7	-15	33.3	13.81	33.3	13.89	33.1	13.97	33.1	13.21	33.1	12.71	33.0	12.45
	-11.8	-13	34.4	13.89	34.2	13.97	34.2	13.45	34.2	12.72	34.2	12.23	33.0	11.97
	-9.8	-11	35.5	13.97	35.5	13.38	35.4	12.90	35.4	12.21	35.4	11.74	33.0	11.47
	-9.5	-10	35.8	13.88	35.8	13.29	35.6	12.81	35.6	12.13	35.4	11.66	33.0	11.40
	-8.5	-9.1	36.7	13.56	36.7	13.00	36.5	12.54	36.6	11.87	35.4	11.41	33.0	11.15
	-7.0	-7.6	38.6	13.09	38.5	12.55	37.8	12.12	36.6	11.49	35.4	11.04	33.0	10.77
	-5.0	-5.6	40.3	12.46	39.9	11.96	37.8	11.57	36.6	10.98	35.4	10.54	33.0	10.27
	-3.0	-3.7	41.5	11.83	40.2	11.37	37.8	11.02	36.6	10.46	35.4	10.05	33.0	9.77
	0.0	-0.7	42.6	10.89	40.2	10.48	37.8	10.19	36.6	9.70	35.4	9.30	33.0	9.02
	3.0	2.2	42.6	9.94	40.2	9.59	37.8	9.36	36.6	8.93	35.4	8.56	33.0	8.27
	5.0	4.1	42.6	9.31	40.2	9.00	37.8	8.81	36.6	8.41	35.4	8.06	33.0	7.77
	7.0	6.0	42.6	8.68	40.2	8.41	37.8	8.26	36.6	7.90	35.4	7.56	33.0	7.27
9.0	7.9	42.6	8.17	40.2	7.91	37.8	7.77	36.6	7.44	35.4	7.12	33.0	6.84	
11.0	9.8	42.6	7.72	40.2	7.48	37.8	7.35	36.6	7.03	35.4	6.73	33.0	6.47	
13.0	11.8	42.6	7.25	40.2	7.02	37.8	6.90	36.6	6.60	35.4	6.32	33.0	6.07	
15.0	13.7	42.6	6.76	40.2	6.54	37.8	6.43	36.6	6.15	35.4	5.89	33.0	5.66	
90	-24.8	-25	23.4	11.74	23.4	12.17	23.3	12.47	23.3	12.61	23.3	12.90	23.2	13.33
	-21.8	-22	27.8	12.17	27.8	12.60	27.7	12.90	27.7	13.04	27.7	13.33	27.5	12.69
	-19.8	-20	29.0	12.46	29.0	12.88	28.8	13.18	28.8	13.33	28.8	12.89	28.7	12.27
	-18.8	-19	29.8	12.60	29.6	13.03	29.5	13.33	29.5	13.10	29.5	12.67	29.4	12.06
	-16.7	-17	31.1	12.90	31.1	13.33	30.9	12.85	30.9	12.62	30.9	12.21	30.1	11.62
	-13.7	-15	33.3	13.33	33.3	12.61	33.0	12.17	33.0	11.94	32.4	11.55	30.1	10.98
	-11.8	-13	34.4	12.83	34.2	12.16	34.1	11.74	33.5	11.51	32.4	11.13	30.1	10.58
	-9.8	-11	35.5	12.31	35.5	11.69	34.6	11.29	33.5	11.05	32.4	10.70	30.1	10.16
	-9.5	-10	35.8	12.23	35.8	11.61	34.6	11.22	33.5	10.98	32.4	10.63	30.1	10.10
	-8.5	-9.1	36.7	11.97	36.4	11.38	34.6	10.99	33.5	10.75	32.4	10.41	30.1	9.88
	-7.0	-7.6	38.6	11.58	36.7	11.02	34.6	10.65	33.5	10.41	32.4	10.08	30.1	9.57
	-5.0	-5.6	39.0	11.06	36.7	10.54	34.6	10.20	33.5	9.96	32.4	9.64	30.1	9.15
	-3.0	-3.7	39.0	10.54	36.7	10.07	34.6	9.75	33.5	9.50	32.4	9.20	30.1	8.72
	0.0	-0.7	39.0	9.76	36.7	9.35	34.6	9.07	33.5	8.82	32.4	8.55	30.1	8.09
	3.0	2.2	39.0	8.97	36.7	8.64	34.6	8.39	33.5	8.14	32.4	7.89	30.1	7.46
	5.0	4.1	39.0	8.45	36.7	8.16	34.6	7.93	33.5	7.68	32.4	7.45	30.1	7.03
	7.0	6.0	39.0	7.93	36.7	7.69	34.6	7.48	33.5	7.23	32.4	7.01	30.1	6.61
9.0	7.9	39.0	7.45	36.7	7.22	34.6	7.03	33.5	6.79	32.4	6.59	30.1	6.21	
11.0	9.8	39.0	6.97	36.7	6.76	34.6	6.57	33.5	6.35	32.4	6.16	30.1	5.81	
13.0	11.8	39.0	6.49	36.7	6.29	34.6	6.12	33.5	5.91	32.4	5.74	30.1	5.41	
15.0	13.7	39.0	6.01	36.7	5.82	34.6	5.67	33.5	5.47	32.4	5.31	30.1	5.01	
80	-24.8	-25	23.3	10.23	23.3	10.66	23.2	10.96	23.2	11.10	23.2	11.82	23.1	11.26
	-21.8	-22	27.5	10.66	27.5	11.09	27.5	11.39	27.5	11.82	27.5	11.26	26.9	10.73
	-19.8	-20	28.7	10.95	28.7	11.37	28.7	11.82	28.7	11.42	28.7	10.89	26.9	10.38
	-18.8	-19	29.4	11.09	29.4	11.82	29.4	11.61	29.4	11.22	28.9	10.70	26.9	10.20
	-16.7	-17	30.9	11.82	30.9	11.39	30.9	11.19	30.0	10.81	28.9	10.31	26.9	9.83
	-13.7	-15	32.3	11.18	31.7	10.78	30.9	10.58	30.0	10.21	28.9	9.75	26.9	9.30
	-11.8	-13	33.2	10.77	32.2	10.39	30.9	10.19	30.0	9.83	28.9	9.40	26.9	8.96
	-9.8	-11	34.1	10.34	32.7	9.98	30.9	9.78	30.0	9.44	28.9	9.03	26.9	8.61
	-9.5	-10	34.3	10.28	32.8	9.92	30.9	9.72	30.0	9.38	28.9	8.97	26.9	8.55
	-8.5	-9.1	34.7	10.07	33.0	9.72	30.9	9.52	30.0	9.18	28.9	8.78	26.9	8.38
	-7.0	-7.6	35.0	9.75	33.0	9.41	30.9	9.21	30.0	8.88	28.9	8.51	26.9	8.11
	-5.0	-5.6	35.0	9.32	33.0	9.01	30.9	8.81	30.0	8.48	28.9	8.13	26.9	7.76
	-3.0	-3.7	35.0	8.89	33.0	8.60	30.9	8.40	30.0	8.09	28.9	7.76	26.9	7.40
	0.0	-0.7	35.0	8.25	33.0	7.99	30.9	7.79	30.0	7.49	28.9	7.20	26.9	6.87
	3.0	2.2	35.0	7.61	33.0	7.37	30.9	7.18	30.0	6.89	28.9	6.64	26.9	6.34
	5.0	4.1	35.0	7.18	33.0	6.97	30.9	6.77	30.0	6.50	28.9	6.27	26.9	5.99
	7.0	6.0	35.0	6.76	33.0	6.56	30.9	6.37	30.0	6.10	28.9	5.90	26.9	5.63
9.0	7.9	35.0	6.34	33.0	6.16	30.9	5.98	30.0	5.73	28.9	5.54	26.9	5.29	
11.0	9.8	35.0	5.89	33.0	5.72	30.9	5.55	30.0	5.32	28.9	5.14	26.9	4.91	
13.0	11.8	35.0	5.50	33.0	5.34	30.9	5.18	30.0	4.96	28.9	4.80	26.9	4.58	
15.0	13.7	35.0	5.17	33.0	5.02	30.9	4.87	30.0	4.67	28.9	4.52	26.9	4.31	

# 7. Capacity Tables

Heating Capacity (12HP)

Combination (%)	Outdoor air temp.		Indoor air temp. °C DB											
			16		18		20		21		22		24	
	°C DB	°C WB	TC	PI	TC	PI	TC	PI	TC	PI	TC	PI	TC	PI
70	-24.8	-25	23.3	10.53	23.3	10.67	23.2	10.96	23.2	11.39	23.2	10.81	23.0	10.26
	-21.8	-22	26.5	10.96	26.5	11.10	26.3	11.39	25.4	10.42	24.7	10.26	23.0	9.74
	-19.8	-20	28.6	11.25	28.0	11.39	26.3	10.98	25.4	10.42	24.7	9.90	23.0	9.40
	-18.8	-19	29.4	11.39	28.0	11.17	26.3	10.77	25.4	10.22	24.7	9.72	23.0	9.22
	-16.7	-17	29.6	10.94	28.0	10.72	26.3	10.34	25.4	9.82	24.7	9.34	23.0	8.86
	-13.7	-15	29.6	10.30	28.0	10.08	26.3	9.72	25.4	9.23	24.7	8.80	23.0	8.34
	-11.8	-13	29.6	9.89	28.0	9.67	26.3	9.33	25.4	8.86	24.7	8.45	23.0	8.01
	-9.8	-11	29.6	9.47	28.0	9.25	26.3	8.92	25.4	8.47	24.7	8.09	23.0	7.66
	-9.5	-10	29.6	9.40	28.0	9.18	26.3	8.86	25.4	8.42	24.7	8.04	23.0	7.61
	-8.5	-9.1	29.6	9.19	28.0	8.97	26.3	8.65	25.4	8.22	24.7	7.86	23.0	7.44
	-7.0	-7.6	29.6	8.87	28.0	8.65	26.3	8.34	25.4	7.93	24.7	7.59	23.0	7.18
	-5.0	-5.6	29.6	8.44	28.0	8.22	26.3	7.93	25.4	7.54	24.7	7.22	23.0	6.83
	-3.0	-3.7	29.6	8.02	28.0	7.79	26.3	7.52	25.4	7.15	24.7	6.86	23.0	6.48
	0.0	-0.7	29.6	7.38	28.0	7.15	26.3	6.90	25.4	6.57	24.7	6.32	23.0	5.96
	3.0	2.2	29.6	6.74	28.0	6.50	26.3	6.28	25.4	5.99	24.7	5.78	23.0	5.44
	5.0	4.1	29.6	6.31	28.0	6.07	26.3	5.87	25.4	5.60	24.7	5.41	23.0	5.10
	7.0	6.0	29.6	5.88	28.0	5.65	26.3	5.46	25.4	5.21	24.7	5.05	23.0	4.75
9.0	7.9	29.6	5.31	28.0	5.10	26.3	4.93	25.4	4.70	24.7	4.56	23.0	4.29	
11.0	9.8	29.6	4.95	28.0	4.75	26.3	4.59	25.4	4.38	24.7	4.25	23.0	3.99	
13.0	11.8	29.6	4.63	28.0	4.44	26.3	4.29	25.4	4.10	24.7	3.97	23.0	3.74	
15.0	13.7	29.6	4.36	28.0	4.19	26.3	4.05	25.4	3.86	24.7	3.75	23.0	3.52	
60	-24.8	-25	22.7	10.24	22.7	10.53	22.6	10.96	21.8	10.37	21.1	9.81	19.7	9.29
	-21.8	-22	24.3	10.67	24.1	10.96	22.6	10.37	21.8	9.81	21.1	9.29	19.7	8.79
	-19.8	-20	25.4	10.96	24.1	10.54	22.6	9.97	21.8	9.44	21.1	8.94	19.7	8.46
	-18.8	-19	25.4	10.75	24.1	10.33	22.6	9.77	21.8	9.25	21.1	8.77	19.7	8.29
	-16.7	-17	25.4	10.30	24.1	9.88	22.6	9.36	21.8	8.87	21.1	8.41	19.7	7.94
	-13.7	-15	25.4	9.65	24.1	9.25	22.6	8.76	21.8	8.31	21.1	7.89	19.7	7.44
	-11.8	-13	25.4	9.25	24.1	8.85	22.6	8.38	21.8	7.96	21.1	7.56	19.7	7.13
	-9.8	-11	25.4	8.82	24.1	8.43	22.6	7.99	21.8	7.59	21.1	7.21	19.7	6.79
	-9.5	-10	25.4	8.75	24.1	8.37	22.6	7.93	21.8	7.53	21.1	7.16	19.7	6.74
	-8.5	-9.1	25.4	8.54	24.1	8.16	22.6	7.73	21.8	7.35	21.1	6.98	19.7	6.58
	-7.0	-7.6	25.4	8.22	24.1	7.84	22.6	7.43	21.8	7.07	21.1	6.72	19.7	6.33
	-5.0	-5.6	25.4	7.79	24.1	7.42	22.6	7.04	21.8	6.70	21.1	6.38	19.7	5.99
	-3.0	-3.7	25.4	7.36	24.1	7.00	22.6	6.64	21.8	6.33	21.1	6.03	19.7	5.66
	0.0	-0.7	25.4	6.72	24.1	6.36	22.6	6.05	21.8	5.77	21.1	5.51	19.7	5.16
	3.0	2.2	25.4	6.08	24.1	5.73	22.6	5.45	21.8	5.22	21.1	4.99	19.7	4.66
	5.0	4.1	25.4	5.65	24.1	5.31	22.6	5.06	21.8	4.85	21.1	4.64	19.7	4.33
	7.0	6.0	25.4	5.22	24.1	4.89	22.6	4.66	21.8	4.48	21.1	4.30	19.7	3.99
9.0	7.9	25.4	4.66	24.1	4.36	22.6	4.16	21.8	4.00	21.1	3.83	19.7	3.56	
11.0	9.8	25.4	4.35	24.1	4.07	22.6	3.88	21.8	3.73	21.1	3.58	19.7	3.33	
13.0	11.8	25.4	4.07	24.1	3.81	22.6	3.64	21.8	3.50	21.1	3.35	19.7	3.12	
15.0	13.7	25.4	3.85	24.1	3.61	22.6	3.44	21.8	3.30	21.1	3.17	19.7	2.95	
50	-24.8	-25	21.2	9.38	20.0	9.81	18.8	9.26	18.2	8.74	17.6	8.26	16.4	7.81
	-21.8	-22	21.2	9.81	20.0	9.26	18.8	8.74	18.2	8.26	17.6	7.81	16.4	7.38
	-19.8	-20	21.2	9.42	20.0	8.89	18.8	8.40	18.2	7.93	17.6	7.51	16.4	7.09
	-18.8	-19	21.2	9.23	20.0	8.70	18.8	8.23	18.2	7.77	17.6	7.36	16.4	6.95
	-16.7	-17	21.2	8.82	20.0	8.32	18.8	7.87	18.2	7.43	17.6	7.04	16.4	6.65
	-13.7	-15	21.2	8.24	20.0	7.76	18.8	7.35	18.2	6.95	17.6	6.59	16.4	6.22
	-11.8	-13	21.2	7.87	20.0	7.41	18.8	7.02	18.2	6.64	17.6	6.31	16.4	5.95
	-9.8	-11	21.2	7.48	20.0	7.04	18.8	6.68	18.2	6.32	17.6	6.01	16.4	5.66
	-9.5	-10	21.2	7.42	20.0	6.99	18.8	6.63	18.2	6.27	17.6	5.97	16.4	5.62
	-8.5	-9.1	21.2	7.22	20.0	6.80	18.8	6.46	18.2	6.11	17.6	5.82	16.4	5.48
	-7.0	-7.6	21.2	6.93	20.0	6.53	18.8	6.20	18.2	5.87	17.6	5.59	16.4	5.26
	-5.0	-5.6	21.2	6.54	20.0	6.16	18.8	5.86	18.2	5.54	17.6	5.29	16.4	4.98
	-3.0	-3.7	21.2	6.15	20.0	5.79	18.8	5.51	18.2	5.22	17.6	4.99	16.4	4.69
	0.0	-0.7	21.2	5.57	20.0	5.23	18.8	5.00	18.2	4.74	17.6	4.54	16.4	4.26
	3.0	2.2	21.2	4.99	20.0	4.68	18.8	4.48	18.2	4.25	17.6	4.09	16.4	3.83
	5.0	4.1	21.2	4.60	20.0	4.31	18.8	4.14	18.2	3.93	17.6	3.79	16.4	3.55
	7.0	6.0	21.2	4.21	20.0	3.94	18.8	3.80	18.2	3.61	17.6	3.49	16.4	3.26
9.0	7.9	21.2	3.80	20.0	3.56	18.8	3.43	18.2	3.26	17.6	3.16	16.4	2.94	
11.0	9.8	21.2	3.56	20.0	3.33	18.8	3.21	18.2	3.05	17.6	2.95	16.4	2.75	
13.0	11.8	21.2	3.34	20.0	3.13	18.8	3.01	18.2	2.86	17.6	2.77	16.4	2.59	
15.0	13.7	21.2	3.16	20.0	2.96	18.8	2.85	18.2	2.71	17.6	2.62	16.4	2.45	

**Note**

1. TC: Total Capacity(kW), PI : Power Input(kW, Comp. + Outdoor fan motor)
2. Capacity tables show the average value of conditions which may occur.
3. The heating capacity table is based on the values expressed as Max. in the specification of the outdoor unit. (When measuring the Max. heating capacity, the setting status of the indoor unit is the same as that for measuring the heating capacity of the indoor unit.)

# 7. Capacity Tables

## ◆ ARUM140LTE5

Heating Capacity (14HP)

Combination (%)	Outdoor air temp.		Indoor air temp. °C DB											
			16		18		20		21		22		24	
	°C DB	°C WB	TC	PI	TC	PI	TC	PI	TC	PI	TC	PI	TC	PI
130	-24.8	-25	27.3	13.07	27.3	13.20	27.2	13.32	27.2	13.50	27.2	13.67	26.6	13.94
	-21.8	-22	33.3	13.34	33.3	13.47	33.0	13.59	33.0	13.77	33.0	13.94	32.4	14.21
	-19.8	-20	35.1	13.52	35.1	13.65	34.9	13.77	34.9	13.95	34.9	14.12	34.2	14.39
	-18.8	-19	35.9	13.61	35.9	13.74	35.7	13.86	35.7	14.04	35.7	14.21	35.0	14.48
	-16.7	-17	37.7	13.80	37.7	13.93	37.4	14.05	37.4	14.23	37.4	14.40	36.7	14.67
	-13.7	-15	40.1	14.07	40.1	14.20	39.9	14.32	39.9	14.50	39.9	14.67	39.1	14.13
	-11.8	-13	41.4	14.24	41.4	14.37	41.2	14.49	41.2	14.67	41.2	14.31	40.6	13.79
	-9.8	-11	42.8	14.42	42.8	14.55	42.5	14.67	42.5	14.29	42.5	13.93	42.2	13.43
	-9.5	-10	43.1	14.45	43.1	14.58	42.8	14.61	42.8	14.23	42.8	13.87	42.5	13.37
	-8.5	-9.1	43.9	14.54	43.9	14.67	43.6	14.42	43.6	14.03	43.4	13.68	43.3	13.19
	-7.0	-7.6	45.1	14.67	45.1	14.39	44.8	14.12	44.8	13.74	44.8	13.39	44.5	12.92
	-5.0	-5.6	46.8	14.30	46.8	14.00	46.5	13.73	46.5	13.36	46.5	13.01	46.1	12.56
	-3.0	-3.7	48.4	13.94	48.4	13.62	48.1	13.34	48.1	12.97	48.1	12.63	47.7	12.20
	0.0	-0.7	50.9	13.39	50.9	13.05	50.6	12.75	50.6	12.39	50.6	12.05	49.8	11.66
	3.0	2.2	53.4	12.84	53.4	12.48	53.0	12.16	53.0	11.81	53.0	11.48	49.8	11.11
	5.0	4.1	55.0	12.47	55.0	12.09	54.7	11.77	54.7	11.43	53.5	11.10	49.8	10.75
	7.0	6.0	56.7	12.10	56.7	11.71	56.3	11.37	55.4	11.04	53.5	10.71	49.8	10.39
	9.0	7.9	57.0	11.80	57.0	11.42	56.8	11.09	55.4	10.77	53.5	10.45	49.8	10.13
	11.0	9.8	57.0	11.60	57.0	11.23	56.8	10.90	55.4	10.59	53.5	10.27	49.8	9.96
	13.0	11.8	57.0	11.39	57.0	11.02	56.8	10.70	55.4	10.39	53.5	10.08	49.8	9.78
15.0	13.7	57.0	11.16	57.0	10.80	56.8	10.49	55.4	10.18	53.5	9.88	49.8	9.58	
120	-24.8	-25	27.1	13.20	27.1	13.32	27.0	13.50	27.0	13.67	27.0	13.94	26.4	14.13
	-21.8	-22	33.0	13.47	33.0	13.59	32.8	13.77	32.8	13.94	32.8	14.21	32.2	14.40
	-19.8	-20	34.8	13.65	34.8	13.77	34.6	13.95	34.6	14.12	34.6	14.39	33.9	14.58
	-18.8	-19	35.7	13.74	35.7	13.86	35.4	14.04	35.4	14.21	35.4	14.48	34.7	14.67
	-16.7	-17	37.4	13.93	37.4	14.05	37.2	14.23	37.2	14.40	37.2	14.67	36.4	14.32
	-13.7	-15	39.8	14.20	39.8	14.32	39.6	14.50	39.6	14.67	39.6	14.15	38.8	13.82
	-11.8	-13	41.1	14.37	41.1	14.49	40.9	14.67	40.9	14.30	40.9	13.82	40.3	13.51
	-9.8	-11	42.5	14.55	42.5	14.67	42.2	14.27	42.2	13.92	42.2	13.48	41.9	13.18
	-9.5	-10	42.8	14.58	42.8	14.61	42.5	14.21	42.5	13.86	42.5	13.43	42.2	13.13
	-8.5	-9.1	43.6	14.67	43.6	14.40	43.3	14.01	43.3	13.67	43.3	13.25	43.0	12.96
	-7.0	-7.6	44.8	14.36	44.8	14.08	44.5	13.71	44.5	13.38	44.5	13.00	44.2	12.71
	-5.0	-5.6	46.4	13.94	46.4	13.65	46.1	13.30	46.1	12.99	46.1	12.65	45.8	12.38
	-3.0	-3.7	48.1	13.52	48.1	13.23	47.8	12.90	47.8	12.61	47.8	12.30	46.8	12.05
	0.0	-0.7	50.5	12.89	50.5	12.59	50.2	12.30	50.2	12.03	50.2	11.79	46.8	11.55
	3.0	2.2	53.0	12.25	53.0	11.95	52.6	11.69	52.0	11.45	50.3	11.27	46.8	11.05
	5.0	4.1	54.6	11.83	54.6	11.53	53.7	11.29	52.0	11.06	50.3	10.92	46.8	10.72
	7.0	6.0	56.3	11.41	55.9	11.11	53.7	10.89	52.0	10.68	50.3	10.58	46.8	10.39
	9.0	7.9	56.5	11.10	55.9	10.80	53.7	10.59	52.0	10.39	50.3	10.29	46.8	10.10
	11.0	9.8	56.5	10.89	55.9	10.59	53.7	10.38	52.0	10.18	50.3	10.09	46.8	9.91
	13.0	11.8	56.5	10.66	55.9	10.37	53.7	10.16	52.0	9.97	50.3	9.87	46.8	9.70
15.0	13.7	56.5	10.41	55.9	10.12	53.7	9.93	52.0	9.74	50.3	9.64	46.8	9.47	
110	-24.8	-25	27.0	13.32	27.0	13.50	26.8	13.67	26.8	13.94	26.8	14.13	26.3	14.22
	-21.8	-22	32.8	13.59	32.8	13.77	32.6	13.94	32.6	14.21	32.6	14.40	32.0	14.49
	-19.8	-20	34.7	13.77	34.7	13.95	34.4	14.12	34.4	14.39	34.4	14.58	33.8	14.67
	-18.8	-19	35.5	13.86	35.5	14.04	35.2	14.21	35.2	14.48	35.2	14.67	34.6	14.49
	-16.7	-17	37.2	14.05	37.2	14.23	37.0	14.40	37.0	14.67	37.0	14.29	36.2	14.10
	-13.7	-15	39.6	14.32	39.6	14.50	39.4	14.67	39.4	14.10	39.4	13.75	39.4	13.54
	-11.8	-13	40.9	14.49	40.9	14.67	40.7	14.27	40.7	13.74	40.7	13.41	40.7	13.19
	-9.8	-11	42.3	14.67	42.3	14.22	42.0	13.84	42.0	13.35	42.0	13.05	42.0	12.82
	-9.5	-10	42.5	14.60	42.5	14.15	42.3	13.78	42.3	13.30	42.3	12.99	42.1	12.76
	-8.5	-9.1	43.3	14.35	43.3	13.92	43.1	13.57	43.1	13.11	43.1	12.81	42.1	12.58
	-7.0	-7.6	44.6	13.98	44.6	13.58	44.3	13.25	44.3	12.82	44.3	12.54	42.1	12.30
	-5.0	-5.6	46.2	13.49	46.2	13.12	45.9	12.82	45.9	12.44	45.1	12.18	42.1	11.93
	-3.0	-3.7	47.8	13.00	47.8	12.67	47.5	12.40	46.6	12.06	45.1	11.82	42.1	11.56
	0.0	-0.7	50.3	12.27	50.3	11.98	48.2	11.76	46.6	11.48	45.1	11.28	42.1	11.01
	3.0	2.2	52.7	11.53	51.4	11.30	48.2	11.12	46.6	10.91	45.1	10.74	42.1	10.45
	5.0	4.1	54.3	11.04	51.4	10.85	48.2	10.70	46.6	10.53	45.1	10.38	42.1	10.08
	7.0	6.0	54.4	10.55	51.4	10.39	48.2	10.27	46.6	10.15	45.1	10.02	42.1	9.71
	9.0	7.9	54.4	10.21	51.4	10.06	48.2	9.95	46.6	9.83	45.1	9.70	42.1	9.40
	11.0	9.8	54.4	9.97	51.4	9.82	48.2	9.71	46.6	9.59	45.1	9.47	42.1	9.17
	13.0	11.8	54.4	9.70	51.4	9.56	48.2	9.45	46.6	9.33	45.1	9.21	42.1	8.93
15.0	13.7	54.4	9.42	51.4	9.28	48.2	9.17	46.6	9.06	45.1	8.95	42.1	8.67	

# 7. Capacity Tables

Heating Capacity (14HP)

Combination (%)	Outdoor air temp.		Indoor air temp. °C DB											
			16		18		20		21		22		24	
	°C DB	°C WB	TC	PI	TC	PI	TC	PI	TC	PI	TC	PI	TC	PI
100	-24.8	-25	26.9	14.67	26.9	14.67	26.7	13.87	26.7	14.67	26.7	14.67	26.2	14.67
	-21.8	-22	32.7	14.67	32.7	14.67	32.5	14.30	32.5	14.67	32.5	14.86	31.9	14.67
	-19.8	-20	34.5	14.67	34.5	14.67	34.3	14.58	34.3	14.67	34.3	14.73	33.6	14.67
	-18.8	-19	35.3	14.67	35.1	14.67	35.1	14.67	35.1	14.67	35.1	14.67	34.4	14.44
	-16.7	-17	36.8	14.67	36.8	14.67	36.8	14.86	36.6	14.67	36.6	14.20	35.9	13.96
	-13.7	-15	39.4	14.67	39.4	14.67	39.2	14.67	39.2	13.99	39.2	13.53	38.5	13.28
	-11.8	-13	40.7	14.67	40.5	14.67	40.5	14.22	40.5	13.56	40.5	13.10	38.5	12.85
	-9.8	-11	42.1	14.67	42.1	14.16	41.8	13.74	41.8	13.11	41.3	12.66	38.5	12.39
	-9.5	-10	42.3	14.59	42.3	14.09	42.1	13.67	42.1	13.04	41.3	12.59	38.5	12.32
	-8.5	-9.1	43.1	14.33	43.1	13.83	42.9	13.43	42.7	12.81	41.3	12.37	38.5	12.09
	-7.0	-7.6	45.1	13.93	44.9	13.45	44.1	13.07	42.7	12.47	41.3	12.03	38.5	11.75
	-5.0	-5.6	47.0	13.40	46.6	12.94	44.1	12.59	42.7	12.02	41.3	11.58	38.5	11.29
	-3.0	-3.7	48.4	12.87	46.9	12.43	44.1	12.11	42.7	11.57	41.3	11.14	38.5	10.84
	0.0	-0.7	49.7	12.07	46.9	11.67	44.1	11.39	42.7	10.89	41.3	10.46	38.5	10.15
	3.0	2.2	49.7	11.27	46.9	10.91	44.1	10.68	42.7	10.21	41.3	9.79	38.5	9.47
	5.0	4.1	49.7	10.74	46.9	10.40	44.1	10.20	42.7	9.75	41.3	9.34	38.5	9.01
	7.0	6.0	49.7	10.21	46.9	9.89	44.1	9.72	42.7	9.30	41.3	8.90	38.5	8.56
	9.0	7.9	49.7	9.82	46.9	9.51	44.1	9.35	42.7	8.94	41.3	8.55	38.5	8.23
	11.0	9.8	49.7	9.51	46.9	9.21	44.1	9.05	42.7	8.66	41.3	8.28	38.5	7.97
	13.0	11.8	49.7	9.18	46.9	8.89	44.1	8.73	42.7	8.36	41.3	7.99	38.5	7.69
15.0	13.7	49.7	8.83	46.9	8.55	44.1	8.40	42.7	8.04	41.3	7.69	38.5	7.39	
90	-24.8	-25	26.8	13.09	26.8	13.36	26.6	13.55	26.6	13.64	26.6	13.82	26.1	14.09
	-21.8	-22	32.6	13.36	32.6	13.63	32.4	13.82	32.4	13.91	32.4	14.09	31.7	13.49
	-19.8	-20	34.4	13.54	34.4	13.81	34.2	14.00	34.2	14.09	34.2	13.68	33.5	13.10
	-18.8	-19	35.3	13.63	35.1	13.90	35.0	14.09	35.0	13.88	35.0	13.48	34.3	12.90
	-16.7	-17	36.8	13.82	36.8	14.09	36.6	13.66	36.6	13.44	36.6	13.06	35.1	12.48
	-13.7	-15	39.4	14.09	39.4	13.45	39.1	13.04	39.1	12.82	37.8	12.45	35.1	11.89
	-11.8	-13	40.7	13.65	40.5	13.05	40.3	12.66	39.1	12.42	37.8	12.06	35.1	11.51
	-9.8	-11	42.1	13.19	42.1	12.62	40.4	12.25	39.1	12.01	37.8	11.66	35.1	11.11
	-9.5	-10	42.3	13.12	42.3	12.56	40.4	12.18	39.1	11.94	37.8	11.60	35.1	11.05
	-8.5	-9.1	43.1	12.90	42.8	12.34	40.4	11.98	39.1	11.73	37.8	11.39	35.1	10.86
	-7.0	-7.6	45.1	12.55	42.9	12.03	40.4	11.67	39.1	11.42	37.8	11.09	35.1	10.56
	-5.0	-5.6	45.6	12.09	42.9	11.60	40.4	11.26	39.1	11.00	37.8	10.68	35.1	10.16
	-3.0	-3.7	45.6	11.63	42.9	11.17	40.4	10.85	39.1	10.59	37.8	10.28	35.1	9.76
	0.0	-0.7	45.6	10.94	42.9	10.54	40.4	10.24	39.1	9.96	37.8	9.67	35.1	9.17
	3.0	2.2	45.6	10.25	42.9	9.90	40.4	9.62	39.1	9.34	37.8	9.06	35.1	8.57
	5.0	4.1	45.6	9.79	42.9	9.47	40.4	9.21	39.1	8.92	37.8	8.66	35.1	8.18
	7.0	6.0	45.6	9.33	42.9	9.05	40.4	8.80	39.1	8.50	37.8	8.25	35.1	7.78
	9.0	7.9	45.6	8.90	42.9	8.62	40.4	8.39	39.1	8.11	37.8	7.87	35.1	7.42
	11.0	9.8	45.6	8.46	42.9	8.20	40.4	7.98	39.1	7.71	37.8	7.48	35.1	7.05
	13.0	11.8	45.6	8.03	42.9	7.78	40.4	7.57	39.1	7.31	37.8	7.10	35.1	6.69
15.0	13.7	45.6	7.59	42.9	7.36	40.4	7.16	39.1	6.92	37.8	6.71	35.1	6.33	
80	-24.8	-25	26.7	11.49	26.7	11.76	26.5	11.95	26.5	12.04	26.5	12.49	26.0	11.97
	-21.8	-22	32.2	11.76	32.2	12.03	32.2	12.22	32.2	12.49	32.2	11.97	31.4	11.47
	-19.8	-20	34.0	11.94	34.0	12.21	34.0	12.49	34.0	12.12	33.7	11.62	31.4	11.13
	-18.8	-19	34.8	12.03	34.8	12.49	34.8	12.31	34.8	11.94	33.7	11.45	31.4	10.96
	-16.7	-17	36.1	12.49	36.1	12.11	36.1	11.92	35.0	11.55	33.7	11.08	31.4	10.61
	-13.7	-15	37.7	11.92	37.0	11.55	36.1	11.36	35.0	11.00	33.7	10.56	31.4	10.11
	-11.8	-13	38.7	11.55	37.5	11.20	36.1	11.00	35.0	10.65	33.7	10.22	31.4	9.79
	-9.8	-11	39.7	11.17	38.1	10.83	36.1	10.63	35.0	10.28	33.7	9.88	31.4	9.45
	-9.5	-10	40.0	11.11	38.3	10.77	36.1	10.57	35.0	10.22	33.7	9.82	31.4	9.40
	-8.5	-9.1	40.4	10.92	38.4	10.59	36.1	10.38	35.0	10.04	33.7	9.65	31.4	9.23
	-7.0	-7.6	40.8	10.63	38.4	10.31	36.1	10.10	35.0	9.76	33.7	9.39	31.4	8.98
	-5.0	-5.6	40.8	10.25	38.4	9.94	36.1	9.73	35.0	9.39	33.7	9.04	31.4	8.64
	-3.0	-3.7	40.8	9.87	38.4	9.57	36.1	9.36	35.0	9.02	33.7	8.69	31.4	8.31
	0.0	-0.7	40.8	9.29	38.4	9.01	36.1	8.80	35.0	8.47	33.7	8.16	31.4	7.81
	3.0	2.2	40.8	8.72	38.4	8.46	36.1	8.24	35.0	7.92	33.7	7.64	31.4	7.30
	5.0	4.1	40.8	8.33	38.4	8.09	36.1	7.86	35.0	7.55	33.7	7.29	31.4	6.97
	7.0	6.0	40.8	7.95	38.4	7.72	36.1	7.49	35.0	7.18	33.7	6.94	31.4	6.63
	9.0	7.9	40.8	7.46	38.4	7.25	36.1	7.03	35.0	6.74	33.7	6.52	31.4	6.22
	11.0	9.8	40.8	6.93	38.4	6.73	36.1	6.53	35.0	6.26	33.7	6.05	31.4	5.78
	13.0	11.8	40.8	6.47	38.4	6.28	36.1	6.09	35.0	5.84	33.7	5.65	31.4	5.39
15.0	13.7	40.8	6.09	38.4	5.91	36.1	5.74	35.0	5.50	33.7	5.32	31.4	5.08	

## 7. Capacity Tables

## Heating Capacity (14HP)

Combination (%)	Outdoor air temp.		Indoor air temp. °C DB											
			16		18		20		21		22		24	
	°C DB	°C WB	TC	PI	TC	PI	TC	PI	TC	PI	TC	PI	TC	PI
70	-24.8	-25	26.7	11.66	26.7	11.75	26.5	11.93	26.5	12.20	26.5	11.63	26.0	11.09
	-21.8	-22	30.9	11.93	30.9	12.02	30.7	12.20	29.7	11.63	28.8	11.09	26.9	10.57
	-19.8	-20	33.8	12.11	32.7	12.20	30.7	11.80	29.7	11.25	28.8	10.74	26.9	10.23
	-18.8	-19	34.6	12.20	32.7	11.99	30.7	11.60	29.7	11.06	28.8	10.56	26.9	10.05
	-16.7	-17	34.6	11.77	32.7	11.56	30.7	11.18	29.7	10.66	28.8	10.18	26.9	9.69
	-13.7	-15	34.6	11.16	32.7	10.94	30.7	10.58	29.7	10.08	28.8	9.65	26.9	9.17
	-11.8	-13	34.6	10.77	32.7	10.54	30.7	10.19	29.7	9.72	28.8	9.31	26.9	8.84
	-9.8	-11	34.6	10.36	32.7	10.13	30.7	9.79	29.7	9.34	28.8	8.95	26.9	8.50
	-9.5	-10	34.6	10.30	32.7	10.07	30.7	9.73	29.7	9.28	28.8	8.89	26.9	8.45
	-8.5	-9.1	34.6	10.09	32.7	9.86	30.7	9.53	29.7	9.09	28.8	8.72	26.9	8.27
	-7.0	-7.6	34.6	9.79	32.7	9.55	30.7	9.23	29.7	8.80	28.8	8.45	26.9	8.01
	-5.0	-5.6	34.6	9.38	32.7	9.13	30.7	8.83	29.7	8.42	28.8	8.09	26.9	7.67
	-3.0	-3.7	34.6	8.97	32.7	8.72	30.7	8.43	29.7	8.04	28.8	7.73	26.9	7.32
	0.0	-0.7	34.6	8.35	32.7	8.10	30.7	7.83	29.7	7.47	28.8	7.20	26.9	6.80
	3.0	2.2	34.6	7.74	32.7	7.47	30.7	7.22	29.7	6.89	28.8	6.66	26.9	6.28
	5.0	4.1	34.6	7.33	32.7	7.06	30.7	6.82	29.7	6.51	28.8	6.30	26.9	5.94
	7.0	6.0	34.6	6.92	32.7	6.64	30.7	6.42	29.7	6.13	28.8	5.95	26.9	5.59
	9.0	7.9	34.6	6.25	32.7	6.00	30.7	5.80	29.7	5.54	28.8	5.37	26.9	5.05
	11.0	9.8	34.6	5.82	32.7	5.59	30.7	5.40	29.7	5.15	28.8	5.00	26.9	4.70
	13.0	11.8	34.6	5.45	32.7	5.23	30.7	5.05	29.7	4.82	28.8	4.68	26.9	4.40
15.0	13.7	34.6	5.13	32.7	4.93	30.7	4.76	29.7	4.55	28.8	4.41	26.9	4.15	
60	-24.8	-25	26.5	11.48	26.5	11.66	26.3	11.93	25.5	11.32	24.6	10.75	23.0	10.21
	-21.8	-22	28.4	11.75	28.1	11.93	26.3	11.32	25.5	10.75	24.6	10.21	23.0	9.69
	-19.8	-20	29.7	11.93	28.1	11.50	26.3	10.92	25.5	10.37	24.6	9.86	23.0	9.35
	-18.8	-19	29.7	11.72	28.1	11.29	26.3	10.71	25.5	10.18	24.6	9.68	23.0	9.17
	-16.7	-17	29.7	11.26	28.1	10.84	26.3	10.29	25.5	9.78	24.6	9.30	23.0	8.81
	-13.7	-15	29.7	10.61	28.1	10.19	26.3	9.68	25.5	9.21	24.6	8.76	23.0	8.29
	-11.8	-13	29.7	10.20	28.1	9.79	26.3	9.30	25.5	8.85	24.6	8.42	23.0	7.96
	-9.8	-11	29.7	9.77	28.1	9.36	26.3	8.89	25.5	8.47	24.6	8.06	23.0	7.61
	-9.5	-10	29.7	9.71	28.1	9.29	26.3	8.83	25.5	8.41	24.6	8.01	23.0	7.56
	-8.5	-9.1	29.7	9.49	28.1	9.08	26.3	8.63	25.5	8.22	24.6	7.83	23.0	7.39
	-7.0	-7.6	29.7	9.17	28.1	8.76	26.3	8.32	25.5	7.93	24.6	7.56	23.0	7.13
	-5.0	-5.6	29.7	8.73	28.1	8.33	26.3	7.92	25.5	7.55	24.6	7.21	23.0	6.78
	-3.0	-3.7	29.7	8.30	28.1	7.90	26.3	7.51	25.5	7.17	24.6	6.85	23.0	6.43
	0.0	-0.7	29.7	7.65	28.1	7.25	26.3	6.90	25.5	6.60	24.6	6.31	23.0	5.91
	3.0	2.2	29.7	7.00	28.1	6.61	26.3	6.29	25.5	6.03	24.6	5.77	23.0	5.39
	5.0	4.1	29.7	6.57	28.1	6.18	26.3	5.89	25.5	5.65	24.6	5.41	23.0	5.05
	7.0	6.0	29.7	6.14	28.1	5.75	26.3	5.48	25.5	5.27	24.6	5.06	23.0	4.70
	9.0	7.9	29.7	5.48	28.1	5.13	26.3	4.89	25.5	4.70	24.6	4.51	23.0	4.19
	11.0	9.8	29.7	5.12	28.1	4.79	26.3	4.57	25.5	4.39	24.6	4.21	23.0	3.92
	13.0	11.8	29.7	4.79	28.1	4.49	26.3	4.28	25.5	4.11	24.6	3.95	23.0	3.67
15.0	13.7	29.7	4.53	28.1	4.24	26.3	4.04	25.5	3.89	24.6	3.73	23.0	3.47	
50	-24.8	-25	24.8	10.10	23.4	10.37	21.9	9.83	21.2	9.32	20.5	8.85	19.1	8.40
	-21.8	-22	24.8	10.37	23.4	9.83	21.9	9.32	21.2	8.85	20.5	8.40	19.1	7.97
	-19.8	-20	24.8	10.00	23.4	9.47	21.9	8.99	21.2	8.53	20.5	8.10	19.1	7.68
	-18.8	-19	24.8	9.81	23.4	9.29	21.9	8.82	21.2	8.37	20.5	7.95	19.1	7.54
	-16.7	-17	24.8	9.41	23.4	8.91	21.9	8.46	21.2	8.03	20.5	7.64	19.1	7.24
	-13.7	-15	24.8	8.85	23.4	8.37	21.9	7.96	21.2	7.55	20.5	7.19	19.1	6.81
	-11.8	-13	24.8	8.49	23.4	8.03	21.9	7.64	21.2	7.25	20.5	6.91	19.1	6.53
	-9.8	-11	24.8	8.11	23.4	7.67	21.9	7.30	21.2	6.93	20.5	6.61	19.1	6.25
	-9.5	-10	24.8	8.06	23.4	7.61	21.9	7.25	21.2	6.88	20.5	6.57	19.1	6.20
	-8.5	-9.1	24.8	7.87	23.4	7.43	21.9	7.08	21.2	6.72	20.5	6.42	19.1	6.06
	-7.0	-7.6	24.8	7.59	23.4	7.16	21.9	6.83	21.2	6.48	20.5	6.20	19.1	5.85
	-5.0	-5.6	24.8	7.21	23.4	6.80	21.9	6.49	21.2	6.16	20.5	5.90	19.1	5.56
	-3.0	-3.7	24.8	6.83	23.4	6.44	21.9	6.15	21.2	5.84	20.5	5.60	19.1	5.27
	0.0	-0.7	24.8	6.27	23.4	5.90	21.9	5.65	21.2	5.36	20.5	5.15	19.1	4.84
	3.0	2.2	24.8	5.71	23.4	5.36	21.9	5.14	21.2	4.88	20.5	4.71	19.1	4.41
	5.0	4.1	24.8	5.33	23.4	5.00	21.9	4.80	21.2	4.56	20.5	4.41	19.1	4.12
	7.0	6.0	24.8	4.95	23.4	4.64	21.9	4.47	21.2	4.24	20.5	4.11	19.1	3.84
	9.0	7.9	24.8	4.47	23.4	4.19	21.9	4.03	21.2	3.83	20.5	3.71	19.1	3.46
	11.0	9.8	24.8	4.19	23.4	3.92	21.9	3.77	21.2	3.59	20.5	3.47	19.1	3.24
	13.0	11.8	24.8	3.93	23.4	3.68	21.9	3.54	21.2	3.37	20.5	3.26	19.1	3.04
15.0	13.7	24.8	3.72	23.4	3.48	21.9	3.35	21.2	3.19	20.5	3.09	19.1	2.88	

## Note

1. TC: Total Capacity(kW), PI : Power Input(kW, Comp. + Outdoor fan motor)
2. Capacity tables show the average value of conditions which may occur.
3. The heating capacity table is based on the values expressed as Max. in the specification of the outdoor unit. (When measuring the Max. heating capacity, the setting status of the indoor unit is the same as that for measuring the heating capacity of the indoor unit.)

# 7. Capacity Tables

## ◆ ARUM160LTE5

Heating Capacity (16HP)

Combination (%)	Outdoor air temp.		Indoor air temp. °C DB											
			16		18		20		21		22		24	
	°C DB	°C WB	TC	PI	TC	PI	TC	PI	TC	PI	TC	PI	TC	PI
130	-24.8	-25	28.7	14.80	28.7	15.08	28.5	15.32	28.5	15.69	28.5	16.03	28.5	16.59
	-21.8	-22	35.2	15.36	35.2	15.63	35.0	15.87	35.0	16.24	35.0	16.59	35.0	17.14
	-19.8	-20	37.3	15.72	37.3	16.00	37.1	16.24	37.1	16.60	37.1	16.95	37.1	17.50
	-18.8	-19	38.3	15.91	38.3	16.18	38.1	16.42	38.1	16.79	38.1	17.14	38.1	17.69
	-16.7	-17	40.3	16.29	40.3	16.57	40.1	16.81	40.1	17.17	40.1	17.52	40.1	18.07
	-13.7	-15	43.2	16.84	43.2	17.12	42.9	17.36	42.9	17.72	42.9	18.07	42.9	17.46
	-11.8	-13	44.7	17.19	44.7	17.47	44.4	17.71	44.4	18.07	44.4	17.67	44.4	17.08
	-9.8	-11	46.3	17.56	46.3	17.83	46.0	18.07	46.0	17.65	46.0	17.24	46.0	16.67
	-9.5	-10	46.8	17.61	46.8	17.89	46.5	18.01	46.5	17.58	46.2	17.18	46.2	16.61
	-8.5	-9.1	48.7	17.80	48.7	18.07	48.4	17.80	48.4	17.37	47.0	16.96	47.0	16.40
	-7.0	-7.6	51.6	18.07	51.6	17.77	51.2	17.48	51.2	17.05	51.2	16.64	49.4	16.10
	-5.0	-5.6	55.4	17.70	55.4	17.36	55.0	17.05	55.0	16.63	55.0	16.22	51.3	15.69
	-3.0	-3.7	59.2	17.32	59.2	16.96	58.8	16.63	58.8	16.20	58.8	15.79	53.2	15.28
	0.0	-0.7	64.9	16.75	64.9	16.35	64.4	15.99	63.3	15.56	61.1	15.15	56.1	14.67
	3.0	2.2	65.1	16.18	65.1	15.74	64.9	15.35	63.3	14.93	61.1	14.51	56.9	14.06
	5.0	4.1	65.1	15.81	65.1	15.34	64.9	14.92	63.3	14.50	61.1	14.08	56.9	13.65
	7.0	6.0	65.1	15.43	65.1	14.93	64.9	14.50	63.3	14.07	61.1	13.66	56.9	13.25
	9.0	7.9	65.1	15.12	65.1	14.64	64.9	14.21	63.3	13.80	61.1	13.39	56.9	12.99
	11.0	9.8	65.1	14.96	65.1	14.47	64.9	14.05	63.3	13.64	61.1	13.24	56.9	12.84
	13.0	11.8	65.1	14.77	65.1	14.29	64.9	13.88	63.3	13.48	61.1	13.07	56.9	12.68
15.0	13.7	65.1	14.57	65.1	14.10	64.9	13.69	63.3	13.29	61.1	12.89	56.9	12.51	
120	-24.8	-25	28.5	15.08	28.5	15.32	28.3	15.69	28.3	16.03	28.3	16.59	28.3	16.97
	-21.8	-22	35.0	15.63	35.0	15.87	34.8	16.24	34.8	16.59	34.8	17.14	34.8	17.52
	-19.8	-20	37.1	16.00	37.1	16.24	36.8	16.60	36.8	16.95	36.8	17.50	36.8	17.89
	-18.8	-19	38.0	16.18	38.0	16.42	37.8	16.79	37.8	17.14	37.8	17.69	37.8	18.07
	-16.7	-17	40.0	16.57	40.0	16.81	39.8	17.17	39.8	17.52	39.8	18.07	39.8	17.68
	-13.7	-15	42.9	17.12	42.9	17.36	42.6	17.72	42.6	18.07	42.6	17.49	42.6	17.12
	-11.8	-13	44.4	17.47	44.4	17.71	44.1	18.07	44.1	17.66	44.1	17.12	44.1	16.76
	-9.8	-11	45.9	17.83	45.9	18.07	45.6	17.63	45.6	17.23	45.6	16.74	45.6	16.39
	-9.5	-10	46.5	17.89	46.5	18.00	46.2	17.56	46.2	17.17	46.2	16.68	46.2	16.33
	-8.5	-9.1	48.4	18.07	48.4	17.77	48.1	17.34	48.1	16.95	47.6	16.49	47.6	16.14
	-7.0	-7.6	51.2	17.73	51.2	17.42	50.9	17.00	50.9	16.63	49.0	16.19	49.0	15.86
	-5.0	-5.6	55.0	17.28	55.0	16.95	54.6	16.56	54.6	16.20	54.6	15.81	50.9	15.49
	-3.0	-3.7	58.7	16.82	58.7	16.49	58.4	16.11	58.4	15.77	57.5	15.42	52.8	15.11
	0.0	-0.7	64.4	16.14	63.9	15.79	61.4	15.44	59.4	15.12	57.5	14.84	53.4	14.55
	3.0	2.2	64.6	15.46	63.9	15.09	61.4	14.77	59.4	14.47	57.5	14.26	53.4	13.99
	5.0	4.1	64.6	15.00	63.9	14.62	61.4	14.32	59.4	14.04	57.5	13.87	53.4	13.62
	7.0	6.0	64.6	14.55	63.9	14.16	61.4	13.88	59.4	13.61	57.5	13.48	53.4	13.24
	9.0	7.9	64.6	14.22	63.9	13.84	61.4	13.56	59.4	13.31	57.5	13.18	53.4	12.94
	11.0	9.8	64.6	14.02	63.9	13.64	61.4	13.37	59.4	13.12	57.5	12.99	53.4	12.76
	13.0	11.8	64.6	13.80	63.9	13.43	61.4	13.16	59.4	12.91	57.5	12.79	53.4	12.56
15.0	13.7	64.6	13.56	63.9	13.20	61.4	12.94	59.4	12.69	57.5	12.57	53.4	12.35	
110	-24.8	-25	28.3	15.32	28.3	15.69	28.2	16.03	28.2	16.59	28.2	16.97	28.2	17.16
	-21.8	-22	34.8	15.87	34.8	16.24	34.6	16.59	34.6	17.14	34.6	17.52	34.6	17.71
	-19.8	-20	36.9	16.24	36.9	16.60	36.6	16.95	36.6	17.50	36.6	17.89	36.6	18.07
	-18.8	-19	37.8	16.42	37.8	16.79	37.6	17.14	37.6	17.69	37.6	18.07	37.6	17.86
	-16.7	-17	39.8	16.81	39.8	17.17	39.6	17.52	39.6	18.07	39.6	17.64	39.6	17.41
	-13.7	-15	42.7	17.36	42.7	17.72	42.4	18.07	42.4	17.42	42.4	17.03	42.4	16.78
	-11.8	-13	44.1	17.71	44.1	18.07	43.9	17.62	43.9	17.01	43.9	16.63	43.9	16.37
	-9.8	-11	45.7	18.07	45.7	17.56	45.4	17.14	45.4	16.58	45.4	16.22	45.4	15.95
	-9.5	-10	46.2	17.99	46.2	17.48	46.0	17.06	46.0	16.51	46.0	16.16	46.0	15.88
	-8.5	-9.1	48.1	17.72	48.1	17.23	47.8	16.82	47.8	16.30	47.5	15.96	47.5	15.67
	-7.0	-7.6	50.9	17.30	50.9	16.84	50.6	16.46	50.6	15.97	49.1	15.65	48.1	15.35
	-5.0	-5.6	54.7	16.75	54.7	16.33	54.3	15.98	53.3	15.54	50.6	15.24	48.1	14.93
	-3.0	-3.7	58.4	16.20	58.4	15.81	55.1	15.50	53.3	15.10	51.5	14.83	48.1	14.50
	0.0	-0.7	62.1	15.37	58.7	15.04	55.1	14.78	53.3	14.45	51.5	14.21	48.1	13.86
	3.0	2.2	62.1	14.55	58.7	14.27	55.1	14.06	53.3	13.80	51.5	13.59	48.1	13.23
	5.0	4.1	62.1	14.00	58.7	13.76	55.1	13.58	53.3	13.37	51.5	13.18	48.1	12.80
	7.0	6.0	62.1	13.45	58.7	13.24	55.1	13.10	53.3	12.94	51.5	12.77	48.1	12.38
	9.0	7.9	62.1	13.08	58.7	12.89	55.1	12.74	53.3	12.59	51.5	12.43	48.1	12.04
	11.0	9.8	62.1	12.83	58.7	12.64	55.1	12.50	53.3	12.35	51.5	12.19	48.1	11.81
	13.0	11.8	62.1	12.56	58.7	12.38	55.1	12.24	53.3	12.09	51.5	11.93	48.1	11.56
15.0	13.7	62.1	12.27	58.7	12.09	55.1	11.95	53.3	11.81	51.5	11.66	48.1	11.30	



# 7. Capacity Tables

Heating Capacity (16HP)

Combination (%)	Outdoor air temp.		Indoor air temp. °C DB											
			16		18		20		21		22		24	
	°C DB	°C WB	TC	PI	TC	PI	TC	PI	TC	PI	TC	PI	TC	PI
100	-24.8	-25	28.2	16.89	28.2	17.04	28.0	16.61	28.0	17.43	28.0	17.60	28.0	17.68
	-21.8	-22	34.6	17.12	34.6	17.28	34.4	17.14	34.4	17.67	34.4	18.06	34.4	17.92
	-19.8	-20	36.7	17.28	36.7	17.44	36.5	17.49	36.5	17.83	36.5	18.07	36.5	18.07
	-18.8	-19	37.7	17.36	37.4	17.52	37.4	17.67	37.4	17.91	37.4	18.07	37.4	17.81
	-16.7	-17	39.4	17.53	39.4	17.69	39.4	18.06	39.2	18.07	39.2	17.53	39.2	17.24
	-13.7	-15	42.5	17.76	42.5	17.92	42.2	18.07	42.2	17.29	42.2	16.74	42.2	16.44
	-11.8	-13	43.9	17.92	43.7	18.07	43.7	17.55	43.7	16.79	43.7	16.25	43.7	15.93
	-9.8	-11	45.4	18.07	45.4	17.49	45.2	17.00	45.2	16.26	45.2	15.73	43.9	15.40
	-9.5	-10	46.0	17.98	46.0	17.41	45.8	16.92	45.8	16.18	45.8	15.65	43.9	15.32
	-8.5	-9.1	47.8	17.68	47.8	17.11	47.6	16.65	48.8	15.92	47.2	15.39	43.9	15.05
	-7.0	-7.6	51.5	17.23	51.3	16.68	50.4	16.23	48.8	15.53	47.2	14.99	43.9	14.65
	-5.0	-5.6	53.8	16.63	53.2	16.10	50.4	15.68	48.8	15.00	47.2	14.47	43.9	14.12
	-3.0	-3.7	55.3	16.03	53.6	15.52	50.4	15.14	48.8	14.48	47.2	13.95	43.9	13.58
	0.0	-0.7	56.9	15.12	53.6	14.64	50.4	14.31	48.8	13.69	47.2	13.17	43.9	12.78
	3.0	2.2	56.9	14.22	53.6	13.77	50.4	13.49	48.8	12.90	47.2	12.38	43.9	11.98
	5.0	4.1	56.9	13.62	53.6	13.19	50.4	12.94	48.8	12.38	47.2	11.86	43.9	11.44
	7.0	6.0	56.9	13.02	53.6	12.61	50.4	12.39	48.8	11.85	47.2	11.34	43.9	10.91
9.0	7.9	56.9	12.54	53.6	12.15	50.4	11.94	48.8	11.42	47.2	10.93	43.9	10.51	
11.0	9.8	56.9	12.17	53.6	11.79	50.4	11.59	48.8	11.09	47.2	10.61	43.9	10.20	
13.0	11.8	56.9	11.78	53.6	11.41	50.4	11.21	48.8	10.73	47.2	10.26	43.9	9.87	
15.0	13.7	56.9	11.37	53.6	11.01	50.4	10.82	48.8	10.35	47.2	9.90	43.9	9.52	
90	-24.8	-25	28.1	15.08	28.1	15.63	27.9	16.02	27.9	16.20	27.9	16.57	27.9	17.12
	-21.8	-22	34.5	15.63	34.5	16.18	34.3	16.57	34.3	16.75	34.3	17.12	34.3	16.44
	-19.8	-20	36.6	16.00	36.6	16.55	36.3	16.93	36.3	17.12	36.3	16.66	36.3	15.99
	-18.8	-19	37.7	16.18	37.4	16.73	37.3	17.12	37.3	16.88	37.3	16.43	37.3	15.76
	-16.7	-17	39.4	16.57	39.4	17.12	39.2	16.64	39.2	16.39	39.2	15.95	39.2	15.28
	-13.7	-15	42.5	17.12	42.5	16.41	42.1	15.95	42.1	15.69	42.1	15.26	40.2	14.60
	-11.8	-13	43.9	16.64	43.7	15.96	43.5	15.52	43.5	15.24	43.2	14.83	40.2	14.17
	-9.8	-11	45.4	16.13	45.4	15.49	45.0	15.06	44.7	14.77	43.2	14.37	40.2	13.72
	-9.5	-10	46.0	16.06	46.0	15.42	45.6	14.99	44.7	14.70	43.2	14.30	40.2	13.65
	-8.5	-9.1	47.8	15.81	47.5	15.18	46.1	14.76	44.7	14.47	43.2	14.07	40.2	13.43
	-7.0	-7.6	51.5	15.43	49.0	14.83	46.1	14.42	44.7	14.12	43.2	13.73	40.2	13.09
	-5.0	-5.6	52.1	14.92	49.0	14.36	46.1	13.96	44.7	13.65	43.2	13.27	40.2	12.63
	-3.0	-3.7	52.1	14.42	49.0	13.89	46.1	13.51	44.7	13.18	43.2	12.81	40.2	12.18
	0.0	-0.7	52.1	13.66	49.0	13.18	46.1	12.82	44.7	12.48	43.2	12.12	40.2	11.50
	3.0	2.2	52.1	12.91	49.0	12.47	46.1	12.14	44.7	11.78	43.2	11.43	40.2	10.82
	5.0	4.1	52.1	12.40	49.0	12.00	46.1	11.68	44.7	11.31	43.2	10.97	40.2	10.37
	7.0	6.0	52.1	11.90	49.0	11.53	46.1	11.22	44.7	10.84	43.2	10.52	40.2	9.92
9.0	7.9	52.1	11.41	49.0	11.06	46.1	10.76	44.7	10.40	43.2	10.09	40.2	9.51	
11.0	9.8	52.1	10.93	49.0	10.59	46.1	10.31	44.7	9.96	43.2	9.66	40.2	9.11	
13.0	11.8	52.1	10.44	49.0	10.12	46.1	9.85	44.7	9.51	43.2	9.23	40.2	8.70	
15.0	13.7	52.1	9.96	49.0	9.65	46.1	9.39	44.7	9.07	43.2	8.80	40.2	8.30	
80	-24.8	-25	28.0	13.14	28.0	13.69	27.8	14.08	27.8	14.26	27.8	15.18	27.8	14.58
	-21.8	-22	34.1	13.69	34.1	14.24	34.1	14.63	34.1	15.18	34.1	14.58	34.1	14.00
	-19.8	-20	36.2	14.06	36.2	14.61	36.2	15.18	36.2	14.76	36.2	14.18	35.9	13.62
	-18.8	-19	37.1	14.24	37.1	15.18	37.1	14.97	37.1	14.55	37.1	13.98	35.9	13.42
	-16.7	-17	39.2	15.18	39.2	14.74	39.2	14.53	39.2	14.11	38.6	13.57	35.9	13.02
	-13.7	-15	43.1	14.54	42.3	14.12	41.3	13.90	40.0	13.48	38.6	12.97	35.9	12.44
	-11.8	-13	44.2	14.14	42.9	13.73	41.3	13.50	40.0	13.09	38.6	12.59	35.9	12.08
	-9.8	-11	45.0	13.71	43.3	13.32	41.3	13.08	40.0	12.67	38.6	12.19	35.9	11.69
	-9.5	-10	45.3	13.65	43.6	13.25	41.3	13.01	40.0	12.60	38.6	12.13	35.9	11.63
	-8.5	-9.1	45.9	13.43	43.9	13.05	41.3	12.80	40.0	12.40	38.6	11.93	35.9	11.44
	-7.0	-7.6	46.6	13.11	43.9	12.74	41.3	12.49	40.0	12.08	38.6	11.64	35.9	11.15
	-5.0	-5.6	46.6	12.69	43.9	12.32	41.3	12.07	40.0	11.66	38.6	11.24	35.9	10.76
	-3.0	-3.7	46.6	12.26	43.9	11.91	41.3	11.65	40.0	11.24	38.6	10.84	35.9	10.38
	0.0	-0.7	46.6	11.62	43.9	11.29	41.3	11.02	40.0	10.62	38.6	10.24	35.9	9.80
	3.0	2.2	46.6	10.98	43.9	10.67	41.3	10.39	40.0	9.99	38.6	9.65	35.9	9.22
	5.0	4.1	46.6	10.56	43.9	10.25	41.3	9.97	40.0	9.57	38.6	9.25	35.9	8.84
	7.0	6.0	46.6	10.13	43.9	9.84	41.3	9.55	40.0	9.15	38.6	8.85	35.9	8.45
9.0	7.9	46.6	9.51	43.9	9.24	41.3	8.97	40.0	8.59	38.6	8.31	35.9	7.93	
11.0	9.8	46.6	8.83	43.9	8.57	41.3	8.32	40.0	7.97	38.6	7.71	35.9	7.36	
13.0	11.8	46.6	8.24	43.9	8.00	41.3	7.77	40.0	7.44	38.6	7.20	35.9	6.87	
15.0	13.7	46.6	7.76	43.9	7.53	41.3	7.31	40.0	7.01	38.6	6.78	35.9	6.47	

# 7. Capacity Tables

Heating Capacity (16HP)

Combination (%)	Outdoor air temp.		Indoor air temp. °C DB											
			16		18		20		21		22		24	
	°C DB	°C WB	TC	PI	TC	PI	TC	PI	TC	PI	TC	PI	TC	PI
70	-24.8	-25	28.0	13.53	28.0	13.71	27.8	14.08	27.8	14.63	27.8	13.98	27.8	13.38
	-21.8	-22	34.1	14.08	34.4	14.26	34.1	14.63	33.9	13.98	32.9	13.38	30.7	12.79
	-19.8	-20	36.2	14.44	36.2	14.63	35.1	14.18	33.9	13.56	32.9	12.98	30.7	12.40
	-18.8	-19	37.1	14.63	37.1	14.40	35.1	13.96	33.9	13.34	32.9	12.78	30.7	12.20
	-16.7	-17	39.2	14.16	37.3	13.92	35.1	13.49	33.9	12.89	32.9	12.35	30.7	11.79
	-13.7	-15	39.5	13.48	37.3	13.23	35.1	12.82	33.9	12.25	32.9	11.75	30.7	11.20
	-11.8	-13	39.5	13.05	37.3	12.79	35.1	12.39	33.9	11.84	32.9	11.37	30.7	10.82
	-9.8	-11	39.5	12.60	37.3	12.33	35.1	11.94	33.9	11.41	32.9	10.96	30.7	10.43
	-9.5	-10	39.5	12.54	37.3	12.26	35.1	11.88	33.9	11.35	32.9	10.90	30.7	10.37
	-8.5	-9.1	39.5	12.31	37.3	12.03	35.1	11.65	33.9	11.14	32.9	10.70	30.7	10.17
	-7.0	-7.6	39.5	11.97	37.3	11.69	35.1	11.32	33.9	10.81	32.9	10.40	30.7	9.88
	-5.0	-5.6	39.5	11.52	37.3	11.23	35.1	10.87	33.9	10.39	32.9	10.00	30.7	9.49
	-3.0	-3.7	39.5	11.07	37.3	10.77	35.1	10.42	33.9	9.96	32.9	9.59	30.7	9.09
	0.0	-0.7	39.5	10.40	37.3	10.08	35.1	9.75	33.9	9.31	32.9	8.99	30.7	8.50
	3.0	2.2	39.5	9.72	37.3	9.39	35.1	9.08	33.9	8.67	32.9	8.38	30.7	7.91
	5.0	4.1	39.5	9.27	37.3	8.93	35.1	8.63	33.9	8.24	32.9	7.98	30.7	7.52
	7.0	6.0	39.5	8.82	37.3	8.47	35.1	8.19	33.9	7.81	32.9	7.58	30.7	7.13
	9.0	7.9	39.5	8.37	37.3	8.01	35.1	7.94	33.9	7.42	32.9	7.19	30.7	6.74
	11.0	9.8	39.5	7.92	37.3	7.55	35.1	7.67	33.9	7.03	32.9	6.84	30.7	6.35
	13.0	11.8	39.5	7.47	37.3	7.18	35.1	7.28	33.9	6.57	32.9	6.37	30.7	5.96
15.0	13.7	39.5	7.02	37.3	6.79	35.1	6.88	33.9	6.10	32.9	5.98	30.7	5.57	
60	-24.8	-25	28.0	13.16	28.0	13.53	27.8	14.08	27.8	13.41	27.8	12.78	26.3	12.18
	-21.8	-22	31.5	13.71	32.1	14.08	30.1	13.41	29.1	12.78	28.1	12.18	26.3	11.60
	-19.8	-20	33.9	14.08	32.1	13.61	30.1	12.96	29.1	12.36	28.1	11.78	26.3	11.21
	-18.8	-19	33.9	13.84	32.1	13.37	30.1	12.74	29.1	12.15	28.1	11.58	26.3	11.01
	-16.7	-17	33.9	13.35	32.1	12.88	30.1	12.27	29.1	11.70	28.1	11.16	26.3	10.60
	-13.7	-15	33.9	12.65	32.1	12.18	30.1	11.60	29.1	11.07	28.1	10.57	26.3	10.02
	-11.8	-13	33.9	12.21	32.1	11.73	30.1	11.18	29.1	10.67	28.1	10.19	26.3	9.65
	-9.8	-11	33.9	11.74	32.1	11.27	30.1	10.73	29.1	10.25	28.1	9.79	26.3	9.26
	-9.5	-10	33.9	11.67	32.1	11.20	30.1	10.67	29.1	10.19	28.1	9.73	26.3	9.20
	-8.5	-9.1	33.9	11.44	32.1	10.96	30.1	10.44	29.1	9.98	28.1	9.53	26.3	9.01
	-7.0	-7.6	33.9	11.09	32.1	10.61	30.1	10.11	29.1	9.66	28.1	9.23	26.3	8.72
	-5.0	-5.6	33.9	10.63	32.1	10.14	30.1	9.66	29.1	9.24	28.1	8.83	26.3	8.33
	-3.0	-3.7	33.9	10.16	32.1	9.67	30.1	9.22	29.1	8.82	28.1	8.44	26.3	7.94
	0.0	-0.7	33.9	9.46	32.1	8.97	30.1	8.55	29.1	8.19	28.1	7.84	26.3	7.55
	3.0	2.2	33.9	8.76	32.1	8.27	30.1	7.88	29.1	7.56	28.1	7.24	26.3	6.77
	5.0	4.1	33.9	8.29	32.1	7.80	30.1	7.44	29.1	7.14	28.1	6.84	26.3	6.38
	7.0	6.0	33.9	7.83	32.1	7.33	30.1	6.99	29.1	6.72	28.1	6.44	26.3	5.99
	9.0	7.9	33.9	7.36	32.1	6.84	30.1	6.54	29.1	6.24	28.1	5.98	26.3	5.60
	11.0	9.8	33.9	6.89	32.1	6.35	30.1	6.05	29.1	5.74	28.1	5.47	26.3	5.21
	13.0	11.8	33.9	6.41	32.1	5.86	30.1	5.56	29.1	5.24	28.1	4.99	26.3	4.82
15.0	13.7	33.9	5.93	32.1	5.37	30.1	5.07	29.1	4.95	28.1	4.75	26.3	4.42	
50	-24.8	-25	28.3	12.05	26.7	12.60	25.1	11.97	24.3	11.38	23.5	10.81	21.9	10.29
	-21.8	-22	28.3	12.60	26.7	11.97	25.1	11.38	24.3	10.81	23.5	10.29	21.9	9.78
	-19.8	-20	28.3	12.16	26.7	11.55	25.1	10.98	24.3	10.44	23.5	9.94	21.9	9.44
	-18.8	-19	28.3	11.95	26.7	11.34	25.1	10.79	24.3	10.25	23.5	9.76	21.9	9.27
	-16.7	-17	28.3	11.49	26.7	10.90	25.1	10.37	24.3	9.86	23.5	9.40	21.9	8.91
	-13.7	-15	28.3	10.83	26.7	10.27	25.1	9.78	24.3	9.29	23.5	8.87	21.9	8.40
	-11.8	-13	28.3	10.42	26.7	9.87	25.1	9.40	24.3	8.94	23.5	8.54	21.9	8.08
	-9.8	-11	28.3	9.98	26.7	9.45	25.1	9.01	24.3	8.56	23.5	8.19	21.9	7.74
	-9.5	-10	28.3	9.92	26.7	9.38	25.1	8.95	24.3	8.51	23.5	8.13	21.9	7.69
	-8.5	-9.1	28.3	9.70	26.7	9.17	25.1	8.75	24.3	8.32	23.5	7.96	21.9	7.52
	-7.0	-7.6	28.3	9.37	26.7	8.86	25.1	8.46	24.3	8.04	23.5	7.70	21.9	7.27
	-5.0	-5.6	28.3	8.93	26.7	8.44	25.1	8.06	24.3	7.66	23.5	7.34	21.9	6.93
	-3.0	-3.7	28.3	8.50	26.7	8.02	25.1	7.67	24.3	7.29	23.5	6.99	21.9	6.59
	0.0	-0.7	28.3	7.84	26.7	7.38	25.1	7.08	24.3	6.72	23.5	6.47	21.9	6.08
	3.0	2.2	28.3	7.19	26.7	6.75	25.1	6.48	24.3	6.16	23.5	5.94	21.9	5.57
	5.0	4.1	28.3	6.75	26.7	6.33	25.1	6.09	24.3	5.78	23.5	5.59	21.9	5.23
	7.0	6.0	28.3	6.31	26.7	5.91	25.1	5.69	24.3	5.41	23.5	5.24	21.9	4.89
	9.0	7.9	28.3	5.70	26.7	5.34	25.1	5.14	24.3	4.88	23.5	4.73	21.9	4.42
	11.0	9.8	28.3	5.33	26.7	5.00	25.1	4.81	24.3	4.57	23.5	4.43	21.9	4.13
	13.0	11.8	28.3	5.01	26.7	4.69	25.1	4.52	24.3	4.29	23.5	4.16	21.9	3.88
15.0	13.7	28.3	4.74	26.7	4.44	25.1	4.27	24.3	4.06	23.5	3.93	21.9	3.67	

**Note**

1. TC: Total Capacity(kW), PI : Power Input(kW, Comp. + Outdoor fan motor)
2. Capacity tables show the average value of conditions which may occur.
3. The heating capacity table is based on the values expressed as Max. in the specification of the outdoor unit. (When measuring the Max. heating capacity, the setting status of the indoor unit is the same as that for measuring the heating capacity of the indoor unit.)

# 7. Capacity Tables

## ◆ ARUM180LTE5

Heating Capacity (18HP)

Combination (%)	Outdoor air temp.		Indoor air temp. °C DB											
			16		18		20		21		22		24	
	°C DB	°C WB	TC	PI	TC	PI	TC	PI	TC	PI	TC	PI	TC	PI
130	-24.8	-25	37.3	17.62	37.3	17.73	37.0	17.83	37.0	17.98	37.0	18.13	36.3	18.36
	-21.8	-22	44.2	17.85	44.2	17.96	43.9	18.06	43.9	18.21	43.9	18.36	43.1	18.59
	-19.8	-20	46.1	18.00	46.1	18.11	45.8	18.21	45.8	18.37	45.8	18.51	44.9	18.74
	-18.8	-19	47.0	18.07	47.0	18.19	46.7	18.29	46.7	18.44	46.7	18.59	45.8	18.82
	-16.7	-17	48.9	18.24	48.9	18.35	48.5	18.45	48.5	18.60	48.5	18.75	47.6	18.98
	-13.7	-15	51.6	18.46	51.6	18.58	51.2	18.68	51.2	18.83	51.2	18.98	50.3	18.19
	-11.8	-13	53.2	18.61	53.2	18.72	52.9	18.82	52.9	18.98	52.9	18.44	51.9	17.69
	-9.8	-11	55.0	18.76	55.0	18.88	54.7	18.98	54.7	18.40	54.7	17.88	53.7	17.17
	-9.5	-10	55.3	18.79	55.3	18.90	55.0	18.89	55.0	18.31	54.9	17.80	54.0	17.09
	-8.5	-9.1	56.4	18.86	56.4	18.98	56.1	18.59	56.1	18.03	55.8	17.52	54.8	16.83
	-7.0	-7.6	58.0	18.98	58.0	18.53	57.7	18.14	57.7	17.59	57.7	17.09	56.2	16.43
	-5.0	-5.6	60.2	18.39	60.2	17.94	59.8	17.55	59.8	17.02	59.8	16.53	57.9	15.91
	-3.0	-3.7	62.3	17.80	62.3	17.35	61.9	16.95	61.9	16.44	61.9	15.97	59.7	15.39
	0.0	-0.7	65.5	16.92	65.5	16.46	65.1	16.06	65.1	15.58	65.1	15.13	62.3	14.60
	3.0	2.2	68.8	16.04	68.8	15.57	68.3	15.16	68.3	14.71	68.3	14.28	64.0	13.81
	5.0	4.1	70.9	15.45	70.9	14.98	70.5	14.57	70.5	14.14	68.8	13.72	64.0	13.29
	7.0	6.0	73.1	14.87	73.1	14.39	72.6	13.97	71.2	13.56	68.8	13.16	64.0	12.77
9.0	7.9	73.3	14.38	73.3	13.91	73.1	13.51	71.2	13.11	68.8	12.72	64.0	12.34	
11.0	9.8	73.3	14.01	73.3	13.55	73.1	13.16	71.2	12.78	68.8	12.40	64.0	12.03	
13.0	11.8	73.3	13.61	73.3	13.17	73.1	12.79	71.2	12.42	68.8	12.05	64.0	11.69	
15.0	13.7	73.3	13.19	73.3	12.77	73.1	12.40	71.2	12.04	68.8	11.68	64.0	11.33	
120	-24.8	-25	37.0	17.73	37.0	17.83	36.8	17.98	36.8	18.13	36.8	18.36	36.1	18.52
	-21.8	-22	43.9	17.96	43.9	18.06	43.6	18.21	43.6	18.36	43.6	18.59	42.8	18.75
	-19.8	-20	45.7	18.11	45.7	18.21	45.4	18.37	45.4	18.51	45.4	18.74	44.6	18.90
	-18.8	-19	46.6	18.19	46.6	18.29	46.3	18.44	46.3	18.59	46.3	18.82	45.5	18.98
	-16.7	-17	48.5	18.35	48.5	18.45	48.2	18.60	48.2	18.75	48.2	18.98	47.3	18.47
	-13.7	-15	51.2	18.58	51.2	18.68	50.9	18.83	50.9	18.98	50.9	18.22	49.9	17.75
	-11.8	-13	52.9	18.72	52.9	18.82	52.5	18.98	52.5	18.44	52.5	17.74	51.6	17.29
	-9.8	-11	54.6	18.88	54.6	18.98	54.3	18.38	54.3	17.87	54.3	17.23	53.3	16.81
	-9.5	-10	54.9	18.90	54.9	18.88	54.6	18.29	54.6	17.79	54.6	17.16	53.6	16.74
	-8.5	-9.1	56.0	18.98	56.0	18.56	55.7	17.99	55.7	17.50	55.5	16.91	54.5	16.50
	-7.0	-7.6	57.6	18.50	57.6	18.09	57.2	17.55	57.2	17.08	56.8	16.53	55.8	16.13
	-5.0	-5.6	59.7	17.86	59.7	17.45	59.4	16.95	59.4	16.51	59.4	16.02	57.5	15.65
	-3.0	-3.7	61.9	17.22	61.9	16.82	61.5	16.35	61.5	15.95	61.5	15.52	59.3	15.17
	0.0	-0.7	65.1	16.26	65.1	15.86	64.7	15.46	64.7	15.10	64.7	14.76	60.1	14.45
	3.0	2.2	68.3	15.30	68.3	14.91	67.8	14.57	66.8	14.25	64.7	14.00	60.1	13.72
	5.0	4.1	70.4	14.66	70.4	14.28	69.1	13.97	66.8	13.68	64.7	13.50	60.1	13.24
	7.0	6.0	72.5	14.02	71.9	13.64	69.1	13.37	66.8	13.12	64.7	12.99	60.1	12.76
9.0	7.9	72.7	13.53	71.9	13.16	69.1	12.90	66.8	12.66	64.7	12.54	60.1	12.31	
11.0	9.8	72.7	13.15	71.9	12.80	69.1	12.55	66.8	12.31	64.7	12.19	60.1	11.97	
13.0	11.8	72.7	12.75	71.9	12.41	69.1	12.16	66.8	11.93	64.7	11.82	60.1	11.61	
15.0	13.7	72.7	12.33	71.9	11.99	69.1	11.76	66.8	11.53	64.7	11.42	60.1	11.22	
110	-24.8	-25	36.8	17.83	36.8	17.98	36.6	18.13	36.6	18.36	36.6	18.52	35.9	18.59
	-21.8	-22	43.7	18.06	43.7	18.21	43.4	18.36	43.4	18.59	43.4	18.75	42.6	18.82
	-19.8	-20	45.5	18.21	45.5	18.37	45.2	18.51	45.2	18.74	45.2	18.90	44.3	18.98
	-18.8	-19	46.4	18.29	46.4	18.44	46.1	18.59	46.1	18.82	46.1	18.98	45.2	18.71
	-16.7	-17	48.2	18.45	48.2	18.60	47.9	18.75	47.9	18.98	47.9	18.43	47.0	18.16
	-13.7	-15	50.9	18.68	50.9	18.83	50.6	18.98	50.6	18.15	50.6	17.66	50.6	17.37
	-11.8	-13	52.6	18.82	52.6	18.98	52.2	18.39	52.2	17.63	52.2	17.17	52.2	16.87
	-9.8	-11	54.3	18.98	54.3	18.32	54.0	17.78	54.0	17.08	54.0	16.65	53.3	16.35
	-9.5	-10	54.6	18.87	54.6	18.22	54.3	17.69	54.3	17.00	54.3	16.57	54.1	16.27
	-8.5	-9.1	55.7	18.51	55.7	17.89	55.4	17.38	55.4	16.72	55.4	16.31	54.1	16.00
	-7.0	-7.6	57.3	17.97	57.3	17.39	56.9	16.92	56.9	16.31	56.9	15.93	54.1	15.61
	-5.0	-5.6	59.4	17.26	59.4	16.73	59.0	16.31	59.0	15.76	57.9	15.41	54.1	15.08
	-3.0	-3.7	61.5	16.54	61.5	16.07	61.2	15.69	60.0	15.21	57.9	14.89	54.1	14.56
	0.0	-0.7	64.7	15.47	64.7	15.08	62.0	14.77	60.0	14.39	57.9	14.12	54.1	13.77
	3.0	2.2	67.9	14.39	66.1	14.09	62.0	13.85	60.0	13.57	57.9	13.34	54.1	12.98
	5.0	4.1	69.9	13.68	66.1	13.42	62.0	13.23	60.0	13.02	57.9	12.82	54.1	12.45
	7.0	6.0	69.9	12.96	66.1	12.76	62.0	12.62	60.0	12.47	57.9	12.31	54.1	11.93
9.0	7.9	69.9	12.45	66.1	12.26	62.0	12.13	60.0	11.98	57.9	11.83	54.1	11.46	
11.0	9.8	69.9	12.05	66.1	11.87	62.0	11.73	60.0	11.59	57.9	11.44	54.1	11.09	
13.0	11.8	69.9	11.62	66.1	11.45	62.0	11.32	60.0	11.18	57.9	11.04	54.1	10.70	
15.0	13.7	69.9	11.17	66.1	11.00	62.0	10.88	60.0	10.74	57.9	10.61	54.1	10.28	

# 7. Capacity Tables

Heating Capacity (18HP)

Combination (%)	Outdoor air temp.		Indoor air temp. °C DB											
			16		18		20		21		22		24	
	°C DB	°C WB	TC	PI	TC	PI	TC	PI	TC	PI	TC	PI	TC	PI
100	-24.8	-25	36.6	18.53	36.6	18.59	36.4	17.83	36.4	18.73	36.4	18.80	35.7	18.83
	-21.8	-22	43.5	18.62	43.5	18.68	43.2	18.40	43.2	18.82	43.2	18.98	42.4	18.92
	-19.8	-20	45.3	18.68	45.3	18.74	45.0	18.75	45.0	18.88	45.0	18.98	44.2	18.98
	-18.8	-19	46.2	18.71	45.9	18.77	45.9	18.82	45.9	18.91	45.9	18.98	45.0	18.66
	-16.7	-17	47.7	18.77	47.7	18.83	47.7	18.98	47.5	18.98	47.5	18.32	46.6	18.00
	-13.7	-15	50.7	18.86	50.7	18.92	50.4	18.98	50.4	18.02	50.4	17.39	49.4	17.05
	-11.8	-13	52.3	18.92	52.0	18.98	52.0	18.33	52.0	17.41	52.0	16.79	49.4	16.45
	-9.8	-11	54.0	18.98	54.0	18.25	53.8	17.65	53.8	16.78	53.1	16.17	49.4	15.82
	-9.5	-10	54.3	18.86	54.3	18.14	54.1	17.55	54.1	16.68	53.1	16.08	49.4	15.72
	-8.5	-9.1	55.4	18.48	55.4	17.78	55.1	17.21	54.9	16.36	53.1	15.76	49.4	15.41
	-7.0	-7.6	57.9	17.90	57.7	17.23	56.7	16.70	54.9	15.89	53.1	15.30	49.4	14.93
	-5.0	-5.6	60.5	17.14	59.9	16.51	56.7	16.02	54.9	15.25	53.1	14.67	49.4	14.30
	-3.0	-3.7	62.2	16.37	60.3	15.78	56.7	15.34	54.9	14.61	53.1	14.05	49.4	13.67
	0.0	-0.7	64.0	15.23	60.3	14.69	56.7	14.32	54.9	13.65	53.1	13.11	49.4	12.72
	3.0	2.2	64.0	14.08	60.3	13.60	56.7	13.30	54.9	12.70	53.1	12.18	49.4	11.77
	5.0	4.1	64.0	13.31	60.3	12.88	56.7	12.62	54.9	12.06	53.1	11.55	49.4	11.14
	7.0	6.0	64.0	12.55	60.3	12.15	56.7	11.94	54.9	11.42	53.1	10.93	49.4	10.51
	9.0	7.9	64.0	11.84	60.3	11.47	56.7	11.27	54.9	10.78	53.1	10.32	49.4	9.92
	11.0	9.8	64.0	11.23	60.3	10.88	56.7	10.69	54.9	10.23	53.1	9.78	49.4	9.41
	13.0	11.8	64.0	10.59	60.3	10.25	56.7	10.07	54.9	9.64	53.1	9.22	49.4	8.87
15.0	13.7	64.0	9.91	60.3	9.60	56.7	9.43	54.9	9.02	53.1	8.63	49.4	8.30	
90	-24.8	-25	36.5	17.15	36.5	17.38	36.3	17.54	36.3	17.62	36.3	17.77	35.6	18.00
	-21.8	-22	43.3	17.38	43.3	17.61	43.0	17.77	43.0	17.85	43.0	18.00	42.2	17.20
	-19.8	-20	45.1	17.53	45.1	17.76	44.8	17.92	44.8	18.00	44.8	17.45	44.0	16.67
	-18.8	-19	46.2	17.61	45.9	17.84	45.7	18.00	45.7	17.72	45.7	17.18	44.8	16.41
	-16.7	-17	47.7	17.77	47.7	18.00	47.5	17.41	47.5	17.12	47.5	16.61	45.2	15.85
	-13.7	-15	50.7	18.00	50.7	17.13	50.2	16.58	50.2	16.28	48.7	15.79	45.2	15.05
	-11.8	-13	52.3	17.40	52.0	16.57	51.8	16.05	50.3	15.74	48.7	15.27	45.2	14.55
	-9.8	-11	54.0	16.77	54.0	15.99	51.9	15.49	50.3	15.18	48.7	14.72	45.2	14.02
	-9.5	-10	54.3	16.67	54.3	15.91	51.9	15.41	50.3	15.10	48.7	14.64	45.2	13.94
	-8.5	-9.1	55.4	16.36	55.0	15.62	51.9	15.13	50.3	14.81	48.7	14.37	45.2	13.67
	-7.0	-7.6	57.9	15.88	55.1	15.18	51.9	14.71	50.3	14.39	48.7	13.96	45.2	13.27
	-5.0	-5.6	58.6	15.25	55.1	14.60	51.9	14.16	50.3	13.83	48.7	13.41	45.2	12.74
	-3.0	-3.7	58.6	14.62	55.1	14.02	51.9	13.60	50.3	13.26	48.7	12.86	45.2	12.21
	0.0	-0.7	58.6	13.67	55.1	13.15	51.9	12.76	50.3	12.42	48.7	12.05	45.2	11.41
	3.0	2.2	58.6	12.73	55.1	12.27	51.9	11.93	50.3	11.57	48.7	11.23	45.2	10.62
	5.0	4.1	58.6	12.10	55.1	11.69	51.9	11.37	50.3	11.01	48.7	10.68	45.2	10.09
	7.0	6.0	58.6	11.46	55.1	11.11	51.9	10.81	50.3	10.44	48.7	10.13	45.2	9.56
	9.0	7.9	58.6	10.87	55.1	10.54	51.9	10.26	50.3	9.91	48.7	9.61	45.2	9.06
	11.0	9.8	58.6	10.28	55.1	9.97	51.9	9.70	50.3	9.37	48.7	9.09	45.2	8.57
	13.0	11.8	58.6	9.69	55.1	9.39	51.9	9.14	50.3	8.83	48.7	8.57	45.2	8.08
15.0	13.7	58.6	9.10	55.1	8.82	51.9	8.59	50.3	8.29	48.7	8.05	45.2	7.59	
80	-24.8	-25	36.3	15.11	36.3	15.34	36.1	15.50	36.1	15.58	36.1	15.96	35.4	15.26
	-21.8	-22	42.9	15.34	42.9	15.57	42.9	15.73	42.9	15.96	42.9	15.26	40.4	14.59
	-19.8	-20	44.6	15.49	44.6	15.72	44.6	15.96	44.6	15.46	43.4	14.79	40.4	14.14
	-18.8	-19	45.5	15.57	45.5	15.96	45.5	15.71	45.0	15.22	43.4	14.56	40.4	13.92
	-16.7	-17	46.4	15.96	46.4	15.43	46.4	15.18	45.0	14.70	43.4	14.07	40.4	13.45
	-13.7	-15	48.5	15.18	47.6	14.68	46.4	14.42	45.0	13.95	43.4	13.37	40.4	12.78
	-11.8	-13	50.1	14.68	48.6	14.20	46.4	13.94	45.0	13.48	43.4	12.92	40.4	12.35
	-9.8	-11	51.4	14.16	49.1	13.70	46.4	13.44	45.0	12.98	43.4	12.45	40.4	11.90
	-9.5	-10	51.7	14.08	49.4	13.62	46.4	13.36	45.0	12.91	43.4	12.38	40.4	11.84
	-8.5	-9.1	52.1	13.82	49.4	13.37	46.4	13.11	45.0	12.66	43.4	12.15	40.4	11.61
	-7.0	-7.6	52.4	13.42	49.4	13.00	46.4	12.73	45.0	12.29	43.4	11.80	40.4	11.28
	-5.0	-5.6	52.4	12.90	49.4	12.49	46.4	12.23	45.0	11.79	43.4	11.33	40.4	10.83
	-3.0	-3.7	52.4	12.38	49.4	11.99	46.4	11.72	45.0	11.30	43.4	10.87	40.4	10.38
	0.0	-0.7	52.4	11.59	49.4	11.24	46.4	10.97	45.0	10.55	43.4	10.16	40.4	9.71
	3.0	2.2	52.4	10.81	49.4	10.49	46.4	10.21	45.0	9.81	43.4	9.46	40.4	9.04
	5.0	4.1	52.4	10.29	49.4	9.98	46.4	9.71	45.0	9.31	43.4	9.00	40.4	8.59
	7.0	6.0	52.4	9.76	49.4	9.48	46.4	9.20	45.0	8.82	43.4	8.53	40.4	8.14
	9.0	7.9	52.4	9.17	49.4	8.90	46.4	8.64	45.0	8.28	43.4	8.01	40.4	7.65
	11.0	9.8	52.4	8.51	49.4	8.26	46.4	8.02	45.0	7.68	43.4	7.43	40.4	7.10
	13.0	11.8	52.4	7.94	49.4	7.71	46.4	7.49	45.0	7.17	43.4	6.94	40.4	6.62
15.0	13.7	52.4	7.48	49.4	7.26	46.4	7.05	45.0	6.75	43.4	6.53	40.4	6.24	

# 7. Capacity Tables

Heating Capacity (18HP)

Combination (%)	Outdoor air temp.		Indoor air temp. °C DB													
			16		18		20		21		22		24			
	°C DB	°C WB	TC	PI	TC	PI	TC	PI	TC	PI	TC	PI	TC	PI		
70	-24.8	-25	36.3	15.13	36.3	15.20	36.1	15.36	36.1	15.59	36.1	15.59	36.1	14.83	34.5	14.12
	-21.8	-22	39.8	15.36	39.8	15.43	39.5	15.59	38.2	14.83	37.0	14.12	34.5	13.43		
	-19.8	-20	42.0	15.51	42.0	15.59	39.5	15.05	38.2	14.32	37.0	13.64	34.5	12.98		
	-18.8	-19	43.2	15.59	42.0	15.31	39.5	14.78	38.2	14.07	37.0	13.41	34.5	12.75		
	-16.7	-17	44.5	15.01	42.0	14.73	39.5	14.22	38.2	13.53	37.0	12.91	34.5	12.27		
	-13.7	-15	44.5	14.19	42.0	13.90	39.5	13.42	38.2	12.77	37.0	12.20	34.5	11.59		
	-11.8	-13	44.5	13.66	42.0	13.37	39.5	12.91	38.2	12.29	37.0	11.75	34.5	11.15		
	-9.8	-11	44.5	13.12	42.0	12.82	39.5	12.38	38.2	11.79	37.0	11.28	34.5	10.70		
	-9.5	-10	44.5	13.03	42.0	12.73	39.5	12.30	38.2	11.71	37.0	11.21	34.5	10.63		
	-8.5	-9.1	44.5	12.76	42.0	12.46	39.5	12.03	38.2	11.46	37.0	10.97	34.5	10.40		
	-7.0	-7.6	44.5	12.35	42.0	12.04	39.5	11.63	38.2	11.08	37.0	10.62	34.5	10.06		
	-5.0	-5.6	44.5	11.80	42.0	11.49	39.5	11.10	38.2	10.57	37.0	10.14	34.5	9.60		
	-3.0	-3.7	44.5	11.25	42.0	10.93	39.5	10.56	38.2	10.06	37.0	9.67	34.5	9.15		
	0.0	-0.7	44.5	10.42	42.0	10.10	39.5	9.76	38.2	9.30	37.0	8.96	34.5	8.46		
	3.0	2.2	44.5	9.60	42.0	9.27	39.5	8.96	38.2	8.54	37.0	8.25	34.5	7.78		
	5.0	4.1	44.5	9.05	42.0	8.72	39.5	8.42	38.2	8.04	37.0	7.78	34.5	7.32		
	7.0	6.0	44.5	8.50	42.0	8.16	39.5	7.89	38.2	7.53	37.0	7.30	34.5	6.87		
	9.0	7.9	44.5	7.68	42.0	7.37	39.5	7.12	38.2	6.80	37.0	6.60	34.5	6.20		
11.0	9.8	44.5	7.15	42.0	6.86	39.5	6.63	38.2	6.33	37.0	6.14	34.5	5.77			
13.0	11.8	44.5	6.69	42.0	6.42	39.5	6.21	38.2	5.92	37.0	5.75	34.5	5.40			
15.0	13.7	44.5	6.31	42.0	6.05	39.5	5.85	38.2	5.59	37.0	5.42	34.5	5.09			
60	-24.8	-25	34.1	14.97	34.1	15.13	33.9	15.36	32.7	14.54	31.6	13.78	29.6	13.07		
	-21.8	-22	36.5	15.20	36.1	15.36	33.9	14.54	32.7	13.78	31.6	13.07	29.6	12.38		
	-19.8	-20	38.2	15.36	36.1	14.78	33.9	14.00	32.7	13.27	31.6	12.59	29.6	11.92		
	-18.8	-19	38.2	15.07	36.1	14.49	33.9	13.73	32.7	13.02	31.6	12.35	29.6	11.69		
	-16.7	-17	38.2	14.45	36.1	13.89	33.9	13.16	32.7	12.49	31.6	11.85	29.6	11.21		
	-13.7	-15	38.2	13.58	36.1	13.02	33.9	12.35	32.7	11.73	31.6	11.14	29.6	10.52		
	-11.8	-13	38.2	13.02	36.1	12.48	33.9	11.83	32.7	11.24	31.6	10.69	29.6	10.09		
	-9.8	-11	38.2	12.44	36.1	11.90	33.9	11.29	32.7	10.74	31.6	10.21	29.6	9.63		
	-9.5	-10	38.2	12.35	36.1	11.82	33.9	11.21	32.7	10.66	31.6	10.14	29.6	9.56		
	-8.5	-9.1	38.2	12.06	36.1	11.53	33.9	10.94	32.7	10.41	31.6	9.90	29.6	9.33		
	-7.0	-7.6	38.2	11.62	36.1	11.10	33.9	10.53	32.7	10.03	31.6	9.54	29.6	8.99		
	-5.0	-5.6	38.2	11.04	36.1	10.52	33.9	9.99	32.7	9.52	31.6	9.07	29.6	8.53		
	-3.0	-3.7	38.2	10.46	36.1	9.94	33.9	9.45	32.7	9.01	31.6	8.59	29.6	8.07		
	0.0	-0.7	38.2	9.58	36.1	9.08	33.9	8.63	32.7	8.25	31.6	7.88	29.6	7.38		
	3.0	2.2	38.2	8.71	36.1	8.22	33.9	7.82	32.7	7.49	31.6	7.16	29.6	6.69		
	5.0	4.1	38.2	8.13	36.1	7.64	33.9	7.28	32.7	6.98	31.6	6.69	29.6	6.23		
	7.0	6.0	38.2	7.54	36.1	7.07	33.9	6.74	32.7	6.47	31.6	6.21	29.6	5.77		
	9.0	7.9	38.2	6.73	36.1	6.30	33.9	6.01	32.7	5.78	31.6	5.54	29.6	5.15		
11.0	9.8	38.2	6.28	36.1	5.89	33.9	5.61	32.7	5.39	31.6	5.17	29.6	4.81			
13.0	11.8	38.2	5.89	36.1	5.51	33.9	5.26	32.7	5.05	31.6	4.85	29.6	4.51			
15.0	13.7	38.2	5.56	36.1	5.21	33.9	4.97	32.7	4.77	31.6	4.58	29.6	4.26			
50	-24.8	-25	31.8	13.02	30.0	13.25	28.2	12.54	27.3	11.87	26.4	11.24	24.6	10.66		
	-21.8	-22	31.8	13.25	30.0	12.54	28.2	11.87	27.3	11.24	26.4	10.66	24.6	10.10		
	-19.8	-20	31.8	12.75	30.0	12.06	28.2	11.43	27.3	10.82	26.4	10.27	24.6	9.72		
	-18.8	-19	31.8	12.50	30.0	11.82	28.2	11.21	27.3	10.62	26.4	10.08	24.6	9.54		
	-16.7	-17	31.8	11.98	30.0	11.33	28.2	10.74	27.3	10.18	26.4	9.67	24.6	9.14		
	-13.7	-15	31.8	11.23	30.0	10.61	28.2	10.08	27.3	9.55	26.4	9.08	24.6	8.58		
	-11.8	-13	31.8	10.76	30.0	10.16	28.2	9.65	27.3	9.15	26.4	8.71	24.6	8.23		
	-9.8	-11	31.8	10.26	30.0	9.69	28.2	9.21	27.3	8.73	26.4	8.32	24.6	7.85		
	-9.5	-10	31.8	10.19	30.0	9.62	28.2	9.14	27.3	8.67	26.4	8.26	24.6	7.80		
	-8.5	-9.1	31.8	9.94	30.0	9.38	28.2	8.92	27.3	8.46	26.4	8.07	24.6	7.61		
	-7.0	-7.6	31.8	9.57	30.0	9.02	28.2	8.59	27.3	8.14	26.4	7.78	24.6	7.33		
	-5.0	-5.6	31.8	9.07	30.0	8.55	28.2	8.15	27.3	7.73	26.4	7.39	24.6	6.96		
	-3.0	-3.7	31.8	8.57	30.0	8.07	28.2	7.70	27.3	7.31	26.4	7.00	24.6	6.58		
	0.0	-0.7	31.8	7.83	30.0	7.36	28.2	7.04	27.3	6.68	26.4	6.41	24.6	6.02		
	3.0	2.2	31.8	7.08	30.0	6.65	28.2	6.37	27.3	6.05	26.4	5.83	24.6	5.46		
	5.0	4.1	31.8	6.58	30.0	6.17	28.2	5.93	27.3	5.63	26.4	5.44	24.6	5.09		
	7.0	6.0	31.8	6.08	30.0	5.70	28.2	5.49	27.3	5.21	26.4	5.05	24.6	4.71		
	9.0	7.9	31.8	5.49	30.0	5.14	28.2	4.96	27.3	4.71	26.4	4.56	24.6	4.26		
11.0	9.8	31.8	5.14	30.0	4.81	28.2	4.64	27.3	4.40	26.4	4.27	24.6	3.98			
13.0	11.8	31.8	4.83	30.0	4.52	28.2	4.35	27.3	4.14	26.4	4.01	24.6	3.74			
15.0	13.7	31.8	4.57	30.0	4.28	28.2	4.12	27.3	3.91	26.4	3.79	24.6	3.54			

**Note**

1. TC: Total Capacity(kW), PI : Power Input(kW, Comp. + Outdoor fan motor)
2. Capacity tables show the average value of conditions which may occur.
3. The heating capacity table is based on the values expressed as Max. in the specification of the outdoor unit. (When measuring the Max. heating capacity, the setting status of the indoor unit is the same as that for measuring the heating capacity of the indoor unit.)

# 7. Capacity Tables

## ◆ ARUM200LTE5

Heating Capacity (20HP)

Combination (%)	Outdoor air temp.		Indoor air temp. °C DB											
			16		18		20		21		22		24	
	°C DB	°C WB	TC	PI	TC	PI	TC	PI	TC	PI	TC	PI	TC	PI
130	-24.8	-25	39.5	21.22	39.5	21.29	39.2	21.35	39.2	21.44	39.2	21.53	38.5	21.66
	-21.8	-22	48.0	21.36	48.0	21.43	47.7	21.49	47.7	21.58	47.7	21.66	46.8	21.80
	-19.8	-20	50.7	21.45	50.7	21.52	50.3	21.58	50.3	21.67	50.3	21.75	49.4	21.89
	-18.8	-19	51.7	21.49	51.7	21.56	51.4	21.62	51.4	21.71	51.4	21.80	50.4	21.93
	-16.7	-17	54.0	21.59	54.0	21.66	53.7	21.72	53.7	21.81	53.7	21.89	52.7	22.03
	-13.7	-15	57.3	21.73	57.3	21.79	57.0	21.85	57.0	21.94	57.0	22.03	55.9	21.23
	-11.8	-13	59.2	21.81	59.2	21.88	58.8	21.94	58.8	22.03	58.8	21.49	57.9	20.72
	-9.8	-11	61.1	21.90	61.1	21.97	60.8	22.03	60.8	21.46	60.8	20.93	60.0	20.19
	-9.5	-10	61.5	21.92	61.5	21.98	61.1	21.94	61.1	21.38	61.1	20.84	60.3	20.11
	-8.5	-9.1	62.7	21.96	62.7	22.03	62.3	21.65	62.3	21.09	62.0	20.56	61.4	19.84
	-7.0	-7.6	64.5	22.03	64.5	21.61	64.1	21.22	64.1	20.66	64.1	20.14	63.0	19.44
	-5.0	-5.6	66.8	21.49	66.8	21.05	66.4	20.65	66.4	20.10	66.4	19.58	65.1	18.91
	-3.0	-3.7	69.2	20.96	69.2	20.49	68.8	20.07	68.8	19.53	68.8	19.01	67.2	18.37
	0.0	-0.7	72.7	20.16	72.7	19.66	72.3	19.20	72.3	18.68	72.3	18.17	70.4	17.57
	3.0	2.2	76.3	19.36	76.3	18.82	75.8	18.34	75.8	17.82	75.8	17.32	71.1	16.77
	5.0	4.1	78.7	18.83	78.7	18.26	78.2	17.76	78.2	17.26	76.4	16.75	71.1	16.24
	7.0	6.0	81.0	18.29	81.0	17.70	80.5	17.19	79.2	16.69	76.4	16.19	71.1	15.71
9.0	7.9	81.4	17.85	81.4	17.28	81.2	16.78	79.2	16.29	76.4	15.80	71.1	15.33	
11.0	9.8	81.4	17.58	81.4	17.01	81.2	16.52	79.2	16.03	76.4	15.56	71.1	15.09	
13.0	11.8	81.4	17.27	81.4	16.72	81.2	16.23	79.2	15.76	76.4	15.29	71.1	14.83	
15.0	13.7	81.4	16.95	81.4	16.40	81.2	15.92	79.2	15.46	76.4	15.00	71.1	14.55	
120	-24.8	-25	39.2	21.29	39.2	21.35	38.9	21.44	38.9	21.53	38.9	21.66	38.2	21.76
	-21.8	-22	47.7	21.43	47.7	21.49	47.4	21.58	47.4	21.66	47.4	21.80	46.5	21.89
	-19.8	-20	50.3	21.52	50.3	21.58	50.0	21.67	50.0	21.75	50.0	21.89	49.0	21.98
	-18.8	-19	51.4	21.56	51.4	21.62	51.1	21.71	51.1	21.80	51.1	21.93	50.1	22.03
	-16.7	-17	53.7	21.66	53.7	21.72	53.3	21.81	53.3	21.89	53.3	22.03	52.3	21.51
	-13.7	-15	56.9	21.79	56.9	21.85	56.6	21.94	56.6	22.03	56.6	21.26	55.5	20.78
	-11.8	-13	58.8	21.88	58.8	21.94	58.4	22.03	58.4	21.49	58.4	20.78	57.5	20.31
	-9.8	-11	60.7	21.97	60.7	22.03	60.3	21.44	60.3	20.92	60.3	20.27	59.6	19.82
	-9.5	-10	61.1	21.98	61.1	21.94	60.7	21.35	60.7	20.83	60.7	20.19	59.9	19.75
	-8.5	-9.1	62.2	22.03	62.2	21.62	61.9	21.05	61.9	20.55	61.9	19.94	61.0	19.50
	-7.0	-7.6	64.0	21.57	64.0	21.15	63.6	20.61	63.6	20.12	63.6	19.56	62.5	19.13
	-5.0	-5.6	66.4	20.95	66.4	20.53	65.9	20.01	65.9	19.55	65.9	19.05	64.7	18.64
	-3.0	-3.7	68.7	20.33	68.7	19.91	68.3	19.42	68.3	18.98	68.3	18.54	66.8	18.15
	0.0	-0.7	72.2	19.41	72.2	18.97	71.8	18.53	71.8	18.13	71.8	17.77	66.8	17.42
	3.0	2.2	75.8	18.48	75.8	18.03	75.3	17.64	74.2	17.28	71.9	17.01	66.8	16.68
	5.0	4.1	78.1	17.87	78.1	17.41	76.8	17.05	74.2	16.71	71.9	16.50	66.8	16.19
	7.0	6.0	80.5	17.25	79.9	16.78	76.8	16.45	74.2	16.14	71.9	15.99	66.8	15.70
9.0	7.9	80.8	16.80	79.9	16.34	76.8	16.02	74.2	15.71	71.9	15.56	66.8	15.29	
11.0	9.8	80.8	16.49	79.9	16.04	76.8	15.72	74.2	15.42	71.9	15.28	66.8	15.01	
13.0	11.8	80.8	16.15	79.9	15.72	76.8	15.41	74.2	15.11	71.9	14.97	66.8	14.70	
15.0	13.7	80.8	15.80	79.9	15.37	76.8	15.07	74.2	14.78	71.9	14.64	66.8	14.38	
110	-24.8	-25	39.0	21.35	39.0	21.44	38.7	21.53	38.7	21.66	38.7	21.76	38.0	21.80
	-21.8	-22	47.4	21.49	47.4	21.58	47.1	21.66	47.1	21.80	47.1	21.89	46.2	21.94
	-19.8	-20	50.0	21.58	50.0	21.67	49.7	21.75	49.7	21.89	49.7	21.98	48.7	22.03
	-18.8	-19	51.1	21.62	51.1	21.71	50.8	21.80	50.8	21.93	50.8	22.03	49.8	21.75
	-16.7	-17	53.4	21.72	53.4	21.81	53.0	21.89	53.0	22.03	53.0	21.47	52.0	21.18
	-13.7	-15	56.6	21.85	56.6	21.94	56.2	22.03	56.2	21.18	56.2	20.67	56.2	20.35
	-11.8	-13	58.4	21.94	58.4	22.03	58.1	21.43	58.1	20.65	58.1	20.16	58.1	19.83
	-9.8	-11	60.4	22.03	60.4	21.36	60.0	20.80	60.0	20.08	60.0	19.63	59.6	19.28
	-9.5	-10	60.7	21.92	60.7	21.25	60.4	20.71	60.4	20.00	60.4	19.55	60.1	19.20
	-8.5	-9.1	61.9	21.56	61.9	20.92	61.5	20.40	61.5	19.71	61.5	19.28	60.1	18.93
	-7.0	-7.6	63.7	21.01	63.7	20.41	63.3	19.92	63.3	19.29	63.3	18.88	60.1	18.52
	-5.0	-5.6	66.0	20.29	66.0	19.74	65.6	19.30	65.6	18.73	64.4	18.35	60.1	17.97
	-3.0	-3.7	68.3	19.57	68.3	19.07	67.9	18.67	66.6	18.16	64.4	17.81	60.1	17.42
	0.0	-0.7	71.8	18.48	71.8	18.06	68.9	17.73	66.6	17.31	64.4	17.01	60.1	16.59
	3.0	2.2	75.3	17.39	73.4	17.05	68.9	16.78	66.6	16.47	64.4	16.21	60.1	15.77
	5.0	4.1	77.7	16.67	73.4	16.38	68.9	16.16	66.6	15.90	64.4	15.68	60.1	15.22
	7.0	6.0	77.7	15.94	73.4	15.70	68.9	15.53	66.6	15.34	64.4	15.14	60.1	14.67
9.0	7.9	77.7	15.45	73.4	15.22	68.9	15.05	66.6	14.87	64.4	14.67	60.1	14.22	
11.0	9.8	77.7	15.09	73.4	14.87	68.9	14.70	66.6	14.52	64.4	14.33	60.1	13.89	
13.0	11.8	77.7	14.71	73.4	14.49	68.9	14.33	66.6	14.15	64.4	13.97	60.1	13.54	
15.0	13.7	77.7	14.30	73.4	14.08	68.9	13.93	66.6	13.76	64.4	13.58	60.1	13.16	

# 7. Capacity Tables

Heating Capacity (20HP)

Combination (%)	Outdoor air temp.		Indoor air temp. °C DB											
			16		18		20		21		22		24	
	°C DB	°C WB	TC	PI	TC	PI	TC	PI	TC	PI	TC	PI	TC	PI
100	-24.8	-25	38.8	23.35	38.8	23.18	38.6	21.35	38.6	22.74	38.6	22.56	37.8	22.47
	-21.8	-22	47.2	23.09	47.2	22.91	46.9	22.02	46.9	22.48	46.9	22.57	46.0	22.21
	-19.8	-20	49.8	22.91	49.8	22.73	49.5	22.43	49.5	22.30	49.5	22.21	48.5	22.03
	-18.8	-19	50.9	22.82	50.6	22.65	50.6	22.48	50.6	22.21	50.6	22.03	49.6	21.69
	-16.7	-17	52.8	22.64	52.8	22.46	52.8	22.57	52.5	22.03	52.5	21.33	51.5	20.98
	-13.7	-15	56.3	22.37	56.3	22.20	56.0	22.03	56.0	21.02	56.0	20.33	54.9	19.96
	-11.8	-13	58.1	22.21	57.8	22.03	57.8	21.36	57.8	20.38	57.8	19.70	54.9	19.31
	-9.8	-11	60.1	22.03	60.1	21.28	59.8	20.65	59.8	19.71	59.0	19.03	54.9	18.63
	-9.5	-10	60.4	21.91	60.4	21.16	60.1	20.54	60.1	19.61	59.0	18.94	54.9	18.53
	-8.5	-9.1	61.6	21.52	61.6	20.79	61.3	20.19	61.0	19.27	59.0	18.60	54.9	18.19
	-7.0	-7.6	64.4	20.93	64.1	20.22	63.0	19.65	61.0	18.76	59.0	18.10	54.9	17.68
	-5.0	-5.6	67.2	20.14	66.5	19.47	63.0	18.94	61.0	18.09	59.0	17.44	54.9	17.01
	-3.0	-3.7	69.1	19.36	67.0	18.72	63.0	18.24	61.0	17.42	59.0	16.77	54.9	16.33
	0.0	-0.7	71.1	18.18	67.0	17.59	63.0	17.17	61.0	16.41	59.0	15.77	54.9	15.31
	3.0	2.2	71.1	17.00	67.0	16.46	63.0	16.11	61.0	15.40	59.0	14.78	54.9	14.29
	5.0	4.1	71.1	16.22	67.0	15.70	63.0	15.40	61.0	14.73	59.0	14.11	54.9	13.61
	7.0	6.0	71.1	15.43	67.0	14.95	63.0	14.69	61.0	14.05	59.0	13.45	54.9	12.93
9.0	7.9	71.1	14.89	67.0	14.43	63.0	14.18	61.0	13.56	59.0	12.98	54.9	12.48	
11.0	9.8	71.1	14.48	67.0	14.02	63.0	13.78	61.0	13.18	59.0	12.61	54.9	12.13	
13.0	11.8	71.1	14.04	67.0	13.60	63.0	13.36	61.0	12.78	59.0	12.23	54.9	11.76	
15.0	13.7	71.1	13.57	67.0	13.14	63.0	12.91	61.0	12.36	59.0	11.82	54.9	11.37	
90	-24.8	-25	38.7	20.90	38.7	21.03	38.4	21.13	38.4	21.17	38.4	21.27	37.7	21.40
	-21.8	-22	47.0	21.03	47.0	21.17	46.7	21.27	46.7	21.31	46.7	21.40	45.8	20.49
	-19.8	-20	49.6	21.13	49.6	21.26	49.3	21.36	49.3	21.40	49.3	20.78	48.4	19.89
	-18.8	-19	50.9	21.17	50.6	21.31	50.4	21.40	50.4	21.08	50.4	20.47	49.4	19.58
	-16.7	-17	52.8	21.27	52.8	21.40	52.6	20.74	52.6	20.41	52.6	19.82	50.2	18.94
	-13.7	-15	56.3	21.40	56.3	20.42	55.8	19.80	55.8	19.46	54.1	18.89	50.2	18.04
	-11.8	-13	58.1	20.73	57.8	19.80	57.6	19.20	55.9	18.85	54.1	18.30	50.2	17.46
	-9.8	-11	60.1	20.03	60.1	19.15	57.6	18.58	55.9	18.21	54.1	17.68	50.2	16.85
	-9.5	-10	60.4	19.92	60.4	19.05	57.6	18.48	55.9	18.11	54.1	17.59	50.2	16.76
	-8.5	-9.1	61.6	19.57	61.1	18.73	57.6	18.17	55.9	17.80	54.1	17.28	50.2	16.46
	-7.0	-7.6	64.4	19.04	61.2	18.24	57.6	17.70	55.9	17.32	54.1	16.81	50.2	16.00
	-5.0	-5.6	65.1	18.33	61.2	17.59	57.6	17.07	55.9	16.68	54.1	16.19	50.2	15.40
	-3.0	-3.7	65.1	17.63	61.2	16.93	57.6	16.44	55.9	16.04	54.1	15.57	50.2	14.79
	0.0	-0.7	65.1	16.57	61.2	15.95	57.6	15.50	55.9	15.08	54.1	14.64	50.2	13.88
	3.0	2.2	65.1	15.52	61.2	14.98	57.6	14.56	55.9	14.13	54.1	13.71	50.2	12.97
	5.0	4.1	65.1	14.81	61.2	14.32	57.6	13.93	55.9	13.49	54.1	13.09	50.2	12.36
	7.0	6.0	65.1	14.11	61.2	13.67	57.6	13.30	55.9	12.85	54.1	12.47	50.2	11.76
9.0	7.9	65.1	13.44	61.2	13.03	57.6	12.68	55.9	12.24	54.1	11.88	50.2	11.20	
11.0	9.8	65.1	12.77	61.2	12.38	57.6	12.05	55.9	11.64	54.1	11.29	50.2	10.65	
13.0	11.8	65.1	12.11	61.2	11.74	57.6	11.42	55.9	11.03	54.1	10.70	50.2	10.09	
15.0	13.7	65.1	11.44	61.2	11.09	57.6	10.79	55.9	10.42	54.1	10.11	50.2	9.54	
80	-24.8	-25	38.5	18.47	38.5	18.61	38.3	18.71	38.3	18.75	38.3	18.98	37.5	18.18
	-21.8	-22	46.5	18.61	46.5	18.75	46.5	18.84	46.5	18.98	46.5	18.18	44.9	17.41
	-19.8	-20	49.1	18.70	49.1	18.84	49.1	18.98	49.1	18.41	48.2	17.64	44.9	16.89
	-18.8	-19	50.2	18.75	50.2	18.98	50.2	18.69	50.0	18.13	48.2	17.38	44.9	16.64
	-16.7	-17	51.6	18.98	51.6	18.38	51.6	18.09	50.0	17.54	48.2	16.82	44.9	16.10
	-13.7	-15	53.9	18.10	52.9	17.53	51.6	17.23	50.0	16.69	48.2	16.02	44.9	15.33
	-11.8	-13	55.3	17.54	53.7	16.99	51.6	16.69	50.0	16.16	48.2	15.51	44.9	14.84
	-9.8	-11	56.8	16.95	54.4	16.43	51.6	16.12	50.0	15.59	48.2	14.98	44.9	14.33
	-9.5	-10	57.2	16.86	54.7	16.34	51.6	16.03	50.0	15.51	48.2	14.90	44.9	14.25
	-8.5	-9.1	57.7	16.57	54.9	16.06	51.6	15.75	50.0	15.22	48.2	14.63	44.9	14.00
	-7.0	-7.6	58.3	16.13	54.9	15.63	51.6	15.32	50.0	14.80	48.2	14.23	44.9	13.61
	-5.0	-5.6	58.3	15.54	54.9	15.07	51.6	14.75	50.0	14.24	48.2	13.69	44.9	13.10
	-3.0	-3.7	58.3	14.95	54.9	14.50	51.6	14.18	50.0	13.67	48.2	13.16	44.9	12.58
	0.0	-0.7	58.3	14.07	54.9	13.65	51.6	13.32	50.0	12.83	48.2	12.36	44.9	11.81
	3.0	2.2	58.3	13.19	54.9	12.80	51.6	12.46	50.0	11.98	48.2	11.56	44.9	11.05
	5.0	4.1	58.3	12.60	54.9	12.23	51.6	11.89	50.0	11.41	48.2	11.03	44.9	10.53
	7.0	6.0	58.3	12.01	54.9	11.66	51.6	11.32	50.0	10.85	48.2	10.49	44.9	10.02
9.0	7.9	58.3	11.28	54.9	10.95	51.6	10.63	50.0	10.19	48.2	9.85	44.9	9.41	
11.0	9.8	58.3	10.47	54.9	10.17	51.6	9.87	50.0	9.45	48.2	9.14	44.9	8.73	
13.0	11.8	58.3	9.77	54.9	9.49	51.6	9.21	50.0	8.83	48.2	8.54	44.9	8.15	
15.0	13.7	58.3	9.20	54.9	8.93	51.6	8.67	50.0	8.31	48.2	8.04	44.9	7.67	

## 7. Capacity Tables

Heating Capacity (20HP)

Combination (%)	Outdoor air temp.		Indoor air temp. °C DB											
			16		18		20		21		22		24	
	°C DB	°C WB	TC	PI	TC	PI	TC	PI	TC	PI	TC	PI	TC	PI
70	-24.8	-25	38.5	18.26	38.5	18.31	38.3	18.40	38.3	18.53	38.3	17.66	37.5	16.84
	-21.8	-22	44.2	18.40	44.2	18.44	43.9	18.53	42.4	17.66	41.1	16.84	38.4	16.05
	-19.8	-20	48.0	18.49	46.7	18.53	43.9	17.92	42.4	17.08	41.1	16.30	38.4	15.52
	-18.8	-19	49.4	18.53	46.7	18.22	43.9	17.61	42.4	16.78	41.1	16.02	38.4	15.26
	-16.7	-17	49.4	17.88	46.7	17.55	43.9	16.97	42.4	16.17	41.1	15.45	38.4	14.70
	-13.7	-15	49.4	16.94	46.7	16.60	43.9	16.05	42.4	15.30	41.1	14.63	38.4	13.91
	-11.8	-13	49.4	16.34	46.7	16.00	43.9	15.47	42.4	14.74	41.1	14.11	38.4	13.41
	-9.8	-11	49.4	15.72	46.7	15.36	43.9	14.85	42.4	14.16	41.1	13.57	38.4	12.88
	-9.5	-10	49.4	15.62	46.7	15.27	43.9	14.76	42.4	14.07	41.1	13.49	38.4	12.80
	-8.5	-9.1	49.4	15.31	46.7	14.95	43.9	14.46	42.4	13.78	41.1	13.21	38.4	12.54
	-7.0	-7.6	49.4	14.84	46.7	14.48	43.9	14.00	42.4	13.35	41.1	12.80	38.4	12.14
	-5.0	-5.6	49.4	14.22	46.7	13.84	43.9	13.38	42.4	12.76	41.1	12.26	38.4	11.62
	-3.0	-3.7	49.4	13.59	46.7	13.21	43.9	12.77	42.4	12.18	41.1	11.71	38.4	11.09
	0.0	-0.7	49.4	12.65	46.7	12.26	43.9	11.85	42.4	11.31	41.1	10.89	38.4	10.30
	3.0	2.2	49.4	11.71	46.7	11.31	43.9	10.93	42.4	10.43	41.1	10.08	38.4	9.50
	5.0	4.1	49.4	11.09	46.7	10.67	43.9	10.32	42.4	9.85	41.1	9.53	38.4	8.98
	7.0	6.0	49.4	10.46	46.7	10.04	43.9	9.70	42.4	9.27	41.1	8.99	38.4	8.45
	9.0	7.9	49.4	9.45	46.7	9.07	43.9	8.76	42.4	8.37	41.1	8.11	38.4	7.63
	11.0	9.8	49.4	8.80	46.7	8.44	43.9	8.16	42.4	7.79	41.1	7.56	38.4	7.10
	13.0	11.8	49.4	8.23	46.7	7.90	43.9	7.63	42.4	7.29	41.1	7.07	38.4	6.65
15.0	13.7	49.4	7.76	46.7	7.45	43.9	7.20	42.4	6.87	41.1	6.66	38.4	6.27	
60	-24.8	-25	37.9	18.10	37.9	18.19	37.6	18.33	36.4	17.38	35.1	16.49	32.9	15.66
	-21.8	-22	40.6	18.24	40.1	18.33	37.6	17.38	36.4	16.49	35.1	15.66	32.9	14.85
	-19.8	-20	42.4	18.33	40.1	17.66	37.6	16.75	36.4	15.90	35.1	15.10	32.9	14.31
	-18.8	-19	42.4	17.99	40.1	17.33	37.6	16.44	36.4	15.61	35.1	14.82	32.9	14.04
	-16.7	-17	42.4	17.28	40.1	16.62	37.6	15.77	36.4	14.98	35.1	14.24	32.9	13.48
	-13.7	-15	42.4	16.27	40.1	15.62	37.6	14.82	36.4	14.10	35.1	13.40	32.9	12.67
	-11.8	-13	42.4	15.63	40.1	14.98	37.6	14.22	36.4	13.53	35.1	12.87	32.9	12.16
	-9.8	-11	42.4	14.95	40.1	14.31	37.6	13.59	36.4	12.94	35.1	12.32	32.9	11.62
	-9.5	-10	42.4	14.85	40.1	14.21	37.6	13.50	36.4	12.85	35.1	12.23	32.9	11.54
	-8.5	-9.1	42.4	14.51	40.1	13.88	37.6	13.18	36.4	12.56	35.1	11.96	32.9	11.27
	-7.0	-7.6	42.4	14.01	40.1	13.38	37.6	12.71	36.4	12.11	35.1	11.54	32.9	10.87
	-5.0	-5.6	42.4	13.33	40.1	12.71	37.6	12.08	36.4	11.52	35.1	10.98	32.9	10.33
	-3.0	-3.7	42.4	12.66	40.1	12.04	37.6	11.45	36.4	10.93	35.1	10.42	32.9	9.79
	0.0	-0.7	42.4	11.64	40.1	11.03	37.6	10.50	36.4	10.04	35.1	9.59	32.9	8.99
	3.0	2.2	42.4	10.63	40.1	10.03	37.6	9.55	36.4	9.15	35.1	8.75	32.9	8.18
	5.0	4.1	42.4	9.96	40.1	9.36	37.6	8.92	36.4	8.56	35.1	8.20	32.9	7.64
	7.0	6.0	42.4	9.28	40.1	8.69	37.6	8.29	36.4	7.96	35.1	7.64	32.9	7.10
	9.0	7.9	42.4	8.28	40.1	7.76	37.6	7.39	36.4	7.11	35.1	6.82	32.9	6.34
	11.0	9.8	42.4	7.73	40.1	7.24	37.6	6.90	36.4	6.64	35.1	6.37	32.9	5.92
	13.0	11.8	42.4	7.24	40.1	6.78	37.6	6.47	36.4	6.22	35.1	5.96	32.9	5.54
15.0	13.7	42.4	6.84	40.1	6.41	37.6	6.11	36.4	5.87	35.1	5.64	32.9	5.24	
50	-24.8	-25	35.4	15.62	33.4	15.75	31.4	14.93	30.4	14.16	29.3	13.43	27.3	12.75
	-21.8	-22	35.4	15.75	33.4	14.93	31.4	14.16	30.4	13.43	29.3	12.75	27.3	12.09
	-19.8	-20	35.4	15.18	33.4	14.38	31.4	13.64	30.4	12.94	29.3	12.29	27.3	11.65
	-18.8	-19	35.4	14.89	33.4	14.10	31.4	13.39	30.4	12.70	29.3	12.07	27.3	11.44
	-16.7	-17	35.4	14.29	33.4	13.53	31.4	12.85	30.4	12.18	29.3	11.59	27.3	10.98
	-13.7	-15	35.4	13.43	33.4	12.70	31.4	12.07	30.4	11.45	29.3	10.91	27.3	10.32
	-11.8	-13	35.4	12.88	33.4	12.18	31.4	11.59	30.4	10.99	29.3	10.48	27.3	9.91
	-9.8	-11	35.4	12.31	33.4	11.63	31.4	11.07	30.4	10.50	29.3	10.02	27.3	9.47
	-9.5	-10	35.4	12.22	33.4	11.55	31.4	10.99	30.4	10.43	29.3	9.96	27.3	9.40
	-8.5	-9.1	35.4	11.94	33.4	11.27	31.4	10.74	30.4	10.19	29.3	9.73	27.3	9.18
	-7.0	-7.6	35.4	11.50	33.4	10.86	31.4	10.35	30.4	9.82	29.3	9.39	27.3	8.86
	-5.0	-5.6	35.4	10.93	33.4	10.31	31.4	9.84	30.4	9.34	29.3	8.94	27.3	8.42
	-3.0	-3.7	35.4	10.36	33.4	9.76	31.4	9.32	30.4	8.85	29.3	8.48	27.3	7.98
	0.0	-0.7	35.4	9.50	33.4	8.93	31.4	8.55	30.4	8.12	29.3	7.80	27.3	7.33
	3.0	2.2	35.4	8.63	33.4	8.11	31.4	7.78	30.4	7.39	29.3	7.12	27.3	6.67
	5.0	4.1	35.4	8.06	33.4	7.56	31.4	7.27	30.4	6.90	29.3	6.67	27.3	6.23
	7.0	6.0	35.4	7.49	33.4	7.01	31.4	6.75	30.4	6.41	29.3	6.21	27.3	5.80
	9.0	7.9	35.4	6.76	33.4	6.33	31.4	6.10	30.4	5.79	29.3	5.61	27.3	5.24
	11.0	9.8	35.4	6.33	33.4	5.92	31.4	5.70	30.4	5.42	29.3	5.25	27.3	4.90
	13.0	11.8	35.4	5.94	33.4	5.56	31.4	5.36	30.4	5.09	29.3	4.93	27.3	4.60
15.0	13.7	35.4	5.62	33.4	5.26	31.4	5.07	30.4	4.81	29.3	4.67	27.3	4.35	

## Note

1. TC: Total Capacity(kW), PI : Power Input(kW, Comp. + Outdoor fan motor)
2. Capacity tables show the average value of conditions which may occur.
3. The heating capacity table is based on the values expressed as Max. in the specification of the outdoor unit. (When measuring the Max. heating capacity, the setting status of the indoor unit is the same as that for measuring the heating capacity of the indoor unit.)



# 7. Capacity Tables

## ◆ ARUM220LTE5

Heating Capacity (22HP)

Combination (%)	Outdoor air temp.		Indoor air temp. °C DB											
			16		18		20		21		22		24	
	°C DB	°C WB	TC	PI	TC	PI	TC	PI	TC	PI	TC	PI	TC	PI
130	-24.8	-25	43.4	24.18	43.4	24.26	43.2	24.33	43.2	24.44	43.2	24.54	42.3	24.70
	-21.8	-22	52.8	24.34	52.8	24.42	52.5	24.49	52.5	24.60	52.5	24.70	51.5	24.86
	-19.8	-20	55.7	24.45	55.7	24.53	55.3	24.60	55.3	24.70	55.3	24.81	54.3	24.97
	-18.8	-19	56.9	24.50	56.9	24.58	56.5	24.65	56.5	24.76	56.5	24.86	55.5	25.02
	-16.7	-17	59.4	24.61	59.4	24.69	59.0	24.76	59.0	24.87	59.0	24.97	57.9	25.13
	-13.7	-15	63.0	24.77	63.0	24.85	62.6	24.92	62.6	25.03	62.6	25.13	61.4	24.22
	-11.8	-13	65.1	24.88	65.1	24.96	64.7	25.03	64.7	25.13	64.7	24.52	63.7	23.64
	-9.8	-11	67.3	24.98	67.3	25.06	66.8	25.13	66.8	24.49	66.8	23.88	66.0	23.03
	-9.5	-10	67.7	25.00	67.7	25.08	67.2	25.03	67.2	24.39	67.2	23.78	66.4	22.94
	-8.5	-9.1	69.0	25.05	69.0	25.13	68.5	24.71	68.5	24.06	68.3	23.46	67.5	22.64
	-7.0	-7.6	70.9	25.13	70.9	24.66	70.5	24.21	70.5	23.58	70.5	22.98	69.3	22.18
	-5.0	-5.6	73.5	24.52	73.5	24.02	73.0	23.56	73.0	22.93	73.0	22.33	71.7	21.57
	-3.0	-3.7	76.1	23.92	76.1	23.38	75.6	22.90	75.6	22.28	75.6	21.69	74.0	20.96
	0.0	-0.7	80.0	23.00	80.0	22.43	79.5	21.91	79.5	21.31	79.5	20.72	77.5	20.05
	3.0	2.2	83.9	22.09	83.9	21.47	83.4	20.92	83.4	20.34	83.4	19.76	78.2	19.14
	5.0	4.1	86.5	21.48	86.5	20.83	86.0	20.27	86.0	19.69	84.0	19.12	78.2	18.53
	7.0	6.0	89.1	20.87	89.1	20.20	88.5	19.61	87.1	19.04	84.0	18.47	78.2	17.92
	9.0	7.9	89.6	20.37	89.6	19.71	89.3	19.14	87.1	18.58	84.0	18.03	78.2	17.49
	11.0	9.8	89.6	20.05	89.6	19.41	89.3	18.84	87.1	18.29	84.0	17.75	78.2	17.22
	13.0	11.8	89.6	19.71	89.6	19.07	89.3	18.52	87.1	17.98	84.0	17.44	78.2	16.92
15.0	13.7	89.6	19.33	89.6	18.71	89.3	18.17	87.1	17.64	84.0	17.11	78.2	16.60	
120	-24.8	-25	43.1	24.26	43.1	24.33	42.9	24.44	42.9	24.54	42.9	24.70	42.0	24.81
	-21.8	-22	52.4	24.42	52.4	24.49	52.1	24.60	52.1	24.70	52.1	24.86	51.1	24.97
	-19.8	-20	55.3	24.53	55.3	24.60	54.9	24.70	54.9	24.81	54.9	24.97	53.9	25.08
	-18.8	-19	56.5	24.58	56.5	24.65	56.1	24.76	56.1	24.86	56.1	25.02	55.1	25.13
	-16.7	-17	59.0	24.69	59.0	24.76	58.6	24.87	58.6	24.97	58.6	25.13	57.5	24.55
	-13.7	-15	62.6	24.85	62.6	24.92	62.2	25.03	62.2	25.13	62.2	24.26	61.0	23.71
	-11.8	-13	64.6	24.96	64.6	25.03	64.2	25.13	64.2	24.52	64.2	23.71	63.2	23.17
	-9.8	-11	66.8	25.06	66.8	25.13	66.4	24.46	66.4	23.87	66.4	23.13	65.6	22.61
	-9.5	-10	67.2	25.08	67.2	25.03	66.8	24.36	66.8	23.77	66.8	23.04	65.9	22.53
	-8.5	-9.1	68.5	25.13	68.5	24.67	68.0	24.02	68.0	23.45	68.0	22.75	67.1	22.25
	-7.0	-7.6	70.4	24.61	70.4	24.14	70.0	23.51	70.0	22.96	70.0	22.31	68.8	21.83
	-5.0	-5.6	73.0	23.90	73.0	23.42	72.5	22.83	72.5	22.31	72.5	21.73	71.1	21.27
	-3.0	-3.7	75.6	23.20	75.6	22.71	75.1	22.16	75.1	21.66	75.1	21.15	73.5	20.71
	0.0	-0.7	79.4	22.14	79.4	21.64	78.9	21.14	78.9	20.69	78.9	20.27	73.5	19.87
	3.0	2.2	83.3	21.09	83.3	20.57	82.8	20.12	81.6	19.71	79.1	19.40	73.5	19.03
	5.0	4.1	85.9	20.39	85.9	19.86	84.5	19.45	81.6	19.06	79.1	18.82	73.5	18.47
	7.0	6.0	88.5	19.68	87.9	19.15	84.5	18.77	81.6	18.41	79.1	18.24	73.5	17.91
	9.0	7.9	88.8	19.16	87.9	18.64	84.5	18.28	81.6	17.93	79.1	17.76	73.5	17.44
	11.0	9.8	88.8	18.81	87.9	18.30	84.5	17.94	81.6	17.60	79.1	17.43	73.5	17.12
	13.0	11.8	88.8	18.43	87.9	17.93	84.5	17.58	81.6	17.24	79.1	17.08	73.5	16.77
15.0	13.7	88.8	18.02	87.9	17.53	84.5	17.19	81.6	16.86	79.1	16.70	73.5	16.40	
110	-24.8	-25	42.9	24.33	42.9	24.44	42.6	24.54	42.6	24.70	42.6	24.81	41.8	24.87
	-21.8	-22	52.1	24.49	52.1	24.60	51.8	24.70	51.8	24.86	51.8	24.97	50.8	25.03
	-19.8	-20	55.0	24.60	55.0	24.70	54.7	24.81	54.7	24.97	54.7	25.08	53.6	25.13
	-18.8	-19	56.2	24.65	56.2	24.76	55.8	24.86	55.8	25.02	55.8	25.13	54.8	24.82
	-16.7	-17	58.7	24.76	58.7	24.87	58.3	24.97	58.3	25.13	58.3	24.49	57.2	24.16
	-13.7	-15	62.2	24.92	62.2	25.03	61.9	25.13	61.9	24.17	61.9	23.58	61.9	23.22
	-11.8	-13	64.3	25.03	64.3	25.13	63.9	24.45	63.9	23.56	63.9	23.00	63.9	22.63
	-9.8	-11	66.4	25.13	66.4	24.37	66.0	23.74	66.0	22.91	66.0	22.39	65.5	22.00
	-9.5	-10	66.8	25.01	66.8	24.25	66.4	23.63	66.4	22.81	66.4	22.30	66.1	21.91
	-8.5	-9.1	68.1	24.60	68.1	23.87	67.7	23.27	67.7	22.49	67.7	22.00	66.1	21.60
	-7.0	-7.6	70.0	23.98	70.0	23.29	69.6	22.73	69.6	22.01	69.6	21.54	66.1	21.13
	-5.0	-5.6	72.6	23.15	72.6	22.52	72.1	22.02	72.1	21.37	70.8	20.93	66.1	20.50
	-3.0	-3.7	75.2	22.32	75.2	21.76	74.7	21.30	73.3	20.72	70.8	20.32	66.1	19.87
	0.0	-0.7	79.0	21.08	79.0	20.60	75.8	20.22	73.3	19.75	70.8	19.41	66.1	18.93
	3.0	2.2	82.9	19.84	80.7	19.45	75.8	19.15	73.3	18.79	70.8	18.49	66.1	17.99
	5.0	4.1	85.4	19.02	80.7	18.68	75.8	18.43	73.3	18.14	70.8	17.88	66.1	17.37
	7.0	6.0	85.4	18.19	80.7	17.92	75.8	17.72	73.3	17.50	70.8	17.28	66.1	16.74
	9.0	7.9	85.4	17.63	80.7	17.36	75.8	17.17	73.3	16.96	70.8	16.74	66.1	16.23
	11.0	9.8	85.4	17.22	80.7	16.96	75.8	16.77	73.3	16.57	70.8	16.35	66.1	15.85
	13.0	11.8	85.4	16.78	80.7	16.53	75.8	16.34	73.3	16.14	70.8	15.94	66.1	15.45
15.0	13.7	85.4	16.31	80.7	16.07	75.8	15.89	73.3	15.69	70.8	15.49	66.1	15.01	

# 7. Capacity Tables

Heating Capacity (22HP)

Combination (%)	Outdoor air temp.		Indoor air temp. °C DB											
			16		18		20		21		22		24	
	°C DB	°C WB	TC	PI	TC	PI	TC	PI	TC	PI	TC	PI	TC	PI
100	-24.8	-25	42.7	26.62	42.7	26.42	42.4	24.35	42.4	25.94	42.4	25.73	41.6	25.63
	-21.8	-22	51.9	26.33	51.9	26.13	51.6	25.12	51.6	25.64	51.6	25.75	50.6	25.33
	-19.8	-20	54.8	26.13	54.8	25.93	54.4	25.59	54.4	25.44	54.4	25.34	53.4	25.13
	-18.8	-19	55.9	26.03	55.6	25.83	55.6	25.64	55.6	25.34	55.6	25.13	54.5	24.75
	-16.7	-17	58.1	25.82	58.1	25.62	58.1	25.75	57.7	25.13	57.7	24.34	56.6	23.93
	-13.7	-15	61.9	25.52	61.9	25.32	61.6	25.13	61.6	23.98	61.6	23.20	60.4	22.77
	-11.8	-13	63.9	25.33	63.6	25.13	63.6	24.37	63.6	23.25	63.6	22.48	60.4	22.04
	-9.8	-11	66.1	25.13	66.1	24.27	65.7	23.56	65.7	22.48	64.9	21.72	60.4	21.26
	-9.5	-10	66.4	25.00	66.4	24.15	66.1	23.43	66.1	22.37	64.9	21.60	60.4	21.14
	-8.5	-9.1	67.7	24.55	67.7	23.72	67.4	23.03	67.1	21.99	64.9	21.22	60.4	20.76
	-7.0	-7.6	70.8	23.88	70.5	23.07	69.3	22.42	67.1	21.41	64.9	20.65	60.4	20.18
	-5.0	-5.6	73.9	22.98	73.2	22.21	69.3	21.61	67.1	20.64	64.9	19.90	60.4	19.40
	-3.0	-3.7	76.0	22.09	73.7	21.35	69.3	20.81	67.1	19.87	64.9	19.14	60.4	18.63
	0.0	-0.7	78.2	20.74	73.7	20.06	69.3	19.59	67.1	18.72	64.9	18.00	60.4	17.47
	3.0	2.2	78.2	19.40	73.7	18.78	69.3	18.38	67.1	17.57	64.9	16.86	60.4	16.30
	5.0	4.1	78.2	18.51	73.7	17.92	69.3	17.57	67.1	16.80	64.9	16.10	60.4	15.53
	7.0	6.0	78.2	17.61	73.7	17.06	69.3	16.76	67.1	16.03	64.9	15.34	60.4	14.75
9.0	7.9	78.2	16.99	73.7	16.46	69.3	16.17	67.1	15.47	64.9	14.80	60.4	14.24	
11.0	9.8	78.2	16.52	73.7	16.00	69.3	15.72	67.1	15.04	64.9	14.39	60.4	13.84	
13.0	11.8	78.2	16.02	73.7	15.51	69.3	15.24	67.1	14.58	64.9	13.95	60.4	13.42	
15.0	13.7	78.2	15.48	73.7	15.00	69.3	14.73	67.1	14.10	64.9	13.49	60.4	12.97	
90	-24.8	-25	42.5	23.82	42.5	23.98	42.3	24.09	42.3	24.15	42.3	24.25	41.5	24.42
	-21.8	-22	51.7	23.98	51.7	24.14	51.4	24.25	51.4	24.31	51.4	24.42	50.4	23.38
	-19.8	-20	54.5	24.09	54.5	24.25	54.2	24.36	54.2	24.42	54.2	23.71	53.2	22.69
	-18.8	-19	55.9	24.14	55.6	24.30	55.4	24.42	55.4	24.05	55.4	23.35	54.3	22.34
	-16.7	-17	58.1	24.25	58.1	24.42	57.8	23.66	57.8	23.29	57.8	22.61	55.2	21.61
	-13.7	-15	61.9	24.42	61.9	23.30	61.3	22.59	61.3	22.20	59.5	21.55	55.2	20.58
	-11.8	-13	63.9	23.65	63.6	22.59	63.4	21.91	61.4	21.50	59.5	20.88	55.2	19.92
	-9.8	-11	66.1	22.85	66.1	21.85	63.4	21.19	61.4	20.78	59.5	20.17	55.2	19.23
	-9.5	-10	66.4	22.73	66.4	21.74	63.4	21.09	61.4	20.67	59.5	20.06	55.2	19.12
	-8.5	-9.1	67.7	22.32	67.3	21.36	63.4	20.73	61.4	20.30	59.5	19.71	55.2	18.78
	-7.0	-7.6	70.8	21.72	67.4	20.81	63.4	20.19	61.4	19.76	59.5	19.18	55.2	18.26
	-5.0	-5.6	71.6	20.92	67.4	20.06	63.4	19.47	61.4	19.03	59.5	18.47	55.2	17.57
	-3.0	-3.7	71.6	20.11	67.4	19.32	63.4	18.76	61.4	18.30	59.5	17.76	55.2	16.87
	0.0	-0.7	71.6	18.91	67.4	18.20	63.4	17.68	61.4	17.21	59.5	16.70	55.2	15.84
	3.0	2.2	71.6	17.70	67.4	17.09	63.4	16.61	61.4	16.12	59.5	15.64	55.2	14.80
	5.0	4.1	71.6	16.90	67.4	16.34	63.4	15.89	61.4	15.39	59.5	14.93	55.2	14.11
	7.0	6.0	71.6	16.09	67.4	15.60	63.4	15.18	61.4	14.66	59.5	14.23	55.2	13.41
9.0	7.9	71.6	15.33	67.4	14.86	63.4	14.46	61.4	13.97	59.5	13.55	55.2	12.78	
11.0	9.8	71.6	14.57	67.4	14.13	63.4	13.75	61.4	13.28	59.5	12.88	55.2	12.15	
13.0	11.8	71.6	13.82	67.4	13.39	63.4	13.03	61.4	12.59	59.5	12.21	55.2	11.52	
15.0	13.7	71.6	13.06	67.4	12.65	63.4	12.31	61.4	11.89	59.5	11.54	55.2	10.88	
80	-24.8	-25	42.4	21.05	42.4	21.22	42.1	21.33	42.1	21.38	42.1	21.65	41.3	20.74
	-21.8	-22	51.2	21.22	51.2	21.38	51.2	21.49	51.2	21.65	51.2	20.74	49.3	19.86
	-19.8	-20	54.0	21.32	54.0	21.48	54.0	21.65	54.0	21.01	53.0	20.13	49.3	19.27
	-18.8	-19	55.1	21.38	55.1	21.65	55.1	21.32	55.0	20.68	53.0	19.82	49.3	18.98
	-16.7	-17	56.7	21.65	56.7	20.97	56.7	20.64	55.0	20.01	53.0	19.18	49.3	18.37
	-13.7	-15	59.3	20.64	58.1	20.00	56.7	19.66	55.0	19.04	53.0	18.27	49.3	17.49
	-11.8	-13	60.8	20.01	59.0	19.39	56.7	19.04	55.0	18.43	53.0	17.69	49.3	16.93
	-9.8	-11	62.5	19.34	59.9	18.74	56.7	18.39	55.0	17.79	53.0	17.08	49.3	16.35
	-9.5	-10	62.9	19.24	60.2	18.64	56.7	18.29	55.0	17.69	53.0	16.99	49.3	16.26
	-8.5	-9.1	63.5	18.90	60.4	18.32	56.7	17.97	55.0	17.37	53.0	16.69	49.3	15.97
	-7.0	-7.6	64.1	18.40	60.4	17.83	56.7	17.48	55.0	16.89	53.0	16.23	49.3	15.53
	-5.0	-5.6	64.1	17.73	60.4	17.19	56.7	16.83	55.0	16.24	53.0	15.62	49.3	14.94
	-3.0	-3.7	64.1	17.06	60.4	16.54	56.7	16.17	55.0	15.60	53.0	15.02	49.3	14.36
	0.0	-0.7	64.1	16.05	60.4	15.57	56.7	15.20	55.0	14.63	53.0	14.10	49.3	13.48
	3.0	2.2	64.1	15.05	60.4	14.60	56.7	14.22	55.0	13.67	53.0	13.19	49.3	12.60
	5.0	4.1	64.1	14.38	60.4	13.96	56.7	13.57	55.0	13.02	53.0	12.58	49.3	12.02
	7.0	6.0	64.1	13.71	60.4	13.31	56.7	12.92	55.0	12.38	53.0	11.97	49.3	11.43
9.0	7.9	64.1	12.87	60.4	12.50	56.7	12.13	55.0	11.62	53.0	11.24	49.3	10.73	
11.0	9.8	64.1	11.94	60.4	11.60	56.7	11.26	55.0	10.79	53.0	10.43	49.3	9.96	
13.0	11.8	64.1	11.15	60.4	10.83	56.7	10.51	55.0	10.07	53.0	9.74	49.3	9.30	
15.0	13.7	64.1	10.50	60.4	10.19	56.7	9.89	55.0	9.48	53.0	9.17	49.3	8.75	

# 7. Capacity Tables

Heating Capacity (22HP)

Combination (%)	Outdoor air temp.		Indoor air temp. °C DB											
			16		18		20		21		22		24	
	°C DB	°C WB	TC	PI	TC	PI	TC	PI	TC	PI	TC	PI	TC	PI
70	-24.8	-25	42.4	20.82	42.4	20.87	42.1	20.98	42.1	21.14	42.1	20.15	41.3	19.21
	-21.8	-22	48.6	20.98	48.6	21.04	48.3	21.14	46.6	20.15	45.3	19.21	42.2	18.31
	-19.8	-20	52.7	21.09	51.3	21.14	48.3	20.44	46.6	19.48	45.3	18.59	42.2	17.71
	-18.8	-19	54.4	21.14	51.3	20.78	48.3	20.09	46.6	19.15	45.3	18.28	42.2	17.41
	-16.7	-17	54.4	20.39	51.3	20.02	48.3	19.36	46.6	18.45	45.3	17.63	42.2	16.77
	-13.7	-15	54.4	19.32	51.3	18.94	48.3	18.31	46.6	17.45	45.3	16.69	42.2	15.87
	-11.8	-13	54.4	18.64	51.3	18.25	48.3	17.65	46.6	16.82	45.3	16.10	42.2	15.30
	-9.8	-11	54.4	17.93	51.3	17.53	48.3	16.95	46.6	16.16	45.3	15.48	42.2	14.70
	-9.5	-10	54.4	17.82	51.3	17.42	48.3	16.84	46.6	16.06	45.3	15.39	42.2	14.61
	-8.5	-9.1	54.4	17.47	51.3	17.06	48.3	16.49	46.6	15.72	45.3	15.07	42.2	14.31
	-7.0	-7.6	54.4	16.93	51.3	16.52	48.3	15.97	46.6	15.23	45.3	14.61	42.2	13.85
	-5.0	-5.6	54.4	16.22	51.3	15.79	48.3	15.27	46.6	14.56	45.3	13.99	42.2	13.25
	-3.0	-3.7	54.4	15.50	51.3	15.07	48.3	14.57	46.6	13.90	45.3	13.36	42.2	12.65
	0.0	-0.7	54.4	14.43	51.3	13.99	48.3	13.52	46.6	12.90	45.3	12.43	42.2	11.75
	3.0	2.2	54.4	13.36	51.3	12.90	48.3	12.47	46.6	11.90	45.3	11.50	42.2	10.84
	5.0	4.1	54.4	12.65	51.3	12.18	48.3	11.77	46.6	11.24	45.3	10.87	42.2	10.24
	7.0	6.0	54.4	11.94	51.3	11.46	48.3	11.07	46.6	10.57	45.3	10.25	42.2	9.64
	9.0	7.9	54.4	10.78	51.3	10.35	48.3	10.00	46.6	9.55	45.3	9.26	42.2	8.70
	11.0	9.8	54.4	10.04	51.3	9.63	48.3	9.31	46.6	8.89	45.3	8.62	42.2	8.10
	13.0	11.8	54.4	9.39	51.3	9.01	48.3	8.71	46.6	8.32	45.3	8.06	42.2	7.58
15.0	13.7	54.4	8.85	51.3	8.50	48.3	8.21	46.6	7.84	45.3	7.60	42.2	7.15	
60	-24.8	-25	41.6	20.64	41.6	20.75	41.4	20.91	40.0	19.83	38.6	18.82	36.1	17.86
	-21.8	-22	44.6	20.80	44.1	20.91	41.4	19.83	40.0	18.82	38.6	17.86	36.1	16.94
	-19.8	-20	46.6	20.91	44.1	20.15	41.4	19.11	40.0	18.14	38.6	17.23	36.1	16.33
	-18.8	-19	46.6	20.53	44.1	19.77	41.4	18.75	40.0	17.80	38.6	16.91	36.1	16.02
	-16.7	-17	46.6	19.72	44.1	18.96	41.4	17.99	40.0	17.09	38.6	16.24	36.1	15.38
	-13.7	-15	46.6	18.56	44.1	17.82	41.4	16.91	40.0	16.08	38.6	15.29	36.1	14.46
	-11.8	-13	46.6	17.83	44.1	17.09	41.4	16.23	40.0	15.44	38.6	14.69	36.1	13.87
	-9.8	-11	46.6	17.06	44.1	16.33	41.4	15.51	40.0	14.76	38.6	14.05	36.1	13.26
	-9.5	-10	46.6	16.94	44.1	16.22	41.4	15.40	40.0	14.66	38.6	13.96	36.1	13.17
	-8.5	-9.1	46.6	16.56	44.1	15.83	41.4	15.04	40.0	14.32	38.6	13.64	36.1	12.86
	-7.0	-7.6	46.6	15.98	44.1	15.26	41.4	14.50	40.0	13.82	38.6	13.16	36.1	12.40
	-5.0	-5.6	46.6	15.21	44.1	14.50	41.4	13.78	40.0	13.14	38.6	12.53	36.1	11.79
	-3.0	-3.7	46.6	14.44	44.1	13.73	41.4	13.06	40.0	12.47	38.6	11.89	36.1	11.17
	0.0	-0.7	46.6	13.28	44.1	12.59	41.4	11.98	40.0	11.45	38.6	10.94	36.1	10.25
	3.0	2.2	46.6	12.13	44.1	11.44	41.4	10.90	40.0	10.44	38.6	9.99	36.1	9.33
	5.0	4.1	46.6	11.36	44.1	10.68	41.4	10.18	40.0	9.76	38.6	9.35	36.1	8.72
	7.0	6.0	46.6	10.59	44.1	9.92	41.4	9.45	40.0	9.09	38.6	8.72	36.1	8.11
	9.0	7.9	46.6	9.45	44.1	8.85	41.4	8.44	40.0	8.11	38.6	7.78	36.1	7.23
	11.0	9.8	46.6	8.82	44.1	8.26	41.4	7.88	40.0	7.57	38.6	7.26	36.1	6.75
	13.0	11.8	46.6	8.26	44.1	7.74	41.4	7.38	40.0	7.09	38.6	6.80	36.1	6.33
15.0	13.7	46.6	7.81	44.1	7.31	41.4	6.97	40.0	6.70	38.6	6.43	36.1	5.98	
50	-24.8	-25	38.9	17.81	36.7	17.97	34.5	17.03	33.4	16.15	32.3	15.32	30.1	14.54
	-21.8	-22	38.9	17.97	36.7	17.03	34.5	16.15	33.4	15.32	32.3	14.54	30.1	13.79
	-19.8	-20	38.9	17.32	36.7	16.40	34.5	15.56	33.4	14.76	32.3	14.02	30.1	13.30
	-18.8	-19	38.9	16.99	36.7	16.09	34.5	15.27	33.4	14.48	32.3	13.77	30.1	13.05
	-16.7	-17	38.9	16.30	36.7	15.43	34.5	14.66	33.4	13.90	32.3	13.22	30.1	12.52
	-13.7	-15	38.9	15.32	36.7	14.49	34.5	13.77	33.4	13.07	32.3	12.45	30.1	11.77
	-11.8	-13	38.9	14.70	36.7	13.89	34.5	13.22	33.4	12.54	32.3	11.95	30.1	11.30
	-9.8	-11	38.9	14.04	36.7	13.27	34.5	12.63	33.4	11.98	32.3	11.44	30.1	10.80
	-9.5	-10	38.9	13.94	36.7	13.17	34.5	12.54	33.4	11.90	32.3	11.36	30.1	10.73
	-8.5	-9.1	38.9	13.62	36.7	12.86	34.5	12.25	33.4	11.62	32.3	11.10	30.1	10.48
	-7.0	-7.6	38.9	13.13	36.7	12.39	34.5	11.81	33.4	11.21	32.3	10.71	30.1	10.10
	-5.0	-5.6	38.9	12.47	36.7	11.76	34.5	11.22	33.4	10.65	32.3	10.20	30.1	9.61
	-3.0	-3.7	38.9	11.82	36.7	11.13	34.5	10.64	33.4	10.10	32.3	9.68	30.1	9.11
	0.0	-0.7	38.9	10.83	36.7	10.19	34.5	9.76	33.4	9.26	32.3	8.90	30.1	8.36
	3.0	2.2	38.9	9.85	36.7	9.25	34.5	8.88	33.4	8.43	32.3	8.13	30.1	7.61
	5.0	4.1	38.9	9.20	36.7	8.62	34.5	8.29	33.4	7.87	32.3	7.61	30.1	7.11
	7.0	6.0	38.9	8.54	36.7	8.00	34.5	7.70	33.4	7.32	32.3	7.09	30.1	6.61
	9.0	7.9	38.9	7.71	36.7	7.22	34.5	6.96	33.4	6.61	32.3	6.40	30.1	5.97
	11.0	9.8	38.9	7.22	36.7	6.76	34.5	6.51	33.4	6.18	32.3	5.99	30.1	5.59
	13.0	11.8	38.9	6.78	36.7	6.34	34.5	6.11	33.4	5.81	32.3	5.63	30.1	5.25
15.0	13.7	38.9	6.41	36.7	6.00	34.5	5.78	33.4	5.49	32.3	5.32	30.1	4.97	

**Note**

1. TC: Total Capacity(kW), PI : Power Input(kW, Comp. + Outdoor fan motor)
2. Capacity tables show the average value of conditions which may occur.
3. The heating capacity table is based on the values expressed as Max. in the specification of the outdoor unit. (When measuring the Max. heating capacity, the setting status of the indoor unit is the same as that for measuring the heating capacity of the indoor unit.)

# 7. Capacity Tables

## ◆ ARUM240LTE5

Heating Capacity (24HP)

Combination (%)	Outdoor air temp.		Indoor air temp. °C DB											
			16		18		20		21		22		24	
	°C DB	°C WB	TC	PI	TC	PI	TC	PI	TC	PI	TC	PI	TC	PI
130	-24.8	-25	45.4	25.72	45.4	25.93	45.1	26.11	45.1	26.38	45.1	26.65	44.3	27.07
	-21.8	-22	56.0	26.13	56.0	26.34	55.6	26.52	55.6	26.80	55.6	27.07	54.5	27.48
	-19.8	-20	59.4	26.41	59.4	26.62	59.0	26.80	59.0	27.08	59.0	27.34	57.9	27.76
	-18.8	-19	60.8	26.55	60.8	26.76	60.4	26.94	60.4	27.22	60.4	27.48	59.2	27.90
	-16.7	-17	63.6	26.84	63.6	27.05	63.2	27.23	63.2	27.51	63.2	27.78	62.0	28.19
	-13.7	-15	67.6	27.26	67.6	27.47	67.2	27.65	67.2	27.93	67.2	28.19	65.9	27.17
	-11.8	-13	69.8	27.53	69.8	27.73	69.4	27.91	69.4	28.19	69.4	27.51	68.4	26.52
	-9.8	-11	72.1	27.80	72.1	28.01	71.7	28.19	71.7	27.47	71.7	26.79	71.0	25.84
	-9.5	-10	72.5	27.85	72.5	28.05	72.1	28.08	72.1	27.36	72.0	26.68	71.4	25.73
	-8.5	-9.1	73.9	27.98	73.9	28.19	73.5	27.71	73.5	26.99	73.2	26.32	72.7	25.39
	-7.0	-7.6	76.0	28.19	76.0	27.66	75.5	27.16	75.5	26.45	75.5	25.77	74.6	24.88
	-5.0	-5.6	78.8	27.51	78.8	26.94	78.3	26.42	78.3	25.72	78.3	25.05	77.2	24.20
	-3.0	-3.7	81.6	26.83	81.6	26.23	81.1	25.68	81.1	24.99	81.1	24.33	79.8	23.51
	0.0	-0.7	85.8	25.80	85.8	25.16	85.2	24.58	85.2	23.90	85.2	23.25	83.8	22.49
	3.0	2.2	90.0	24.78	90.0	24.08	89.4	23.47	89.4	22.81	89.4	22.16	83.9	21.47
	5.0	4.1	92.7	24.09	92.7	23.37	92.2	22.73	92.2	22.08	90.1	21.44	83.9	20.78
	7.0	6.0	95.5	23.41	95.5	22.65	94.9	22.00	93.4	21.36	90.1	20.72	83.9	20.10
9.0	7.9	96.0	22.85	96.0	22.11	95.7	21.47	93.4	20.85	90.1	20.23	83.9	19.62	
11.0	9.8	96.0	22.49	96.0	21.77	95.7	21.14	93.4	20.52	90.1	19.91	83.9	19.31	
13.0	11.8	96.0	22.11	96.0	21.39	95.7	20.77	93.4	20.17	90.1	19.57	83.9	18.98	
15.0	13.7	96.0	21.69	96.0	20.99	95.7	20.38	93.4	19.78	90.1	19.20	83.9	18.62	
120	-24.8	-25	45.1	25.93	45.1	26.11	44.8	26.38	44.8	26.65	44.8	27.07	44.0	27.36
	-21.8	-22	55.6	26.34	55.6	26.52	55.2	26.80	55.2	27.07	55.2	27.48	54.2	27.78
	-19.8	-20	59.0	26.62	59.0	26.80	58.6	27.08	58.6	27.34	58.6	27.76	57.5	28.05
	-18.8	-19	60.3	26.76	60.3	26.94	59.9	27.22	59.9	27.48	59.9	27.90	58.8	28.19
	-16.7	-17	63.1	27.05	63.1	27.23	62.7	27.51	62.7	27.78	62.7	28.19	61.5	27.53
	-13.7	-15	67.1	27.47	67.1	27.65	66.7	27.93	66.7	28.19	66.7	27.21	65.4	26.59
	-11.8	-13	69.3	27.73	69.3	27.91	68.9	28.19	68.9	27.50	68.9	26.59	67.9	26.00
	-9.8	-11	71.6	28.01	71.6	28.19	71.2	27.43	71.2	26.77	71.2	25.94	70.5	25.37
	-9.5	-10	72.0	28.05	72.0	28.07	71.6	27.32	71.6	26.66	71.6	25.84	70.9	25.27
	-8.5	-9.1	73.4	28.19	73.4	27.67	72.9	26.94	72.9	26.30	72.9	25.52	72.1	24.96
	-7.0	-7.6	75.5	27.60	75.5	27.07	75.0	26.37	75.0	25.75	75.0	25.03	74.1	24.49
	-5.0	-5.6	78.3	26.81	78.3	26.27	77.8	25.61	77.8	25.02	77.8	24.37	76.7	23.86
	-3.0	-3.7	81.0	26.02	81.0	25.48	80.5	24.85	80.5	24.30	80.5	23.72	78.8	23.23
	0.0	-0.7	85.2	24.84	85.2	24.28	84.6	23.71	84.6	23.20	84.6	22.74	78.8	22.29
	3.0	2.2	89.3	23.66	89.3	23.08	88.8	22.57	87.5	22.11	84.8	21.76	78.8	21.35
	5.0	4.1	92.1	22.87	92.1	22.28	90.5	21.82	87.5	21.38	84.8	21.11	78.8	20.72
	7.0	6.0	94.9	22.08	94.3	21.48	90.5	21.06	87.5	20.65	84.8	20.46	78.8	20.09
9.0	7.9	95.3	21.49	94.3	20.91	90.5	20.50	87.5	20.11	84.8	19.92	78.8	19.56	
11.0	9.8	95.3	21.10	94.3	20.53	90.5	20.12	87.5	19.74	84.8	19.55	78.8	19.20	
13.0	11.8	95.3	20.67	94.3	20.11	90.5	19.72	87.5	19.34	84.8	19.16	78.8	18.82	
15.0	13.7	95.3	20.22	94.3	19.67	90.5	19.28	87.5	18.91	84.8	18.73	78.8	18.40	
110	-24.8	-25	44.9	26.11	44.9	26.38	44.6	26.65	44.6	27.07	44.6	27.36	43.7	27.50
	-21.8	-22	55.3	26.52	55.3	26.80	54.9	27.07	54.9	27.48	54.9	27.78	53.9	27.91
	-19.8	-20	58.7	26.80	58.7	27.08	58.3	27.34	58.3	27.76	58.3	28.05	57.2	28.19
	-18.8	-19	60.0	26.94	60.0	27.22	59.6	27.48	59.6	27.90	59.6	28.19	58.5	27.84
	-16.7	-17	62.8	27.23	62.8	27.51	62.4	27.78	62.4	28.19	62.4	27.48	61.2	27.10
	-13.7	-15	66.7	27.65	66.7	27.93	66.3	28.19	66.3	27.11	66.3	26.45	66.3	26.05
	-11.8	-13	68.9	27.91	68.9	28.19	68.5	27.43	68.5	26.42	68.5	25.80	68.5	25.38
	-9.8	-11	71.2	28.19	71.2	27.33	70.8	26.63	70.8	25.70	70.8	25.12	70.5	24.68
	-9.5	-10	71.6	28.05	71.6	27.20	71.2	26.50	71.2	25.59	71.2	25.02	70.9	24.58
	-8.5	-9.1	73.0	27.59	73.0	26.77	72.6	26.10	72.6	25.23	72.6	24.67	70.9	24.22
	-7.0	-7.6	75.1	26.89	75.1	26.13	74.6	25.50	74.6	24.69	74.6	24.16	70.9	23.70
	-5.0	-5.6	77.8	25.97	77.8	25.26	77.3	24.70	77.3	23.97	75.9	23.48	70.9	22.99
	-3.0	-3.7	80.6	25.04	80.6	24.40	80.1	23.89	78.6	23.24	75.9	22.79	70.9	22.29
	0.0	-0.7	84.7	23.65	84.7	23.11	81.2	22.69	78.6	22.16	75.9	21.77	70.9	21.24
	3.0	2.2	88.8	22.26	86.6	21.82	81.2	21.48	78.6	21.08	75.9	20.74	70.9	20.18
	5.0	4.1	91.6	21.33	86.6	20.96	81.2	20.68	78.6	20.35	75.9	20.06	70.9	19.48
	7.0	6.0	91.6	20.40	86.6	20.10	81.2	19.87	78.6	19.63	75.9	19.38	70.9	18.78
9.0	7.9	91.6	19.77	86.6	19.48	81.2	19.26	78.6	19.02	75.9	18.78	70.9	18.20	
11.0	9.8	91.6	19.32	86.6	19.03	81.2	18.81	78.6	18.58	75.9	18.34	70.9	17.78	
13.0	11.8	91.6	18.82	86.6	18.54	81.2	18.33	78.6	18.11	75.9	17.88	70.9	17.33	
15.0	13.7	91.6	18.30	86.6	18.02	81.2	17.82	78.6	17.60	75.9	17.38	70.9	16.84	

# 7. Capacity Tables

Heating Capacity (24HP)

Combination (%)	Outdoor air temp.		Indoor air temp. °C DB											
			16		18		20		21		22		24	
	°C DB	°C WB	TC	PI	TC	PI	TC	PI	TC	PI	TC	PI	TC	PI
100	-24.8	-25	44.7	28.98	44.7	28.88	44.4	26.94	44.4	28.62	44.4	28.51	43.5	28.46
	-21.8	-22	55.0	28.82	55.0	28.72	54.7	27.79	54.7	28.46	54.7	28.75	53.6	28.30
	-19.8	-20	58.4	28.72	58.4	28.61	58.1	28.32	58.1	28.36	58.1	28.38	57.0	28.19
	-18.8	-19	59.7	28.67	59.4	28.56	59.4	28.46	59.4	28.30	59.4	28.19	58.2	27.76
	-16.7	-17	62.1	28.56	62.1	28.45	62.1	28.75	61.8	28.19	61.8	27.30	60.6	26.85
	-13.7	-15	66.4	28.40	66.4	28.29	66.0	28.19	66.0	26.90	66.0	26.02	64.8	25.54
	-11.8	-13	68.6	28.30	68.2	28.19	68.2	27.33	68.2	26.08	68.2	25.21	64.8	24.72
	-9.8	-11	70.8	28.19	70.8	27.23	70.5	26.42	70.5	25.22	69.5	24.36	64.8	23.85
	-9.5	-10	71.2	28.04	71.2	27.08	70.9	26.29	70.9	25.09	69.5	24.23	64.8	23.72
	-8.5	-9.1	72.6	27.54	72.6	26.60	72.3	25.83	71.9	24.66	69.5	23.81	64.8	23.28
	-7.0	-7.6	75.9	26.79	75.6	25.88	74.3	25.15	71.9	24.02	69.5	23.17	64.8	22.63
	-5.0	-5.6	79.2	25.78	78.4	24.92	74.3	24.25	71.9	23.15	69.5	22.32	64.8	21.76
	-3.0	-3.7	81.5	24.78	79.1	23.95	74.3	23.34	71.9	22.29	69.5	21.47	64.8	20.89
	0.0	-0.7	83.8	23.27	79.1	22.51	74.3	21.98	71.9	21.00	69.5	20.19	64.8	19.59
	3.0	2.2	83.8	21.76	79.1	21.06	74.3	20.62	71.9	19.71	69.5	18.91	64.8	18.29
	5.0	4.1	83.8	20.76	79.1	20.10	74.3	19.71	71.9	18.85	69.5	18.06	64.8	17.42
	7.0	6.0	83.8	19.75	79.1	19.13	74.3	18.80	71.9	17.99	69.5	17.21	64.8	16.55
	9.0	7.9	83.8	19.06	79.1	18.46	74.3	18.14	71.9	17.36	69.5	16.61	64.8	15.97
	11.0	9.8	83.8	18.53	79.1	17.95	74.3	17.64	71.9	16.87	69.5	16.14	64.8	15.53
	13.0	11.8	83.8	17.97	79.1	17.40	74.3	17.10	71.9	16.36	69.5	15.65	64.8	15.05
15.0	13.7	83.8	17.37	79.1	16.82	74.3	16.53	71.9	15.81	69.5	15.13	64.8	14.55	
90	-24.8	-25	44.5	25.72	44.5	26.13	44.2	26.43	44.2	26.56	44.2	26.84	43.4	27.26
	-21.8	-22	54.8	26.13	54.8	26.55	54.5	26.84	54.5	26.98	54.5	27.26	53.4	26.11
	-19.8	-20	58.2	26.41	58.2	26.83	57.8	27.12	57.8	27.26	57.8	26.47	56.7	25.34
	-18.8	-19	59.7	26.55	59.4	26.97	59.1	27.26	59.1	26.86	59.1	26.08	58.0	24.96
	-16.7	-17	62.1	26.84	62.1	27.26	61.9	26.43	61.9	26.01	61.9	25.26	59.2	24.15
	-13.7	-15	66.4	27.26	66.4	26.02	65.8	25.24	65.8	24.80	63.8	24.08	59.2	23.00
	-11.8	-13	68.6	26.41	68.2	25.24	67.9	24.48	65.9	24.03	63.8	23.34	59.2	22.27
	-9.8	-11	70.8	25.53	70.8	24.42	68.0	23.69	65.9	23.22	63.8	22.55	59.2	21.50
	-9.5	-10	71.2	25.39	71.2	24.29	68.0	23.57	65.9	23.10	63.8	22.43	59.2	21.38
	-8.5	-9.1	72.6	24.95	72.1	23.88	68.0	23.17	65.9	22.70	63.8	22.04	59.2	21.00
	-7.0	-7.6	75.9	24.28	72.2	23.26	68.0	22.58	65.9	22.09	63.8	21.45	59.2	20.42
	-5.0	-5.6	76.7	23.39	72.2	22.44	68.0	21.79	65.9	21.29	63.8	20.67	59.2	19.66
	-3.0	-3.7	76.7	22.50	72.2	21.62	68.0	20.99	65.9	20.48	63.8	19.88	59.2	18.89
	0.0	-0.7	76.7	21.17	72.2	20.38	68.0	19.80	65.9	19.27	63.8	18.70	59.2	17.74
	3.0	2.2	76.7	19.83	72.2	19.14	68.0	18.61	65.9	18.06	63.8	17.53	59.2	16.58
	5.0	4.1	76.7	18.94	72.2	18.32	68.0	17.82	65.9	17.25	63.8	16.74	59.2	15.81
	7.0	6.0	76.7	18.05	72.2	17.50	68.0	17.03	65.9	16.45	63.8	15.96	59.2	15.05
	9.0	7.9	76.7	17.21	72.2	16.68	68.0	16.23	65.9	15.68	63.8	15.21	59.2	14.35
	11.0	9.8	76.7	16.37	72.2	15.87	68.0	15.44	65.9	14.91	63.8	14.47	59.2	13.64
	13.0	11.8	76.7	15.53	72.2	15.05	68.0	14.65	65.9	14.15	63.8	13.73	59.2	12.94
15.0	13.7	76.7	14.69	72.2	14.24	68.0	13.85	65.9	13.38	63.8	12.98	59.2	12.24	
80	-24.8	-25	44.3	22.63	44.3	23.05	44.0	23.34	44.0	23.48	44.0	24.17	43.2	23.16
	-21.8	-22	54.2	23.05	54.2	23.46	54.2	23.75	54.2	24.17	54.2	23.16	52.9	22.18
	-19.8	-20	57.6	23.32	57.6	23.74	57.6	24.17	57.6	23.46	56.9	22.48	52.9	21.53
	-18.8	-19	58.9	23.46	58.9	24.17	58.9	23.81	58.9	23.10	56.9	22.14	52.9	21.21
	-16.7	-17	60.8	24.17	60.8	23.42	60.8	23.05	59.0	22.35	56.9	21.44	52.9	20.53
	-13.7	-15	63.6	23.06	62.3	22.34	60.8	21.97	59.0	21.28	56.9	20.42	52.9	19.55
	-11.8	-13	65.1	22.35	63.2	21.66	60.8	21.28	59.0	20.60	56.9	19.78	52.9	18.93
	-9.8	-11	66.8	21.61	64.1	20.95	60.8	20.56	59.0	19.89	56.9	19.10	52.9	18.28
	-9.5	-10	67.3	21.50	64.5	20.84	60.8	20.45	59.0	19.78	56.9	19.00	52.9	18.19
	-8.5	-9.1	68.0	21.13	64.8	20.48	60.8	20.09	59.0	19.42	56.9	18.67	52.9	17.86
	-7.0	-7.6	68.7	20.57	64.8	19.94	60.8	19.55	59.0	18.89	56.9	18.16	52.9	17.37
	-5.0	-5.6	68.7	19.83	64.8	19.23	60.8	18.82	59.0	18.17	56.9	17.48	52.9	16.72
	-3.0	-3.7	68.7	19.09	64.8	18.51	60.8	18.10	59.0	17.46	56.9	16.81	52.9	16.07
	0.0	-0.7	68.7	17.97	64.8	17.44	60.8	17.02	59.0	16.39	56.9	15.79	52.9	15.10
	3.0	2.2	68.7	16.86	64.8	16.36	60.8	15.93	59.0	15.31	56.9	14.78	52.9	14.12
	5.0	4.1	68.7	16.12	64.8	15.65	60.8	15.21	59.0	14.60	56.9	14.10	52.9	13.47
	7.0	6.0	68.7	15.38	64.8	14.93	60.8	14.49	59.0	13.89	56.9	13.43	52.9	12.82
	9.0	7.9	68.7	14.44	64.8	14.02	60.8	13.60	59.0	13.04	56.9	12.61	52.9	12.04
	11.0	9.8	68.7	13.40	64.8	13.01	60.8	12.63	59.0	12.10	56.9	11.70	52.9	11.17
	13.0	11.8	68.7	12.51	64.8	12.14	60.8	11.79	59.0	11.30	56.9	10.92	52.9	10.43
15.0	13.7	68.7	11.77	64.8	11.43	60.8	11.09	59.0	10.63	56.9	10.28	52.9	9.82	

# 7. Capacity Tables

Heating Capacity (24HP)

Combination (%)	Outdoor air temp.		Indoor air temp. °C DB													
			16		18		20		21		22		24			
	°C DB	°C WB	TC	PI	TC	PI	TC	PI	TC	PI	TC	PI	TC	PI		
70	-24.8	-25	44.3	22.77	44.3	22.91	44.0	23.19	44.0	23.61	44.0	22.50	44.0	22.50	43.2	21.46
	-21.8	-22	52.1	23.19	52.1	23.33	51.8	23.61	50.0	22.50	48.5	21.46	45.3	20.46		
	-19.8	-20	57.3	23.47	55.0	23.61	51.8	22.83	50.0	21.76	48.5	20.77	45.3	19.79		
	-18.8	-19	58.3	23.61	55.0	23.21	51.8	22.44	50.0	21.39	48.5	20.42	45.3	19.45		
	-16.7	-17	58.3	22.77	55.0	22.36	51.8	21.63	50.0	20.61	48.5	19.70	45.3	18.75		
	-13.7	-15	58.3	21.59	55.0	21.16	51.8	20.46	50.0	19.51	48.5	18.66	45.3	17.74		
	-11.8	-13	58.3	20.83	55.0	20.40	51.8	19.72	50.0	18.80	48.5	18.00	45.3	17.11		
	-9.8	-11	58.3	20.04	55.0	19.59	51.8	18.95	50.0	18.06	48.5	17.31	45.3	16.44		
	-9.5	-10	58.3	19.92	55.0	19.47	51.8	18.83	50.0	17.95	48.5	17.21	45.3	16.34		
	-8.5	-9.1	58.3	19.53	55.0	19.07	51.8	18.44	50.0	17.58	48.5	16.86	45.3	16.00		
	-7.0	-7.6	58.3	18.93	55.0	18.47	51.8	17.86	50.0	17.03	48.5	16.34	45.3	15.50		
	-5.0	-5.6	58.3	18.14	55.0	17.67	51.8	17.08	50.0	16.29	48.5	15.65	45.3	14.83		
	-3.0	-3.7	58.3	17.35	55.0	16.86	51.8	16.30	50.0	15.55	48.5	14.96	45.3	14.16		
	0.0	-0.7	58.3	16.16	55.0	15.66	51.8	15.14	50.0	14.44	48.5	13.92	45.3	13.16		
	3.0	2.2	58.3	14.97	55.0	14.46	51.8	13.97	50.0	13.34	48.5	12.88	45.3	12.15		
	5.0	4.1	58.3	14.18	55.0	13.65	51.8	13.20	50.0	12.60	48.5	12.19	45.3	11.48		
	7.0	6.0	58.3	13.39	55.0	12.85	51.8	12.42	50.0	11.86	48.5	11.50	45.3	10.81		
	9.0	7.9	58.3	12.09	55.0	11.60	51.8	11.22	50.0	10.71	48.5	10.39	45.3	9.76		
	11.0	9.8	58.3	11.26	55.0	10.80	51.8	10.44	50.0	9.97	48.5	9.67	45.3	9.09		
	13.0	11.8	58.3	10.53	55.0	10.11	51.8	9.77	50.0	9.33	48.5	9.05	45.3	8.51		
15.0	13.7	58.3	9.93	55.0	9.53	51.8	9.21	50.0	8.79	48.5	8.53	45.3	8.02			
60	-24.8	-25	44.3	22.49	44.3	22.77	44.0	23.19	42.9	22.00	41.4	20.89	38.8	19.84		
	-21.8	-22	47.7	22.91	47.3	23.19	44.4	22.00	42.9	20.89	41.4	19.84	38.8	18.83		
	-19.8	-20	50.0	23.19	47.3	22.35	44.4	21.21	42.9	20.15	41.4	19.14	38.8	18.15		
	-18.8	-19	50.0	22.77	47.3	21.93	44.4	20.81	42.9	19.77	41.4	18.79	38.8	17.81		
	-16.7	-17	50.0	21.88	47.3	21.05	44.4	19.98	42.9	18.99	41.4	18.06	38.8	17.10		
	-13.7	-15	50.0	20.61	47.3	19.80	44.4	18.80	42.9	17.88	41.4	17.01	38.8	16.09		
	-11.8	-13	50.0	19.81	47.3	19.00	44.4	18.04	42.9	17.17	41.4	16.35	38.8	15.45		
	-9.8	-11	50.0	18.97	47.3	18.16	44.4	17.25	42.9	16.43	41.4	15.65	38.8	14.77		
	-9.5	-10	50.0	18.84	47.3	18.04	44.4	17.13	42.9	16.32	41.4	15.54	38.8	14.67		
	-8.5	-9.1	50.0	18.42	47.3	17.62	44.4	16.74	42.9	15.95	41.4	15.19	38.8	14.33		
	-7.0	-7.6	50.0	17.79	47.3	16.99	44.4	16.15	42.9	15.39	41.4	14.67	38.8	13.82		
	-5.0	-5.6	50.0	16.94	47.3	16.15	44.4	15.35	42.9	14.65	41.4	13.97	38.8	13.15		
	-3.0	-3.7	50.0	16.10	47.3	15.31	44.4	14.56	42.9	13.91	41.4	13.27	38.8	12.47		
	0.0	-0.7	50.0	14.83	47.3	14.06	44.4	13.38	42.9	12.79	41.4	12.22	38.8	11.46		
	3.0	2.2	50.0	13.56	47.3	12.80	44.4	12.19	42.9	11.68	41.4	11.18	38.8	10.44		
	5.0	4.1	50.0	12.72	47.3	11.96	44.4	11.40	42.9	10.94	41.4	10.48	38.8	9.77		
	7.0	6.0	50.0	11.88	47.3	11.12	44.4	10.61	42.9	10.19	41.4	9.78	38.8	9.09		
	9.0	7.9	50.0	10.60	47.3	9.93	44.4	9.46	42.9	9.09	41.4	8.72	38.8	8.11		
	11.0	9.8	50.0	9.89	47.3	9.27	44.4	8.84	42.9	8.49	41.4	8.15	38.8	7.57		
	13.0	11.8	50.0	9.27	47.3	8.68	44.4	8.28	42.9	7.95	41.4	7.63	38.8	7.10		
15.0	13.7	50.0	8.76	47.3	8.21	44.4	7.82	42.9	7.52	41.4	7.21	38.8	6.71			
50	-24.8	-25	41.7	19.65	39.3	20.07	37.0	19.02	35.8	18.04	34.6	17.11	32.2	16.25		
	-21.8	-22	41.7	20.07	39.3	19.02	37.0	18.04	35.8	17.11	34.6	16.25	32.2	15.42		
	-19.8	-20	41.7	19.34	39.3	18.32	37.0	17.39	35.8	16.49	34.6	15.67	32.2	14.86		
	-18.8	-19	41.7	18.97	39.3	17.97	37.0	17.06	35.8	16.19	34.6	15.38	32.2	14.58		
	-16.7	-17	41.7	18.21	39.3	17.24	37.0	16.38	35.8	15.54	34.6	14.78	32.2	14.00		
	-13.7	-15	41.7	17.12	39.3	16.19	37.0	15.40	35.8	14.61	34.6	13.92	32.2	13.17		
	-11.8	-13	41.7	16.43	39.3	15.53	37.0	14.78	35.8	14.02	34.6	13.37	32.2	12.64		
	-9.8	-11	41.7	15.70	39.3	14.83	37.0	14.12	35.8	13.40	34.6	12.79	32.2	12.08		
	-9.5	-10	41.7	15.59	39.3	14.73	37.0	14.03	35.8	13.31	34.6	12.71	32.2	12.00		
	-8.5	-9.1	41.7	15.22	39.3	14.38	37.0	13.70	35.8	13.00	34.6	12.42	32.2	11.72		
	-7.0	-7.6	41.7	14.68	39.3	13.86	37.0	13.21	35.8	12.54	34.6	11.99	32.2	11.31		
	-5.0	-5.6	41.7	13.95	39.3	13.16	37.0	12.56	35.8	11.92	34.6	11.41	32.2	10.75		
	-3.0	-3.7	41.7	13.22	39.3	12.46	37.0	11.90	35.8	11.30	34.6	10.83	32.2	10.20		
	0.0	-0.7	41.7	12.13	39.3	11.41	37.0	10.92	35.8	10.37	34.6	9.97	32.2	9.36		
	3.0	2.2	41.7	11.04	39.3	10.37	37.0	9.95	35.8	9.44	34.6	9.11	32.2	8.53		
	5.0	4.1	41.7	10.31	39.3	9.67	37.0	9.29	35.8	8.83	34.6	8.53	32.2	7.98		
	7.0	6.0	41.7	9.58	39.3	8.97	37.0	8.64	35.8	8.21	34.6	7.95	32.2	7.42		
	9.0	7.9	41.7	8.65	39.3	8.10	37.0	7.80	35.8	7.41	34.6	7.18	32.2	6.70		
	11.0	9.8	41.7	8.09	39.3	7.58	37.0	7.30	35.8	6.94	34.6	6.72	32.2	6.27		
	13.0	11.8	41.7	7.60	39.3	7.12	37.0	6.85	35.8	6.51	34.6	6.31	32.2	5.89		
15.0	13.7	41.7	7.19	39.3	6.73	37.0	6.49	35.8	6.16	34.6	5.97	32.2	5.57			

**Note**

1. TC: Total Capacity(kW), PI : Power Input(kW, Comp. + Outdoor fan motor)
2. Capacity tables show the average value of conditions which may occur.
3. The heating capacity table is based on the values expressed as Max. in the specification of the outdoor unit. (When measuring the Max. heating capacity, the setting status of the indoor unit is the same as that for measuring the heating capacity of the indoor unit.)

# 7. Capacity Tables

## ◆ ARUM260LTE5

Heating Capacity (26HP)

Combination (%)	Outdoor air temp.		Indoor air temp. °C DB											
			16		18		20		21		22		24	
	°C DB	°C WB	TC	PI	TC	PI	TC	PI	TC	PI	TC	PI	TC	PI
130	-24.8	-25	46.6	26.20	46.6	26.41	46.3	26.59	46.3	26.88	46.3	27.14	45.4	27.57
	-21.8	-22	56.6	26.62	56.6	26.83	56.2	27.02	56.2	27.30	56.2	27.57	55.2	28.00
	-19.8	-20	59.7	26.90	59.7	27.12	59.3	27.30	59.3	27.58	59.3	27.85	58.2	28.28
	-18.8	-19	61.0	27.05	61.0	27.26	60.6	27.44	60.6	27.73	60.6	28.00	59.5	28.42
	-16.7	-17	63.7	27.34	63.7	27.56	63.3	27.74	63.3	28.02	63.3	28.29	62.1	28.72
	-13.7	-15	67.6	27.77	67.6	27.98	67.2	28.17	67.2	28.45	67.2	28.72	65.9	27.67
	-11.8	-13	69.8	28.04	69.8	28.25	69.4	28.43	69.4	28.72	69.4	28.02	68.3	27.01
	-9.8	-11	72.1	28.32	72.1	28.53	71.7	28.72	71.7	27.98	71.7	27.28	70.8	26.32
	-9.5	-10	72.5	28.36	72.5	28.58	72.1	28.61	72.1	27.87	72.0	27.17	71.2	26.21
	-8.5	-9.1	73.9	28.51	73.9	28.72	73.5	28.23	73.5	27.50	73.2	26.81	72.4	25.87
	-7.0	-7.6	76.0	28.72	76.0	28.17	75.5	27.67	75.5	26.94	75.5	26.25	74.3	25.34
	-5.0	-5.6	78.8	28.02	78.8	27.44	78.3	26.91	78.3	26.20	78.3	25.52	76.8	24.65
	-3.0	-3.7	81.6	27.33	81.6	26.72	81.1	26.16	81.1	25.46	81.1	24.78	79.3	23.95
	0.0	-0.7	85.8	26.28	85.8	25.62	85.2	25.04	85.2	24.35	85.2	23.68	83.1	22.91
	3.0	2.2	90.0	25.24	90.0	24.53	89.4	23.91	89.4	23.23	89.4	22.58	83.9	21.86
	5.0	4.1	92.7	24.54	92.7	23.80	92.2	23.16	92.2	22.49	90.1	21.84	83.9	21.17
	7.0	6.0	95.5	23.84	95.5	23.08	94.9	22.41	93.4	21.75	90.1	21.11	83.9	20.47
	9.0	7.9	96.0	23.28	96.0	22.52	95.7	21.87	93.4	21.23	90.1	20.60	83.9	19.98
	11.0	9.8	96.0	22.91	96.0	22.17	95.7	21.53	93.4	20.90	90.1	20.28	83.9	19.67
	13.0	11.8	96.0	22.52	96.0	21.79	95.7	21.16	93.4	20.54	90.1	19.93	83.9	19.33
15.0	13.7	96.0	22.09	96.0	21.38	95.7	20.76	93.4	20.15	90.1	19.55	83.9	18.97	
120	-24.8	-25	46.2	26.41	46.2	26.59	45.9	26.88	45.9	27.14	45.9	27.57	45.1	27.87
	-21.8	-22	56.2	26.83	56.2	27.02	55.8	27.30	55.8	27.57	55.8	28.00	54.8	28.29
	-19.8	-20	59.3	27.12	59.3	27.30	58.9	27.58	58.9	27.85	58.9	28.28	57.8	28.58
	-18.8	-19	60.6	27.26	60.6	27.44	60.2	27.73	60.2	28.00	60.2	28.42	59.0	28.72
	-16.7	-17	63.3	27.56	63.3	27.74	62.9	28.02	62.9	28.29	62.9	28.72	61.7	28.05
	-13.7	-15	67.1	27.98	67.1	28.17	66.7	28.45	66.7	28.72	66.7	27.72	65.4	27.09
	-11.8	-13	69.3	28.25	69.3	28.43	68.9	28.72	68.9	28.01	68.9	27.09	67.8	26.48
	-9.8	-11	71.6	28.53	71.6	28.72	71.2	27.94	71.2	27.27	71.2	26.42	70.3	25.84
	-9.5	-10	72.0	28.58	72.0	28.60	71.6	27.83	71.6	27.16	71.6	26.32	70.7	25.74
	-8.5	-9.1	73.4	28.72	73.4	28.19	72.9	27.44	72.9	26.79	72.9	25.99	71.9	25.42
	-7.0	-7.6	75.5	28.11	75.5	27.58	75.0	26.86	75.0	26.23	75.0	25.49	73.8	24.94
	-5.0	-5.6	78.3	27.31	78.3	26.76	77.8	26.09	77.8	25.49	77.8	24.83	76.3	24.30
	-3.0	-3.7	81.0	26.51	81.0	25.95	80.5	25.31	80.5	24.75	80.5	24.16	78.8	23.66
	0.0	-0.7	85.2	25.30	85.2	24.73	84.6	24.15	84.6	23.63	84.6	23.17	78.8	22.71
	3.0	2.2	89.3	24.10	89.3	23.51	88.8	22.99	87.5	22.52	84.8	22.17	78.8	21.75
	5.0	4.1	92.1	23.29	92.1	22.69	90.5	22.22	87.5	21.78	84.8	21.50	78.8	21.11
	7.0	6.0	94.9	22.49	94.3	21.88	90.5	21.45	87.5	21.04	84.8	20.84	78.8	20.47
	9.0	7.9	95.3	21.89	94.3	21.30	90.5	20.88	87.5	20.48	84.8	20.29	78.8	19.93
	11.0	9.8	95.3	21.49	94.3	20.91	90.5	20.50	87.5	20.11	84.8	19.92	78.8	19.56
	13.0	11.8	95.3	21.06	94.3	20.49	90.5	20.08	87.5	19.70	84.8	19.51	78.8	19.17
15.0	13.7	95.3	20.59	94.3	20.03	90.5	19.64	87.5	19.26	84.8	19.08	78.8	18.74	
110	-24.8	-25	46.0	26.59	46.0	26.88	45.7	27.14	45.7	27.57	45.7	27.87	44.8	28.01
	-21.8	-22	55.9	27.02	55.9	27.30	55.5	27.57	55.5	28.00	55.5	28.29	54.5	28.43
	-19.8	-20	59.0	27.30	59.0	27.58	58.6	27.85	58.6	28.28	58.6	28.58	57.5	28.72
	-18.8	-19	60.2	27.44	60.2	27.73	59.9	28.00	59.9	28.42	59.9	28.72	58.7	28.36
	-16.7	-17	62.9	27.74	62.9	28.02	62.5	28.29	62.5	28.72	62.5	27.99	61.3	27.61
	-13.7	-15	66.7	28.17	66.7	28.45	66.3	28.72	66.3	27.61	66.3	26.94	65.3	26.54
	-11.8	-13	68.9	28.43	68.9	28.72	68.5	27.94	68.5	26.91	68.5	26.28	68.5	25.86
	-9.8	-11	71.2	28.72	71.2	27.84	70.8	27.12	70.8	26.18	70.8	25.59	70.3	25.14
	-9.5	-10	71.6	28.58	71.6	27.71	71.2	27.00	71.2	26.07	71.2	25.48	70.9	25.03
	-8.5	-9.1	73.0	28.10	73.0	27.27	72.6	26.59	72.6	25.70	72.6	25.13	70.9	24.67
	-7.0	-7.6	75.1	27.40	75.1	26.61	74.6	25.97	74.6	25.15	74.6	24.61	70.9	24.14
	-5.0	-5.6	77.8	26.45	77.8	25.73	77.3	25.16	77.3	24.41	75.9	23.92	70.9	23.42
	-3.0	-3.7	80.6	25.51	80.6	24.86	80.1	24.34	78.6	23.68	75.9	23.22	70.9	22.71
	0.0	-0.7	84.7	24.09	84.7	23.54	81.2	23.11	78.6	22.57	75.9	22.18	70.9	21.63
	3.0	2.2	88.8	22.67	86.6	22.23	81.2	21.88	78.6	21.47	75.9	21.13	70.9	20.56
	5.0	4.1	91.6	21.73	86.6	21.35	81.2	21.06	78.6	20.73	75.9	20.44	70.9	19.84
	7.0	6.0	91.6	20.78	86.6	20.47	81.2	20.24	78.6	20.00	75.9	19.74	70.9	19.13
	9.0	7.9	91.6	20.14	86.6	19.84	81.2	19.62	78.6	19.38	75.9	19.13	70.9	18.54
	11.0	9.8	91.6	19.68	86.6	19.38	81.2	19.16	78.6	18.93	75.9	18.69	70.9	18.11
	13.0	11.8	91.6	19.17	86.6	18.89	81.2	18.67	78.6	18.45	75.9	18.21	70.9	17.65
15.0	13.7	91.6	18.64	86.6	18.36	81.2	18.15	78.6	17.93	75.9	17.70	70.9	17.16	

# 7. Capacity Tables

Heating Capacity (26HP)

Combination (%)	Outdoor air temp.		Indoor air temp. °C DB											
			16		18		20		21		22		24	
	°C DB	°C WB	TC	PI	TC	PI	TC	PI	TC	PI	TC	PI	TC	PI
100	-24.8	-25	45.8	29.52	45.8	29.41	45.5	27.44	45.5	29.15	45.5	29.04	44.6	28.99
	-21.8	-22	55.7	29.36	55.7	29.25	55.3	28.30	55.3	28.99	55.3	29.29	54.3	28.82
	-19.8	-20	58.7	29.25	58.7	29.15	58.4	28.85	58.4	28.88	58.4	28.91	57.2	28.72
	-18.8	-19	60.0	29.20	59.6	29.09	59.6	28.99	59.6	28.83	59.6	28.72	58.5	28.28
	-16.7	-17	62.3	29.09	62.3	28.98	62.3	29.29	61.9	28.72	61.9	27.81	60.7	27.35
	-13.7	-15	66.4	28.93	66.4	28.82	66.0	28.72	66.0	27.40	66.0	26.51	64.8	26.02
	-11.8	-13	68.6	28.82	68.2	28.72	68.2	27.84	68.2	26.57	68.2	25.68	64.8	25.18
	-9.8	-11	70.8	28.72	70.8	27.74	70.5	26.92	70.5	25.69	69.5	24.81	64.8	24.29
	-9.5	-10	71.2	28.56	71.2	27.59	70.9	26.78	70.9	25.56	69.5	24.68	64.8	24.16
	-8.5	-9.1	72.6	28.05	72.6	27.10	72.3	26.31	71.9	25.12	69.5	24.25	64.8	23.72
	-7.0	-7.6	75.9	27.28	75.6	26.36	74.3	25.62	71.9	24.46	69.5	23.60	64.8	23.05
	-5.0	-5.6	79.2	26.26	78.4	25.38	74.3	24.70	71.9	23.58	69.5	22.73	64.8	22.17
	-3.0	-3.7	81.5	25.24	79.1	24.40	74.3	23.77	71.9	22.71	69.5	21.87	64.8	21.28
	0.0	-0.7	83.8	23.70	79.1	22.93	74.3	22.39	71.9	21.39	69.5	20.56	64.8	19.96
	3.0	2.2	83.8	22.17	79.1	21.45	74.3	21.00	71.9	20.08	69.5	19.26	64.8	18.63
	5.0	4.1	83.8	21.14	79.1	20.47	74.3	20.07	71.9	19.20	69.5	18.40	64.8	17.74
	7.0	6.0	83.8	20.12	79.1	19.49	74.3	19.15	71.9	18.32	69.5	17.53	64.8	16.86
	9.0	7.9	83.8	19.42	79.1	18.81	74.3	18.48	71.9	17.68	69.5	16.91	64.8	16.27
	11.0	9.8	83.8	18.88	79.1	18.28	74.3	17.97	71.9	17.19	69.5	16.44	64.8	15.82
	13.0	11.8	83.8	18.30	79.1	17.73	74.3	17.42	71.9	16.66	69.5	15.94	64.8	15.33
15.0	13.7	83.8	17.69	79.1	17.13	74.3	16.84	71.9	16.11	69.5	15.41	64.8	14.82	
90	-24.8	-25	45.6	26.19	45.6	26.62	45.3	26.92	45.3	27.06	45.3	27.34	44.5	27.77
	-21.8	-22	55.4	26.62	55.4	27.04	55.1	27.34	55.1	27.48	55.1	27.77	54.0	26.59
	-19.8	-20	58.5	26.90	58.5	27.33	58.1	27.63	58.1	27.77	58.1	26.97	57.0	25.81
	-18.8	-19	60.0	27.04	59.6	27.47	59.4	27.77	59.4	27.36	59.4	26.57	58.2	25.42
	-16.7	-17	62.3	27.34	62.3	27.77	62.0	26.92	62.0	26.49	62.0	25.73	59.2	24.60
	-13.7	-15	66.4	27.77	66.4	26.51	65.8	25.71	65.8	25.26	63.8	24.53	59.2	23.42
	-11.8	-13	68.6	26.91	68.2	25.71	67.9	24.94	65.9	24.48	63.8	23.77	59.2	22.68
	-9.8	-11	70.8	26.00	70.8	24.87	68.0	24.13	65.9	23.66	63.8	22.97	59.2	21.90
	-9.5	-10	71.2	25.86	71.2	24.75	68.0	24.01	65.9	23.53	63.8	22.85	59.2	21.78
	-8.5	-9.1	72.6	25.41	72.1	24.33	68.0	23.61	65.9	23.12	63.8	22.45	59.2	21.39
	-7.0	-7.6	75.9	24.73	72.2	23.70	68.0	23.00	65.9	22.51	63.8	21.85	59.2	20.80
	-5.0	-5.6	76.7	23.83	72.2	22.86	68.0	22.19	65.9	21.68	63.8	21.05	59.2	20.02
	-3.0	-3.7	76.7	22.92	72.2	22.02	68.0	21.38	65.9	20.86	63.8	20.25	59.2	19.24
	0.0	-0.7	76.7	21.56	72.2	20.76	68.0	20.17	65.9	19.63	63.8	19.05	59.2	18.07
	3.0	2.2	76.7	20.20	72.2	19.50	68.0	18.96	65.9	18.40	63.8	17.85	59.2	16.89
	5.0	4.1	76.7	19.29	72.2	18.66	68.0	18.15	65.9	17.57	63.8	17.05	59.2	16.11
	7.0	6.0	76.7	18.39	72.2	17.82	68.0	17.34	65.9	16.75	63.8	16.25	59.2	15.33
	9.0	7.9	76.7	17.53	72.2	16.99	68.0	16.53	65.9	15.97	63.8	15.50	59.2	14.61
	11.0	9.8	76.7	16.67	72.2	16.16	68.0	15.73	65.9	15.19	63.8	14.74	59.2	13.90
	13.0	11.8	76.7	15.82	72.2	15.33	68.0	14.92	65.9	14.41	63.8	13.98	59.2	13.18
15.0	13.7	76.7	14.96	72.2	14.50	68.0	14.11	65.9	13.63	63.8	13.22	59.2	12.47	
80	-24.8	-25	45.4	23.05	45.4	23.47	45.1	23.77	45.1	23.91	45.1	24.62	44.3	23.59
	-21.8	-22	54.9	23.47	54.9	23.90	54.9	24.20	54.9	24.62	54.9	23.59	52.9	22.60
	-19.8	-20	57.9	23.76	57.9	24.18	57.9	24.62	57.9	23.89	56.9	22.90	52.9	21.93
	-18.8	-19	59.1	23.90	59.1	24.62	59.1	24.25	59.0	23.53	56.9	22.56	52.9	21.60
	-16.7	-17	60.8	24.62	60.8	23.86	60.8	23.48	59.0	22.77	56.9	21.83	52.9	20.91
	-13.7	-15	63.6	23.49	62.3	22.76	60.8	22.38	59.0	21.67	56.9	20.80	52.9	19.91
	-11.8	-13	65.2	22.77	63.3	22.07	60.8	21.68	59.0	20.98	56.9	20.15	52.9	19.29
	-9.8	-11	67.0	22.01	64.2	21.34	60.8	20.94	59.0	20.26	56.9	19.46	52.9	18.62
	-9.5	-10	67.4	21.90	64.5	21.23	60.8	20.83	59.0	20.15	56.9	19.36	52.9	18.52
	-8.5	-9.1	68.1	21.52	64.8	20.86	60.8	20.46	59.0	19.78	56.9	19.01	52.9	18.19
	-7.0	-7.6	68.7	20.95	64.8	20.32	60.8	19.91	59.0	19.24	56.9	18.50	52.9	17.70
	-5.0	-5.6	68.7	20.20	64.8	19.59	60.8	19.17	59.0	18.51	56.9	17.81	52.9	17.03
	-3.0	-3.7	68.7	19.44	64.8	18.86	60.8	18.44	59.0	17.78	56.9	17.12	52.9	16.37
	0.0	-0.7	68.7	18.31	64.8	17.76	60.8	17.33	59.0	16.69	56.9	16.09	52.9	15.38
	3.0	2.2	68.7	17.17	64.8	16.67	60.8	16.23	59.0	15.60	56.9	15.06	52.9	14.39
	5.0	4.1	68.7	16.42	64.8	15.94	60.8	15.49	59.0	14.87	56.9	14.37	52.9	13.72
	7.0	6.0	68.7	15.66	64.8	15.21	60.8	14.76	59.0	14.14	56.9	13.68	52.9	13.06
	9.0	7.9	68.7	14.71	64.8	14.28	60.8	13.86	59.0	13.28	56.9	12.84	52.9	12.26
	11.0	9.8	68.7	13.65	64.8	13.25	60.8	12.86	59.0	12.33	56.9	11.92	52.9	11.38
	13.0	11.8	68.7	12.74	64.8	12.37	60.8	12.01	59.0	11.51	56.9	11.13	52.9	10.63
15.0	13.7	68.7	11.99	64.8	11.64	60.8	11.30	59.0	10.83	56.9	10.48	52.9	10.00	



# 7. Capacity Tables

Heating Capacity (26HP)

Combination (%)	Outdoor air temp.		Indoor air temp. °C DB											
			16		18		20		21		22		24	
	°C DB	°C WB	TC	PI	TC	PI	TC	PI	TC	PI	TC	PI	TC	PI
70	-24.8	-25	45.4	23.20	45.4	23.34	45.1	23.62	45.1	24.05	45.1	22.92	44.3	21.86
	-21.8	-22	52.1	23.62	52.1	23.76	51.8	24.05	50.0	22.92	48.5	21.86	45.3	20.84
	-19.8	-20	56.5	23.90	55.0	24.05	51.8	23.25	50.0	22.16	48.5	21.16	45.3	20.15
	-18.8	-19	58.3	24.05	55.0	23.64	51.8	22.86	50.0	21.79	48.5	20.80	45.3	19.81
	-16.7	-17	58.3	23.20	55.0	22.78	51.8	22.03	50.0	21.00	48.5	20.06	45.3	19.10
	-13.7	-15	58.3	21.99	55.0	21.55	51.8	20.84	50.0	19.87	48.5	19.01	45.3	18.07
	-11.8	-13	58.3	21.22	55.0	20.78	51.8	20.09	50.0	19.15	48.5	18.34	45.3	17.43
	-9.8	-11	58.3	20.41	55.0	19.96	51.8	19.30	50.0	18.40	48.5	17.63	45.3	16.74
	-9.5	-10	58.3	20.29	55.0	19.84	51.8	19.18	50.0	18.29	48.5	17.53	45.3	16.64
	-8.5	-9.1	58.3	19.89	55.0	19.43	51.8	18.78	50.0	17.91	48.5	17.17	45.3	16.30
	-7.0	-7.6	58.3	19.29	55.0	18.81	51.8	18.19	50.0	17.35	48.5	16.65	45.3	15.79
	-5.0	-5.6	58.3	18.48	55.0	18.00	51.8	17.40	50.0	16.59	48.5	15.94	45.3	15.11
	-3.0	-3.7	58.3	17.67	55.0	17.18	51.8	16.61	50.0	15.84	48.5	15.24	45.3	14.42
	0.0	-0.7	58.3	16.46	55.0	15.95	51.8	15.42	50.0	14.71	48.5	14.18	45.3	13.40
	3.0	2.2	58.3	15.25	55.0	14.72	51.8	14.23	50.0	13.58	48.5	13.12	45.3	12.38
	5.0	4.1	58.3	14.44	55.0	13.91	51.8	13.44	50.0	12.83	48.5	12.42	45.3	11.70
	7.0	6.0	58.3	13.64	55.0	13.09	51.8	12.65	50.0	12.08	48.5	11.71	45.3	11.01
	9.0	7.9	58.3	12.32	55.0	11.82	51.8	11.42	50.0	10.91	48.5	10.58	45.3	9.95
	11.0	9.8	58.3	11.47	55.0	11.01	51.8	10.64	50.0	10.16	48.5	9.85	45.3	9.26
	13.0	11.8	58.3	10.73	55.0	10.30	51.8	9.95	50.0	9.50	48.5	9.21	45.3	8.66
15.0	13.7	58.3	10.11	55.0	9.71	51.8	9.38	50.0	8.96	48.5	8.69	45.3	8.17	
60	-24.8	-25	44.7	22.91	44.7	23.20	44.4	23.62	42.9	22.41	41.4	21.28	38.8	20.21
	-21.8	-22	47.9	23.34	47.3	23.62	44.4	22.41	42.9	21.28	41.4	20.21	38.8	19.18
	-19.8	-20	50.0	23.62	47.3	22.77	44.4	21.61	42.9	20.52	41.4	19.50	38.8	18.49
	-18.8	-19	50.0	23.19	47.3	22.34	44.4	21.20	42.9	20.14	41.4	19.14	38.8	18.14
	-16.7	-17	50.0	22.29	47.3	21.44	44.4	20.36	42.9	19.35	41.4	18.39	38.8	17.42
	-13.7	-15	50.0	21.00	47.3	20.16	44.4	19.15	42.9	18.21	41.4	17.33	38.8	16.39
	-11.8	-13	50.0	20.18	47.3	19.35	44.4	18.38	42.9	17.49	41.4	16.65	38.8	15.73
	-9.8	-11	50.0	19.32	47.3	18.50	44.4	17.57	42.9	16.74	41.4	15.94	38.8	15.05
	-9.5	-10	50.0	19.19	47.3	18.37	44.4	17.45	42.9	16.62	41.4	15.83	38.8	14.94
	-8.5	-9.1	50.0	18.76	47.3	17.95	44.4	17.05	42.9	16.25	41.4	15.48	38.8	14.60
	-7.0	-7.6	50.0	18.12	47.3	17.31	44.4	16.45	42.9	15.68	41.4	14.94	38.8	14.08
	-5.0	-5.6	50.0	17.26	47.3	16.45	44.4	15.64	42.9	14.92	41.4	14.23	38.8	13.39
	-3.0	-3.7	50.0	16.40	47.3	15.60	44.4	14.83	42.9	14.17	41.4	13.52	38.8	12.70
	0.0	-0.7	50.0	15.11	47.3	14.32	44.4	13.62	42.9	13.03	41.4	12.45	38.8	11.67
	3.0	2.2	50.0	13.82	47.3	13.04	44.4	12.42	42.9	11.90	41.4	11.38	38.8	10.64
	5.0	4.1	50.0	12.96	47.3	12.18	44.4	11.61	42.9	11.14	41.4	10.67	38.8	9.95
	7.0	6.0	50.0	12.10	47.3	11.33	44.4	10.80	42.9	10.38	41.4	9.96	38.8	9.26
	9.0	7.9	50.0	10.79	47.3	10.11	44.4	9.64	42.9	9.26	41.4	8.89	38.8	8.26
	11.0	9.8	50.0	10.08	47.3	9.44	44.4	9.00	42.9	8.65	41.4	8.30	38.8	7.72
	13.0	11.8	50.0	9.44	47.3	8.84	44.4	8.43	42.9	8.10	41.4	7.77	38.8	7.23
15.0	13.7	50.0	8.92	47.3	8.36	44.4	7.97	42.9	7.66	41.4	7.35	38.8	6.83	
50	-24.8	-25	41.7	20.01	39.3	20.44	37.0	19.37	35.8	18.38	34.6	17.43	32.2	16.55
	-21.8	-22	41.7	20.44	39.3	19.37	37.0	18.38	35.8	17.43	34.6	16.55	32.2	15.70
	-19.8	-20	41.7	19.70	39.3	18.66	37.0	17.71	35.8	16.80	34.6	15.96	32.2	15.14
	-18.8	-19	41.7	19.33	39.3	18.31	37.0	17.38	35.8	16.49	34.6	15.67	32.2	14.85
	-16.7	-17	41.7	18.55	39.3	17.56	37.0	16.68	35.8	15.83	34.6	15.05	32.2	14.26
	-13.7	-15	41.7	17.44	39.3	16.49	37.0	15.68	35.8	14.88	34.6	14.17	32.2	13.41
	-11.8	-13	41.7	16.73	39.3	15.82	37.0	15.05	35.8	14.28	34.6	13.62	32.2	12.87
	-9.8	-11	41.7	15.99	39.3	15.11	37.0	14.39	35.8	13.65	34.6	13.03	32.2	12.31
	-9.5	-10	41.7	15.88	39.3	15.00	37.0	14.29	35.8	13.56	34.6	12.94	32.2	12.22
	-8.5	-9.1	41.7	15.51	39.3	14.65	37.0	13.95	35.8	13.24	34.6	12.65	32.2	11.94
	-7.0	-7.6	41.7	14.95	39.3	14.11	37.0	13.46	35.8	12.77	34.6	12.21	32.2	11.52
	-5.0	-5.6	41.7	14.21	39.3	13.40	37.0	12.79	35.8	12.14	34.6	11.62	32.2	10.95
	-3.0	-3.7	41.7	13.47	39.3	12.69	37.0	12.13	35.8	11.51	34.6	11.04	32.2	10.39
	0.0	-0.7	41.7	12.35	39.3	11.63	37.0	11.13	35.8	10.57	34.6	10.16	32.2	9.54
	3.0	2.2	41.7	11.24	39.3	10.56	37.0	10.13	35.8	9.62	34.6	9.28	32.2	8.69
	5.0	4.1	41.7	10.50	39.3	9.85	37.0	9.47	35.8	8.99	34.6	8.69	32.2	8.12
	7.0	6.0	41.7	9.76	39.3	9.14	37.0	8.80	35.8	8.36	34.6	8.10	32.2	7.56
	9.0	7.9	41.7	8.81	39.3	8.25	37.0	7.95	35.8	7.55	34.6	7.32	32.2	6.83
	11.0	9.8	41.7	8.25	39.3	7.72	37.0	7.44	35.8	7.06	34.6	6.85	32.2	6.39
	13.0	11.8	41.7	7.74	39.3	7.25	37.0	6.98	35.8	6.63	34.6	6.43	32.2	6.00
15.0	13.7	41.7	7.33	39.3	6.86	37.0	6.61	35.8	6.28	34.6	6.08	32.2	5.67	

**Note**

1. TC: Total Capacity(kW), PI : Power Input(kW, Comp. + Outdoor fan motor)
2. Capacity tables show the average value of conditions which may occur.
3. The heating capacity table is based on the values expressed as Max. in the specification of the outdoor unit. (When measuring the Max. heating capacity, the setting status of the indoor unit is the same as that for measuring the heating capacity of the indoor unit.)

# 7. Capacity Tables

## ◆ ARUM221LTE5

Heating Capacity (22HP)

Combination (%)	Outdoor air temp.		Indoor air temp. °C DB											
			16		18		20		21		22		24	
	°C DB	°C WB	TC	PI	TC	PI	TC	PI	TC	PI	TC	PI	TC	PI
130	-24.8	-25	44.3	21.1	44.3	21.41	44.0	21.69	44.0	22.10	44.0	22.50	43.4	23.13
	-21.8	-22	53.1	21.73	53.1	22.04	52.8	22.31	52.8	22.72	52.8	23.13	52.1	23.74
	-19.8	-20	55.7	22.14	55.7	22.46	55.3	22.72	55.3	23.14	55.3	23.54	54.6	24.16
	-18.8	-19	56.9	22.36	56.9	22.66	56.5	22.94	56.5	23.35	56.5	23.74	55.7	24.37
	-16.7	-17	59.3	22.79	59.3	23.10	58.9	23.38	58.9	23.79	58.9	24.18	58.0	24.81
	-13.7	-15	62.7	23.42	62.7	23.73	62.4	24.00	62.4	24.41	62.4	24.81	61.4	23.59
	-11.8	-13	64.7	23.81	64.7	24.12	64.3	24.40	64.3	24.81	64.3	23.97	63.6	22.81
	-9.8	-11	66.7	24.22	66.7	24.54	66.2	24.81	66.2	23.89	66.2	23.08	65.5	22.00
	-9.5	-10	67.1	24.29	67.1	24.60	66.7	24.67	66.7	23.74	66.6	22.95	65.9	21.88
	-8.5	-9.1	68.6	24.50	68.6	24.81	68.2	24.17	68.2	23.28	67.6	22.50	66.9	21.47
	-7.0	-7.6	70.9	24.81	70.9	24.06	70.4	23.44	70.4	22.59	70.4	21.84	69.0	20.86
	-5.0	-5.6	73.9	23.79	73.9	23.07	73.4	22.46	73.4	21.66	73.4	20.95	71.2	20.04
	-3.0	-3.7	77.0	22.77	77.0	22.07	76.4	21.48	76.4	20.73	76.4	20.07	73.5	19.23
	0.0	-0.7	81.4	21.23	81.4	20.58	81.0	20.02	81.0	19.35	81.0	18.73	76.6	18.01
	3.0	2.2	85.9	19.70	85.9	19.08	85.4	18.55	85.4	17.96	83.9	17.40	77.9	16.79
	5.0	4.1	88.4	18.68	88.4	18.08	88.0	17.57	86.8	17.03	84.0	16.51	78.3	15.97
	7.0	6.0	89.6	17.65	89.6	17.08	89.2	16.59	87.1	16.10	84.0	15.62	78.3	15.16
9.0	7.9	89.6	16.78	89.6	16.24	89.3	15.77	87.1	15.31	84.0	14.86	78.3	14.41	
11.0	9.8	89.6	16.04	89.6	15.52	89.3	15.08	87.1	14.64	84.0	14.20	78.3	13.77	
13.0	11.8	89.6	15.26	89.6	14.77	89.3	14.34	87.1	13.92	84.0	13.51	78.3	13.11	
15.0	13.7	89.6	14.44	89.6	13.97	89.3	13.56	87.1	13.17	84.0	12.77	78.3	12.39	
120	-24.8	-25	44.0	21.41	44.0	21.69	43.7	22.10	43.7	22.50	43.7	23.13	43.1	23.56
	-21.8	-22	52.8	22.04	52.8	22.31	52.4	22.72	52.4	23.13	52.4	23.74	51.7	24.18
	-19.8	-20	55.3	22.46	55.3	22.72	55.0	23.14	55.0	23.54	55.0	24.16	54.2	24.60
	-18.8	-19	56.5	22.66	56.5	22.94	56.1	23.35	56.1	23.74	56.1	24.37	55.3	24.81
	-16.7	-17	58.9	23.10	58.9	23.38	58.5	23.79	58.5	24.18	58.5	24.81	57.6	24.03
	-13.7	-15	62.2	23.73	62.2	24.00	61.9	24.41	61.9	24.81	61.9	23.62	61.0	22.91
	-11.8	-13	64.2	24.12	64.2	24.40	63.8	24.81	63.8	23.96	63.8	22.87	63.1	22.19
	-9.8	-11	66.2	24.54	66.2	24.81	65.8	23.86	65.8	23.07	65.8	22.08	65.1	21.44
	-9.5	-10	66.7	24.60	66.7	24.65	66.3	23.72	66.3	22.94	66.3	21.96	65.5	21.33
	-8.5	-9.1	68.2	24.81	68.2	24.14	67.7	23.24	67.7	22.49	67.6	21.57	66.8	20.96
	-7.0	-7.6	70.4	24.02	70.4	23.38	70.0	22.53	70.0	21.82	69.4	20.97	68.5	20.39
	-5.0	-5.6	73.4	22.97	73.4	22.35	72.9	21.59	72.9	20.93	72.9	20.18	70.8	19.64
	-3.0	-3.7	76.4	21.92	76.4	21.33	75.9	20.63	75.9	20.04	75.9	19.39	72.4	18.89
	0.0	-0.7	80.8	20.34	80.8	19.79	80.3	19.21	80.3	18.70	78.9	18.20	73.5	17.77
	3.0	2.2	85.3	18.75	85.3	18.25	83.9	17.79	81.6	17.36	78.9	17.01	73.5	16.66
	5.0	4.1	87.8	17.70	87.3	17.23	84.5	16.83	81.6	16.47	79.1	16.22	73.5	15.91
	7.0	6.0	88.9	16.65	88.0	16.20	84.5	15.88	81.6	15.57	79.1	15.43	73.5	15.16
9.0	7.9	88.9	15.81	88.0	15.38	84.5	15.08	81.6	14.80	79.1	14.66	73.5	14.39	
11.0	9.8	88.9	15.10	88.0	14.69	84.5	14.40	81.6	14.12	79.1	13.99	73.5	13.75	
13.0	11.8	88.9	14.35	88.0	13.95	84.5	13.68	81.6	13.43	79.1	13.29	73.5	13.06	
15.0	13.7	88.9	13.55	88.0	13.18	84.5	12.93	81.6	12.68	79.1	12.56	73.5	12.33	
110	-24.8	-25	43.7	21.69	43.7	22.10	43.5	22.50	43.5	23.13	43.5	23.56	42.9	23.77
	-21.8	-22	52.5	22.31	52.5	22.72	52.2	23.13	52.2	23.74	52.2	24.18	51.5	24.40
	-19.8	-20	55.0	22.72	55.0	23.14	54.7	23.54	54.7	24.16	54.7	24.60	53.9	24.81
	-18.8	-19	56.1	22.94	56.1	23.35	55.8	23.74	55.8	24.37	55.8	24.81	55.0	24.41
	-16.7	-17	58.6	23.38	58.6	23.79	58.2	24.18	58.2	24.81	58.2	23.98	57.3	23.58
	-13.7	-15	62.0	24.00	62.0	24.41	61.5	24.81	61.5	23.55	61.5	22.79	61.5	22.39
	-11.8	-13	63.9	24.40	63.9	24.81	63.4	23.91	63.4	22.74	63.4	22.04	63.4	21.64
	-9.8	-11	65.8	24.81	65.8	23.79	65.5	22.96	65.5	21.90	65.5	21.25	64.9	20.84
	-9.5	-10	66.3	24.64	66.3	23.62	65.9	22.82	65.9	21.77	65.9	21.14	65.6	20.71
	-8.5	-9.1	67.8	24.09	67.8	23.12	67.3	22.35	67.3	21.35	67.3	20.74	66.2	20.32
	-7.0	-7.6	70.0	23.24	70.0	22.35	69.6	21.63	69.6	20.71	69.6	20.15	66.2	19.73
	-5.0	-5.6	73.0	22.12	73.0	21.32	72.5	20.68	72.5	19.87	70.8	19.35	66.2	18.93
	-3.0	-3.7	75.9	21.00	75.9	20.30	75.3	19.73	73.3	19.03	70.8	18.57	66.2	18.14
	0.0	-0.7	80.4	19.31	80.0	18.76	75.7	18.31	73.3	17.76	70.8	17.39	66.2	16.95
	3.0	2.2	84.4	17.64	80.7	17.21	75.7	16.88	73.3	16.50	70.8	16.20	66.2	15.76
	5.0	4.1	85.4	16.51	80.7	16.19	75.7	15.94	73.3	15.65	70.8	15.41	66.2	14.96
	7.0	6.0	85.4	15.39	80.7	15.16	75.7	14.99	73.3	14.80	70.8	14.61	66.2	14.16
9.0	7.9	85.4	14.56	80.7	14.34	75.7	14.18	73.3	14.01	70.8	13.83	66.2	13.40	
11.0	9.8	85.4	13.84	80.7	13.64	75.7	13.48	73.3	13.32	70.8	13.15	66.2	12.74	
13.0	11.8	85.4	13.09	80.7	12.90	75.7	12.75	73.3	12.59	70.8	12.43	66.2	12.05	
15.0	13.7	85.4	12.30	80.7	12.12	75.7	11.97	73.3	11.83	70.8	11.68	66.2	11.32	

# 7. Capacity Tables

Heating Capacity (22HP)

Combination (%)	Outdoor air temp.		Indoor air temp. °C DB											
			16		18		20		21		22		24	
	°C DB	°C WB	TC	PI	TC	PI	TC	PI	TC	PI	TC	PI	TC	PI
100	-24.8	-25	43.5	23.61	43.5	23.76	43.3	22.99	43.3	24.16	43.3	24.33	42.7	24.41
	-21.8	-22	52.2	23.85	52.2	24.01	52.0	23.71	52.0	24.40	52.0	24.84	51.2	24.65
	-19.8	-20	54.8	24.01	54.8	24.16	54.4	24.19	54.4	24.56	54.4	24.82	53.7	24.81
	-18.8	-19	55.9	24.08	55.5	24.25	55.5	24.40	55.5	24.64	55.5	24.81	54.8	24.35
	-16.7	-17	58.0	24.25	58.0	24.42	58.0	24.84	57.6	24.81	57.6	23.85	56.7	23.39
	-13.7	-15	61.6	24.50	61.6	24.65	61.3	24.81	61.3	23.39	61.3	22.48	60.5	22.01
	-11.8	-13	63.5	24.65	63.2	24.81	63.2	23.84	63.2	22.49	63.2	21.60	60.5	21.13
	-9.8	-11	65.5	24.81	65.5	23.70	65.2	22.81	65.2	21.54	64.9	20.69	60.5	20.21
	-9.5	-10	66.0	24.63	66.0	23.54	65.6	22.65	65.6	21.39	64.9	20.54	60.5	20.07
	-8.5	-9.1	67.5	24.04	67.5	22.99	67.1	22.14	67.1	20.92	64.9	20.08	60.5	19.61
	-7.0	-7.6	70.8	23.16	70.5	22.16	69.3	21.37	67.1	20.21	64.9	19.40	60.5	18.92
	-5.0	-5.6	73.9	21.98	73.2	21.06	69.3	20.34	67.1	19.26	64.9	18.48	60.5	18.00
	-3.0	-3.7	76.1	20.80	73.7	19.95	69.3	19.32	67.1	18.31	64.9	17.57	60.5	17.08
	0.0	-0.7	78.1	19.03	73.7	18.30	69.3	17.77	67.1	16.89	64.9	16.19	60.5	15.70
	3.0	2.2	78.1	17.26	73.7	16.64	69.3	16.23	67.1	15.47	64.9	14.82	60.5	14.32
	5.0	4.1	78.1	16.08	73.7	15.54	69.3	15.21	67.1	14.51	64.9	13.90	60.5	13.40
	7.0	6.0	78.1	14.90	73.7	14.43	69.3	14.18	67.1	13.56	64.9	12.98	60.5	12.48
9.0	7.9	78.1	13.86	73.7	13.42	69.3	13.18	67.1	12.62	64.9	12.08	60.5	11.61	
11.0	9.8	78.1	12.91	73.7	12.51	69.3	12.29	67.1	11.76	64.9	11.26	60.5	10.82	
13.0	11.8	78.1	11.93	73.7	11.55	69.3	11.35	67.1	10.86	64.9	10.39	60.5	9.99	
15.0	13.7	78.1	10.90	73.7	10.55	69.3	10.37	67.1	9.92	64.9	9.49	60.5	9.13	
90	-24.8	-25	43.3	21.23	43.3	21.86	43.1	22.30	43.1	22.50	43.1	22.92	42.5	23.55
	-21.8	-22	52.0	21.86	52.0	22.49	51.8	22.92	51.8	23.13	51.8	23.55	51.0	22.39
	-19.8	-20	54.6	22.28	54.6	22.90	54.2	23.33	54.2	23.55	54.2	22.75	53.5	21.63
	-18.8	-19	55.9	22.49	55.5	23.11	55.3	23.55	55.3	23.13	55.3	22.35	54.5	21.25
	-16.7	-17	58.0	22.92	58.0	23.55	57.7	22.67	57.7	22.26	57.7	21.51	55.2	20.44
	-13.7	-15	61.6	23.55	61.6	22.23	61.1	21.43	60.9	21.01	59.4	20.31	55.2	19.29
	-11.8	-13	63.5	22.63	63.2	21.41	62.9	20.64	61.4	20.23	59.4	19.55	55.2	18.56
	-9.8	-11	65.5	21.68	65.5	20.54	63.4	19.82	61.4	19.39	59.4	18.76	55.2	17.79
	-9.5	-10	66.0	21.53	66.0	20.40	63.4	19.69	61.4	19.26	59.4	18.63	55.2	17.68
	-8.5	-9.1	67.5	21.05	66.9	19.97	63.4	19.27	61.4	18.84	59.4	18.23	55.2	17.29
	-7.0	-7.6	70.8	20.33	67.3	19.31	63.4	18.65	61.4	18.22	59.4	17.63	55.2	16.72
	-5.0	-5.6	71.5	19.37	67.3	18.43	63.4	17.82	61.4	17.40	59.4	16.83	55.2	15.96
	-3.0	-3.7	71.5	18.42	67.3	17.57	63.4	16.99	61.4	16.56	59.4	16.03	55.2	15.18
	0.0	-0.7	71.5	16.98	67.3	16.25	63.4	15.75	61.4	15.32	59.4	14.84	55.2	14.03
	3.0	2.2	71.5	15.53	67.3	14.94	63.4	14.50	61.4	14.07	59.4	13.64	55.2	12.89
	5.0	4.1	71.5	14.57	67.3	14.07	63.4	13.67	61.4	13.23	59.4	12.84	55.2	12.11
	7.0	6.0	71.5	13.61	67.3	13.20	63.4	12.84	61.4	12.41	59.4	12.03	55.2	11.35
9.0	7.9	71.5	12.74	67.3	12.34	63.4	12.01	61.4	11.60	59.4	11.26	55.2	10.62	
11.0	9.8	71.5	11.86	67.3	11.50	63.4	11.18	61.4	10.80	59.4	10.48	55.2	9.88	
13.0	11.8	71.5	10.98	67.3	10.64	63.4	10.35	61.4	10.00	59.4	9.71	55.2	9.15	
15.0	13.7	71.5	10.10	67.3	9.78	63.4	9.52	61.4	9.19	59.4	8.92	55.2	8.42	
80	-24.8	-25	43.2	18.57	43.2	19.19	42.9	19.63	42.9	19.84	42.9	20.88	42.3	19.87
	-21.8	-22	51.5	19.19	51.5	19.82	51.5	20.26	51.5	20.88	51.5	19.87	49.3	18.91
	-19.8	-20	54.0	19.61	54.0	20.23	54.0	20.88	53.7	20.16	52.8	19.19	49.3	18.27
	-18.8	-19	55.1	19.82	55.1	20.88	55.1	20.50	54.4	19.79	53.0	18.85	49.3	17.94
	-16.7	-17	56.7	20.88	56.7	20.10	56.7	19.73	55.0	19.04	53.0	18.14	49.3	17.27
	-13.7	-15	59.3	19.71	58.1	18.98	56.7	18.62	55.0	17.95	53.0	17.13	49.3	16.31
	-11.8	-13	61.0	18.96	59.2	18.27	56.7	17.91	55.0	17.26	53.0	16.49	49.3	15.70
	-9.8	-11	62.6	18.17	60.0	17.52	56.7	17.16	55.0	16.55	53.0	15.81	49.3	15.06
	-9.5	-10	63.0	18.06	60.2	17.41	56.7	17.05	55.0	16.44	53.0	15.71	49.3	14.96
	-8.5	-9.1	63.6	17.67	60.5	17.04	56.7	16.68	55.0	16.08	53.0	15.36	49.3	14.64
	-7.0	-7.6	64.1	17.08	60.5	16.48	56.7	16.12	55.0	15.53	53.0	14.87	49.3	14.16
	-5.0	-5.6	64.1	16.30	60.5	15.74	56.7	15.39	55.0	14.81	53.0	14.18	49.3	13.52
	-3.0	-3.7	64.1	15.51	60.5	14.99	56.7	14.64	55.0	14.09	53.0	13.51	49.3	12.87
	0.0	-0.7	64.1	14.34	60.5	13.87	56.7	13.53	55.0	13.00	53.0	12.49	49.3	11.91
	3.0	2.2	64.1	13.16	60.5	12.75	56.7	12.41	55.0	11.91	53.0	11.48	49.3	10.95
	5.0	4.1	64.1	12.38	60.5	12.01	56.7	11.67	55.0	11.20	53.0	10.80	49.3	10.31
	7.0	6.0	64.1	11.60	60.5	11.26	56.7	10.93	55.0	10.47	53.0	10.13	49.3	9.67
9.0	7.9	64.1	10.89	60.5	10.57	56.7	10.26	55.0	9.84	53.0	9.51	49.3	9.08	
11.0	9.8	64.1	10.11	60.5	9.82	56.7	9.53	55.0	9.13	53.0	8.83	49.3	8.43	
13.0	11.8	64.1	9.44	60.5	9.16	56.7	8.89	55.0	8.52	53.0	8.24	49.3	7.86	
15.0	13.7	64.1	8.88	60.5	8.62	56.7	8.36	55.0	8.02	53.0	7.76	49.3	7.40	

# 7. Capacity Tables

Heating Capacity (22HP)

Combination (%)	Outdoor air temp.		Indoor air temp. °C DB											
			16		18		20		21		22		24	
	°C DB	°C WB	TC	PI	TC	PI	TC	PI	TC	PI	TC	PI	TC	PI
70	-24.8	-25	43.2	18.99	43.2	19.19	42.9	19.61	42.9	20.24	42.9	19.18	42.2	18.18
	-21.8	-22	48.6	19.61	48.6	19.82	48.2	20.24	46.6	19.18	45.3	18.18	42.2	17.23
	-19.8	-20	52.2	20.04	51.3	20.24	48.2	19.49	46.6	18.47	45.3	17.52	42.2	16.61
	-18.8	-19	53.7	20.24	51.3	19.84	48.2	19.11	46.6	18.11	45.3	17.19	42.2	16.29
	-16.7	-17	54.3	19.41	51.3	19.01	48.2	18.32	46.6	17.37	45.3	16.50	42.2	15.63
	-13.7	-15	54.3	18.23	51.3	17.84	48.2	17.18	46.6	16.29	45.3	15.51	42.2	14.68
	-11.8	-13	54.3	17.48	51.3	17.09	48.2	16.47	46.6	15.62	45.3	14.88	42.2	14.08
	-9.8	-11	54.3	16.70	51.3	16.31	48.2	15.71	46.6	14.91	45.3	14.22	42.2	13.45
	-9.5	-10	54.3	16.58	51.3	16.18	48.2	15.60	46.6	14.81	45.3	14.12	42.2	13.36
	-8.5	-9.1	54.3	16.19	51.3	15.79	48.2	15.22	46.6	14.45	45.3	13.79	42.2	13.05
	-7.0	-7.6	54.3	15.60	51.3	15.21	48.2	14.65	46.6	13.92	45.3	13.30	42.2	12.57
	-5.0	-5.6	54.3	14.81	51.3	14.42	48.2	13.90	46.6	13.20	45.3	12.63	42.2	11.94
	-3.0	-3.7	54.3	14.03	51.3	13.63	48.2	13.15	46.6	12.49	45.3	11.97	42.2	11.30
	0.0	-0.7	54.3	12.85	51.3	12.45	48.2	12.01	46.6	11.43	45.3	10.99	42.2	10.36
	3.0	2.2	54.3	11.67	51.3	11.26	48.2	10.88	46.6	10.37	45.3	10.00	42.2	9.41
	5.0	4.1	54.3	10.89	51.3	10.47	48.2	10.12	46.6	9.66	45.3	9.33	42.2	8.79
	7.0	6.0	54.3	10.10	51.3	9.70	48.2	9.37	46.6	8.94	45.3	8.67	42.2	8.15
9.0	7.9	54.3	9.12	51.3	8.75	48.2	8.46	46.6	8.07	45.3	7.83	42.2	7.36	
11.0	9.8	54.3	8.49	51.3	8.15	48.2	7.88	46.6	7.52	45.3	7.29	42.2	6.85	
13.0	11.8	54.3	7.95	51.3	7.62	48.2	7.37	46.6	7.04	45.3	6.82	42.2	6.42	
15.0	13.7	54.3	7.49	51.3	7.19	48.2	6.95	46.6	6.63	45.3	6.44	42.2	6.05	
60	-24.8	-25	41.6	18.57	41.6	18.99	41.4	19.61	40.0	18.52	38.7	17.50	36.1	16.54
	-21.8	-22	44.6	19.19	44.2	19.61	41.4	18.52	40.0	17.50	38.7	16.54	36.1	15.63
	-19.8	-20	46.6	19.61	44.2	18.84	41.4	17.79	40.0	16.82	38.7	15.90	36.1	15.02
	-18.8	-19	46.6	19.22	44.2	18.45	41.4	17.42	40.0	16.47	38.7	15.59	36.1	14.71
	-16.7	-17	46.6	18.39	44.2	17.62	41.4	16.66	40.0	15.76	38.7	14.92	36.1	14.07
	-13.7	-15	46.6	17.19	44.2	16.46	41.4	15.56	40.0	14.74	38.7	13.97	36.1	13.16
	-11.8	-13	46.6	16.44	44.2	15.72	41.4	14.86	40.0	14.09	38.7	13.36	36.1	12.59
	-9.8	-11	46.6	15.64	44.2	14.94	41.4	14.14	40.0	13.41	38.7	12.72	36.1	11.97
	-9.5	-10	46.6	15.52	44.2	14.82	41.4	14.03	40.0	13.30	38.7	12.63	36.1	11.88
	-8.5	-9.1	46.6	15.12	44.2	14.44	41.4	13.66	40.0	12.97	38.7	12.30	36.1	11.58
	-7.0	-7.6	46.6	14.53	44.2	13.85	41.4	13.11	40.0	12.46	38.7	11.83	36.1	11.13
	-5.0	-5.6	46.6	13.73	44.2	13.07	41.4	12.39	40.0	11.78	38.7	11.20	36.1	10.51
	-3.0	-3.7	46.6	12.93	44.2	12.29	41.4	11.65	40.0	11.09	38.7	10.56	36.1	9.90
	0.0	-0.7	46.6	11.74	44.2	11.12	41.4	10.56	40.0	10.07	38.7	9.60	36.1	8.99
	3.0	2.2	46.6	10.55	44.2	9.95	41.4	9.46	40.0	9.05	38.7	8.65	36.1	8.08
	5.0	4.1	46.6	9.76	44.2	9.17	41.4	8.73	40.0	8.37	38.7	8.01	36.1	7.47
	7.0	6.0	46.6	8.96	44.2	8.39	41.4	8.00	40.0	7.69	38.7	7.38	36.1	6.85
9.0	7.9	46.6	8.00	44.2	7.49	41.4	7.14	40.0	6.86	38.7	6.58	36.1	6.11	
11.0	9.8	46.6	7.47	44.2	6.99	41.4	6.66	40.0	6.40	38.7	6.15	36.1	5.72	
13.0	11.8	46.6	6.99	44.2	6.54	41.4	6.25	40.0	6.00	38.7	5.75	36.1	5.35	
15.0	13.7	46.6	6.61	44.2	6.19	41.4	5.90	40.0	5.67	38.7	5.44	36.1	5.06	
50	-24.8	-25	38.9	16.71	36.7	17.33	34.5	16.34	33.4	15.41	32.3	14.54	30.1	13.74
	-21.8	-22	38.9	17.33	36.7	16.34	34.5	15.41	33.4	14.54	32.3	13.74	30.1	12.97
	-19.8	-20	38.9	16.63	36.7	15.67	34.5	14.79	33.4	13.96	32.3	13.20	30.1	12.45
	-18.8	-19	38.9	16.28	36.7	15.34	34.5	14.49	33.4	13.67	32.3	12.93	30.1	12.20
	-16.7	-17	38.9	15.55	36.7	14.65	34.5	13.84	33.4	13.06	32.3	12.36	30.1	11.66
	-13.7	-15	38.9	14.50	36.7	13.64	34.5	12.91	33.4	12.19	32.3	11.55	30.1	10.89
	-11.8	-13	38.9	13.83	36.7	13.01	34.5	12.32	33.4	11.64	32.3	11.05	30.1	10.41
	-9.8	-11	38.9	13.13	36.7	12.35	34.5	11.70	33.4	11.06	32.3	10.51	30.1	9.89
	-9.5	-10	38.9	13.02	36.7	12.25	34.5	11.61	33.4	10.97	32.3	10.44	30.1	9.82
	-8.5	-9.1	38.9	12.66	36.7	11.91	34.5	11.31	33.4	10.69	32.3	10.17	30.1	9.57
	-7.0	-7.6	38.9	12.14	36.7	11.42	34.5	10.84	33.4	10.25	32.3	9.76	30.1	9.18
	-5.0	-5.6	38.9	11.43	36.7	10.76	34.5	10.23	33.4	9.67	32.3	9.22	30.1	8.67
	-3.0	-3.7	38.9	10.73	36.7	10.09	34.5	9.60	33.4	9.09	32.3	8.68	30.1	8.16
	0.0	-0.7	38.9	9.68	36.7	9.09	34.5	8.68	33.4	8.22	32.3	7.88	30.1	7.39
	3.0	2.2	38.9	8.63	36.7	8.10	34.5	7.75	33.4	7.35	32.3	7.07	30.1	6.62
	5.0	4.1	38.9	7.93	36.7	7.43	34.5	7.13	33.4	6.77	32.3	6.53	30.1	6.11
	7.0	6.0	38.9	7.23	36.7	6.76	34.5	6.52	33.4	6.19	32.3	5.99	30.1	5.60
9.0	7.9	38.9	6.52	36.7	6.11	34.5	5.89	33.4	5.59	32.3	5.42	30.1	5.05	
11.0	9.8	38.9	6.11	36.7	5.72	34.5	5.51	33.4	5.23	32.3	5.07	30.1	4.72	
13.0	11.8	38.9	5.73	36.7	5.37	34.5	5.17	33.4	4.91	32.3	4.76	30.1	4.44	
15.0	13.7	38.9	5.42	36.7	5.08	34.5	4.89	33.4	4.65	32.3	4.50	30.1	4.20	

**Note**

1. TC: Total Capacity(kW), PI : Power Input(kW, Comp. + Outdoor fan motor)
2. Capacity tables show the average value of conditions which may occur.
3. The heating capacity table is based on the values expressed as Max. in the specification of the outdoor unit. (When measuring the Max. heating capacity, the setting status of the indoor unit is the same as that for measuring the heating capacity of the indoor unit.)

# 7. Capacity Tables

## ◆ ARUM241LTE5

Heating Capacity (24HP)

Combination (%)	Outdoor air temp.		Indoor air temp. °C DB											
			16		18		20		21		22		24	
	°C DB	°C WB	TC	PI	TC	PI	TC	PI	TC	PI	TC	PI	TC	PI
130	-24.8	-25	47.8	22.9	47.8	23.28	47.6	23.66	47.6	24.22	47.6	24.78	47.4	25.64
	-21.8	-22	56.8	23.72	56.8	24.14	56.4	24.52	56.4	25.08	56.4	25.64	56.2	26.48
	-19.8	-20	59.2	24.28	59.2	24.72	58.8	25.08	58.8	25.66	58.8	26.20	58.6	27.06
	-18.8	-19	60.6	24.58	60.6	25.00	60.2	25.38	60.2	25.94	60.2	26.48	60.0	27.34
	-16.7	-17	63.6	25.18	63.6	25.60	63.2	25.98	63.2	26.54	63.2	27.08	62.8	27.94
	-13.7	-15	67.8	26.04	67.8	26.46	67.4	26.84	67.4	27.40	67.4	27.94	67.0	28.64
	-11.8	-13	70.0	26.58	70.0	27.00	69.6	27.38	69.6	27.94	69.6	28.48	69.2	29.34
	-9.8	-11	72.4	27.14	72.4	27.58	71.8	27.94	71.8	28.48	71.8	29.02	71.4	29.84
	-9.5	-10	72.8	27.24	72.8	27.66	72.4	28.00	72.4	28.54	72.4	29.08	72.0	29.84
	-8.5	-9.1	74.6	27.52	74.6	27.94	74.2	28.38	74.2	28.92	74.2	29.46	73.8	30.24
	-7.0	-7.6	77.4	27.94	77.4	28.38	76.8	28.82	76.8	29.36	76.8	29.90	76.4	30.74
	-5.0	-5.6	81.0	26.90	81.0	26.14	80.4	25.48	80.4	24.62	80.4	23.86	79.0	22.86
	-3.0	-3.7	84.6	25.84	84.6	25.10	84.0	24.46	84.0	23.64	84.0	22.92	81.8	22.00
	0.0	-0.7	89.8	24.26	89.8	23.54	89.4	22.92	89.4	22.18	89.4	21.50	85.4	20.70
	3.0	2.2	95.2	22.68	95.2	21.98	94.6	21.38	94.6	20.72	91.6	20.08	85.4	19.40
	5.0	4.1	97.8	21.62	97.8	20.94	97.4	20.36	95.0	19.74	91.6	19.14	85.4	18.52
	7.0	6.0	97.8	20.56	97.8	19.90	97.4	19.32	95.0	18.76	91.6	18.20	85.4	17.66
	9.0	7.9	97.8	19.68	97.8	19.04	97.4	18.48	95.0	17.94	91.6	17.42	85.4	16.90
	11.0	9.8	97.8	18.94	97.8	18.32	97.4	17.80	95.0	17.28	91.6	16.76	85.4	16.26
	13.0	11.8	97.8	18.16	97.8	17.58	97.4	17.06	95.0	16.56	91.6	16.08	85.4	15.60
15.0	13.7	97.8	17.34	97.8	16.78	97.4	16.28	95.0	15.82	91.6	15.34	85.4	14.88	
120	-24.8	-25	47.6	23.28	47.6	23.66	47.2	24.22	47.2	24.78	47.2	25.64	47.0	26.24
	-21.8	-22	56.4	24.14	56.4	24.52	56.0	25.08	56.0	25.64	56.0	26.48	55.8	27.08
	-19.8	-20	58.8	24.72	58.8	25.08	58.4	25.66	58.4	26.20	58.4	27.06	58.2	27.66
	-18.8	-19	60.2	25.00	60.2	25.38	59.8	25.94	59.8	26.48	59.8	27.34	59.6	27.94
	-16.7	-17	63.2	25.60	63.2	25.98	62.8	26.54	62.8	27.08	62.8	27.94	62.4	28.64
	-13.7	-15	67.2	26.46	67.2	26.84	66.8	27.40	66.8	27.94	66.8	28.48	66.4	29.14
	-11.8	-13	69.4	27.00	69.4	27.38	69.0	27.94	69.0	28.48	69.0	29.02	68.6	29.74
	-9.8	-11	71.8	27.58	71.8	27.94	71.4	28.48	71.4	29.02	71.4	29.56	71.0	30.24
	-9.5	-10	72.4	27.66	72.4	27.78	72.0	28.32	72.0	28.86	72.0	29.40	71.6	30.04
	-8.5	-9.1	74.2	27.94	74.2	28.38	73.6	28.92	73.6	29.46	73.6	30.04	73.2	30.84
	-7.0	-7.6	76.8	27.12	76.8	26.44	76.4	25.54	76.4	24.78	76.0	23.86	75.8	23.24
	-5.0	-5.6	80.4	26.02	80.4	25.36	79.8	24.54	79.8	23.82	79.8	23.02	78.6	22.44
	-3.0	-3.7	84.0	24.92	84.0	24.28	83.4	23.52	83.4	22.88	83.4	22.18	80.2	21.64
	0.0	-0.7	89.2	23.26	89.2	22.66	88.6	22.02	88.6	21.46	86.2	20.92	80.2	20.44
	3.0	2.2	94.6	21.60	94.6	21.04	92.2	20.52	89.0	20.04	86.2	19.66	80.2	19.26
	5.0	4.1	97.0	20.50	96.0	19.96	92.2	19.50	89.0	19.10	86.2	18.82	80.2	18.46
	7.0	6.0	97.0	19.40	96.0	18.88	92.2	18.50	89.0	18.14	86.2	17.98	80.2	17.66
	9.0	7.9	97.0	18.52	96.0	18.02	92.2	17.68	89.0	17.34	86.2	17.18	80.2	16.86
	11.0	9.8	97.0	17.82	96.0	17.32	92.2	16.98	89.0	16.66	86.2	16.50	80.2	16.22
	13.0	11.8	97.0	17.06	96.0	16.58	92.2	16.26	89.0	15.96	86.2	15.80	80.2	15.52
15.0	13.7	97.0	16.24	96.0	15.80	92.2	15.50	89.0	15.20	86.2	15.06	80.2	14.78	
110	-24.8	-25	47.2	23.66	47.2	24.22	47.0	24.78	47.0	25.64	47.0	26.24	46.8	26.52
	-21.8	-22	56.2	24.52	56.2	25.08	55.8	25.64	55.8	26.48	55.8	27.08	55.6	27.38
	-19.8	-20	58.4	25.08	58.4	25.66	58.2	26.20	58.2	27.06	58.2	27.66	57.8	27.94
	-18.8	-19	59.8	25.38	59.8	25.94	59.4	26.48	59.4	27.34	59.4	27.94	59.2	28.52
	-16.7	-17	62.8	25.98	62.8	26.54	62.4	27.08	62.4	27.94	62.4	28.54	62.0	29.24
	-13.7	-15	67.0	26.84	67.0	27.40	66.4	27.94	66.4	28.48	66.4	29.06	66.0	29.74
	-11.8	-13	69.2	27.38	69.2	27.94	68.6	28.48	68.6	29.02	68.6	29.56	68.2	30.24
	-9.8	-11	71.4	27.94	71.4	28.48	71.0	29.02	71.0	29.56	71.0	30.04	70.6	30.74
	-9.5	-10	72.0	27.76	72.0	28.32	71.6	28.86	71.6	29.40	71.6	30.04	71.2	30.84
	-8.5	-9.1	73.8	27.18	73.8	26.14	73.2	25.32	73.2	24.24	73.2	23.58	72.2	23.12
	-7.0	-7.6	76.4	26.28	76.4	25.32	76.0	24.56	76.0	23.56	76.0	22.96	72.2	22.48
	-5.0	-5.6	80.0	25.08	80.0	24.22	79.4	23.54	79.4	22.66	77.2	22.10	72.2	21.62
	-3.0	-3.7	83.4	23.90	83.4	23.14	82.6	22.52	80.0	21.76	77.2	21.26	72.2	20.78
	0.0	-0.7	88.8	22.10	88.0	21.50	82.6	21.00	80.0	20.40	77.2	20.00	72.2	19.50
	3.0	2.2	93.2	20.32	88.0	19.84	82.6	19.48	80.0	19.06	77.2	18.72	72.2	18.22
	5.0	4.1	93.2	19.12	88.0	18.76	82.6	18.48	80.0	18.16	77.2	17.88	72.2	17.36
	7.0	6.0	93.2	17.92	88.0	17.66	82.6	17.46	80.0	17.24	77.2	17.02	72.2	16.50
	9.0	7.9	93.2	17.06	88.0	16.80	82.6	16.62	80.0	16.42	77.2	16.20	72.2	15.70
	11.0	9.8	93.2	16.32	88.0	16.08	82.6	15.90	80.0	15.70	77.2	15.50	72.2	15.02
	13.0	11.8	93.2	15.54	88.0	15.32	82.6	15.14	80.0	14.96	77.2	14.76	72.2	14.32
15.0	13.7	93.2	14.74	88.0	14.52	82.6	14.34	80.0	14.18	77.2	14.00	72.2	13.56	

# 7. Capacity Tables

Heating Capacity (24HP)

Combination (%)	Outdoor air temp.		Indoor air temp. °C DB											
			16		18		20		21		22		24	
	°C DB	°C WB	TC	PI	TC	PI	TC	PI	TC	PI	TC	PI	TC	PI
100	-24.8	-25	47.0	26.68	47.0	26.84	46.8	25.86	46.8	27.26	46.8	27.44	46.6	27.52
	-21.8	-22	55.8	26.94	55.8	27.10	55.6	26.68	55.6	27.52	55.6	28.12	55.2	27.78
	-19.8	-20	58.2	27.10	58.2	27.26	57.8	27.22	57.8	27.68	57.8	28.00	57.6	27.94
	-18.8	-19	59.6	27.18	59.2	27.36	59.2	27.52	59.2	27.76	59.2	27.94	59.0	27.44
	-16.7	-17	62.2	27.36	62.2	27.54	62.2	28.12	61.8	27.94	61.8	26.90	61.4	26.40
	-13.7	-15	66.6	27.62	66.6	27.78	66.2	27.94	66.2	26.42	66.2	25.42	66.0	24.90
	-11.8	-13	68.8	27.78	68.4	27.94	68.4	26.90	68.4	25.44	68.4	24.46	66.0	23.94
	-9.8	-11	71.0	27.94	71.0	26.76	70.8	25.80	70.8	24.42	70.8	23.48	66.0	22.94
	-9.5	-10	71.6	27.76	71.6	26.58	71.2	25.62	71.2	24.26	70.8	23.32	66.0	22.80
	-8.5	-9.1	73.4	27.12	73.4	26.00	73.0	25.08	73.2	23.74	70.8	22.82	66.0	22.30
	-7.0	-7.6	77.2	26.18	77.0	25.10	75.6	24.24	73.2	22.98	70.8	22.08	66.0	21.54
	-5.0	-5.6	80.6	24.92	79.8	23.92	75.6	23.14	73.2	21.96	70.8	21.08	66.0	20.54
	-3.0	-3.7	83.0	23.66	80.4	22.74	75.6	22.04	73.2	20.92	70.8	20.10	66.0	19.54
	0.0	-0.7	85.2	21.78	80.4	20.96	75.6	20.38	73.2	19.40	70.8	18.60	66.0	18.04
	3.0	2.2	85.2	19.88	80.4	19.18	75.6	18.72	73.2	17.86	70.8	17.12	66.0	16.54
	5.0	4.1	85.2	18.62	80.4	18.00	75.6	17.62	73.2	16.82	70.8	16.12	66.0	15.54
	7.0	6.0	85.2	17.36	80.4	16.82	75.6	16.52	73.2	15.80	70.8	15.12	66.0	14.54
	9.0	7.9	85.2	16.34	80.4	15.82	75.6	15.54	73.2	14.88	70.8	14.24	66.0	13.68
	11.0	9.8	85.2	15.44	80.4	14.96	75.6	14.70	73.2	14.06	70.8	13.46	66.0	12.94
	13.0	11.8	85.2	14.50	80.4	14.04	75.6	13.80	73.2	13.20	70.8	12.64	66.0	12.14
15.0	13.7	85.2	13.52	80.4	13.08	75.6	12.86	73.2	12.30	70.8	11.78	66.0	11.32	
90	-24.8	-25	46.8	23.48	46.8	24.34	46.6	24.94	46.6	25.22	46.6	25.80	46.4	26.66
	-21.8	-22	55.6	24.34	55.6	25.20	55.4	25.80	55.4	26.08	55.4	26.66	55.0	25.38
	-19.8	-20	58.0	24.92	58.0	25.76	57.6	26.36	57.6	26.66	57.6	25.78	57.4	24.54
	-18.8	-19	59.6	25.20	59.2	26.06	59.0	26.66	59.0	26.20	59.0	25.34	58.8	24.12
	-16.7	-17	62.2	25.80	62.2	26.66	61.8	25.70	61.8	25.24	61.8	24.42	60.2	23.24
	-13.7	-15	66.6	26.66	66.6	25.22	66.0	24.34	66.0	23.88	64.8	23.10	60.2	21.96
	-11.8	-13	68.8	25.66	68.4	24.32	68.2	23.48	67.0	23.02	64.8	22.26	60.2	21.16
	-9.8	-11	71.0	24.62	71.0	23.38	69.2	22.58	67.0	22.10	64.8	21.40	60.2	20.32
	-9.5	-10	71.6	24.46	71.6	23.22	69.2	22.44	67.0	21.96	64.8	21.26	60.2	20.20
	-8.5	-9.1	73.4	23.94	72.8	22.76	69.2	21.98	67.0	21.50	64.8	20.82	60.2	19.76
	-7.0	-7.6	77.2	23.16	73.4	22.04	69.2	21.30	67.0	20.82	64.8	20.16	60.2	19.14
	-5.0	-5.6	78.0	22.12	73.4	21.08	69.2	20.40	67.0	19.92	64.8	19.28	60.2	18.30
	-3.0	-3.7	78.0	21.08	73.4	20.14	69.2	19.50	67.0	19.00	64.8	18.40	60.2	17.44
	0.0	-0.7	78.0	19.52	73.4	18.70	69.2	18.14	67.0	17.64	64.8	17.10	60.2	16.18
	3.0	2.2	78.0	17.94	73.4	17.28	69.2	16.78	67.0	16.28	64.8	15.78	60.2	14.92
	5.0	4.1	78.0	16.90	73.4	16.32	69.2	15.86	67.0	15.36	64.8	14.90	60.2	14.06
	7.0	6.0	78.0	15.86	73.4	15.38	69.2	14.96	67.0	14.46	64.8	14.02	60.2	13.22
	9.0	7.9	78.0	14.90	73.4	14.44	69.2	14.06	67.0	13.58	64.8	13.18	60.2	12.42
	11.0	9.8	78.0	13.94	73.4	13.52	69.2	13.14	67.0	12.70	64.8	12.32	60.2	11.62
	13.0	11.8	78.0	12.98	73.4	12.58	69.2	12.24	67.0	11.82	64.8	11.48	60.2	10.82
15.0	13.7	78.0	12.02	73.4	11.64	69.2	11.34	67.0	10.94	64.8	10.62	60.2	10.02	
80	-24.8	-25	46.6	20.46	46.6	21.32	46.4	21.92	46.4	22.20	46.4	23.64	46.2	22.52
	-21.8	-22	55.0	21.32	55.0	22.18	55.0	22.78	55.0	23.64	55.0	22.52	53.8	21.46
	-19.8	-20	57.4	21.90	57.4	22.74	57.4	23.64	57.4	22.84	57.4	21.78	53.8	20.76
	-18.8	-19	58.8	22.18	58.8	23.64	58.8	23.22	58.8	22.44	57.8	21.40	53.8	20.40
	-16.7	-17	61.8	23.64	61.8	22.78	61.8	22.38	60.0	21.62	57.8	20.62	53.8	19.66
	-13.7	-15	64.6	22.36	63.4	21.56	61.8	21.16	60.0	20.42	57.8	19.50	53.8	18.60
	-11.8	-13	66.4	21.54	64.4	20.78	61.8	20.38	60.0	19.66	57.8	18.80	53.8	17.92
	-9.8	-11	68.2	20.68	65.4	19.96	61.8	19.56	60.0	18.88	57.8	18.06	53.8	17.22
	-9.5	-10	68.6	20.56	65.6	19.84	61.8	19.44	60.0	18.76	57.8	17.94	53.8	17.10
	-8.5	-9.1	69.4	20.14	66.0	19.44	61.8	19.04	60.0	18.36	57.8	17.56	53.8	16.76
	-7.0	-7.6	70.0	19.50	66.0	18.82	61.8	18.42	60.0	17.76	57.8	17.02	53.8	16.22
	-5.0	-5.6	70.0	18.64	66.0	18.02	61.8	17.62	60.0	16.96	57.8	16.26	53.8	15.52
	-3.0	-3.7	70.0	17.78	66.0	17.20	61.8	16.80	60.0	16.18	57.8	15.52	53.8	14.80
	0.0	-0.7	70.0	16.50	66.0	15.98	61.8	15.58	60.0	14.98	57.8	14.40	53.8	13.74
	3.0	2.2	70.0	15.22	66.0	14.74	61.8	14.36	60.0	13.78	57.8	13.28	53.8	12.68
	5.0	4.1	70.0	14.36	66.0	13.94	61.8	13.54	60.0	13.00	57.8	12.54	53.8	11.98
	7.0	6.0	70.0	13.52	66.0	13.12	61.8	12.74	60.0	12.20	57.8	11.80	53.8	11.26
	9.0	7.9	70.0	12.68	66.0	12.32	61.8	11.96	60.0	11.46	57.8	11.08	53.8	10.58
	11.0	9.8	70.0	11.78	66.0	11.44	61.8	11.10	60.0	10.64	57.8	10.28	53.8	9.82
	13.0	11.8	70.0	11.00	66.0	10.68	61.8	10.36	60.0	9.92	57.8	9.60	53.8	9.16
15.0	13.7	70.0	10.34	66.0	10.04	61.8	9.74	60.0	9.34	57.8	9.04	53.8	8.62	

# 7. Capacity Tables

Heating Capacity (24HP)

Combination (%)	Outdoor air temp.		Indoor air temp. °C DB												
			16		18		20		21		22		24		
	°C DB	°C WB	TC	PI	TC	PI	TC	PI	TC	PI	TC	PI	TC	PI	
70	-24.8	-25	46.6	21.06	46.6	21.34	46.4	21.92	46.4	22.78	46.4	21.62	46.4	21.62	20.52
	-21.8	-22	53.0	21.92	53.0	22.20	52.6	22.78	50.8	21.62	49.4	20.52	46.0	19.48	
	-19.8	-20	57.2	22.50	56.0	22.78	52.6	21.96	50.8	20.84	49.4	19.80	46.0	18.80	
	-18.8	-19	58.8	22.78	56.0	22.34	52.6	21.54	50.8	20.44	49.4	19.44	46.0	18.44	
	-16.7	-17	59.2	21.88	56.0	21.44	52.6	20.68	50.8	19.64	49.4	18.68	46.0	17.72	
	-13.7	-15	59.2	20.60	56.0	20.16	52.6	19.44	50.8	18.46	49.4	17.60	46.0	16.68	
	-11.8	-13	59.2	19.78	56.0	19.34	52.6	18.66	50.8	17.72	49.4	16.90	46.0	16.02	
	-9.8	-11	59.2	18.94	56.0	18.50	52.6	17.84	50.8	16.94	49.4	16.18	46.0	15.32	
	-9.5	-10	59.2	18.80	56.0	18.36	52.6	17.72	50.8	16.84	49.4	16.08	46.0	15.22	
	-8.5	-9.1	59.2	18.38	56.0	17.94	52.6	17.30	50.8	16.44	49.4	15.72	46.0	14.88	
	-7.0	-7.6	59.2	17.74	56.0	17.30	52.6	16.68	50.8	15.86	49.4	15.18	46.0	14.36	
	-5.0	-5.6	59.2	16.88	56.0	16.44	52.6	15.86	50.8	15.08	49.4	14.44	46.0	13.66	
	-3.0	-3.7	59.2	16.04	56.0	15.58	52.6	15.04	50.8	14.30	49.4	13.72	46.0	12.96	
	0.0	-0.7	59.2	14.76	56.0	14.30	52.6	13.80	50.8	13.14	49.4	12.64	46.0	11.92	
	3.0	2.2	59.2	13.48	56.0	13.00	52.6	12.56	50.8	11.98	49.4	11.56	46.0	10.88	
	5.0	4.1	59.2	12.62	56.0	12.14	52.6	11.74	50.8	11.20	49.4	10.82	46.0	10.20	
	7.0	6.0	59.2	11.76	56.0	11.30	52.6	10.92	50.8	10.42	49.4	10.10	46.0	9.50	
	9.0	7.9	59.2	10.62	56.0	10.20	52.6	9.86	50.8	9.40	49.4	9.12	46.0	8.58	
	11.0	9.8	59.2	9.90	56.0	9.50	52.6	9.18	50.8	8.76	49.4	8.50	46.0	7.98	
	13.0	11.8	59.2	9.26	56.0	8.88	52.6	8.58	50.8	8.20	49.4	7.94	46.0	7.48	
15.0	13.7	59.2	8.72	56.0	8.38	52.6	8.10	50.8	7.72	49.4	7.50	46.0	7.04		
60	-24.8	-25	45.4	20.48	45.4	21.06	45.2	21.92	43.6	20.74	42.2	19.62	39.4	18.58	
	-21.8	-22	48.6	21.34	48.2	21.92	45.2	20.74	43.6	19.62	42.2	18.58	39.4	17.58	
	-19.8	-20	50.8	21.92	48.2	21.08	45.2	19.94	43.6	18.88	42.2	17.88	39.4	16.92	
	-18.8	-19	50.8	21.50	48.2	20.66	45.2	19.54	43.6	18.50	42.2	17.54	39.4	16.58	
	-16.7	-17	50.8	20.60	48.2	19.76	45.2	18.72	43.6	17.74	42.2	16.82	39.4	15.88	
	-13.7	-15	50.8	19.30	48.2	18.50	45.2	17.52	43.6	16.62	42.2	15.78	39.4	14.88	
	-11.8	-13	50.8	18.50	48.2	17.70	45.2	16.76	43.6	15.92	42.2	15.12	39.4	14.26	
	-9.8	-11	50.8	17.64	48.2	16.86	45.2	15.98	43.6	15.18	42.2	14.42	39.4	13.58	
	-9.5	-10	50.8	17.50	48.2	16.74	45.2	15.86	43.6	15.06	42.2	14.32	39.4	13.48	
	-8.5	-9.1	50.8	17.08	48.2	16.32	45.2	15.46	43.6	14.70	42.2	13.96	39.4	13.16	
	-7.0	-7.6	50.8	16.44	48.2	15.68	45.2	14.86	43.6	14.14	42.2	13.44	39.4	12.66	
	-5.0	-5.6	50.8	15.58	48.2	14.84	45.2	14.08	43.6	13.40	42.2	12.76	39.4	11.98	
	-3.0	-3.7	50.8	14.72	48.2	14.00	45.2	13.28	43.6	12.66	42.2	12.06	39.4	11.32	
	0.0	-0.7	50.8	13.44	48.2	12.72	45.2	12.10	43.6	11.54	42.2	11.02	39.4	10.32	
	3.0	2.2	50.8	12.16	48.2	11.46	45.2	10.90	43.6	10.44	42.2	9.98	39.4	9.32	
	5.0	4.1	50.8	11.30	48.2	10.62	45.2	10.12	43.6	9.70	42.2	9.28	39.4	8.66	
	7.0	6.0	50.8	10.44	48.2	9.78	45.2	9.32	43.6	8.96	42.2	8.60	39.4	7.98	
	9.0	7.9	50.8	9.32	48.2	8.72	45.2	8.32	43.6	8.00	42.2	7.66	39.4	7.12	
	11.0	9.8	50.8	8.70	48.2	8.14	45.2	7.76	43.6	7.46	42.2	7.16	39.4	6.66	
	13.0	11.8	50.8	8.14	48.2	7.62	45.2	7.28	43.6	7.00	42.2	6.70	39.4	6.24	
15.0	13.7	50.8	7.70	48.2	7.22	45.2	6.88	43.6	6.60	42.2	6.34	39.4	5.90		
50	-24.8	-25	42.4	18.76	40.0	19.62	37.6	18.52	36.4	17.48	35.2	16.52	32.8	15.62	
	-21.8	-22	42.4	19.62	40.0	18.52	37.6	17.48	36.4	16.52	35.2	15.62	32.8	14.76	
	-19.8	-20	42.4	18.84	40.0	17.78	37.6	16.80	36.4	15.86	35.2	15.02	32.8	14.18	
	-18.8	-19	42.4	18.46	40.0	17.40	37.6	16.46	36.4	15.54	35.2	14.72	32.8	13.90	
	-16.7	-17	42.4	17.64	40.0	16.64	37.6	15.74	36.4	14.86	35.2	14.08	32.8	13.30	
	-13.7	-15	42.4	16.48	40.0	15.52	37.6	14.70	36.4	13.90	35.2	13.18	32.8	12.44	
	-11.8	-13	42.4	15.74	40.0	14.82	37.6	14.04	36.4	13.28	35.2	12.62	32.8	11.90	
	-9.8	-11	42.4	14.96	40.0	14.08	37.6	13.36	36.4	12.64	35.2	12.02	32.8	11.32	
	-9.5	-10	42.4	14.84	40.0	13.98	37.6	13.26	36.4	12.54	35.2	11.94	32.8	11.24	
	-8.5	-9.1	42.4	14.44	40.0	13.60	37.6	12.92	36.4	12.22	35.2	11.64	32.8	10.96	
	-7.0	-7.6	42.4	13.86	40.0	13.06	37.6	12.40	36.4	11.74	35.2	11.18	32.8	10.52	
	-5.0	-5.6	42.4	13.08	40.0	12.32	37.6	11.72	36.4	11.08	35.2	10.58	32.8	9.96	
	-3.0	-3.7	42.4	12.30	40.0	11.58	37.6	11.02	36.4	10.44	35.2	9.98	32.8	9.38	
	0.0	-0.7	42.4	11.14	40.0	10.46	37.6	10.00	36.4	9.48	35.2	9.08	32.8	8.52	
	3.0	2.2	42.4	9.98	40.0	9.36	37.6	8.96	36.4	8.50	35.2	8.18	32.8	7.66	
	5.0	4.1	42.4	9.20	40.0	8.62	37.6	8.28	36.4	7.86	35.2	7.58	32.8	7.10	
	7.0	6.0	42.4	8.42	40.0	7.88	37.6	7.60	36.4	7.22	35.2	6.98	32.8	6.52	
	9.0	7.9	42.4	7.60	40.0	7.12	37.6	6.86	36.4	6.52	35.2	6.32	32.8	5.88	
	11.0	9.8	42.4	7.12	40.0	6.66	37.6	6.42	36.4	6.10	35.2	5.90	32.8	5.50	
	13.0	11.8	42.4	6.68	40.0	6.26	37.6	6.02	36.4	5.72	35.2	5.54	32.8	5.18	
15.0	13.7	42.4	6.32	40.0	5.92	37.6	5.70	36.4	5.42	35.2	5.24	32.8	4.90		

**Note**

1. TC: Total Capacity(kW), PI : Power Input(kW, Comp. + Outdoor fan motor)
2. Capacity tables show the average value of conditions which may occur.
3. The heating capacity table is based on the values expressed as Max. in the specification of the outdoor unit. (When measuring the Max. heating capacity, the setting status of the indoor unit is the same as that for measuring the heating capacity of the indoor unit.)

# 7. Capacity Tables

## ◆ ARUM261LTE5

Heating Capacity (26HP)

Combination (%)	Outdoor air temp.		Indoor air temp. °C DB											
			16		18		20		21		22		24	
	°C DB	°C WB	TC	PI	TC	PI	TC	PI	TC	PI	TC	PI	TC	PI
130	-24.8	-25	51.2	24.5	51.2	24.84	51.0	25.15	51.0	25.61	51.0	26.06	50.3	26.76
	-21.8	-22	61.7	25.20	61.7	25.54	61.2	25.85	61.2	26.31	61.2	26.76	60.5	27.45
	-19.8	-20	64.7	25.66	64.7	26.01	64.3	26.31	64.3	26.78	64.3	27.22	63.5	27.92
	-18.8	-19	66.2	25.90	66.2	26.24	65.8	26.55	65.8	27.01	65.8	27.45	65.0	28.15
	-16.7	-17	69.5	26.39	69.5	26.73	69.0	27.04	69.0	27.50	69.0	27.94	68.1	28.64
	-13.7	-15	74.0	27.09	74.0	27.43	73.6	27.74	73.6	28.20	73.6	28.64	72.6	27.45
	-11.8	-13	76.4	27.53	76.4	27.87	76.0	28.18	76.0	28.64	76.0	27.84	75.4	26.70
	-9.8	-11	79.0	27.99	79.0	28.34	78.4	28.64	78.4	27.78	78.4	26.99	78.1	25.91
	-9.5	-10	79.5	28.07	79.5	28.41	79.0	28.51	79.0	27.64	78.9	26.86	78.6	25.78
	-8.5	-9.1	81.2	28.30	81.2	28.64	80.7	28.06	80.7	27.20	80.1	26.43	80.0	25.38
	-7.0	-7.6	83.8	28.64	83.8	27.97	83.2	27.38	83.2	26.54	83.2	25.79	82.7	24.79
	-5.0	-5.6	87.3	27.75	87.3	27.07	86.7	26.47	86.7	25.67	86.7	24.94	85.6	23.99
	-3.0	-3.7	90.7	26.86	90.7	26.17	90.1	25.57	90.1	24.79	90.1	24.09	88.6	23.20
	0.0	-0.7	95.8	25.52	95.8	24.82	95.3	24.21	95.3	23.48	95.3	22.80	92.5	22.01
	3.0	2.2	101.0	24.18	101.0	23.47	100.3	22.85	100.3	22.17	98.8	21.52	92.5	20.81
	5.0	4.1	103.9	23.28	103.9	22.56	103.4	21.95	102.2	21.30	99.3	20.67	92.5	20.01
	7.0	6.0	105.6	22.38	105.6	21.66	105.0	21.03	102.9	20.42	99.3	19.81	92.5	19.22
	9.0	7.9	105.9	21.64	105.9	20.94	105.5	20.33	102.9	19.74	99.3	19.16	92.5	18.58
	11.0	9.8	105.9	21.07	105.9	20.39	105.5	19.80	102.9	19.23	99.3	18.65	92.5	18.09
	13.0	11.8	105.9	20.47	105.9	19.81	105.5	19.23	102.9	18.67	99.3	18.12	92.5	17.58
15.0	13.7	105.9	19.83	105.9	19.19	105.5	18.63	102.9	18.09	99.3	17.55	92.5	17.02	
120	-24.8	-25	50.9	24.84	50.9	25.15	50.6	25.61	50.6	26.06	50.6	26.76	49.9	27.25
	-21.8	-22	61.2	25.54	61.2	25.85	60.8	26.31	60.8	26.76	60.8	27.45	60.1	27.94
	-19.8	-20	64.2	26.01	64.2	26.31	63.8	26.78	63.8	27.22	63.8	27.92	63.0	28.41
	-18.8	-19	65.8	26.24	65.8	26.55	65.3	27.01	65.3	27.45	65.3	28.15	64.5	28.64
	-16.7	-17	69.0	26.73	69.0	27.04	68.6	27.50	68.6	27.94	68.6	28.64	67.6	27.88
	-13.7	-15	73.4	27.43	73.4	27.74	73.0	28.20	73.0	28.64	73.0	27.49	72.1	26.78
	-11.8	-13	75.8	27.87	75.8	28.18	75.4	28.64	75.4	27.82	75.4	26.76	74.8	26.09
	-9.8	-11	78.4	28.34	78.4	28.64	77.9	27.74	77.9	26.97	77.9	26.00	77.6	25.36
	-9.5	-10	79.0	28.41	79.0	28.50	78.5	27.61	78.5	26.84	78.5	25.89	78.2	25.25
	-8.5	-9.1	80.7	28.64	80.7	28.02	80.1	27.15	80.1	26.41	80.1	25.50	79.8	24.88
	-7.0	-7.6	83.2	27.92	83.2	27.30	82.7	26.48	82.7	25.77	82.5	24.93	82.1	24.33
	-5.0	-5.6	86.6	26.95	86.6	26.33	86.0	25.57	86.0	24.90	86.0	24.16	85.1	23.60
	-3.0	-3.7	90.1	25.98	90.1	25.37	89.5	24.66	89.5	24.05	89.5	23.39	86.9	22.87
	0.0	-0.7	95.1	24.52	95.1	23.92	94.5	23.31	94.5	22.76	93.3	22.25	86.9	21.77
	3.0	2.2	100.3	23.05	100.3	22.47	98.7	21.95	96.5	21.47	93.4	21.10	86.9	20.68
	5.0	4.1	103.1	22.08	102.6	21.51	99.8	21.04	96.5	20.61	93.4	20.33	86.9	19.95
	7.0	6.0	104.8	21.11	103.9	20.55	99.8	20.14	96.5	19.75	93.4	19.57	86.9	19.22
	9.0	7.9	105.0	20.36	103.9	19.81	99.8	19.43	96.5	19.06	93.4	18.88	86.9	18.53
	11.0	9.8	105.0	19.80	103.9	19.25	99.8	18.87	96.5	18.51	93.4	18.34	86.9	18.02
	13.0	11.8	105.0	19.19	103.9	18.66	99.8	18.29	96.5	17.95	93.4	17.77	86.9	17.46
15.0	13.7	105.0	18.53	103.9	18.02	99.8	17.68	96.5	17.34	93.4	17.17	86.9	16.86	
110	-24.8	-25	50.6	25.15	50.6	25.61	50.3	26.06	50.3	26.76	50.3	27.25	49.7	27.48
	-21.8	-22	60.9	25.85	60.9	26.31	60.5	26.76	60.5	27.45	60.5	27.94	59.8	28.18
	-19.8	-20	63.9	26.31	63.9	26.78	63.5	27.22	63.5	27.92	63.5	28.41	62.7	28.64
	-18.8	-19	65.4	26.55	65.4	27.01	64.9	27.45	64.9	28.15	64.9	28.64	64.2	28.25
	-16.7	-17	68.6	27.04	68.6	27.50	68.2	27.94	68.2	28.64	68.2	27.82	67.2	27.41
	-13.7	-15	73.1	27.74	73.1	28.20	72.6	28.64	72.6	27.40	72.6	26.64	72.6	26.21
	-11.8	-13	75.5	28.18	75.5	28.64	75.0	27.76	75.0	26.61	75.0	25.90	75.0	25.46
	-9.8	-11	78.0	28.64	78.0	27.65	77.5	26.83	77.5	25.77	77.5	25.12	77.5	24.66
	-9.5	-10	78.5	28.48	78.5	27.49	78.1	26.69	78.1	25.65	78.1	25.00	77.9	24.53
	-8.5	-9.1	80.2	27.94	80.2	26.99	79.7	26.23	79.7	25.23	79.7	24.60	78.2	24.14
	-7.0	-7.6	82.8	27.12	82.8	26.24	82.3	25.53	82.3	24.60	82.3	24.02	78.2	23.54
	-5.0	-5.6	86.2	26.03	86.2	25.23	85.6	24.59	85.6	23.77	83.7	23.23	78.2	22.74
	-3.0	-3.7	89.5	24.95	89.5	24.24	88.8	23.66	86.6	22.94	83.7	22.45	78.2	21.95
	0.0	-0.7	94.7	23.32	94.3	22.73	89.5	22.26	86.6	21.68	83.7	21.28	78.2	20.76
	3.0	2.2	99.3	21.69	95.4	21.22	89.5	20.86	86.6	20.44	83.7	20.10	78.2	19.56
	5.0	4.1	100.9	20.60	95.4	20.23	89.5	19.94	86.6	19.61	83.7	19.32	78.2	18.76
	7.0	6.0	101.0	19.51	95.4	19.22	89.5	19.00	86.6	18.77	83.7	18.53	78.2	17.96
	9.0	7.9	101.0	18.74	95.4	18.46	89.5	18.26	86.6	18.04	83.7	17.80	78.2	17.25
	11.0	9.8	101.0	18.13	95.4	17.86	89.5	17.66	86.6	17.44	83.7	17.22	78.2	16.68
	13.0	11.8	101.0	17.47	95.4	17.22	89.5	17.02	86.6	16.81	83.7	16.59	78.2	16.09
15.0	13.7	101.0	16.79	95.4	16.54	89.5	16.34	86.6	16.15	83.7	15.95	78.2	15.45	



# 7. Capacity Tables

Heating Capacity (26HP)

Combination (%)	Outdoor air temp.		Indoor air temp. °C DB											
			16		18		20		21		22		24	
	°C DB	°C WB	TC	PI	TC	PI	TC	PI	TC	PI	TC	PI	TC	PI
100	-24.8	-25	50.4	28.01	50.4	28.09	50.1	26.80	50.1	28.30	50.1	28.39	49.5	28.43
	-21.8	-22	60.6	28.14	60.6	28.22	60.3	27.64	60.3	28.43	60.3	28.92	59.5	28.56
	-19.8	-20	63.6	28.22	63.6	28.30	63.2	28.19	63.2	28.51	63.2	28.73	62.4	28.64
	-18.8	-19	65.1	28.26	64.7	28.35	64.7	28.43	64.7	28.55	64.7	28.64	63.9	28.16
	-16.7	-17	67.9	28.35	67.9	28.44	67.9	28.92	67.5	28.64	67.5	27.65	66.6	27.16
	-13.7	-15	72.7	28.48	72.7	28.56	72.3	28.64	72.3	27.20	72.3	26.24	71.5	25.73
	-11.8	-13	75.1	28.56	74.7	28.64	74.7	27.67	74.7	26.28	74.7	25.33	71.5	24.82
	-9.8	-11	77.6	28.64	77.6	27.54	77.2	26.64	77.2	25.32	76.7	24.40	71.5	23.86
	-9.5	-10	78.1	28.47	78.1	27.38	77.7	26.48	77.7	25.17	76.7	24.25	71.5	23.72
	-8.5	-9.1	79.8	27.89	79.8	26.83	79.4	25.97	79.3	24.68	76.7	23.78	71.5	23.24
	-7.0	-7.6	83.7	27.02	83.4	26.00	81.9	25.19	79.3	23.96	76.7	23.07	71.5	22.52
	-5.0	-5.6	87.3	25.86	86.5	24.90	81.9	24.16	79.3	23.00	76.7	22.12	71.5	21.56
	-3.0	-3.7	89.9	24.70	87.1	23.80	81.9	23.13	79.3	22.03	76.7	21.19	71.5	20.61
	0.0	-0.7	92.3	22.96	87.1	22.15	81.9	21.58	79.3	20.59	76.7	19.76	71.5	19.17
	3.0	2.2	92.3	21.21	87.1	20.50	81.9	20.04	79.3	19.14	76.7	18.35	71.5	17.74
	5.0	4.1	92.3	20.05	87.1	19.40	81.9	19.01	79.3	18.16	76.7	17.40	71.5	16.78
	7.0	6.0	92.3	18.89	87.1	18.30	81.9	17.98	79.3	17.20	76.7	16.46	71.5	15.83
	9.0	7.9	92.3	17.99	87.1	17.42	81.9	17.12	79.3	16.38	76.7	15.67	71.5	15.07
	11.0	9.8	92.3	17.23	87.1	16.69	81.9	16.40	79.3	15.69	76.7	15.01	71.5	14.44
	13.0	11.8	92.3	16.43	87.1	15.91	81.9	15.63	79.3	14.96	76.7	14.31	71.5	13.76
15.0	13.7	92.3	15.59	87.1	15.09	81.9	14.83	79.3	14.19	76.7	13.58	71.5	13.05	
90	-24.8	-25	50.2	24.83	50.2	25.53	49.9	26.02	49.9	26.25	49.9	26.72	49.3	27.42
	-21.8	-22	60.4	25.53	60.4	26.23	60.1	26.72	60.1	26.95	60.1	27.42	59.2	26.18
	-19.8	-20	63.4	26.00	63.4	26.69	63.0	27.18	63.0	27.42	63.0	26.57	62.2	25.37
	-18.8	-19	65.1	26.23	64.7	26.93	64.5	27.42	64.5	26.98	64.5	26.15	63.7	24.96
	-16.7	-17	67.9	26.72	67.9	27.42	67.5	26.51	67.5	26.06	67.5	25.27	65.2	24.10
	-13.7	-15	72.7	27.42	72.7	26.06	72.1	25.21	72.1	24.76	70.2	24.00	65.2	22.87
	-11.8	-13	75.1	26.48	74.7	25.21	74.4	24.40	72.6	23.93	70.2	23.19	65.2	22.09
	-9.8	-11	77.6	25.50	77.6	24.31	75.0	23.54	72.6	23.06	70.2	22.36	65.2	21.27
	-9.5	-10	78.1	25.35	78.1	24.17	75.0	23.40	72.6	22.92	70.2	22.23	65.2	21.15
	-8.5	-9.1	79.8	24.87	79.2	23.72	75.0	22.97	72.6	22.48	70.2	21.80	65.2	20.74
	-7.0	-7.6	83.7	24.13	79.6	23.05	75.0	22.32	72.6	21.83	70.2	21.17	65.2	20.13
	-5.0	-5.6	84.6	23.15	79.6	22.14	75.0	21.46	72.6	20.96	70.2	20.32	65.2	19.31
	-3.0	-3.7	84.6	22.17	79.6	21.24	75.0	20.60	72.6	20.09	70.2	19.48	65.2	18.48
	0.0	-0.7	84.6	20.70	79.6	19.89	75.0	19.31	72.6	18.78	70.2	18.22	65.2	17.26
	3.0	2.2	84.6	19.22	79.6	18.54	75.0	18.01	72.6	17.48	70.2	16.95	65.2	16.03
	5.0	4.1	84.6	18.24	79.6	17.63	75.0	17.14	72.6	16.60	70.2	16.11	65.2	15.21
	7.0	6.0	84.6	17.26	79.6	16.74	75.0	16.28	72.6	15.73	70.2	15.26	65.2	14.39
	9.0	7.9	84.6	16.35	79.6	15.84	75.0	15.42	72.6	14.90	70.2	14.46	65.2	13.63
	11.0	9.8	84.6	15.43	79.6	14.96	75.0	14.55	72.6	14.06	70.2	13.64	65.2	12.86
	13.0	11.8	84.6	14.52	79.6	14.07	75.0	13.69	72.6	13.22	70.2	12.84	65.2	12.10
15.0	13.7	84.6	13.60	79.6	13.18	75.0	12.83	72.6	12.39	70.2	12.02	65.2	11.34	
80	-24.8	-25	50.0	21.72	50.0	22.42	49.7	22.91	49.7	23.14	49.7	24.31	49.1	23.23
	-21.8	-22	59.7	22.42	59.7	23.12	59.7	23.61	59.7	24.31	59.7	23.23	58.3	22.20
	-19.8	-20	62.7	22.89	62.7	23.58	62.7	24.31	62.7	23.54	62.4	22.51	58.3	21.51
	-18.8	-19	64.2	23.12	64.2	24.31	64.2	23.92	64.2	23.16	62.6	22.15	58.3	21.16
	-16.7	-17	67.0	24.31	67.0	23.50	67.0	23.11	65.0	22.36	62.6	21.39	58.3	20.44
	-13.7	-15	70.0	23.10	68.7	22.33	67.0	21.94	65.0	21.21	62.6	20.31	58.3	19.41
	-11.8	-13	71.9	22.32	69.7	21.59	67.0	21.19	65.0	20.48	62.6	19.62	58.3	18.75
	-9.8	-11	73.8	21.51	70.8	20.81	67.0	20.41	65.0	19.72	62.6	18.91	58.3	18.06
	-9.5	-10	74.3	21.39	71.1	20.69	67.0	20.29	65.0	19.60	62.6	18.79	58.3	17.95
	-8.5	-9.1	75.1	20.99	71.4	20.31	67.0	19.90	65.0	19.22	62.6	18.43	58.3	17.61
	-7.0	-7.6	75.8	20.38	71.4	19.72	67.0	19.31	65.0	18.64	62.6	17.90	58.3	17.09
	-5.0	-5.6	75.8	19.57	71.4	18.95	67.0	18.54	65.0	17.87	62.6	17.17	58.3	16.40
	-3.0	-3.7	75.8	18.76	71.4	18.17	67.0	17.76	65.0	17.11	62.6	16.45	58.3	15.71
	0.0	-0.7	75.8	17.54	71.4	17.00	67.0	16.59	65.0	15.96	62.6	15.36	58.3	14.68
	3.0	2.2	75.8	16.33	71.4	15.83	67.0	15.42	65.0	14.81	62.6	14.28	58.3	13.64
	5.0	4.1	75.8	15.51	71.4	15.06	67.0	14.63	65.0	14.05	62.6	13.56	58.3	12.96
	7.0	6.0	75.8	14.71	71.4	14.28	67.0	13.86	65.0	13.28	62.6	12.84	58.3	12.26
	9.0	7.9	75.8	13.80	71.4	13.41	67.0	13.01	65.0	12.47	62.6	12.06	58.3	11.51
	11.0	9.8	75.8	12.82	71.4	12.45	67.0	12.08	65.0	11.58	62.6	11.19	58.3	10.69
	13.0	11.8	75.8	11.97	71.4	11.62	67.0	11.27	65.0	10.80	62.6	10.45	58.3	9.97
15.0	13.7	75.8	11.26	71.4	10.93	67.0	10.61	65.0	10.17	62.6	9.84	58.3	9.39	

# 7. Capacity Tables

Heating Capacity (26HP)

Combination (%)	Outdoor air temp.		Indoor air temp. °C DB											
			16		18		20		21		22		24	
	°C DB	°C WB	TC	PI	TC	PI	TC	PI	TC	PI	TC	PI	TC	PI
70	-24.8	-25	50.0	22.19	50.0	22.42	49.7	22.89	49.7	23.59	49.7	22.44	49.7	22.35
	-21.8	-22	57.4	22.89	57.4	23.12	57.0	23.59	55.1	22.44	53.5	21.35	49.9	20.31
	-19.8	-20	62.4	23.36	60.7	23.59	57.0	22.78	55.1	21.67	53.5	20.64	49.9	19.63
	-18.8	-19	64.0	23.59	60.7	23.16	57.0	22.37	55.1	21.28	53.5	20.28	49.9	19.27
	-16.7	-17	64.2	22.71	60.7	22.28	57.0	21.52	55.1	20.48	53.5	19.52	49.9	18.55
	-13.7	-15	64.2	21.46	60.7	21.02	57.0	20.30	55.1	19.31	53.5	18.45	49.9	17.51
	-11.8	-13	64.2	20.66	60.7	20.21	57.0	19.52	55.1	18.58	53.5	17.76	49.9	16.85
	-9.8	-11	64.2	19.83	60.7	19.38	57.0	18.71	55.1	17.81	53.5	17.04	49.9	16.16
	-9.5	-10	64.2	19.70	60.7	19.25	57.0	18.59	55.1	17.70	53.5	16.93	49.9	16.06
	-8.5	-9.1	64.2	19.28	60.7	18.83	57.0	18.18	55.1	17.31	53.5	16.58	49.9	15.71
	-7.0	-7.6	64.2	18.66	60.7	18.20	57.0	17.57	55.1	16.73	53.5	16.04	49.9	15.19
	-5.0	-5.6	64.2	17.82	60.7	17.35	57.0	16.76	55.1	15.96	53.5	15.31	49.9	14.50
	-3.0	-3.7	64.2	16.99	60.7	16.51	57.0	15.95	55.1	15.19	53.5	14.59	49.9	13.80
	0.0	-0.7	64.2	15.73	60.7	15.25	57.0	14.73	55.1	14.04	53.5	13.52	49.9	12.76
	3.0	2.2	64.2	14.48	60.7	13.97	57.0	13.50	55.1	12.88	53.5	12.44	49.9	11.72
	5.0	4.1	64.2	13.64	60.7	13.13	57.0	12.69	55.1	12.11	53.5	11.71	49.9	11.04
	7.0	6.0	64.2	12.80	60.7	12.29	57.0	11.88	55.1	11.34	53.5	11.00	49.9	10.34
	9.0	7.9	64.2	11.56	60.7	11.10	57.0	10.73	55.1	10.24	53.5	9.93	49.9	9.34
	11.0	9.8	64.2	10.77	60.7	10.34	57.0	9.99	55.1	9.53	53.5	9.25	49.9	8.69
	13.0	11.8	64.2	10.08	60.7	9.67	57.0	9.34	55.1	8.92	53.5	8.65	49.9	8.14
15.0	13.7	64.2	9.49	60.7	9.12	57.0	8.81	55.1	8.41	53.5	8.16	49.9	7.67	
60	-24.8	-25	49.2	21.72	49.2	22.19	48.9	22.89	47.3	21.69	45.7	20.56	42.7	19.50
	-21.8	-22	52.7	22.42	52.2	22.89	48.9	21.69	47.3	20.56	45.7	19.50	42.7	18.48
	-19.8	-20	55.1	22.89	52.2	22.04	48.9	20.89	47.3	19.81	45.7	18.80	42.7	17.81
	-18.8	-19	55.1	22.47	52.2	21.62	48.9	20.48	47.3	19.43	45.7	18.45	42.7	17.46
	-16.7	-17	55.1	21.56	52.2	20.72	48.9	19.65	47.3	18.65	45.7	17.71	42.7	16.75
	-13.7	-15	55.1	20.26	52.2	19.44	48.9	18.44	47.3	17.52	45.7	16.65	42.7	15.73
	-11.8	-13	55.1	19.45	52.2	18.64	48.9	17.68	47.3	16.81	45.7	15.98	42.7	15.09
	-9.8	-11	55.1	18.59	52.2	17.79	48.9	16.88	47.3	16.06	45.7	15.27	42.7	14.40
	-9.5	-10	55.1	18.46	52.2	17.66	48.9	16.76	47.3	15.94	45.7	15.17	42.7	14.30
	-8.5	-9.1	55.1	18.03	52.2	17.24	48.9	16.36	47.3	15.57	45.7	14.81	42.7	13.97
	-7.0	-7.6	55.1	17.39	52.2	16.60	48.9	15.75	47.3	15.00	45.7	14.28	42.7	13.46
	-5.0	-5.6	55.1	16.52	52.2	15.75	48.9	14.96	47.3	14.25	45.7	13.59	42.7	12.77
	-3.0	-3.7	55.1	15.66	52.2	14.90	48.9	14.15	47.3	13.50	45.7	12.88	42.7	12.09
	0.0	-0.7	55.1	14.37	52.2	13.61	48.9	12.95	47.3	12.37	45.7	11.82	42.7	11.07
	3.0	2.2	55.1	13.08	52.2	12.34	48.9	11.74	47.3	11.25	45.7	10.76	42.7	10.05
	5.0	4.1	55.1	12.22	52.2	11.49	48.9	10.95	47.3	10.50	45.7	10.05	42.7	9.38
	7.0	6.0	55.1	11.36	52.2	10.64	48.9	10.14	47.3	9.75	45.7	9.36	42.7	8.69
	9.0	7.9	55.1	10.14	52.2	9.49	48.9	9.05	47.3	8.70	45.7	8.34	42.7	7.75
	11.0	9.8	55.1	9.47	52.2	8.86	48.9	8.45	47.3	8.12	45.7	7.79	42.7	7.25
	13.0	11.8	55.1	8.86	52.2	8.30	48.9	7.92	47.3	7.61	45.7	7.30	42.7	6.79
15.0	13.7	55.1	8.38	52.2	7.85	48.9	7.48	47.3	7.19	45.7	6.90	42.7	6.42	
50	-24.8	-25	46.0	19.48	43.4	20.18	40.7	19.09	39.4	18.06	38.1	17.11	35.5	16.21
	-21.8	-22	46.0	20.18	43.4	19.09	40.7	18.06	39.4	17.11	38.1	16.21	35.5	15.35
	-19.8	-20	46.0	19.42	43.4	18.36	40.7	17.39	39.4	16.46	38.1	15.61	35.5	14.77
	-18.8	-19	46.0	19.04	43.4	17.99	40.7	17.05	39.4	16.14	38.1	15.31	35.5	14.49
	-16.7	-17	46.0	18.23	43.4	17.23	40.7	16.33	39.4	15.46	38.1	14.68	35.5	13.89
	-13.7	-15	46.0	17.09	43.4	16.13	40.7	15.31	39.4	14.50	38.1	13.78	35.5	13.03
	-11.8	-13	46.0	16.36	43.4	15.44	40.7	14.66	39.4	13.89	38.1	13.22	35.5	12.48
	-9.8	-11	46.0	15.59	43.4	14.71	40.7	13.98	39.4	13.25	38.1	12.62	35.5	11.91
	-9.5	-10	46.0	15.48	43.4	14.60	40.7	13.88	39.4	13.15	38.1	12.54	35.5	11.82
	-8.5	-9.1	46.0	15.09	43.4	14.23	40.7	13.54	39.4	12.83	38.1	12.24	35.5	11.54
	-7.0	-7.6	46.0	14.52	43.4	13.69	40.7	13.03	39.4	12.35	38.1	11.79	35.5	11.11
	-5.0	-5.6	46.0	13.75	43.4	12.96	40.7	12.35	39.4	11.70	38.1	11.19	35.5	10.54
	-3.0	-3.7	46.0	12.98	43.4	12.23	40.7	11.66	39.4	11.06	38.1	10.59	35.5	9.96
	0.0	-0.7	46.0	11.84	43.4	11.13	40.7	10.65	39.4	10.10	38.1	9.69	35.5	9.10
	3.0	2.2	46.0	10.70	43.4	10.04	40.7	9.62	39.4	9.13	38.1	8.80	35.5	8.24
	5.0	4.1	46.0	9.93	43.4	9.31	40.7	8.94	39.4	8.49	38.1	8.20	35.5	7.67
	7.0	6.0	46.0	9.16	43.4	8.58	40.7	8.27	39.4	7.85	38.1	7.60	35.5	7.10
	9.0	7.9	46.0	8.27	43.4	7.75	40.7	7.46	39.4	7.09	38.1	6.87	35.5	6.40
	11.0	9.8	46.0	7.75	43.4	7.25	40.7	6.98	39.4	6.64	38.1	6.42	35.5	5.99
	13.0	11.8	46.0	7.27	43.4	6.81	40.7	6.55	39.4	6.23	38.1	6.03	35.5	5.63
15.0	13.7	46.0	6.88	43.4	6.44	40.7	6.20	39.4	5.90	38.1	5.71	35.5	5.33	

**Note**

1. TC: Total Capacity(kW), PI : Power Input(kW, Comp. + Outdoor fan motor)
2. Capacity tables show the average value of conditions which may occur.
3. The heating capacity table is based on the values expressed as Max. in the specification of the outdoor unit. (When measuring the Max. heating capacity, the setting status of the indoor unit is the same as that for measuring the heating capacity of the indoor unit.)

# 7. Capacity Tables

## ◆ ARUM280LTE5

Heating Capacity (28HP)

Combination (%)	Outdoor air temp.		Indoor air temp. °C DB											
			16		18		20		21		22		24	
	°C DB	°C WB	TC	PI	TC	PI	TC	PI	TC	PI	TC	PI	TC	PI
130	-24.8	-25	52.6	26.2	52.6	26.72	52.3	27.15	52.3	27.80	52.3	28.42	52.2	29.41
	-21.8	-22	63.6	27.22	63.6	27.70	63.2	28.13	63.2	28.78	63.2	29.41	63.1	30.38
	-19.8	-20	66.9	27.86	66.9	28.36	66.5	28.78	66.5	29.43	66.5	30.05	66.4	31.03
	-18.8	-19	68.6	28.20	68.6	28.68	68.2	29.11	68.2	29.76	68.2	30.38	68.1	31.36
	-16.7	-17	72.1	28.88	72.1	29.37	71.7	29.80	71.7	30.44	71.7	31.06	71.5	32.04
	-13.7	-15	77.1	29.86	77.1	30.35	76.6	30.78	76.6	31.42	76.6	32.04	76.4	30.78
	-11.8	-13	79.7	30.48	79.7	30.97	79.2	31.40	79.2	32.04	79.2	31.20	79.2	29.99
	-9.8	-11	82.5	31.13	82.5	31.62	81.9	32.04	81.9	31.14	81.9	30.30	81.9	29.15
	-9.5	-10	83.2	31.23	83.2	31.72	82.7	31.91	82.7	30.99	82.3	30.17	82.3	29.02
	-8.5	-9.1	86.0	31.56	86.0	32.04	85.5	31.44	85.5	30.54	83.7	29.71	83.7	28.59
	-7.0	-7.6	90.3	32.04	90.3	31.35	89.6	30.74	89.6	29.85	89.6	29.04	87.6	27.97
	-5.0	-5.6	95.9	31.15	95.9	30.43	95.2	29.79	95.2	28.94	95.2	28.15	90.8	27.12
	-3.0	-3.7	101.5	30.24	101.5	29.51	100.8	28.86	100.8	28.02	100.8	27.25	94.1	26.28
	0.0	-0.7	109.8	28.88	109.8	28.12	109.1	27.45	108.0	26.65	105.8	25.90	98.8	25.02
	3.0	2.2	112.7	27.52	112.7	26.73	112.2	26.04	110.6	25.29	106.9	24.55	99.6	23.76
	5.0	4.1	114.0	26.62	114.0	25.81	113.6	25.10	110.8	24.37	106.9	23.65	99.6	22.91
	7.0	6.0	114.0	25.71	114.0	24.88	113.6	24.16	110.8	23.45	106.9	22.76	99.6	22.08
9.0	7.9	114.0	24.96	114.0	24.16	113.6	23.45	110.8	22.77	106.9	22.10	99.6	21.44	
11.0	9.8	114.0	24.43	114.0	23.63	113.6	22.95	110.8	22.28	106.9	21.62	99.6	20.97	
13.0	11.8	114.0	23.85	114.0	23.08	113.6	22.41	110.8	21.76	106.9	21.11	99.6	20.48	
15.0	13.7	114.0	23.24	114.0	22.49	113.6	21.83	110.8	21.20	106.9	20.56	99.6	19.95	
120	-24.8	-25	52.3	26.72	52.3	27.15	51.9	27.80	51.9	28.42	51.9	29.41	51.8	30.09
	-21.8	-22	63.2	27.70	63.2	28.13	62.8	28.78	62.8	29.41	62.8	30.38	62.7	31.06
	-19.8	-20	66.5	28.36	66.5	28.78	66.0	29.43	66.0	30.05	66.0	31.03	65.9	31.72
	-18.8	-19	68.1	28.68	68.1	29.11	67.7	29.76	67.7	30.38	67.7	31.36	67.6	32.04
	-16.7	-17	71.6	29.37	71.6	29.80	71.2	30.44	71.2	31.06	71.2	32.04	71.0	31.24
	-13.7	-15	76.5	30.35	76.5	30.78	76.0	31.42	76.0	32.04	76.0	30.83	75.9	30.08
	-11.8	-13	79.1	30.97	79.1	31.40	78.6	32.04	78.6	31.18	78.6	30.06	78.6	29.34
	-9.8	-11	81.8	31.62	81.8	32.04	81.3	31.10	81.3	30.28	81.3	29.26	81.3	28.57
	-9.5	-10	82.7	31.72	82.7	31.89	82.2	30.96	82.2	30.15	82.2	29.14	82.2	28.45
	-8.5	-9.1	85.5	32.04	85.5	31.39	84.9	30.48	84.9	29.69	84.4	28.74	84.4	28.06
	-7.0	-7.6	89.6	31.29	89.6	30.64	89.1	29.77	89.1	29.02	87.0	28.12	86.9	27.48
	-5.0	-5.6	95.2	30.29	95.2	29.63	94.5	28.83	94.5	28.11	94.5	27.32	90.2	26.71
	-3.0	-3.7	100.7	29.28	100.7	28.63	100.1	27.87	100.1	27.21	99.2	26.51	92.9	25.93
	0.0	-0.7	109.0	27.77	108.5	27.12	105.7	26.45	103.7	25.85	100.6	25.30	93.5	24.77
	3.0	2.2	111.9	26.26	111.2	25.61	107.5	25.03	103.9	24.49	100.6	24.09	93.5	23.62
	5.0	4.1	113.1	25.25	111.9	24.60	107.5	24.07	103.9	23.59	100.6	23.28	93.5	22.85
	7.0	6.0	113.1	24.25	111.9	23.60	107.5	23.13	103.9	22.68	100.6	22.47	93.5	22.07
9.0	7.9	113.1	23.48	111.9	22.85	107.5	22.40	103.9	21.98	100.6	21.77	93.5	21.37	
11.0	9.8	113.1	22.93	111.9	22.30	107.5	21.86	103.9	21.45	100.6	21.24	93.5	20.87	
13.0	11.8	113.1	22.33	111.9	21.72	107.5	21.29	103.9	20.89	100.6	20.69	93.5	20.32	
15.0	13.7	113.1	21.68	111.9	21.10	107.5	20.69	103.9	20.29	100.6	20.10	93.5	19.74	
110	-24.8	-25	51.9	27.15	51.9	27.80	51.7	28.42	51.7	29.41	51.7	30.09	51.6	30.42
	-21.8	-22	62.9	28.13	62.9	28.78	62.5	29.41	62.5	30.38	62.5	31.06	62.4	31.40
	-19.8	-20	66.1	28.78	66.1	29.43	65.7	30.05	65.7	31.03	65.7	31.72	65.5	32.04
	-18.8	-19	67.7	29.11	67.7	29.76	67.3	30.38	67.3	31.36	67.3	32.04	67.2	31.62
	-16.7	-17	71.2	29.80	71.2	30.44	70.8	31.06	70.8	32.04	70.8	31.17	70.6	30.72
	-13.7	-15	76.2	30.78	76.2	31.42	75.6	32.04	75.6	30.72	75.6	29.92	75.6	29.45
	-11.8	-13	78.7	31.40	78.7	32.04	78.2	31.11	78.2	29.88	78.2	29.12	78.2	28.64
	-9.8	-11	81.4	32.04	81.4	30.99	80.9	30.13	80.9	29.00	80.9	28.29	80.9	27.79
	-9.5	-10	82.2	31.87	82.2	30.82	81.8	29.97	81.8	28.86	81.8	28.17	81.8	27.65
	-8.5	-9.1	85.0	31.31	85.0	30.30	84.4	29.48	84.4	28.42	84.1	27.75	83.6	27.23
	-7.0	-7.6	89.1	30.44	89.1	29.50	88.6	28.74	88.6	27.75	87.1	27.13	84.2	26.59
	-5.0	-5.6	94.7	29.29	94.7	28.44	94.0	27.75	93.0	26.87	89.2	26.29	84.2	25.74
	-3.0	-3.7	100.1	28.15	100.1	27.38	96.4	26.76	93.3	25.98	90.1	25.46	84.2	24.89
	0.0	-0.7	106.5	26.42	102.7	25.79	96.4	25.28	93.3	24.65	90.1	24.21	84.2	23.61
	3.0	2.2	108.7	24.71	102.7	24.19	96.4	23.80	93.3	23.33	90.1	22.95	84.2	22.34
	5.0	4.1	108.7	23.56	102.7	23.14	96.4	22.82	93.3	22.45	90.1	22.12	84.2	21.48
	7.0	6.0	108.7	22.41	102.7	22.07	96.4	21.83	93.3	21.56	90.1	21.28	84.2	20.63
9.0	7.9	108.7	21.61	102.7	21.29	96.4	21.05	93.3	20.80	90.1	20.53	84.2	19.89	
11.0	9.8	108.7	20.99	102.7	20.68	96.4	20.45	93.3	20.20	90.1	19.94	84.2	19.32	
13.0	11.8	108.7	20.33	102.7	20.04	96.4	19.81	93.3	19.57	90.1	19.31	84.2	18.72	
15.0	13.7	108.7	19.64	102.7	19.35	96.4	19.12	93.3	18.90	90.1	18.66	84.2	18.08	

# 7. Capacity Tables

Heating Capacity (28HP)

Combination (%)	Outdoor air temp.		Indoor air temp. °C DB											
			16		18		20		21		22		24	
	°C DB	°C WB	TC	PI	TC	PI	TC	PI	TC	PI	TC	PI	TC	PI
100	-24.8	-25	51.7	30.23	51.7	30.46	51.4	29.54	51.4	31.06	51.4	31.32	51.3	31.44
	-21.8	-22	62.5	30.59	62.5	30.83	62.2	30.48	62.2	31.43	62.2	32.12	62.0	31.81
	-19.8	-20	65.8	30.83	65.8	31.07	65.4	31.10	65.4	31.67	65.4	32.07	65.3	32.04
	-18.8	-19	67.5	30.95	67.0	31.20	67.0	31.43	67.0	31.79	67.0	32.04	66.9	31.53
	-16.7	-17	70.5	31.21	70.5	31.46	70.5	32.12	70.1	32.04	70.1	30.98	69.9	30.44
	-13.7	-15	75.8	31.57	75.8	31.81	75.3	32.04	75.3	30.50	75.3	29.45	75.2	28.89
	-11.8	-13	78.3	31.81	77.9	32.04	77.9	31.00	77.9	29.51	77.9	28.48	76.7	27.90
	-9.8	-11	80.9	32.04	80.9	30.87	80.6	29.90	80.6	28.47	80.6	27.47	76.9	26.87
	-9.5	-10	81.8	31.86	81.8	30.70	81.4	29.73	81.4	28.31	81.2	27.31	76.9	26.72
	-8.5	-9.1	84.5	31.24	84.5	30.11	84.1	29.19	85.4	27.79	82.6	26.80	76.9	26.20
	-7.0	-7.6	90.1	30.32	89.8	29.23	88.2	28.35	85.4	27.02	82.6	26.03	76.9	25.42
	-5.0	-5.6	94.1	29.09	93.1	28.06	88.2	27.25	85.4	25.98	82.6	25.01	76.9	24.39
	-3.0	-3.7	96.8	27.86	93.8	26.89	88.2	26.16	85.4	24.94	82.6	24.00	76.9	23.35
	0.0	-0.7	99.5	26.01	93.8	25.12	88.2	24.50	85.4	23.39	82.6	22.47	76.9	21.80
	3.0	2.2	99.5	24.16	93.8	23.36	88.2	22.85	85.4	21.83	82.6	20.94	76.9	20.25
	5.0	4.1	99.5	22.93	93.8	22.19	88.2	21.75	85.4	20.79	82.6	19.92	76.9	19.21
	7.0	6.0	99.5	21.70	93.8	21.02	88.2	20.65	85.4	19.75	82.6	18.90	76.9	18.18
9.0	7.9	99.5	20.71	93.8	20.06	88.2	19.71	85.4	18.86	82.6	18.05	76.9	17.35	
11.0	9.8	99.5	19.89	93.8	19.27	88.2	18.94	85.4	18.12	82.6	17.34	76.9	16.67	
13.0	11.8	99.5	19.03	93.8	18.43	88.2	18.11	85.4	17.33	82.6	16.58	76.9	15.94	
15.0	13.7	99.5	18.13	93.8	17.55	88.2	17.25	85.4	16.50	82.6	15.79	76.9	15.18	
90	-24.8	-25	51.5	26.82	51.5	27.80	51.2	28.49	51.2	28.81	51.2	29.47	51.1	30.45
	-21.8	-22	62.3	27.80	62.3	28.78	62.0	29.47	62.0	29.79	62.0	30.45	61.8	29.13
	-19.8	-20	65.6	28.46	65.6	29.43	65.1	30.11	65.1	30.45	65.1	29.55	65.0	28.26
	-18.8	-19	67.5	28.78	67.0	29.76	66.8	30.45	66.8	29.98	66.8	29.10	66.7	27.82
	-16.7	-17	70.5	29.47	70.5	30.45	70.1	29.49	70.1	29.01	70.1	28.16	69.3	26.90
	-13.7	-15	75.8	30.45	75.8	29.02	75.1	28.12	75.1	27.63	74.5	26.81	70.3	25.58
	-11.8	-13	78.3	29.47	77.9	28.12	77.6	27.26	77.0	26.75	75.6	25.96	70.3	24.75
	-9.8	-11	80.9	28.44	80.9	27.18	79.6	26.35	78.2	25.82	75.6	25.07	70.3	23.88
	-9.5	-10	81.8	28.29	81.8	27.03	80.2	26.21	78.2	25.68	75.6	24.93	70.3	23.75
	-8.5	-9.1	84.5	27.78	83.9	26.56	80.7	25.75	78.2	25.22	75.6	24.48	70.3	23.31
	-7.0	-7.6	90.1	27.01	85.7	25.85	80.7	25.07	78.2	24.53	75.6	23.81	70.3	22.66
	-5.0	-5.6	91.1	25.98	85.7	24.90	80.7	24.16	78.2	23.61	75.6	22.91	70.3	21.78
	-3.0	-3.7	91.1	24.96	85.7	23.96	80.7	23.26	78.2	22.68	75.6	22.01	70.3	20.90
	0.0	-0.7	91.1	23.42	85.7	22.53	80.7	21.89	78.2	21.30	75.6	20.67	70.3	19.59
	3.0	2.2	91.1	21.88	85.7	21.11	80.7	20.53	78.2	19.92	75.6	19.32	70.3	18.28
	5.0	4.1	91.1	20.85	85.7	20.16	80.7	19.61	78.2	18.99	75.6	18.42	70.3	17.40
	7.0	6.0	91.1	19.83	85.7	19.22	80.7	18.70	78.2	18.07	75.6	17.53	70.3	16.53
9.0	7.9	91.1	18.86	85.7	18.28	80.7	17.79	78.2	17.19	75.6	16.68	70.3	15.72	
11.0	9.8	91.1	17.90	85.7	17.35	80.7	16.88	78.2	16.31	75.6	15.82	70.3	14.92	
13.0	11.8	91.1	16.93	85.7	16.41	80.7	15.97	78.2	15.42	75.6	14.97	70.3	14.11	
15.0	13.7	91.1	15.97	85.7	15.47	80.7	15.06	78.2	14.54	75.6	14.11	70.3	13.31	
80	-24.8	-25	51.3	23.37	51.3	24.35	51.0	25.04	51.0	25.36	51.0	27.00	50.9	25.84
	-21.8	-22	61.6	24.35	61.6	25.33	61.6	26.02	61.6	27.00	61.6	25.84	61.0	24.73
	-19.8	-20	64.9	25.01	64.9	25.98	64.9	27.00	64.9	26.18	64.9	25.07	62.8	24.00
	-18.8	-19	66.5	25.33	66.5	27.00	66.5	26.58	66.5	25.77	66.0	24.68	62.8	23.62
	-16.7	-17	70.1	27.00	70.1	26.13	70.1	25.72	69.2	24.92	67.5	23.88	62.8	22.85
	-13.7	-15	75.4	25.72	74.0	24.90	72.2	24.48	70.0	23.69	67.5	22.72	62.8	21.74
	-11.8	-13	77.4	24.91	75.1	24.12	72.2	23.69	70.0	22.92	67.5	21.99	62.8	21.04
	-9.8	-11	79.1	24.05	76.0	23.30	72.2	22.86	70.0	22.11	67.5	21.22	62.8	20.30
	-9.5	-10	79.6	23.93	76.4	23.17	72.2	22.73	70.0	21.98	67.5	21.10	62.8	20.18
	-8.5	-9.1	80.6	23.50	76.9	22.77	72.2	22.32	70.0	21.58	67.5	20.71	62.8	19.82
	-7.0	-7.6	81.6	22.86	76.9	22.15	72.2	21.70	70.0	20.96	67.5	20.15	62.8	19.26
	-5.0	-5.6	81.6	22.01	76.9	21.33	72.2	20.88	70.0	20.14	67.5	19.37	62.8	18.52
	-3.0	-3.7	81.6	21.15	76.9	20.51	72.2	20.05	70.0	19.33	67.5	18.60	62.8	17.78
	0.0	-0.7	81.6	19.87	76.9	19.28	72.2	18.81	70.0	18.11	67.5	17.44	62.8	16.67
	3.0	2.2	81.6	18.59	76.9	18.04	72.2	17.57	70.0	16.88	67.5	16.29	62.8	15.56
	5.0	4.1	81.6	17.74	76.9	17.22	72.2	16.74	70.0	16.07	67.5	15.52	62.8	14.83
	7.0	6.0	81.6	16.89	76.9	16.40	72.2	15.92	70.0	15.25	67.5	14.75	62.8	14.08
9.0	7.9	81.6	15.85	76.9	15.40	72.2	14.95	70.0	14.32	67.5	13.85	62.8	13.22	
11.0	9.8	81.6	14.72	76.9	14.29	72.2	13.87	70.0	13.29	67.5	12.85	62.8	12.27	
13.0	11.8	81.6	13.74	76.9	13.34	72.2	12.95	70.0	12.40	67.5	12.00	62.8	11.45	
15.0	13.7	81.6	12.93	76.9	12.55	72.2	12.18	70.0	11.68	67.5	11.30	62.8	10.78	

# 7. Capacity Tables

Heating Capacity (28HP)

Combination (%)	Outdoor air temp.		Indoor air temp. °C DB															
			16		18		20		21		22		24					
	°C DB	°C WB	TC	PI	TC	PI	TC	PI	TC	PI	TC	PI	TC	PI				
70	-24.8	-25	51.3	24.06	51.3	24.38	51.0	25.04	51.0	26.02	51.0	26.02	51.0	24.79	57.6	23.64	53.7	22.53
	-21.8	-22	60.6	25.04	60.9	25.36	60.4	26.02	61.4	25.16	59.3	23.98	57.6	22.88	53.7	21.80		
	-19.8	-20	64.8	25.69	64.2	26.02	61.4	25.16	59.3	23.98	57.6	22.88	53.7	21.80				
	-18.8	-19	66.5	26.02	65.1	25.57	61.4	24.73	59.3	23.56	57.6	22.50	53.7	21.42				
	-16.7	-17	68.8	25.10	65.3	24.64	61.4	23.83	59.3	22.71	57.6	21.69	53.7	20.65				
	-13.7	-15	69.1	23.78	65.3	23.31	61.4	22.54	59.3	21.48	57.6	20.55	53.7	19.54				
	-11.8	-13	69.1	22.94	65.3	22.46	61.4	21.72	59.3	20.70	57.6	19.82	53.7	18.83				
	-9.8	-11	69.1	22.07	65.3	21.58	61.4	20.86	59.3	19.88	57.6	19.05	53.7	18.09				
	-9.5	-10	69.1	21.94	65.3	21.44	61.4	20.74	59.3	19.77	57.6	18.94	53.7	17.98				
	-8.5	-9.1	69.1	21.50	65.3	21.00	61.4	20.30	59.3	19.36	57.6	18.56	53.7	17.61				
	-7.0	-7.6	69.1	20.84	65.3	20.34	61.4	19.66	59.3	18.74	57.6	17.99	53.7	17.06				
	-5.0	-5.6	69.1	19.96	65.3	19.45	61.4	18.80	59.3	17.93	57.6	17.22	53.7	16.32				
	-3.0	-3.7	69.1	19.09	65.3	18.56	61.4	17.94	59.3	17.11	57.6	16.45	53.7	15.57				
	0.0	-0.7	69.1	17.78	65.3	17.23	61.4	16.65	59.3	15.88	57.6	15.31	53.7	14.46				
	3.0	2.2	69.1	16.46	65.3	15.89	61.4	15.36	59.3	14.66	57.6	14.16	53.7	13.35				
	5.0	4.1	69.1	15.58	65.3	15.00	61.4	14.50	59.3	13.84	57.6	13.39	53.7	12.62				
	7.0	6.0	69.1	14.70	65.3	14.12	61.4	13.65	59.3	13.02	57.6	12.63	53.7	11.88				
	9.0	7.9	69.1	13.28	65.3	12.75	61.4	12.32	59.3	11.76	57.6	11.40	53.7	10.72				
11.0	9.8	69.1	12.37	65.3	11.87	61.4	11.47	59.3	10.95	57.6	10.62	53.7	9.98					
13.0	11.8	69.1	11.57	65.3	11.10	61.4	10.73	59.3	10.25	57.6	9.93	53.7	9.35					
15.0	13.7	69.1	10.90	65.3	10.47	61.4	10.12	59.3	9.66	57.6	9.37	53.7	8.80					
60	-24.8	-25	50.7	23.40	50.7	24.06	50.4	25.04	49.6	23.78	48.9	22.59	46.0	21.47				
	-21.8	-22	55.8	24.38	56.2	25.04	52.7	23.78	50.9	22.59	49.2	21.47	46.0	20.39				
	-19.8	-20	59.3	25.04	56.2	24.15	52.7	22.93	50.9	21.80	49.2	20.72	46.0	19.67				
	-18.8	-19	59.3	24.59	56.2	23.70	52.7	22.51	50.9	21.40	49.2	20.35	46.0	19.30				
	-16.7	-17	59.3	23.65	56.2	22.76	52.7	21.63	50.9	20.57	49.2	19.57	46.0	18.54				
	-13.7	-15	59.3	22.30	56.2	21.43	52.7	20.36	50.9	19.38	49.2	18.46	46.0	17.46				
	-11.8	-13	59.3	21.46	56.2	20.58	52.7	19.56	50.9	18.63	49.2	17.75	46.0	16.78				
	-9.8	-11	59.3	20.56	56.2	19.70	52.7	18.72	50.9	17.84	49.2	17.00	46.0	16.05				
	-9.5	-10	59.3	20.42	56.2	19.57	52.7	18.60	50.9	17.72	49.2	16.89	46.0	15.94				
	-8.5	-9.1	59.3	19.98	56.2	19.12	52.7	18.17	50.9	17.33	49.2	16.51	46.0	15.59				
	-7.0	-7.6	59.3	19.31	56.2	18.45	52.7	17.54	50.9	16.73	49.2	15.95	46.0	15.05				
	-5.0	-5.6	59.3	18.42	56.2	17.56	52.7	16.70	50.9	15.94	49.2	15.21	46.0	14.32				
	-3.0	-3.7	59.3	17.52	56.2	16.67	52.7	15.86	50.9	15.15	49.2	14.47	46.0	13.60				
	0.0	-0.7	59.3	16.18	56.2	15.33	52.7	14.60	50.9	13.96	49.2	13.35	46.0	12.51				
	3.0	2.2	59.3	14.84	56.2	14.00	52.7	13.33	50.9	12.78	49.2	12.23	46.0	11.43				
	5.0	4.1	59.3	13.94	56.2	13.11	52.7	12.50	50.9	11.99	49.2	11.48	46.0	10.71				
	7.0	6.0	59.3	13.05	56.2	12.22	52.7	11.65	50.9	11.20	49.2	10.74	46.0	9.98				
	9.0	7.9	59.3	11.64	56.2	10.90	52.7	10.40	50.9	9.99	49.2	9.58	46.0	8.91				
11.0	9.8	59.3	10.87	56.2	10.18	52.7	9.70	50.9	9.33	49.2	8.95	46.0	8.32					
13.0	11.8	59.3	10.18	56.2	9.53	52.7	9.10	50.9	8.74	49.2	8.38	46.0	7.80					
15.0	13.7	59.3	9.62	56.2	9.02	52.7	8.60	50.9	8.25	49.2	7.92	46.0	7.37					
50	-24.8	-25	49.5	21.43	46.7	22.41	43.9	21.23	42.5	20.12	41.1	19.07	38.3	18.10				
	-21.8	-22	49.5	22.41	46.7	21.23	43.9	20.12	42.5	19.07	41.1	18.10	38.3	17.16				
	-19.8	-20	49.5	21.58	46.7	20.44	43.9	19.38	42.5	18.37	41.1	17.45	38.3	16.53				
	-18.8	-19	49.5	21.18	46.7	20.04	43.9	19.02	42.5	18.02	41.1	17.12	38.3	16.22				
	-16.7	-17	49.5	20.31	46.7	19.22	43.9	18.24	42.5	17.29	41.1	16.44	38.3	15.56				
	-13.7	-15	49.5	19.07	46.7	18.03	43.9	17.13	42.5	16.24	41.1	15.46	38.3	14.62				
	-11.8	-13	49.5	18.29	46.7	17.28	43.9	16.42	42.5	15.58	41.1	14.85	38.3	14.03				
	-9.8	-11	49.5	17.46	46.7	16.49	43.9	15.69	42.5	14.88	41.1	14.20	38.3	13.40				
	-9.5	-10	49.5	17.34	46.7	16.37	43.9	15.58	42.5	14.78	41.1	14.10	38.3	13.31				
	-8.5	-9.1	49.5	16.92	46.7	15.97	43.9	15.21	42.5	14.43	41.1	13.78	38.3	13.00				
	-7.0	-7.6	49.5	16.30	46.7	15.39	43.9	14.66	42.5	13.91	41.1	13.29	38.3	12.53				
	-5.0	-5.6	49.5	15.47	46.7	14.60	43.9	13.92	42.5	13.20	41.1	12.63	38.3	11.91				
	-3.0	-3.7	49.5	14.65	46.7	13.81	43.9	13.18	42.5	12.51	41.1	11.98	38.3	11.28				
	0.0	-0.7	49.5	13.41	46.7	12.61	43.9	12.08	42.5	11.46	41.1	11.01	38.3	10.34				
	3.0	2.2	49.5	12.18	46.7	11.43	43.9	10.96	42.5	10.41	41.1	10.03	38.3	9.40				
	5.0	4.1	49.5	11.35	46.7	10.64	43.9	10.23	42.5	9.71	41.1	9.38	38.3	8.78				
	7.0	6.0	49.5	10.52	46.7	9.85	43.9	9.49	42.5	9.02	41.1	8.73	38.3	8.15				
	9.0	7.9	49.5	9.50	46.7	8.90	43.9	8.57	42.5	8.14	41.1	7.89	38.3	7.36				
11.0	9.8	49.5	8.89	46.7	8.33	43.9	8.02	42.5	7.62	41.1	7.38	38.3	6.88					
13.0	11.8	49.5	8.35	46.7	7.82	43.9	7.53	42.5	7.15	41.1	6.93	38.3	6.47					
15.0	13.7	49.5	7.90	46.7	7.40	43.9	7.12	42.5	6.77	41.1	6.55	38.3	6.12					

**Note**

1. TC: Total Capacity(kW), PI : Power Input(kW, Comp. + Outdoor fan motor)
2. Capacity tables show the average value of conditions which may occur.
3. The heating capacity table is based on the values expressed as Max. in the specification of the outdoor unit. (When measuring the Max. heating capacity, the setting status of the indoor unit is the same as that for measuring the heating capacity of the indoor unit.)

# 7. Capacity Tables

## ◆ ARUM300LTE5

Heating Capacity (30HP)

Combination (%)	Outdoor air temp.		Indoor air temp. °C DB											
			16		18		20		21		22		24	
	°C DB	°C WB	TC	PI	TC	PI	TC	PI	TC	PI	TC	PI	TC	PI
130	-24.8	-25	61.2	29.1	61.2	29.37	60.8	29.66	60.8	30.09	60.8	30.52	60.0	31.18
	-21.8	-22	72.6	29.71	72.6	30.03	72.1	30.32	72.1	30.75	72.1	31.18	71.2	31.83
	-19.8	-20	75.7	30.14	75.7	30.47	75.2	30.75	75.2	31.20	75.2	31.61	74.2	32.27
	-18.8	-19	77.3	30.36	77.3	30.69	76.8	30.98	76.8	31.41	76.8	31.83	75.8	32.49
	-16.7	-17	80.7	30.83	80.7	31.15	80.1	31.44	80.1	31.87	80.1	32.29	79.0	32.95
	-13.7	-15	85.5	31.48	85.5	31.81	84.9	32.10	84.9	32.53	84.9	32.95	83.8	31.51
	-11.8	-13	88.2	31.90	88.2	32.22	87.7	32.51	87.7	32.95	87.7	31.97	86.7	30.60
	-9.8	-11	91.2	32.33	91.2	32.67	90.6	32.95	90.6	31.89	90.6	30.94	89.6	29.65
	-9.5	-10	91.7	32.41	91.7	32.73	91.2	32.79	91.2	31.72	91.0	30.79	90.1	29.50
	-8.5	-9.1	93.7	32.62	93.7	32.95	93.2	32.23	93.2	31.20	92.5	30.27	91.5	29.02
	-7.0	-7.6	96.7	32.95	96.7	32.11	96.1	31.40	96.1	30.39	96.1	29.49	94.4	28.30
	-5.0	-5.6	100.7	31.84	100.7	31.01	100.0	30.29	100.0	29.33	100.0	28.46	97.4	27.34
	-3.0	-3.7	104.6	30.72	104.6	29.90	103.9	29.18	103.9	28.26	103.9	27.43	100.6	26.39
	0.0	-0.7	110.4	29.05	110.4	28.23	109.8	27.52	109.8	26.67	109.8	25.88	105.0	24.95
	3.0	2.2	116.4	27.38	116.4	26.56	115.6	25.85	115.6	25.07	114.1	24.32	106.7	23.51
	5.0	4.1	119.8	26.26	119.8	25.45	119.2	24.75	118.0	24.01	114.6	23.29	106.7	22.55
	7.0	6.0	122.0	25.15	122.0	24.34	121.3	23.63	118.7	22.94	114.6	22.26	106.7	21.60
9.0	7.9	122.2	24.22	122.2	23.43	121.8	22.75	118.7	22.08	114.6	21.43	106.7	20.79	
11.0	9.8	122.2	23.48	122.2	22.71	121.8	22.06	118.7	21.42	114.6	20.78	106.7	20.16	
13.0	11.8	122.2	22.69	122.2	21.96	121.8	21.32	118.7	20.70	114.6	20.09	106.7	19.49	
15.0	13.7	122.2	21.86	122.2	21.16	121.8	20.54	118.7	19.95	114.6	19.35	106.7	18.77	
120	-24.8	-25	60.8	29.37	60.8	29.66	60.4	30.09	60.4	30.52	60.4	31.18	59.6	31.64
	-21.8	-22	72.1	30.03	72.1	30.32	71.6	30.75	71.6	31.18	71.6	31.83	70.7	32.29
	-19.8	-20	75.1	30.47	75.1	30.75	74.6	31.20	74.6	31.61	74.6	32.27	73.7	32.73
	-18.8	-19	76.7	30.69	76.7	30.98	76.2	31.41	76.2	31.83	76.2	32.49	75.3	32.95
	-16.7	-17	80.1	31.15	80.1	31.44	79.6	31.87	79.6	32.29	79.6	32.95	78.5	32.03
	-13.7	-15	84.8	31.81	84.8	32.10	84.3	32.53	84.3	32.95	84.3	31.56	83.2	30.71
	-11.8	-13	87.6	32.22	87.6	32.51	87.0	32.95	87.0	31.96	87.0	30.68	86.1	29.87
	-9.8	-11	90.5	32.67	90.5	32.95	90.0	31.85	90.0	30.92	90.0	29.75	89.0	28.99
	-9.5	-10	91.1	32.73	91.1	32.77	90.6	31.69	90.6	30.77	90.6	29.62	89.6	28.86
	-8.5	-9.1	93.1	32.95	93.1	32.18	92.5	31.13	92.5	30.24	92.3	29.16	91.3	28.42
	-7.0	-7.6	96.0	32.06	96.0	31.31	95.4	30.32	95.4	29.47	94.8	28.46	93.7	27.75
	-5.0	-5.6	99.9	30.87	99.9	30.13	99.3	29.22	99.3	28.42	99.3	27.53	96.8	26.87
	-3.0	-3.7	103.9	29.68	103.9	28.96	103.2	28.11	103.2	27.39	103.2	26.61	99.4	25.99
	0.0	-0.7	109.7	27.89	109.7	27.19	109.0	26.47	109.0	25.83	107.8	25.22	100.2	24.67
	3.0	2.2	115.6	26.10	115.6	25.43	113.9	24.83	111.3	24.27	107.8	23.83	100.2	23.35
	5.0	4.1	118.9	24.91	118.4	24.26	115.2	23.72	111.3	23.23	107.8	22.91	100.2	22.47
	7.0	6.0	121.0	23.72	119.9	23.08	115.2	22.62	111.3	22.19	107.8	21.98	100.2	21.59
9.0	7.9	121.2	22.79	119.9	22.17	115.2	21.74	111.3	21.33	107.8	21.13	100.2	20.74	
11.0	9.8	121.2	22.06	119.9	21.46	115.2	21.04	111.3	20.64	107.8	20.44	100.2	20.08	
13.0	11.8	121.2	21.28	119.9	20.70	115.2	20.29	111.3	19.91	107.8	19.72	100.2	19.37	
15.0	13.7	121.2	20.45	119.9	19.89	115.2	19.51	111.3	19.13	107.8	18.95	100.2	18.61	
110	-24.8	-25	60.4	29.66	60.4	30.09	60.1	30.52	60.1	31.18	60.1	31.64	59.3	31.85
	-21.8	-22	71.8	30.32	71.8	30.75	71.3	31.18	71.3	31.83	71.3	32.29	70.4	32.51
	-19.8	-20	74.7	30.75	74.7	31.20	74.3	31.61	74.3	32.27	74.3	32.73	73.2	32.95
	-18.8	-19	76.3	30.98	76.3	31.41	75.8	31.83	75.8	32.49	75.8	32.95	74.8	32.47
	-16.7	-17	79.6	31.44	79.6	31.87	79.1	32.29	79.1	32.95	79.1	31.96	78.0	31.47
	-13.7	-15	84.4	32.10	84.4	32.53	83.8	32.95	83.8	31.45	83.8	30.55	83.8	30.04
	-11.8	-13	87.2	32.51	87.2	32.95	86.5	31.88	86.5	30.50	86.5	29.66	86.5	29.14
	-9.8	-11	90.0	32.95	90.0	31.75	89.5	30.77	89.5	29.50	89.5	28.72	88.8	28.19
	-9.5	-10	90.6	32.75	90.6	31.56	90.1	30.60	90.1	29.35	90.1	28.58	89.9	28.04
	-8.5	-9.1	92.6	32.10	92.6	30.96	92.0	30.04	92.0	28.84	92.0	28.10	90.2	27.56
	-7.0	-7.6	95.5	31.11	95.5	30.05	94.9	29.20	94.9	28.09	94.9	27.41	90.2	26.85
	-5.0	-5.6	99.4	29.80	99.4	28.84	98.7	28.08	98.7	27.09	96.5	26.46	90.2	25.89
	-3.0	-3.7	103.2	28.49	103.2	27.64	102.5	26.95	100.0	26.09	96.5	25.52	90.2	24.95
	0.0	-0.7	109.1	26.52	108.7	25.83	103.3	25.27	100.0	24.59	96.5	24.12	90.2	23.52
	3.0	2.2	114.5	24.55	110.1	24.01	103.3	23.59	100.0	23.10	96.5	22.70	90.2	22.09
	5.0	4.1	116.5	23.24	110.1	22.80	103.3	22.47	100.0	22.10	96.5	21.76	90.2	21.13
	7.0	6.0	116.5	21.92	110.1	21.59	103.3	21.35	100.0	21.09	96.5	20.82	90.2	20.18
9.0	7.9	116.5	20.98	110.1	20.66	103.3	20.44	100.0	20.19	96.5	19.93	90.2	19.31	
11.0	9.8	116.5	20.21	110.1	19.91	103.3	19.68	100.0	19.44	96.5	19.19	90.2	18.60	
13.0	11.8	116.5	19.39	110.1	19.11	103.3	18.89	100.0	18.66	96.5	18.42	90.2	17.86	
15.0	13.7	116.5	18.54	110.1	18.26	103.3	18.05	100.0	17.83	96.5	17.61	90.2	17.06	

# 7. Capacity Tables

Heating Capacity (30HP)

Combination (%)	Outdoor air temp.		Indoor air temp. °C DB											
			16		18		20		21		22		24	
	°C DB	°C WB	TC	PI	TC	PI	TC	PI	TC	PI	TC	PI	TC	PI
100	-24.8	-25	60.1	31.87	60.1	32.01	59.8	30.76	59.8	32.36	59.8	32.52	59.0	32.59
	-21.8	-22	71.4	32.09	71.4	32.23	71.0	31.74	71.0	32.58	71.0	33.04	70.0	32.81
	-19.8	-20	74.4	32.23	74.4	32.37	73.9	32.36	73.9	32.72	73.9	32.98	73.0	32.95
	-18.8	-19	76.0	32.30	75.5	32.45	75.5	32.58	75.5	32.79	75.5	32.95	74.5	32.38
	-16.7	-17	78.8	32.45	78.8	32.60	78.8	33.04	78.4	32.95	78.4	31.77	77.3	31.20
	-13.7	-15	84.0	32.67	84.0	32.81	83.5	32.95	83.5	31.23	83.5	30.10	82.4	29.50
	-11.8	-13	86.7	32.81	86.2	32.95	86.2	31.78	86.2	30.13	86.2	29.02	82.4	28.42
	-9.8	-11	89.5	32.95	89.5	31.63	89.2	30.55	89.2	28.99	88.5	27.91	82.4	27.29
	-9.5	-10	90.1	32.74	90.1	31.43	89.7	30.36	89.7	28.81	88.5	27.74	82.4	27.12
	-8.5	-9.1	92.1	32.04	92.1	30.78	91.6	29.75	91.5	28.23	88.5	27.17	82.4	26.56
	-7.0	-7.6	96.5	30.99	96.2	29.78	94.5	28.82	91.5	27.38	88.5	26.34	82.4	25.70
	-5.0	-5.6	100.8	29.60	99.8	28.47	94.5	27.59	91.5	26.23	88.5	25.21	82.4	24.57
	-3.0	-3.7	103.7	28.20	100.5	27.15	94.5	26.36	91.5	25.07	88.5	24.10	82.4	23.44
	0.0	-0.7	106.6	26.12	100.5	25.17	94.5	24.51	91.5	23.35	88.5	22.41	82.4	21.74
	3.0	2.2	106.6	24.02	100.5	23.19	94.5	22.66	91.5	21.63	88.5	20.74	82.4	20.04
	5.0	4.1	106.6	22.62	100.5	21.88	94.5	21.43	91.5	20.47	88.5	19.61	82.4	18.91
	7.0	6.0	106.6	21.23	100.5	20.56	94.5	20.20	91.5	19.32	88.5	18.49	82.4	17.78
	9.0	7.9	106.6	20.01	100.5	19.38	94.5	19.04	91.5	18.22	88.5	17.44	82.4	16.76
	11.0	9.8	106.6	18.95	100.5	18.36	94.5	18.04	91.5	17.26	88.5	16.51	82.4	15.88
	13.0	11.8	106.6	17.84	100.5	17.27	94.5	16.97	91.5	16.24	88.5	15.54	82.4	14.94
15.0	13.7	106.6	16.67	100.5	16.14	94.5	15.86	91.5	15.17	88.5	14.52	82.4	13.96	
90	-24.8	-25	59.9	28.89	59.9	29.55	59.6	30.01	59.6	30.23	59.6	30.67	58.8	31.33
	-21.8	-22	71.1	29.55	71.1	30.21	70.7	30.67	70.7	30.89	70.7	31.33	69.7	29.89
	-19.8	-20	74.1	29.99	74.1	30.64	73.6	31.10	73.6	31.33	73.6	30.34	72.7	28.94
	-18.8	-19	76.0	30.21	75.5	30.87	75.2	31.33	75.2	30.82	75.2	29.85	74.2	28.47
	-16.7	-17	78.8	30.67	78.8	31.33	78.4	30.26	78.4	29.74	78.4	28.82	75.3	27.47
	-13.7	-15	84.0	31.33	84.0	29.74	83.2	28.75	83.2	28.22	81.1	27.34	75.3	26.03
	-11.8	-13	86.7	30.23	86.2	28.73	85.9	27.79	83.8	27.25	81.1	26.40	75.3	25.13
	-9.8	-11	89.5	29.08	89.5	27.68	86.5	26.78	83.8	26.23	81.1	25.42	75.3	24.18
	-9.5	-10	90.1	28.90	90.1	27.52	86.5	26.63	83.8	26.08	81.1	25.27	75.3	24.04
	-8.5	-9.1	92.1	28.33	91.4	27.00	86.5	26.12	83.8	25.56	81.1	24.78	75.3	23.55
	-7.0	-7.6	96.5	27.46	91.8	26.20	86.5	25.36	83.8	24.80	81.1	24.04	75.3	22.84
	-5.0	-5.6	97.6	26.31	91.8	25.14	86.5	24.36	83.8	23.79	81.1	23.05	75.3	21.89
	-3.0	-3.7	97.6	25.16	91.8	24.09	86.5	23.35	83.8	22.76	81.1	22.06	75.3	20.93
	0.0	-0.7	97.6	23.43	91.8	22.50	86.5	21.83	83.8	21.24	81.1	20.60	75.3	19.50
	3.0	2.2	97.6	21.70	91.8	20.91	86.5	20.32	83.8	19.71	81.1	19.12	75.3	18.08
	5.0	4.1	97.6	20.55	91.8	19.85	86.5	19.30	83.8	18.69	81.1	18.13	75.3	17.12
	7.0	6.0	97.6	19.39	91.8	18.80	86.5	18.29	83.8	17.67	81.1	17.14	75.3	16.17
	9.0	7.9	97.6	18.32	91.8	17.76	86.5	17.29	83.8	16.70	81.1	16.20	75.3	15.27
	11.0	9.8	97.6	17.25	91.8	16.73	86.5	16.27	83.8	15.72	81.1	15.25	75.3	14.38
	13.0	11.8	97.6	16.18	91.8	15.68	86.5	15.26	83.8	14.74	81.1	14.31	75.3	13.49
15.0	13.7	97.6	15.11	91.8	14.64	86.5	14.26	83.8	13.76	81.1	13.36	75.3	12.60	
80	-24.8	-25	59.6	25.34	59.6	26.00	59.3	26.46	59.3	26.68	59.3	27.78	58.5	26.52
	-21.8	-22	70.4	26.00	70.4	26.66	70.4	27.12	70.4	27.78	70.4	26.52	67.3	25.32
	-19.8	-20	73.3	26.44	73.3	27.09	73.3	27.78	73.3	26.88	72.1	25.68	67.3	24.52
	-18.8	-19	74.9	26.66	74.9	27.78	74.9	27.32	74.4	26.44	72.3	25.26	67.3	24.12
	-16.7	-17	77.3	27.78	77.3	26.82	77.3	26.37	75.0	25.51	72.3	24.38	67.3	23.28
	-13.7	-15	80.8	26.36	79.3	25.46	77.3	25.00	75.0	24.16	72.3	23.12	67.3	22.08
	-11.8	-13	83.3	25.45	80.8	24.59	77.3	24.13	75.0	23.31	72.3	22.32	67.3	21.31
	-9.8	-11	85.5	24.50	81.8	23.68	77.3	23.22	75.0	22.42	72.3	21.48	67.3	20.51
	-9.5	-10	86.0	24.36	82.2	23.54	77.3	23.08	75.0	22.29	72.3	21.35	67.3	20.39
	-8.5	-9.1	86.8	23.89	82.4	23.09	77.3	22.63	75.0	21.84	72.3	20.93	67.3	19.99
	-7.0	-7.6	87.4	23.17	82.4	22.41	77.3	21.94	75.0	21.17	72.3	20.31	67.3	19.39
	-5.0	-5.6	87.4	22.22	82.4	21.50	77.3	21.04	75.0	20.27	72.3	19.46	67.3	18.59
	-3.0	-3.7	87.4	21.27	82.4	20.59	77.3	20.12	75.0	19.39	72.3	18.63	67.3	17.78
	0.0	-0.7	87.4	19.84	82.4	19.23	77.3	18.76	75.0	18.04	72.3	17.36	67.3	16.58
	3.0	2.2	87.4	18.42	82.4	17.86	77.3	17.39	75.0	16.70	72.3	16.10	67.3	15.38
	5.0	4.1	87.4	17.47	82.4	16.95	77.3	16.48	75.0	15.81	72.3	15.27	67.3	14.58
	7.0	6.0	87.4	16.52	82.4	16.04	77.3	15.57	75.0	14.92	72.3	14.43	67.3	13.77
	9.0	7.9	87.4	15.51	82.4	15.06	77.3	14.62	75.0	14.01	72.3	13.55	67.3	12.94
	11.0	9.8	87.4	14.40	82.4	13.98	77.3	13.57	75.0	13.00	72.3	12.57	67.3	12.01
	13.0	11.8	87.4	13.44	82.4	13.05	77.3	12.67	75.0	12.13	72.3	11.74	67.3	11.20
15.0	13.7	87.4	12.65	82.4	12.28	77.3	11.92	75.0	11.42	72.3	11.05	67.3	10.55	

# 7. Capacity Tables

Heating Capacity (30HP)

Combination (%)	Outdoor air temp.		Indoor air temp. °C DB													
			16		18		20		21		22		24			
	°C DB	°C WB	TC	PI	TC	PI	TC	PI	TC	PI	TC	PI	TC	PI		
70	-24.8	-25	59.6	25.66	59.6	25.87	59.3	26.32	59.3	26.98	59.3	26.98	59.3	25.64	57.5	24.38
	-21.8	-22	66.3	26.32	66.3	26.53	65.8	26.98	63.6	25.64	61.7	24.38	57.5	23.17		
	-19.8	-20	70.6	26.76	70.0	26.98	65.8	26.03	63.6	24.74	61.7	23.54	57.5	22.38		
	-18.8	-19	72.6	26.98	70.0	26.48	65.8	25.55	63.6	24.29	61.7	23.13	57.5	21.97		
	-16.7	-17	74.1	25.95	70.0	25.45	65.8	24.56	63.6	23.35	61.7	22.25	57.5	21.13		
	-13.7	-15	74.1	24.49	70.0	23.98	65.8	23.14	63.6	22.00	61.7	21.00	57.5	19.93		
	-11.8	-13	74.1	23.55	70.0	23.04	65.8	22.24	63.6	21.15	61.7	20.20	57.5	19.16		
	-9.8	-11	74.1	22.59	70.0	22.07	65.8	21.30	63.6	20.26	61.7	19.37	57.5	18.36		
	-9.5	-10	74.1	22.43	70.0	21.91	65.8	21.16	63.6	20.13	61.7	19.25	57.5	18.24		
	-8.5	-9.1	74.1	21.95	70.0	21.43	65.8	20.68	63.6	19.68	61.7	18.83	57.5	17.84		
	-7.0	-7.6	74.1	21.22	70.0	20.69	65.8	19.97	63.6	19.01	61.7	18.21	57.5	17.24		
	-5.0	-5.6	74.1	20.24	70.0	19.71	65.8	19.03	63.6	18.11	61.7	17.36	57.5	16.43		
	-3.0	-3.7	74.1	19.27	70.0	18.72	65.8	18.08	63.6	17.21	61.7	16.53	57.5	15.63		
	0.0	-0.7	74.1	17.80	70.0	17.25	65.8	16.66	63.6	15.87	61.7	15.28	57.5	14.42		
	3.0	2.2	74.1	16.34	70.0	15.77	65.8	15.24	63.6	14.53	61.7	14.03	57.5	13.22		
	5.0	4.1	74.1	15.36	70.0	14.79	65.8	14.29	63.6	13.64	61.7	13.19	57.5	12.42		
	7.0	6.0	74.1	14.38	70.0	13.81	65.8	13.35	63.6	12.74	61.7	12.35	57.5	11.62		
	9.0	7.9	74.1	12.99	70.0	12.47	65.8	12.05	63.6	11.50	61.7	11.16	57.5	10.49		
	11.0	9.8	74.1	12.10	70.0	11.61	65.8	11.22	63.6	10.71	61.7	10.39	57.5	9.76		
	13.0	11.8	74.1	11.32	70.0	10.86	65.8	10.50	63.6	10.02	61.7	9.72	57.5	9.14		
15.0	13.7	74.1	10.67	70.0	10.24	65.8	9.90	63.6	9.45	61.7	9.17	57.5	8.61			
60	-24.8	-25	56.8	25.21	56.8	25.66	56.5	26.32	54.5	24.91	52.7	23.59	49.3	22.36		
	-21.8	-22	60.8	25.87	60.2	26.32	56.5	24.91	54.5	23.59	52.7	22.36	49.3	21.17		
	-19.8	-20	63.6	26.32	60.2	25.32	56.5	23.97	54.5	22.71	52.7	21.53	49.3	20.38		
	-18.8	-19	63.6	25.82	60.2	24.82	56.5	23.50	54.5	22.27	52.7	21.12	49.3	19.98		
	-16.7	-17	63.6	24.75	60.2	23.77	56.5	22.52	54.5	21.36	52.7	20.26	49.3	19.15		
	-13.7	-15	63.6	23.23	60.2	22.27	56.5	21.11	54.5	20.04	52.7	19.03	49.3	17.96		
	-11.8	-13	63.6	22.27	60.2	21.33	56.5	20.21	54.5	19.20	52.7	18.25	49.3	17.22		
	-9.8	-11	63.6	21.26	60.2	20.33	56.5	19.28	54.5	18.33	52.7	17.42	49.3	16.42		
	-9.5	-10	63.6	21.10	60.2	20.19	56.5	19.14	54.5	18.19	52.7	17.30	49.3	16.30		
	-8.5	-9.1	63.6	20.60	60.2	19.69	56.5	18.67	54.5	17.76	52.7	16.88	49.3	15.91		
	-7.0	-7.6	63.6	19.84	60.2	18.94	56.5	17.96	54.5	17.10	52.7	16.26	49.3	15.32		
	-5.0	-5.6	63.6	18.83	60.2	17.94	56.5	17.03	54.5	16.22	52.7	15.45	49.3	14.52		
	-3.0	-3.7	63.6	17.82	60.2	16.94	56.5	16.09	54.5	15.34	52.7	14.62	49.3	13.73		
	0.0	-0.7	63.6	16.30	60.2	15.44	56.5	14.68	54.5	14.02	52.7	13.39	49.3	12.54		
	3.0	2.2	63.6	14.79	60.2	13.95	56.5	13.27	54.5	12.71	52.7	12.15	49.3	11.35		
	5.0	4.1	63.6	13.78	60.2	12.95	56.5	12.34	54.5	11.83	52.7	11.33	49.3	10.56		
	7.0	6.0	63.6	12.76	60.2	11.96	56.5	11.40	54.5	10.95	52.7	10.51	49.3	9.76		
	9.0	7.9	63.6	11.39	60.2	10.66	56.5	10.17	54.5	9.78	52.7	9.37	49.3	8.71		
	11.0	9.8	63.6	10.63	60.2	9.96	56.5	9.49	54.5	9.12	52.7	8.75	49.3	8.14		
	13.0	11.8	63.6	9.96	60.2	9.32	56.5	8.90	54.5	8.55	52.7	8.20	49.3	7.63		
15.0	13.7	63.6	9.41	60.2	8.82	56.5	8.41	54.5	8.07	52.7	7.75	49.3	7.21			
50	-24.8	-25	53.0	22.40	50.0	23.06	47.0	21.80	45.5	20.61	44.0	19.50	41.0	18.47		
	-21.8	-22	53.0	23.06	50.0	21.80	47.0	20.61	45.5	19.50	44.0	18.47	41.0	17.48		
	-19.8	-20	53.0	22.17	50.0	20.95	47.0	19.83	45.5	18.75	44.0	17.78	41.0	16.81		
	-18.8	-19	53.0	21.73	50.0	20.52	47.0	19.44	45.5	18.39	44.0	17.44	41.0	16.49		
	-16.7	-17	53.0	20.80	50.0	19.65	47.0	18.61	45.5	17.61	44.0	16.71	41.0	15.79		
	-13.7	-15	53.0	19.47	50.0	18.37	47.0	17.43	45.5	16.50	44.0	15.67	41.0	14.80		
	-11.8	-13	53.0	18.63	50.0	17.57	47.0	16.67	45.5	15.79	44.0	15.02	41.0	14.18		
	-9.8	-11	53.0	17.74	50.0	16.73	47.0	15.89	45.5	15.05	44.0	14.33	41.0	13.51		
	-9.5	-10	53.0	17.61	50.0	16.61	47.0	15.77	45.5	14.94	44.0	14.23	41.0	13.42		
	-8.5	-9.1	53.0	17.16	50.0	16.18	47.0	15.38	45.5	14.57	44.0	13.89	41.0	13.09		
	-7.0	-7.6	53.0	16.50	50.0	15.55	47.0	14.79	45.5	14.01	44.0	13.37	41.0	12.59		
	-5.0	-5.6	53.0	15.61	50.0	14.71	47.0	14.01	45.5	13.27	44.0	12.68	41.0	11.94		
	-3.0	-3.7	53.0	14.72	50.0	13.86	47.0	13.21	45.5	12.53	44.0	11.99	41.0	11.27		
	0.0	-0.7	53.0	13.40	50.0	12.59	47.0	12.04	45.5	11.42	44.0	10.95	41.0	10.28		
	3.0	2.2	53.0	12.07	50.0	11.33	47.0	10.85	45.5	10.30	44.0	9.92	41.0	9.29		
	5.0	4.1	53.0	11.18	50.0	10.48	47.0	10.07	45.5	9.56	44.0	9.23	41.0	8.64		
	7.0	6.0	53.0	10.29	50.0	9.64	47.0	9.29	45.5	8.82	44.0	8.54	41.0	7.97		
	9.0	7.9	53.0	9.29	50.0	8.70	47.0	8.39	45.5	7.97	44.0	7.72	41.0	7.20		
	11.0	9.8	53.0	8.70	50.0	8.14	47.0	7.85	45.5	7.45	44.0	7.22	41.0	6.73		
	13.0	11.8	53.0	8.17	50.0	7.65	47.0	7.36	45.5	7.00	44.0	6.78	41.0	6.33		
15.0	13.7	53.0	7.73	50.0	7.24	47.0	6.97	45.5	6.62	44.0	6.41	41.0	5.99			

**Note**

1. TC: Total Capacity(kW), PI : Power Input(kW, Comp. + Outdoor fan motor)
2. Capacity tables show the average value of conditions which may occur.
3. The heating capacity table is based on the values expressed as Max. in the specification of the outdoor unit. (When measuring the Max. heating capacity, the setting status of the indoor unit is the same as that for measuring the heating capacity of the indoor unit.)



# 7. Capacity Tables

## ◆ ARUM320LTE5

Heating Capacity (32HP)

Combination (%)	Outdoor air temp.		Indoor air temp. °C DB											
			16		18		20		21		22		24	
	°C DB	°C WB	TC	PI	TC	PI	TC	PI	TC	PI	TC	PI	TC	PI
130	-24.8	-25	63.4	32.7	63.4	32.93	63.0	33.18	63.0	33.55	63.0	33.92	62.2	34.48
	-21.8	-22	76.4	33.22	76.4	33.50	75.9	33.75	75.9	34.12	75.9	34.48	74.9	35.04
	-19.8	-20	80.3	33.59	80.3	33.88	79.7	34.12	79.7	34.50	79.7	34.85	78.7	35.42
	-18.8	-19	82.0	33.78	82.0	34.06	81.5	34.31	81.5	34.68	81.5	35.04	80.4	35.60
	-16.7	-17	85.8	34.18	85.8	34.46	85.3	34.71	85.3	35.08	85.3	35.43	84.1	36.00
	-13.7	-15	91.2	34.75	91.2	35.02	90.7	35.27	90.7	35.64	90.7	36.00	89.4	34.55
	-11.8	-13	94.2	35.10	94.2	35.38	93.6	35.63	93.6	36.00	93.6	36.00	92.7	33.63
	-9.8	-11	97.3	35.47	97.3	35.76	96.7	36.00	96.7	36.00	96.7	36.00	95.9	32.67
	-9.5	-10	97.9	35.54	97.9	35.81	97.3	35.84	97.3	36.00	97.3	36.00	96.4	32.52
	-8.5	-9.1	100.0	35.72	100.0	36.00	99.4	35.29	99.4	36.00	99.4	36.00	98.1	32.03
	-7.0	-7.6	103.2	36.00	103.2	35.19	102.5	34.48	102.5	33.46	102.5	32.54	101.2	31.31
	-5.0	-5.6	107.3	34.94	107.3	34.12	106.6	33.39	106.6	32.41	106.6	31.51	104.6	30.34
	-3.0	-3.7	111.5	33.88	111.5	33.04	110.8	32.30	110.8	31.35	110.8	30.47	108.1	29.37
	0.0	-0.7	117.6	32.29	117.6	31.43	117.0	30.66	117.0	29.77	117.0	28.92	113.1	27.92
	3.0	2.2	123.9	30.70	123.9	29.81	123.1	29.03	123.1	28.18	121.6	27.36	113.8	26.47
	5.0	4.1	127.6	29.64	127.6	28.73	126.9	27.94	125.7	27.13	122.2	26.32	113.8	25.50
	7.0	6.0	129.9	28.57	129.9	27.65	129.2	26.85	126.7	26.07	122.2	25.29	113.8	24.54
	9.0	7.9	130.3	27.69	130.3	26.80	129.9	26.02	126.7	25.26	122.2	24.51	113.8	23.78
	11.0	9.8	130.3	27.05	130.3	26.17	129.9	25.42	126.7	24.67	122.2	23.94	113.8	23.22
	13.0	11.8	130.3	26.35	130.3	25.51	129.9	24.76	126.7	24.04	122.2	23.33	113.8	22.63
15.0	13.7	130.3	25.62	130.3	24.79	129.9	24.06	126.7	23.37	122.2	22.67	113.8	21.99	
120	-24.8	-25	63.0	32.93	63.0	33.18	62.5	33.55	62.5	33.92	62.5	34.48	61.7	34.88
	-21.8	-22	75.9	33.50	75.9	33.75	75.4	34.12	75.4	34.48	75.4	35.04	74.4	35.43
	-19.8	-20	79.7	33.88	79.7	34.12	79.2	34.50	79.2	34.85	79.2	35.42	78.1	35.81
	-18.8	-19	81.5	34.06	81.5	34.31	81.0	34.68	81.0	35.04	81.0	35.60	79.9	36.00
	-16.7	-17	85.3	34.46	85.3	34.71	84.7	35.08	84.7	35.43	84.7	36.00	83.5	35.07
	-13.7	-15	90.5	35.02	90.5	35.27	90.0	35.64	90.0	36.00	90.0	36.00	88.8	33.74
	-11.8	-13	93.5	35.38	93.5	35.63	92.9	36.00	92.9	35.01	92.9	33.72	92.0	32.89
	-9.8	-11	96.6	35.76	96.6	36.00	96.0	34.91	96.0	33.97	96.0	32.79	95.3	32.00
	-9.5	-10	97.3	35.81	97.3	35.83	96.7	34.75	96.7	33.81	96.7	32.65	95.9	31.87
	-8.5	-9.1	99.3	36.00	99.3	35.24	98.7	34.19	98.7	33.29	98.7	32.19	97.8	31.42
	-7.0	-7.6	102.4	35.13	102.4	34.37	101.8	33.38	101.8	32.51	101.6	31.49	100.4	30.75
	-5.0	-5.6	106.6	33.96	106.6	33.21	105.8	32.28	105.8	31.46	105.8	30.56	104.0	29.86
	-3.0	-3.7	110.7	32.79	110.7	32.05	110.0	31.18	110.0	30.42	110.0	29.63	106.9	28.97
	0.0	-0.7	116.8	31.04	116.8	30.30	116.1	29.54	116.1	28.86	114.9	28.23	106.9	27.64
	3.0	2.2	123.1	29.28	123.1	28.55	121.4	27.90	118.7	27.30	115.0	26.84	106.9	26.31
	5.0	4.1	126.6	28.12	126.1	27.39	122.9	26.80	118.7	26.26	115.0	25.91	106.9	25.42
	7.0	6.0	129.0	26.95	127.9	26.22	122.9	25.70	118.7	25.21	115.0	24.98	106.9	24.53
	9.0	7.9	129.3	26.06	127.9	25.35	122.9	24.86	118.7	24.38	115.0	24.15	106.9	23.72
	11.0	9.8	129.3	25.40	127.9	24.70	122.9	24.21	118.7	23.75	115.0	23.53	106.9	23.12
	13.0	11.8	129.3	24.68	127.9	24.01	122.9	23.54	118.7	23.09	115.0	22.87	106.9	22.46
15.0	13.7	129.3	23.92	127.9	23.27	122.9	22.82	118.7	22.38	115.0	22.17	106.9	21.77	
110	-24.8	-25	62.6	33.18	62.6	33.55	62.2	33.92	62.2	34.48	62.2	34.88	61.4	35.06
	-21.8	-22	75.5	33.75	75.5	34.12	75.0	34.48	75.0	35.04	75.0	35.43	74.0	35.63
	-19.8	-20	79.2	34.12	79.2	34.50	78.8	34.85	78.8	35.42	78.8	35.81	77.6	36.00
	-18.8	-19	81.0	34.31	81.0	34.68	80.5	35.04	80.5	35.60	80.5	36.00	79.4	35.51
	-16.7	-17	84.8	34.71	84.8	35.08	84.2	35.43	84.2	36.00	84.2	36.00	83.0	34.49
	-13.7	-15	90.1	35.27	90.1	35.64	89.4	36.00	89.4	34.48	89.4	33.56	89.4	33.02
	-11.8	-13	93.0	35.63	93.0	36.00	92.4	34.92	92.4	33.52	92.4	32.65	92.4	32.10
	-9.8	-11	96.1	36.00	96.1	34.79	95.5	33.79	95.5	32.50	95.5	31.70	95.1	31.12
	-9.5	-10	96.7	35.80	96.7	34.59	96.2	33.62	96.2	32.35	96.2	31.56	95.9	30.97
	-8.5	-9.1	98.8	35.15	98.8	33.99	98.1	33.06	98.1	31.83	98.1	31.07	96.2	30.49
	-7.0	-7.6	101.9	34.15	101.9	33.07	101.3	32.20	101.3	31.07	101.3	30.36	96.2	29.76
	-5.0	-5.6	106.0	32.83	106.0	31.85	105.3	31.07	105.3	30.06	103.0	29.40	96.2	28.78
	-3.0	-3.7	110.0	31.52	110.0	30.64	109.2	29.93	106.6	29.04	103.0	28.44	96.2	27.81
	0.0	-0.7	116.2	29.53	115.8	28.81	110.2	28.23	106.6	27.51	103.0	27.01	96.2	26.34
	3.0	2.2	121.9	27.55	117.4	26.97	110.2	26.52	106.6	26.00	103.0	25.57	96.2	24.88
	5.0	4.1	124.3	26.23	117.4	25.76	110.2	25.40	106.6	24.98	103.0	24.62	96.2	23.90
	7.0	6.0	124.3	24.90	117.4	24.53	110.2	24.26	106.6	23.96	103.0	23.65	96.2	22.92
	9.0	7.9	124.3	23.98	117.4	23.62	110.2	23.36	106.6	23.08	103.0	22.77	96.2	22.07
	11.0	9.8	124.3	23.25	117.4	22.91	110.2	22.65	106.6	22.37	103.0	22.08	96.2	21.40
	13.0	11.8	124.3	22.48	117.4	22.15	110.2	21.90	106.6	21.63	103.0	21.35	96.2	20.70
15.0	13.7	124.3	21.67	117.4	21.34	110.2	21.10	106.6	20.85	103.0	20.58	96.2	19.94	

# 7. Capacity Tables

Heating Capacity (32HP)

Combination (%)	Outdoor air temp.		Indoor air temp. °C DB											
			16		18		20		21		22		24	
	°C DB	°C WB	TC	PI	TC	PI	TC	PI	TC	PI	TC	PI	TC	PI
100	-24.8	-25	62.3	36.69	62.3	36.60	62.0	34.28	62.0	36.37	62.0	36.28	61.1	36.23
	-21.8	-22	75.1	36.56	75.1	36.46	74.7	35.36	74.7	36.24	74.7	36.63	73.6	36.10
	-19.8	-20	78.9	36.46	78.9	36.36	78.4	36.04	78.4	36.14	78.4	36.21	77.3	36.00
	-18.8	-19	80.7	36.41	80.2	36.33	80.2	36.24	80.2	36.09	80.2	36.00	79.1	35.41
	-16.7	-17	83.9	36.32	83.9	36.23	83.9	36.63	83.4	36.00	83.4	34.78	82.2	34.18
	-13.7	-15	89.6	36.18	89.6	36.09	89.1	36.00	89.1	34.23	89.1	33.04	87.9	32.41
	-11.8	-13	92.5	36.10	92.0	36.00	92.0	34.81	92.0	33.10	92.0	31.93	87.9	31.28
	-9.8	-11	95.6	36.00	95.6	34.66	95.2	33.55	95.2	31.92	94.4	30.77	87.9	30.10
	-9.5	-10	96.2	35.79	96.2	34.45	95.7	33.35	95.7	31.74	94.4	30.60	87.9	29.93
	-8.5	-9.1	98.3	35.08	98.3	33.79	97.8	32.73	97.6	31.14	94.4	30.01	87.9	29.34
	-7.0	-7.6	103.0	34.02	102.6	32.77	100.8	31.77	97.6	30.25	94.4	29.14	87.9	28.45
	-5.0	-5.6	107.5	32.60	106.4	31.43	100.8	30.51	97.6	29.07	94.4	27.98	87.9	27.28
	-3.0	-3.7	110.6	31.19	107.2	30.09	100.8	29.26	97.6	27.88	94.4	26.82	87.9	26.10
	0.0	-0.7	113.7	29.07	107.2	28.07	100.8	27.36	97.6	26.11	94.4	25.07	87.9	24.33
	3.0	2.2	113.7	26.94	107.2	26.05	100.8	25.47	97.6	24.33	94.4	23.34	87.9	22.56
	5.0	4.1	113.7	25.53	107.2	24.70	100.8	24.21	97.6	23.14	94.4	22.17	87.9	21.38
	7.0	6.0	113.7	24.11	107.2	23.36	100.8	22.95	97.6	21.95	94.4	21.01	87.9	20.20
	9.0	7.9	113.7	23.06	107.2	22.34	100.8	21.95	97.6	21.00	94.4	20.10	87.9	19.32
	11.0	9.8	113.7	22.20	107.2	21.50	100.8	21.13	97.6	20.21	94.4	19.34	87.9	18.60
	13.0	11.8	113.7	21.29	107.2	20.62	100.8	20.26	97.6	19.38	94.4	18.55	87.9	17.83
15.0	13.7	113.7	20.33	107.2	19.68	100.8	19.34	97.6	18.51	94.4	17.71	87.9	17.03	
90	-24.8	-25	62.1	32.64	62.1	33.20	61.7	33.60	61.7	33.78	61.7	34.17	60.9	34.73
	-21.8	-22	74.8	33.20	74.8	33.77	74.4	34.17	74.4	34.35	74.4	34.73	73.3	33.18
	-19.8	-20	78.6	33.59	78.6	34.14	78.1	34.54	78.1	34.73	78.1	33.67	77.1	32.16
	-18.8	-19	80.7	33.77	80.2	34.34	79.9	34.73	79.9	34.18	79.9	33.14	78.8	31.64
	-16.7	-17	83.9	34.17	83.9	34.73	83.5	33.59	83.5	33.03	83.5	32.03	80.3	30.56
	-13.7	-15	89.6	34.73	89.6	33.03	88.8	31.97	88.8	31.40	86.5	30.44	80.3	29.02
	-11.8	-13	92.5	33.56	92.0	31.96	91.7	30.94	89.4	30.36	86.5	29.43	80.3	28.04
	-9.8	-11	95.6	32.34	95.6	30.84	92.2	29.87	89.4	29.26	86.5	28.38	80.3	27.01
	-9.5	-10	96.2	32.15	96.2	30.66	92.2	29.70	89.4	29.09	86.5	28.22	80.3	26.86
	-8.5	-9.1	98.3	31.54	97.5	30.11	92.2	29.16	89.4	28.55	86.5	27.69	80.3	26.34
	-7.0	-7.6	103.0	30.62	97.9	29.26	92.2	28.35	89.4	27.73	86.5	26.89	80.3	25.57
	-5.0	-5.6	104.1	29.39	97.9	28.13	92.2	27.27	89.4	26.64	86.5	25.83	80.3	24.55
	-3.0	-3.7	104.1	28.17	97.9	27.00	92.2	26.19	89.4	25.54	86.5	24.77	80.3	23.51
	0.0	-0.7	104.1	26.33	97.9	25.30	92.2	24.57	89.4	23.90	86.5	23.19	80.3	21.97
	3.0	2.2	104.1	24.49	97.9	23.62	92.2	22.95	89.4	22.27	86.5	21.60	80.3	20.43
	5.0	4.1	104.1	23.26	97.9	22.48	92.2	21.86	89.4	21.17	86.5	20.54	80.3	19.39
	7.0	6.0	104.1	22.04	97.9	21.36	92.2	20.78	89.4	20.08	86.5	19.48	80.3	18.37
	9.0	7.9	104.1	20.89	97.9	20.25	92.2	19.71	89.4	19.03	86.5	18.47	80.3	17.41
	11.0	9.8	104.1	19.74	97.9	19.14	92.2	18.62	89.4	17.99	86.5	17.45	80.3	16.46
	13.0	11.8	104.1	18.60	97.9	18.03	92.2	17.54	89.4	16.94	86.5	16.44	80.3	15.50
15.0	13.7	104.1	17.45	97.9	16.91	92.2	16.46	89.4	15.89	86.5	15.42	80.3	14.55	
80	-24.8	-25	61.8	28.70	61.8	29.27	61.5	29.67	61.5	29.85	61.5	30.80	60.6	29.44
	-21.8	-22	74.0	29.27	74.0	29.84	74.0	30.23	74.0	30.80	74.0	29.44	71.8	28.14
	-19.8	-20	77.8	29.65	77.8	30.21	77.8	30.80	77.8	29.83	76.9	28.53	71.8	27.27
	-18.8	-19	79.6	29.84	79.6	30.80	79.6	30.30	79.4	29.35	77.1	28.08	71.8	26.84
	-16.7	-17	82.5	30.80	82.5	29.77	82.5	29.28	80.0	28.35	77.1	27.13	71.8	25.93
	-13.7	-15	86.2	29.28	84.6	28.31	82.5	27.81	80.0	26.90	77.1	25.77	71.8	24.63
	-11.8	-13	88.5	28.31	85.9	27.38	82.5	26.88	80.0	25.99	77.1	24.91	71.8	23.80
	-9.8	-11	90.9	27.29	87.1	26.41	82.5	25.90	80.0	25.03	77.1	24.01	71.8	22.94
	-9.5	-10	91.5	27.14	87.5	26.26	82.5	25.75	80.0	24.89	77.1	23.87	71.8	22.80
	-8.5	-9.1	92.4	26.64	87.9	25.78	82.5	25.27	80.0	24.40	77.1	23.41	71.8	22.38
	-7.0	-7.6	93.3	25.88	87.9	25.04	82.5	24.53	80.0	23.68	77.1	22.74	71.8	21.72
	-5.0	-5.6	93.3	24.86	87.9	24.08	82.5	23.56	80.0	22.72	77.1	21.82	71.8	20.86
	-3.0	-3.7	93.3	23.84	87.9	23.10	82.5	22.58	80.0	21.76	77.1	20.92	71.8	19.98
	0.0	-0.7	93.3	22.32	87.9	21.64	82.5	21.11	80.0	20.32	77.1	19.56	71.8	18.68
	3.0	2.2	93.3	20.80	87.9	20.17	82.5	19.64	80.0	18.87	77.1	18.20	71.8	17.39
	5.0	4.1	93.3	19.78	87.9	19.20	82.5	18.66	80.0	17.91	77.1	17.30	71.8	16.52
	7.0	6.0	93.3	18.77	87.9	18.22	82.5	17.69	80.0	16.95	77.1	16.39	71.8	15.65
	9.0	7.9	93.3	17.62	87.9	17.11	82.5	16.61	80.0	15.92	77.1	15.39	71.8	14.70
	11.0	9.8	93.3	16.36	87.9	15.89	82.5	15.42	80.0	14.77	77.1	14.28	71.8	13.64
	13.0	11.8	93.3	15.27	87.9	14.83	82.5	14.39	80.0	13.79	77.1	13.34	71.8	12.73
15.0	13.7	93.3	14.37	87.9	13.95	82.5	13.54	80.0	12.98	77.1	12.56	71.8	11.98	

# 7. Capacity Tables

## Heating Capacity (32HP)

Combination (%)	Outdoor air temp.		Indoor air temp. °C DB											
			16		18		20		21		22		24	
	°C DB	°C WB	TC	PI	TC	PI	TC	PI	TC	PI	TC	PI	TC	PI
70	-24.8	-25	61.8	28.79	61.8	28.98	61.5	29.36	61.5	29.92	61.5	28.47	60.5	27.10
	-21.8	-22	70.7	29.36	70.7	29.54	70.2	29.92	67.8	28.47	65.8	27.10	61.4	25.79
	-19.8	-20	76.6	29.74	74.7	29.92	70.2	28.90	67.8	27.50	65.8	26.20	61.4	24.92
	-18.8	-19	78.8	29.92	74.7	29.39	70.2	28.38	67.8	27.00	65.8	25.74	61.4	24.48
	-16.7	-17	79.0	28.82	74.7	28.27	70.2	27.31	67.8	25.99	65.8	24.79	61.4	23.56
	-13.7	-15	79.0	27.24	74.7	26.68	70.2	25.77	67.8	24.53	65.8	23.43	61.4	22.25
	-11.8	-13	79.0	26.23	74.7	25.67	70.2	24.80	67.8	23.60	65.8	22.56	61.4	21.42
	-9.8	-11	79.0	25.19	74.7	24.61	70.2	23.77	67.8	22.63	65.8	21.66	61.4	20.54
	-9.5	-10	79.0	25.02	74.7	24.45	70.2	23.62	67.8	22.49	65.8	21.53	61.4	20.41
	-8.5	-9.1	79.0	24.50	74.7	23.92	70.2	23.11	67.8	22.00	65.8	21.07	61.4	19.98
	-7.0	-7.6	79.0	23.71	74.7	23.13	70.2	22.34	67.8	21.28	65.8	20.39	61.4	19.32
	-5.0	-5.6	79.0	22.66	74.7	22.06	70.2	21.31	67.8	20.30	65.8	19.48	61.4	18.45
	-3.0	-3.7	79.0	21.61	74.7	21.00	70.2	20.29	67.8	19.33	65.8	18.57	61.4	17.57
	0.0	-0.7	79.0	20.03	74.7	19.41	70.2	18.75	67.8	17.88	65.8	17.21	61.4	16.26
	3.0	2.2	79.0	18.45	74.7	17.81	70.2	17.21	67.8	16.42	65.8	15.86	61.4	14.94
	5.0	4.1	79.0	17.40	74.7	16.74	70.2	16.19	67.8	15.45	65.8	14.94	61.4	14.08
	7.0	6.0	79.0	16.34	74.7	15.69	70.2	15.16	67.8	14.48	65.8	14.04	61.4	13.20
	9.0	7.9	79.0	14.76	74.7	14.17	70.2	13.69	67.8	13.07	65.8	12.67	61.4	11.92
11.0	9.8	79.0	13.75	74.7	13.19	70.2	12.75	67.8	12.17	65.8	11.81	61.4	11.09	
13.0	11.8	79.0	12.86	74.7	12.34	70.2	11.92	67.8	11.39	65.8	11.04	61.4	10.39	
15.0	13.7	79.0	12.12	74.7	11.64	70.2	11.25	67.8	10.73	65.8	10.41	61.4	9.79	
60	-24.8	-25	60.6	28.34	60.6	28.72	60.2	29.29	58.2	27.75	56.2	26.30	52.6	24.95
	-21.8	-22	64.9	28.91	64.2	29.29	60.2	27.75	58.2	26.30	56.2	24.95	52.6	23.64
	-19.8	-20	67.8	29.29	64.2	28.20	60.2	26.72	58.2	25.34	56.2	24.04	52.6	22.77
	-18.8	-19	67.8	28.74	64.2	27.66	60.2	26.21	58.2	24.86	56.2	23.59	52.6	22.33
	-16.7	-17	67.8	27.58	64.2	26.50	60.2	25.13	58.2	23.85	56.2	22.65	52.6	21.42
	-13.7	-15	67.8	25.92	64.2	24.87	60.2	23.58	58.2	22.41	56.2	21.29	52.6	20.11
	-11.8	-13	67.8	24.88	64.2	23.83	60.2	22.60	58.2	21.49	56.2	20.43	52.6	19.29
	-9.8	-11	67.8	23.77	64.2	22.74	60.2	21.58	58.2	20.53	56.2	19.53	52.6	18.41
	-9.5	-10	67.8	23.60	64.2	22.58	60.2	21.43	58.2	20.38	56.2	19.39	52.6	18.28
	-8.5	-9.1	67.8	23.05	64.2	22.04	60.2	20.91	58.2	19.91	56.2	18.94	52.6	17.85
	-7.0	-7.6	67.8	22.23	64.2	21.22	60.2	20.14	58.2	19.18	56.2	18.26	52.6	17.20
	-5.0	-5.6	67.8	21.12	64.2	20.13	60.2	19.12	58.2	18.22	56.2	17.36	52.6	16.32
	-3.0	-3.7	67.8	20.02	64.2	19.04	60.2	18.09	58.2	17.26	56.2	16.45	52.6	15.45
	0.0	-0.7	67.8	18.36	64.2	17.39	60.2	16.55	58.2	15.81	56.2	15.10	52.6	14.15
	3.0	2.2	67.8	16.71	64.2	15.76	60.2	15.00	58.2	14.37	56.2	13.74	52.6	12.84
	5.0	4.1	67.8	15.61	64.2	14.67	60.2	13.98	58.2	13.41	56.2	12.84	52.6	11.97
	7.0	6.0	67.8	14.50	64.2	13.58	60.2	12.95	58.2	12.44	56.2	11.94	52.6	11.09
	9.0	7.9	67.8	12.94	64.2	12.12	60.2	11.55	58.2	11.11	56.2	10.65	52.6	9.90
11.0	9.8	67.8	12.08	64.2	11.31	60.2	10.78	58.2	10.37	56.2	9.95	52.6	9.25	
13.0	11.8	67.8	11.31	64.2	10.59	60.2	10.11	58.2	9.72	56.2	9.31	52.6	8.66	
15.0	13.7	67.8	10.69	64.2	10.02	60.2	9.55	58.2	9.17	56.2	8.81	52.6	8.19	
50	-24.8	-25	56.6	25.00	53.4	25.56	50.2	24.19	48.6	22.90	46.9	21.69	43.7	20.56
	-21.8	-22	56.6	25.56	53.4	24.19	50.2	22.90	48.6	21.69	46.9	20.56	43.7	19.47
	-19.8	-20	56.6	24.60	53.4	23.27	50.2	22.04	48.6	20.87	46.9	19.80	43.7	18.74
	-18.8	-19	56.6	24.12	53.4	22.80	50.2	21.62	48.6	20.47	46.9	19.43	43.7	18.39
	-16.7	-17	56.6	23.11	53.4	21.85	50.2	20.72	48.6	19.61	46.9	18.63	43.7	17.63
	-13.7	-15	56.6	21.67	53.4	20.46	50.2	19.42	48.6	18.40	46.9	17.50	43.7	16.54
	-11.8	-13	56.6	20.75	53.4	19.59	50.2	18.61	48.6	17.63	46.9	16.79	43.7	15.86
	-9.8	-11	56.6	19.79	53.4	18.67	50.2	17.75	48.6	16.82	46.9	16.03	43.7	15.13
	-9.5	-10	56.6	19.64	53.4	18.54	50.2	17.62	48.6	16.70	46.9	15.93	43.7	15.02
	-8.5	-9.1	56.6	19.16	53.4	18.07	50.2	17.20	48.6	16.30	46.9	15.55	43.7	14.66
	-7.0	-7.6	56.6	18.43	53.4	17.39	50.2	16.55	48.6	15.69	46.9	14.98	43.7	14.12
	-5.0	-5.6	56.6	17.47	53.4	16.47	50.2	15.70	48.6	14.88	46.9	14.23	43.7	13.40
	-3.0	-3.7	56.6	16.51	53.4	15.55	50.2	14.83	48.6	14.07	46.9	13.47	43.7	12.67
	0.0	-0.7	56.6	15.07	53.4	14.16	50.2	13.55	48.6	12.86	46.9	12.34	43.7	11.59
	3.0	2.2	56.6	13.62	53.4	12.79	50.2	12.26	48.6	11.64	46.9	11.21	43.7	10.50
	5.0	4.1	56.6	12.66	53.4	11.87	50.2	11.41	48.6	10.83	46.9	10.46	43.7	9.78
	7.0	6.0	56.6	11.70	53.4	10.95	50.2	10.55	48.6	10.02	46.9	9.70	43.7	9.06
	9.0	7.9	56.6	10.56	53.4	9.89	50.2	9.53	48.6	9.05	46.9	8.77	43.7	8.18
11.0	9.8	56.6	9.89	53.4	9.25	50.2	8.91	48.6	8.47	46.9	8.20	43.7	7.65	
13.0	11.8	56.6	9.28	53.4	8.69	50.2	8.37	48.6	7.95	46.9	7.70	43.7	7.19	
15.0	13.7	56.6	8.78	53.4	8.22	50.2	7.92	48.6	7.52	46.9	7.29	43.7	6.80	

**Note**

1. TC: Total Capacity(kW), PI : Power Input(kW, Comp. + Outdoor fan motor)
2. Capacity tables show the average value of conditions which may occur.
3. The heating capacity table is based on the values expressed as Max. in the specification of the outdoor unit. (When measuring the Max. heating capacity, the setting status of the indoor unit is the same as that for measuring the heating capacity of the indoor unit.)

# 7. Capacity Tables

## ◆ ARUM340LTE5

Heating Capacity (34HP)

Combination (%)	Outdoor air temp.		Indoor air temp. °C DB											
			16		18		20		21		22		24	
	°C DB	°C WB	TC	PI	TC	PI	TC	PI	TC	PI	TC	PI	TC	PI
130	-24.8	-25	67.3	35.6	67.3	35.90	67.0	36.16	67.0	36.55	67.0	36.93	66.0	37.52
	-21.8	-22	81.2	36.20	81.2	36.49	80.7	36.75	80.7	37.14	80.7	37.52	79.6	38.10
	-19.8	-20	85.3	36.59	85.3	36.89	84.7	37.14	84.7	37.53	84.7	37.91	83.6	38.50
	-18.8	-19	87.2	36.79	87.2	37.08	86.6	37.34	86.6	37.73	86.6	38.10	85.5	38.69
	-16.7	-17	91.2	37.20	91.2	37.49	90.6	37.75	90.6	38.14	90.6	38.51	89.3	39.10
	-13.7	-15	96.9	37.79	96.9	38.08	96.3	38.34	96.3	38.73	96.3	39.10	94.9	37.54
	-11.8	-13	100.1	38.17	100.1	38.46	99.5	38.72	99.5	39.10	99.5	38.05	98.5	36.55
	-9.8	-11	103.5	38.55	103.5	38.85	102.7	39.10	102.7	37.98	102.7	36.94	101.9	35.51
	-9.5	-10	104.1	38.62	104.1	38.91	103.4	38.93	103.4	37.80	103.3	36.77	102.5	35.35
	-8.5	-9.1	106.3	38.81	106.3	39.10	105.6	38.35	105.6	37.23	105.0	36.21	104.2	34.83
	-7.0	-7.6	109.6	39.10	109.6	38.24	108.9	37.47	108.9	36.38	108.9	35.38	107.5	34.05
	-5.0	-5.6	114.0	37.97	114.0	37.09	113.2	36.30	113.2	35.24	113.2	34.26	111.2	33.00
	-3.0	-3.7	118.4	36.84	118.4	35.93	117.6	35.13	117.6	34.10	117.6	33.15	114.9	31.96
	0.0	-0.7	124.9	35.13	124.9	34.20	124.2	33.37	124.2	32.40	124.2	31.47	120.2	30.40
	3.0	2.2	131.5	33.43	131.5	32.46	130.7	31.61	130.7	30.70	129.2	29.80	120.9	28.84
	5.0	4.1	135.4	32.29	135.4	31.30	134.7	30.45	133.5	29.56	129.8	28.69	120.9	27.79
	7.0	6.0	138.0	31.15	138.0	30.15	137.2	29.27	134.6	28.42	129.8	27.57	120.9	26.75
	9.0	7.9	138.5	30.21	138.5	29.23	138.0	28.38	134.6	27.55	129.8	26.74	120.9	25.94
	11.0	9.8	138.5	29.52	138.5	28.57	138.0	27.74	134.6	26.93	129.8	26.13	120.9	25.35
	13.0	11.8	138.5	28.79	138.5	27.86	138.0	27.05	134.6	26.26	129.8	25.48	120.9	24.72
15.0	13.7	138.5	28.00	138.5	27.10	138.0	26.31	134.6	25.55	129.8	24.78	120.9	24.04	
120	-24.8	-25	66.9	35.90	66.9	36.16	66.5	36.55	66.5	36.93	66.5	37.52	65.5	37.93
	-21.8	-22	80.6	36.49	80.6	36.75	80.1	37.14	80.1	37.52	80.1	38.10	79.0	38.51
	-19.8	-20	84.7	36.89	84.7	37.14	84.1	37.53	84.1	37.91	84.1	38.50	83.0	38.91
	-18.8	-19	86.6	37.08	86.6	37.34	86.0	37.73	86.0	38.10	86.0	38.69	84.9	39.10
	-16.7	-17	90.6	37.49	90.6	37.75	90.0	38.14	90.0	38.51	90.0	39.10	88.7	38.11
	-13.7	-15	96.2	38.08	96.2	38.34	95.6	38.73	95.6	39.10	95.6	37.60	94.3	36.67
	-11.8	-13	99.3	38.46	99.3	38.72	98.7	39.10	98.7	38.04	98.7	36.65	97.7	35.75
	-9.8	-11	102.7	38.85	102.7	39.10	102.1	37.93	102.1	36.92	102.1	35.65	101.3	34.79
	-9.5	-10	103.4	38.91	103.4	38.92	102.8	37.76	102.8	36.75	102.8	35.50	101.9	34.65
	-8.5	-9.1	105.6	39.10	105.6	38.29	104.8	37.16	104.8	36.19	104.8	35.00	103.9	33.17
	-7.0	-7.6	108.8	38.17	108.8	37.36	108.2	36.28	108.2	35.35	108.0	34.24	106.7	33.45
	-5.0	-5.6	113.2	36.91	113.2	36.10	112.4	35.10	112.4	34.22	112.4	33.24	110.4	32.49
	-3.0	-3.7	117.6	35.66	117.6	34.85	116.8	33.92	116.8	33.10	116.8	32.24	113.6	31.53
	0.0	-0.7	124.0	33.77	124.0	32.97	123.2	32.15	123.2	31.42	122.0	30.73	113.6	30.09
	3.0	2.2	130.6	31.89	130.6	31.09	128.9	30.38	126.1	29.73	122.2	29.23	113.6	28.66
	5.0	4.1	134.4	30.64	133.9	29.84	130.6	29.20	126.1	28.61	122.2	28.23	113.6	27.70
	7.0	6.0	137.0	29.38	135.9	28.59	130.6	28.02	126.1	27.48	122.2	27.23	113.6	26.74
	9.0	7.9	137.3	28.42	135.9	27.65	130.6	27.12	126.1	26.60	122.2	26.35	113.6	25.87
	11.0	9.8	137.3	27.72	135.9	26.96	130.6	26.43	126.1	25.93	122.2	25.68	113.6	25.23
	13.0	11.8	137.3	26.96	135.9	26.22	130.6	25.71	126.1	25.22	122.2	24.98	113.6	24.53
15.0	13.7	137.3	26.14	135.9	25.43	130.6	24.94	126.1	24.46	122.2	24.23	113.6	23.79	
110	-24.8	-25	66.5	36.16	66.5	36.55	66.1	36.93	66.1	37.52	66.1	37.93	65.2	38.13
	-21.8	-22	80.2	36.75	80.2	37.14	79.7	37.52	79.7	38.10	79.7	38.51	78.6	38.72
	-19.8	-20	84.2	37.14	84.2	37.53	83.8	37.91	83.8	38.50	83.8	38.91	82.5	39.10
	-18.8	-19	86.1	37.34	86.1	37.73	85.5	38.10	85.5	38.69	85.5	39.10	84.4	38.58
	-16.7	-17	90.1	37.75	90.1	38.14	89.5	38.51	89.5	39.10	89.5	38.02	88.2	37.47
	-13.7	-15	95.7	38.34	95.7	38.73	95.1	39.10	95.1	37.47	95.1	36.47	95.1	35.89
	-11.8	-13	98.9	38.72	98.9	39.10	98.2	37.94	98.2	36.43	98.2	35.49	98.2	34.90
	-9.8	-11	102.1	39.10	102.1	37.80	101.5	36.73	101.5	35.33	101.5	34.46	101.0	33.84
	-9.5	-10	102.8	38.89	102.8	37.59	102.2	36.54	102.2	35.16	102.2	34.31	101.9	33.68
	-8.5	-9.1	105.0	38.19	105.0	36.94	104.3	35.93	104.3	34.61	104.3	33.79	102.2	33.16
	-7.0	-7.6	108.2	37.12	108.2	35.95	107.6	35.01	107.6	33.79	107.6	33.02	102.2	32.37
	-5.0	-5.6	112.6	35.69	112.6	34.63	111.8	33.79	111.8	32.70	109.4	31.98	102.2	31.31
	-3.0	-3.7	116.9	34.27	116.9	33.33	116.0	32.56	113.3	31.60	109.4	30.95	102.2	30.26
	0.0	-0.7	123.4	32.13	123.0	31.35	117.1	30.72	113.3	29.95	109.4	29.41	102.2	28.68
	3.0	2.2	129.5	30.00	124.7	29.37	117.1	28.89	113.3	28.32	109.4	27.85	102.2	27.10
	5.0	4.1	132.0	28.58	124.7	28.06	117.1	27.67	113.3	27.22	109.4	26.82	102.2	26.05
	7.0	6.0	132.0	27.15	124.7	26.75	117.1	26.45	113.3	26.12	109.4	25.79	102.2	24.99
	9.0	7.9	132.0	26.16	124.7	25.76	117.1	25.48	113.3	25.17	109.4	24.84	102.2	24.08
	11.0	9.8	132.0	25.38	124.7	25.00	117.1	24.72	113.3	24.42	109.4	24.10	102.2	23.36
	13.0	11.8	132.0	24.55	124.7	24.19	117.1	23.91	113.3	23.62	109.4	23.32	102.2	22.61
15.0	13.7	132.0	23.68	124.7	23.33	117.1	23.06	113.3	22.78	109.4	22.49	102.2	21.79	

# 7. Capacity Tables

Heating Capacity (34HP)

Combination (%)	Outdoor air temp.		Indoor air temp. °C DB											
			16		18		20		21		22		24	
	°C DB	°C WB	TC	PI	TC	PI	TC	PI	TC	PI	TC	PI	TC	PI
100	-24.8	-25	66.2	39.96	66.2	39.84	65.8	37.28	65.8	39.57	65.8	39.45	64.9	39.39
	-21.8	-22	79.8	39.80	79.8	39.68	79.4	38.46	79.4	39.40	79.4	39.81	78.2	39.22
	-19.8	-20	83.9	39.68	83.9	39.56	83.3	39.20	83.3	39.28	83.3	39.34	82.2	39.10
	-18.8	-19	85.7	39.62	85.2	39.51	85.2	39.40	85.2	39.22	85.2	39.10	84.0	38.47
	-16.7	-17	89.2	39.50	89.2	39.39	89.2	39.81	88.6	39.10	88.6	37.79	87.3	37.13
	-13.7	-15	95.2	39.33	95.2	39.21	94.7	39.10	94.7	37.19	94.7	35.91	93.4	35.22
	-11.8	-13	98.3	39.22	97.8	39.10	97.8	37.82	97.8	35.97	97.8	34.71	93.4	34.01
	-9.8	-11	101.6	39.10	101.6	37.65	101.1	36.46	101.1	34.69	100.3	33.46	93.4	32.73
	-9.5	-10	102.2	38.88	102.2	37.44	101.7	36.24	101.7	34.50	100.3	33.26	93.4	32.54
	-8.5	-9.1	104.4	38.11	104.4	36.72	103.9	35.57	103.7	33.86	100.3	32.63	93.4	31.91
	-7.0	-7.6	109.4	36.97	109.0	35.62	107.1	34.54	103.7	32.90	100.3	31.69	93.4	30.95
	-5.0	-5.6	114.2	35.44	113.1	34.17	107.1	33.18	103.7	31.62	100.3	30.44	93.4	29.67
	-3.0	-3.7	117.5	33.92	113.9	32.72	107.1	31.83	103.7	30.33	100.3	29.19	93.4	28.40
	0.0	-0.7	120.8	31.63	113.9	30.54	107.1	29.78	103.7	28.42	100.3	27.30	93.4	26.49
	3.0	2.2	120.8	29.34	113.9	28.37	107.1	27.74	103.7	26.50	100.3	25.42	93.4	24.57
	5.0	4.1	120.8	27.82	113.9	26.92	107.1	26.38	103.7	25.21	100.3	24.16	93.4	23.30
	7.0	6.0	120.8	26.29	113.9	25.47	107.1	25.02	103.7	23.93	100.3	22.90	93.4	22.02
	9.0	7.9	120.8	25.16	113.9	24.37	107.1	23.94	103.7	22.91	100.3	21.92	93.4	21.08
	11.0	9.8	120.8	24.24	113.9	23.48	107.1	23.07	103.7	22.07	100.3	21.12	93.4	20.31
	13.0	11.8	120.8	23.27	113.9	22.53	107.1	22.14	103.7	21.18	100.3	20.27	93.4	19.49
15.0	13.7	120.8	22.24	113.9	21.54	107.1	21.16	103.7	20.25	100.3	19.38	93.4	18.63	
90	-24.8	-25	65.9	35.56	65.9	36.15	65.6	36.56	65.6	36.76	65.6	37.15	64.7	37.75
	-21.8	-22	79.5	36.15	79.5	36.74	79.1	37.15	79.1	37.35	79.1	37.75	77.9	36.07
	-19.8	-20	83.5	36.55	83.5	37.13	83.0	37.54	83.0	37.75	83.0	36.60	81.9	34.96
	-18.8	-19	85.7	36.74	85.2	37.33	84.9	37.75	84.9	37.15	84.9	36.02	83.7	34.40
	-16.7	-17	89.2	37.15	89.2	37.75	88.7	36.51	88.7	35.91	88.7	34.82	85.3	33.23
	-13.7	-15	95.2	37.75	95.2	35.91	94.3	34.76	94.3	34.14	91.9	33.10	85.3	31.56
	-11.8	-13	98.3	36.48	97.8	34.75	97.5	33.65	94.9	33.01	91.9	32.01	85.3	30.50
	-9.8	-11	101.6	35.16	101.6	33.54	98.0	32.48	94.9	31.83	91.9	30.87	85.3	29.39
	-9.5	-10	102.2	34.96	102.2	33.35	98.0	32.31	94.9	31.65	91.9	30.69	85.3	29.22
	-8.5	-9.1	104.4	34.29	103.7	32.74	98.0	31.72	94.9	31.05	91.9	30.12	85.3	28.66
	-7.0	-7.6	109.4	33.30	104.1	31.83	98.0	30.84	94.9	30.17	91.9	29.26	85.3	27.83
	-5.0	-5.6	110.6	31.98	104.1	30.60	98.0	29.67	94.9	28.99	91.9	28.11	85.3	26.72
	-3.0	-3.7	110.6	30.65	104.1	29.39	98.0	28.51	94.9	27.80	91.9	26.96	85.3	25.59
	0.0	-0.7	110.6	28.67	104.1	27.55	98.0	26.75	94.9	26.03	91.9	25.25	85.3	23.93
	3.0	2.2	110.6	26.67	104.1	25.73	98.0	25.00	94.9	24.26	91.9	23.53	85.3	22.26
	5.0	4.1	110.6	25.35	104.1	24.50	98.0	23.82	94.9	23.07	91.9	22.38	85.3	21.14
	7.0	6.0	110.6	24.02	104.1	23.29	98.0	22.66	94.9	21.89	91.9	21.24	85.3	20.02
	9.0	7.9	110.6	22.78	104.1	22.08	98.0	21.49	94.9	20.76	91.9	20.14	85.3	18.99
	11.0	9.8	110.6	21.54	104.1	20.89	98.0	20.32	94.9	19.63	91.9	19.04	85.3	17.96
	13.0	11.8	110.6	20.31	104.1	19.68	98.0	19.15	94.9	18.50	91.9	17.95	85.3	16.93
15.0	13.7	110.6	19.07	104.1	18.47	98.0	17.98	94.9	17.36	91.9	16.85	85.3	15.89	
80	-24.8	-25	65.7	31.28	65.7	31.88	65.3	32.29	65.3	32.48	65.3	33.47	64.4	32.00
	-21.8	-22	78.7	31.88	78.7	32.47	78.7	32.88	78.7	33.47	78.7	32.00	76.2	30.59
	-19.8	-20	82.7	32.27	82.7	32.85	82.7	33.47	82.7	32.43	81.7	31.02	76.2	29.65
	-18.8	-19	84.5	32.47	84.5	33.47	84.5	32.93	84.4	31.90	81.9	30.52	76.2	29.18
	-16.7	-17	87.6	33.47	87.6	32.36	87.6	31.83	85.0	30.82	81.9	29.49	76.2	28.20
	-13.7	-15	91.6	31.82	89.8	30.78	87.6	30.24	85.0	29.25	81.9	28.02	76.2	26.79
	-11.8	-13	94.0	30.78	91.2	29.78	87.6	29.23	85.0	28.26	81.9	27.09	76.2	25.89
	-9.8	-11	96.6	29.68	92.6	28.72	87.6	28.17	85.0	27.23	81.9	26.11	76.2	24.96
	-9.5	-10	97.2	29.52	93.0	28.56	87.6	28.01	85.0	27.07	81.9	25.96	76.2	24.81
	-8.5	-9.1	98.2	28.97	93.4	28.04	87.6	27.49	85.0	26.55	81.9	25.47	76.2	24.35
	-7.0	-7.6	99.1	28.15	93.4	27.24	87.6	26.69	85.0	25.77	81.9	24.74	76.2	23.64
	-5.0	-5.6	99.1	27.05	93.4	26.20	87.6	25.64	85.0	24.72	81.9	23.75	76.2	22.70
	-3.0	-3.7	99.1	25.95	93.4	25.14	87.6	24.57	85.0	23.69	81.9	22.78	76.2	21.76
	0.0	-0.7	99.1	24.30	93.4	23.56	87.6	22.99	85.0	22.12	81.9	21.30	76.2	20.35
	3.0	2.2	99.1	22.66	93.4	21.97	87.6	21.40	85.0	20.56	81.9	19.83	76.2	18.94
	5.0	4.1	99.1	21.56	93.4	20.93	87.6	20.34	85.0	19.52	81.9	18.85	76.2	18.01
	7.0	6.0	99.1	20.47	93.4	19.87	87.6	19.29	85.0	18.48	81.9	17.87	76.2	17.06
	9.0	7.9	99.1	19.21	93.4	18.66	87.6	18.11	85.0	17.35	81.9	16.78	76.2	16.02
	11.0	9.8	99.1	17.83	93.4	17.32	87.6	16.81	85.0	16.11	81.9	15.57	76.2	14.87
	13.0	11.8	99.1	16.65	93.4	16.17	87.6	15.69	85.0	15.03	81.9	14.54	76.2	13.88
15.0	13.7	99.1	15.67	93.4	15.21	87.6	14.76	85.0	14.15	81.9	13.69	76.2	13.06	

## 7. Capacity Tables

## Heating Capacity (34HP)

Combination (%)	Outdoor air temp.		Indoor air temp. °C DB											
			16		18		20		21		22		24	
	°C DB	°C WB	TC	PI	TC	PI	TC	PI	TC	PI	TC	PI	TC	PI
70	-24.8	-25	65.7	31.35	65.7	31.54	65.3	31.94	65.3	32.53	65.3	30.96	64.3	29.47
	-21.8	-22	75.1	31.94	75.1	32.14	74.6	32.53	72.0	30.96	70.0	29.47	65.2	28.05
	-19.8	-20	81.3	32.34	79.3	32.53	74.6	31.42	72.0	29.90	70.0	28.49	65.2	27.11
	-18.8	-19	83.8	32.53	79.3	31.95	74.6	30.86	72.0	29.37	70.0	28.00	65.2	26.63
	-16.7	-17	84.0	31.33	79.3	30.74	74.6	29.70	72.0	28.27	70.0	26.97	65.2	25.63
	-13.7	-15	84.0	29.62	79.3	29.02	74.6	28.03	72.0	26.68	70.0	25.49	65.2	24.21
	-11.8	-13	84.0	28.53	79.3	27.92	74.6	26.98	72.0	25.68	70.0	24.55	65.2	23.31
	-9.8	-11	84.0	27.40	79.3	26.78	74.6	25.87	72.0	24.63	70.0	23.57	65.2	22.36
	-9.5	-10	84.0	27.22	79.3	26.60	74.6	25.70	72.0	24.48	70.0	23.43	65.2	22.22
	-8.5	-9.1	84.0	26.66	79.3	26.03	74.6	25.14	72.0	23.94	70.0	22.93	65.2	21.75
	-7.0	-7.6	84.0	25.80	79.3	25.17	74.6	24.31	72.0	23.16	70.0	22.20	65.2	21.03
	-5.0	-5.6	84.0	24.66	79.3	24.01	74.6	23.20	72.0	22.10	70.0	21.21	65.2	20.08
	-3.0	-3.7	84.0	23.52	79.3	22.86	74.6	22.09	72.0	21.05	70.0	20.22	65.2	19.13
	0.0	-0.7	84.0	21.81	79.3	21.14	74.6	20.42	72.0	19.47	70.0	18.75	65.2	17.71
	3.0	2.2	84.0	20.10	79.3	19.40	74.6	18.75	72.0	17.89	70.0	17.28	65.2	16.28
	5.0	4.1	84.0	18.96	79.3	18.25	74.6	17.64	72.0	16.84	70.0	16.28	65.2	15.34
	7.0	6.0	84.0	17.82	79.3	17.11	74.6	16.53	72.0	15.78	70.0	15.30	65.2	14.39
9.0	7.9	84.0	16.09	79.3	15.45	74.6	14.93	72.0	14.25	70.0	13.82	65.2	12.99	
11.0	9.8	84.0	14.99	79.3	14.38	74.6	13.90	72.0	13.27	70.0	12.87	65.2	12.09	
13.0	11.8	84.0	14.02	79.3	13.45	74.6	13.00	72.0	12.42	70.0	12.03	65.2	11.32	
15.0	13.7	84.0	13.21	79.3	12.69	74.6	12.26	72.0	11.70	70.0	11.35	65.2	10.67	
60	-24.8	-25	64.3	30.88	64.3	31.28	64.0	31.87	61.8	30.20	59.7	28.63	55.8	27.15
	-21.8	-22	68.9	31.47	68.2	31.87	64.0	30.20	61.8	28.63	59.7	27.15	55.8	25.73
	-19.8	-20	72.0	31.87	68.2	30.69	64.0	29.08	61.8	27.58	59.7	26.17	55.8	24.79
	-18.8	-19	72.0	31.28	68.2	30.10	64.0	28.52	61.8	27.05	59.7	25.68	55.8	24.31
	-16.7	-17	72.0	30.02	68.2	28.84	64.0	27.35	61.8	25.96	59.7	24.65	55.8	23.32
	-13.7	-15	72.0	28.21	68.2	27.07	64.0	25.67	61.8	24.39	59.7	23.18	55.8	21.90
	-11.8	-13	72.0	27.08	68.2	25.94	64.0	24.61	61.8	23.40	59.7	22.25	55.8	21.00
	-9.8	-11	72.0	25.88	68.2	24.76	64.0	23.50	61.8	22.35	59.7	21.26	55.8	20.05
	-9.5	-10	72.0	25.69	68.2	24.59	64.0	23.33	61.8	22.19	59.7	21.12	55.8	19.91
	-8.5	-9.1	72.0	25.10	68.2	23.99	64.0	22.77	61.8	21.67	59.7	20.62	55.8	19.44
	-7.0	-7.6	72.0	24.20	68.2	23.10	64.0	21.93	61.8	20.89	59.7	19.88	55.8	18.73
	-5.0	-5.6	72.0	23.00	68.2	21.92	64.0	20.82	61.8	19.84	59.7	18.91	55.8	17.78
	-3.0	-3.7	72.0	21.80	68.2	20.73	64.0	19.70	61.8	18.80	59.7	17.92	55.8	16.83
	0.0	-0.7	72.0	20.00	68.2	18.95	64.0	18.03	61.8	17.22	59.7	16.45	55.8	15.41
	3.0	2.2	72.0	18.21	68.2	17.17	64.0	16.35	61.8	15.66	59.7	14.98	55.8	13.99
	5.0	4.1	72.0	17.01	68.2	15.99	64.0	15.24	61.8	14.61	59.7	13.99	55.8	13.05
	7.0	6.0	72.0	15.81	68.2	14.81	64.0	14.11	61.8	13.57	59.7	13.02	55.8	12.10
9.0	7.9	72.0	14.11	68.2	13.21	64.0	12.60	61.8	12.11	59.7	11.61	55.8	10.79	
11.0	9.8	72.0	13.17	68.2	12.33	64.0	11.76	61.8	11.30	59.7	10.84	55.8	10.08	
13.0	11.8	72.0	12.33	68.2	11.55	64.0	11.02	61.8	10.59	59.7	10.15	55.8	9.45	
15.0	13.7	72.0	11.66	68.2	10.92	64.0	10.41	61.8	10.00	59.7	9.60	55.8	8.93	
50	-24.8	-25	60.1	27.19	56.7	27.78	53.3	26.29	51.6	24.89	49.9	23.58	46.5	22.35
	-21.8	-22	60.1	27.78	56.7	26.29	53.3	24.89	51.6	23.58	49.9	22.35	46.5	21.17
	-19.8	-20	60.1	26.74	56.7	25.29	53.3	23.96	51.6	22.69	49.9	21.53	46.5	20.39
	-18.8	-19	60.1	26.22	56.7	24.79	53.3	23.50	51.6	22.25	49.9	21.13	46.5	20.00
	-16.7	-17	60.1	25.12	56.7	23.75	53.3	22.53	51.6	21.33	49.9	20.26	46.5	19.17
	-13.7	-15	60.1	23.56	56.7	22.25	53.3	21.12	51.6	20.02	49.9	19.04	46.5	17.99
	-11.8	-13	60.1	22.57	56.7	21.30	53.3	20.24	51.6	19.18	49.9	18.26	46.5	17.25
	-9.8	-11	60.1	21.52	56.7	20.31	53.3	19.31	51.6	18.30	49.9	17.45	46.5	16.46
	-9.5	-10	60.1	21.36	56.7	20.16	53.3	19.17	51.6	18.17	49.9	17.33	46.5	16.35
	-8.5	-9.1	60.1	20.84	56.7	19.66	53.3	18.71	51.6	17.73	49.9	16.92	46.5	15.96
	-7.0	-7.6	60.1	20.06	56.7	18.92	53.3	18.01	51.6	17.08	49.9	16.30	46.5	15.36
	-5.0	-5.6	60.1	19.01	56.7	17.92	53.3	17.08	51.6	16.19	49.9	15.49	46.5	14.59
	-3.0	-3.7	60.1	17.97	56.7	16.92	53.3	16.15	51.6	15.32	49.9	14.67	46.5	13.80
	0.0	-0.7	60.1	16.40	56.7	15.42	53.3	14.76	51.6	14.00	49.9	13.44	46.5	12.62
	3.0	2.2	60.1	14.84	56.7	13.93	53.3	13.36	51.6	12.68	49.9	12.22	46.5	11.44
	5.0	4.1	60.1	13.80	56.7	12.93	53.3	12.43	51.6	11.80	49.9	11.40	46.5	10.66
	7.0	6.0	60.1	12.75	56.7	11.94	53.3	11.50	51.6	10.93	49.9	10.58	46.5	9.87
9.0	7.9	60.1	11.51	56.7	10.78	53.3	10.39	51.6	9.87	49.9	9.56	46.5	8.91	
11.0	9.8	60.1	10.78	56.7	10.09	53.3	9.72	51.6	9.23	49.9	8.94	46.5	8.34	
13.0	11.8	60.1	10.12	56.7	9.47	53.3	9.12	51.6	8.67	49.9	8.40	46.5	7.84	
15.0	13.7	60.1	9.57	56.7	8.96	53.3	8.63	51.6	8.20	49.9	7.94	46.5	7.42	

## Note

1. TC: Total Capacity(kW), PI : Power Input(kW, Comp. + Outdoor fan motor)
2. Capacity tables show the average value of conditions which may occur.
3. The heating capacity table is based on the values expressed as Max. in the specification of the outdoor unit. (When measuring the Max. heating capacity, the setting status of the indoor unit is the same as that for measuring the heating capacity of the indoor unit.)

# 7. Capacity Tables

## ◆ ARUM360LTE5

Heating Capacity (36HP)

Combination (%)	Outdoor air temp.		Indoor air temp. °C DB											
			16		18		20		21		22		24	
	°C DB	°C WB	TC	PI	TC	PI	TC	PI	TC	PI	TC	PI	TC	PI
130	-24.8	-25	69.3	37.2	69.3	37.57	68.9	37.94	68.9	38.49	68.9	39.04	68.0	39.89
	-21.8	-22	84.4	37.99	84.4	38.41	83.8	38.78	83.8	39.34	83.8	39.89	82.6	40.72
	-19.8	-20	89.0	38.55	89.0	38.98	88.4	39.34	88.4	39.91	88.4	40.44	87.2	41.29
	-18.8	-19	91.1	38.84	91.1	39.26	90.5	39.63	90.5	40.19	90.5	40.72	89.2	41.57
	-16.7	-17	95.4	39.43	95.4	39.85	94.8	40.22	94.8	40.78	94.8	41.32	93.4	42.16
	-13.7	-15	101.5	40.28	101.5	40.70	100.9	41.07	100.9	41.63	100.9	42.16	99.4	40.49
	-11.8	-13	104.8	40.82	104.8	41.23	104.2	41.60	104.2	42.16	104.2	41.04	103.2	39.43
	-9.8	-11	108.3	41.37	108.3	41.80	107.6	42.16	107.6	40.96	107.6	39.85	106.9	38.32
	-9.5	-10	108.9	41.47	108.9	41.88	108.3	41.98	108.3	40.77	108.1	39.67	107.5	38.14
	-8.5	-9.1	111.2	41.74	111.2	42.16	110.6	41.35	110.6	40.16	109.9	39.07	109.4	37.58
	-7.0	-7.6	114.7	42.16	114.7	41.24	113.9	40.42	113.9	39.25	113.9	38.17	112.8	36.75
	-5.0	-5.6	119.3	40.96	119.3	40.01	118.5	39.16	118.5	38.03	118.5	36.98	116.7	35.63
	-3.0	-3.7	123.9	39.75	123.9	38.78	123.1	37.91	123.1	36.81	123.1	35.79	120.7	34.51
	0.0	-0.7	130.7	37.93	130.7	36.93	129.9	36.04	129.9	34.99	129.9	34.00	126.5	32.84
	3.0	2.2	137.6	36.12	137.6	35.07	136.7	34.16	136.7	33.17	135.2	32.20	126.6	31.17
	5.0	4.1	141.6	34.90	141.6	33.84	140.9	32.91	139.7	31.95	135.9	31.01	126.6	30.04
	7.0	6.0	144.4	33.69	144.4	32.60	143.6	31.66	140.9	30.74	135.9	29.82	126.6	28.93
	9.0	7.9	144.9	32.69	144.9	31.63	144.4	30.71	140.9	29.82	135.9	28.94	126.6	28.07
	11.0	9.8	144.9	31.96	144.9	30.93	144.4	30.04	140.9	29.16	135.9	28.29	126.6	27.44
	13.0	11.8	144.9	31.19	144.9	30.18	144.4	29.30	140.9	28.45	135.9	27.61	126.6	26.78
15.0	13.7	144.9	30.36	144.9	29.38	144.4	28.52	140.9	27.69	135.9	26.87	126.6	26.06	
120	-24.8	-25	68.9	37.57	68.9	37.94	68.4	38.49	68.4	39.04	68.4	39.89	67.5	40.48
	-21.8	-22	83.8	38.41	83.8	38.78	83.2	39.34	83.2	39.89	83.2	40.72	82.1	41.32
	-19.8	-20	88.4	38.98	88.4	39.34	87.8	39.91	87.8	40.44	87.8	41.29	86.6	41.88
	-18.8	-19	90.4	39.26	90.4	39.63	89.8	40.19	89.8	40.72	89.8	41.57	88.6	42.16
	-16.7	-17	94.7	39.85	94.7	40.22	94.1	40.78	94.1	41.32	94.1	42.16	92.7	41.09
	-13.7	-15	100.7	40.70	100.7	41.07	100.1	41.63	100.1	42.16	100.1	40.55	98.7	39.55
	-11.8	-13	104.0	41.23	104.0	41.60	103.4	42.16	103.4	41.02	103.4	39.53	102.4	38.58
	-9.8	-11	107.5	41.80	107.5	42.16	106.9	40.90	106.9	39.82	106.9	38.46	106.2	37.55
	-9.5	-10	108.2	41.88	108.2	41.96	107.6	40.72	107.6	39.64	107.6	38.30	106.9	37.39
	-8.5	-9.1	110.5	42.16	110.5	41.29	109.7	40.08	109.7	39.04	109.7	37.77	108.9	36.88
	-7.0	-7.6	113.9	41.16	113.9	40.29	113.2	39.14	113.2	38.14	113.0	36.96	112.0	36.11
	-5.0	-5.6	118.5	39.82	118.5	38.95	117.7	37.88	117.7	36.93	117.7	35.88	116.0	35.08
	-3.0	-3.7	123.0	38.48	123.0	37.62	122.2	36.61	122.2	35.74	122.2	34.81	118.9	34.05
	0.0	-0.7	129.8	36.47	129.8	35.61	128.9	34.72	128.9	33.93	127.7	33.20	118.9	32.51
	3.0	2.2	136.6	34.46	136.6	33.60	134.9	32.83	132.0	32.13	127.9	31.59	118.9	30.98
	5.0	4.1	140.6	33.12	140.1	32.26	136.6	31.57	132.0	30.93	127.9	30.52	118.9	29.95
	7.0	6.0	143.4	31.78	142.3	30.92	136.6	30.31	132.0	29.72	127.9	29.45	118.9	28.92
	9.0	7.9	143.8	30.75	142.3	29.92	136.6	29.34	132.0	28.78	127.9	28.51	118.9	27.99
	11.0	9.8	143.8	30.01	142.3	29.19	136.6	28.61	132.0	28.07	127.9	27.80	118.9	27.31
	13.0	11.8	143.8	29.20	142.3	28.40	136.6	27.85	132.0	27.32	127.9	27.06	118.9	26.58
15.0	13.7	143.8	28.34	142.3	27.57	136.6	27.03	132.0	26.51	127.9	26.26	118.9	25.79	
110	-24.8	-25	68.5	37.94	68.5	38.49	68.1	39.04	68.1	39.89	68.1	40.48	67.1	40.76
	-21.8	-22	83.4	38.78	83.4	39.34	82.8	39.89	82.8	40.72	82.8	41.32	81.7	41.60
	-19.8	-20	87.9	39.34	87.9	39.91	87.4	40.44	87.4	41.29	87.4	41.88	86.1	42.16
	-18.8	-19	89.9	39.63	89.9	40.19	89.3	40.72	89.3	41.57	89.3	42.16	88.1	41.60
	-16.7	-17	94.2	40.22	94.2	40.78	93.6	41.32	93.6	42.16	93.6	41.01	92.2	40.41
	-13.7	-15	100.2	41.07	100.2	41.63	99.5	42.16	99.5	40.41	99.5	39.34	99.5	38.72
	-11.8	-13	103.5	41.60	103.5	42.16	102.8	40.92	102.8	39.29	102.8	38.29	102.8	37.65
	-9.8	-11	106.9	42.16	106.9	40.76	106.3	39.62	106.3	38.12	106.3	37.19	106.0	36.52
	-9.5	-10	107.6	41.93	107.6	40.54	107.0	39.41	107.0	37.94	107.0	37.03	106.7	36.35
	-8.5	-9.1	109.9	41.18	109.9	39.84	109.2	38.76	109.2	37.35	109.2	36.46	107.0	35.78
	-7.0	-7.6	113.3	40.03	113.3	38.79	112.6	37.78	112.6	36.47	112.6	35.64	107.0	34.94
	-5.0	-5.6	117.8	38.51	117.8	37.37	117.0	36.47	117.0	35.30	114.5	34.53	107.0	33.80
	-3.0	-3.7	122.3	36.99	122.3	35.97	121.4	35.15	118.6	34.12	114.5	33.42	107.0	32.68
	0.0	-0.7	129.1	34.70	128.7	33.86	122.5	33.19	118.6	32.36	114.5	31.77	107.0	30.99
	3.0	2.2	135.4	32.42	130.6	31.74	122.5	31.22	118.6	30.61	114.5	30.10	107.0	29.29
	5.0	4.1	138.2	30.89	130.6	30.34	122.5	29.92	118.6	29.43	114.5	29.00	107.0	28.16
	7.0	6.0	138.2	29.36	130.6	28.93	122.5	28.60	118.6	28.25	114.5	27.89	107.0	27.03
	9.0	7.9	138.2	28.30	130.6	27.88	122.5	27.57	118.6	27.23	114.5	26.88	107.0	26.05
	11.0	9.8	138.2	27.48	130.6	27.07	122.5	26.76	118.6	26.43	114.5	26.09	107.0	25.29
	13.0	11.8	138.2	26.59	130.6	26.20	122.5	25.90	118.6	25.59	114.5	25.26	107.0	24.49
15.0	13.7	138.2	25.67	130.6	25.28	122.5	24.99	118.6	24.69	114.5	24.38	107.0	23.62	

# 7. Capacity Tables

Heating Capacity (36HP)

Combination (%)	Outdoor air temp.		Indoor air temp. °C DB											
			16		18		20		21		22		24	
	°C DB	°C WB	TC	PI	TC	PI	TC	PI	TC	PI	TC	PI	TC	PI
100	-24.8	-25	68.2	42.32	68.2	42.30	67.8	39.87	67.8	42.25	67.8	42.23	66.8	42.22
	-21.8	-22	82.9	42.29	82.9	42.27	82.5	41.13	82.5	42.22	82.5	42.81	81.2	42.19
	-19.8	-20	87.5	42.27	87.5	42.24	87.0	41.93	87.0	42.20	87.0	42.38	85.8	42.16
	-18.8	-19	89.5	42.26	89.0	42.24	89.0	42.22	89.0	42.18	89.0	42.16	87.7	41.48
	-16.7	-17	93.2	42.24	93.2	42.22	93.2	42.81	92.7	42.16	92.7	40.75	91.3	40.05
	-13.7	-15	99.7	42.21	99.7	42.18	99.1	42.16	99.1	40.11	99.1	38.73	97.8	37.99
	-11.8	-13	103.0	42.19	102.4	42.16	102.4	40.78	102.4	38.80	102.4	37.44	97.8	36.69
	-9.8	-11	106.3	42.16	106.3	40.61	105.9	39.32	105.9	37.43	104.9	36.10	97.8	35.32
	-9.5	-10	107.0	41.92	107.0	40.37	106.5	39.10	106.5	37.22	104.9	35.89	97.8	35.12
	-8.5	-9.1	109.3	41.10	109.3	39.60	108.8	38.37	108.5	36.53	104.9	35.22	97.8	34.43
	-7.0	-7.6	114.5	39.88	114.1	38.43	112.1	37.27	108.5	35.51	104.9	34.21	97.8	33.40
	-5.0	-5.6	119.5	38.24	118.3	36.88	112.1	35.82	108.5	34.13	104.9	32.86	97.8	32.03
	-3.0	-3.7	123.0	36.61	119.3	35.32	112.1	34.36	108.5	32.75	104.9	31.52	97.8	30.66
	0.0	-0.7	126.4	34.16	119.3	32.99	112.1	32.17	108.5	30.70	104.9	29.49	97.8	28.61
	3.0	2.2	126.4	31.70	119.3	30.65	112.1	29.98	108.5	28.64	104.9	27.47	97.8	26.56
	5.0	4.1	126.4	30.07	119.3	29.10	112.1	28.52	108.5	27.26	104.9	26.12	97.8	25.19
	7.0	6.0	126.4	28.43	119.3	27.54	112.1	27.06	108.5	25.89	104.9	24.77	97.8	23.82
	9.0	7.9	126.4	27.23	119.3	26.37	112.1	25.91	108.5	24.80	104.9	23.73	97.8	22.81
	11.0	9.8	126.4	26.25	119.3	25.43	112.1	24.99	108.5	23.90	104.9	22.87	97.8	22.00
	13.0	11.8	126.4	25.22	119.3	24.42	112.1	24.00	108.5	22.96	104.9	21.97	97.8	21.12
15.0	13.7	126.4	24.13	119.3	23.36	112.1	22.96	108.5	21.96	104.9	21.02	97.8	20.21	
90	-24.8	-25	67.9	37.46	67.9	38.30	67.5	38.90	67.5	39.17	67.5	39.74	66.6	40.59
	-21.8	-22	82.6	38.30	82.6	39.15	82.2	39.74	82.2	40.02	82.2	40.59	80.9	38.80
	-19.8	-20	87.2	38.87	87.2	39.71	86.6	40.30	86.6	40.59	86.6	39.36	85.4	37.61
	-18.8	-19	89.5	39.15	89.0	40.00	88.6	40.59	88.6	39.96	88.6	38.75	87.4	37.02
	-16.7	-17	93.2	39.74	93.2	40.59	92.8	39.28	92.8	38.63	92.8	37.47	89.3	35.77
	-13.7	-15	99.7	40.59	99.7	38.63	98.8	37.41	98.8	36.74	96.2	35.63	89.3	33.98
	-11.8	-13	103.0	39.24	102.4	37.40	102.0	36.22	99.4	35.54	96.2	34.47	89.3	32.85
	-9.8	-11	106.3	37.84	106.3	36.11	102.6	34.98	99.4	34.27	96.2	33.25	89.3	31.66
	-9.5	-10	107.0	37.62	107.0	35.90	102.6	34.79	99.4	34.08	96.2	33.06	89.3	31.48
	-8.5	-9.1	109.3	36.92	108.5	35.26	102.6	34.16	99.4	33.45	96.2	32.45	89.3	30.88
	-7.0	-7.6	114.5	35.86	108.9	34.28	102.6	33.23	99.4	32.50	96.2	31.53	89.3	29.99
	-5.0	-5.6	115.7	34.45	108.9	32.98	102.6	31.99	99.4	31.25	96.2	30.31	89.3	28.81
	-3.0	-3.7	115.7	33.04	108.9	31.69	102.6	30.74	99.4	29.98	96.2	29.08	89.3	27.61
	0.0	-0.7	115.7	30.93	108.9	29.73	102.6	28.87	99.4	28.09	96.2	27.25	89.3	25.83
	3.0	2.2	115.7	28.80	108.9	27.78	102.6	27.00	99.4	26.20	96.2	25.42	89.3	24.04
	5.0	4.1	115.7	27.39	108.9	26.48	102.6	25.75	99.4	24.93	96.2	24.19	89.3	22.84
	7.0	6.0	115.7	25.98	108.9	25.19	102.6	24.51	99.4	23.68	96.2	22.97	89.3	21.66
	9.0	7.9	115.7	24.66	108.9	23.90	102.6	23.26	99.4	22.47	96.2	21.80	89.3	20.56
	11.0	9.8	115.7	23.34	108.9	22.63	102.6	22.01	99.4	21.26	96.2	20.63	89.3	19.45
	13.0	11.8	115.7	22.02	108.9	21.34	102.6	20.77	99.4	20.06	96.2	19.47	89.3	18.35
15.0	13.7	115.7	20.70	108.9	20.06	102.6	19.52	99.4	18.85	96.2	18.29	89.3	17.25	
80	-24.8	-25	67.6	32.86	67.6	33.71	67.2	34.30	67.2	34.58	67.2	35.99	66.3	34.42
	-21.8	-22	81.7	33.71	81.7	34.55	81.7	35.14	81.7	35.99	81.7	34.42	79.8	32.91
	-19.8	-20	86.3	34.27	86.3	35.11	86.3	35.99	86.3	34.88	85.6	33.37	79.8	31.91
	-18.8	-19	88.3	34.55	88.3	35.99	88.3	35.42	88.3	34.32	85.8	32.84	79.8	31.41
	-16.7	-17	91.7	35.99	91.7	34.81	91.7	34.24	89.0	33.16	85.8	31.75	79.8	30.36
	-13.7	-15	95.9	34.24	94.0	33.12	91.7	32.55	89.0	31.49	85.8	30.17	79.8	28.85
	-11.8	-13	98.3	33.12	95.4	32.05	91.7	31.47	89.0	30.43	85.8	29.18	79.8	27.89
	-9.8	-11	100.9	31.95	96.8	30.93	91.7	30.34	89.0	29.33	85.8	28.13	79.8	26.89
	-9.5	-10	101.6	31.78	97.3	30.76	91.7	30.17	89.0	29.16	85.8	27.97	79.8	26.74
	-8.5	-9.1	102.7	31.20	97.8	30.20	91.7	29.61	89.0	28.60	85.8	27.45	79.8	26.24
	-7.0	-7.6	103.7	30.32	97.8	29.35	91.7	28.76	89.0	27.77	85.8	26.67	79.8	25.48
	-5.0	-5.6	103.7	29.15	97.8	28.24	91.7	27.63	89.0	26.65	85.8	25.61	79.8	24.48
	-3.0	-3.7	103.7	27.98	97.8	27.11	91.7	26.50	89.0	25.55	85.8	24.57	79.8	23.47
	0.0	-0.7	103.7	26.22	97.8	25.43	91.7	24.81	89.0	23.88	85.8	22.99	79.8	21.97
	3.0	2.2	103.7	24.47	97.8	23.73	91.7	23.11	89.0	22.20	85.8	21.42	79.8	20.46
	5.0	4.1	103.7	23.30	97.8	22.62	91.7	21.98	89.0	21.10	85.8	20.37	79.8	19.46
	7.0	6.0	103.7	22.14	97.8	21.49	91.7	20.86	89.0	19.99	85.8	19.33	79.8	18.45
	9.0	7.9	103.7	20.78	97.8	20.18	91.7	19.58	89.0	18.77	85.8	18.15	79.8	17.33
	11.0	9.8	103.7	19.29	97.8	18.73	91.7	18.18	89.0	17.42	85.8	16.84	79.8	16.08
	13.0	11.8	103.7	18.01	97.8	17.48	91.7	16.97	89.0	16.26	85.8	15.72	79.8	15.01
15.0	13.7	103.7	16.94	97.8	16.45	91.7	15.96	89.0	15.30	85.8	14.80	79.8	14.13	



# 7. Capacity Tables

Heating Capacity (36HP)

Combination (%)	Outdoor air temp.		Indoor air temp. °C DB											
			16		18		20		21		22		24	
	°C DB	°C WB	TC	PI	TC	PI	TC	PI	TC	PI	TC	PI	TC	PI
70	-24.8	-25	67.6	33.30	67.6	33.58	67.2	34.15	67.2	35.00	67.2	33.31	66.2	31.72
	-21.8	-22	78.6	34.15	78.6	34.43	78.1	35.00	75.4	33.31	73.2	31.72	68.3	30.20
	-19.8	-20	85.9	34.72	83.0	35.00	78.1	33.81	75.4	32.18	73.2	30.67	68.3	29.19
	-18.8	-19	87.7	35.00	83.0	34.38	78.1	33.21	75.4	31.61	73.2	30.14	68.3	28.67
	-16.7	-17	87.9	33.71	83.0	33.08	78.1	31.97	75.4	30.43	73.2	29.04	68.3	27.61
	-13.7	-15	87.9	31.89	83.0	31.24	78.1	30.18	75.4	28.74	73.2	27.46	68.3	26.08
	-11.8	-13	87.9	30.72	83.0	30.07	78.1	29.05	75.4	27.66	73.2	26.45	68.3	25.12
	-9.8	-11	87.9	29.51	83.0	28.84	78.1	27.87	75.4	26.53	73.2	25.40	68.3	24.10
	-9.5	-10	87.9	29.32	83.0	28.65	78.1	27.69	75.4	26.37	73.2	25.25	68.3	23.95
	-8.5	-9.1	87.9	28.72	83.0	28.04	78.1	27.09	75.4	25.80	73.2	24.72	68.3	23.44
	-7.0	-7.6	87.9	27.80	83.0	27.12	78.1	26.20	75.4	24.96	73.2	23.93	68.3	22.68
	-5.0	-5.6	87.9	26.58	83.0	25.89	78.1	25.01	75.4	23.83	73.2	22.87	68.3	21.66
	-3.0	-3.7	87.9	25.37	83.0	24.65	78.1	23.82	75.4	22.70	73.2	21.82	68.3	20.64
	0.0	-0.7	87.9	23.54	83.0	22.81	78.1	22.04	75.4	21.01	73.2	20.24	68.3	19.12
	3.0	2.2	87.9	21.71	83.0	20.96	78.1	20.25	75.4	19.33	73.2	18.66	68.3	17.59
	5.0	4.1	87.9	20.49	83.0	19.72	78.1	19.07	75.4	18.20	73.2	17.60	68.3	16.58
	7.0	6.0	87.9	19.27	83.0	18.50	78.1	17.88	75.4	17.07	73.2	16.55	68.3	15.56
	9.0	7.9	87.9	17.40	83.0	16.70	78.1	16.15	75.4	15.41	73.2	14.95	68.3	14.05
	11.0	9.8	87.9	16.21	83.0	15.55	78.1	15.03	75.4	14.35	73.2	13.92	68.3	13.08
	13.0	11.8	87.9	15.16	83.0	14.55	78.1	14.06	75.4	13.43	73.2	13.02	68.3	12.25
15.0	13.7	87.9	14.29	83.0	13.72	78.1	13.26	75.4	12.65	73.2	12.28	68.3	11.54	
60	-24.8	-25	67.0	32.73	67.0	33.30	66.6	34.15	64.7	32.37	62.5	30.70	58.5	29.13
	-21.8	-22	72.0	33.58	71.4	34.15	67.0	32.37	64.7	30.70	62.5	29.13	58.5	27.62
	-19.8	-20	75.4	34.15	71.4	32.89	67.0	31.18	64.7	29.59	62.5	28.08	58.5	26.61
	-18.8	-19	75.4	33.52	71.4	32.26	67.0	30.58	64.7	29.02	62.5	27.56	58.5	26.10
	-16.7	-17	75.4	32.18	71.4	30.93	67.0	29.34	64.7	27.86	62.5	26.47	58.5	25.04
	-13.7	-15	75.4	30.26	71.4	29.05	67.0	27.56	64.7	26.19	62.5	24.90	58.5	23.53
	-11.8	-13	75.4	29.06	71.4	27.85	67.0	26.42	64.7	25.13	62.5	23.91	58.5	22.58
	-9.8	-11	75.4	27.79	71.4	26.59	67.0	25.24	64.7	24.02	62.5	22.86	58.5	21.56
	-9.5	-10	75.4	27.59	71.4	26.41	67.0	25.06	64.7	23.85	62.5	22.70	58.5	21.41
	-8.5	-9.1	75.4	26.96	71.4	25.78	67.0	24.47	64.7	23.30	62.5	22.17	58.5	20.91
	-7.0	-7.6	75.4	26.01	71.4	24.83	67.0	23.58	64.7	22.46	62.5	21.39	58.5	20.15
	-5.0	-5.6	75.4	24.73	71.4	23.57	67.0	22.39	64.7	21.35	62.5	20.35	58.5	19.14
	-3.0	-3.7	75.4	23.46	71.4	22.31	67.0	21.20	64.7	20.24	62.5	19.30	58.5	18.13
	0.0	-0.7	75.4	21.55	71.4	20.42	67.0	19.43	64.7	18.56	62.5	17.73	58.5	16.62
	3.0	2.2	75.4	19.64	71.4	18.53	67.0	17.64	64.7	16.90	62.5	16.17	58.5	15.10
	5.0	4.1	75.4	18.37	71.4	17.27	67.0	16.46	64.7	15.79	62.5	15.12	58.5	14.10
	7.0	6.0	75.4	17.10	71.4	16.01	67.0	15.27	64.7	14.67	62.5	14.08	58.5	13.08
	9.0	7.9	75.4	15.26	71.4	14.29	67.0	13.62	64.7	13.09	62.5	12.55	58.5	11.67
	11.0	9.8	75.4	14.24	71.4	13.34	67.0	12.72	64.7	12.22	62.5	11.73	58.5	10.90
	13.0	11.8	75.4	13.34	71.4	12.49	67.0	11.92	64.7	11.45	62.5	10.98	58.5	10.22
15.0	13.7	75.4	12.61	71.4	11.82	67.0	11.26	64.7	10.82	62.5	10.38	58.5	9.66	
50	-24.8	-25	62.9	29.03	59.3	29.88	55.8	28.28	54.0	26.78	52.2	25.37	48.6	24.06
	-21.8	-22	62.9	29.88	59.3	28.28	55.8	26.78	54.0	25.37	52.2	24.06	48.6	22.80
	-19.8	-20	62.9	28.76	59.3	27.21	55.8	25.79	54.0	24.42	52.2	23.18	48.6	21.95
	-18.8	-19	62.9	28.20	59.3	26.67	55.8	25.29	54.0	23.96	52.2	22.74	48.6	21.53
	-16.7	-17	62.9	27.03	59.3	25.56	55.8	24.25	54.0	22.97	52.2	21.82	48.6	20.65
	-13.7	-15	62.9	25.36	59.3	23.95	55.8	22.75	54.0	21.56	52.2	20.51	48.6	19.39
	-11.8	-13	62.9	24.30	59.3	22.94	55.8	21.80	54.0	20.66	52.2	19.68	48.6	18.59
	-9.8	-11	62.9	23.18	59.3	21.87	55.8	20.80	54.0	19.72	52.2	18.80	48.6	17.74
	-9.5	-10	62.9	23.01	59.3	21.72	55.8	20.66	54.0	19.58	52.2	18.68	48.6	17.62
	-8.5	-9.1	62.9	22.44	59.3	21.18	55.8	20.16	54.0	19.11	52.2	18.24	48.6	17.20
	-7.0	-7.6	62.9	21.61	59.3	20.39	55.8	19.41	54.0	18.41	52.2	17.58	48.6	16.57
	-5.0	-5.6	62.9	20.49	59.3	19.32	55.8	18.42	54.0	17.46	52.2	16.70	48.6	15.73
	-3.0	-3.7	62.9	19.37	59.3	18.25	55.8	17.41	54.0	16.52	52.2	15.82	48.6	14.89
	0.0	-0.7	62.9	17.70	59.3	16.64	55.8	15.92	54.0	15.11	52.2	14.51	48.6	13.62
	3.0	2.2	62.9	16.03	59.3	15.05	55.8	14.43	54.0	13.69	52.2	13.20	48.6	12.36
	5.0	4.1	62.9	14.91	59.3	13.98	55.8	13.43	54.0	12.76	52.2	12.32	48.6	11.53
	7.0	6.0	62.9	13.79	59.3	12.91	55.8	12.44	54.0	11.82	52.2	11.44	48.6	10.68
	9.0	7.9	62.9	12.45	59.3	11.66	55.8	11.23	54.0	10.67	52.2	10.34	48.6	9.64
	11.0	9.8	62.9	11.65	59.3	10.91	55.8	10.51	54.0	9.99	52.2	9.67	48.6	9.02
	13.0	11.8	62.9	10.94	59.3	10.25	55.8	9.86	54.0	9.37	52.2	9.08	48.6	8.48
15.0	13.7	62.9	10.35	59.3	9.69	55.8	9.34	54.0	8.87	52.2	8.59	48.6	8.02	

**Note**

1. TC: Total Capacity(kW), PI : Power Input(kW, Comp. + Outdoor fan motor)
2. Capacity tables show the average value of conditions which may occur.
3. The heating capacity table is based on the values expressed as Max. in the specification of the outdoor unit. (When measuring the Max. heating capacity, the setting status of the indoor unit is the same as that for measuring the heating capacity of the indoor unit.)

# 7. Capacity Tables

## ◆ ARUM380LTE5

Heating Capacity (38HP)

Combination (%)	Outdoor air temp.		Indoor air temp. °C DB											
			16		18		20		21		22		24	
	°C DB	°C WB	TC	PI	TC	PI	TC	PI	TC	PI	TC	PI	TC	PI
130	-24.8	-25	72.7	38.8	72.7	39.13	72.3	39.43	72.3	39.88	72.3	40.32	70.9	41.01
	-21.8	-22	89.3	39.47	89.3	39.81	88.6	40.11	88.6	40.57	88.6	41.01	86.9	41.69
	-19.8	-20	94.5	39.93	94.5	40.27	93.9	40.57	93.9	41.03	93.9	41.46	92.1	42.15
	-18.8	-19	96.7	40.16	96.7	40.50	96.1	40.80	96.1	41.26	96.1	41.69	94.2	42.38
	-16.7	-17	101.3	40.64	101.3	40.98	100.6	41.28	100.6	41.74	100.6	42.18	98.7	42.86
	-13.7	-15	107.7	41.33	107.7	41.67	107.1	41.97	107.1	42.43	107.1	42.86	105.0	41.30
	-11.8	-13	111.2	41.77	111.2	42.10	110.6	42.40	110.6	42.86	110.6	41.82	109.0	40.31
	-9.8	-11	114.9	42.22	114.9	42.56	114.2	42.86	114.2	41.76	114.2	40.72	113.2	39.27
	-9.5	-10	115.6	42.30	115.6	42.63	114.9	42.69	114.9	41.59	114.8	40.55	113.9	39.10
	-8.5	-9.1	117.8	42.52	117.8	42.86	117.1	42.13	117.1	41.02	116.6	40.00	116.0	38.58
	-7.0	-7.6	121.1	42.86	121.1	42.05	120.3	41.28	120.3	40.19	120.3	39.16	119.1	37.80
	-5.0	-5.6	125.6	41.81	125.6	40.94	124.8	40.15	124.8	39.08	124.8	38.06	123.3	36.76
	-3.0	-3.7	130.0	40.77	130.0	39.85	129.2	39.02	129.2	37.96	129.2	36.96	127.5	35.71
	0.0	-0.7	136.7	39.19	136.7	38.21	135.8	37.33	135.8	36.29	135.8	35.30	133.6	34.15
	3.0	2.2	143.4	37.62	143.4	36.56	142.4	35.63	142.4	34.62	142.4	33.64	133.7	32.58
	5.0	4.1	147.7	36.56	147.7	35.46	146.9	34.50	146.9	33.51	146.9	32.54	133.7	31.53
	7.0	6.0	152.2	35.51	152.2	34.36	151.2	33.37	148.8	32.40	143.6	31.43	133.7	30.49
9.0	7.9	153.0	34.65	153.0	33.53	152.5	32.56	148.8	31.62	143.6	30.68	133.7	29.75	
11.0	9.8	153.0	34.09	153.0	33.00	152.5	32.04	148.8	31.11	143.6	30.18	133.7	29.27	
13.0	11.8	153.0	33.50	153.0	32.41	152.5	31.47	148.8	30.56	143.6	29.65	133.7	28.76	
15.0	13.7	153.0	32.85	153.0	31.79	152.5	30.87	148.8	29.96	143.6	29.08	133.7	28.20	
120	-24.8	-25	72.2	39.13	72.2	39.43	71.8	39.88	71.8	40.32	71.8	41.01	70.4	41.49
	-21.8	-22	88.6	39.81	88.6	40.11	88.0	40.57	88.0	41.01	88.0	41.69	86.4	42.18
	-19.8	-20	93.8	40.27	93.8	40.57	93.2	41.03	93.2	41.46	93.2	42.15	91.4	42.63
	-18.8	-19	96.0	40.50	96.0	40.80	95.3	41.26	95.3	41.69	95.3	42.38	93.5	42.86
	-16.7	-17	100.5	40.98	100.5	41.28	99.9	41.74	99.9	42.18	99.9	42.86	97.9	41.85
	-13.7	-15	106.9	41.67	106.9	41.97	106.3	42.43	106.3	42.86	106.3	41.36	104.2	40.41
	-11.8	-13	110.4	42.10	110.4	42.40	109.8	42.86	109.8	41.80	109.8	40.41	108.2	39.51
	-9.8	-11	114.1	42.56	114.1	42.86	113.4	41.70	113.4	40.69	113.4	39.42	112.4	38.55
	-9.5	-10	114.8	42.63	114.8	42.68	114.1	41.53	114.1	40.52	114.1	39.27	113.1	38.40
	-8.5	-9.1	117.0	42.86	117.0	42.07	116.2	40.95	116.2	39.97	116.2	38.77	115.1	37.92
	-7.0	-7.6	120.3	41.96	120.3	41.15	119.5	40.08	119.5	39.13	119.5	38.03	118.3	37.20
	-5.0	-5.6	124.7	40.75	124.7	39.92	123.9	38.91	123.9	38.01	123.9	37.02	122.5	36.24
	-3.0	-3.7	129.1	39.54	129.1	38.71	128.3	37.75	128.3	36.91	128.3	36.02	125.6	35.28
	0.0	-0.7	135.7	37.73	135.7	36.87	134.8	36.01	134.8	35.23	134.8	34.53	125.6	33.84
	3.0	2.2	142.3	35.91	142.3	35.03	141.4	34.26	139.5	33.56	135.1	33.03	125.6	32.40
	5.0	4.1	146.7	34.70	146.7	33.81	144.2	33.11	139.5	32.44	135.1	32.03	125.6	31.44
	7.0	6.0	151.2	33.49	150.2	32.59	144.2	31.95	139.5	31.33	135.1	31.04	125.6	30.48
9.0	7.9	151.8	32.59	150.2	31.71	144.2	31.09	139.5	30.50	135.1	30.21	125.6	29.66	
11.0	9.8	151.8	31.99	150.2	31.12	144.2	30.50	139.5	29.92	135.1	29.64	125.6	29.11	
13.0	11.8	151.8	31.33	150.2	30.48	144.2	29.88	139.5	29.31	135.1	29.03	125.6	28.52	
15.0	13.7	151.8	30.63	150.2	29.79	144.2	29.21	139.5	28.65	135.1	28.37	125.6	27.87	
110	-24.8	-25	71.9	39.43	71.9	39.88	71.4	40.32	71.4	41.01	71.4	41.49	70.0	41.72
	-21.8	-22	88.1	40.11	88.1	40.57	87.5	41.01	87.5	41.69	87.5	42.18	85.9	42.40
	-19.8	-20	93.4	40.57	93.4	41.03	92.7	41.46	92.7	42.15	92.7	42.63	91.0	42.86
	-18.8	-19	95.5	40.80	95.5	41.26	94.8	41.69	94.8	42.38	94.8	42.86	93.1	42.33
	-16.7	-17	100.0	41.28	100.0	41.74	99.4	42.18	99.4	42.86	99.4	41.77	97.4	41.20
	-13.7	-15	106.3	41.97	106.3	42.43	105.7	42.86	105.7	41.21	105.7	40.20	105.7	39.59
	-11.8	-13	109.8	42.40	109.8	42.86	109.2	41.70	109.2	40.16	109.2	39.21	109.2	38.57
	-9.8	-11	113.5	42.86	113.5	41.55	112.8	40.47	112.8	39.05	112.8	38.17	112.5	37.50
	-9.5	-10	114.1	42.65	114.1	41.35	113.5	40.28	113.5	38.89	113.5	38.01	113.0	37.34
	-8.5	-9.1	116.3	41.94	116.3	40.69	115.7	39.67	115.7	38.34	115.7	37.48	113.0	36.80
	-7.0	-7.6	119.7	40.87	119.7	39.71	118.9	38.75	118.9	37.51	118.9	36.70	113.0	36.00
	-5.0	-5.6	124.0	39.46	124.0	38.38	123.2	37.52	123.2	36.41	121.0	35.66	113.0	34.92
	-3.0	-3.7	128.4	38.04	128.4	37.07	127.6	36.29	125.2	35.30	121.0	34.61	113.0	33.85
	0.0	-0.7	135.0	35.92	135.0	35.09	129.4	34.45	125.2	33.64	121.0	33.05	113.0	32.25
	3.0	2.2	141.5	33.79	138.0	33.12	129.4	32.60	125.2	31.99	121.0	31.48	113.0	30.63
	5.0	4.1	145.9	32.37	138.0	31.81	129.4	31.38	125.2	30.88	121.0	30.44	113.0	29.56
	7.0	6.0	146.0	30.95	138.0	30.49	129.4	30.14	125.2	29.78	121.0	29.40	113.0	28.49
9.0	7.9	146.0	29.98	138.0	29.54	129.4	29.21	125.2	28.85	121.0	28.48	113.0	27.60	
11.0	9.8	146.0	29.29	138.0	28.85	129.4	28.52	125.2	28.17	121.0	27.81	113.0	26.95	
13.0	11.8	146.0	28.52	138.0	28.10	129.4	27.78	125.2	27.44	121.0	27.09	113.0	26.26	
15.0	13.7	146.0	27.72	138.0	27.30	129.4	26.99	125.2	26.66	121.0	26.33	113.0	25.51	

# 7. Capacity Tables

Heating Capacity (38HP)

Combination (%)	Outdoor air temp.		Indoor air temp. °C DB											
			16		18		20		21		22		24	
	°C DB	°C WB	TC	PI	TC	PI	TC	PI	TC	PI	TC	PI	TC	PI
100	-24.8	-25	71.6	43.65	71.6	43.55	71.1	40.81	71.1	43.29	71.1	43.18	69.7	43.13
	-21.8	-22	87.7	43.49	87.7	43.39	87.2	42.09	87.2	43.13	87.2	43.61	85.5	42.97
	-19.8	-20	92.9	43.39	92.9	43.28	92.4	42.90	92.4	43.03	92.4	43.11	90.6	42.86
	-18.8	-19	95.0	43.34	94.5	43.23	94.5	43.13	94.5	42.97	94.5	42.86	92.6	42.20
	-16.7	-17	98.9	43.23	98.9	43.12	98.9	43.61	98.4	42.86	98.4	41.50	96.5	40.81
	-13.7	-15	105.8	43.07	105.8	42.96	105.2	42.86	105.2	40.89	105.2	39.55	103.3	38.82
	-11.8	-13	109.3	42.97	108.7	42.86	108.7	41.55	108.7	39.64	108.7	38.31	103.3	37.57
	-9.8	-11	112.9	42.86	112.9	41.39	112.3	40.16	112.3	38.33	110.8	37.02	103.3	36.24
	-9.5	-10	113.5	42.63	113.5	41.17	113.0	39.96	113.0	38.13	110.8	36.82	103.3	36.04
	-8.5	-9.1	115.7	41.87	115.7	40.43	115.2	39.26	114.6	37.47	110.8	36.18	103.3	35.37
	-7.0	-7.6	121.0	40.72	120.5	39.33	118.4	38.22	114.6	36.49	110.8	35.20	103.3	34.38
	-5.0	-5.6	126.2	39.18	125.0	37.86	118.4	36.84	114.6	35.17	110.8	33.90	103.3	33.05
	-3.0	-3.7	129.9	37.65	126.0	36.38	118.4	35.45	114.6	33.86	110.8	32.61	103.3	31.73
	0.0	-0.7	133.5	35.34	126.0	34.18	118.4	33.37	114.6	31.89	110.8	30.65	103.3	29.74
	3.0	2.2	133.5	33.03	126.0	31.97	118.4	31.30	114.6	29.92	110.8	28.70	103.3	27.76
	5.0	4.1	133.5	31.50	126.0	30.50	118.4	29.91	114.6	28.60	110.8	27.40	103.3	26.43
	7.0	6.0	133.5	29.96	126.0	29.02	118.4	28.52	114.6	27.29	110.8	26.11	103.3	25.11
	9.0	7.9	133.5	28.88	126.0	27.97	118.4	27.49	114.6	26.30	110.8	25.16	103.3	24.20
	11.0	9.8	133.5	28.04	126.0	27.16	118.4	26.69	114.6	25.53	110.8	24.42	103.3	23.50
	13.0	11.8	133.5	27.15	126.0	26.29	118.4	25.83	114.6	24.72	110.8	23.64	103.3	22.74
15.0	13.7	133.5	26.20	126.0	25.37	118.4	24.93	114.6	23.85	110.8	22.82	103.3	21.94	
90	-24.8	-25	71.3	38.81	71.3	39.49	70.8	39.98	70.8	40.20	70.8	40.66	69.5	41.35
	-21.8	-22	87.4	39.49	87.4	40.18	86.9	40.66	86.9	40.89	86.9	41.35	85.1	39.60
	-19.8	-20	92.6	39.95	92.6	40.64	92.0	41.12	92.0	41.35	92.0	40.15	90.2	38.44
	-18.8	-19	95.0	40.18	94.5	40.87	94.1	41.35	94.1	40.74	94.1	39.56	92.3	37.86
	-16.7	-17	98.9	40.66	98.9	41.35	98.5	40.09	98.5	39.45	98.5	38.32	94.3	36.63
	-13.7	-15	105.8	41.35	105.8	39.47	104.9	38.28	104.9	37.62	101.6	36.53	94.3	34.89
	-11.8	-13	109.3	40.06	108.7	38.29	108.2	37.14	105.0	36.45	101.6	35.40	94.3	33.78
	-9.8	-11	112.9	38.72	112.9	37.04	108.4	35.94	105.0	35.23	101.6	34.21	94.3	32.61
	-9.5	-10	113.5	38.51	113.5	36.85	108.4	35.75	105.0	35.04	101.6	34.03	94.3	32.43
	-8.5	-9.1	115.7	37.85	114.9	36.22	108.4	35.15	105.0	34.43	101.6	33.43	94.3	31.86
	-7.0	-7.6	121.0	36.83	115.1	35.29	108.4	34.25	105.0	33.51	101.6	32.54	94.3	30.98
	-5.0	-5.6	122.3	35.48	115.1	34.04	108.4	33.05	105.0	32.29	101.6	31.35	94.3	29.82
	-3.0	-3.7	122.3	34.13	115.1	32.79	108.4	31.84	105.0	31.07	101.6	30.16	94.3	28.65
	0.0	-0.7	122.3	32.11	115.1	30.92	108.4	30.04	105.0	29.23	101.6	28.37	94.3	26.91
	3.0	2.2	122.3	30.08	115.1	29.04	108.4	28.23	105.0	27.40	101.6	26.59	94.3	25.15
	5.0	4.1	122.3	28.73	115.1	27.79	108.4	27.03	105.0	26.17	101.6	25.40	94.3	23.99
	7.0	6.0	122.3	27.38	115.1	26.55	108.4	25.83	105.0	24.95	101.6	24.21	94.3	22.83
	9.0	7.9	122.3	26.11	115.1	25.30	108.4	24.62	105.0	23.79	101.6	23.08	94.3	21.77
	11.0	9.8	122.3	24.83	115.1	24.07	108.4	23.42	105.0	22.62	101.6	21.95	94.3	20.69
	13.0	11.8	122.3	23.56	115.1	22.83	108.4	22.22	105.0	21.46	101.6	20.83	94.3	19.63
15.0	13.7	122.3	22.28	115.1	21.60	108.4	21.01	105.0	20.30	101.6	19.69	94.3	18.57	
80	-24.8	-25	71.0	34.12	71.0	34.81	70.5	35.29	70.5	35.52	70.5	36.66	69.2	35.13
	-21.8	-22	86.4	34.81	86.4	35.49	86.4	35.97	86.4	36.66	86.4	35.13	84.3	33.65
	-19.8	-20	91.6	35.26	91.6	35.95	91.6	36.66	91.6	35.58	90.6	34.10	84.3	32.66
	-18.8	-19	93.7	35.49	93.7	36.66	93.7	36.12	93.7	35.04	90.6	33.59	84.3	32.17
	-16.7	-17	96.9	36.66	96.9	35.53	96.9	34.97	94.0	33.90	90.6	32.52	84.3	31.14
	-13.7	-15	101.3	34.98	99.3	33.89	96.9	33.33	94.0	32.28	90.6	30.98	84.3	29.66
	-11.8	-13	103.8	33.90	100.7	32.86	96.9	32.28	94.0	31.25	90.6	30.00	84.3	28.72
	-9.8	-11	106.5	32.78	102.2	31.78	96.9	31.19	94.0	30.17	90.6	28.98	84.3	27.73
	-9.5	-10	107.3	32.61	102.8	31.61	96.9	31.02	94.0	30.00	90.6	28.82	84.3	27.59
	-8.5	-9.1	108.4	32.05	103.2	31.07	96.9	30.47	94.0	29.46	90.6	28.32	84.3	27.09
	-7.0	-7.6	109.5	31.20	103.2	30.25	96.9	29.65	94.0	28.65	90.6	27.55	84.3	26.35
	-5.0	-5.6	109.5	30.08	103.2	29.17	96.9	28.55	94.0	27.56	90.6	26.52	84.3	25.36
	-3.0	-3.7	109.5	28.96	103.2	28.08	96.9	27.46	94.0	26.48	90.6	25.50	84.3	24.38
	0.0	-0.7	109.5	27.26	103.2	26.45	96.9	25.82	94.0	24.86	90.6	23.95	84.3	22.91
	3.0	2.2	109.5	25.58	103.2	24.82	96.9	24.17	94.0	23.23	90.6	22.42	84.3	21.42
	5.0	4.1	109.5	24.45	103.2	23.74	96.9	23.07	94.0	22.15	90.6	21.39	84.3	20.44
	7.0	6.0	109.5	23.33	103.2	22.65	96.9	21.98	94.0	21.07	90.6	20.37	84.3	19.45
	9.0	7.9	109.5	21.90	103.2	21.27	96.9	20.63	94.0	19.78	90.6	19.13	84.3	18.26
	11.0	9.8	109.5	20.33	103.2	19.74	96.9	19.16	94.0	18.36	90.6	17.75	84.3	16.95
	13.0	11.8	109.5	18.98	103.2	18.42	96.9	17.88	94.0	17.14	90.6	16.57	84.3	15.82
15.0	13.7	109.5	17.86	103.2	17.34	96.9	16.83	94.0	16.13	90.6	15.60	84.3	14.90	

## 7. Capacity Tables

## Heating Capacity (38HP)

Combination (%)	Outdoor air temp.		Indoor air temp. °C DB													
			16		18		20		21		22		24			
	°C DB	°C WB	TC	PI	TC	PI	TC	PI	TC	PI	TC	PI	TC	PI		
70	-24.8	-25	71.0	34.43	71.0	34.66	70.5	35.12	70.5	35.81	70.5	34.13	70.5	34.13	69.2	32.55
	-21.8	-22	83.0	35.12	83.0	35.35	82.5	35.81	79.7	34.13	77.3	32.55	72.2	31.03		
	-19.8	-20	91.1	35.58	87.7	35.81	82.5	34.63	79.7	33.01	77.3	31.51	72.2	30.02		
	-18.8	-19	92.9	35.81	87.7	35.20	82.5	34.04	79.7	32.45	77.3	30.98	72.2	29.50		
	-16.7	-17	92.9	34.54	87.7	33.92	82.5	32.81	79.7	31.27	77.3	29.88	72.2	28.44		
	-13.7	-15	92.9	32.75	87.7	32.10	82.5	31.04	79.7	29.59	77.3	28.31	72.2	26.91		
	-11.8	-13	92.9	31.60	87.7	30.94	82.5	29.91	79.7	28.52	77.3	27.31	72.2	25.95		
	-9.8	-11	92.9	30.40	87.7	29.72	82.5	28.74	79.7	27.40	77.3	26.26	72.2	24.94		
	-9.5	-10	92.9	30.22	87.7	29.54	82.5	28.56	79.7	27.23	77.3	26.10	72.2	24.79		
	-8.5	-9.1	92.9	29.62	87.7	28.93	82.5	27.97	79.7	26.67	77.3	25.58	72.2	24.27		
	-7.0	-7.6	92.9	28.72	87.7	28.02	82.5	27.09	79.7	25.83	77.3	24.79	72.2	23.51		
	-5.0	-5.6	92.9	27.52	87.7	26.80	82.5	25.91	79.7	24.71	77.3	23.74	72.2	22.50		
	-3.0	-3.7	92.9	26.32	87.7	25.58	82.5	24.73	79.7	23.59	77.3	22.69	72.2	21.48		
	0.0	-0.7	92.9	24.51	87.7	23.76	82.5	22.97	79.7	21.91	77.3	21.12	72.2	19.96		
	3.0	2.2	92.9	22.71	87.7	21.93	82.5	21.19	79.7	20.23	77.3	19.54	72.2	18.43		
	5.0	4.1	92.9	21.51	87.7	20.71	82.5	20.02	79.7	19.11	77.3	18.49	72.2	17.42		
	7.0	6.0	92.9	20.31	87.7	19.49	82.5	18.84	79.7	17.99	77.3	17.45	72.2	16.40		
	9.0	7.9	92.9	18.34	87.7	17.60	82.5	17.02	79.7	16.25	77.3	15.76	72.2	14.81		
	11.0	9.8	92.9	17.08	87.7	16.39	82.5	15.84	79.7	15.12	77.3	14.67	72.2	13.79		
	13.0	11.8	92.9	15.98	87.7	15.34	82.5	14.82	79.7	14.15	77.3	13.73	72.2	12.91		
15.0	13.7	92.9	15.06	87.7	14.46	82.5	13.97	79.7	13.34	77.3	12.94	72.2	12.17			
60	-24.8	-25	70.8	33.97	70.8	34.43	70.3	35.12	68.4	33.32	66.0	31.64	61.8	30.05		
	-21.8	-22	76.1	34.66	75.4	35.12	70.7	33.32	68.4	31.64	66.0	30.05	61.8	28.52		
	-19.8	-20	79.7	35.12	75.4	33.85	70.7	32.13	68.4	30.52	66.0	29.00	61.8	27.50		
	-18.8	-19	79.7	34.49	75.4	33.22	70.7	31.52	68.4	29.95	66.0	28.47	61.8	26.98		
	-16.7	-17	79.7	33.14	75.4	31.89	70.7	30.27	68.4	28.77	66.0	27.36	61.8	25.91		
	-13.7	-15	79.7	31.22	75.4	29.99	70.7	28.48	68.4	27.09	66.0	25.77	61.8	24.38		
	-11.8	-13	79.7	30.01	75.4	28.79	70.7	27.34	68.4	26.02	66.0	24.77	61.8	23.41		
	-9.8	-11	79.7	28.74	75.4	27.52	70.7	26.14	68.4	24.90	66.0	23.71	61.8	22.38		
	-9.5	-10	79.7	28.55	75.4	27.33	70.7	25.96	68.4	24.73	66.0	23.55	61.8	22.23		
	-8.5	-9.1	79.7	27.91	75.4	26.70	70.7	25.37	68.4	24.17	66.0	23.02	61.8	21.72		
	-7.0	-7.6	79.7	26.96	75.4	25.75	70.7	24.47	68.4	23.32	66.0	22.23	61.8	20.95		
	-5.0	-5.6	79.7	25.67	75.4	24.48	70.7	23.27	68.4	22.20	66.0	21.18	61.8	19.93		
	-3.0	-3.7	79.7	24.40	75.4	23.21	70.7	22.07	68.4	21.08	66.0	20.12	61.8	18.90		
	0.0	-0.7	79.7	22.48	75.4	21.31	70.7	20.28	68.4	19.39	66.0	18.53	61.8	17.37		
	3.0	2.2	79.7	20.56	75.4	19.41	70.7	18.48	68.4	17.71	66.0	16.95	61.8	15.83		
	5.0	4.1	79.7	19.29	75.4	18.14	70.7	17.29	68.4	16.59	66.0	15.89	61.8	14.82		
	7.0	6.0	79.7	18.02	75.4	16.87	70.7	16.09	68.4	15.46	66.0	14.84	61.8	13.79		
	9.0	7.9	79.7	16.08	75.4	15.06	70.7	14.35	68.4	13.79	66.0	13.23	61.8	12.30		
	11.0	9.8	79.7	15.01	75.4	14.06	70.7	13.41	68.4	12.88	66.0	12.36	61.8	11.49		
	13.0	11.8	79.7	14.06	75.4	13.17	70.7	12.56	68.4	12.06	66.0	11.58	61.8	10.77		
15.0	13.7	79.7	13.29	75.4	12.45	70.7	11.86	68.4	11.41	66.0	10.94	61.8	10.18			
50	-24.8	-25	66.5	29.75	62.7	30.44	58.9	28.85	57.0	27.36	55.1	25.96	51.3	24.65		
	-21.8	-22	66.5	30.44	62.7	28.85	58.9	27.36	57.0	25.96	55.1	24.65	51.3	23.39		
	-19.8	-20	66.5	29.34	62.7	27.79	58.9	26.38	57.0	25.02	55.1	23.77	51.3	22.54		
	-18.8	-19	66.5	28.78	62.7	27.26	58.9	25.88	57.0	24.56	55.1	23.33	51.3	22.12		
	-16.7	-17	66.5	27.62	62.7	26.15	58.9	24.84	57.0	23.57	55.1	22.42	51.3	21.24		
	-13.7	-15	66.5	25.97	62.7	24.56	58.9	23.36	57.0	22.16	55.1	21.11	51.3	19.98		
	-11.8	-13	66.5	24.92	62.7	23.56	58.9	22.42	57.0	21.27	55.1	20.28	51.3	19.17		
	-9.8	-11	66.5	23.81	62.7	22.50	58.9	21.42	57.0	20.33	55.1	19.40	51.3	18.33		
	-9.5	-10	66.5	23.65	62.7	22.34	58.9	21.28	57.0	20.19	55.1	19.28	51.3	18.20		
	-8.5	-9.1	66.5	23.09	62.7	21.81	58.9	20.78	57.0	19.72	55.1	18.84	51.3	17.78		
	-7.0	-7.6	66.5	22.27	62.7	21.02	58.9	20.04	57.0	19.02	55.1	18.19	51.3	17.16		
	-5.0	-5.6	66.5	21.16	62.7	19.96	58.9	19.05	57.0	18.08	55.1	17.31	51.3	16.31		
	-3.0	-3.7	66.5	20.05	62.7	18.90	58.9	18.05	57.0	17.14	55.1	16.43	51.3	15.47		
	0.0	-0.7	66.5	18.40	62.7	17.31	58.9	16.57	57.0	15.73	55.1	15.12	51.3	14.20		
	3.0	2.2	66.5	16.75	62.7	15.73	58.9	15.09	57.0	14.32	55.1	13.82	51.3	12.94		
	5.0	4.1	66.5	15.64	62.7	14.67	58.9	14.09	57.0	13.39	55.1	12.94	51.3	12.10		
	7.0	6.0	66.5	14.53	62.7	13.61	58.9	13.11	57.0	12.45	55.1	12.06	51.3	11.26		
	9.0	7.9	66.5	13.12	62.7	12.29	58.9	11.83	57.0	11.24	55.1	10.89	51.3	10.16		
	11.0	9.8	66.5	12.28	62.7	11.50	58.9	11.07	57.0	10.53	55.1	10.19	51.3	9.51		
	13.0	11.8	66.5	11.53	62.7	10.80	58.9	10.39	57.0	9.88	55.1	9.57	51.3	8.93		
15.0	13.7	66.5	10.91	62.7	10.21	58.9	9.84	57.0	9.35	55.1	9.06	51.3	8.45			

## Note

1. TC: Total Capacity(kW), PI: Power Input(kW, Comp. + Outdoor fan motor)
2. Capacity tables show the average value of conditions which may occur.
3. The heating capacity table is based on the values expressed as Max. in the specification of the outdoor unit. (When measuring the Max. heating capacity, the setting status of the indoor unit is the same as that for measuring the heating capacity of the indoor unit.)

# 7. Capacity Tables

## ◆ ARUM400LTE5

Heating Capacity (40HP)

Combination (%)	Outdoor air temp.		Indoor air temp. °C DB											
			16		18		20		21		22		24	
	°C DB	°C WB	TC	PI	TC	PI	TC	PI	TC	PI	TC	PI	TC	PI
130	-24.8	-25	74.1	40.5	74.1	41.01	73.6	41.43	73.6	42.07	73.6	42.68	72.8	43.66
	-21.8	-22	91.2	41.49	91.2	41.97	90.6	42.39	90.6	43.04	90.6	43.66	89.5	44.62
	-19.8	-20	96.7	42.13	96.7	42.62	96.1	43.04	96.1	43.68	96.1	44.29	95.0	45.26
	-18.8	-19	99.1	42.46	99.1	42.94	98.5	43.36	98.5	44.01	98.5	44.62	97.3	45.59
	-16.7	-17	103.9	43.13	103.9	43.62	103.3	44.04	103.3	44.68	103.3	45.30	102.1	46.26
	-13.7	-15	110.8	44.10	110.8	44.59	110.1	45.01	110.1	45.65	110.1	46.26	108.8	46.63
	-11.8	-13	114.5	44.72	114.5	45.20	113.8	45.62	113.8	46.26	113.8	46.86	112.8	47.62
	-9.8	-11	118.4	45.36	118.4	45.84	117.7	46.26	117.7	46.90	117.7	47.54	116.7	48.61
	-9.5	-10	119.3	45.46	119.3	45.94	118.6	46.09	118.6	46.74	118.6	47.38	117.6	49.19
	-8.5	-9.1	122.6	45.78	122.6	46.26	121.9	46.51	121.9	47.16	121.9	47.81	120.7	48.77
	-7.0	-7.6	127.6	46.26	127.6	46.74	126.9	47.00	126.9	47.65	126.9	48.30	125.7	49.34
	-5.0	-5.6	134.2	47.10	134.2	47.58	133.5	47.90	133.5	48.55	133.5	49.25	132.3	50.00
	-3.0	-3.7	140.8	48.15	140.8	48.63	140.1	49.05	140.1	49.70	140.1	50.40	138.9	50.75
	0.0	-0.7	150.7	49.45	150.7	49.93	149.9	50.35	149.9	51.00	149.9	51.75	148.7	52.50
	3.0	2.2	155.1	50.96	155.1	51.44	154.3	51.84	154.3	52.50	154.3	53.25	153.1	54.00
	5.0	4.1	157.8	51.90	157.8	52.38	157.0	52.76	157.0	53.42	157.0	54.15	155.8	54.75
	7.0	6.0	160.6	52.84	160.6	53.32	159.8	53.70	159.8	54.34	159.8	55.15	158.6	55.50
9.0	7.9	161.1	53.77	161.1	54.25	160.6	54.63	160.6	55.25	160.6	56.10	159.4	56.25	
11.0	9.8	161.1	54.70	161.1	55.16	160.6	55.54	160.6	56.14	160.6	57.00	159.4	57.00	
13.0	11.8	161.1	55.63	161.1	56.07	160.6	56.42	160.6	57.40	160.6	58.35	159.4	57.75	
15.0	13.7	161.1	56.56	161.1	56.99	160.6	57.31	160.6	58.34	160.6	59.27	159.4	58.50	
120	-24.8	-25	73.6	41.01	73.6	41.43	73.1	42.07	73.1	42.68	73.1	43.29	72.3	44.33
	-21.8	-22	90.6	41.97	90.6	42.39	90.0	43.04	90.0	43.66	90.0	44.29	89.0	45.30
	-19.8	-20	96.1	42.62	96.1	43.04	95.4	43.68	95.4	44.29	95.4	45.00	94.3	45.94
	-18.8	-19	98.3	42.94	98.3	43.36	97.7	44.01	97.7	44.62	97.7	45.26	96.6	46.26
	-16.7	-17	103.1	43.62	103.1	44.04	102.5	44.68	102.5	45.30	102.5	46.00	101.3	46.26
	-13.7	-15	110.0	44.59	110.0	45.01	109.3	45.65	109.3	46.26	109.3	46.90	108.0	47.62
	-11.8	-13	113.7	45.20	113.7	45.62	113.0	46.04	113.0	46.68	113.0	47.32	111.8	48.61
	-9.8	-11	117.5	45.84	117.5	46.26	116.8	46.68	116.8	47.32	116.8	48.00	115.6	49.19
	-9.5	-10	118.5	45.94	118.5	46.07	117.8	46.49	117.8	47.14	117.8	47.88	116.6	49.77
	-8.5	-9.1	121.8	46.26	121.8	46.74	121.0	47.16	121.0	47.81	121.0	48.50	119.7	50.34
	-7.0	-7.6	126.7	46.74	126.7	47.22	125.9	47.54	125.9	48.19	125.9	48.84	124.7	50.91
	-5.0	-5.6	133.3	47.58	133.3	48.06	132.4	48.48	132.4	49.13	132.4	49.88	131.2	51.48
	-3.0	-3.7	139.7	48.63	139.7	49.11	138.9	49.53	138.9	50.18	138.9	50.93	137.7	52.05
	0.0	-0.7	149.6	49.93	149.6	50.41	148.7	50.83	148.7	51.50	148.7	52.25	147.5	52.62
	3.0	2.2	153.9	50.96	153.9	51.44	153.0	51.84	153.0	52.50	153.0	53.25	151.8	53.25
	5.0	4.1	156.7	51.90	156.7	52.38	155.8	52.76	155.8	53.42	155.8	54.15	154.6	53.90
	7.0	6.0	159.5	52.84	159.5	53.32	158.6	53.70	158.6	54.34	158.6	55.15	157.4	54.50
9.0	7.9	159.9	53.77	159.9	54.25	159.4	54.63	159.4	55.64	159.4	56.10	158.2	55.25	
11.0	9.8	159.9	54.70	159.9	55.16	159.4	55.54	159.4	56.54	159.4	57.00	158.2	56.00	
13.0	11.8	159.9	55.63	159.9	56.07	159.4	56.42	159.4	57.40	159.4	58.35	158.2	56.75	
15.0	13.7	159.9	56.56	159.9	56.99	159.4	57.31	159.4	58.34	159.4	59.27	158.2	57.50	
110	-24.8	-25	73.2	41.43	73.2	42.07	72.8	42.68	72.8	43.29	72.8	43.90	71.9	44.66
	-21.8	-22	90.1	42.39	90.1	43.04	89.5	43.66	89.5	44.29	89.5	44.90	88.5	45.62
	-19.8	-20	95.6	43.04	95.6	43.68	94.9	44.29	94.9	45.00	94.9	45.71	93.8	46.26
	-18.8	-19	97.8	43.36	97.8	44.01	97.2	44.62	97.2	45.26	97.2	45.97	96.1	46.91
	-16.7	-17	102.6	44.04	102.6	44.68	102.0	45.30	102.0	46.00	102.0	46.71	100.8	47.55
	-13.7	-15	109.4	45.01	109.4	45.65	108.7	46.26	108.7	46.90	108.7	47.54	107.5	48.19
	-11.8	-13	113.0	45.62	113.0	46.04	112.4	46.68	112.4	47.32	112.4	48.00	111.2	48.77
	-9.8	-11	116.9	46.26	116.9	46.88	116.2	47.50	116.2	48.14	116.2	48.85	115.0	49.34
	-9.5	-10	117.8	46.36	117.8	46.98	117.2	47.60	117.2	48.25	117.2	48.96	116.0	50.00
	-8.5	-9.1	121.1	46.68	121.1	47.16	120.4	47.78	120.4	48.49	120.4	49.20	119.2	50.57
	-7.0	-7.6	126.0	47.14	126.0	47.72	125.2	48.34	125.2	49.05	125.2	49.76	124.0	51.14
	-5.0	-5.6	132.5	47.98	132.5	48.46	131.6	48.88	131.6	49.59	131.6	50.30	130.4	51.71
	-3.0	-3.7	139.0	49.03	139.0	49.51	138.2	49.93	138.2	50.60	138.2	51.31	137.0	52.28
	0.0	-0.7	148.8	50.33	148.8	50.81	147.9	51.23	147.9	51.92	147.9	52.63	146.7	53.25
	3.0	2.2	150.9	51.36	150.9	51.84	150.0	52.26	150.0	52.95	150.0	53.65	148.8	53.90
	5.0	4.1	153.7	52.30	153.7	52.78	152.8	53.16	152.8	53.85	152.8	54.55	151.6	54.50
	7.0	6.0	153.7	53.23	153.7	53.71	153.3	54.09	153.3	54.78	153.3	55.47	152.1	55.15
9.0	7.9	153.7	54.16	153.7	54.64	153.3	54.98	153.3	55.67	153.3	56.36	152.1	55.80	
11.0	9.8	153.7	55.09	153.7	55.57	153.3	55.91	153.3	56.60	153.3	57.28	152.1	56.45	
13.0	11.8	153.7	56.02	153.7	56.50	153.3	56.84	153.3	57.47	153.3	58.14	152.1	57.10	
15.0	13.7	153.7	56.95	153.7	57.43	153.3	57.77	153.3	58.40	153.3	59.10	152.1	57.75	

# 7. Capacity Tables

Heating Capacity (40HP)

Combination (%)	Outdoor air temp.		Indoor air temp. °C DB											
			16		18		20		21		22		24	
	°C DB	°C WB	TC	PI	TC	PI	TC	PI	TC	PI	TC	PI	TC	PI
100	-24.8	-25	72.9	45.87	72.9	45.92	72.4	43.55	72.4	46.05	72.4	46.11	71.5	46.14
	-21.8	-22	89.6	45.94	89.6	46.00	89.1	44.93	89.1	46.13	89.1	46.81	88.0	46.22
	-19.8	-20	95.1	46.00	95.1	46.05	94.6	45.81	94.6	46.19	94.6	46.45	93.5	46.26
	-18.8	-19	97.4	46.03	96.8	46.08	96.8	46.13	96.8	46.21	96.8	46.26	95.6	45.57
	-16.7	-17	101.5	46.09	101.5	46.14	101.5	46.81	101.0	46.26	101.0	44.83	99.8	44.09
	-13.7	-15	108.9	46.16	108.9	46.21	108.2	46.26	108.2	44.19	108.2	42.76	107.0	41.98
	-11.8	-13	112.5	46.22	111.9	46.26	111.9	44.88	111.9	42.87	111.9	41.46	108.5	40.65
	-9.8	-11	116.2	46.26	116.2	44.72	115.7	43.42	115.7	41.48	114.7	40.09	108.7	39.25
	-9.5	-10	117.2	46.02	117.2	44.49	116.7	43.21	116.7	41.27	115.3	39.88	108.7	39.04
	-8.5	-9.1	120.4	45.22	120.4	43.71	119.9	42.48	120.7	40.58	116.7	39.20	108.7	38.33
	-7.0	-7.6	127.4	44.02	126.9	42.56	124.7	41.38	120.7	39.55	116.7	38.16	108.7	37.28
	-5.0	-5.6	133.0	42.41	131.6	41.02	124.7	39.93	120.7	38.15	116.7	36.79	108.7	35.88
	-3.0	-3.7	136.8	40.81	132.7	39.47	124.7	38.48	120.7	36.77	116.7	35.42	108.7	34.47
	0.0	-0.7	140.7	38.39	132.7	37.15	124.7	36.29	120.7	34.69	116.7	33.36	108.7	32.37
	3.0	2.2	140.7	35.98	132.7	34.83	124.7	34.11	120.7	32.61	116.7	31.29	108.7	30.27
	5.0	4.1	140.7	34.38	132.7	33.29	124.7	32.65	120.7	31.23	116.7	29.92	108.7	28.86
	7.0	6.0	140.7	32.77	132.7	31.74	124.7	31.19	120.7	29.84	116.7	28.55	108.7	27.46
	9.0	7.9	140.7	31.60	132.7	30.61	124.7	30.08	120.7	28.78	116.7	27.54	108.7	26.48
	11.0	9.8	140.7	30.70	132.7	29.74	124.7	29.23	120.7	27.96	116.7	26.75	108.7	25.73
	13.0	11.8	140.7	29.75	132.7	28.81	124.7	28.31	120.7	27.09	116.7	25.91	108.7	24.92
15.0	13.7	140.7	28.74	132.7	27.83	124.7	27.35	120.7	26.16	116.7	25.03	108.7	24.07	
90	-24.8	-25	72.6	40.80	72.6	41.76	72.1	42.45	72.1	42.76	72.1	43.41	71.3	44.38
	-21.8	-22	89.3	41.76	89.3	42.73	88.8	43.41	88.8	43.73	88.8	44.38	87.7	42.55
	-19.8	-20	94.8	42.41	94.8	43.38	94.1	44.05	94.1	44.38	94.1	43.13	93.0	41.33
	-18.8	-19	97.4	42.73	96.8	43.70	96.4	44.38	96.4	43.74	96.4	42.51	95.3	40.72
	-16.7	-17	101.5	43.41	101.5	44.38	101.1	43.07	101.1	42.40	101.1	41.21	98.4	39.43
	-13.7	-15	108.9	44.38	108.9	42.43	107.9	41.19	107.9	40.49	105.9	39.34	99.4	37.60
	-11.8	-13	112.5	43.05	111.9	41.20	111.4	40.00	109.4	39.27	107.0	38.17	99.4	36.44
	-9.8	-11	116.2	41.66	116.2	39.91	113.0	38.75	110.6	37.99	107.0	36.92	99.4	35.22
	-9.5	-10	117.2	41.45	117.2	39.71	113.6	38.56	110.6	37.80	107.0	36.73	99.4	35.03
	-8.5	-9.1	120.4	40.76	119.6	39.06	114.1	37.93	110.6	37.17	107.0	36.11	99.4	34.43
	-7.0	-7.6	127.4	39.71	121.2	38.09	114.1	37.00	110.6	36.21	107.0	35.18	99.4	33.51
	-5.0	-5.6	128.8	38.31	121.2	36.80	114.1	35.75	110.6	34.94	107.0	33.94	99.4	32.29
	-3.0	-3.7	128.8	36.92	121.2	35.51	114.1	34.50	110.6	33.66	107.0	32.69	99.4	31.07
	0.0	-0.7	128.8	34.83	121.2	33.56	114.1	32.62	110.6	31.75	107.0	30.82	99.4	29.24
	3.0	2.2	128.8	32.74	121.2	31.61	114.1	30.75	110.6	29.84	107.0	28.96	99.4	27.40
	5.0	4.1	128.8	31.34	121.2	30.32	114.1	29.50	110.6	28.56	107.0	27.71	99.4	26.18
	7.0	6.0	128.8	29.95	121.2	29.03	114.1	28.25	110.6	27.29	107.0	26.48	99.4	24.97
	9.0	7.9	128.8	28.62	121.2	27.74	114.1	26.99	110.6	26.08	107.0	25.30	99.4	23.86
	11.0	9.8	128.8	27.30	121.2	26.46	114.1	25.75	110.6	24.87	107.0	24.13	99.4	22.75
	13.0	11.8	128.8	25.97	121.2	25.17	114.1	24.50	110.6	23.66	107.0	22.96	99.4	21.64
15.0	13.7	128.8	24.65	121.2	23.89	114.1	23.24	110.6	22.45	107.0	21.78	99.4	20.54	
80	-24.8	-25	72.3	35.77	72.3	36.74	71.8	37.42	71.8	37.74	71.8	39.35	71.0	37.74
	-21.8	-22	88.3	36.74	88.3	37.70	88.3	38.38	88.3	39.35	88.3	37.74	87.0	36.18
	-19.8	-20	93.8	37.38	93.8	38.35	93.8	39.35	93.8	38.22	93.1	36.66	88.8	35.15
	-18.8	-19	96.0	37.70	96.0	39.35	96.0	38.78	96.0	37.65	94.0	36.12	88.8	34.63
	-16.7	-17	100.0	39.35	100.0	38.16	100.0	37.58	98.2	36.46	95.5	35.01	88.8	33.55
	-13.7	-15	106.7	37.60	104.6	36.46	102.1	35.87	99.0	34.76	95.5	33.39	88.8	31.99
	-11.8	-13	109.3	36.49	106.1	35.39	102.1	34.78	99.0	33.69	95.5	32.37	88.8	31.01
	-9.8	-11	111.8	35.32	107.4	34.27	102.1	33.64	99.0	32.56	95.5	31.29	88.8	29.97
	-9.5	-10	112.6	35.15	108.1	34.09	102.1	33.46	99.0	32.38	95.5	31.13	88.8	29.82
	-8.5	-9.1	113.9	34.56	108.7	33.53	102.1	32.89	99.0	31.82	95.5	30.60	88.8	29.30
	-7.0	-7.6	115.3	33.68	108.7	32.68	102.1	32.04	99.0	30.97	95.5	29.80	88.8	28.52
	-5.0	-5.6	115.3	32.52	108.7	31.55	102.1	30.89	99.0	29.83	95.5	28.72	88.8	27.48
	-3.0	-3.7	115.3	31.35	108.7	30.42	102.1	29.75	99.0	28.70	95.5	27.65	88.8	26.45
	0.0	-0.7	115.3	29.59	108.7	28.73	102.1	28.04	99.0	27.01	95.5	26.03	88.8	24.90
	3.0	2.2	115.3	27.84	108.7	27.03	102.1	26.32	99.0	25.30	95.5	24.43	88.8	23.34
	5.0	4.1	115.3	26.68	108.7	25.90	102.1	25.18	99.0	24.17	95.5	23.35	88.8	22.31
	7.0	6.0	115.3	25.51	108.7	24.77	102.1	24.04	99.0	23.04	95.5	22.28	88.8	21.27
	9.0	7.9	115.3	23.95	108.7	23.26	102.1	22.57	99.0	21.63	95.5	20.92	88.8	19.97
	11.0	9.8	115.3	22.23	108.7	21.58	102.1	20.95	99.0	20.07	95.5	19.41	88.8	18.53
	13.0	11.8	115.3	20.75	108.7	20.14	102.1	19.56	99.0	18.74	95.5	18.12	88.8	17.30
15.0	13.7	115.3	19.53	108.7	18.96	102.1	18.40	99.0	17.64	95.5	17.06	88.8	16.29	

# 7. Capacity Tables

Heating Capacity (40HP)

Combination (%)	Outdoor air temp.		Indoor air temp. °C DB											
			16		18		20		21		22		24	
	°C DB	°C WB	TC	PI	TC	PI	TC	PI	TC	PI	TC	PI	TC	PI
70	-24.8	-25	72.3	36.30	72.3	36.62	71.8	37.27	71.8	38.24	71.8	36.48	71.0	34.84
	-21.8	-22	86.2	37.27	86.5	37.59	85.9	38.24	83.9	36.48	81.4	34.84	76.0	33.25
	-19.8	-20	93.5	37.91	91.2	38.24	86.9	37.01	83.9	35.32	81.4	33.75	76.0	32.19
	-18.8	-19	95.4	38.24	92.1	37.61	86.9	36.40	83.9	34.73	81.4	33.20	76.0	31.65
	-16.7	-17	97.5	36.93	92.3	36.28	86.9	35.12	83.9	33.50	81.4	32.05	76.0	30.54
	-13.7	-15	97.8	35.07	92.3	34.39	86.9	33.28	83.9	31.76	81.4	30.41	76.0	28.94
	-11.8	-13	97.8	33.88	92.3	33.19	86.9	32.11	83.9	30.64	81.4	29.37	76.0	27.93
	-9.8	-11	97.8	32.64	92.3	31.92	86.9	30.89	83.9	29.47	81.4	28.27	76.0	26.87
	-9.5	-10	97.8	32.46	92.3	31.73	86.9	30.71	83.9	29.30	81.4	28.11	76.0	26.71
	-8.5	-9.1	97.8	31.84	92.3	31.10	86.9	30.09	83.9	28.72	81.4	27.56	76.0	26.17
	-7.0	-7.6	97.8	30.90	92.3	30.16	86.9	29.18	83.9	27.84	81.4	26.74	76.0	25.38
	-5.0	-5.6	97.8	29.66	92.3	28.90	86.9	27.95	83.9	26.68	81.4	25.65	76.0	24.32
	-3.0	-3.7	97.8	28.42	92.3	27.63	86.9	26.72	83.9	25.51	81.4	24.55	76.0	23.25
	0.0	-0.7	97.8	26.56	92.3	25.74	86.9	24.89	83.9	23.75	81.4	22.91	76.0	21.66
	3.0	2.2	97.8	24.69	92.3	23.85	86.9	23.05	83.9	22.01	81.4	21.26	76.0	20.06
	5.0	4.1	97.8	23.45	92.3	22.58	86.9	21.83	83.9	20.84	81.4	20.17	76.0	19.00
	7.0	6.0	97.8	22.21	92.3	21.32	86.9	20.61	83.9	19.67	81.4	19.08	76.0	17.94
	9.0	7.9	97.8	20.06	92.3	19.25	86.9	18.61	83.9	17.77	81.4	17.23	76.0	16.19
	11.0	9.8	97.8	18.68	92.3	17.92	86.9	17.32	83.9	16.54	81.4	16.04	76.0	15.08
	13.0	11.8	97.8	17.47	92.3	16.77	86.9	16.21	83.9	15.48	81.4	15.01	76.0	14.12
15.0	13.7	97.8	16.47	92.3	15.81	86.9	15.28	83.9	14.59	81.4	14.15	76.0	13.30	
60	-24.8	-25	72.3	35.65	72.3	36.30	71.8	37.27	70.7	35.41	69.2	33.67	65.1	32.02
	-21.8	-22	79.2	36.62	79.4	37.27	74.5	35.41	72.0	33.67	69.5	32.02	65.1	30.43
	-19.8	-20	83.9	37.27	79.4	35.96	74.5	34.17	72.0	32.51	69.5	30.92	65.1	29.36
	-18.8	-19	83.9	36.61	79.4	35.30	74.5	33.55	72.0	31.92	69.5	30.37	65.1	28.82
	-16.7	-17	83.9	35.23	79.4	33.93	74.5	32.25	72.0	30.69	69.5	29.22	65.1	27.70
	-13.7	-15	83.9	33.26	79.4	31.98	74.5	30.40	72.0	28.95	69.5	27.58	65.1	26.11
	-11.8	-13	83.9	32.02	79.4	30.73	74.5	29.22	72.0	27.84	69.5	26.54	65.1	25.10
	-9.8	-11	83.9	30.71	79.4	29.43	74.5	27.98	72.0	26.68	69.5	25.44	65.1	24.03
	-9.5	-10	83.9	30.51	79.4	29.24	74.5	27.80	72.0	26.51	69.5	25.27	65.1	23.87
	-8.5	-9.1	83.9	29.86	79.4	28.58	74.5	27.18	72.0	25.93	69.5	24.72	65.1	23.34
	-7.0	-7.6	83.9	28.88	79.4	27.60	74.5	26.26	72.0	25.05	69.5	23.90	65.1	22.54
	-5.0	-5.6	83.9	27.57	79.4	26.29	74.5	25.01	72.0	23.89	69.5	22.80	65.1	21.48
	-3.0	-3.7	83.9	26.26	79.4	24.98	74.5	23.78	72.0	22.73	69.5	21.71	65.1	20.41
	0.0	-0.7	83.9	24.29	79.4	23.03	74.5	21.93	72.0	20.98	69.5	20.06	65.1	18.81
	3.0	2.2	83.9	22.32	79.4	21.07	74.5	20.07	72.0	19.24	69.5	18.42	65.1	17.21
	5.0	4.1	83.9	21.01	79.4	19.76	74.5	18.84	72.0	18.08	69.5	17.32	65.1	16.15
	7.0	6.0	83.9	19.71	79.4	18.45	74.5	17.60	72.0	16.91	69.5	16.22	65.1	15.08
	9.0	7.9	83.9	17.58	79.4	16.47	74.5	15.70	72.0	15.08	69.5	14.47	65.1	13.46
	11.0	9.8	83.9	16.41	79.4	15.38	74.5	14.66	72.0	14.09	69.5	13.52	65.1	12.56
	13.0	11.8	83.9	15.38	79.4	14.40	74.5	13.74	72.0	13.19	69.5	12.66	65.1	11.78
15.0	13.7	83.9	14.53	79.4	13.62	74.5	12.98	72.0	12.47	69.5	11.96	65.1	11.13	
50	-24.8	-25	70.0	31.70	66.0	32.67	62.1	30.99	60.1	29.42	58.1	27.92	54.1	26.54
	-21.8	-22	70.0	32.67	66.0	30.99	62.1	29.42	60.1	27.92	58.1	26.54	54.1	25.20
	-19.8	-20	70.0	31.50	66.0	29.87	62.1	28.37	60.1	26.93	58.1	25.61	54.1	24.30
	-18.8	-19	70.0	30.92	66.0	29.31	62.1	27.85	60.1	26.44	58.1	25.14	54.1	23.85
	-16.7	-17	70.0	29.70	66.0	28.14	62.1	26.75	60.1	25.40	58.1	24.18	54.1	22.91
	-13.7	-15	70.0	27.95	66.0	26.46	62.1	25.18	60.1	23.90	58.1	22.79	54.1	21.57
	-11.8	-13	70.0	26.85	66.0	25.40	62.1	24.18	60.1	22.96	58.1	21.91	54.1	20.72
	-9.8	-11	70.0	25.68	66.0	24.28	62.1	23.13	60.1	21.96	58.1	20.98	54.1	19.82
	-9.5	-10	70.0	25.51	66.0	24.11	62.1	22.98	60.1	21.82	58.1	20.84	54.1	19.69
	-8.5	-9.1	70.0	24.92	66.0	23.55	62.1	22.45	60.1	21.32	58.1	20.38	54.1	19.24
	-7.0	-7.6	70.0	24.05	66.0	22.72	62.1	21.67	60.1	20.58	58.1	19.69	54.1	18.58
	-5.0	-5.6	70.0	22.88	66.0	21.60	62.1	20.62	60.1	19.58	58.1	18.75	54.1	17.68
	-3.0	-3.7	70.0	21.72	66.0	20.48	62.1	19.57	60.1	18.59	58.1	17.82	54.1	16.79
	0.0	-0.7	70.0	19.97	66.0	18.79	62.1	18.00	60.1	17.09	58.1	16.44	54.1	15.44
	3.0	2.2	70.0	18.23	66.0	17.12	62.1	16.43	60.1	15.60	58.1	15.05	54.1	14.10
	5.0	4.1	70.0	17.06	66.0	16.00	62.1	15.38	60.1	14.61	58.1	14.12	54.1	13.21
	7.0	6.0	70.0	15.89	66.0	14.88	62.1	14.33	60.1	13.62	58.1	13.19	54.1	12.31
	9.0	7.9	70.0	14.35	66.0	13.44	62.1	12.94	60.1	12.29	58.1	11.91	54.1	11.12
	11.0	9.8	70.0	13.42	66.0	12.58	62.1	12.11	60.1	11.51	58.1	11.15	54.1	10.40
	13.0	11.8	70.0	12.61	66.0	11.81	62.1	11.37	60.1	10.80	58.1	10.47	54.1	9.77
15.0	13.7	70.0	11.93	66.0	11.17	62.1	10.76	60.1	10.22	58.1	9.90	54.1	9.24	

**Note**

1. TC: Total Capacity(kW), PI : Power Input(kW, Comp. + Outdoor fan motor)
2. Capacity tables show the average value of conditions which may occur.
3. The heating capacity table is based on the values expressed as Max. in the specification of the outdoor unit. (When measuring the Max. heating capacity, the setting status of the indoor unit is the same as that for measuring the heating capacity of the indoor unit.)

# 7. Capacity Tables

## ◆ ARUM420LTE5

Heating Capacity (42HP)

Combination (%)	Outdoor air temp.		Indoor air temp. °C DB											
			16		18		20		21		22		24	
	°C DB	°C WB	TC	PI	TC	PI	TC	PI	TC	PI	TC	PI	TC	PI
130	-24.8	-25	82.7	43.3	82.7	43.66	82.1	43.94	82.1	44.36	82.1	44.78	80.6	45.43
	-21.8	-22	100.2	43.98	100.2	44.30	99.5	44.58	99.5	45.01	99.5	45.43	97.6	46.07
	-19.8	-20	105.5	44.41	105.5	44.73	104.8	45.01	104.8	45.45	104.8	45.85	102.8	46.50
	-18.8	-19	107.8	44.62	107.8	44.95	107.1	45.23	107.1	45.66	107.1	46.07	105.0	46.72
	-16.7	-17	112.5	45.08	112.5	45.40	111.7	45.68	111.7	46.11	111.7	46.53	109.6	47.17
	-13.7	-15	119.2	45.72	119.2	46.05	118.4	46.33	118.4	46.76	118.4	47.17	116.2	45.36
	-11.8	-13	123.0	46.14	123.0	46.45	122.3	46.73	122.3	47.17	122.3	45.95	120.3	44.21
	-9.8	-11	127.1	46.56	127.1	46.89	126.4	47.17	126.4	45.87	126.4	44.67	124.7	43.01
	-9.5	-10	127.8	46.64	127.8	46.95	127.1	46.97	127.1	45.67	126.9	44.48	125.4	42.82
	-8.5	-9.1	130.3	46.84	130.3	47.17	129.6	46.30	129.6	45.02	129.0	43.84	127.5	42.22
	-7.0	-7.6	134.0	47.17	134.0	46.19	133.2	45.30	133.2	44.04	133.2	42.86	130.8	41.31
	-5.0	-5.6	139.0	45.90	139.0	44.88	138.1	43.97	138.1	42.74	138.1	41.58	135.1	40.11
	-3.0	-3.7	143.9	44.63	143.9	43.58	143.0	42.63	143.0	41.43	143.0	40.30	139.5	38.90
	0.0	-0.7	151.3	42.72	151.3	41.62	150.3	40.64	150.3	39.48	150.3	38.38	146.1	37.09
	3.0	2.2	158.8	40.82	158.8	39.65	157.7	38.63	157.7	37.52	157.7	36.44	147.9	35.28
	5.0	4.1	163.6	39.54	163.6	38.35	162.7	37.30	162.7	36.22	158.9	35.16	147.9	34.07
	7.0	6.0	168.6	38.28	168.6	37.04	167.5	35.97	164.6	34.92	158.9	33.88	147.9	32.87
9.0	7.9	169.3	37.23	169.3	36.02	168.8	34.98	164.6	33.96	158.9	32.95	147.9	31.96	
11.0	9.8	169.3	36.50	169.3	35.32	168.8	34.30	164.6	33.30	158.9	32.31	147.9	31.34	
13.0	11.8	169.3	35.72	169.3	34.56	168.8	33.56	164.6	32.59	158.9	31.62	147.9	30.67	
15.0	13.7	169.3	34.88	169.3	33.76	168.8	32.78	164.6	31.82	158.9	30.88	147.9	29.95	
120	-24.8	-25	82.1	43.66	82.1	43.94	81.6	44.36	81.6	44.78	81.6	45.43	80.1	45.88
	-21.8	-22	99.5	44.30	99.5	44.58	98.8	45.01	98.8	45.43	98.8	46.07	97.0	46.53
	-19.8	-20	104.7	44.73	104.7	45.01	104.0	45.45	104.0	45.85	104.0	46.50	102.1	46.95
	-18.8	-19	106.9	44.95	106.9	45.23	106.2	45.66	106.2	46.07	106.2	46.72	104.3	47.17
	-16.7	-17	111.6	45.40	111.6	45.68	110.9	46.11	110.9	46.53	110.9	47.17	108.8	46.00
	-13.7	-15	118.3	46.05	118.3	46.33	117.6	46.76	117.6	47.17	117.6	45.43	115.3	44.34
	-11.8	-13	122.2	46.45	122.2	46.73	121.4	47.17	121.4	45.94	121.4	44.33	119.5	43.29
	-9.8	-11	126.2	46.89	126.2	47.17	125.5	45.81	125.5	44.64	125.5	43.17	123.8	42.18
	-9.5	-10	126.9	46.95	126.9	46.95	126.2	45.61	126.2	44.45	126.2	43.00	124.5	42.01
	-8.5	-9.1	129.4	47.17	129.4	46.23	128.6	44.93	128.6	43.80	128.4	42.43	126.6	41.46
	-7.0	-7.6	133.1	46.10	133.1	45.16	132.2	43.92	132.2	42.83	131.8	41.56	129.9	40.62
	-5.0	-5.6	138.0	44.67	138.0	43.72	137.2	42.56	137.2	41.53	137.2	40.39	134.2	39.51
	-3.0	-3.7	142.9	43.24	142.9	42.30	142.0	41.20	142.0	40.25	142.0	39.24	138.1	38.40
	0.0	-0.7	150.3	41.10	150.3	40.14	149.3	39.17	149.3	38.30	149.3	37.50	138.9	36.74
	3.0	2.2	157.6	38.96	157.6	37.99	156.6	37.14	154.3	36.36	149.5	35.76	138.9	35.07
	5.0	4.1	162.5	37.53	162.5	36.56	159.6	35.79	154.3	35.06	149.5	34.61	138.9	33.96
	7.0	6.0	167.4	36.10	166.2	35.12	159.6	34.43	154.3	33.77	149.5	33.45	138.9	32.85
9.0	7.9	168.0	35.02	166.2	34.07	159.6	33.40	154.3	32.77	149.5	32.46	138.9	31.87	
11.0	9.8	168.0	34.25	166.2	33.33	159.6	32.67	154.3	32.05	149.5	31.74	138.9	31.17	
13.0	11.8	168.0	33.42	166.2	32.52	159.6	31.88	154.3	31.27	149.5	30.98	138.9	30.43	
15.0	13.7	168.0	32.55	166.2	31.66	159.6	31.04	154.3	30.44	149.5	30.15	138.9	29.62	
110	-24.8	-25	81.7	43.94	81.7	44.36	81.2	44.78	81.2	45.43	81.2	45.88	79.6	46.09
	-21.8	-22	99.0	44.58	99.0	45.01	98.3	45.43	98.3	46.07	98.3	46.53	96.5	46.73
	-19.8	-20	104.2	45.01	104.2	45.45	103.5	45.85	103.5	46.50	103.5	46.95	101.5	47.17
	-18.8	-19	106.4	45.23	106.4	45.66	105.7	46.07	105.7	46.72	105.7	47.17	103.7	46.55
	-16.7	-17	111.0	45.68	111.0	46.11	110.3	46.53	110.3	47.17	110.3	45.91	108.2	45.26
	-13.7	-15	117.6	46.33	117.6	46.76	116.9	47.17	116.9	45.26	116.9	44.11	116.9	43.42
	-11.8	-13	121.5	46.73	121.5	47.17	120.7	45.82	120.7	44.05	120.7	42.97	120.7	42.25
	-9.8	-11	125.5	47.17	125.5	45.65	124.8	44.41	124.8	42.78	124.8	41.77	123.8	41.03
	-9.5	-10	126.2	46.92	126.2	45.42	125.5	44.19	125.5	42.59	125.5	41.59	125.0	40.85
	-8.5	-9.1	128.7	46.10	128.7	44.66	128.0	43.48	128.0	41.95	128.0	40.98	125.0	40.22
	-7.0	-7.6	132.4	44.86	132.4	43.52	131.5	42.42	131.5	41.00	131.5	40.09	125.0	39.31
	-5.0	-5.6	137.2	43.23	137.2	41.99	136.3	41.01	136.3	39.73	133.8	38.89	125.0	38.07
	-3.0	-3.7	142.1	41.58	142.1	40.47	141.3	39.58	138.6	38.45	133.8	37.68	125.0	36.85
	0.0	-0.7	149.4	39.12	149.4	38.19	143.2	37.46	138.6	36.55	133.8	35.89	125.0	35.01
	3.0	2.2	156.7	36.65	152.7	35.91	143.2	35.33	138.6	34.65	133.8	34.08	125.0	33.16
	5.0	4.1	161.5	35.01	152.7	34.38	143.2	33.91	138.6	33.37	133.8	32.88	125.0	31.93
	7.0	6.0	161.5	33.36	152.7	32.86	143.2	32.49	138.6	32.10	133.8	31.69	125.0	30.71
9.0	7.9	161.5	32.22	152.7	31.74	143.2	31.39	138.6	31.00	133.8	30.61	125.0	29.66	
11.0	9.8	161.5	31.37	152.7	30.90	143.2	30.54	138.6	30.17	133.8	29.78	125.0	28.87	
13.0	11.8	161.5	30.44	152.7	29.99	143.2	29.65	138.6	29.29	133.8	28.92	125.0	28.03	
15.0	13.7	161.5	29.47	152.7	29.02	143.2	28.70	138.6	28.34	133.8	27.99	125.0	27.12	



# 7. Capacity Tables

Heating Capacity (42HP)

Combination (%)	Outdoor air temp.		Indoor air temp. °C DB											
			16		18		20		21		22		24	
	°C DB	°C WB	TC	PI	TC	PI	TC	PI	TC	PI	TC	PI	TC	PI
100	-24.8	-25	81.3	47.51	81.3	47.47	80.8	44.77	80.8	47.35	80.8	47.31	79.2	47.29
	-21.8	-22	98.5	47.44	98.5	47.40	97.9	46.19	97.9	47.28	97.9	47.73	96.0	47.22
	-19.8	-20	103.7	47.40	103.7	47.35	103.1	47.07	103.1	47.24	103.1	47.36	101.2	47.17
	-18.8	-19	105.9	47.38	105.3	47.33	105.3	47.28	105.3	47.21	105.3	47.17	103.2	46.42
	-16.7	-17	109.8	47.33	109.8	47.28	109.8	47.73	109.3	47.17	109.3	45.62	107.2	44.85
	-13.7	-15	117.1	47.26	117.1	47.21	116.4	47.17	116.4	44.92	116.4	43.41	114.2	42.59
	-11.8	-13	120.9	47.22	120.2	47.17	120.2	45.66	120.2	43.49	120.2	42.00	114.2	41.17
	-9.8	-11	124.8	47.17	124.8	45.48	124.3	44.07	124.3	42.00	122.6	40.53	114.2	39.67
	-9.5	-10	125.5	46.90	125.5	45.22	125.0	43.84	125.0	41.77	122.6	40.31	114.2	39.44
	-8.5	-9.1	128.0	46.02	128.0	44.38	127.4	43.04	126.8	41.02	122.6	39.57	114.2	38.69
	-7.0	-7.6	133.8	44.69	133.3	43.11	131.0	41.85	126.8	39.91	122.6	38.47	114.2	37.56
	-5.0	-5.6	139.7	42.92	138.3	41.43	131.0	40.27	126.8	38.40	122.6	36.99	114.2	36.06
	-3.0	-3.7	143.7	41.15	139.4	39.73	131.0	38.68	126.8	36.90	122.6	35.52	114.2	34.56
	0.0	-0.7	147.8	38.50	139.4	37.20	131.0	36.30	126.8	34.65	122.6	33.30	114.2	32.31
	3.0	2.2	147.8	35.84	139.4	34.66	131.0	33.92	126.8	32.41	122.6	31.09	114.2	30.06
	5.0	4.1	147.8	34.07	139.4	32.98	131.0	32.33	126.8	30.91	122.6	29.61	114.2	28.56
	7.0	6.0	147.8	32.30	139.4	31.28	131.0	30.74	126.8	29.41	122.6	28.14	114.2	27.06
	9.0	7.9	147.8	30.90	139.4	29.93	131.0	29.41	126.8	28.14	122.6	26.93	114.2	25.89
	11.0	9.8	147.8	29.76	139.4	28.83	131.0	28.33	126.8	27.10	122.6	25.92	114.2	24.94
	13.0	11.8	147.8	28.56	139.4	27.65	131.0	27.17	126.8	26.00	122.6	24.87	114.2	23.92
15.0	13.7	147.8	27.28	139.4	26.42	131.0	25.96	126.8	24.83	122.6	23.76	114.2	22.85	
90	-24.8	-25	81.0	42.87	81.0	43.51	80.5	43.97	80.5	44.18	80.5	44.61	79.0	45.26
	-21.8	-22	98.1	43.51	98.1	44.16	97.5	44.61	97.5	44.83	97.5	45.26	95.6	43.31
	-19.8	-20	103.3	43.94	103.3	44.59	102.6	45.04	102.6	45.26	102.6	43.92	100.7	42.01
	-18.8	-19	105.9	44.16	105.3	44.81	104.8	45.26	104.8	44.58	104.8	43.26	102.8	41.37
	-16.7	-17	109.8	44.61	109.8	45.26	109.4	43.84	109.4	43.13	109.4	41.87	104.4	40.00
	-13.7	-15	117.1	45.26	117.1	43.15	116.0	41.82	116.0	41.08	112.5	39.87	104.4	38.05
	-11.8	-13	120.9	43.81	120.2	41.81	119.7	40.53	116.2	39.77	112.5	38.61	104.4	36.82
	-9.8	-11	124.8	42.30	124.8	40.41	119.9	39.18	116.2	38.40	112.5	37.27	104.4	35.52
	-9.5	-10	125.5	42.06	125.5	40.20	119.9	38.98	116.2	38.20	112.5	37.07	104.4	35.32
	-8.5	-9.1	128.0	41.31	127.1	39.50	119.9	38.30	116.2	37.51	112.5	36.41	104.4	34.67
	-7.0	-7.6	133.8	40.16	127.3	38.44	119.9	37.29	116.2	36.48	112.5	35.41	104.4	33.69
	-5.0	-5.6	135.3	38.64	127.3	37.04	119.9	35.95	116.2	35.12	112.5	34.08	104.4	32.40
	-3.0	-3.7	135.3	37.12	127.3	35.64	119.9	34.59	116.2	33.74	112.5	32.74	104.4	31.10
	0.0	-0.7	135.3	34.84	127.3	33.53	119.9	32.56	116.2	31.69	112.5	30.75	104.4	29.15
	3.0	2.2	135.3	32.56	127.3	31.41	119.9	30.54	116.2	29.63	112.5	28.76	104.4	27.20
	5.0	4.1	135.3	31.04	127.3	30.01	119.9	29.19	116.2	28.26	112.5	27.42	104.4	25.90
	7.0	6.0	135.3	29.51	127.3	28.61	119.9	27.84	116.2	26.89	112.5	26.09	104.4	24.61
	9.0	7.9	135.3	28.08	127.3	27.22	119.9	26.49	116.2	25.59	112.5	24.82	104.4	23.41
	11.0	9.8	135.3	26.65	127.3	25.84	119.9	25.14	116.2	24.28	112.5	23.56	104.4	22.21
	13.0	11.8	135.3	25.22	127.3	24.44	119.9	23.79	116.2	22.98	112.5	22.30	104.4	21.02
15.0	13.7	135.3	23.79	127.3	23.06	119.9	22.44	116.2	21.67	112.5	21.03	104.4	19.83	
80	-24.8	-25	80.6	37.74	80.6	38.39	80.1	38.84	80.1	39.06	80.1	40.13	78.6	38.42
	-21.8	-22	97.1	38.39	97.1	39.03	97.1	39.48	97.1	40.13	97.1	38.42	93.3	36.77
	-19.8	-20	102.2	38.81	102.2	39.46	102.2	40.13	102.2	38.92	100.3	37.27	93.3	35.67
	-18.8	-19	104.4	39.03	104.4	40.13	104.4	39.52	103.9	38.32	100.3	36.70	93.3	35.13
	-16.7	-17	107.2	40.13	107.2	38.85	107.2	38.23	104.0	37.05	100.3	35.51	93.3	33.98
	-13.7	-15	112.1	38.24	109.9	37.02	107.2	36.39	104.0	35.23	100.3	33.79	93.3	32.33
	-11.8	-13	115.2	37.03	111.8	35.86	107.2	35.22	104.0	34.08	100.3	32.70	93.3	31.28
	-9.8	-11	118.2	35.77	113.2	34.65	107.2	34.00	104.0	32.87	100.3	31.55	93.3	30.18
	-9.5	-10	119.0	35.58	113.9	34.46	107.2	33.81	104.0	32.69	100.3	31.38	93.3	30.03
	-8.5	-9.1	120.1	34.95	114.2	33.85	107.2	33.20	104.0	32.08	100.3	30.82	93.3	29.47
	-7.0	-7.6	121.1	33.99	114.2	32.94	107.2	32.28	104.0	31.18	100.3	29.96	93.3	28.65
	-5.0	-5.6	121.1	32.73	114.2	31.72	107.2	31.05	104.0	29.96	100.3	28.81	93.3	27.55
	-3.0	-3.7	121.1	31.47	114.2	30.50	107.2	29.82	104.0	28.76	100.3	27.68	93.3	26.45
	0.0	-0.7	121.1	29.56	114.2	28.68	107.2	27.99	104.0	26.94	100.3	25.95	93.3	24.81
	3.0	2.2	121.1	27.67	114.2	26.85	107.2	26.14	104.0	25.12	100.3	24.24	93.3	23.16
	5.0	4.1	121.1	26.41	114.2	25.63	107.2	24.92	104.0	23.91	100.3	23.10	93.3	22.06
	7.0	6.0	121.1	25.14	114.2	24.41	107.2	23.69	104.0	22.71	100.3	21.96	93.3	20.96
	9.0	7.9	121.1	23.61	114.2	22.92	107.2	22.24	104.0	21.32	100.3	20.62	93.3	19.69
	11.0	9.8	121.1	21.91	114.2	21.27	107.2	20.65	104.0	19.78	100.3	19.13	93.3	18.27
	13.0	11.8	121.1	20.45	114.2	19.85	107.2	19.28	104.0	18.47	100.3	17.86	93.3	17.05
15.0	13.7	121.1	19.25	114.2	18.69	107.2	18.14	104.0	17.38	100.3	16.81	93.3	16.06	

# 7. Capacity Tables

Heating Capacity (42HP)

Combination (%)	Outdoor air temp.		Indoor air temp. °C DB											
			16		18		20		21		22		24	
	°C DB	°C WB	TC	PI	TC	PI	TC	PI	TC	PI	TC	PI	TC	PI
70	-24.8	-25	80.6	37.90	80.6	38.11	80.1	38.55	80.1	39.20	80.1	37.33	77.7	35.58
	-21.8	-22	91.9	38.55	91.9	38.76	91.3	39.20	88.2	37.33	85.5	35.58	79.8	33.89
	-19.8	-20	99.3	38.98	97.0	39.20	91.3	37.88	88.2	36.08	85.5	34.41	79.8	32.77
	-18.8	-19	101.5	39.20	97.0	38.52	91.3	37.22	88.2	35.46	85.5	33.83	79.8	32.20
	-16.7	-17	102.8	37.78	97.0	37.09	91.3	35.85	88.2	34.14	85.5	32.61	79.8	31.02
	-13.7	-15	102.8	35.78	97.0	35.06	91.3	33.88	88.2	32.28	85.5	30.86	79.8	29.33
	-11.8	-13	102.8	34.49	97.0	33.77	91.3	32.63	88.2	31.09	85.5	29.75	79.8	28.26
	-9.8	-11	102.8	33.16	97.0	32.41	91.3	31.33	88.2	29.85	85.5	28.59	79.8	27.14
	-9.5	-10	102.8	32.95	97.0	32.20	91.3	31.13	88.2	29.66	85.5	28.42	79.8	26.97
	-8.5	-9.1	102.8	32.29	97.0	31.53	91.3	30.47	88.2	29.04	85.5	27.83	79.8	26.40
	-7.0	-7.6	102.8	31.28	97.0	30.51	91.3	29.49	88.2	28.11	85.5	26.96	79.8	25.56
	-5.0	-5.6	102.8	29.94	97.0	29.16	91.3	28.18	88.2	26.86	85.5	25.79	79.8	24.43
	-3.0	-3.7	102.8	28.60	97.0	27.79	91.3	26.86	88.2	25.61	85.5	24.63	79.8	23.31
	0.0	-0.7	102.8	26.58	97.0	25.76	91.3	24.90	88.2	23.74	85.5	22.88	79.8	21.62
	3.0	2.2	102.8	24.57	97.0	23.73	91.3	22.93	88.2	21.88	85.5	21.13	79.8	19.93
	5.0	4.1	102.8	23.23	97.0	22.37	91.3	21.62	88.2	20.64	85.5	19.97	79.8	18.80
	7.0	6.0	102.8	21.89	97.0	21.01	91.3	20.31	88.2	19.39	85.5	18.80	79.8	17.68
9.0	7.9	102.8	19.77	97.0	18.97	91.3	18.34	88.2	17.51	85.5	16.99	79.8	15.96	
11.0	9.8	102.8	18.41	97.0	17.66	91.3	17.07	88.2	16.30	85.5	15.81	79.8	14.86	
13.0	11.8	102.8	17.22	97.0	16.53	91.3	15.98	88.2	15.25	85.5	14.80	79.8	13.91	
15.0	13.7	102.8	16.24	97.0	15.58	91.3	15.06	88.2	14.38	85.5	13.95	79.8	13.11	
60	-24.8	-25	78.4	37.46	78.4	37.90	77.9	38.55	75.6	36.54	73.0	34.67	68.4	32.91
	-21.8	-22	84.2	38.11	83.4	38.55	78.3	36.54	75.6	34.67	73.0	32.91	68.4	31.21
	-19.8	-20	88.2	38.55	83.4	37.13	78.3	35.21	75.6	33.42	73.0	31.73	68.4	30.07
	-18.8	-19	88.2	37.84	83.4	36.42	78.3	34.54	75.6	32.79	73.0	31.14	68.4	29.50
	-16.7	-17	88.2	36.33	83.4	34.94	78.3	33.14	75.6	31.48	73.0	29.91	68.4	28.31
	-13.7	-15	88.2	34.19	83.4	32.82	78.3	31.15	75.6	29.61	73.0	28.15	68.4	26.61
	-11.8	-13	88.2	32.83	83.4	31.48	78.3	29.87	75.6	28.41	73.0	27.04	68.4	25.54
	-9.8	-11	88.2	31.41	83.4	30.06	78.3	28.54	75.6	27.17	73.0	25.86	68.4	24.40
	-9.5	-10	88.2	31.19	83.4	29.86	78.3	28.34	75.6	26.98	73.0	25.68	68.4	24.23
	-8.5	-9.1	88.2	30.48	83.4	29.15	78.3	27.68	75.6	26.36	73.0	25.09	68.4	23.66
	-7.0	-7.6	88.2	29.41	83.4	28.09	78.3	26.68	75.6	25.42	73.0	24.21	68.4	22.81
	-5.0	-5.6	88.2	27.98	83.4	26.67	78.3	25.34	75.6	24.17	73.0	23.04	68.4	21.68
	-3.0	-3.7	88.2	26.56	83.4	25.25	78.3	24.01	75.6	22.92	73.0	21.86	68.4	20.54
	0.0	-0.7	88.2	24.41	83.4	23.14	78.3	22.01	75.6	21.04	73.0	20.10	68.4	18.84
	3.0	2.2	88.2	22.27	83.4	21.02	78.3	20.01	75.6	19.17	73.0	18.34	68.4	17.13
	5.0	4.1	88.2	20.85	83.4	19.60	78.3	18.68	75.6	17.92	73.0	17.17	68.4	16.00
	7.0	6.0	88.2	19.42	83.4	18.19	78.3	17.35	75.6	16.66	73.0	15.99	68.4	14.86
9.0	7.9	88.2	17.33	83.4	16.23	78.3	15.47	75.6	14.87	73.0	14.26	68.4	13.26	
11.0	9.8	88.2	16.17	83.4	15.16	78.3	14.45	75.6	13.88	73.0	13.32	68.4	12.38	
13.0	11.8	88.2	15.16	83.4	14.19	78.3	13.54	75.6	13.00	73.0	12.48	68.4	11.61	
15.0	13.7	88.2	14.32	83.4	13.42	78.3	12.79	75.6	12.29	73.0	11.79	68.4	10.97	
50	-24.8	-25	73.5	32.67	69.3	33.32	65.2	31.56	63.1	29.91	61.0	28.35	56.8	26.91
	-21.8	-22	73.5	33.32	69.3	31.56	65.2	29.91	63.1	28.35	61.0	26.91	56.8	25.52
	-19.8	-20	73.5	32.09	69.3	30.38	65.2	28.82	63.1	27.31	61.0	25.94	56.8	24.58
	-18.8	-19	73.5	31.47	69.3	29.79	65.2	28.27	63.1	26.81	61.0	25.46	56.8	24.12
	-16.7	-17	73.5	30.19	69.3	28.57	65.2	27.12	63.1	25.72	61.0	24.45	56.8	23.14
	-13.7	-15	73.5	28.35	69.3	26.80	65.2	25.48	63.1	24.16	61.0	23.00	56.8	21.75
	-11.8	-13	73.5	27.19	69.3	25.69	65.2	24.43	63.1	23.17	61.0	22.08	56.8	20.87
	-9.8	-11	73.5	25.96	69.3	24.52	65.2	23.33	63.1	22.13	61.0	21.11	56.8	19.93
	-9.5	-10	73.5	25.78	69.3	24.35	65.2	23.17	63.1	21.98	61.0	20.97	56.8	19.80
	-8.5	-9.1	73.5	25.16	69.3	23.76	65.2	22.62	63.1	21.46	61.0	20.49	56.8	19.33
	-7.0	-7.6	73.5	24.25	69.3	22.88	65.2	21.80	63.1	20.68	61.0	19.77	56.8	18.64
	-5.0	-5.6	73.5	23.02	69.3	21.71	65.2	20.71	63.1	19.65	61.0	18.80	56.8	17.71
	-3.0	-3.7	73.5	21.79	69.3	20.53	65.2	19.60	63.1	18.61	61.0	17.83	56.8	16.78
	0.0	-0.7	73.5	19.96	69.3	18.77	65.2	17.96	63.1	17.05	61.0	16.38	56.8	15.38
	3.0	2.2	73.5	18.12	69.3	17.02	65.2	16.32	63.1	15.49	61.0	14.94	56.8	13.99
	5.0	4.1	73.5	16.89	69.3	15.84	65.2	15.22	63.1	14.46	61.0	13.97	56.8	13.07
	7.0	6.0	73.5	15.66	69.3	14.67	65.2	14.13	63.1	13.42	61.0	13.00	56.8	12.13
9.0	7.9	73.5	14.14	69.3	13.24	65.2	12.76	63.1	12.12	61.0	11.74	56.8	10.96	
11.0	9.8	73.5	13.23	69.3	12.39	65.2	11.94	63.1	11.34	61.0	10.99	56.8	10.25	
13.0	11.8	73.5	12.43	69.3	11.64	65.2	11.20	63.1	10.65	61.0	10.32	56.8	9.63	
15.0	13.7	73.5	11.76	69.3	11.01	65.2	10.61	63.1	10.07	61.0	9.76	56.8	9.11	

**Note**

1. TC: Total Capacity(kW), PI : Power Input(kW, Comp. + Outdoor fan motor)
2. Capacity tables show the average value of conditions which may occur.
3. The heating capacity table is based on the values expressed as Max. in the specification of the outdoor unit. (When measuring the Max. heating capacity, the setting status of the indoor unit is the same as that for measuring the heating capacity of the indoor unit.)

# 7. Capacity Tables

## ◆ ARUM440LTE5

Heating Capacity (44HP)

Combination (%)	Outdoor air temp.		Indoor air temp. °C DB											
			16		18		20		21		22		24	
	°C DB	°C WB	TC	PI	TC	PI	TC	PI	TC	PI	TC	PI	TC	PI
130	-24.8	-25	84.9	46.9	84.9	47.22	84.3	47.46	84.3	47.82	84.3	48.18	82.8	48.73
	-21.8	-22	104.0	47.49	104.0	47.77	103.3	48.01	103.3	48.38	103.3	48.73	101.3	49.28
	-19.8	-20	110.1	47.86	110.1	48.14	109.3	48.38	109.3	48.75	109.3	49.09	107.3	49.65
	-18.8	-19	112.5	48.04	112.5	48.32	111.8	48.56	111.8	48.93	111.8	49.28	109.6	49.83
	-16.7	-17	117.6	48.43	117.6	48.71	116.9	48.95	116.9	49.32	116.9	49.67	114.7	50.22
	-13.7	-15	124.9	48.99	124.9	49.26	124.2	49.50	124.2	49.87	124.2	50.22	121.8	48.40
	-11.8	-13	129.0	49.34	129.0	49.61	128.2	49.85	128.2	50.22	128.2	49.00	126.3	47.24
	-9.8	-11	133.2	49.70	133.2	49.98	132.5	50.22	132.5	48.93	132.5	47.72	131.0	46.03
	-9.5	-10	134.0	49.77	134.0	50.03	133.2	50.02	133.2	48.74	133.1	47.52	131.7	45.84
	-8.5	-9.1	136.6	49.94	136.6	50.22	135.8	49.36	135.8	48.08	135.2	46.88	134.1	45.23
	-7.0	-7.6	140.5	50.22	140.5	49.27	139.6	48.38	139.6	47.11	139.6	45.91	137.6	44.32
	-5.0	-5.6	145.6	49.00	145.6	47.99	144.7	47.07	144.7	45.82	144.7	44.63	142.3	43.11
	-3.0	-3.7	150.8	47.79	150.8	46.72	149.9	45.75	149.9	44.52	149.9	43.34	147.0	41.88
	0.0	-0.7	158.5	45.96	158.5	44.82	157.5	43.78	157.5	42.58	157.5	41.42	154.2	40.06
	3.0	2.2	166.3	44.14	166.3	42.90	165.2	41.81	165.2	40.63	165.2	39.48	155.0	38.24
	5.0	4.1	171.4	42.92	171.4	41.63	170.4	40.49	170.4	39.34	166.5	38.19	155.0	37.02
	7.0	6.0	176.5	41.70	176.5	40.35	175.4	39.19	172.6	38.05	166.5	36.91	155.0	35.81
	9.0	7.9	177.4	40.70	177.4	39.39	176.9	38.25	172.6	37.14	166.5	36.03	155.0	34.95
	11.0	9.8	177.4	40.07	177.4	38.78	176.9	37.66	172.6	36.55	166.5	35.47	155.0	34.40
	13.0	11.8	177.4	39.38	177.4	38.11	176.9	37.00	172.6	35.93	166.5	34.86	155.0	33.81
15.0	13.7	177.4	38.64	177.4	37.39	176.9	36.30	172.6	35.24	166.5	34.20	155.0	33.17	
120	-24.8	-25	84.3	47.22	84.3	47.46	83.7	47.82	83.7	48.18	83.7	48.73	82.2	49.12
	-21.8	-22	103.3	47.77	103.3	48.01	102.6	48.38	102.6	48.73	102.6	49.28	100.7	49.67
	-19.8	-20	109.3	48.14	109.3	48.38	108.6	48.75	108.6	49.09	108.6	49.65	106.5	50.03
	-18.8	-19	111.7	48.32	111.7	48.56	111.0	48.93	111.0	49.28	111.0	49.83	108.9	50.22
	-16.7	-17	116.8	48.71	116.8	48.95	116.0	49.32	116.0	49.67	116.0	50.22	113.8	49.04
	-13.7	-15	124.0	49.26	124.0	49.50	123.3	49.87	123.3	50.22	123.3	48.47	120.9	47.37
	-11.8	-13	128.1	49.61	128.1	49.85	127.3	50.22	127.3	48.99	127.3	47.37	125.4	46.31
	-9.8	-11	132.3	49.98	132.3	50.22	131.5	48.87	131.5	47.69	131.5	46.21	130.1	45.19
	-9.5	-10	133.1	50.03	133.1	50.01	132.3	48.67	132.3	47.49	132.3	46.03	130.8	45.02
	-8.5	-9.1	135.6	50.22	135.6	49.29	134.8	47.99	134.8	46.85	134.8	45.46	133.1	44.46
	-7.0	-7.6	139.5	49.17	139.5	48.22	138.6	46.98	138.6	45.87	138.6	44.59	136.6	43.62
	-5.0	-5.6	144.7	47.76	144.7	46.80	143.7	45.62	143.7	44.57	143.7	43.42	141.4	42.50
	-3.0	-3.7	149.7	46.35	149.7	45.39	148.8	44.27	148.8	43.28	148.8	42.26	145.6	41.38
	0.0	-0.7	157.4	44.25	157.4	43.25	156.4	42.24	156.4	41.33	156.4	40.51	145.6	39.71
	3.0	2.2	165.1	42.14	165.1	41.11	164.1	40.21	161.7	39.39	156.7	38.77	145.6	38.03
	5.0	4.1	170.2	40.74	170.2	39.69	167.3	38.87	161.7	38.09	156.7	37.61	145.6	36.91
	7.0	6.0	175.4	39.33	174.2	38.26	167.3	37.51	161.7	36.79	156.7	36.45	145.6	35.79
	9.0	7.9	176.1	38.29	174.2	37.25	167.3	36.52	161.7	35.82	156.7	35.48	145.6	34.85
	11.0	9.8	176.1	37.59	174.2	36.57	167.3	35.84	161.7	35.16	156.7	34.83	145.6	34.21
	13.0	11.8	176.1	36.82	174.2	35.83	167.3	35.13	161.7	34.45	156.7	34.13	145.6	33.52
15.0	13.7	176.1	36.02	174.2	35.04	167.3	34.35	161.7	33.69	156.7	33.37	145.6	32.78	
110	-24.8	-25	83.9	47.46	83.9	47.82	83.3	48.18	83.3	48.73	83.3	49.12	81.7	49.30
	-21.8	-22	102.7	48.01	102.7	48.38	102.0	48.73	102.0	49.28	102.0	49.67	100.1	49.85
	-19.8	-20	108.7	48.38	108.7	48.75	108.0	49.09	108.0	49.65	108.0	50.03	105.9	50.22
	-18.8	-19	111.1	48.56	111.1	48.93	110.4	49.28	110.4	49.83	110.4	50.22	108.3	49.59
	-16.7	-17	116.2	48.95	116.2	49.32	115.4	49.67	115.4	50.22	115.4	48.95	113.2	48.28
	-13.7	-15	123.3	49.50	123.3	49.87	122.5	50.22	122.5	48.29	122.5	47.12	122.5	46.40
	-11.8	-13	127.3	49.85	127.3	50.22	126.6	48.86	126.6	47.07	126.6	45.96	126.6	45.21
	-9.8	-11	131.6	50.22	131.6	48.69	130.8	47.43	130.8	45.78	130.8	44.75	130.1	43.96
	-9.5	-10	132.3	49.97	132.3	48.45	131.6	47.21	131.6	45.59	131.6	44.57	131.0	43.78
	-8.5	-9.1	134.9	49.15	134.9	47.69	134.1	46.50	134.1	44.94	134.1	43.95	131.0	43.15
	-7.0	-7.6	138.8	47.90	138.8	46.54	137.9	45.42	137.9	43.98	137.9	43.04	131.0	42.22
	-5.0	-5.6	143.8	46.26	143.8	45.00	142.9	44.00	142.9	42.70	140.3	41.83	131.0	40.96
	-3.0	-3.7	148.9	44.61	148.9	43.47	148.0	42.56	145.2	41.40	140.3	40.60	131.0	39.71
	0.0	-0.7	156.5	42.13	156.5	41.17	150.1	40.42	145.2	39.47	140.3	38.78	131.0	37.83
	3.0	2.2	164.1	39.65	160.0	38.87	150.1	38.26	145.2	37.55	140.3	36.95	131.0	35.95
	5.0	4.1	169.3	38.00	160.0	37.34	150.1	36.84	145.2	36.25	140.3	35.74	131.0	34.70
	7.0	6.0	169.3	36.34	160.0	35.80	150.1	35.40	145.2	34.97	140.3	34.52	131.0	33.45
	9.0	7.9	169.3	35.22	160.0	34.70	150.1	34.31	145.2	33.89	140.3	33.45	131.0	32.42
	11.0	9.8	169.3	34.41	160.0	33.90	150.1	33.51	145.2	33.10	140.3	32.67	131.0	31.67
	13.0	11.8	169.3	33.53	160.0	33.03	150.1	32.66	145.2	32.26	140.3	31.85	131.0	30.87
15.0	13.7	169.3	32.60	160.0	32.10	150.1	31.75	145.2	31.36	140.3	30.96	131.0	30.00	

# 7. Capacity Tables

Heating Capacity (44HP)

Combination (%)	Outdoor air temp.		Indoor air temp. °C DB											
			16		18		20		21		22		24	
	°C DB	°C WB	TC	PI	TC	PI	TC	PI	TC	PI	TC	PI	TC	PI
100	-24.8	-25	83.5	52.33	83.5	52.06	83.0	48.29	83.0	51.36	83.0	51.07	81.3	50.93
	-21.8	-22	102.2	51.91	102.2	51.63	101.6	49.81	101.6	50.94	101.6	51.32	99.6	50.51
	-19.8	-20	108.2	51.63	108.2	51.34	107.6	50.75	107.6	50.66	107.6	50.59	105.5	50.22
	-18.8	-19	110.6	51.49	110.0	51.21	110.0	50.94	110.0	50.51	110.0	50.22	107.8	49.45
	-16.7	-17	114.9	51.20	114.9	50.91	114.9	51.32	114.3	50.22	114.3	48.63	112.1	47.83
	-13.7	-15	122.7	50.77	122.7	50.49	122.0	50.22	122.0	47.92	122.0	46.35	119.7	45.50
	-11.8	-13	126.7	50.51	126.0	50.22	126.0	48.69	126.0	46.46	126.0	44.91	119.7	44.03
	-9.8	-11	130.9	50.22	130.9	48.51	130.3	47.07	130.3	44.93	128.5	43.39	119.7	42.48
	-9.5	-10	131.6	49.95	131.6	48.24	131.0	46.83	131.0	44.70	128.5	43.17	119.7	42.25
	-8.5	-9.1	134.2	49.06	134.2	47.39	133.6	46.02	132.9	43.93	128.5	42.41	119.7	41.47
	-7.0	-7.6	140.3	47.72	139.7	46.10	137.3	44.80	132.9	42.78	128.5	41.27	119.7	40.31
	-5.0	-5.6	146.4	45.92	144.9	44.39	137.3	43.19	132.9	41.24	128.5	39.76	119.7	38.77
	-3.0	-3.7	150.6	44.14	146.1	42.67	137.3	41.58	132.9	39.71	128.5	38.24	119.7	37.22
	0.0	-0.7	154.9	41.45	146.1	40.10	137.3	39.15	132.9	37.41	128.5	35.96	119.7	34.90
	3.0	2.2	154.9	38.76	146.1	37.52	137.3	36.73	132.9	35.11	128.5	33.69	119.7	32.58
	5.0	4.1	154.9	36.98	146.1	35.80	137.3	35.11	132.9	33.58	128.5	32.17	119.7	31.03
	7.0	6.0	154.9	35.18	146.1	34.08	137.3	33.49	132.9	32.04	128.5	30.66	119.7	29.48
	9.0	7.9	154.9	33.95	146.1	32.89	137.3	32.32	132.9	30.92	128.5	29.59	119.7	28.45
	11.0	9.8	154.9	33.01	146.1	31.97	137.3	31.42	132.9	30.05	128.5	28.75	119.7	27.66
	13.0	11.8	154.9	32.01	146.1	31.00	137.3	30.46	132.9	29.14	128.5	27.88	119.7	26.81
15.0	13.7	154.9	30.94	146.1	29.96	137.3	29.44	132.9	28.17	128.5	26.95	119.7	25.92	
90	-24.8	-25	83.2	46.62	83.2	47.16	82.6	47.56	82.6	47.73	82.6	48.11	81.1	48.66
	-21.8	-22	101.8	47.16	101.8	47.72	101.2	48.11	101.2	48.29	101.2	48.66	99.2	46.60
	-19.8	-20	107.8	47.54	107.8	48.09	107.1	48.48	107.1	48.66	107.1	47.25	105.1	45.23
	-18.8	-19	110.6	47.72	110.0	48.28	109.5	48.66	109.5	47.94	109.5	46.55	107.4	44.54
	-16.7	-17	114.9	48.11	114.9	48.66	114.5	47.17	114.5	46.42	114.5	45.08	109.4	43.09
	-13.7	-15	122.7	48.66	122.7	46.44	121.6	45.04	121.6	44.26	117.9	42.97	109.4	41.04
	-11.8	-13	126.7	47.14	126.0	45.04	125.5	43.68	121.8	42.88	117.9	41.64	109.4	39.73
	-9.8	-11	130.9	45.56	130.9	43.57	125.6	42.27	121.8	41.43	117.9	40.23	109.4	38.35
	-9.5	-10	131.6	45.31	131.6	43.34	125.6	42.05	121.8	41.21	117.9	40.02	109.4	38.14
	-8.5	-9.1	134.2	44.52	133.2	42.61	125.6	41.34	121.8	40.50	117.9	39.32	109.4	37.46
	-7.0	-7.6	140.3	43.32	133.4	41.50	125.6	40.28	121.8	39.41	117.9	38.26	109.4	36.42
	-5.0	-5.6	141.8	41.72	133.4	40.03	125.6	38.86	121.8	37.97	117.9	36.86	109.4	35.06
	-3.0	-3.7	141.8	40.13	133.4	38.55	125.6	37.43	121.8	36.52	117.9	35.45	109.4	33.68
	0.0	-0.7	141.8	37.74	133.4	36.33	125.6	35.30	121.8	34.35	117.9	33.34	109.4	31.62
	3.0	2.2	141.8	35.35	133.4	34.12	125.6	33.17	121.8	32.19	117.9	31.24	109.4	29.55
	5.0	4.1	141.8	33.75	133.4	32.64	125.6	31.75	121.8	30.74	117.9	29.83	109.4	28.17
	7.0	6.0	141.8	32.16	133.4	31.17	125.6	30.33	121.8	29.30	117.9	28.43	109.4	26.81
	9.0	7.9	141.8	30.65	133.4	29.71	125.6	28.91	121.8	27.92	117.9	27.09	109.4	25.55
	11.0	9.8	141.8	29.14	133.4	28.25	125.6	27.49	121.8	26.55	117.9	25.76	109.4	24.29
	13.0	11.8	141.8	27.64	133.4	26.79	125.6	26.07	121.8	25.18	117.9	24.43	109.4	23.03
15.0	13.7	141.8	26.13	133.4	25.33	125.6	24.64	121.8	23.80	117.9	23.09	109.4	21.78	
80	-24.8	-25	82.8	41.10	82.8	41.66	82.3	42.05	82.3	42.23	82.3	43.15	80.7	41.34
	-21.8	-22	100.7	41.66	100.7	42.21	100.7	42.59	100.7	43.15	100.7	41.34	97.8	39.59
	-19.8	-20	106.7	42.02	106.7	42.58	106.7	43.15	106.7	41.87	105.1	40.12	97.8	38.42
	-18.8	-19	109.1	42.21	109.1	43.15	109.1	42.50	108.9	41.23	105.1	39.52	97.8	37.85
	-16.7	-17	112.4	43.15	112.4	41.80	112.4	41.14	109.0	39.89	105.1	38.26	97.8	36.63
	-13.7	-15	117.5	41.16	115.2	39.87	112.4	39.20	109.0	37.97	105.1	36.44	97.8	34.88
	-11.8	-13	120.4	39.89	116.9	38.65	112.4	37.97	109.0	36.76	105.1	35.29	97.8	33.77
	-9.8	-11	123.6	38.56	118.5	37.38	112.4	36.68	109.0	35.48	105.1	34.08	97.8	32.61
	-9.5	-10	124.5	38.36	119.2	37.18	112.4	36.48	109.0	35.29	105.1	33.90	97.8	32.44
	-8.5	-9.1	125.7	37.70	119.7	36.54	112.4	35.84	109.0	34.64	105.1	33.30	97.8	31.86
	-7.0	-7.6	127.0	36.70	119.7	35.57	112.4	34.87	109.0	33.69	105.1	32.39	97.8	30.98
	-5.0	-5.6	127.0	35.37	119.7	34.30	112.4	33.57	109.0	32.41	105.1	31.17	97.8	29.82
	-3.0	-3.7	127.0	34.04	119.7	33.01	112.4	32.28	109.0	31.13	105.1	29.97	97.8	28.65
	0.0	-0.7	127.0	32.04	119.7	31.09	112.4	30.34	109.0	29.22	105.1	28.15	97.8	26.91
	3.0	2.2	127.0	30.05	119.7	29.16	112.4	28.39	109.0	27.29	105.1	26.34	97.8	25.17
	5.0	4.1	127.0	28.72	119.7	27.88	112.4	27.10	109.0	26.01	105.1	25.13	97.8	24.00
	7.0	6.0	127.0	27.39	119.7	26.59	112.4	25.81	109.0	24.74	105.1	23.92	97.8	22.84
	9.0	7.9	127.0	25.72	119.7	24.97	112.4	24.23	109.0	23.23	105.1	22.46	97.8	21.45
	11.0	9.8	127.0	23.87	119.7	23.18	112.4	22.50	109.0	21.55	105.1	20.84	97.8	19.90
	13.0	11.8	127.0	22.28	119.7	21.63	112.4	21.00	109.0	20.13	105.1	19.46	97.8	18.58
15.0	13.7	127.0	20.97	119.7	20.36	112.4	19.76	109.0	18.94	105.1	18.32	97.8	17.49	

## 7. Capacity Tables

## Heating Capacity (44HP)

Combination (%)	Outdoor air temp.		Indoor air temp. °C DB											
			16		18		20		21		22		24	
	°C DB	°C WB	TC	PI	TC	PI	TC	PI	TC	PI	TC	PI	TC	PI
70	-24.8	-25	82.8	41.03	82.8	41.22	82.3	41.59	82.3	42.14	82.3	40.16	80.7	38.30
	-21.8	-22	96.3	41.59	96.3	41.77	95.7	42.14	92.4	40.16	89.6	38.30	83.7	36.51
	-19.8	-20	105.3	41.96	101.7	42.14	95.7	40.75	92.4	38.84	89.6	37.07	83.7	35.31
	-18.8	-19	107.7	42.14	101.7	41.43	95.7	40.05	92.4	38.17	89.6	36.44	83.7	34.71
	-16.7	-17	107.7	40.65	101.7	39.91	95.7	38.60	92.4	36.78	89.6	35.15	83.7	33.45
	-13.7	-15	107.7	38.53	101.7	37.76	95.7	36.51	92.4	34.81	89.6	33.29	83.7	31.65
	-11.8	-13	107.7	37.17	101.7	36.40	95.7	35.19	92.4	33.54	89.6	32.11	83.7	30.52
	-9.8	-11	107.7	35.76	101.7	34.95	95.7	33.80	92.4	32.22	89.6	30.88	83.7	29.32
	-9.5	-10	107.7	35.54	101.7	34.74	95.7	33.59	92.4	32.02	89.6	30.70	83.7	29.14
	-8.5	-9.1	107.7	34.84	101.7	34.02	95.7	32.90	92.4	31.36	89.6	30.07	83.7	28.54
	-7.0	-7.6	107.7	33.77	101.7	32.95	95.7	31.86	92.4	30.38	89.6	29.14	83.7	27.64
	-5.0	-5.6	107.7	32.36	101.7	31.51	95.7	30.46	92.4	29.05	89.6	27.91	83.7	26.45
	-3.0	-3.7	107.7	30.94	101.7	30.07	95.7	29.07	92.4	27.73	89.6	26.67	83.7	25.25
	0.0	-0.7	107.7	28.81	101.7	27.92	95.7	26.99	92.4	25.75	89.6	24.81	83.7	23.46
	3.0	2.2	107.7	26.68	101.7	25.77	95.7	24.90	92.4	23.77	89.6	22.96	83.7	21.65
	5.0	4.1	107.7	25.27	101.7	24.32	95.7	23.52	92.4	22.45	89.6	21.72	83.7	20.46
	7.0	6.0	107.7	23.85	101.7	22.89	95.7	22.12	92.4	21.13	89.6	20.49	83.7	19.26
	9.0	7.9	107.7	21.54	101.7	20.67	95.7	19.98	92.4	19.08	89.6	18.50	83.7	17.39
	11.0	9.8	107.7	20.06	101.7	19.24	95.7	18.60	92.4	17.76	89.6	17.23	83.7	16.19
13.0	11.8	107.7	18.76	101.7	18.01	95.7	17.40	92.4	16.62	89.6	16.12	83.7	15.16	
15.0	13.7	107.7	17.69	101.7	16.98	95.7	16.41	92.4	15.66	89.6	15.19	83.7	14.29	
60	-24.8	-25	82.2	40.59	82.2	40.96	81.6	41.52	79.3	39.38	76.5	37.38	71.7	35.50
	-21.8	-22	88.3	41.15	87.4	41.52	82.0	39.38	79.3	37.38	76.5	35.50	71.7	33.68
	-19.8	-20	92.4	41.52	87.4	40.01	82.0	37.96	79.3	36.05	76.5	34.24	71.7	32.46
	-18.8	-19	92.4	40.76	87.4	39.26	82.0	37.25	79.3	35.38	76.5	33.61	71.7	31.85
	-16.7	-17	92.4	39.16	87.4	37.67	82.0	35.75	79.3	33.97	76.5	32.30	71.7	30.58
	-13.7	-15	92.4	36.88	87.4	35.42	82.0	33.62	79.3	31.98	76.5	30.41	71.7	28.76
	-11.8	-13	92.4	35.44	87.4	33.98	82.0	32.26	79.3	30.70	76.5	29.22	71.7	27.61
	-9.8	-11	92.4	33.92	87.4	32.47	82.0	30.84	79.3	29.37	76.5	27.97	71.7	26.39
	-9.5	-10	92.4	33.69	87.4	32.25	82.0	30.63	79.3	29.17	76.5	27.77	71.7	26.21
	-8.5	-9.1	92.4	32.93	87.4	31.50	82.0	29.92	79.3	28.51	76.5	27.15	71.7	25.60
	-7.0	-7.6	92.4	31.80	87.4	30.37	82.0	28.86	79.3	27.50	76.5	26.21	71.7	24.69
	-5.0	-5.6	92.4	30.27	87.4	28.86	82.0	27.43	79.3	26.17	76.5	24.95	71.7	23.48
	-3.0	-3.7	92.4	28.76	87.4	27.35	82.0	26.01	79.3	24.84	76.5	23.69	71.7	22.26
	0.0	-0.7	92.4	26.47	87.4	25.09	82.0	23.88	79.3	22.83	76.5	21.81	71.7	20.45
	3.0	2.2	92.4	24.19	87.4	22.83	82.0	21.74	79.3	20.83	76.5	19.93	71.7	18.62
	5.0	4.1	92.4	22.68	87.4	21.32	82.0	20.32	79.3	19.50	76.5	18.68	71.7	17.41
	7.0	6.0	92.4	21.16	87.4	19.81	82.0	18.90	79.3	18.15	76.5	17.42	71.7	16.19
	9.0	7.9	92.4	18.88	87.4	17.69	82.0	16.85	79.3	16.20	76.5	15.54	71.7	14.45
	11.0	9.8	92.4	17.62	87.4	16.51	82.0	15.74	79.3	15.13	76.5	14.52	71.7	13.49
13.0	11.8	92.4	16.51	87.4	15.46	82.0	14.75	79.3	14.17	76.5	13.59	71.7	12.64	
15.0	13.7	92.4	15.60	87.4	14.62	82.0	13.93	79.3	13.39	76.5	12.85	71.7	11.95	
50	-24.8	-25	77.1	35.27	72.7	35.82	68.4	33.95	66.2	32.20	63.9	30.54	59.5	29.00
	-21.8	-22	77.1	35.82	72.7	33.95	68.4	32.20	66.2	30.54	63.9	29.00	59.5	27.51
	-19.8	-20	77.1	34.52	72.7	32.70	68.4	31.03	66.2	29.43	63.9	27.96	59.5	26.51
	-18.8	-19	77.1	33.86	72.7	32.07	68.4	30.45	66.2	28.89	63.9	27.45	59.5	26.02
	-16.7	-17	77.1	32.50	72.7	30.77	68.4	29.23	66.2	27.72	63.9	26.37	59.5	24.98
	-13.7	-15	77.1	30.55	72.7	28.89	68.4	27.47	66.2	26.06	63.9	24.83	59.5	23.49
	-11.8	-13	77.1	29.31	72.7	27.71	68.4	26.37	66.2	25.01	63.9	23.85	59.5	22.55
	-9.8	-11	77.1	28.01	72.7	26.46	68.4	25.19	66.2	23.90	63.9	22.81	59.5	21.55
	-9.5	-10	77.1	27.81	72.7	26.28	68.4	25.02	66.2	23.74	63.9	22.67	59.5	21.40
	-8.5	-9.1	77.1	27.16	72.7	25.65	68.4	24.44	66.2	23.19	63.9	22.15	59.5	20.90
	-7.0	-7.6	77.1	26.18	72.7	24.72	68.4	23.56	66.2	22.36	63.9	21.38	59.5	20.17
	-5.0	-5.6	77.1	24.88	72.7	23.47	68.4	22.40	66.2	21.26	63.9	20.35	59.5	19.17
	-3.0	-3.7	77.1	23.58	72.7	22.22	68.4	21.22	66.2	20.15	63.9	19.31	59.5	18.18
	0.0	-0.7	77.1	21.63	72.7	20.34	68.4	19.47	66.2	18.49	63.9	17.77	59.5	16.69
	3.0	2.2	77.1	19.67	72.7	18.48	68.4	17.73	66.2	16.83	63.9	16.23	59.5	15.20
	5.0	4.1	77.1	18.37	72.7	17.23	68.4	16.56	66.2	15.73	63.9	15.20	59.5	14.21
	7.0	6.0	77.1	17.07	72.7	15.98	68.4	15.39	66.2	14.62	63.9	14.16	59.5	13.22
	9.0	7.9	77.1	15.41	72.7	14.43	68.4	13.90	66.2	13.20	63.9	12.79	59.5	11.94
	11.0	9.8	77.1	14.42	72.7	13.50	68.4	13.00	66.2	12.36	63.9	11.97	59.5	11.17
13.0	11.8	77.1	13.54	72.7	12.68	68.4	12.21	66.2	11.60	63.9	11.24	59.5	10.49	
15.0	13.7	77.1	12.81	72.7	11.99	68.4	11.56	66.2	10.97	63.9	10.64	59.5	9.92	

## Note

1. TC: Total Capacity(kW), PI : Power Input(kW, Comp. + Outdoor fan motor)
2. Capacity tables show the average value of conditions which may occur.
3. The heating capacity table is based on the values expressed as Max. in the specification of the outdoor unit. (When measuring the Max. heating capacity, the setting status of the indoor unit is the same as that for measuring the heating capacity of the indoor unit.)

# 7. Capacity Tables

## ◆ ARUM460LTE5

Heating Capacity (46HP)

Combination (%)	Outdoor air temp.		Indoor air temp. °C DB											
			16		18		20		21		22		24	
	°C DB	°C WB	TC	PI	TC	PI	TC	PI	TC	PI	TC	PI	TC	PI
130	-24.8	-25	88.8	49.9	88.8	50.19	88.3	50.44	88.3	50.82	88.3	51.19	86.6	51.77
	-21.8	-22	108.8	50.47	108.8	50.76	108.1	51.01	108.1	51.40	108.1	51.77	106.0	52.34
	-19.8	-20	115.1	50.86	115.1	51.15	114.3	51.40	114.3	51.78	114.3	52.15	112.2	52.73
	-18.8	-19	117.7	51.05	117.7	51.34	116.9	51.59	116.9	51.98	116.9	52.34	114.7	52.92
	-16.7	-17	123.0	51.45	123.0	51.74	122.2	51.99	122.2	52.38	122.2	52.75	119.9	53.32
	-13.7	-15	130.6	52.03	130.6	52.32	129.8	52.57	129.8	52.96	129.8	53.32	127.3	51.39
	-11.8	-13	134.9	52.41	134.9	52.69	134.1	52.94	134.1	53.32	134.1	52.03	132.1	50.16
	-9.8	-11	139.4	52.78	139.4	53.07	138.5	53.32	138.5	51.96	138.5	50.67	137.0	48.87
	-9.5	-10	140.2	52.85	140.2	53.13	139.3	53.11	139.3	51.75	139.2	50.46	137.8	48.67
	-8.5	-9.1	142.9	53.03	142.9	53.32	142.0	52.42	142.0	51.05	141.5	49.78	140.2	48.03
	-7.0	-7.6	146.9	53.32	146.9	52.32	146.0	51.37	146.0	50.03	146.0	48.75	143.9	47.06
	-5.0	-5.6	152.3	52.03	152.3	50.96	151.3	49.98	151.3	48.65	151.3	47.38	148.9	45.77
	-3.0	-3.7	157.7	50.75	157.7	49.61	156.7	48.58	156.7	47.27	156.7	46.02	153.8	44.47
	0.0	-0.7	165.8	48.80	165.8	47.59	164.7	46.49	164.7	45.21	164.7	43.97	161.3	42.54
	3.0	2.2	173.9	46.87	173.9	45.55	172.8	44.39	172.8	43.15	172.8	41.92	162.1	40.61
	5.0	4.1	179.2	45.57	179.2	44.20	178.2	43.00	178.2	41.77	174.1	40.56	162.1	39.31
	7.0	6.0	184.6	44.28	184.6	42.85	183.4	41.61	180.5	40.40	174.1	39.19	162.1	38.02
	9.0	7.9	185.6	43.22	185.6	41.82	185.0	40.61	180.5	39.43	174.1	38.26	162.1	37.11
	11.0	9.8	185.6	42.54	185.6	41.18	185.0	39.98	180.5	38.81	174.1	37.66	162.1	36.53
	13.0	11.8	185.6	41.82	185.6	40.46	185.0	39.29	180.5	38.15	174.1	37.01	162.1	35.90
15.0	13.7	185.6	41.02	185.6	39.70	185.0	38.55	180.5	37.42	174.1	36.31	162.1	35.22	
120	-24.8	-25	88.2	50.19	88.2	50.44	87.7	50.82	87.7	51.19	87.7	51.77	86.0	52.17
	-21.8	-22	108.0	50.76	108.0	51.01	107.3	51.40	107.3	51.77	107.3	52.34	105.3	52.75
	-19.8	-20	114.3	51.15	114.3	51.40	113.5	51.78	113.5	52.15	113.5	52.73	111.4	53.13
	-18.8	-19	116.8	51.34	116.8	51.59	116.0	51.98	116.0	52.34	116.0	52.92	113.9	53.32
	-16.7	-17	122.1	51.74	122.1	51.99	121.3	52.38	121.3	52.75	121.3	53.32	119.0	52.08
	-13.7	-15	129.7	52.32	129.7	52.57	128.9	52.96	128.9	53.32	128.9	51.47	126.4	50.30
	-11.8	-13	133.9	52.69	133.9	52.94	133.1	53.32	133.1	52.02	133.1	50.30	131.1	49.17
	-9.8	-11	138.4	53.07	138.4	53.32	137.6	51.89	137.6	50.64	137.6	49.07	136.1	47.98
	-9.5	-10	139.2	53.13	139.2	53.10	138.4	51.68	138.4	50.43	138.4	48.88	136.8	47.80
	-8.5	-9.1	141.9	53.32	141.9	52.34	140.9	50.96	140.9	49.75	140.9	48.27	139.2	47.21
	-7.0	-7.6	145.9	52.21	145.9	51.21	145.0	49.88	145.0	48.71	145.0	47.34	142.9	46.32
	-5.0	-5.6	151.3	50.71	151.3	49.69	150.3	48.44	150.3	47.33	150.3	46.10	147.8	45.13
	-3.0	-3.7	156.6	49.22	156.6	48.19	155.6	47.01	155.6	45.96	155.6	44.87	152.3	43.94
	0.0	-0.7	164.6	46.98	164.6	45.92	163.5	44.85	163.5	43.89	163.5	43.01	152.3	42.16
	3.0	2.2	172.6	44.75	172.6	43.65	171.6	42.69	169.1	41.82	163.9	41.16	152.3	40.38
	5.0	4.1	178.0	43.26	178.0	42.14	175.0	41.27	169.1	40.44	163.9	39.93	152.3	39.19
	7.0	6.0	183.4	41.76	182.2	40.63	175.0	39.83	169.1	39.06	163.9	38.70	152.3	38.00
	9.0	7.9	184.1	40.65	182.2	39.55	175.0	38.78	169.1	38.04	163.9	37.68	152.3	37.00
	11.0	9.8	184.1	39.91	182.2	38.83	175.0	38.06	169.1	37.34	163.9	36.98	152.3	36.32
	13.0	11.8	184.1	39.10	182.2	38.04	175.0	37.30	169.1	36.58	163.9	36.24	152.3	35.59
15.0	13.7	184.1	38.24	182.2	37.20	175.0	36.47	169.1	35.77	163.9	35.43	152.3	34.80	
110	-24.8	-25	87.8	50.44	87.8	50.82	87.2	51.19	87.2	51.77	87.2	52.17	85.5	52.37
	-21.8	-22	107.4	51.01	107.4	51.40	106.7	51.77	106.7	52.34	106.7	52.75	104.7	52.94
	-19.8	-20	113.7	51.40	113.7	51.78	113.0	52.15	113.0	52.73	113.0	53.13	110.8	53.32
	-18.8	-19	116.2	51.59	116.2	51.98	115.4	52.34	115.4	52.92	115.4	53.32	113.3	52.66
	-16.7	-17	121.5	51.99	121.5	52.38	120.7	52.75	120.7	53.32	120.7	51.97	118.4	51.26
	-13.7	-15	128.9	52.57	128.9	52.96	128.2	53.32	128.2	51.28	128.2	50.03	128.2	49.27
	-11.8	-13	133.2	52.94	133.2	53.32	132.4	51.88	132.4	49.98	132.4	48.80	132.4	48.01
	-9.8	-11	137.6	53.32	137.6	51.70	136.8	50.37	136.8	48.61	136.8	47.51	136.0	46.68
	-9.5	-10	138.4	53.06	138.4	51.45	137.6	50.13	137.6	48.40	137.6	47.32	137.0	46.49
	-8.5	-9.1	141.1	52.19	141.1	50.64	140.3	49.37	140.3	47.72	140.3	46.67	137.0	45.82
	-7.0	-7.6	145.1	50.87	145.1	49.42	144.2	48.23	144.2	46.70	144.2	45.70	137.0	44.83
	-5.0	-5.6	150.4	49.12	150.4	47.78	149.4	46.72	149.4	45.34	146.7	44.41	137.0	43.49
	-3.0	-3.7	155.8	47.36	155.8	46.16	154.8	45.19	151.9	43.96	146.7	43.11	137.0	42.16
	0.0	-0.7	163.7	44.73	163.7	43.71	157.0	42.91	151.9	41.91	146.7	41.18	137.0	40.17
	3.0	2.2	171.7	42.10	167.3	41.27	157.0	40.63	151.9	39.87	146.7	39.23	137.0	38.17
	5.0	4.1	177.0	40.35	167.3	39.64	157.0	39.11	151.9	38.49	146.7	37.94	137.0	36.85
	7.0	6.0	177.0	38.59	167.3	38.02	157.0	37.59	151.9	37.13	146.7	36.66	137.0	35.52
	9.0	7.9	177.0	37.40	167.3	36.84	157.0	36.43	151.9	35.98	146.7	35.52	137.0	34.43
	11.0	9.8	177.0	36.54	167.3	35.99	157.0	35.58	151.9	35.15	146.7	34.69	137.0	33.63
	13.0	11.8	177.0	35.60	167.3	35.07	157.0	34.67	151.9	34.25	146.7	33.82	137.0	32.78
15.0	13.7	177.0	34.61	167.3	34.09	157.0	33.71	151.9	33.29	146.7	32.87	137.0	31.85	

# 7. Capacity Tables

Heating Capacity (46HP)

Combination (%)	Outdoor air temp.		Indoor air temp. °C DB											
			16		18		20		21		22		24	
	°C DB	°C WB	TC	PI	TC	PI	TC	PI	TC	PI	TC	PI	TC	PI
100	-24.8	-25	87.4	55.60	87.4	55.30	86.8	51.29	86.8	54.56	86.8	54.24	85.1	54.09
	-21.8	-22	106.9	55.15	106.9	54.85	106.3	52.91	106.3	54.10	106.3	54.50	104.2	53.63
	-19.8	-20	113.2	54.85	113.2	54.54	112.5	53.91	112.5	53.80	112.5	53.72	110.4	53.32
	-18.8	-19	115.6	54.70	115.0	54.39	115.0	54.10	115.0	53.64	115.0	53.32	112.7	52.51
	-16.7	-17	120.2	54.38	120.2	54.07	120.2	54.50	119.5	53.32	119.5	51.64	117.2	50.78
	-13.7	-15	128.3	53.92	128.3	53.61	127.6	53.32	127.6	50.88	127.6	49.22	125.2	48.31
	-11.8	-13	132.5	53.63	131.8	53.32	131.8	51.70	131.8	49.33	131.8	47.69	125.2	46.76
	-9.8	-11	136.9	53.32	136.9	51.50	136.2	49.98	136.2	47.70	134.4	46.08	125.2	45.11
	-9.5	-10	137.6	53.04	137.6	51.23	137.0	49.72	137.0	47.46	134.4	45.83	125.2	44.86
	-8.5	-9.1	140.3	52.09	140.3	50.32	139.7	48.86	139.0	46.65	134.4	45.03	125.2	44.04
	-7.0	-7.6	146.7	50.67	146.1	48.95	143.6	47.57	139.0	45.43	134.4	43.82	125.2	42.81
	-5.0	-5.6	153.1	48.76	151.6	47.13	143.6	45.86	139.0	43.79	134.4	42.22	125.2	41.16
	-3.0	-3.7	157.5	46.87	152.8	45.30	143.6	44.15	139.0	42.16	134.4	40.61	125.2	39.52
	0.0	-0.7	162.0	44.01	152.8	42.57	143.6	41.57	139.0	39.72	134.4	38.19	125.2	37.06
	3.0	2.2	162.0	41.16	152.8	39.84	143.6	39.00	139.0	37.28	134.4	35.77	125.2	34.59
	5.0	4.1	162.0	39.27	152.8	38.02	143.6	37.28	139.0	35.65	134.4	34.16	125.2	32.95
	7.0	6.0	162.0	37.36	152.8	36.19	143.6	35.56	139.0	34.02	134.4	32.55	125.2	31.30
	9.0	7.9	162.0	36.05	152.8	34.92	143.6	34.31	139.0	32.83	134.4	31.41	125.2	30.21
	11.0	9.8	162.0	35.05	152.8	33.95	143.6	33.36	139.0	31.91	134.4	30.53	125.2	29.37
	13.0	11.8	162.0	33.99	152.8	32.91	143.6	32.34	139.0	30.94	134.4	29.60	125.2	28.47
15.0	13.7	162.0	32.85	152.8	31.82	143.6	31.26	139.0	29.91	134.4	28.62	125.2	27.52	
90	-24.8	-25	87.0	49.54	87.0	50.11	86.5	50.52	86.5	50.71	86.5	51.09	84.9	51.68
	-21.8	-22	106.5	50.11	106.5	50.69	105.9	51.09	105.9	51.29	105.9	51.68	103.8	49.49
	-19.8	-20	112.7	50.50	112.7	51.08	112.0	51.48	112.0	51.68	112.0	51.18	109.9	48.03
	-18.8	-19	115.6	50.69	115.0	51.27	114.5	51.68	114.5	50.91	114.5	49.43	112.3	47.30
	-16.7	-17	120.2	51.09	120.2	51.68	119.7	50.09	119.7	49.30	119.7	47.87	114.4	45.76
	-13.7	-15	128.3	51.68	128.3	49.32	127.1	47.83	127.1	47.00	123.3	45.63	114.4	43.58
	-11.8	-13	132.5	50.06	131.8	47.83	131.3	46.39	127.3	45.53	123.3	44.22	114.4	42.19
	-9.8	-11	136.9	48.38	136.9	46.27	131.4	44.88	127.3	44.00	123.3	42.72	114.4	40.73
	-9.5	-10	137.6	48.12	137.6	46.03	131.4	44.66	127.3	43.77	123.3	42.49	114.4	40.50
	-8.5	-9.1	140.3	47.27	139.4	45.24	131.4	43.90	127.3	43.00	123.3	41.75	114.4	39.78
	-7.0	-7.6	146.7	46.00	139.6	44.07	131.4	42.77	127.3	41.85	123.3	40.63	114.4	38.68
	-5.0	-5.6	148.3	44.31	139.6	42.50	131.4	41.26	127.3	40.32	123.3	39.14	114.4	37.23
	-3.0	-3.7	148.3	42.61	139.6	40.94	131.4	39.75	127.3	38.78	123.3	37.64	114.4	35.76
	0.0	-0.7	148.3	40.08	139.6	38.58	131.4	37.48	127.3	36.48	123.3	35.40	114.4	33.58
	3.0	2.2	148.3	37.53	139.6	36.23	131.4	35.22	127.3	34.18	123.3	33.17	114.4	31.38
	5.0	4.1	148.3	35.84	139.6	34.66	131.4	33.71	127.3	32.64	123.3	31.67	114.4	29.92
	7.0	6.0	148.3	34.14	139.6	33.10	131.4	32.21	127.3	31.11	123.3	30.19	114.4	28.46
	9.0	7.9	148.3	32.54	139.6	31.54	131.4	30.69	127.3	29.65	123.3	28.76	114.4	27.13
	11.0	9.8	148.3	30.94	139.6	30.00	131.4	29.19	127.3	28.19	123.3	27.35	114.4	25.79
	13.0	11.8	148.3	29.35	139.6	28.44	131.4	27.68	127.3	26.74	123.3	25.94	114.4	24.46
15.0	13.7	148.3	27.75	139.6	26.89	131.4	26.16	127.3	25.27	123.3	24.52	114.4	23.12	
80	-24.8	-25	86.7	43.68	86.7	44.27	86.1	44.67	86.1	44.86	86.1	45.82	84.5	43.90
	-21.8	-22	105.4	44.27	105.4	44.84	105.4	45.24	105.4	45.82	105.4	43.90	102.2	42.04
	-19.8	-20	111.6	44.64	111.6	45.22	111.6	45.82	111.6	44.47	109.9	42.61	102.2	40.80
	-18.8	-19	114.0	44.84	114.0	45.82	114.0	45.13	113.9	43.78	109.9	41.96	102.2	40.19
	-16.7	-17	117.5	45.82	117.5	44.39	117.5	43.69	114.0	42.36	109.9	40.62	102.2	38.90
	-13.7	-15	122.9	43.70	120.4	42.34	117.5	41.63	114.0	40.32	109.9	38.69	102.2	37.04
	-11.8	-13	125.9	42.36	122.2	41.05	117.5	40.32	114.0	39.03	109.9	37.47	102.2	35.86
	-9.8	-11	129.3	40.95	124.0	39.69	117.5	38.95	114.0	37.68	109.9	36.18	102.2	34.63
	-9.5	-10	130.2	40.74	124.7	39.48	117.5	38.74	114.0	37.47	109.9	35.99	102.2	34.45
	-8.5	-9.1	131.5	40.03	125.2	38.80	117.5	38.06	114.0	36.79	109.9	35.36	102.2	33.83
	-7.0	-7.6	132.8	38.97	125.2	37.77	117.5	37.03	114.0	35.78	109.9	34.39	102.2	32.90
	-5.0	-5.6	132.8	37.56	125.2	36.42	117.5	35.65	114.0	34.41	109.9	33.10	102.2	31.66
	-3.0	-3.7	132.8	36.15	125.2	35.05	117.5	34.27	114.0	33.06	109.9	31.83	102.2	30.43
	0.0	-0.7	132.8	34.02	125.2	33.01	117.5	32.22	114.0	31.02	109.9	29.89	102.2	28.58
	3.0	2.2	132.8	31.91	125.2	30.96	117.5	30.15	114.0	28.98	109.9	27.97	102.2	26.72
	5.0	4.1	132.8	30.50	125.2	29.61	117.5	28.78	114.0	27.62	109.9	26.68	102.2	25.49
	7.0	6.0	132.8	29.09	125.2	28.24	117.5	27.41	114.0	26.27	109.9	25.40	102.2	24.25
	9.0	7.9	132.8	27.31	125.2	26.52	117.5	25.73	114.0	24.66	109.9	23.85	102.2	22.77
	11.0	9.8	132.8	25.34	125.2	24.61	117.5	23.89	114.0	22.89	109.9	22.13	102.2	21.13
	13.0	11.8	132.8	23.66	125.2	22.97	117.5	22.30	114.0	21.37	109.9	20.66	102.2	19.73
15.0	13.7	132.8	22.27	125.2	21.62	117.5	20.98	114.0	20.11	109.9	19.45	102.2	18.57	

# 7. Capacity Tables

Heating Capacity (46HP)

Combination (%)	Outdoor air temp.		Indoor air temp. °C DB													
			16		18		20		21		22		24			
	°C DB	°C WB	TC	PI	TC	PI	TC	PI	TC	PI	TC	PI	TC	PI		
70	-24.8	-25	86.7	43.59	86.7	43.78	86.1	44.17	86.1	44.75	86.1	42.65	86.1	42.65	84.5	40.67
	-21.8	-22	100.7	44.17	100.7	44.37	100.1	44.75	96.6	42.65	93.8	40.67	87.5	38.77		
	-19.8	-20	110.0	44.56	106.3	44.75	100.1	43.27	96.6	41.24	93.8	39.36	87.5	37.50		
	-18.8	-19	112.7	44.75	106.3	43.99	100.1	42.53	96.6	40.54	93.8	38.70	87.5	36.86		
	-16.7	-17	112.7	43.16	106.3	42.38	100.1	40.99	96.6	39.06	93.8	37.33	87.5	35.52		
	-13.7	-15	112.7	40.91	106.3	40.10	100.1	38.77	96.6	36.96	93.8	35.35	87.5	33.61		
	-11.8	-13	112.7	39.47	106.3	38.65	100.1	37.37	96.6	35.62	93.8	34.10	87.5	32.41		
	-9.8	-11	112.7	37.97	106.3	37.12	100.1	35.90	96.6	34.22	93.8	32.79	87.5	31.14		
	-9.5	-10	112.7	37.74	106.3	36.89	100.1	35.67	96.6	34.01	93.8	32.60	87.5	30.95		
	-8.5	-9.1	112.7	37.00	106.3	36.13	100.1	34.93	96.6	33.30	93.8	31.93	87.5	30.31		
	-7.0	-7.6	112.7	35.86	106.3	34.99	100.1	33.83	96.6	32.26	93.8	30.95	87.5	29.35		
	-5.0	-5.6	112.7	34.36	106.3	33.46	100.1	32.35	96.6	30.85	93.8	29.64	87.5	28.08		
	-3.0	-3.7	112.7	32.85	106.3	31.93	100.1	30.87	96.6	29.45	93.8	28.32	87.5	26.81		
	0.0	-0.7	112.7	30.59	106.3	29.65	100.1	28.66	96.6	27.34	93.8	26.35	87.5	24.91		
	3.0	2.2	112.7	28.33	106.3	27.36	100.1	26.44	96.6	25.24	93.8	24.38	87.5	22.99		
	5.0	4.1	112.7	26.83	106.3	25.83	100.1	24.97	96.6	23.84	93.8	23.06	87.5	21.72		
	7.0	6.0	112.7	25.33	106.3	24.31	100.1	23.49	96.6	22.43	93.8	21.75	87.5	20.45		
	9.0	7.9	112.7	22.87	106.3	21.95	100.1	21.22	96.6	20.26	93.8	19.65	87.5	18.46		
11.0	9.8	112.7	21.30	106.3	20.43	100.1	19.75	96.6	18.86	93.8	18.29	87.5	17.19			
13.0	11.8	112.7	19.92	106.3	19.12	100.1	18.48	96.6	17.65	93.8	17.11	87.5	16.09			
15.0	13.7	112.7	18.78	106.3	18.03	100.1	17.42	96.6	16.63	93.8	16.13	87.5	15.17			
60	-24.8	-25	85.9	43.13	85.9	43.52	85.4	44.10	82.9	41.83	80.0	39.71	74.9	37.70		
	-21.8	-22	92.3	43.71	91.4	44.10	85.8	41.83	82.9	39.71	80.0	37.70	74.9	35.77		
	-19.8	-20	96.6	44.10	91.4	42.50	85.8	40.32	82.9	38.29	80.0	36.37	74.9	34.48		
	-18.8	-19	96.6	43.30	91.4	41.70	85.8	39.56	82.9	37.57	80.0	35.70	74.9	33.83		
	-16.7	-17	96.6	41.60	91.4	40.01	85.8	37.97	82.9	36.08	80.0	34.30	74.9	32.48		
	-13.7	-15	96.6	39.17	91.4	37.62	85.8	35.71	82.9	33.96	80.0	32.30	74.9	30.55		
	-11.8	-13	96.6	37.64	91.4	36.09	85.8	34.27	82.9	32.61	80.0	31.04	74.9	29.32		
	-9.8	-11	96.6	36.03	91.4	34.49	85.8	32.76	82.9	31.19	80.0	29.70	74.9	28.03		
	-9.5	-10	96.6	35.78	91.4	34.26	85.8	32.53	82.9	30.98	80.0	29.50	74.9	27.84		
	-8.5	-9.1	96.6	34.98	91.4	33.45	85.8	31.78	82.9	30.27	80.0	28.83	74.9	27.19		
	-7.0	-7.6	96.6	33.77	91.4	32.25	85.8	30.65	82.9	29.21	80.0	27.83	74.9	26.22		
	-5.0	-5.6	96.6	32.15	91.4	30.65	85.8	29.13	82.9	27.79	80.0	26.50	74.9	24.94		
	-3.0	-3.7	96.6	30.54	91.4	29.04	85.8	27.62	82.9	26.38	80.0	25.16	74.9	23.64		
	0.0	-0.7	96.6	28.11	91.4	26.65	85.8	25.36	82.9	24.24	80.0	23.16	74.9	21.71		
	3.0	2.2	96.6	25.69	91.4	24.24	85.8	23.09	82.9	22.12	80.0	21.17	74.9	19.77		
	5.0	4.1	96.6	24.08	91.4	22.64	85.8	21.58	82.9	20.70	80.0	19.83	74.9	18.49		
	7.0	6.0	96.6	22.47	91.4	21.04	85.8	20.06	82.9	19.28	80.0	18.50	74.9	17.20		
	9.0	7.9	96.6	20.05	91.4	18.78	85.8	17.90	82.9	17.20	80.0	16.50	74.9	15.34		
11.0	9.8	96.6	18.71	91.4	17.53	85.8	16.72	82.9	16.06	80.0	15.41	74.9	14.32			
13.0	11.8	96.6	17.53	91.4	16.42	85.8	15.66	82.9	15.04	80.0	14.43	74.9	13.43			
15.0	13.7	96.6	16.57	91.4	15.52	85.8	14.79	82.9	14.22	80.0	13.64	74.9	12.69			
50	-24.8	-25	80.6	37.46	76.0	38.04	71.5	36.05	69.2	34.19	66.9	32.43	62.3	30.79		
	-21.8	-22	80.6	38.04	76.0	36.05	71.5	34.19	69.2	32.43	66.9	30.79	62.3	29.21		
	-19.8	-20	80.6	36.66	76.0	34.72	71.5	32.95	69.2	31.25	66.9	29.69	62.3	28.16		
	-18.8	-19	80.6	35.96	76.0	34.06	71.5	32.33	69.2	30.67	66.9	29.15	62.3	27.63		
	-16.7	-17	80.6	34.51	76.0	32.67	71.5	31.04	69.2	29.44	66.9	28.00	62.3	26.52		
	-13.7	-15	80.6	32.44	76.0	30.68	71.5	29.17	69.2	27.68	66.9	26.37	62.3	24.94		
	-11.8	-13	80.6	31.13	76.0	29.42	71.5	28.00	69.2	26.56	66.9	25.32	62.3	23.94		
	-9.8	-11	80.6	29.74	76.0	28.10	71.5	26.75	69.2	25.38	66.9	24.23	62.3	22.88		
	-9.5	-10	80.6	29.53	76.0	27.90	71.5	26.57	69.2	25.21	66.9	24.07	62.3	22.73		
	-8.5	-9.1	80.6	28.84	76.0	27.24	71.5	25.95	69.2	24.62	66.9	23.52	62.3	22.20		
	-7.0	-7.6	80.6	27.81	76.0	26.25	71.5	25.02	69.2	23.75	66.9	22.70	62.3	21.41		
	-5.0	-5.6	80.6	26.42	76.0	24.92	71.5	23.78	69.2	22.57	66.9	21.61	62.3	20.36		
	-3.0	-3.7	80.6	25.04	76.0	23.59	71.5	22.54	69.2	21.40	66.9	20.51	62.3	19.31		
	0.0	-0.7	80.6	22.96	76.0	21.60	71.5	20.68	69.2	19.63	66.9	18.87	62.3	17.72		
	3.0	2.2	80.6	20.89	76.0	19.62	71.5	18.83	69.2	17.87	66.9	17.24	62.3	16.14		
	5.0	4.1	80.6	19.51	76.0	18.29	71.5	17.58	69.2	16.70	66.9	16.14	62.3	15.09		
	7.0	6.0	80.6	18.12	76.0	16.97	71.5	16.34	69.2	15.53	66.9	15.04	62.3	14.03		
	9.0	7.9	80.6	16.36	76.0	15.32	71.5	14.76	69.2	14.02	66.9	13.58	62.3	12.67		
11.0	9.8	80.6	15.31	76.0	14.34	71.5	13.81	69.2	13.12	66.9	12.71	62.3	11.86			
13.0	11.8	80.6	14.38	76.0	13.46	71.5	12.96	69.2	12.32	66.9	11.94	62.3	11.14			
15.0	13.7	80.6	13.60	76.0	12.73	71.5	12.27	69.2	11.65	66.9	11.29	62.3	10.54			

**Note**

1. TC: Total Capacity(kW), PI : Power Input(kW, Comp. + Outdoor fan motor)
2. Capacity tables show the average value of conditions which may occur.
3. The heating capacity table is based on the values expressed as Max. in the specification of the outdoor unit. (When measuring the Max. heating capacity, the setting status of the indoor unit is the same as that for measuring the heating capacity of the indoor unit.)



# 7. Capacity Tables

## ◆ ARUM480LTE5

Heating Capacity (48HP)

Combination (%)	Outdoor air temp.		Indoor air temp. °C DB											
			16		18		20		21		22		24	
	°C DB	°C WB	TC	PI	TC	PI	TC	PI	TC	PI	TC	PI	TC	PI
130	-24.8	-25	90.8	51.4	90.8	51.86	90.2	52.22	90.2	52.76	90.2	53.30	88.6	54.14
	-21.8	-22	112.0	52.26	112.0	52.68	111.2	53.04	111.2	53.60	111.2	54.14	109.0	54.96
	-19.8	-20	118.8	52.82	118.8	53.24	118.0	53.60	118.0	54.16	118.0	54.68	115.8	55.52
	-18.8	-19	121.6	53.10	121.6	53.52	120.8	53.88	120.8	54.44	120.8	54.96	118.4	55.80
	-16.7	-17	127.2	53.68	127.2	54.10	126.4	54.46	126.4	55.02	126.4	55.56	124.0	56.38
	-13.7	-15	135.2	54.52	135.2	54.94	134.4	55.30	134.4	55.86	134.4	56.38	131.8	54.34
	-11.8	-13	139.6	55.06	139.6	55.46	138.8	55.82	138.8	56.38	138.8	55.02	136.8	53.04
	-9.8	-11	144.2	55.60	144.2	56.02	143.4	56.38	143.4	54.94	143.4	53.58	142.0	51.68
	-9.5	-10	145.0	55.70	145.0	56.10	144.2	56.16	144.2	54.72	144.0	53.36	142.8	51.46
	-8.5	-9.1	147.8	55.96	147.8	56.38	147.0	55.42	147.0	53.98	146.4	52.64	145.4	50.78
	-7.0	-7.6	152.0	56.38	152.0	55.32	151.0	54.32	151.0	52.90	151.0	51.54	149.2	49.76
	-5.0	-5.6	157.6	55.02	157.6	53.88	156.6	52.84	156.6	51.44	156.6	50.10	154.4	48.40
	-3.0	-3.7	163.2	53.66	163.2	52.46	162.2	51.36	162.2	49.98	162.2	48.66	159.6	47.02
	0.0	-0.7	171.6	51.60	171.6	50.32	170.4	49.16	170.4	47.80	170.4	46.50	167.6	44.98
	3.0	2.2	180.0	49.56	180.0	48.16	178.8	46.94	178.8	45.62	178.8	44.32	167.8	42.94
	5.0	4.1	185.4	48.18	185.4	46.74	184.4	45.46	184.4	44.16	184.4	42.88	167.8	41.56
	7.0	6.0	191.0	46.82	191.0	45.30	189.8	44.00	186.8	42.72	180.2	41.44	167.8	40.20
	9.0	7.9	192.0	45.70	192.0	44.22	191.4	42.94	186.8	41.70	180.2	40.46	167.8	39.24
	11.0	9.8	192.0	44.98	192.0	43.54	191.4	42.28	186.8	41.04	180.2	39.82	167.8	38.62
	13.0	11.8	192.0	44.22	192.0	42.78	191.4	41.54	186.8	40.34	180.2	39.14	167.8	37.96
15.0	13.7	192.0	43.38	192.0	41.98	191.4	40.76	186.8	39.56	180.2	38.40	167.8	37.24	
120	-24.8	-25	90.2	51.86	90.2	52.22	89.6	52.76	89.6	53.30	89.6	54.14	88.0	54.72
	-21.8	-22	111.2	52.68	111.2	53.04	110.4	53.60	110.4	54.14	110.4	54.96	108.4	55.56
	-19.8	-20	118.0	53.24	118.0	53.60	117.2	54.16	117.2	54.68	117.2	55.52	115.0	56.10
	-18.8	-19	120.6	53.52	120.6	53.88	119.8	54.44	119.8	54.96	119.8	55.80	117.6	56.38
	-16.7	-17	126.2	54.10	126.2	54.46	125.4	55.02	125.4	55.56	125.4	56.38	123.0	55.06
	-13.7	-15	134.2	54.94	134.2	55.30	133.4	55.86	133.4	56.38	133.4	54.42	130.8	53.18
	-11.8	-13	138.6	55.46	138.6	55.82	137.8	56.38	137.8	55.00	137.8	53.18	135.8	52.00
	-9.8	-11	143.2	56.02	143.2	56.38	142.4	54.86	142.4	53.54	142.4	51.88	141.0	50.74
	-9.5	-10	144.0	56.10	144.0	56.14	143.2	54.64	143.2	53.32	143.2	51.68	141.8	50.54
	-8.5	-9.1	146.8	56.38	146.8	55.34	145.8	53.88	145.8	52.60	145.8	51.04	144.2	49.92
	-7.0	-7.6	151.0	55.20	151.0	54.14	150.0	52.74	150.0	51.50	150.0	50.06	148.2	48.98
	-5.0	-5.6	156.6	53.62	156.6	52.54	155.6	51.22	155.6	50.04	155.6	48.74	153.4	47.72
	-3.0	-3.7	162.0	52.04	162.0	50.96	161.0	49.70	161.0	48.60	161.0	47.44	157.6	46.46
	0.0	-0.7	170.4	49.68	170.4	48.56	169.2	47.42	169.2	46.40	169.2	45.48	157.6	44.58
	3.0	2.2	178.6	47.32	178.6	46.16	177.6	45.14	175.0	44.22	169.6	43.52	157.6	42.70
	5.0	4.1	184.2	45.74	184.2	44.56	181.0	43.64	175.0	42.76	169.6	42.22	157.6	41.44
	7.0	6.0	189.8	44.16	188.6	42.96	181.0	42.12	175.0	41.30	169.6	40.92	157.6	40.18
	9.0	7.9	190.6	42.98	188.6	41.82	181.0	41.00	175.0	40.22	169.6	39.84	157.6	39.12
	11.0	9.8	190.6	42.20	188.6	41.06	181.0	40.24	175.0	39.48	169.6	39.10	157.6	38.40
	13.0	11.8	190.6	41.34	188.6	40.22	181.0	39.44	175.0	38.68	169.6	38.32	157.6	37.64
15.0	13.7	190.6	40.44	188.6	39.34	181.0	38.56	175.0	37.82	169.6	37.46	157.6	36.80	
110	-24.8	-25	89.8	52.22	89.8	52.76	89.2	53.30	89.2	54.14	89.2	54.72	87.4	55.00
	-21.8	-22	110.6	53.04	110.6	53.60	109.8	54.14	109.8	54.96	109.8	55.56	107.8	55.82
	-19.8	-20	117.4	53.60	117.4	54.16	116.6	54.68	116.6	55.52	116.6	56.10	114.4	56.38
	-18.8	-19	120.0	53.88	120.0	54.44	119.2	54.96	119.2	55.80	119.2	56.38	117.0	55.68
	-16.7	-17	125.6	54.46	125.6	55.02	124.8	55.56	124.8	56.38	124.8	54.96	122.4	54.20
	-13.7	-15	133.4	55.30	133.4	55.86	132.6	56.38	132.6	54.22	132.6	52.90	132.6	52.10
	-11.8	-13	137.8	55.82	137.8	56.38	137.0	54.86	137.0	52.84	137.0	51.60	137.0	50.76
	-9.8	-11	142.4	56.38	142.4	54.66	141.6	53.26	141.6	51.40	141.6	50.24	141.0	49.36
	-9.5	-10	143.2	56.10	143.2	54.40	142.4	53.00	142.4	51.18	142.4	50.04	141.8	49.16
	-8.5	-9.1	146.0	55.18	146.0	53.54	145.2	52.20	145.2	50.46	145.2	49.34	141.8	48.44
	-7.0	-7.6	150.2	53.78	150.2	52.26	149.2	51.00	149.2	49.38	149.2	48.32	141.8	47.40
	-5.0	-5.6	155.6	51.94	155.6	50.52	154.6	49.40	154.6	47.94	151.8	46.96	141.8	45.98
	-3.0	-3.7	161.2	50.08	161.2	48.80	160.2	47.78	157.2	46.48	151.8	45.58	141.8	44.58
	0.0	-0.7	169.4	47.30	169.4	46.22	162.4	45.38	157.2	44.32	151.8	43.54	141.8	42.48
	3.0	2.2	177.6	44.52	173.2	43.64	162.4	42.96	157.2	42.16	151.8	41.48	141.8	40.36
	5.0	4.1	183.2	42.66	173.2	41.92	162.4	41.36	157.2	40.70	151.8	40.12	141.8	38.96
	7.0	6.0	183.2	40.80	173.2	40.20	162.4	39.74	157.2	39.26	151.8	38.76	141.8	37.56
	9.0	7.9	183.2	39.54	173.2	38.96	162.4	38.52	157.2	38.04	151.8	37.56	141.8	36.40
	11.0	9.8	183.2	38.64	173.2	38.06	162.4	37.62	157.2	37.16	151.8	36.68	141.8	35.56
	13.0	11.8	183.2	37.64	173.2	37.08	162.4	36.66	157.2	36.22	151.8	35.76	141.8	34.66
15.0	13.7	183.2	36.60	173.2	36.04	162.4	35.64	157.2	35.20	151.8	34.76	141.8	33.68	

# 7. Capacity Tables

Heating Capacity (48HP)

Combination (%)	Outdoor air temp.		Indoor air temp. °C DB											
			16		18		20		21		22		24	
	°C DB	°C WB	TC	PI	TC	PI	TC	PI	TC	PI	TC	PI	TC	PI
100	-24.8	-25	89.4	57.96	89.4	57.76	88.8	53.88	88.8	57.24	88.8	57.02	87.0	56.92
	-21.8	-22	110.0	57.64	110.0	57.44	109.4	55.58	109.4	56.92	109.4	57.50	107.2	56.60
	-19.8	-20	116.8	57.44	116.8	57.22	116.2	56.64	116.2	56.72	116.2	56.76	114.0	56.38
	-18.8	-19	119.4	57.34	118.8	57.12	118.8	56.92	118.8	56.60	118.8	56.38	116.4	55.52
	-16.7	-17	124.2	57.12	124.2	56.90	124.2	57.50	123.6	56.38	123.6	54.60	121.2	53.70
	-13.7	-15	132.8	56.80	132.8	56.58	132.0	56.38	132.0	53.80	132.0	52.04	129.6	51.08
	-11.8	-13	137.2	56.60	136.4	56.38	136.4	54.66	136.4	52.16	136.4	50.42	129.6	49.44
	-9.8	-11	141.6	56.38	141.6	54.46	141.0	52.84	141.0	50.44	139.0	48.72	129.6	47.70
	-9.5	-10	142.4	56.08	142.4	54.16	141.8	52.58	141.8	50.18	139.0	48.46	129.6	47.44
	-8.5	-9.1	145.2	55.08	145.2	53.20	144.6	51.66	143.8	49.32	139.0	47.62	129.6	46.56
	-7.0	-7.6	151.8	53.58	151.2	51.76	148.6	50.30	143.8	48.04	139.0	46.34	129.6	45.26
	-5.0	-5.6	158.4	51.56	156.8	49.84	148.6	48.50	143.8	46.30	139.0	44.64	129.6	43.52
	-3.0	-3.7	163.0	49.56	158.2	47.90	148.6	46.68	143.8	44.58	139.0	42.94	129.6	41.78
	0.0	-0.7	167.6	46.54	158.2	45.02	148.6	43.96	143.8	42.00	139.0	40.38	129.6	39.18
	3.0	2.2	167.6	43.52	158.2	42.12	148.6	41.24	143.8	39.42	139.0	37.82	129.6	36.58
	5.0	4.1	167.6	41.52	158.2	40.20	148.6	39.42	143.8	37.70	139.0	36.12	129.6	34.84
	7.0	6.0	167.6	39.50	158.2	38.26	148.6	37.60	143.8	35.98	139.0	34.42	129.6	33.10
	9.0	7.9	167.6	38.12	158.2	36.92	148.6	36.28	143.8	34.72	139.0	33.22	129.6	31.94
	11.0	9.8	167.6	37.06	158.2	35.90	148.6	35.28	143.8	33.74	139.0	32.28	129.6	31.06
	13.0	11.8	167.6	35.94	158.2	34.80	148.6	34.20	143.8	32.72	139.0	31.30	129.6	30.10
15.0	13.7	167.6	34.74	158.2	33.64	148.6	33.06	143.8	31.62	139.0	30.26	129.6	29.10	
90	-24.8	-25	89.0	51.44	89.0	52.26	88.4	52.86	88.4	53.12	88.4	53.68	86.8	54.52
	-21.8	-22	109.6	52.26	109.6	53.10	109.0	53.68	109.0	53.96	109.0	54.52	106.8	52.22
	-19.8	-20	116.4	52.82	116.4	53.66	115.6	54.24	115.6	54.52	115.6	54.94	113.4	50.68
	-18.8	-19	119.4	53.10	118.8	53.94	118.2	54.52	118.2	53.72	118.2	52.16	116.0	49.92
	-16.7	-17	124.2	53.68	124.2	54.52	123.8	52.86	123.8	52.02	123.8	50.52	118.4	48.30
	-13.7	-15	132.8	54.52	132.8	52.04	131.6	50.48	131.6	49.60	127.6	48.16	118.4	46.00
	-11.8	-13	137.2	52.82	136.4	50.48	135.8	48.96	131.8	48.06	127.6	46.68	118.4	44.54
	-9.8	-11	141.6	51.06	141.6	48.84	136.0	47.38	131.8	46.44	127.6	45.10	118.4	43.00
	-9.5	-10	142.4	50.78	142.4	48.58	136.0	47.14	131.8	46.20	127.6	44.86	118.4	42.76
	-8.5	-9.1	145.2	49.90	144.2	47.76	136.0	46.34	131.8	45.40	127.6	44.08	118.4	42.00
	-7.0	-7.6	151.8	48.56	144.4	46.52	136.0	45.16	131.8	44.18	127.6	42.90	118.4	40.84
	-5.0	-5.6	153.4	46.78	144.4	44.88	136.0	43.58	131.8	42.58	127.6	41.34	118.4	39.32
	-3.0	-3.7	153.4	45.00	144.4	43.24	136.0	41.98	131.8	40.96	127.6	39.76	118.4	37.78
	0.0	-0.7	153.4	42.34	144.4	40.76	136.0	39.60	131.8	38.54	127.6	37.40	118.4	35.48
	3.0	2.2	153.4	39.66	144.4	38.28	136.0	37.22	131.8	36.12	127.6	35.06	118.4	33.16
	5.0	4.1	153.4	37.88	144.4	36.64	136.0	35.64	131.8	34.50	127.6	33.48	118.4	31.62
	7.0	6.0	153.4	36.10	144.4	35.00	136.0	34.06	131.8	32.90	127.6	31.92	118.4	30.10
	9.0	7.9	153.4	34.42	144.4	33.36	136.0	32.46	131.8	31.36	127.6	30.42	118.4	28.70
	11.0	9.8	153.4	32.74	144.4	31.74	136.0	30.88	131.8	29.82	127.6	28.94	118.4	27.28
	13.0	11.8	153.4	31.06	144.4	30.10	136.0	29.30	131.8	28.30	127.6	27.46	118.4	25.88
15.0	13.7	153.4	29.38	144.4	28.48	136.0	27.70	131.8	26.76	127.6	25.96	118.4	24.48	
80	-24.8	-25	88.6	45.26	88.6	46.10	88.0	46.68	88.0	46.96	88.0	48.34	86.4	46.32
	-21.8	-22	108.4	46.10	108.4	46.92	108.4	47.50	108.4	48.34	108.4	46.32	105.8	44.36
	-19.8	-20	115.2	46.64	115.2	47.48	115.2	48.34	115.2	46.92	113.8	44.96	105.8	43.06
	-18.8	-19	117.8	46.92	117.8	48.34	117.8	47.62	117.8	46.20	113.8	44.28	105.8	42.42
	-16.7	-17	121.6	48.34	121.6	46.84	121.6	46.10	118.0	44.70	113.8	42.88	105.8	41.06
	-13.7	-15	127.2	46.12	124.6	44.68	121.6	43.94	118.0	42.56	113.8	40.84	105.8	39.10
	-11.8	-13	130.2	44.70	126.4	43.32	121.6	42.56	118.0	41.20	113.8	39.56	105.8	37.86
	-9.8	-11	133.6	43.22	128.2	41.90	121.6	41.12	118.0	39.78	113.8	38.20	105.8	36.56
	-9.5	-10	134.6	43.00	129.0	41.68	121.6	40.90	118.0	39.56	113.8	38.00	105.8	36.38
	-8.5	-9.1	136.0	42.26	129.6	40.96	121.6	40.18	118.0	38.84	113.8	37.34	105.8	35.72
	-7.0	-7.6	137.4	41.14	129.6	39.88	121.6	39.10	118.0	37.78	113.8	36.32	105.8	34.74
	-5.0	-5.6	137.4	39.66	129.6	38.46	121.6	37.64	118.0	36.34	113.8	34.96	105.8	33.44
	-3.0	-3.7	137.4	38.18	129.6	37.02	121.6	36.20	118.0	34.92	113.8	33.62	105.8	32.14
	0.0	-0.7	137.4	35.94	129.6	34.88	121.6	34.04	118.0	32.78	113.8	31.58	105.8	30.20
	3.0	2.2	137.4	33.72	129.6	32.72	121.6	31.86	118.0	30.62	113.8	29.56	105.8	28.24
	5.0	4.1	137.4	32.24	129.6	31.30	121.6	30.42	118.0	29.20	113.8	28.20	105.8	26.94
	7.0	6.0	137.4	30.76	129.6	29.86	121.6	28.98	118.0	27.78	113.8	26.86	105.8	25.64
	9.0	7.9	137.4	28.88	129.6	28.04	121.6	27.20	118.0	26.08	113.8	25.22	105.8	24.08
	11.0	9.8	137.4	26.80	129.6	26.02	121.6	25.26	118.0	24.20	113.8	23.40	105.8	22.34
	13.0	11.8	137.4	25.02	129.6	24.28	121.6	23.58	118.0	22.60	113.8	21.84	105.8	20.86
15.0	13.7	137.4	23.54	129.6	22.86	121.6	22.18	118.0	21.26	113.8	20.56	105.8	19.64	

# 7. Capacity Tables

Heating Capacity (48HP)

Combination (%)	Outdoor air temp.		Indoor air temp. °C DB											
			16		18		20		21		22		24	
	°C DB	°C WB	TC	PI	TC	PI	TC	PI	TC	PI	TC	PI	TC	PI
70	-24.8	-25	88.6	45.54	88.6	45.82	88.0	46.38	88.0	47.22	88.0	45.00	86.4	42.92
	-21.8	-22	104.2	46.38	104.2	46.66	103.6	47.22	100.0	45.00	97.0	42.92	90.6	40.92
	-19.8	-20	114.6	46.94	110.0	47.22	103.6	45.66	100.0	43.52	97.0	41.54	90.6	39.58
	-18.8	-19	116.6	47.22	110.0	46.42	103.6	44.88	100.0	42.78	97.0	40.84	90.6	38.90
	-16.7	-17	116.6	45.54	110.0	44.72	103.6	43.26	100.0	41.22	97.0	39.40	90.6	37.50
	-13.7	-15	116.6	43.18	110.0	42.32	103.6	40.92	100.0	39.02	97.0	37.32	90.6	35.48
	-11.8	-13	116.6	41.66	110.0	40.80	103.6	39.44	100.0	37.60	97.0	36.00	90.6	34.22
	-9.8	-11	116.6	40.08	110.0	39.18	103.6	37.90	100.0	36.12	97.0	34.62	90.6	32.88
	-9.5	-10	116.6	39.84	110.0	38.94	103.6	37.66	100.0	35.90	97.0	34.42	90.6	32.68
	-8.5	-9.1	116.6	39.06	110.0	38.14	103.6	36.88	100.0	35.16	97.0	33.72	90.6	32.00
	-7.0	-7.6	116.6	37.86	110.0	36.94	103.6	35.72	100.0	34.06	97.0	32.68	90.6	31.00
	-5.0	-5.6	116.6	36.28	110.0	35.34	103.6	34.16	100.0	32.58	97.0	31.30	90.6	29.66
	-3.0	-3.7	116.6	34.70	110.0	33.72	103.6	32.60	100.0	31.10	97.0	29.92	90.6	28.32
	0.0	-0.7	116.6	32.32	110.0	31.32	103.6	30.28	100.0	28.88	97.0	27.84	90.6	26.32
	3.0	2.2	116.6	29.94	110.0	28.92	103.6	27.94	100.0	26.68	97.0	25.76	90.6	24.30
	5.0	4.1	116.6	28.36	110.0	27.30	103.6	26.40	100.0	25.20	97.0	24.38	90.6	22.96
	7.0	6.0	116.6	26.78	110.0	25.70	103.6	24.84	100.0	23.72	97.0	23.00	90.6	21.62
	9.0	7.9	116.6	24.18	110.0	23.20	103.6	22.44	100.0	21.42	97.0	20.78	90.6	19.52
11.0	9.8	116.6	22.52	110.0	21.60	103.6	20.88	100.0	19.94	97.0	19.34	90.6	18.18	
13.0	11.8	116.6	21.06	110.0	20.22	103.6	19.54	100.0	18.66	97.0	18.10	90.6	17.02	
15.0	13.7	116.6	19.86	110.0	19.06	103.6	18.42	100.0	17.58	97.0	17.06	90.6	16.04	
60	-24.8	-25	88.6	44.98	88.6	45.54	88.0	46.38	85.8	44.00	82.8	41.78	77.6	39.68
	-21.8	-22	95.4	45.82	94.6	46.38	88.8	44.00	85.8	41.78	82.8	39.68	77.6	37.66
	-19.8	-20	100.0	46.38	94.6	44.70	88.8	42.42	85.8	40.30	82.8	38.28	77.6	36.30
	-18.8	-19	100.0	45.54	94.6	43.86	88.8	41.62	85.8	39.54	82.8	37.58	77.6	35.62
	-16.7	-17	100.0	43.76	94.6	42.10	88.8	39.96	85.8	37.98	82.8	36.12	77.6	34.20
	-13.7	-15	100.0	41.22	94.6	39.60	88.8	37.60	85.8	35.76	82.8	34.02	77.6	32.18
	-11.8	-13	100.0	39.62	94.6	38.00	88.8	36.08	85.8	34.34	82.8	32.70	77.6	30.90
	-9.8	-11	100.0	37.94	94.6	36.32	88.8	34.50	85.8	32.86	82.8	31.30	77.6	29.54
	-9.5	-10	100.0	37.68	94.6	36.08	88.8	34.26	85.8	32.64	82.8	31.08	77.6	29.34
	-8.5	-9.1	100.0	36.84	94.6	35.24	88.8	33.48	85.8	31.90	82.8	30.38	77.6	28.66
	-7.0	-7.6	100.0	35.58	94.6	33.98	88.8	32.30	85.8	30.78	82.8	29.34	77.6	27.64
	-5.0	-5.6	100.0	33.88	94.6	32.30	88.8	30.70	85.8	29.30	82.8	27.94	77.6	26.30
	-3.0	-3.7	100.0	32.20	94.6	30.62	88.8	29.12	85.8	27.82	82.8	26.54	77.6	24.94
	0.0	-0.7	100.0	29.66	94.6	28.12	88.8	26.76	85.8	25.58	82.8	24.44	77.6	22.92
	3.0	2.2	100.0	27.12	94.6	25.60	88.8	24.38	85.8	23.36	82.8	22.36	77.6	20.88
	5.0	4.1	100.0	25.44	94.6	23.92	88.8	22.80	85.8	21.88	82.8	20.96	77.6	19.54
	7.0	6.0	100.0	23.76	94.6	22.24	88.8	21.22	85.8	20.38	82.8	19.56	77.6	18.18
	9.0	7.9	100.0	21.20	94.6	19.86	88.8	18.92	85.8	18.18	82.8	17.44	77.6	16.22
11.0	9.8	100.0	19.78	94.6	18.54	88.8	17.68	85.8	16.98	82.8	16.30	77.6	15.14	
13.0	11.8	100.0	18.54	94.6	17.36	88.8	16.56	85.8	15.90	82.8	15.26	77.6	14.20	
15.0	13.7	100.0	17.52	94.6	16.42	88.8	15.64	85.8	15.04	82.8	14.42	77.6	13.42	
50	-24.8	-25	83.4	39.30	78.6	40.14	74.0	38.04	71.6	36.08	69.2	34.22	64.4	32.50
	-21.8	-22	83.4	40.14	78.6	38.04	74.0	36.08	71.6	34.22	69.2	32.50	64.4	30.84
	-19.8	-20	83.4	38.68	78.6	36.64	74.0	34.78	71.6	32.98	69.2	31.34	64.4	29.72
	-18.8	-19	83.4	37.94	78.6	35.94	74.0	34.12	71.6	32.38	69.2	30.76	64.4	29.16
	-16.7	-17	83.4	36.42	78.6	34.48	74.0	32.76	71.6	31.08	69.2	29.56	64.4	28.00
	-13.7	-15	83.4	34.24	78.6	32.38	74.0	30.80	71.6	29.22	69.2	27.84	64.4	26.34
	-11.8	-13	83.4	32.86	78.6	31.06	74.0	29.56	71.6	28.04	69.2	26.74	64.4	25.28
	-9.8	-11	83.4	31.40	78.6	29.66	74.0	28.24	71.6	26.80	69.2	25.58	64.4	24.16
	-9.5	-10	83.4	31.18	78.6	29.46	74.0	28.06	71.6	26.62	69.2	25.42	64.4	24.00
	-8.5	-9.1	83.4	30.44	78.6	28.76	74.0	27.40	71.6	26.00	69.2	24.84	64.4	23.44
	-7.0	-7.6	83.4	29.36	78.6	27.72	74.0	26.42	71.6	25.08	69.2	23.98	64.4	22.62
	-5.0	-5.6	83.4	27.90	78.6	26.32	74.0	25.12	71.6	23.84	69.2	22.82	64.4	21.50
	-3.0	-3.7	83.4	26.44	78.6	24.92	74.0	23.80	71.6	22.60	69.2	21.66	64.4	20.40
	0.0	-0.7	83.4	24.26	78.6	22.82	74.0	21.84	71.6	20.74	69.2	19.94	64.4	18.72
	3.0	2.2	83.4	22.08	78.6	20.74	74.0	19.90	71.6	18.88	69.2	18.22	64.4	17.06
	5.0	4.1	83.4	20.62	78.6	19.34	74.0	18.58	71.6	17.66	69.2	17.06	64.4	15.96
	7.0	6.0	83.4	19.16	78.6	17.94	74.0	17.28	71.6	16.42	69.2	15.90	64.4	14.84
	9.0	7.9	83.4	17.30	78.6	16.20	74.0	15.60	71.6	14.82	69.2	14.36	64.4	13.40
11.0	9.8	83.4	16.18	78.6	15.16	74.0	14.60	71.6	13.88	69.2	13.44	64.4	12.54	
13.0	11.8	83.4	15.20	78.6	14.24	74.0	13.70	71.6	13.02	69.2	12.62	64.4	11.78	
15.0	13.7	83.4	14.38	78.6	13.46	74.0	12.98	71.6	12.32	69.2	11.94	64.4	11.14	

**Note**

1. TC: Total Capacity(kW), PI : Power Input(kW, Comp. + Outdoor fan motor)
2. Capacity tables show the average value of conditions which may occur.
3. The heating capacity table is based on the values expressed as Max. in the specification of the outdoor unit. (When measuring the Max. heating capacity, the setting status of the indoor unit is the same as that for measuring the heating capacity of the indoor unit.)

# 7. Capacity Tables

## ◆ ARUM500LTE5

Heating Capacity (50HP)

Combination (%)	Outdoor air temp.		Indoor air temp. °C DB											
			16		18		20		21		22		24	
	°C DB	°C WB	TC	PI	TC	PI	TC	PI	TC	PI	TC	PI	TC	PI
130	-24.8	-25	96.6	50.2	96.6	50.77	96.1	51.26	96.1	51.99	96.1	52.71	94.6	53.83
	-21.8	-22	117.7	51.33	117.7	51.88	116.8	52.37	116.8	53.11	116.8	53.83	115.0	54.93
	-19.8	-20	124.1	52.07	124.1	52.63	123.3	53.11	123.3	53.86	123.3	54.56	121.4	55.68
	-18.8	-19	127.0	52.45	127.0	53.00	126.2	53.49	126.2	54.23	126.2	54.93	124.2	56.05
	-16.7	-17	133.1	53.23	133.1	53.78	132.2	54.27	132.2	55.01	132.2	55.72	130.1	56.83
	-13.7	-15	141.6	54.35	141.6	54.90	140.8	55.39	140.8	56.13	140.8	56.83	138.5	54.62
	-11.8	-13	146.2	55.06	146.2	55.60	145.4	56.09	145.4	56.83	145.4	57.56	143.8	53.22
	-9.8	-11	151.1	55.79	151.1	56.35	150.1	56.83	150.1	57.56	150.1	58.23	149.1	51.75
	-9.5	-10	152.0	55.92	152.0	56.46	151.1	56.59	151.1	57.23	151.1	57.96	150.0	51.51
	-8.5	-9.1	155.1	56.28	155.1	56.83	154.2	57.77	154.2	58.50	154.2	59.23	152.7	50.77
	-7.0	-7.6	159.8	56.83	159.8	57.38	158.7	58.11	158.7	58.84	158.7	59.57	157.3	49.67
	-5.0	-5.6	166.1	57.26	166.1	57.81	165.0	58.54	165.0	59.27	165.0	60.00	162.8	48.19
	-3.0	-3.7	172.3	57.69	172.3	58.24	171.2	58.97	171.2	59.70	171.2	60.43	168.4	46.71
	0.0	-0.7	181.6	58.12	181.6	58.79	180.5	59.52	180.5	60.25	180.5	60.98	176.3	44.50
	3.0	2.2	191.0	48.96	191.0	47.55	189.7	46.32	189.7	44.98	188.2	43.68	176.4	42.28
	5.0	4.1	196.6	47.37	196.6	45.93	195.6	44.68	194.4	43.38	189.4	42.11	176.4	40.79
	7.0	6.0	201.1	45.79	201.1	44.31	199.9	43.03	196.3	41.78	189.4	40.53	176.4	39.32
9.0	7.9	201.9	44.49	201.9	43.05	201.2	41.80	196.3	40.59	189.4	39.39	176.4	38.20	
11.0	9.8	201.9	43.56	201.9	42.16	201.2	40.94	196.3	39.75	189.4	38.56	176.4	37.40	
13.0	11.8	201.9	42.58	201.9	41.20	201.2	40.00	196.3	38.84	189.4	37.69	176.4	36.56	
15.0	13.7	201.9	41.52	201.9	40.18	201.2	39.01	196.3	37.87	189.4	36.75	176.4	35.64	
120	-24.8	-25	96.0	50.77	96.0	51.26	95.4	51.99	95.4	52.71	95.4	53.46	93.9	54.61
	-21.8	-22	116.8	51.88	116.8	52.37	116.0	53.11	116.0	53.83	116.0	54.56	114.3	55.72
	-19.8	-20	123.2	52.63	123.2	53.11	122.4	53.86	122.4	54.56	122.4	55.23	120.5	56.46
	-18.8	-19	126.1	53.00	126.1	53.49	125.2	54.23	125.2	54.93	125.2	55.66	123.3	56.83
	-16.7	-17	132.1	53.78	132.1	54.27	131.3	55.01	131.3	55.72	131.3	56.46	129.1	55.41
	-13.7	-15	140.5	54.90	140.5	55.39	139.7	56.13	139.7	56.83	139.7	57.56	137.5	53.37
	-11.8	-13	145.1	55.60	145.1	56.09	144.3	56.83	144.3	57.56	144.3	58.23	142.7	52.09
	-9.8	-11	150.0	56.35	150.0	56.83	149.1	57.56	149.1	58.23	149.1	58.96	148.1	50.73
	-9.5	-10	151.0	56.46	151.0	56.57	150.1	56.83	150.1	57.56	150.1	58.23	149.1	50.52
	-8.5	-9.1	154.1	56.83	154.1	57.38	153.0	58.11	153.0	58.84	153.0	59.57	151.9	49.84
	-7.0	-7.6	158.7	57.38	158.7	57.93	157.7	58.66	157.7	59.39	157.7	60.12	156.2	48.82
	-5.0	-5.6	164.9	57.76	164.9	58.31	163.8	59.04	163.8	59.77	163.8	60.50	161.8	47.46
	-3.0	-3.7	171.1	58.19	171.1	58.74	170.0	59.47	170.0	60.20	170.0	60.93	167.9	46.10
	0.0	-0.7	180.3	49.36	180.3	48.20	179.1	47.02	179.1	45.96	177.9	44.99	165.7	44.06
	3.0	2.2	189.6	46.71	189.6	45.55	187.5	44.52	184.0	43.58	178.2	42.86	165.7	42.03
	5.0	4.1	195.2	44.95	194.7	43.79	190.3	42.86	184.0	41.99	178.2	41.44	165.7	40.67
	7.0	6.0	199.7	43.19	198.2	42.03	190.3	41.20	184.0	40.40	178.2	40.03	165.7	39.31
9.0	7.9	200.3	41.85	198.2	40.72	190.3	39.93	184.0	39.17	178.2	38.80	165.7	38.09	
11.0	9.8	200.3	40.90	198.2	39.78	190.3	38.99	184.0	38.25	178.2	37.89	165.7	37.22	
13.0	11.8	200.3	39.86	198.2	38.77	190.3	38.01	184.0	37.29	178.2	36.93	165.7	36.28	
15.0	13.7	200.3	38.75	198.2	37.69	190.3	36.96	184.0	36.25	178.2	35.90	165.7	35.26	
110	-24.8	-25	95.5	51.26	95.5	51.99	94.9	52.71	94.9	53.46	94.9	54.21	93.4	54.98
	-21.8	-22	116.2	52.37	116.2	53.11	115.4	53.83	115.4	54.56	115.4	55.23	113.7	56.09
	-19.8	-20	122.6	53.11	122.6	53.86	121.8	54.56	121.8	55.23	121.8	55.96	119.9	56.83
	-18.8	-19	125.4	53.49	125.4	54.23	124.5	54.93	124.5	55.66	124.5	56.33	122.7	56.09
	-16.7	-17	131.4	54.27	131.4	55.01	130.6	55.72	130.6	56.46	130.6	57.13	128.4	54.51
	-13.7	-15	139.8	55.39	139.8	56.13	138.9	56.83	138.9	57.56	138.9	58.23	136.9	52.26
	-11.8	-13	144.4	56.09	144.4	56.83	143.5	57.56	143.5	58.23	143.5	58.96	141.5	50.84
	-9.8	-11	149.2	56.83	149.2	57.56	148.3	58.23	148.3	58.96	148.3	59.69	146.3	49.34
	-9.5	-10	150.1	56.53	150.1	56.83	149.3	57.56	149.3	58.23	149.3	58.96	148.8	49.11
	-8.5	-9.1	153.2	57.38	153.2	58.11	152.3	58.84	152.3	59.57	152.3	60.30	149.1	48.36
	-7.0	-7.6	157.9	57.93	157.9	58.48	156.9	59.21	156.9	59.94	156.9	60.67	149.1	47.24
	-5.0	-5.6	164.0	58.31	164.0	58.86	162.9	59.59	162.9	60.32	162.9	61.05	149.1	45.73
	-3.0	-3.7	170.1	58.74	170.1	59.29	168.9	60.02	168.9	60.75	168.9	61.48	149.1	44.24
	0.0	-0.7	179.4	46.97	179.0	45.84	177.7	44.95	176.2	44.34	174.7	43.84	172.9	42.00
	3.0	2.2	188.1	43.95	182.0	43.04	177.7	42.34	176.2	41.52	174.7	40.84	172.9	39.74
	5.0	4.1	192.5	41.93	182.0	41.19	177.7	40.62	176.2	39.96	174.7	39.38	172.9	38.24
	7.0	6.0	192.6	39.91	182.0	39.32	177.7	38.87	176.2	38.40	174.7	37.91	172.9	36.74
9.0	7.9	192.6	38.51	182.0	37.94	177.7	37.52	176.2	37.06	174.7	36.58	172.9	35.45	
11.0	9.8	192.6	37.45	182.0	36.89	177.7	36.47	176.2	36.02	174.7	35.56	172.9	34.46	
13.0	11.8	192.6	36.29	182.0	35.76	177.7	35.35	176.2	34.92	174.7	34.47	172.9	33.42	
15.0	13.7	192.6	35.09	182.0	34.56	177.7	34.16	176.2	33.75	174.7	33.33	172.9	32.29	

# 7. Capacity Tables

Heating Capacity (50HP)

Combination (%)	Outdoor air temp.		Indoor air temp. °C DB											
			16		18		20		21		22		24	
	°C DB	°C WB	TC	PI	TC	PI	TC	PI	TC	PI	TC	PI	TC	PI
100	-24.8	-25	95.1	56.99	95.1	56.97	94.5	53.74	94.5	56.92	94.5	56.90	93.0	56.89
	-21.8	-22	115.6	56.96	115.6	56.94	115.0	55.43	115.0	56.89	115.0	57.67	113.1	56.86
	-19.8	-20	122.0	56.94	122.0	56.91	121.3	56.51	121.3	56.87	121.3	57.11	119.4	56.83
	-18.8	-19	124.8	56.93	124.1	56.91	124.1	56.89	124.1	56.85	124.1	56.83	122.1	55.92
	-16.7	-17	130.0	56.91	130.0	56.89	130.0	57.67	129.3	56.83	129.3	54.95	127.2	54.01
	-13.7	-15	139.1	56.88	139.1	56.85	138.3	56.83	138.3	54.10	138.3	52.26	136.3	51.27
	-11.8	-13	143.7	56.86	142.9	56.83	142.9	55.00	142.9	52.36	142.9	50.54	136.3	49.54
	-9.8	-11	148.4	56.83	148.4	54.77	147.7	53.06	147.7	50.54	146.2	48.76	136.3	47.71
	-9.5	-10	149.3	56.51	149.3	54.46	148.6	52.77	148.6	50.26	146.2	48.48	136.3	47.44
	-8.5	-9.1	152.4	55.43	152.4	53.43	151.7	51.80	151.2	49.34	146.2	47.59	136.3	46.52
	-7.0	-7.6	159.6	53.81	159.0	51.88	156.2	50.34	151.2	47.98	146.2	46.24	136.3	45.15
	-5.0	-5.6	166.5	51.64	164.9	49.82	156.2	48.41	151.2	46.15	146.2	44.44	136.3	43.32
	-3.0	-3.7	171.4	49.48	166.2	47.75	156.2	46.47	151.2	44.32	146.2	42.66	136.3	41.50
	0.0	-0.7	176.1	46.23	166.2	44.66	156.2	43.56	151.2	41.59	146.2	39.95	136.3	38.76
	3.0	2.2	176.1	42.97	166.2	41.56	156.2	40.66	151.2	38.85	146.2	37.26	136.3	36.03
	5.0	4.1	176.1	40.81	166.2	39.50	156.2	38.72	151.2	37.01	146.2	35.46	136.3	34.20
	7.0	6.0	176.1	38.64	166.2	37.43	156.2	36.78	151.2	35.19	146.2	33.67	136.3	32.38
	9.0	7.9	176.1	37.05	166.2	35.88	156.2	35.26	151.2	33.74	146.2	32.28	136.3	31.04
	11.0	9.8	176.1	35.76	166.2	34.64	156.2	34.04	151.2	32.56	146.2	31.15	136.3	29.97
	13.0	11.8	176.1	34.40	166.2	33.31	156.2	32.73	151.2	31.32	146.2	29.96	136.3	28.81
15.0	13.7	176.1	32.96	166.2	31.91	156.2	31.36	151.2	30.00	146.2	28.71	136.3	27.60	
90	-24.8	-25	94.7	50.55	94.7	51.66	94.1	52.45	94.1	52.81	94.1	53.56	92.7	54.68
	-21.8	-22	115.2	51.66	115.2	52.78	114.6	53.56	114.6	53.93	114.6	54.68	112.6	52.29
	-19.8	-20	121.6	52.41	121.6	53.52	120.8	54.30	120.8	54.68	120.8	55.04	118.9	50.71
	-18.8	-19	124.8	52.78	124.1	53.90	123.6	54.68	123.6	53.84	123.6	52.23	121.7	49.92
	-16.7	-17	130.0	53.56	130.0	54.68	129.4	52.94	129.4	52.07	129.4	50.53	124.4	48.25
	-13.7	-15	139.1	54.68	139.1	52.08	137.9	50.45	137.9	49.56	134.0	48.08	124.4	45.87
	-11.8	-13	143.7	52.89	142.9	50.45	142.3	48.88	138.5	47.96	134.0	46.53	124.4	44.36
	-9.8	-11	148.4	51.03	148.4	48.73	143.0	47.23	138.5	46.28	134.0	44.91	124.4	42.77
	-9.5	-10	149.3	50.74	149.3	48.46	143.0	46.97	138.5	46.02	134.0	44.66	124.4	42.53
	-8.5	-9.1	152.4	49.82	151.3	47.60	143.0	46.14	138.5	45.18	134.0	43.84	124.4	41.74
	-7.0	-7.6	159.6	48.41	151.8	46.31	143.0	44.90	138.5	43.92	134.0	42.62	124.4	40.55
	-5.0	-5.6	161.3	46.54	151.8	44.58	143.0	43.25	138.5	42.25	134.0	40.99	124.4	38.97
	-3.0	-3.7	161.3	44.67	151.8	42.86	143.0	41.59	138.5	40.57	134.0	39.36	124.4	37.37
	0.0	-0.7	161.3	41.87	151.8	40.27	143.0	39.11	138.5	38.05	134.0	36.92	124.4	35.00
	3.0	2.2	161.3	39.05	151.8	37.68	143.0	36.62	138.5	35.54	134.0	34.48	124.4	32.61
	5.0	4.1	161.3	37.18	151.8	35.95	143.0	34.96	138.5	33.85	134.0	32.85	124.4	31.02
	7.0	6.0	161.3	35.31	151.8	34.24	143.0	33.31	138.5	32.18	134.0	31.22	124.4	29.44
	9.0	7.9	161.3	33.56	151.8	32.52	143.0	31.65	138.5	30.58	134.0	29.67	124.4	27.98
	11.0	9.8	161.3	31.80	151.8	30.83	143.0	29.99	138.5	28.97	134.0	28.11	124.4	26.50
	13.0	11.8	161.3	30.05	151.8	29.12	143.0	28.34	138.5	27.37	134.0	26.57	124.4	25.04
15.0	13.7	161.3	28.29	151.8	27.42	143.0	26.68	138.5	25.77	134.0	25.00	124.4	23.58	
80	-24.8	-25	94.3	44.35	94.3	45.47	93.7	46.25	93.7	46.62	93.7	48.48	92.3	46.39
	-21.8	-22	113.9	45.47	113.9	46.58	113.9	47.36	113.9	48.48	113.9	46.39	111.2	44.38
	-19.8	-20	120.3	46.21	120.3	47.32	120.3	48.48	120.3	47.00	119.3	44.99	111.2	43.04
	-18.8	-19	123.1	46.58	123.1	48.48	123.1	47.73	123.1	46.26	119.5	44.29	111.2	42.37
	-16.7	-17	127.8	48.48	127.8	46.92	127.8	46.16	124.0	44.71	119.5	42.83	111.2	40.97
	-13.7	-15	133.6	46.16	131.0	44.67	127.8	43.91	124.0	42.49	119.5	40.73	111.2	38.96
	-11.8	-13	137.0	44.67	132.9	43.25	127.8	42.47	124.0	41.08	119.5	39.40	111.2	37.68
	-9.8	-11	140.6	43.12	134.9	41.76	127.8	40.97	124.0	39.61	119.5	38.01	111.2	36.34
	-9.5	-10	141.6	42.89	135.6	41.53	127.8	40.74	124.0	39.38	119.5	37.79	111.2	36.14
	-8.5	-9.1	143.1	42.12	136.2	40.79	127.8	39.99	124.0	38.64	119.5	37.10	111.2	35.47
	-7.0	-7.6	144.5	40.95	136.2	39.66	127.8	38.86	124.0	37.53	119.5	36.06	111.2	34.46
	-5.0	-5.6	144.5	39.40	136.2	38.18	127.8	37.36	124.0	36.04	119.5	34.65	111.2	33.12
	-3.0	-3.7	144.5	37.85	136.2	36.68	127.8	35.86	124.0	34.57	119.5	33.26	111.2	31.78
	0.0	-0.7	144.5	35.51	136.2	34.44	127.8	33.61	124.0	32.35	119.5	31.15	111.2	29.78
	3.0	2.2	144.5	33.19	136.2	32.19	127.8	31.35	124.0	30.12	119.5	29.06	111.2	27.76
	5.0	4.1	144.5	31.63	136.2	30.71	127.8	29.84	124.0	28.65	119.5	27.66	111.2	26.43
	7.0	6.0	144.5	30.09	136.2	29.21	127.8	28.35	124.0	27.17	119.5	26.27	111.2	25.08
	9.0	7.9	144.5	28.24	136.2	27.43	127.8	26.61	124.0	25.51	119.5	24.67	111.2	23.55
	11.0	9.8	144.5	26.22	136.2	25.46	127.8	24.71	124.0	23.68	119.5	22.89	111.2	21.86
	13.0	11.8	144.5	24.48	136.2	23.76	127.8	23.06	124.0	22.10	119.5	21.37	111.2	20.40
15.0	13.7	144.5	23.03	136.2	22.36	127.8	21.70	124.0	20.80	119.5	20.12	111.2	19.21	

# 7. Capacity Tables

Heating Capacity (50HP)

Combination (%)	Outdoor air temp.		Indoor air temp. °C DB											
			16		18		20		21		22		24	
	°C DB	°C WB	TC	PI	TC	PI	TC	PI	TC	PI	TC	PI	TC	PI
70	-24.8	-25	94.3	44.96	94.3	45.33	93.7	46.08	93.7	47.20	93.7	44.94	92.2	42.81
	-21.8	-22	109.5	46.08	109.5	46.45	108.8	47.20	105.1	44.94	102.0	42.81	95.2	40.77
	-19.8	-20	119.7	46.83	115.7	47.20	108.8	45.61	105.1	43.43	102.0	41.41	95.2	39.42
	-18.8	-19	122.3	47.20	115.7	46.37	108.8	44.81	105.1	42.67	102.0	40.70	95.2	38.72
	-16.7	-17	122.5	45.48	115.7	44.64	108.8	43.15	105.1	41.09	102.0	39.22	95.2	37.30
	-13.7	-15	122.5	43.05	115.7	42.18	108.8	40.76	105.1	38.82	102.0	37.11	95.2	35.25
	-11.8	-13	122.5	41.49	115.7	40.61	108.8	39.24	105.1	37.38	102.0	35.76	95.2	33.96
	-9.8	-11	122.5	39.87	115.7	38.97	108.8	37.66	105.1	35.87	102.0	34.35	95.2	32.60
	-9.5	-10	122.5	39.62	115.7	38.72	108.8	37.42	105.1	35.65	102.0	34.14	95.2	32.40
	-8.5	-9.1	122.5	38.81	115.7	37.90	108.8	36.62	105.1	34.89	102.0	33.44	95.2	31.71
	-7.0	-7.6	122.5	37.59	115.7	36.67	108.8	35.43	105.1	33.76	102.0	32.38	95.2	30.69
	-5.0	-5.6	122.5	35.96	115.7	35.02	108.8	33.84	105.1	32.25	102.0	30.96	95.2	29.33
	-3.0	-3.7	122.5	34.34	115.7	33.37	108.8	32.25	105.1	30.74	102.0	29.55	95.2	27.96
	0.0	-0.7	122.5	31.89	115.7	30.91	108.8	29.87	105.1	28.48	102.0	27.44	95.2	25.92
	3.0	2.2	122.5	29.45	115.7	28.43	108.8	27.47	105.1	26.22	102.0	25.32	95.2	23.87
	5.0	4.1	122.5	27.82	115.7	26.78	108.8	25.89	105.1	24.71	102.0	23.90	95.2	22.52
	7.0	6.0	122.5	26.19	115.7	25.14	108.8	24.30	105.1	23.20	102.0	22.50	95.2	21.15
	9.0	7.9	122.5	23.65	115.7	22.70	108.8	21.95	105.1	20.95	102.0	20.32	95.2	19.10
11.0	9.8	122.5	22.03	115.7	21.14	108.8	20.43	105.1	19.50	102.0	18.92	95.2	17.78	
13.0	11.8	122.5	20.61	115.7	19.78	108.8	19.11	105.1	18.25	102.0	17.70	95.2	16.65	
15.0	13.7	122.5	19.42	115.7	18.65	108.8	18.02	105.1	17.20	102.0	16.69	95.2	15.69	
60	-24.8	-25	93.5	44.21	93.5	44.96	92.9	46.08	90.2	43.69	87.1	41.45	81.5	39.34
	-21.8	-22	100.4	45.33	99.5	46.08	93.3	43.69	90.2	41.45	87.1	39.34	81.5	37.31
	-19.8	-20	105.1	46.08	99.5	44.39	93.3	42.10	90.2	39.96	87.1	37.94	81.5	35.96
	-18.8	-19	105.1	45.24	99.5	43.55	93.3	41.29	90.2	39.20	87.1	37.24	81.5	35.27
	-16.7	-17	105.1	43.44	99.5	41.77	93.3	39.63	90.2	37.64	87.1	35.77	81.5	33.85
	-13.7	-15	105.1	40.87	99.5	39.24	93.3	37.24	90.2	35.40	87.1	33.66	81.5	31.82
	-11.8	-13	105.1	39.26	99.5	37.64	93.3	35.72	90.2	33.98	87.1	32.33	81.5	30.54
	-9.8	-11	105.1	37.56	99.5	35.95	93.3	34.13	90.2	32.49	87.1	30.92	81.5	29.17
	-9.5	-10	105.1	37.30	99.5	35.70	93.3	33.89	90.2	32.26	87.1	30.71	81.5	28.97
	-8.5	-9.1	105.1	36.45	99.5	34.86	93.3	33.10	90.2	31.52	87.1	30.00	81.5	28.30
	-7.0	-7.6	105.1	35.18	99.5	33.59	93.3	31.90	90.2	30.39	87.1	28.95	81.5	27.28
	-5.0	-5.6	105.1	33.46	99.5	31.90	93.3	30.31	90.2	28.90	87.1	27.56	81.5	25.92
	-3.0	-3.7	105.1	31.76	99.5	30.21	93.3	28.71	90.2	27.41	87.1	26.15	81.5	24.56
	0.0	-0.7	105.1	29.20	99.5	27.67	93.3	26.33	90.2	25.16	87.1	24.04	81.5	22.53
	3.0	2.2	105.1	26.64	99.5	25.14	93.3	23.93	90.2	22.93	87.1	21.94	81.5	20.49
	5.0	4.1	105.1	24.94	99.5	23.45	93.3	22.35	90.2	21.44	87.1	20.53	81.5	19.15
	7.0	6.0	105.1	23.24	99.5	21.76	93.3	20.75	90.2	19.94	87.1	19.14	81.5	17.78
	9.0	7.9	105.1	20.74	99.5	19.42	93.3	18.51	90.2	17.79	87.1	17.06	81.5	15.86
11.0	9.8	105.1	19.36	99.5	18.13	93.3	17.29	90.2	16.61	87.1	15.94	81.5	14.82	
13.0	11.8	105.1	18.13	99.5	16.98	93.3	16.20	90.2	15.56	87.1	14.93	81.5	13.89	
15.0	13.7	105.1	17.14	99.5	16.06	93.3	15.30	90.2	14.71	87.1	14.11	81.5	13.13	
50	-24.8	-25	87.7	39.13	82.7	40.25	77.7	38.11	75.2	36.10	72.7	34.22	67.7	32.46
	-21.8	-22	87.7	40.25	82.7	38.11	77.7	36.10	75.2	34.22	72.7	32.46	67.7	30.77
	-19.8	-20	87.7	38.76	82.7	36.68	77.7	34.78	75.2	32.95	72.7	31.28	67.7	29.63
	-18.8	-19	87.7	38.01	82.7	35.96	77.7	34.11	75.2	32.33	72.7	30.69	67.7	29.07
	-16.7	-17	87.7	36.44	82.7	34.47	77.7	32.71	75.2	31.00	72.7	29.46	67.7	27.89
	-13.7	-15	87.7	34.21	82.7	32.32	77.7	30.71	75.2	29.11	72.7	27.70	67.7	26.20
	-11.8	-13	87.7	32.79	82.7	30.97	77.7	29.44	75.2	27.91	72.7	26.59	67.7	25.12
	-9.8	-11	87.7	31.29	82.7	29.54	77.7	28.10	75.2	26.65	72.7	25.41	67.7	23.99
	-9.5	-10	87.7	31.07	82.7	29.33	77.7	27.91	75.2	26.46	72.7	25.25	67.7	23.82
	-8.5	-9.1	87.7	30.31	82.7	28.61	77.7	27.24	75.2	25.83	72.7	24.66	67.7	23.26
	-7.0	-7.6	87.7	29.20	82.7	27.55	77.7	26.24	75.2	24.89	72.7	23.78	67.7	22.42
	-5.0	-5.6	87.7	27.70	82.7	26.12	77.7	24.91	75.2	23.62	72.7	22.60	67.7	21.29
	-3.0	-3.7	87.7	26.20	82.7	24.69	77.7	23.56	75.2	22.36	72.7	21.42	67.7	20.16
	0.0	-0.7	87.7	23.97	82.7	22.54	77.7	21.57	75.2	20.47	72.7	19.66	67.7	18.46
	3.0	2.2	87.7	21.74	82.7	20.41	77.7	19.57	75.2	18.57	72.7	17.91	67.7	16.77
	5.0	4.1	87.7	20.24	82.7	18.98	77.7	18.23	75.2	17.32	72.7	16.73	67.7	15.65
	7.0	6.0	87.7	18.74	82.7	17.55	77.7	16.91	75.2	16.06	72.7	15.55	67.7	14.52
	9.0	7.9	87.7	16.92	82.7	15.85	77.7	15.26	75.2	14.50	72.7	14.05	67.7	13.10
11.0	9.8	87.7	15.84	82.7	14.83	77.7	14.28	75.2	13.58	72.7	13.14	67.7	12.26	
13.0	11.8	87.7	14.87	82.7	13.93	77.7	13.40	75.2	12.74	72.7	12.34	67.7	11.52	
15.0	13.7	87.7	14.07	82.7	13.17	77.7	12.69	75.2	12.06	72.7	11.68	67.7	10.90	

**Note**

1. TC: Total Capacity(kW), PI : Power Input(kW, Comp. + Outdoor fan motor)
2. Capacity tables show the average value of conditions which may occur.
3. The heating capacity table is based on the values expressed as Max. in the specification of the outdoor unit. (When measuring the Max. heating capacity, the setting status of the indoor unit is the same as that for measuring the heating capacity of the indoor unit.)

# 7. Capacity Tables

## ◆ ARUM520LTE5

Heating Capacity (52HP)

Combination (%)	Outdoor air temp.		Indoor air temp. °C DB											
			16		18		20		21		22		24	
	°C DB	°C WB	TC	PI	TC	PI	TC	PI	TC	PI	TC	PI	TC	PI
130	-24.8	-25	98.0	52.0	98.0	52.65	97.4	53.26	97.4	54.18	97.4	55.07	96.5	56.48
	-21.8	-22	119.6	53.35	119.6	54.04	118.8	54.65	118.8	55.58	118.8	56.48	117.6	57.86
	-19.8	-20	126.3	54.27	126.3	54.98	125.5	55.58	125.5	56.51	125.5	57.39	124.3	58.79
	-18.8	-19	129.4	54.75	129.4	55.44	128.6	56.05	128.6	56.98	128.6	57.86	127.3	59.26
	-16.7	-17	135.7	55.72	135.7	56.42	134.9	57.03	134.9	57.95	134.9	58.84	133.5	60.23
	-13.7	-15	144.7	57.12	144.7	57.82	143.8	58.43	143.8	59.35	143.8	60.23	142.3	57.95
	-11.8	-13	149.5	58.01	149.5	58.70	148.6	59.31	148.6	60.23	148.6	58.71	147.6	56.51
	-9.8	-11	154.6	58.93	154.6	59.63	153.6	60.23	153.6	58.61	153.6	57.09	152.9	54.99
	-9.5	-10	155.7	59.08	155.7	59.77	154.8	59.99	154.8	58.35	154.3	56.85	153.7	54.75
	-8.5	-9.1	159.9	59.54	159.9	60.23	159.0	59.15	159.0	57.53	156.9	56.03	156.4	53.98
	-7.0	-7.6	166.3	60.23	166.3	59.01	165.1	57.90	165.1	56.30	165.1	54.81	162.2	52.85
	-5.0	-5.6	174.7	58.66	174.7	57.37	173.5	56.21	173.5	54.66	173.5	53.20	168.0	51.32
	-3.0	-3.7	183.1	57.07	183.1	55.74	181.9	54.54	181.9	53.01	181.9	51.58	173.9	49.79
	0.0	-0.7	195.6	54.68	195.6	53.28	194.3	52.03	193.2	50.55	191.0	49.15	182.6	47.51
	3.0	2.2	202.7	52.30	202.7	50.81	201.6	49.51	200.0	48.10	196.3	46.71	183.5	45.23
	5.0	4.1	206.7	50.71	206.7	49.18	205.8	47.83	203.0	46.45	197.0	45.09	183.5	43.69
	7.0	6.0	209.5	49.12	209.5	47.53	208.5	46.16	204.2	44.81	197.0	43.48	183.5	42.18
	9.0	7.9	210.0	47.81	210.0	46.27	209.3	44.92	204.2	43.62	197.0	42.33	183.5	41.06
11.0	9.8	210.0	46.92	210.0	45.40	209.3	44.09	204.2	42.80	197.0	41.53	183.5	40.28	
13.0	11.8	210.0	45.96	210.0	44.47	209.3	43.18	204.2	41.93	197.0	40.68	183.5	39.46	
15.0	13.7	210.0	44.93	210.0	43.48	209.3	42.21	204.2	40.98	197.0	39.76	183.5	38.57	
120	-24.8	-25	97.4	52.65	97.4	53.26	96.7	54.18	96.7	55.07	96.7	56.48	95.8	57.45
	-21.8	-22	118.8	54.04	118.8	54.65	118.0	55.58	118.0	56.48	118.0	57.86	116.9	58.84
	-19.8	-20	125.5	54.98	125.5	55.58	124.6	56.51	124.6	57.39	124.6	58.79	123.4	59.77
	-18.8	-19	128.4	55.44	128.4	56.05	127.6	56.98	127.6	57.86	127.6	59.26	126.4	60.23
	-16.7	-17	134.7	56.42	134.7	57.03	133.9	57.95	133.9	58.84	133.9	60.23	132.5	58.77
	-13.7	-15	143.6	57.82	143.6	58.43	142.7	59.35	142.7	60.23	142.7	58.04	141.3	56.67
	-11.8	-13	148.4	58.70	148.4	59.31	147.5	60.23	147.5	58.68	147.5	56.65	146.5	55.34
	-9.8	-11	153.4	59.63	153.4	60.23	152.5	58.53	152.5	57.05	152.5	55.20	151.8	53.94
	-9.5	-10	154.7	59.77	154.7	59.96	153.8	58.28	153.8	56.81	153.8	54.98	153.1	53.72
	-8.5	-9.1	158.9	60.23	158.9	59.06	157.8	57.42	157.8	55.99	157.3	54.26	156.5	53.02
	-7.0	-7.6	165.1	58.89	165.1	57.71	164.1	56.14	164.1	54.77	162.0	53.15	161.0	51.97
	-5.0	-5.6	173.5	57.10	173.5	55.90	172.3	54.44	172.3	53.13	172.3	51.69	166.9	50.57
	-3.0	-3.7	181.7	55.30	181.7	54.11	180.6	52.72	180.6	51.51	179.7	50.23	171.7	49.16
	0.0	-0.7	194.2	52.61	193.7	51.40	190.3	50.16	188.3	49.05	185.2	48.04	172.3	47.06
	3.0	2.2	201.2	49.92	200.5	48.69	196.3	47.60	191.4	46.60	185.4	45.85	172.3	44.97
	5.0	4.1	205.2	48.12	204.0	46.88	198.0	45.89	191.4	44.97	185.4	44.39	172.3	43.57
	7.0	6.0	208.0	46.33	206.2	45.08	198.0	44.19	191.4	43.33	185.4	42.93	172.3	42.16
	9.0	7.9	208.4	44.97	206.2	43.76	198.0	42.90	191.4	42.09	185.4	41.69	172.3	40.93
11.0	9.8	208.4	44.03	206.2	42.83	198.0	41.98	191.4	41.19	185.4	40.79	172.3	40.07	
13.0	11.8	208.4	43.00	206.2	41.83	198.0	41.01	191.4	40.23	185.4	39.85	172.3	39.14	
15.0	13.7	208.4	41.90	206.2	40.77	198.0	39.97	191.4	39.20	185.4	38.83	172.3	38.14	
110	-24.8	-25	96.8	53.26	96.8	54.18	96.3	55.07	96.3	56.48	96.3	57.45	95.3	57.92
	-21.8	-22	118.2	54.65	118.2	55.58	117.4	56.48	117.4	57.86	117.4	58.84	116.3	59.31
	-19.8	-20	124.8	55.58	124.8	56.51	124.0	57.39	124.0	58.79	124.0	59.77	122.7	60.23
	-18.8	-19	127.7	56.05	127.7	56.98	126.9	57.86	126.9	59.26	126.9	60.23	125.7	59.46
	-16.7	-17	134.0	57.03	134.0	57.95	133.2	58.84	133.2	60.23	133.2	58.65	131.8	57.82
	-13.7	-15	142.9	58.43	142.9	59.35	141.9	60.23	141.9	57.83	141.9	56.37	141.9	55.50
	-11.8	-13	147.6	59.31	147.6	60.23	146.7	58.54	146.7	56.30	146.7	54.92	146.7	54.02
	-9.8	-11	152.6	60.23	152.6	58.32	151.7	56.76	151.7	54.70	151.7	53.41	151.4	52.47
	-9.5	-10	153.8	59.92	153.8	58.02	153.0	56.47	153.0	54.45	153.0	53.19	152.7	52.23
	-8.5	-9.1	158.0	58.90	158.0	57.07	157.0	55.58	157.0	53.65	156.7	52.42	154.5	51.45
	-7.0	-7.6	164.2	57.33	164.2	55.63	163.2	54.24	163.2	52.44	161.7	51.29	155.1	50.29
	-5.0	-5.6	172.5	55.26	172.5	53.70	171.3	52.45	170.3	50.84	165.1	49.77	155.1	48.73
	-3.0	-3.7	180.7	53.19	180.7	51.78	176.5	50.65	171.9	49.22	166.0	48.25	155.1	47.18
	0.0	-0.7	191.2	50.07	187.4	48.90	177.6	47.97	171.9	46.81	166.0	45.98	155.1	44.85
	3.0	2.2	197.5	46.97	189.3	46.01	177.6	45.28	171.9	44.41	166.0	43.69	155.1	42.52
	5.0	4.1	200.3	44.89	189.3	44.10	177.6	43.50	171.9	42.80	166.0	42.18	155.1	40.96
	7.0	6.0	200.3	42.81	189.3	42.17	177.6	41.70	171.9	41.19	166.0	40.66	155.1	39.41
	9.0	7.9	200.3	41.38	189.3	40.77	177.6	40.31	171.9	39.82	166.0	39.31	155.1	38.09
11.0	9.8	200.3	40.31	189.3	39.71	177.6	39.26	171.9	38.78	166.0	38.28	155.1	37.10	
13.0	11.8	200.3	39.15	189.3	38.58	177.6	38.14	171.9	37.68	166.0	37.19	155.1	36.05	
15.0	13.7	200.3	37.94	189.3	37.37	177.6	36.94	171.9	36.50	166.0	36.04	155.1	34.92	

# 7. Capacity Tables

Heating Capacity (52HP)

Combination (%)	Outdoor air temp.		Indoor air temp. °C DB											
			16		18		20		21		22		24	
	°C DB	°C WB	TC	PI	TC	PI	TC	PI	TC	PI	TC	PI	TC	PI
100	-24.8	-25	96.4	59.21	96.4	59.34	95.8	56.48	95.8	59.68	95.8	59.83	94.8	59.90
	-21.8	-22	117.5	59.41	117.5	59.55	116.9	58.27	116.9	59.89	116.9	60.87	115.6	60.11
	-19.8	-20	124.2	59.55	124.2	59.68	123.5	59.42	123.5	60.03	123.5	60.45	122.3	60.23
	-18.8	-19	127.2	59.62	126.4	59.76	126.4	59.89	126.4	60.09	126.4	60.23	125.1	59.29
	-16.7	-17	132.6	59.77	132.6	59.91	132.6	60.87	131.9	60.23	131.9	58.28	130.5	57.29
	-13.7	-15	142.2	59.97	142.2	60.10	141.3	60.23	141.3	57.40	141.3	55.47	140.0	54.43
	-11.8	-13	146.9	60.11	146.1	60.23	146.1	58.33	146.1	55.59	146.1	53.69	141.5	52.62
	-9.8	-11	151.7	60.23	151.7	58.10	151.1	56.32	151.1	53.69	150.1	51.83	141.7	50.72
	-9.5	-10	153.0	59.90	153.0	57.78	152.3	56.02	152.3	53.40	150.7	51.54	141.7	50.44
	-8.5	-9.1	157.1	58.78	157.1	56.71	156.4	55.02	157.3	52.45	152.1	50.61	141.7	49.48
	-7.0	-7.6	166.0	57.11	165.4	55.11	162.5	53.50	157.3	51.04	152.1	49.20	141.7	48.05
	-5.0	-5.6	173.3	54.87	171.5	52.98	162.5	51.50	157.3	49.13	152.1	47.33	141.7	46.15
	-3.0	-3.7	178.3	52.64	172.9	50.84	162.5	49.50	157.3	47.23	152.1	45.47	141.7	44.24
	0.0	-0.7	183.3	49.28	172.9	47.63	162.5	46.48	157.3	44.39	152.1	42.66	141.7	41.39
	3.0	2.2	183.3	45.92	172.9	44.42	162.5	43.47	157.3	41.54	152.1	39.85	141.7	38.54
	5.0	4.1	183.3	43.69	172.9	42.29	162.5	41.46	157.3	39.64	152.1	37.98	141.7	36.63
	7.0	6.0	183.3	41.45	172.9	40.15	162.5	39.45	157.3	37.74	152.1	36.11	141.7	34.73
	9.0	7.9	183.3	39.77	172.9	38.52	162.5	37.85	157.3	36.22	152.1	34.66	141.7	33.32
	11.0	9.8	183.3	38.42	172.9	37.22	162.5	36.58	157.3	34.99	152.1	33.48	141.7	32.20
	13.0	11.8	183.3	37.00	172.9	35.83	162.5	35.21	157.3	33.69	152.1	32.23	141.7	30.99
15.0	13.7	183.3	35.50	172.9	34.37	162.5	33.78	157.3	32.31	152.1	30.92	141.7	29.73	
90	-24.8	-25	96.0	52.54	96.0	53.93	95.4	54.92	95.4	55.37	95.4	56.31	94.5	57.71
	-21.8	-22	117.1	53.93	117.1	55.33	116.5	56.31	116.5	56.77	116.5	57.71	115.2	55.24
	-19.8	-20	123.8	54.87	123.8	56.26	122.9	57.23	122.9	57.71	122.9	56.02	121.7	53.60
	-18.8	-19	127.2	55.33	126.4	56.73	125.9	57.71	125.9	56.84	125.9	55.18	124.7	52.78
	-16.7	-17	132.6	56.31	132.6	57.71	132.0	55.92	132.0	55.02	132.0	53.42	128.5	51.05
	-13.7	-15	142.2	57.71	142.2	55.04	140.9	53.36	140.9	52.43	138.3	50.89	129.5	48.58
	-11.8	-13	146.9	55.88	146.1	53.36	145.5	51.74	142.9	50.78	139.4	49.30	129.5	47.02
	-9.8	-11	151.7	53.97	151.7	51.60	147.6	50.04	144.1	49.04	139.4	47.62	129.5	45.38
	-9.5	-10	153.0	53.68	153.0	51.32	148.2	49.78	144.1	48.78	139.4	47.36	129.5	45.13
	-8.5	-9.1	157.1	52.73	156.0	50.44	148.7	48.92	144.1	47.92	139.4	46.52	129.5	44.31
	-7.0	-7.6	166.0	51.29	157.9	49.11	148.7	47.65	144.1	46.62	139.4	45.26	129.5	43.08
	-5.0	-5.6	167.8	49.37	157.9	47.34	148.7	45.95	144.1	44.90	139.4	43.58	129.5	41.44
	-3.0	-3.7	167.8	47.46	157.9	45.58	148.7	44.25	144.1	43.16	139.4	41.89	129.5	39.79
	0.0	-0.7	167.8	44.59	157.9	42.91	148.7	41.69	144.1	40.57	139.4	39.37	129.5	37.33
	3.0	2.2	167.8	41.71	157.9	40.25	148.7	39.14	144.1	37.98	139.4	36.85	129.5	34.86
	5.0	4.1	167.8	39.79	157.9	38.48	148.7	37.43	144.1	36.24	139.4	35.16	129.5	33.21
	7.0	6.0	167.8	37.88	157.9	36.72	148.7	35.73	144.1	34.52	139.4	33.49	129.5	31.58
	9.0	7.9	167.8	36.07	157.9	34.96	148.7	34.02	144.1	32.87	139.4	31.89	129.5	30.07
	11.0	9.8	167.8	34.27	157.9	33.22	148.7	32.32	144.1	31.22	139.4	30.29	129.5	28.56
	13.0	11.8	167.8	32.46	157.9	31.46	148.7	30.62	144.1	29.57	139.4	28.70	129.5	27.05
15.0	13.7	167.8	30.66	157.9	29.71	148.7	28.91	144.1	27.92	139.4	27.09	129.5	25.55	
80	-24.8	-25	95.6	46.00	95.6	47.40	95.0	48.38	95.0	48.84	95.0	51.17	94.1	49.00
	-21.8	-22	115.8	47.40	115.8	48.79	115.8	49.77	115.8	51.17	115.8	49.00	113.9	46.91
	-19.8	-20	122.5	48.33	122.5	49.72	122.5	51.17	122.5	49.64	121.8	47.55	115.7	45.53
	-18.8	-19	125.4	48.79	125.4	51.17	125.4	50.39	125.4	48.87	122.9	46.82	115.7	44.83
	-16.7	-17	130.9	51.17	130.9	49.55	130.9	48.77	128.2	47.27	124.4	45.32	115.7	43.38
	-13.7	-15	139.0	48.78	136.3	47.24	133.0	46.45	129.0	44.97	124.4	43.14	115.7	41.29
	-11.8	-13	142.5	47.26	138.3	45.78	133.0	44.97	129.0	43.52	124.4	41.77	115.7	39.97
	-9.8	-11	145.9	45.66	140.1	44.25	133.0	43.42	129.0	42.00	124.4	40.32	115.7	38.58
	-9.5	-10	146.9	45.43	140.9	44.01	133.0	43.18	129.0	41.76	124.4	40.10	115.7	38.37
	-8.5	-9.1	148.6	44.63	141.7	43.25	133.0	42.41	129.0	41.00	124.4	39.38	115.7	37.68
	-7.0	-7.6	150.3	43.43	141.7	42.09	133.0	41.25	129.0	39.85	124.4	38.31	115.7	36.63
	-5.0	-5.6	150.3	41.84	141.7	40.56	133.0	39.70	129.0	38.31	124.4	36.85	115.7	35.24
	-3.0	-3.7	150.3	40.24	141.7	39.02	133.0	38.15	129.0	36.79	124.4	35.41	115.7	33.85
	0.0	-0.7	150.3	37.84	141.7	36.72	133.0	35.83	129.0	34.50	124.4	33.23	115.7	31.77
	3.0	2.2	150.3	35.45	141.7	34.40	133.0	33.50	129.0	32.19	124.4	31.07	115.7	29.68
	5.0	4.1	150.3	33.86	141.7	32.87	133.0	31.95	129.0	30.67	124.4	29.62	115.7	28.30
	7.0	6.0	150.3	32.27	141.7	31.33	133.0	30.41	129.0	29.14	124.4	28.18	115.7	26.90
	9.0	7.9	150.3	30.29	141.7	29.42	133.0	28.55	129.0	27.36	124.4	26.46	115.7	25.26
	11.0	9.8	150.3	28.12	141.7	27.30	133.0	26.50	129.0	25.39	124.4	24.55	115.7	23.44
	13.0	11.8	150.3	26.25	141.7	25.48	133.0	24.74	129.0	23.70	124.4	22.92	115.7	21.88
15.0	13.7	150.3	24.70	141.7	23.98	133.0	23.27	129.0	22.31	124.4	21.58	115.7	20.60	



# 7. Capacity Tables

Heating Capacity (52HP)

Combination (%)	Outdoor air temp.		Indoor air temp. °C DB											
			16		18		20		21		22		24	
	°C DB	°C WB	TC	PI	TC	PI	TC	PI	TC	PI	TC	PI	TC	PI
70	-24.8	-25	95.6	46.83	95.6	47.29	95.0	48.23	95.0	49.63	95.0	47.29	94.0	45.10
	-21.8	-22	112.7	48.23	113.0	48.69	112.2	49.63	109.3	47.29	106.1	45.10	99.0	42.99
	-19.8	-20	122.1	49.16	119.2	49.63	113.2	47.99	109.3	45.74	106.1	43.65	99.0	41.59
	-18.8	-19	124.8	49.63	120.1	48.78	113.2	47.17	109.3	44.95	106.1	42.92	99.0	40.87
	-16.7	-17	127.1	47.87	120.3	47.00	113.2	45.46	109.3	43.32	106.1	41.39	99.0	39.40
	-13.7	-15	127.4	45.37	120.3	44.47	113.2	43.00	109.3	40.99	106.1	39.21	99.0	37.28
	-11.8	-13	127.4	43.77	120.3	42.86	113.2	41.44	109.3	39.50	106.1	37.82	99.0	35.94
	-9.8	-11	127.4	42.11	120.3	41.17	113.2	39.81	109.3	37.94	106.1	36.36	99.0	34.53
	-9.5	-10	127.4	41.86	120.3	40.91	113.2	39.57	109.3	37.72	106.1	36.15	99.0	34.32
	-8.5	-9.1	127.4	41.03	120.3	40.07	113.2	38.74	109.3	36.94	106.1	35.42	99.0	33.61
	-7.0	-7.6	127.4	39.77	120.3	38.81	113.2	37.52	109.3	35.77	106.1	34.33	99.0	32.56
	-5.0	-5.6	127.4	38.10	120.3	37.12	113.2	35.88	109.3	34.22	106.1	32.87	99.0	31.15
	-3.0	-3.7	127.4	36.44	120.3	35.42	113.2	34.24	109.3	32.66	106.1	31.41	99.0	29.73
	0.0	-0.7	127.4	33.94	120.3	32.89	113.2	31.79	109.3	30.32	106.1	29.23	99.0	27.62
	3.0	2.2	127.4	31.43	120.3	30.35	113.2	29.33	109.3	28.00	106.1	27.04	99.0	25.50
	5.0	4.1	127.4	29.76	120.3	28.65	113.2	27.70	109.3	26.44	106.1	25.58	99.0	24.10
	7.0	6.0	127.4	28.09	120.3	26.97	113.2	26.07	109.3	24.88	106.1	24.13	99.0	22.69
	9.0	7.9	127.4	25.37	120.3	24.35	113.2	23.54	109.3	22.47	106.1	21.79	99.0	20.48
11.0	9.8	127.4	23.63	120.3	22.67	113.2	21.91	109.3	20.92	106.1	20.29	99.0	19.07	
13.0	11.8	127.4	22.10	120.3	21.21	113.2	20.50	109.3	19.58	106.1	18.98	99.0	17.86	
15.0	13.7	127.4	20.83	120.3	20.00	113.2	19.33	109.3	18.45	106.1	17.90	99.0	16.82	
60	-24.8	-25	95.0	45.89	95.0	46.83	94.4	48.23	92.5	45.78	90.3	43.48	84.8	41.31
	-21.8	-22	103.5	47.29	103.5	48.23	97.1	45.78	93.8	43.48	90.6	41.31	84.8	39.22
	-19.8	-20	109.3	48.23	103.5	46.50	97.1	44.14	93.8	41.95	90.6	39.86	84.8	37.82
	-18.8	-19	109.3	47.36	103.5	45.63	97.1	43.32	93.8	41.17	90.6	39.14	84.8	37.11
	-16.7	-17	109.3	45.53	103.5	43.81	97.1	41.61	93.8	39.56	90.6	37.63	84.8	35.64
	-13.7	-15	109.3	42.91	103.5	41.23	97.1	39.16	93.8	37.26	90.6	35.47	84.8	33.55
	-11.8	-13	109.3	41.27	103.5	39.58	97.1	37.60	93.8	35.80	90.6	34.10	84.8	32.23
	-9.8	-11	109.3	39.53	103.5	37.86	97.1	35.97	93.8	34.27	90.6	32.65	84.8	30.82
	-9.5	-10	109.3	39.26	103.5	37.61	97.1	35.73	93.8	34.04	90.6	32.43	84.8	30.61
	-8.5	-9.1	109.3	38.40	103.5	36.74	97.1	34.91	93.8	33.28	90.6	31.70	84.8	29.92
	-7.0	-7.6	109.3	37.10	103.5	35.44	97.1	33.69	93.8	32.12	90.6	30.62	84.8	28.87
	-5.0	-5.6	109.3	35.36	103.5	33.71	97.1	32.05	93.8	30.59	90.6	29.18	84.8	27.47
	-3.0	-3.7	109.3	33.62	103.5	31.98	97.1	30.42	93.8	29.06	90.6	27.74	84.8	26.07
	0.0	-0.7	109.3	31.01	103.5	29.39	97.1	27.98	93.8	26.75	90.6	25.57	84.8	23.97
	3.0	2.2	109.3	28.40	103.5	26.80	97.1	25.52	93.8	24.46	90.6	23.41	84.8	21.87
	5.0	4.1	109.3	26.66	103.5	25.07	97.1	23.90	93.8	22.93	90.6	21.96	84.8	20.48
	7.0	6.0	109.3	24.93	103.5	23.34	97.1	22.26	93.8	21.39	90.6	20.52	84.8	19.07
	9.0	7.9	109.3	22.24	103.5	20.83	97.1	19.86	93.8	19.08	90.6	18.30	84.8	17.02
11.0	9.8	109.3	20.76	103.5	19.45	97.1	18.54	93.8	17.82	90.6	17.10	84.8	15.89	
13.0	11.8	109.3	19.45	103.5	18.21	97.1	17.38	93.8	16.69	90.6	16.01	84.8	14.90	
15.0	13.7	109.3	18.38	103.5	17.23	97.1	16.42	93.8	15.77	90.6	15.13	84.8	14.08	
50	-24.8	-25	91.2	41.08	86.0	42.48	80.9	40.25	78.3	38.16	75.7	36.18	70.5	34.35
	-21.8	-22	91.2	42.48	86.0	40.25	80.9	38.16	78.3	36.18	75.7	34.35	70.5	32.58
	-19.8	-20	91.2	40.92	86.0	38.76	80.9	36.77	78.3	34.86	75.7	33.12	70.5	31.39
	-18.8	-19	91.2	40.15	86.0	38.01	80.9	36.08	78.3	34.21	75.7	32.50	70.5	30.80
	-16.7	-17	91.2	38.52	86.0	36.46	80.9	34.62	78.3	32.83	75.7	31.22	70.5	29.56
	-13.7	-15	91.2	36.19	86.0	34.22	80.9	32.53	78.3	30.85	75.7	29.38	70.5	27.79
	-11.8	-13	91.2	34.72	86.0	32.81	80.9	31.20	78.3	29.60	75.7	28.22	70.5	26.67
	-9.8	-11	91.2	33.16	86.0	31.32	80.9	29.81	78.3	28.28	75.7	26.99	70.5	25.48
	-9.5	-10	91.2	32.93	86.0	31.10	80.9	29.61	78.3	28.09	75.7	26.81	70.5	25.31
	-8.5	-9.1	91.2	32.14	86.0	30.35	80.9	28.91	78.3	27.43	75.7	26.20	70.5	24.72
	-7.0	-7.6	91.2	30.98	86.0	29.25	80.9	27.87	78.3	26.45	75.7	25.28	70.5	23.84
	-5.0	-5.6	91.2	29.42	86.0	27.76	80.9	26.48	78.3	25.12	75.7	24.04	70.5	22.66
	-3.0	-3.7	91.2	27.87	86.0	26.27	80.9	25.08	78.3	23.81	75.7	22.81	70.5	21.48
	0.0	-0.7	91.2	25.54	86.0	24.02	80.9	23.00	78.3	21.83	75.7	20.98	70.5	19.70
	3.0	2.2	91.2	23.22	86.0	21.80	80.9	20.91	78.3	19.85	75.7	19.14	70.5	17.93
	5.0	4.1	91.2	21.66	86.0	20.31	80.9	19.52	78.3	18.54	75.7	17.91	70.5	16.76
	7.0	6.0	91.2	20.10	86.0	18.82	80.9	18.13	78.3	17.23	75.7	16.68	70.5	15.57
	9.0	7.9	91.2	18.15	86.0	17.00	80.9	16.37	78.3	15.55	75.7	15.07	70.5	14.06
11.0	9.8	91.2	16.98	86.0	15.91	80.9	15.32	78.3	14.56	75.7	14.10	70.5	13.15	
13.0	11.8	91.2	15.95	86.0	14.94	80.9	14.38	78.3	13.66	75.7	13.24	70.5	12.36	
15.0	13.7	91.2	15.09	86.0	14.13	80.9	13.61	78.3	12.93	75.7	12.52	70.5	11.69	

**Note**

1. TC: Total Capacity(kW), PI : Power Input(kW, Comp. + Outdoor fan motor)
2. Capacity tables show the average value of conditions which may occur.
3. The heating capacity table is based on the values expressed as Max. in the specification of the outdoor unit. (When measuring the Max. heating capacity, the setting status of the indoor unit is the same as that for measuring the heating capacity of the indoor unit.)

# 7. Capacity Tables

## ◆ ARUM540LTE5

Heating Capacity (54HP)

Combination (%)	Outdoor air temp.		Indoor air temp. °C DB											
			16		18		20		21		22		24	
	°C DB	°C WB	TC	PI	TC	PI	TC	PI	TC	PI	TC	PI	TC	PI
130	-24.8	-25	106.6	54.8	106.6	55.30	105.9	55.77	105.9	56.47	105.9	57.17	104.3	58.25
	-21.8	-22	128.6	55.84	128.6	56.37	127.7	56.84	127.7	57.55	127.7	58.25	125.7	59.31
	-19.8	-20	135.1	56.55	135.1	57.09	134.2	57.55	134.2	58.28	134.2	58.95	132.1	60.03
	-18.8	-19	138.1	56.91	138.1	57.45	137.2	57.92	137.2	58.63	137.2	59.31	135.0	60.39
	-16.7	-17	144.3	57.67	144.3	58.20	143.3	58.67	143.3	59.38	143.3	60.07	141.0	61.14
	-13.7	-15	153.1	58.74	153.1	59.28	152.1	59.75	152.1	60.46	152.1	61.14	149.7	58.68
	-11.8	-13	158.0	59.43	158.0	59.95	157.1	60.42	157.1	61.14	157.1	59.48	155.1	57.12
	-9.8	-11	163.3	60.13	163.3	60.68	162.3	61.14	162.3	59.36	162.3	57.73	160.6	55.49
	-9.5	-10	164.2	60.26	164.2	60.78	163.3	60.87	163.3	59.08	163.0	57.47	161.5	55.23
	-8.5	-9.1	167.6	60.60	167.6	61.14	166.7	59.94	166.7	58.19	165.7	56.59	164.2	54.41
	-7.0	-7.6	172.7	61.14	172.7	59.77	171.6	58.56	171.6	56.84	171.6	55.26	169.0	53.18
	-5.0	-5.6	179.5	59.35	179.5	57.95	178.3	56.71	178.3	55.05	178.3	53.51	174.6	51.54
	-3.0	-3.7	186.2	57.55	186.2	56.13	185.0	54.86	185.0	53.25	185.0	51.76	180.4	49.90
	0.0	-0.7	196.2	54.85	196.2	53.39	195.0	52.10	195.0	50.57	195.0	49.13	188.8	47.44
	3.0	2.2	206.4	52.16	206.4	50.64	205.0	49.32	205.0	47.88	203.5	46.48	190.6	44.98
	5.0	4.1	212.5	50.35	212.5	48.82	211.4	47.48	210.2	46.09	204.7	44.73	190.6	43.33
	7.0	6.0	217.5	48.56	217.5	46.99	216.2	45.63	212.1	44.30	204.7	42.98	190.6	41.70
	9.0	7.9	218.2	47.07	218.2	45.54	217.5	44.22	212.1	42.93	204.7	41.66	190.6	40.41
	11.0	9.8	218.2	45.97	218.2	44.48	217.5	43.20	212.1	41.94	204.7	40.69	190.6	39.47
	13.0	11.8	218.2	44.80	218.2	43.35	217.5	42.09	212.1	40.87	204.7	39.66	190.6	38.47
15.0	13.7	218.2	43.55	218.2	42.15	217.5	40.92	212.1	39.73	204.7	38.55	190.6	37.39	
120	-24.8	-25	105.9	55.30	105.9	55.77	105.2	56.47	105.2	57.17	105.2	58.25	103.6	59.00
	-21.8	-22	127.7	56.37	127.7	56.84	126.8	57.55	126.8	58.25	126.8	59.31	124.9	60.07
	-19.8	-20	134.1	57.09	134.1	57.55	133.2	58.28	133.2	58.95	133.2	60.03	131.2	60.78
	-18.8	-19	137.0	57.45	137.0	57.92	136.1	58.63	136.1	59.31	136.1	60.39	134.1	61.14
	-16.7	-17	143.2	58.20	143.2	58.67	142.3	59.38	142.3	60.07	142.3	61.14	140.0	59.56
	-13.7	-15	151.9	59.28	151.9	59.75	151.0	60.46	151.0	61.14	151.0	58.77	148.6	57.30
	-11.8	-13	156.9	59.95	156.9	60.42	155.9	61.14	155.9	59.46	155.9	57.27	154.0	55.87
	-9.8	-11	162.1	60.68	162.1	61.14	161.2	59.28	161.2	57.69	161.2	55.69	159.5	54.36
	-9.5	-10	163.1	60.78	163.1	60.84	162.2	59.01	162.2	57.43	162.2	55.46	160.5	54.13
	-8.5	-9.1	166.5	61.14	166.5	59.85	165.4	58.07	165.4	56.54	165.2	54.68	163.4	53.38
	-7.0	-7.6	171.5	59.66	171.5	58.38	170.4	56.69	170.4	55.22	169.8	53.49	167.8	52.24
	-5.0	-5.6	178.2	57.68	178.2	56.40	177.1	54.83	177.1	53.44	177.1	51.90	173.5	50.73
	-3.0	-3.7	184.9	55.70	184.9	54.44	183.7	52.96	183.7	51.69	183.7	50.33	178.2	49.22
	0.0	-0.7	194.9	52.73	194.9	51.47	193.6	50.18	193.6	49.03	192.4	47.96	179.0	46.96
	3.0	2.2	204.9	49.76	204.9	48.51	202.7	47.40	198.8	46.38	192.6	45.59	179.0	44.70
	5.0	4.1	211.0	47.78	210.5	46.54	205.7	45.54	198.8	44.61	192.6	44.02	179.0	43.19
	7.0	6.0	215.9	45.80	214.2	44.56	205.7	43.68	198.8	42.84	192.6	42.44	179.0	41.68
	9.0	7.9	216.5	44.28	214.2	43.08	205.7	42.24	198.8	41.44	192.6	41.05	179.0	40.30
	11.0	9.8	216.5	43.16	214.2	41.99	205.7	41.16	198.8	40.38	192.6	39.99	179.0	39.28
	13.0	11.8	216.5	41.95	214.2	40.81	205.7	40.01	198.8	39.25	192.6	38.88	179.0	38.19
15.0	13.7	216.5	40.67	214.2	39.56	205.7	38.79	198.8	38.04	192.6	37.68	179.0	37.01	
110	-24.8	-25	105.3	55.77	105.3	56.47	104.7	57.17	104.7	58.25	104.7	59.00	103.0	59.35
	-21.8	-22	127.1	56.84	127.1	57.55	126.2	58.25	126.2	59.31	126.2	60.07	124.3	60.42
	-19.8	-20	133.4	57.55	133.4	58.28	132.6	58.95	132.6	60.03	132.6	60.78	130.4	61.14
	-18.8	-19	136.3	57.92	136.3	58.63	135.4	59.31	135.4	60.39	135.4	61.14	133.3	60.31
	-16.7	-17	142.4	58.67	142.4	59.38	141.5	60.07	141.5	61.14	141.5	59.44	139.2	58.57
	-13.7	-15	151.1	59.75	151.1	60.46	150.1	61.14	150.1	58.56	150.1	57.00	150.1	56.09
	-11.8	-13	156.1	60.42	156.1	61.14	155.0	59.31	155.0	56.92	155.0	55.46	155.0	54.52
	-9.8	-11	161.2	61.14	161.2	59.08	160.3	57.40	160.3	55.20	160.3	53.84	159.3	52.87
	-9.5	-10	162.2	60.80	162.2	58.76	161.3	57.10	161.3	54.94	161.3	53.60	160.8	52.62
	-8.5	-9.1	165.6	59.69	165.6	57.73	164.6	56.14	164.6	54.07	164.6	52.77	161.1	51.78
	-7.0	-7.6	170.6	58.00	170.6	56.18	169.5	54.70	169.5	52.78	169.5	51.57	161.1	50.55
	-5.0	-5.6	177.2	55.77	177.2	54.10	176.0	52.78	176.0	51.06	172.4	49.94	161.1	48.88
	-3.0	-3.7	183.8	53.53	183.8	52.04	182.6	50.84	178.6	49.33	172.4	48.31	161.1	47.24
	0.0	-0.7	193.8	50.17	193.4	48.94	184.5	47.96	178.6	46.75	172.4	45.89	161.1	44.76
	3.0	2.2	203.3	46.81	196.7	45.83	184.5	45.07	178.6	44.18	172.4	43.44	161.1	42.27
	5.0	4.1	208.1	44.57	196.7	43.76	184.5	43.15	178.6	42.45	172.4	41.82	161.1	40.61
	7.0	6.0	208.1	42.32	196.7	41.69	184.5	41.22	178.6	40.72	172.4	40.20	161.1	38.96
	9.0	7.9	208.1	40.75	196.7	40.14	184.5	39.70	178.6	39.21	172.4	38.71	161.1	37.51
	11.0	9.8	208.1	39.53	196.7	38.94	184.5	38.49	178.6	38.02	172.4	37.53	161.1	36.38
	13.0	11.8	208.1	38.21	196.7	37.65	184.5	37.22	178.6	36.77	172.4	36.30	161.1	35.19
15.0	13.7	208.1	36.84	196.7	36.28	184.5	35.87	178.6	35.43	172.4	34.99	161.1	33.90	

# 7. Capacity Tables

Heating Capacity (54HP)

Combination (%)	Outdoor air temp.		Indoor air temp. °C DB											
			16		18		20		21		22		24	
	°C DB	°C WB	TC	PI	TC	PI	TC	PI	TC	PI	TC	PI	TC	PI
100	-24.8	-25	104.8	60.85	104.8	60.89	104.2	57.70	104.2	60.98	104.2	61.03	102.5	61.05
	-21.8	-22	126.4	60.91	126.4	60.95	125.7	59.53	125.7	61.04	125.7	61.79	123.6	61.11
	-19.8	-20	132.8	60.95	132.8	60.98	132.0	60.68	132.0	61.08	132.0	61.36	130.0	61.14
	-18.8	-19	135.7	60.97	134.9	61.01	134.9	61.04	134.9	61.09	134.9	61.14	132.7	60.14
	-16.7	-17	140.9	61.01	140.9	61.05	140.9	61.79	140.2	61.14	140.2	59.07	137.9	58.05
	-13.7	-15	150.4	61.07	150.4	61.10	149.5	61.14	149.5	58.13	149.5	56.12	147.2	55.04
	-11.8	-13	155.3	61.11	154.4	61.14	154.4	59.11	154.4	56.21	154.4	54.23	147.2	53.14
	-9.8	-11	160.3	61.14	160.3	58.86	159.7	56.97	159.7	54.21	158.0	52.27	147.2	51.14
	-9.5	-10	161.3	60.78	161.3	58.51	160.6	56.65	160.6	53.90	158.0	51.97	147.2	50.84
	-8.5	-9.1	164.7	59.58	164.7	57.38	163.9	55.58	163.4	52.89	158.0	50.98	147.2	49.84
	-7.0	-7.6	172.4	57.78	171.8	55.66	168.8	53.97	163.4	51.40	158.0	49.51	147.2	48.33
	-5.0	-5.6	180.0	55.38	178.2	53.39	168.8	51.84	163.4	49.38	158.0	47.53	147.2	46.33
	-3.0	-3.7	185.2	52.98	179.6	51.10	168.8	49.70	163.4	47.36	158.0	45.57	147.2	44.33
	0.0	-0.7	190.4	49.39	179.6	47.68	168.8	46.49	163.4	44.35	158.0	42.60	147.2	41.33
	3.0	2.2	190.4	45.78	179.6	44.25	168.8	43.28	163.4	41.34	158.0	39.65	147.2	38.33
	5.0	4.1	190.4	43.38	179.6	41.98	168.8	41.14	163.4	39.32	158.0	37.67	147.2	36.33
	7.0	6.0	190.4	40.98	179.6	39.69	168.8	39.00	163.4	37.31	158.0	35.70	147.2	34.33
	9.0	7.9	190.4	39.07	179.6	37.84	168.8	37.18	163.4	35.58	158.0	34.05	147.2	32.73
	11.0	9.8	190.4	37.48	179.6	36.31	168.8	35.68	163.4	34.13	158.0	32.65	147.2	31.41
	13.0	11.8	190.4	35.81	179.6	34.67	168.8	34.07	163.4	32.60	158.0	31.19	147.2	29.99
15.0	13.7	190.4	34.04	179.6	32.96	168.8	32.39	163.4	30.98	158.0	29.65	147.2	28.51	
90	-24.8	-25	104.4	54.61	104.4	55.68	103.8	56.44	103.8	56.79	103.8	57.51	102.2	58.59
	-21.8	-22	125.9	55.68	125.9	56.76	125.2	57.51	125.2	57.87	125.2	58.59	123.1	56.00
	-19.8	-20	132.3	56.40	132.3	57.47	131.4	58.22	131.4	58.59	131.4	56.81	129.4	54.28
	-18.8	-19	135.7	56.76	134.9	57.84	134.3	58.59	134.3	57.68	134.3	55.93	132.2	53.43
	-16.7	-17	140.9	57.51	140.9	58.59	140.3	56.69	140.3	55.75	140.3	54.08	134.5	51.62
	-13.7	-15	150.4	58.59	150.4	55.76	149.0	53.99	149.0	53.02	144.9	51.42	134.5	49.03
	-11.8	-13	155.3	56.64	154.4	53.97	153.8	52.27	149.7	51.28	144.9	49.74	134.5	47.40
	-9.8	-11	160.3	54.61	160.3	52.10	154.5	50.47	149.7	49.45	144.9	47.97	134.5	45.68
	-9.5	-10	161.3	54.29	161.3	51.81	154.5	50.20	149.7	49.18	144.9	47.70	134.5	45.42
	-8.5	-9.1	164.7	53.28	163.5	50.88	154.5	49.29	149.7	48.26	144.9	46.82	134.5	44.55
	-7.0	-7.6	172.4	51.74	164.0	49.46	154.5	47.94	149.7	46.89	144.9	45.49	134.5	43.26
	-5.0	-5.6	174.3	49.70	164.0	47.58	154.5	46.15	149.7	45.08	144.9	43.72	134.5	41.55
	-3.0	-3.7	174.3	47.66	164.0	45.71	154.5	44.34	149.7	43.24	144.9	41.94	134.5	39.82
	0.0	-0.7	174.3	44.60	164.0	42.88	154.5	41.63	149.7	40.51	144.9	39.30	134.5	37.24
	3.0	2.2	174.3	41.53	164.0	40.05	154.5	38.93	149.7	37.77	144.9	36.65	134.5	34.66
	5.0	4.1	174.3	39.49	164.0	38.17	154.5	37.12	149.7	35.94	144.9	34.87	134.5	32.93
	7.0	6.0	174.3	37.44	164.0	36.30	154.5	35.32	149.7	34.12	144.9	33.10	134.5	31.22
	9.0	7.9	174.3	35.53	164.0	34.44	154.5	33.52	149.7	32.38	144.9	31.41	134.5	29.62
	11.0	9.8	174.3	33.62	164.0	32.60	154.5	31.71	149.7	30.63	144.9	29.72	134.5	28.02
	13.0	11.8	174.3	31.71	164.0	30.73	154.5	29.91	149.7	28.89	144.9	28.04	134.5	26.43
15.0	13.7	174.3	29.80	164.0	28.88	154.5	28.11	149.7	27.14	144.9	26.34	134.5	24.84	
80	-24.8	-25	103.9	47.97	103.9	49.05	103.3	49.80	103.3	50.16	103.3	51.95	101.7	49.68
	-21.8	-22	124.6	49.05	124.6	50.12	124.6	50.87	124.6	51.95	124.6	49.68	120.2	47.50
	-19.8	-20	130.9	49.76	130.9	50.83	130.9	51.95	130.9	50.34	129.0	48.16	120.2	46.05
	-18.8	-19	133.8	50.12	133.8	51.95	133.8	51.13	133.3	49.54	129.2	47.40	120.2	45.33
	-16.7	-17	138.1	51.95	138.1	50.24	138.1	49.42	134.0	47.86	129.2	45.82	120.2	43.81
	-13.7	-15	144.4	49.42	141.6	47.80	138.1	46.97	134.0	45.44	129.2	43.54	120.2	41.63
	-11.8	-13	148.4	47.80	144.0	46.25	138.1	45.41	134.0	43.91	129.2	42.10	120.2	40.24
	-9.8	-11	152.3	46.11	145.9	44.63	138.1	43.78	134.0	42.31	129.2	40.58	120.2	38.79
	-9.5	-10	153.3	45.86	146.7	44.38	138.1	43.53	134.0	42.07	129.2	40.35	120.2	38.58
	-8.5	-9.1	154.8	45.02	147.2	43.57	138.1	42.72	134.0	41.26	129.2	39.60	120.2	37.85
	-7.0	-7.6	156.1	43.74	147.2	42.35	138.1	41.49	134.0	40.06	129.2	38.47	120.2	36.76
	-5.0	-5.6	156.1	42.05	147.2	40.73	138.1	39.86	134.0	38.44	129.2	36.94	120.2	35.31
	-3.0	-3.7	156.1	40.36	147.2	39.10	138.1	38.22	134.0	36.85	129.2	35.44	120.2	33.85
	0.0	-0.7	156.1	37.81	147.2	36.67	138.1	35.78	134.0	34.43	129.2	33.15	120.2	31.68
	3.0	2.2	156.1	35.28	147.2	34.22	138.1	33.32	134.0	32.01	129.2	30.88	120.2	29.50
	5.0	4.1	156.1	33.59	147.2	32.60	138.1	31.69	134.0	30.41	129.2	29.37	120.2	28.05
	7.0	6.0	156.1	31.90	147.2	30.97	138.1	30.06	134.0	28.81	129.2	27.86	120.2	26.59
	9.0	7.9	156.1	29.95	147.2	29.08	138.1	28.22	134.0	27.05	129.2	26.16	120.2	24.98
	11.0	9.8	156.1	27.80	147.2	26.99	138.1	26.20	134.0	25.10	129.2	24.27	120.2	23.18
	13.0	11.8	156.1	25.95	147.2	25.19	138.1	24.46	134.0	23.43	129.2	22.66	120.2	21.63
15.0	13.7	156.1	24.42	147.2	23.71	138.1	23.01	134.0	22.05	129.2	21.33	120.2	20.37	

# 7. Capacity Tables

Heating Capacity (54HP)

Combination (%)	Outdoor air temp.		Indoor air temp. °C DB											
			16		18		20		21		22		24	
	°C DB	°C WB	TC	PI	TC	PI	TC	PI	TC	PI	TC	PI	TC	PI
70	-24.8	-25	103.9	48.43	103.9	48.78	103.3	49.51	103.3	50.59	103.3	48.14	100.7	45.84
	-21.8	-22	118.4	49.51	118.4	49.86	117.6	50.59	113.6	48.14	110.2	45.84	102.8	43.63
	-19.8	-20	127.9	50.23	125.0	50.59	117.6	48.86	113.6	46.50	110.2	44.31	102.8	42.17
	-18.8	-19	130.9	50.59	125.0	49.69	117.6	47.99	113.6	45.68	110.2	43.55	102.8	41.42
	-16.7	-17	132.4	48.72	125.0	47.81	117.6	46.19	113.6	43.96	110.2	41.95	102.8	39.88
	-13.7	-15	132.4	46.08	125.0	45.14	117.6	43.60	113.6	41.51	110.2	39.66	102.8	37.67
	-11.8	-13	132.4	44.38	125.0	43.44	117.6	41.96	113.6	39.95	110.2	38.20	102.8	36.27
	-9.8	-11	132.4	42.63	125.0	41.66	117.6	40.25	113.6	38.32	110.2	36.68	102.8	34.80
	-9.5	-10	132.4	42.35	125.0	41.38	117.6	39.99	113.6	38.08	110.2	36.46	102.8	34.58
	-8.5	-9.1	132.4	41.48	125.0	40.50	117.6	39.12	113.6	37.26	110.2	35.69	102.8	33.84
	-7.0	-7.6	132.4	40.15	125.0	39.16	117.6	37.83	113.6	36.04	110.2	34.55	102.8	32.74
	-5.0	-5.6	132.4	38.38	125.0	37.38	117.6	36.11	113.6	34.40	110.2	33.01	102.8	31.26
	-3.0	-3.7	132.4	36.62	125.0	35.58	117.6	34.38	113.6	32.76	110.2	31.49	102.8	29.79
	0.0	-0.7	132.4	33.96	125.0	32.91	117.6	31.80	113.6	30.31	110.2	29.20	102.8	27.58
	3.0	2.2	132.4	31.31	125.0	30.23	117.6	29.21	113.6	27.87	110.2	26.91	102.8	25.37
	5.0	4.1	132.4	29.54	125.0	28.44	117.6	27.49	113.6	26.24	110.2	25.38	102.8	23.90
	7.0	6.0	132.4	27.77	125.0	26.66	117.6	25.77	113.6	24.60	110.2	23.85	102.8	22.43
	9.0	7.9	132.4	25.08	125.0	24.07	117.6	23.27	113.6	22.21	110.2	21.55	102.8	20.25
	11.0	9.8	132.4	23.36	125.0	22.41	117.6	21.66	113.6	20.68	110.2	20.06	102.8	18.85
	13.0	11.8	132.4	21.85	125.0	20.97	117.6	20.27	113.6	19.35	110.2	18.77	102.8	17.65
15.0	13.7	132.4	20.60	125.0	19.77	117.6	19.11	113.6	18.24	110.2	17.70	102.8	16.63	
60	-24.8	-25	101.1	47.70	101.1	48.43	100.5	49.51	97.4	46.91	94.1	44.48	88.1	42.20
	-21.8	-22	108.5	48.78	107.5	49.51	100.9	46.91	97.4	44.48	94.1	42.20	88.1	40.00
	-19.8	-20	113.6	49.51	107.5	47.67	100.9	45.18	97.4	42.86	94.1	40.67	88.1	38.53
	-18.8	-19	113.6	48.59	107.5	46.75	100.9	44.31	97.4	42.04	94.1	39.91	88.1	37.79
	-16.7	-17	113.6	46.63	107.5	44.82	100.9	42.50	97.4	40.35	94.1	38.32	88.1	36.25
	-13.7	-15	113.6	43.84	107.5	42.07	100.9	39.91	97.4	37.92	94.1	36.04	88.1	34.05
	-11.8	-13	113.6	42.08	107.5	40.33	100.9	38.25	97.4	36.37	94.1	34.60	88.1	32.67
	-9.8	-11	113.6	40.23	107.5	38.49	100.9	36.53	97.4	34.76	94.1	33.07	88.1	31.19
	-9.5	-10	113.6	39.94	107.5	38.23	100.9	36.27	97.4	34.51	94.1	32.84	88.1	30.97
	-8.5	-9.1	113.6	39.02	107.5	37.31	100.9	35.41	97.4	33.71	94.1	32.07	88.1	30.24
	-7.0	-7.6	113.6	37.63	107.5	35.93	100.9	34.11	97.4	32.49	94.1	30.93	88.1	29.14
	-5.0	-5.6	113.6	35.77	107.5	34.09	100.9	32.38	97.4	30.87	94.1	29.42	88.1	27.67
	-3.0	-3.7	113.6	33.92	107.5	32.25	100.9	30.65	97.4	29.25	94.1	27.89	88.1	26.20
	0.0	-0.7	113.6	31.13	107.5	29.50	100.9	28.06	97.4	26.81	94.1	25.61	88.1	24.00
	3.0	2.2	113.6	28.35	107.5	26.75	100.9	25.46	97.4	24.39	94.1	23.33	88.1	21.79
	5.0	4.1	113.6	26.50	107.5	24.91	100.9	23.74	97.4	22.77	94.1	21.81	88.1	20.33
	7.0	6.0	113.6	24.64	107.5	23.08	100.9	22.01	97.4	21.14	94.1	20.29	88.1	18.85
	9.0	7.9	113.6	21.99	107.5	20.59	100.9	19.63	97.4	18.87	94.1	18.09	88.1	16.82
	11.0	9.8	113.6	20.52	107.5	19.23	100.9	18.33	97.4	17.61	94.1	16.90	88.1	15.71
	13.0	11.8	113.6	19.23	107.5	18.00	100.9	17.18	97.4	16.50	94.1	15.83	88.1	14.73
15.0	13.7	113.6	18.17	107.5	17.03	100.9	16.23	97.4	15.59	94.1	14.96	88.1	13.92	
50	-24.8	-25	94.7	42.05	89.3	43.13	84.0	40.82	81.3	38.65	78.6	36.61	73.2	34.72
	-21.8	-22	94.7	43.13	89.3	40.82	84.0	38.65	81.3	36.61	78.6	34.72	73.2	32.90
	-19.8	-20	94.7	41.51	89.3	39.27	84.0	37.22	81.3	35.24	78.6	33.45	73.2	31.67
	-18.8	-19	94.7	40.70	89.3	38.49	84.0	36.50	81.3	34.58	78.6	32.82	73.2	31.07
	-16.7	-17	94.7	39.01	89.3	36.89	84.0	34.99	81.3	33.15	78.6	31.49	73.2	29.79
	-13.7	-15	94.7	36.59	89.3	34.56	84.0	32.83	81.3	31.11	78.6	29.59	73.2	27.97
	-11.8	-13	94.7	35.06	89.3	33.10	84.0	31.45	81.3	29.81	78.6	28.39	73.2	26.82
	-9.8	-11	94.7	33.44	89.3	31.56	84.0	30.01	81.3	28.45	78.6	27.12	73.2	25.59
	-9.5	-10	94.7	33.20	89.3	31.34	84.0	29.80	81.3	28.25	78.6	26.94	73.2	25.42
	-8.5	-9.1	94.7	32.38	89.3	30.56	84.0	29.08	81.3	27.57	78.6	26.31	73.2	24.81
	-7.0	-7.6	94.7	31.18	89.3	29.41	84.0	28.00	81.3	26.55	78.6	25.36	73.2	23.90
	-5.0	-5.6	94.7	29.56	89.3	27.87	84.0	26.57	81.3	25.19	78.6	24.09	73.2	22.69
	-3.0	-3.7	94.7	27.94	89.3	26.32	84.0	25.11	81.3	23.83	78.6	22.82	73.2	21.47
	0.0	-0.7	94.7	25.53	89.3	24.00	84.0	22.96	81.3	21.79	78.6	20.92	73.2	19.64
	3.0	2.2	94.7	23.11	89.3	21.70	84.0	20.80	81.3	19.74	78.6	19.03	73.2	17.82
	5.0	4.1	94.7	21.49	89.3	20.15	84.0	19.36	81.3	18.39	78.6	17.76	73.2	16.62
	7.0	6.0	94.7	19.87	89.3	18.61	84.0	17.93	81.3	17.03	78.6	16.49	73.2	15.39
	9.0	7.9	94.7	17.94	89.3	16.80	84.0	16.19	81.3	15.38	78.6	14.90	73.2	13.90
	11.0	9.8	94.7	16.79	89.3	15.72	84.0	15.15	81.3	14.39	78.6	13.94	73.2	13.00
	13.0	11.8	94.7	15.77	89.3	14.77	84.0	14.21	81.3	13.51	78.6	13.09	73.2	12.22
15.0	13.7	94.7	14.92	89.3	13.97	84.0	13.46	81.3	12.78	78.6	12.38	73.2	11.56	

**Note**

1. TC: Total Capacity(kW), PI : Power Input(kW, Comp. + Outdoor fan motor)
2. Capacity tables show the average value of conditions which may occur.
3. The heating capacity table is based on the values expressed as Max. in the specification of the outdoor unit. (When measuring the Max. heating capacity, the setting status of the indoor unit is the same as that for measuring the heating capacity of the indoor unit.)

# 7. Capacity Tables

## ◆ ARUM560LTE5

Heating Capacity (56HP)

Combination (%)	Outdoor air temp.		Indoor air temp. °C DB											
			16		18		20		21		22		24	
	°C DB	°C WB	TC	PI	TC	PI	TC	PI	TC	PI	TC	PI	TC	PI
130	-24.8	-25	108.8	58.4	108.8	58.86	108.1	59.29	108.1	59.93	108.1	60.57	106.5	61.55
	-21.8	-22	132.4	59.35	132.4	59.84	131.5	60.27	131.5	60.92	131.5	61.55	129.4	62.52
	-19.8	-20	139.7	60.00	139.7	60.50	138.7	60.92	138.7	61.58	138.7	62.19	136.6	63.18
	-18.8	-19	142.8	60.33	142.8	60.82	141.9	61.25	141.9	61.90	141.9	62.52	139.6	63.50
	-16.7	-17	149.4	61.02	149.4	61.51	148.5	61.94	148.5	62.59	148.5	63.21	146.1	64.19
	-13.7	-15	158.8	62.01	158.8	62.49	157.9	62.92	157.9	63.57	157.9	64.19	155.3	61.72
	-11.8	-13	164.0	62.63	164.0	63.11	163.0	63.54	163.0	64.19	163.0	62.53	161.1	60.15
	-9.8	-11	169.4	63.27	169.4	63.77	168.4	64.19	168.4	62.42	168.4	60.78	166.9	58.51
	-9.5	-10	170.4	63.39	170.4	63.86	169.4	63.92	169.4	62.15	169.2	60.51	167.8	58.25
	-8.5	-9.1	173.9	63.70	173.9	64.19	172.9	63.00	172.9	61.25	171.9	59.63	170.8	57.42
	-7.0	-7.6	179.2	64.19	179.2	62.85	178.0	61.64	178.0	59.91	178.0	58.31	175.8	56.19
	-5.0	-5.6	186.1	62.45	186.1	61.06	184.9	59.81	184.9	58.13	184.9	56.56	181.8	54.54
	-3.0	-3.7	193.1	60.71	193.1	59.27	191.9	57.98	191.9	56.34	191.9	54.80	187.9	52.88
	0.0	-0.7	203.4	58.09	203.4	56.59	202.2	55.24	202.2	53.67	202.2	52.17	196.9	50.41
	3.0	2.2	213.9	55.48	213.9	53.89	212.5	52.50	212.5	50.99	211.0	49.52	197.7	47.94
	5.0	4.1	220.3	53.73	220.3	52.10	219.1	50.67	219.1	49.21	212.3	47.76	197.7	46.28
	7.0	6.0	225.4	51.98	225.4	50.30	224.1	48.85	220.1	47.43	212.3	46.01	197.7	44.64
9.0	7.9	226.3	50.54	226.3	48.91	225.6	47.49	220.1	46.11	212.3	44.74	197.7	43.40	
11.0	9.8	226.3	49.54	226.3	47.94	225.6	46.56	220.1	45.19	212.3	43.85	197.7	42.53	
13.0	11.8	226.3	48.46	226.3	46.90	225.6	45.53	220.1	44.21	212.3	42.90	197.7	41.61	
15.0	13.7	226.3	47.31	226.3	45.78	225.6	44.44	220.1	43.15	212.3	41.87	197.7	40.61	
120	-24.8	-25	108.1	58.86	108.1	59.29	107.3	59.93	107.3	60.57	107.3	61.55	105.7	62.24
	-21.8	-22	131.5	59.84	131.5	60.27	130.6	60.92	130.6	61.55	130.6	62.52	128.6	63.21
	-19.8	-20	138.7	60.50	138.7	60.92	137.8	61.58	137.8	62.19	137.8	63.18	135.6	63.86
	-18.8	-19	141.8	60.82	141.8	61.25	140.9	61.90	140.9	62.52	140.9	63.50	138.7	64.19
	-16.7	-17	148.4	61.51	148.4	61.94	147.4	62.59	147.4	63.21	147.4	64.19	145.0	62.60
	-13.7	-15	157.6	62.49	157.6	62.92	156.7	63.57	156.7	64.19	156.7	61.81	154.2	60.33
	-11.8	-13	162.8	63.11	162.8	63.54	161.8	64.19	161.8	62.51	161.8	60.31	159.9	58.89
	-9.8	-11	168.2	63.77	168.2	64.19	167.2	62.34	167.2	60.74	167.2	58.73	165.8	57.37
	-9.5	-10	169.3	63.86	169.3	63.90	168.3	62.07	168.3	60.47	168.3	58.49	166.8	57.14
	-8.5	-9.1	172.7	64.19	172.7	62.91	171.6	61.13	171.6	59.59	171.6	57.71	169.9	56.38
	-7.0	-7.6	177.9	62.73	177.9	61.44	176.8	59.75	176.8	58.26	176.8	56.52	174.5	55.24
	-5.0	-5.6	184.9	60.77	184.9	59.48	183.6	57.89	183.6	56.48	183.6	54.93	180.7	53.72
	-3.0	-3.7	191.7	58.81	191.7	57.53	190.5	56.03	190.5	54.72	190.5	53.35	185.7	52.20
	0.0	-0.7	202.0	55.88	202.0	54.58	200.7	53.25	200.7	52.06	199.5	50.97	185.7	49.93
	3.0	2.2	212.4	52.94	212.4	51.63	210.2	50.47	206.2	49.41	199.8	48.60	185.7	47.66
	5.0	4.1	218.7	50.99	218.2	49.67	213.4	48.62	206.2	47.64	199.8	47.02	185.7	46.14
	7.0	6.0	223.9	49.03	222.2	47.70	213.4	46.76	206.2	45.86	199.8	45.44	185.7	44.62
9.0	7.9	224.6	47.55	222.2	46.26	213.4	45.36	206.2	44.49	199.8	44.07	185.7	43.28	
11.0	9.8	224.6	46.50	222.2	45.23	213.4	44.33	206.2	43.49	199.8	43.08	185.7	42.32	
13.0	11.8	224.6	45.35	222.2	44.12	213.4	43.26	206.2	42.43	199.8	42.03	185.7	41.28	
15.0	13.7	224.6	44.14	222.2	42.94	213.4	42.10	206.2	41.29	199.8	40.90	185.7	40.17	
110	-24.8	-25	107.5	59.29	107.5	59.93	106.8	60.57	106.8	61.55	106.8	62.24	105.1	62.56
	-21.8	-22	130.8	60.27	130.8	60.92	129.9	61.55	129.9	62.52	129.9	63.21	127.9	63.54
	-19.8	-20	137.9	60.92	137.9	61.58	137.1	62.19	137.1	63.18	137.1	63.86	134.8	64.19
	-18.8	-19	141.0	61.25	141.0	61.90	140.1	62.52	140.1	63.50	140.1	64.19	137.9	63.35
	-16.7	-17	147.6	61.94	147.6	62.59	146.6	63.21	146.6	64.19	146.6	62.48	144.2	61.59
	-13.7	-15	156.8	62.92	156.8	63.57	155.7	64.19	155.7	61.59	155.7	60.01	155.7	59.07
	-11.8	-13	161.9	63.54	161.9	64.19	160.9	62.35	160.9	59.94	160.9	58.45	160.9	57.48
	-9.8	-11	167.3	64.19	167.3	62.12	166.3	60.42	166.3	58.20	166.3	56.82	165.6	55.80
	-9.5	-10	168.3	63.85	168.3	61.79	167.4	60.12	167.4	57.94	167.4	56.58	166.8	55.55
	-8.5	-9.1	171.8	62.74	171.8	60.76	170.7	59.16	170.7	57.06	170.7	55.74	167.1	54.71
	-7.0	-7.6	177.0	61.04	177.0	59.20	175.9	57.70	175.9	55.76	175.9	54.52	167.1	53.46
	-5.0	-5.6	183.8	58.80	183.8	57.11	182.6	55.77	182.6	54.03	178.9	52.88	167.1	51.77
	-3.0	-3.7	190.6	56.56	190.6	55.04	189.3	53.82	185.2	52.28	178.9	51.23	167.1	50.10
	0.0	-0.7	200.9	53.18	200.5	51.92	191.4	50.92	185.2	49.67	178.9	48.78	167.1	47.58
	3.0	2.2	210.7	49.81	204.0	48.79	191.4	48.00	185.2	47.08	178.9	46.31	167.1	45.06
	5.0	4.1	215.9	47.56	204.0	46.72	191.4	46.08	185.2	45.33	178.9	44.68	167.1	43.38
	7.0	6.0	215.9	45.30	204.0	44.63	191.4	44.13	185.2	43.59	178.9	43.03	167.1	41.70
9.0	7.9	215.9	43.75	204.0	43.10	191.4	42.62	185.2	42.10	178.9	41.55	167.1	40.27	
11.0	9.8	215.9	42.57	204.0	41.94	191.4	41.46	185.2	40.95	178.9	40.42	167.1	39.18	
13.0	11.8	215.9	41.30	204.0	40.69	191.4	40.23	185.2	39.74	178.9	39.23	167.1	38.03	
15.0	13.7	215.9	39.97	204.0	39.36	191.4	38.92	185.2	38.45	178.9	37.96	167.1	36.78	

# 7. Capacity Tables

Heating Capacity (56HP)

Combination (%)	Outdoor air temp.		Indoor air temp. °C DB											
			16		18		20		21		22		24	
	°C DB	°C WB	TC	PI	TC	PI	TC	PI	TC	PI	TC	PI	TC	PI
100	-24.8	-25	107.0	65.67	107.0	65.48	106.4	61.22	106.4	64.99	106.4	64.79	104.6	64.69
	-21.8	-22	130.1	65.38	130.1	65.18	129.4	63.15	129.4	64.70	129.4	65.38	127.2	64.40
	-19.8	-20	137.3	65.18	137.3	64.97	136.5	64.36	136.5	64.50	136.5	64.59	134.3	64.19
	-18.8	-19	140.4	65.08	139.6	64.89	139.6	64.70	139.6	64.39	139.6	64.19	137.3	63.17
	-16.7	-17	146.0	64.88	146.0	64.68	146.0	65.38	145.2	64.19	145.2	62.08	142.8	61.03
	-13.7	-15	156.0	64.58	156.0	64.38	155.1	64.19	155.1	61.13	155.1	59.06	152.7	57.95
	-11.8	-13	161.1	64.40	160.2	64.19	160.2	62.14	160.2	59.18	160.2	57.14	152.7	56.00
	-9.8	-11	166.4	64.19	166.4	61.89	165.7	59.97	165.7	57.14	163.9	55.13	152.7	53.95
	-9.5	-10	167.4	63.83	167.4	61.53	166.6	59.64	166.6	56.83	163.9	54.83	152.7	53.65
	-8.5	-9.1	170.9	62.62	170.9	60.39	170.1	58.56	169.5	55.80	163.9	53.82	152.7	52.62
	-7.0	-7.6	178.9	60.81	178.2	58.65	175.1	56.92	169.5	54.27	163.9	52.31	152.7	51.08
	-5.0	-5.6	186.7	58.38	184.8	56.35	175.1	54.76	169.5	52.22	163.9	50.30	152.7	49.04
	-3.0	-3.7	192.1	55.97	186.3	54.04	175.1	52.60	169.5	50.17	163.9	48.29	152.7	46.99
	0.0	-0.7	197.5	52.34	186.3	50.58	175.1	49.34	169.5	47.11	163.9	45.26	152.7	43.92
	3.0	2.2	197.5	48.70	186.3	47.11	175.1	46.09	169.5	44.04	163.9	42.25	152.7	40.85
	5.0	4.1	197.5	46.29	186.3	44.80	175.1	43.92	169.5	41.99	163.9	40.23	152.7	38.80
	7.0	6.0	197.5	43.86	186.3	42.49	175.1	41.75	169.5	39.94	163.9	38.22	152.7	36.75
	9.0	7.9	197.5	42.12	186.3	40.80	175.1	40.09	169.5	38.36	163.9	36.71	152.7	35.29
	11.0	9.8	197.5	40.73	186.3	39.45	175.1	38.77	169.5	37.08	163.9	35.48	152.7	34.13
	13.0	11.8	197.5	39.26	186.3	38.02	175.1	37.36	169.5	35.74	163.9	34.20	152.7	32.88
15.0	13.7	197.5	37.70	186.3	36.50	175.1	35.87	169.5	34.32	163.9	32.84	152.7	31.58	
90	-24.8	-25	106.6	58.36	106.6	59.33	105.9	60.03	105.9	60.34	105.9	61.01	104.3	61.99
	-21.8	-22	129.6	59.33	129.6	60.32	128.9	61.01	128.9	61.33	128.9	61.99	126.7	59.29
	-19.8	-20	136.8	60.00	136.8	60.97	135.9	61.66	135.9	61.99	135.9	60.14	133.8	57.50
	-18.8	-19	140.4	60.32	139.6	61.31	139.0	61.99	139.0	61.04	139.0	59.22	136.8	56.60
	-16.7	-17	146.0	61.01	146.0	61.99	145.4	60.02	145.4	59.04	145.4	57.29	139.5	54.71
	-13.7	-15	156.0	61.99	156.0	59.05	154.6	57.21	154.6	56.20	150.3	54.52	139.5	52.02
	-11.8	-13	161.1	59.97	160.2	57.20	159.6	55.42	155.3	54.39	150.3	52.77	139.5	50.31
	-9.8	-11	166.4	57.87	166.4	55.26	160.2	53.56	155.3	52.48	150.3	50.93	139.5	48.51
	-9.5	-10	167.4	57.54	167.4	54.95	160.2	53.27	155.3	52.19	150.3	50.65	139.5	48.24
	-8.5	-9.1	170.9	56.49	169.6	53.99	160.2	52.33	155.3	51.25	150.3	49.73	139.5	47.34
	-7.0	-7.6	178.9	54.90	170.1	52.52	160.2	50.93	155.3	49.82	150.3	48.34	139.5	45.99
	-5.0	-5.6	180.8	52.78	170.1	50.57	160.2	49.06	155.3	47.93	150.3	46.50	139.5	44.21
	-3.0	-3.7	180.8	50.67	170.1	48.62	160.2	47.18	155.3	46.02	150.3	44.65	139.5	42.40
	0.0	-0.7	180.8	47.50	170.1	45.68	160.2	44.37	155.3	43.17	150.3	41.89	139.5	39.71
	3.0	2.2	180.8	44.32	170.1	42.76	160.2	41.56	155.3	40.33	150.3	39.13	139.5	37.01
	5.0	4.1	180.8	42.20	170.1	40.80	160.2	39.68	155.3	38.42	150.3	37.28	139.5	35.20
	7.0	6.0	180.8	40.09	170.1	38.86	160.2	37.81	155.3	36.53	150.3	35.44	139.5	33.42
	9.0	7.9	180.8	38.10	170.1	36.93	160.2	35.94	155.3	34.71	150.3	33.68	139.5	31.76
	11.0	9.8	180.8	36.11	170.1	35.01	160.2	34.06	155.3	32.90	150.3	31.92	139.5	30.10
	13.0	11.8	180.8	34.13	170.1	33.08	160.2	32.19	155.3	31.09	150.3	30.17	139.5	28.44
15.0	13.7	180.8	32.14	170.1	31.15	160.2	30.31	155.3	29.27	150.3	28.40	139.5	26.79	
80	-24.8	-25	106.1	51.33	106.1	52.32	105.5	53.01	105.5	53.33	105.5	54.97	103.8	52.60
	-21.8	-22	128.2	52.32	128.2	53.30	128.2	53.98	128.2	54.97	128.2	52.60	124.7	50.32
	-19.8	-20	135.4	52.97	135.4	53.95	135.4	54.97	135.4	53.29	133.8	51.01	124.7	48.80
	-18.8	-19	138.5	53.30	138.5	54.97	138.5	54.11	138.3	52.45	134.0	50.22	124.7	48.05
	-16.7	-17	143.3	54.97	143.3	53.19	143.3	52.33	139.0	50.70	134.0	48.57	124.7	46.46
	-13.7	-15	149.8	52.34	146.9	50.65	143.3	49.78	139.0	48.18	134.0	46.19	124.7	44.18
	-11.8	-13	153.6	50.66	149.1	49.04	143.3	48.16	139.0	46.59	134.0	44.69	124.7	42.73
	-9.8	-11	157.7	48.90	151.2	47.36	143.3	46.46	139.0	44.92	134.0	43.11	124.7	41.22
	-9.5	-10	158.8	48.64	152.0	47.10	143.3	46.20	139.0	44.67	134.0	42.87	124.7	40.99
	-8.5	-9.1	160.4	47.77	152.7	46.26	143.3	45.36	139.0	43.82	134.0	42.08	124.7	40.24
	-7.0	-7.6	162.0	46.45	152.7	44.98	143.3	44.08	139.0	42.57	134.0	40.90	124.7	39.09
	-5.0	-5.6	162.0	44.69	152.7	43.31	143.3	42.38	139.0	40.89	134.0	39.30	124.7	37.58
	-3.0	-3.7	162.0	42.93	152.7	41.61	143.3	40.68	139.0	39.22	134.0	37.73	124.7	36.05
	0.0	-0.7	162.0	40.29	152.7	39.08	143.3	38.13	139.0	36.71	134.0	35.35	124.7	33.78
	3.0	2.2	162.0	37.66	152.7	36.53	143.3	35.57	139.0	34.18	134.0	32.98	124.7	31.51
	5.0	4.1	162.0	35.90	152.7	34.85	143.3	33.87	139.0	32.51	134.0	31.40	124.7	29.99
	7.0	6.0	162.0	34.15	152.7	33.15	143.3	32.18	139.0	30.84	134.0	29.82	124.7	28.47
	9.0	7.9	162.0	32.06	152.7	31.13	143.3	30.21	139.0	28.96	134.0	28.00	124.7	26.74
	11.0	9.8	162.0	29.76	152.7	28.90	143.3	28.05	139.0	26.87	134.0	25.98	124.7	24.81
	13.0	11.8	162.0	27.78	152.7	26.97	143.3	26.18	139.0	25.09	134.0	24.26	124.7	23.16
15.0	13.7	162.0	26.14	152.7	25.38	143.3	24.63	139.0	23.61	134.0	22.84	124.7	21.80	

# 7. Capacity Tables

Heating Capacity (56HP)

Combination (%)	Outdoor air temp.		Indoor air temp. °C DB											
			16		18		20		21		22		24	
	°C DB	°C WB	TC	PI	TC	PI	TC	PI	TC	PI	TC	PI	TC	PI
70	-24.8	-25	106.1	51.56	106.1	51.89	105.5	52.55	105.5	53.53	105.5	50.97	103.7	48.56
	-21.8	-22	122.8	52.55	122.8	52.87	122.0	53.53	117.8	50.97	114.3	48.56	106.7	46.25
	-19.8	-20	133.9	53.21	129.7	53.53	122.0	51.73	117.8	49.26	114.3	46.97	106.7	44.71
	-18.8	-19	137.1	53.53	129.7	52.60	122.0	50.82	117.8	48.39	114.3	46.16	106.7	43.93
	-16.7	-17	137.3	51.59	129.7	50.63	122.0	48.94	117.8	46.60	114.3	44.49	106.7	42.31
	-13.7	-15	137.3	48.83	129.7	47.84	122.0	46.23	117.8	44.04	114.3	42.09	106.7	39.99
	-11.8	-13	137.3	47.06	129.7	46.07	122.0	44.52	117.8	42.40	114.3	40.56	106.7	38.53
	-9.8	-11	137.3	45.23	129.7	44.20	122.0	42.72	117.8	40.69	114.3	38.97	106.7	36.98
	-9.5	-10	137.3	44.94	129.7	43.92	122.0	42.45	117.8	40.44	114.3	38.74	106.7	36.75
	-8.5	-9.1	137.3	44.03	129.7	42.99	122.0	41.55	117.8	39.58	114.3	37.93	106.7	35.98
	-7.0	-7.6	137.3	42.64	129.7	41.60	122.0	40.20	117.8	38.31	114.3	36.73	106.7	34.82
	-5.0	-5.6	137.3	40.80	129.7	39.73	122.0	38.39	117.8	36.59	114.3	35.13	106.7	33.28
	-3.0	-3.7	137.3	38.96	129.7	37.86	122.0	36.59	117.8	34.88	114.3	33.53	106.7	31.73
	0.0	-0.7	137.3	36.19	129.7	35.07	122.0	33.89	117.8	32.32	114.3	31.13	106.7	29.42
	3.0	2.2	137.3	33.42	129.7	32.27	122.0	31.18	117.8	29.76	114.3	28.74	106.7	27.09
	5.0	4.1	137.3	31.58	129.7	30.39	122.0	29.39	117.8	28.05	114.3	27.13	106.7	25.56
	7.0	6.0	137.3	29.73	129.7	28.54	122.0	27.58	117.8	26.34	114.3	25.54	106.7	24.01
	9.0	7.9	137.3	26.85	129.7	25.77	122.0	24.91	117.8	23.78	114.3	23.06	106.7	21.68
	11.0	9.8	137.3	25.01	129.7	23.99	122.0	23.19	117.8	22.14	114.3	21.48	106.7	20.18
	13.0	11.8	137.3	23.39	129.7	22.45	122.0	21.69	117.8	20.72	114.3	20.09	106.7	18.90
15.0	13.7	137.3	22.05	129.7	21.17	122.0	20.46	117.8	19.52	114.3	18.94	106.7	17.81	
60	-24.8	-25	104.9	50.83	104.9	51.49	104.2	52.48	101.1	49.75	97.6	47.19	91.4	44.79
	-21.8	-22	112.6	51.82	111.5	52.48	104.6	49.75	101.1	47.19	97.6	44.79	91.4	42.47
	-19.8	-20	117.8	52.48	111.5	50.55	104.6	47.93	101.1	45.49	97.6	43.18	91.4	40.92
	-18.8	-19	117.8	51.51	111.5	49.59	104.6	47.02	101.1	44.63	97.6	42.38	91.4	40.14
	-16.7	-17	117.8	49.46	111.5	47.55	104.6	45.11	101.1	42.84	97.6	40.71	91.4	38.52
	-13.7	-15	117.8	46.53	111.5	44.67	104.6	42.38	101.1	40.29	97.6	38.30	91.4	36.20
	-11.8	-13	117.8	44.69	111.5	42.83	104.6	40.64	101.1	38.66	97.6	36.78	91.4	34.74
	-9.8	-11	117.8	42.74	111.5	40.90	104.6	38.83	101.1	36.96	97.6	35.18	91.4	33.18
	-9.5	-10	117.8	42.44	111.5	40.62	104.6	38.56	101.1	36.70	97.6	34.93	91.4	32.95
	-8.5	-9.1	117.8	41.47	111.5	39.66	104.6	37.65	101.1	35.86	97.6	34.13	91.4	32.18
	-7.0	-7.6	117.8	40.02	111.5	38.21	104.6	36.29	101.1	34.57	97.6	32.93	91.4	31.02
	-5.0	-5.6	117.8	38.06	111.5	36.28	104.6	34.47	101.1	32.87	97.6	31.33	91.4	29.47
	-3.0	-3.7	117.8	36.12	111.5	34.35	104.6	32.65	101.1	31.17	97.6	29.72	91.4	27.92
	0.0	-0.7	117.8	33.19	111.5	31.45	104.6	29.93	101.1	28.60	97.6	27.32	91.4	25.61
	3.0	2.2	117.8	30.27	111.5	28.56	104.6	27.19	101.1	26.05	97.6	24.92	91.4	23.28
	5.0	4.1	117.8	28.33	111.5	26.63	104.6	25.38	101.1	24.35	97.6	23.32	91.4	21.74
	7.0	6.0	117.8	26.38	111.5	24.70	104.6	23.56	101.1	22.63	97.6	21.72	91.4	20.18
	9.0	7.9	117.8	23.54	111.5	22.05	104.6	21.01	101.1	20.20	97.6	19.37	91.4	18.01
	11.0	9.8	117.8	21.97	111.5	20.58	104.6	19.62	101.1	18.86	97.6	18.10	91.4	16.82
	13.0	11.8	117.8	20.58	111.5	19.27	104.6	18.39	101.1	17.67	97.6	16.94	91.4	15.76
15.0	13.7	117.8	19.45	111.5	18.23	104.6	17.37	101.1	16.69	97.6	16.02	91.4	14.90	
50	-24.8	-25	98.3	44.65	92.7	45.63	87.2	43.21	84.4	40.94	81.5	38.80	75.9	36.81
	-21.8	-22	98.3	45.63	92.7	43.21	87.2	40.94	84.4	38.80	81.5	36.81	75.9	34.89
	-19.8	-20	98.3	43.94	92.7	41.59	87.2	39.43	84.4	37.36	81.5	35.47	75.9	33.60
	-18.8	-19	98.3	43.09	92.7	40.77	87.2	38.68	84.4	36.66	81.5	34.81	75.9	32.97
	-16.7	-17	98.3	41.32	92.7	39.09	87.2	37.10	84.4	35.15	81.5	33.41	75.9	31.63
	-13.7	-15	98.3	38.79	92.7	36.65	87.2	34.82	84.4	33.01	81.5	31.42	75.9	29.71
	-11.8	-13	98.3	37.18	92.7	35.12	87.2	33.39	84.4	31.65	81.5	30.16	75.9	28.50
	-9.8	-11	98.3	35.49	92.7	33.50	87.2	31.87	84.4	30.22	81.5	28.82	75.9	27.21
	-9.5	-10	98.3	35.23	92.7	33.27	87.2	31.65	84.4	30.01	81.5	28.64	75.9	27.02
	-8.5	-9.1	98.3	34.38	92.7	32.45	87.2	30.90	84.4	29.30	81.5	27.97	75.9	26.38
	-7.0	-7.6	98.3	33.11	92.7	31.25	87.2	29.76	84.4	28.23	81.5	26.97	75.9	25.43
	-5.0	-5.6	98.3	31.42	92.7	29.63	87.2	28.26	84.4	26.80	81.5	25.64	75.9	24.15
	-3.0	-3.7	98.3	29.73	92.7	28.01	87.2	26.73	84.4	25.37	81.5	24.30	75.9	22.87
	0.0	-0.7	98.3	27.20	92.7	25.57	87.2	24.47	84.4	23.23	81.5	22.31	75.9	20.95
	3.0	2.2	98.3	24.66	92.7	23.16	87.2	22.21	84.4	21.08	81.5	20.32	75.9	19.03
	5.0	4.1	98.3	22.97	92.7	21.54	87.2	20.70	84.4	19.66	81.5	18.99	75.9	17.76
	7.0	6.0	98.3	21.28	92.7	19.92	87.2	19.19	84.4	18.23	81.5	17.65	75.9	16.48
	9.0	7.9	98.3	19.21	92.7	17.99	87.2	17.33	84.4	16.46	81.5	15.95	75.9	14.88
	11.0	9.8	98.3	17.98	92.7	16.83	87.2	16.21	84.4	15.41	81.5	14.92	75.9	13.92
	13.0	11.8	98.3	16.88	92.7	15.81	87.2	15.22	84.4	14.46	81.5	14.01	75.9	13.08
15.0	13.7	98.3	15.97	92.7	14.95	87.2	14.41	84.4	13.68	81.5	13.26	75.9	12.37	

**Note**

1. TC: Total Capacity(kW), PI : Power Input(kW, Comp. + Outdoor fan motor)
2. Capacity tables show the average value of conditions which may occur.
3. The heating capacity table is based on the values expressed as Max. in the specification of the outdoor unit. (When measuring the Max. heating capacity, the setting status of the indoor unit is the same as that for measuring the heating capacity of the indoor unit.)

# 7. Capacity Tables

## ◆ ARUM580LTE5

Heating Capacity (58HP)

Combination (%)	Outdoor air temp.		Indoor air temp. °C DB											
			16		18		20		21		22		24	
	°C DB	°C WB	TC	PI	TC	PI	TC	PI	TC	PI	TC	PI	TC	PI
130	-24.8	-25	112.7	61.3	112.7	61.83	112.1	62.27	112.1	62.93	112.1	63.58	110.3	64.59
	-21.8	-22	137.2	62.33	137.2	62.83	136.3	63.27	136.3	63.94	136.3	64.59	134.1	65.58
	-19.8	-20	144.7	63.00	144.7	63.51	143.7	63.94	143.7	64.61	143.7	65.25	141.5	66.26
	-18.8	-19	148.0	63.34	148.0	63.84	147.0	64.28	147.0	64.95	147.0	65.58	144.7	66.59
	-16.7	-17	154.8	64.04	154.8	64.54	153.8	64.98	153.8	65.65	153.8	66.29	151.3	67.29
	-13.7	-15	164.5	65.05	164.5	65.55	163.5	65.99	163.5	66.66	163.5	67.29	160.8	64.71
	-11.8	-13	169.9	65.70	169.9	66.19	168.9	66.63	168.9	67.29	168.9	67.99	166.9	65.56
	-9.8	-11	175.6	66.35	175.6	66.86	174.4	67.29	174.4	67.99	174.4	68.73	172.9	66.35
	-9.5	-10	176.6	66.47	176.6	66.96	175.5	67.01	175.5	67.66	175.5	68.35	173.9	67.08
	-8.5	-9.1	180.2	66.79	180.2	67.29	179.1	67.06	179.1	67.71	179.1	68.40	176.9	67.99
	-7.0	-7.6	185.6	67.29	185.6	67.99	184.4	67.71	184.4	68.35	184.4	69.08	182.1	68.73
	-5.0	-5.6	192.8	67.99	192.8	68.73	191.5	68.35	191.5	69.08	191.5	69.73	188.4	69.73
	-3.0	-3.7	200.0	68.73	200.0	69.48	198.7	69.08	198.7	69.73	198.7	70.38	196.4	70.38
	0.0	-0.7	210.7	69.48	210.7	70.23	209.4	70.88	209.4	71.53	209.4	72.08	207.1	71.53
	3.0	2.2	221.5	70.23	221.5	71.53	220.1	72.08	220.1	72.73	218.6	73.33	215.8	72.73
	5.0	4.1	228.1	71.53	228.1	72.73	226.9	73.33	226.9	74.08	225.7	74.63	223.4	74.08
	7.0	6.0	233.5	72.73	233.5	74.08	232.1	74.63	232.1	75.38	230.9	76.08	227.4	75.38
	9.0	7.9	234.5	73.33	234.5	74.63	233.7	75.38	233.7	76.08	232.0	76.63	228.0	76.08
	11.0	9.8	234.5	74.08	234.5	75.38	233.7	76.08	233.7	76.63	232.0	77.13	228.0	76.63
	13.0	11.8	234.5	74.63	234.5	75.38	233.7	76.08	233.7	76.63	232.0	77.13	228.0	76.63
15.0	13.7	234.5	75.38	234.5	76.08	233.7	76.63	233.7	77.13	232.0	77.68	228.0	77.13	
120	-24.8	-25	112.0	61.83	112.0	62.27	111.3	62.93	111.3	63.58	111.3	64.19	109.5	65.29
	-21.8	-22	136.2	62.83	136.2	63.27	135.3	63.94	135.3	64.59	135.3	65.58	133.2	66.29
	-19.8	-20	143.7	63.51	143.7	63.94	142.7	64.61	142.7	65.25	142.7	66.26	140.5	66.96
	-18.8	-19	146.9	63.84	146.9	64.28	145.9	64.95	145.9	65.58	145.9	66.59	143.7	67.29
	-16.7	-17	153.7	64.54	153.7	64.98	152.7	65.65	152.7	66.29	152.7	67.29	150.2	68.01
	-13.7	-15	163.3	65.55	163.3	65.99	162.3	66.66	162.3	67.29	162.3	68.01	159.7	68.73
	-11.8	-13	168.6	66.19	168.6	66.63	167.6	67.29	167.6	67.99	167.6	68.73	165.6	69.48
	-9.8	-11	174.3	66.86	174.3	67.29	173.3	67.99	173.3	68.73	173.3	69.48	171.8	70.23
	-9.5	-10	175.4	66.96	175.4	67.29	174.4	67.99	174.4	68.73	174.4	69.48	172.8	70.98
	-8.5	-9.1	179.0	67.29	179.0	67.99	177.7	68.01	177.7	68.73	177.7	69.48	176.0	71.53
	-7.0	-7.6	184.3	67.99	184.3	68.73	183.2	69.48	183.2	70.23	183.2	71.08	180.8	72.28
	-5.0	-5.6	191.5	68.73	191.5	69.48	190.2	70.23	190.2	71.08	190.2	71.83	187.1	73.03
	-3.0	-3.7	198.6	69.48	198.6	70.23	197.3	71.08	197.3	71.83	197.3	72.58	194.4	73.78
	0.0	-0.7	209.2	70.23	209.2	71.08	207.9	71.83	207.9	72.58	207.9	73.33	205.0	74.53
	3.0	2.2	219.9	71.08	219.9	71.83	218.6	72.58	218.6	73.33	217.3	74.08	214.4	75.28
	5.0	4.1	226.5	71.83	226.5	72.58	225.1	73.33	225.1	74.08	223.6	74.83	219.4	76.03
	7.0	6.0	231.9	72.58	231.9	73.33	230.6	74.08	230.6	74.83	229.1	75.58	223.4	76.78
	9.0	7.9	232.6	73.33	232.6	74.08	231.3	74.83	231.3	75.58	229.8	76.33	224.1	77.53
	11.0	9.8	232.6	74.08	232.6	74.83	231.3	75.58	231.3	76.33	229.8	77.08	224.1	78.28
	13.0	11.8	232.6	74.83	232.6	75.58	231.3	76.33	231.3	77.08	229.8	77.83	224.1	79.03
15.0	13.7	232.6	75.58	232.6	76.33	231.3	77.08	231.3	77.83	229.8	78.58	224.1	79.78	
110	-24.8	-25	111.4	62.27	111.4	62.93	110.7	63.58	110.7	64.19	110.7	64.79	108.9	65.63
	-21.8	-22	135.5	63.27	135.5	63.94	134.6	64.59	134.6	65.19	134.6	65.79	132.5	66.63
	-19.8	-20	142.9	63.94	142.9	64.61	142.1	65.25	142.1	65.85	142.1	66.49	140.0	67.58
	-18.8	-19	146.1	64.28	146.1	64.95	145.1	65.58	145.1	66.22	145.1	66.86	143.0	68.53
	-16.7	-17	152.9	64.98	152.9	65.65	151.9	66.29	151.9	66.92	151.9	67.56	149.4	69.48
	-13.7	-15	162.4	65.99	162.4	66.66	161.4	67.29	161.4	68.01	161.4	68.73	159.4	70.43
	-11.8	-13	167.8	66.63	167.8	67.29	166.7	67.99	166.7	68.73	166.7	69.48	165.6	71.18
	-9.8	-11	173.3	67.29	173.3	67.99	172.3	68.73	172.3	69.48	172.3	70.23	170.5	72.03
	-9.5	-10	174.4	67.39	174.4	68.09	173.4	68.79	173.4	69.49	173.4	70.19	171.6	72.78
	-8.5	-9.1	178.0	67.78	178.0	68.17	176.9	68.03	176.9	68.87	176.9	69.71	175.0	73.53
	-7.0	-7.6	183.3	68.01	183.3	68.73	182.2	69.48	182.2	70.23	182.2	71.08	179.8	74.28
	-5.0	-5.6	190.4	68.73	190.4	69.48	189.1	70.23	189.1	71.08	189.1	71.83	187.1	75.03
	-3.0	-3.7	197.5	69.48	197.5	70.23	196.1	71.08	196.1	71.83	196.1	72.58	194.4	75.78
	0.0	-0.7	208.1	70.23	208.1	71.08	206.7	71.83	206.7	72.58	206.7	73.33	204.4	76.53
	3.0	2.2	218.3	71.08	218.3	71.83	216.9	72.58	216.9	73.33	215.5	74.08	211.4	77.28
	5.0	4.1	223.6	71.83	223.6	72.58	222.1	73.33	222.1	74.08	220.6	74.83	215.1	78.03
	7.0	6.0	223.6	72.58	223.6	73.33	222.1	74.08	222.1	74.83	220.6	75.58	215.1	78.78
	9.0	7.9	223.6	73.33	223.6	74.08	222.1	74.83	222.1	75.58	220.6	76.33	215.1	79.53
	11.0	9.8	223.6	74.08	223.6	74.83	222.1	75.58	222.1	76.33	220.6	77.08	215.1	80.28
	13.0	11.8	223.6	74.83	223.6	75.58	222.1	76.33	222.1	77.08	220.6	77.83	215.1	81.03
15.0	13.7	223.6	75.58	223.6	76.33	222.1	77.08	222.1	77.83	220.6	78.58	215.1	81.78	



# 7. Capacity Tables

Heating Capacity (58HP)

Combination (%)	Outdoor air temp.		Indoor air temp. °C DB											
			16		18		20		21		22		24	
	°C DB	°C WB	TC	PI	TC	PI	TC	PI	TC	PI	TC	PI	TC	PI
100	-24.8	-25	110.9	68.94	110.9	68.72	110.2	64.22	110.2	68.19	110.2	67.96	108.4	67.85
	-21.8	-22	134.8	68.62	134.8	68.40	134.1	66.25	134.1	67.86	134.1	68.56	131.8	67.52
	-19.8	-20	142.3	68.40	142.3	68.17	141.4	67.52	141.4	67.64	141.4	67.72	139.2	67.29
	-18.8	-19	145.4	68.29	144.6	68.07	144.6	67.86	144.6	67.52	144.6	67.29	142.2	66.23
	-16.7	-17	151.3	68.06	151.3	67.84	151.3	68.56	150.4	67.29	150.4	65.09	147.9	63.98
	-13.7	-15	161.6	67.73	161.6	67.50	160.7	67.29	160.7	64.09	160.7	61.93	158.2	60.76
	-11.8	-13	166.9	67.52	166.0	67.29	166.0	65.15	166.0	62.05	166.0	59.92	158.2	58.73
	-9.8	-11	172.4	67.29	172.4	64.88	171.6	62.88	171.6	59.91	169.8	57.82	158.2	56.58
	-9.5	-10	173.4	66.92	173.4	64.52	172.6	62.53	172.6	59.59	169.8	57.49	158.2	56.26
	-8.5	-9.1	177.0	65.65	177.0	63.32	176.2	61.40	175.6	58.52	169.8	56.44	158.2	55.19
	-7.0	-7.6	185.3	63.76	184.6	61.50	181.4	59.69	175.6	56.92	169.8	54.86	158.2	53.58
	-5.0	-5.6	193.4	61.22	191.5	59.09	181.4	57.43	175.6	54.77	169.8	52.76	158.2	51.43
	-3.0	-3.7	199.0	58.70	193.0	56.67	181.4	55.17	175.6	52.62	169.8	50.66	158.2	49.29
	0.0	-0.7	204.6	54.90	193.0	53.05	181.4	51.76	175.6	49.42	169.8	47.49	158.2	46.08
	3.0	2.2	204.6	51.10	193.0	49.43	181.4	48.36	175.6	46.21	169.8	44.33	158.2	42.86
	5.0	4.1	204.6	48.58	193.0	47.02	181.4	46.09	175.6	44.06	169.8	42.22	158.2	40.72
	7.0	6.0	204.6	46.04	193.0	44.60	181.4	43.82	175.6	41.92	169.8	40.11	158.2	38.57
	9.0	7.9	204.6	44.22	193.0	42.83	181.4	42.08	175.6	40.27	169.8	38.53	158.2	37.05
	11.0	9.8	204.6	42.77	193.0	41.43	181.4	40.71	175.6	38.94	169.8	37.26	158.2	35.84
	13.0	11.8	204.6	41.24	193.0	39.93	181.4	39.24	175.6	37.54	169.8	35.92	158.2	34.54
15.0	13.7	204.6	39.61	193.0	38.36	181.4	37.69	175.6	36.06	169.8	34.51	158.2	33.18	
90	-24.8	-25	110.4	61.28	110.4	62.28	109.8	62.99	109.8	63.32	109.8	63.99	108.1	65.01
	-21.8	-22	134.3	62.28	134.3	63.29	133.6	63.99	133.6	64.33	133.6	65.01	131.3	62.18
	-19.8	-20	141.7	62.96	141.7	63.96	140.8	64.66	140.8	65.01	140.8	65.07	138.6	60.30
	-18.8	-19	145.4	63.29	144.6	64.30	144.0	65.01	144.0	64.01	144.0	62.10	141.7	59.36
	-16.7	-17	151.3	63.99	151.3	65.01	150.6	62.94	150.6	61.92	150.6	60.08	144.5	57.38
	-13.7	-15	161.6	65.01	161.6	61.93	160.1	60.00	160.1	58.94	155.7	57.18	144.5	54.56
	-11.8	-13	166.9	62.89	166.0	59.99	165.4	58.13	160.8	57.04	155.7	55.35	144.5	52.77
	-9.8	-11	172.4	60.69	172.4	57.96	166.0	56.17	160.8	55.05	155.7	53.42	144.5	50.89
	-9.5	-10	173.4	60.35	173.4	57.64	166.0	55.88	160.8	54.75	155.7	53.12	144.5	50.60
	-8.5	-9.1	177.0	59.24	175.8	56.62	166.0	54.89	160.8	53.75	155.7	52.16	144.5	49.66
	-7.0	-7.6	185.3	57.58	176.3	55.09	166.0	53.42	160.8	52.26	155.7	50.71	144.5	48.25
	-5.0	-5.6	187.3	55.37	176.3	53.04	166.0	51.46	160.8	50.28	155.7	48.78	144.5	46.38
	-3.0	-3.7	187.3	53.15	176.3	51.01	166.0	49.50	160.8	48.28	155.7	46.84	144.5	44.48
	0.0	-0.7	187.3	49.84	176.3	47.93	166.0	46.55	160.8	45.30	155.7	43.95	144.5	41.67
	3.0	2.2	187.3	46.50	176.3	44.87	166.0	43.61	160.8	42.32	155.7	41.06	144.5	38.84
	5.0	4.1	187.3	44.29	176.3	42.82	166.0	41.64	160.8	40.32	155.7	39.12	144.5	36.95
	7.0	6.0	187.3	42.07	176.3	40.79	166.0	39.69	160.8	38.34	155.7	37.20	144.5	35.07
	9.0	7.9	187.3	39.99	176.3	38.76	166.0	37.72	160.8	36.44	155.7	35.35	144.5	33.34
	11.0	9.8	187.3	37.91	176.3	36.76	166.0	35.76	160.8	34.54	155.7	33.51	144.5	31.60
	13.0	11.8	187.3	35.84	176.3	34.73	166.0	33.80	160.8	32.65	155.7	31.68	144.5	29.87
15.0	13.7	187.3	33.76	176.3	32.71	166.0	31.83	160.8	30.74	155.7	29.83	144.5	28.13	
80	-24.8	-25	110.0	53.91	110.0	54.93	109.3	55.63	109.3	55.96	109.3	57.64	107.6	55.16
	-21.8	-22	132.9	54.93	132.9	55.93	132.9	56.63	132.9	57.64	132.9	55.16	129.1	52.77
	-19.8	-20	140.3	55.59	140.3	56.59	140.3	57.64	140.3	55.89	138.6	53.50	129.1	51.18
	-18.8	-19	143.4	55.93	143.4	57.64	143.4	56.74	143.3	55.00	138.8	52.66	129.1	50.39
	-16.7	-17	148.4	57.64	148.4	55.78	148.4	54.88	144.0	53.17	138.8	50.93	129.1	48.73
	-13.7	-15	155.2	54.88	152.1	53.12	148.4	52.21	144.0	50.53	138.8	48.44	129.1	46.34
	-11.8	-13	159.1	53.13	154.4	51.44	148.4	50.51	144.0	48.86	138.8	46.87	129.1	44.82
	-9.8	-11	163.4	51.29	156.7	49.67	148.4	48.73	144.0	47.12	138.8	45.21	129.1	43.24
	-9.5	-10	164.5	51.02	157.5	49.40	148.4	48.46	144.0	46.85	138.8	44.96	129.1	43.00
	-8.5	-9.1	166.2	50.10	158.2	48.52	148.4	47.58	144.0	45.97	138.8	44.14	129.1	42.21
	-7.0	-7.6	167.8	48.72	158.2	47.18	148.4	46.24	144.0	44.66	138.8	42.90	129.1	41.01
	-5.0	-5.6	167.8	46.88	158.2	45.43	148.4	44.46	144.0	42.89	138.8	41.23	129.1	39.42
	-3.0	-3.7	167.8	45.04	158.2	43.65	148.4	42.67	144.0	41.15	138.8	39.59	129.1	37.83
	0.0	-0.7	167.8	42.27	158.2	41.00	148.4	40.01	144.0	38.51	138.8	37.09	129.1	35.45
	3.0	2.2	167.8	39.52	158.2	38.33	148.4	37.33	144.0	35.87	138.8	34.61	129.1	33.06
	5.0	4.1	167.8	37.68	158.2	36.58	148.4	35.55	144.0	34.12	138.8	32.95	129.1	31.48
	7.0	6.0	167.8	35.85	158.2	34.80	148.4	33.78	144.0	32.37	138.8	31.30	129.1	29.88
	9.0	7.9	167.8	33.65	158.2	32.68	148.4	31.71	144.0	30.39	138.8	29.39	129.1	28.06
	11.0	9.8	167.8	31.23	158.2	30.33	148.4	29.44	144.0	28.21	138.8	27.27	129.1	26.04
	13.0	11.8	167.8	29.16	158.2	28.31	148.4	27.48	144.0	26.33	138.8	25.46	129.1	24.31
15.0	13.7	167.8	27.44	158.2	26.64	148.4	25.85	144.0	24.78	138.8	23.97	129.1	22.88	

# 7. Capacity Tables

Heating Capacity (58HP)

Combination (%)	Outdoor air temp.		Indoor air temp. °C DB													
			16		18		20		21		22		24			
	°C DB	°C WB	TC	PI	TC	PI	TC	PI	TC	PI	TC	PI	TC	PI		
70	-24.8	-25	110.0	54.12	110.0	54.45	109.3	55.13	109.3	56.14	109.3	53.46	109.3	53.46	107.5	50.93
	-21.8	-22	127.2	55.13	127.2	55.47	126.4	56.14	122.0	53.46	118.5	50.93	110.5	48.51		
	-19.8	-20	138.6	55.81	134.3	56.14	126.4	54.25	122.0	51.66	118.5	49.26	110.5	46.90		
	-18.8	-19	142.1	56.14	134.3	55.16	126.4	53.30	122.0	50.76	118.5	48.42	110.5	46.08		
	-16.7	-17	142.3	54.10	134.3	53.10	126.4	51.33	122.0	48.88	118.5	46.67	110.5	44.38		
	-13.7	-15	142.3	51.21	134.3	50.18	126.4	48.49	122.0	46.19	118.5	44.15	110.5	41.95		
	-11.8	-13	142.3	49.36	134.3	48.32	126.4	46.70	122.0	44.48	118.5	42.55	110.5	40.42		
	-9.8	-11	142.3	47.44	134.3	46.37	126.4	44.82	122.0	42.69	118.5	40.88	110.5	38.80		
	-9.5	-10	142.3	47.14	134.3	46.07	126.4	44.53	122.0	42.43	118.5	40.64	110.5	38.56		
	-8.5	-9.1	142.3	46.19	134.3	45.10	126.4	43.58	122.0	41.52	118.5	39.79	110.5	37.75		
	-7.0	-7.6	142.3	44.73	134.3	43.64	126.4	42.17	122.0	40.19	118.5	38.54	110.5	36.53		
	-5.0	-5.6	142.3	42.80	134.3	41.68	126.4	40.28	122.0	38.39	118.5	36.86	110.5	34.91		
	-3.0	-3.7	142.3	40.87	134.3	39.72	126.4	38.39	122.0	36.60	118.5	35.18	110.5	33.29		
	0.0	-0.7	142.3	37.97	134.3	36.80	126.4	35.56	122.0	33.91	118.5	32.67	110.5	30.87		
	3.0	2.2	142.3	35.07	134.3	33.86	126.4	32.72	122.0	31.23	118.5	30.16	110.5	28.43		
	5.0	4.1	142.3	33.14	134.3	31.90	126.4	30.84	122.0	29.44	118.5	28.47	110.5	26.82		
	7.0	6.0	142.3	31.21	134.3	29.96	126.4	28.95	122.0	27.64	118.5	26.80	110.5	25.20		
	9.0	7.9	142.3	28.18	134.3	27.05	126.4	26.15	122.0	24.96	118.5	24.21	110.5	22.75		
	11.0	9.8	142.3	26.25	134.3	25.18	126.4	24.34	122.0	23.24	118.5	22.54	110.5	21.18		
	13.0	11.8	142.3	24.55	134.3	23.56	126.4	22.77	122.0	21.75	118.5	21.08	110.5	19.83		
15.0	13.7	142.3	23.14	134.3	22.22	126.4	21.47	122.0	20.49	118.5	19.88	110.5	18.69			
60	-24.8	-25	108.6	53.37	108.6	54.05	108.0	55.06	104.7	52.20	101.1	49.52	94.6	46.99		
	-21.8	-22	116.6	54.38	115.5	55.06	108.4	52.20	104.7	49.52	101.1	46.99	94.6	44.56		
	-19.8	-20	122.0	55.06	115.5	53.04	108.4	50.29	104.7	47.73	101.1	45.31	94.6	42.94		
	-18.8	-19	122.0	54.05	115.5	52.03	108.4	49.33	104.7	46.82	101.1	44.47	94.6	42.12		
	-16.7	-17	122.0	51.90	115.5	49.89	108.4	47.33	104.7	44.95	101.1	42.71	94.6	40.42		
	-13.7	-15	122.0	48.82	115.5	46.87	108.4	44.47	104.7	42.27	101.1	40.19	94.6	37.99		
	-11.8	-13	122.0	46.89	115.5	44.94	108.4	42.65	104.7	40.57	101.1	38.60	94.6	36.45		
	-9.8	-11	122.0	44.85	115.5	42.92	108.4	40.75	104.7	38.78	101.1	36.91	94.6	34.82		
	-9.5	-10	122.0	44.53	115.5	42.63	108.4	40.46	104.7	38.51	101.1	36.66	94.6	34.58		
	-8.5	-9.1	122.0	43.52	115.5	41.61	108.4	39.51	104.7	37.62	101.1	35.81	94.6	33.77		
	-7.0	-7.6	122.0	41.99	115.5	40.09	108.4	38.08	104.7	36.28	101.1	34.55	94.6	32.55		
	-5.0	-5.6	122.0	39.94	115.5	38.07	108.4	36.17	104.7	34.49	101.1	32.88	94.6	30.93		
	-3.0	-3.7	122.0	37.90	115.5	36.04	108.4	34.26	104.7	32.71	101.1	31.19	94.6	29.30		
	0.0	-0.7	122.0	34.83	115.5	33.01	108.4	31.41	104.7	30.01	101.1	28.67	94.6	26.87		
	3.0	2.2	122.0	31.77	115.5	29.97	108.4	28.54	104.7	27.34	101.1	26.16	94.6	24.43		
	5.0	4.1	122.0	29.73	115.5	27.95	108.4	26.64	104.7	25.55	101.1	24.47	94.6	22.82		
	7.0	6.0	122.0	27.69	115.5	25.93	108.4	24.72	104.7	23.76	101.1	22.80	94.6	21.19		
	9.0	7.9	122.0	24.71	115.5	23.14	108.4	22.06	104.7	21.20	101.1	20.33	94.6	18.90		
	11.0	9.8	122.0	23.06	115.5	21.60	108.4	20.60	104.7	19.79	101.1	18.99	94.6	17.65		
	13.0	11.8	122.0	21.60	115.5	20.23	108.4	19.30	104.7	18.54	101.1	17.78	94.6	16.55		
15.0	13.7	122.0	20.42	115.5	19.13	108.4	18.23	104.7	17.52	101.1	16.81	94.6	15.64			
50	-24.8	-25	101.8	46.84	96.0	47.85	90.3	45.31	87.4	42.93	84.5	40.69	78.7	38.60		
	-21.8	-22	101.8	47.85	96.0	45.31	90.3	42.93	87.4	40.69	84.5	38.60	78.7	36.59		
	-19.8	-20	101.8	46.08	96.0	43.61	90.3	41.35	87.4	39.18	84.5	37.20	78.7	35.25		
	-18.8	-19	101.8	45.19	96.0	42.76	90.3	40.56	87.4	38.44	84.5	36.51	78.7	34.58		
	-16.7	-17	101.8	43.33	96.0	40.99	90.3	38.91	87.4	36.87	84.5	35.04	78.7	33.17		
	-13.7	-15	101.8	40.68	96.0	38.44	90.3	36.52	87.4	34.63	84.5	32.96	78.7	31.16		
	-11.8	-13	101.8	39.00	96.0	36.83	90.3	35.02	87.4	33.20	84.5	31.63	78.7	29.89		
	-9.8	-11	101.8	37.22	96.0	35.14	90.3	33.43	87.4	31.70	84.5	30.24	78.7	28.54		
	-9.5	-10	101.8	36.95	96.0	34.89	90.3	33.20	87.4	31.48	84.5	30.04	78.7	28.35		
	-8.5	-9.1	101.8	36.06	96.0	34.04	90.3	32.41	87.4	30.73	84.5	29.34	78.7	27.68		
	-7.0	-7.6	101.8	34.74	96.0	32.78	90.3	31.22	87.4	29.62	84.5	28.29	78.7	26.67		
	-5.0	-5.6	101.8	32.96	96.0	31.08	90.3	29.64	87.4	28.11	84.5	26.90	78.7	25.34		
	-3.0	-3.7	101.8	31.19	96.0	29.38	90.3	28.05	87.4	26.62	84.5	25.50	78.7	24.00		
	0.0	-0.7	101.8	28.53	96.0	26.83	90.3	25.68	87.4	24.37	84.5	23.41	78.7	21.98		
	3.0	2.2	101.8	25.88	96.0	24.30	90.3	23.31	87.4	22.12	84.5	21.33	78.7	19.97		
	5.0	4.1	101.8	24.11	96.0	22.60	90.3	21.72	87.4	20.63	84.5	19.93	78.7	18.64		
	7.0	6.0	101.8	22.33	96.0	20.91	90.3	20.14	87.4	19.14	84.5	18.53	78.7	17.29		
	9.0	7.9	101.8	20.16	96.0	18.88	90.3	18.19	87.4	17.28	84.5	16.74	78.7	15.61		
	11.0	9.8	101.8	18.87	96.0	17.67	90.3	17.02	87.4	16.17	84.5	15.66	78.7	14.61		
	13.0	11.8	101.8	17.72	96.0	16.59	90.3	15.97	87.4	15.18	84.5	14.71	78.7	13.73		
15.0	13.7	101.8	16.76	96.0	15.69	90.3	15.12	87.4	14.36	84.5	13.91	78.7	12.99			

**Note**

1. TC: Total Capacity(kW), PI : Power Input(kW, Comp. + Outdoor fan motor)
2. Capacity tables show the average value of conditions which may occur.
3. The heating capacity table is based on the values expressed as Max. in the specification of the outdoor unit. (When measuring the Max. heating capacity, the setting status of the indoor unit is the same as that for measuring the heating capacity of the indoor unit.)

# 7. Capacity Tables

## ◆ ARUM600LTE5

Heating Capacity (60HP)

Combination (%)	Outdoor air temp.		Indoor air temp. °C DB											
			16		18		20		21		22		24	
	°C DB	°C WB	TC	PI	TC	PI	TC	PI	TC	PI	TC	PI	TC	PI
130	-24.8	-25	114.7	62.9	114.7	63.50	114.0	64.05	114.0	64.87	114.0	65.69	112.3	66.96
	-21.8	-22	140.4	64.12	140.4	64.75	139.4	65.30	139.4	66.14	139.4	66.96	137.1	68.20
	-19.8	-20	148.4	64.96	148.4	65.60	147.4	66.14	147.4	66.99	147.4	67.78	145.1	69.05
	-18.8	-19	151.9	65.39	151.9	66.02	150.9	66.57	150.9	67.41	150.9	68.20	148.4	69.47
	-16.7	-17	159.0	66.27	159.0	66.90	158.0	67.45	158.0	68.29	158.0	69.10	155.4	70.35
	-13.7	-15	169.1	67.54	169.1	68.17	168.1	68.72	168.1	69.56	168.1	70.35	165.3	67.66
	-11.8	-13	174.6	68.35	174.6	68.96	173.6	69.51	173.6	70.35	173.6	68.55	171.6	65.95
	-9.8	-11	180.4	69.17	180.4	69.81	179.3	70.35	179.3	68.43	179.3	66.64	177.9	64.16
	-9.5	-10	181.4	69.32	181.4	69.93	180.4	70.06	180.4	68.13	180.1	66.35	178.9	63.87
	-8.5	-9.1	185.1	69.72	185.1	70.35	184.1	69.06	184.1	67.15	183.1	65.39	182.1	62.97
	-7.0	-7.6	190.7	70.35	190.7	68.90	189.4	67.58	189.4	65.70	189.4	63.94	187.4	61.63
	-5.0	-5.6	198.1	68.47	198.1	66.95	196.8	65.58	196.8	63.75	196.8	62.03	193.9	59.83
	-3.0	-3.7	205.5	66.58	205.5	65.01	204.2	63.59	204.2	61.80	204.2	60.12	200.5	58.02
	0.0	-0.7	216.5	63.73	216.5	62.09	215.1	60.62	215.1	58.89	215.1	57.25	210.3	55.33
	3.0	2.2	227.6	60.90	227.6	59.15	226.1	57.63	226.1	55.98	224.6	54.36	210.5	52.64
	5.0	4.1	234.3	58.99	234.3	57.21	233.1	55.64	231.9	54.03	226.0	52.45	210.5	50.82
	7.0	6.0	239.9	57.10	239.9	55.25	238.5	53.66	234.3	52.10	226.0	50.54	210.5	49.03
	9.0	7.9	240.9	55.54	240.9	53.74	240.1	52.18	234.3	50.67	226.0	49.17	210.5	47.69
	11.0	9.8	240.9	54.45	240.9	52.70	240.1	51.18	234.3	49.68	226.0	48.20	210.5	46.75
	13.0	11.8	240.9	53.30	240.9	51.57	240.1	50.07	234.3	48.62	226.0	47.18	210.5	45.76
15.0	13.7	240.9	52.05	240.9	50.37	240.1	48.90	234.3	47.47	226.0	46.07	210.5	44.68	
120	-24.8	-25	114.0	63.50	114.0	64.05	113.2	64.87	113.2	65.69	113.2	66.96	111.5	67.84
	-21.8	-22	139.4	64.75	139.4	65.30	138.4	66.14	138.4	66.96	138.4	68.20	136.3	69.10
	-19.8	-20	147.4	65.60	147.4	66.14	146.4	66.99	146.4	67.78	146.4	69.05	144.1	69.93
	-18.8	-19	150.7	66.02	150.7	66.57	149.7	67.41	149.7	68.20	149.7	69.47	147.4	70.35
	-16.7	-17	157.8	66.90	157.8	67.45	156.8	68.29	156.8	69.10	156.8	70.35	154.2	68.62
	-13.7	-15	167.8	68.17	167.8	68.72	166.8	69.56	166.8	70.35	166.8	67.76	164.1	66.14
	-11.8	-13	173.3	68.96	173.3	69.51	172.3	70.35	172.3	68.52	172.3	66.12	170.3	64.58
	-9.8	-11	179.1	69.81	179.1	70.35	178.1	68.33	178.1	66.59	178.1	64.40	176.7	62.92
	-9.5	-10	180.2	69.93	180.2	70.03	179.2	68.04	179.2	66.30	179.2	64.14	177.8	62.66
	-8.5	-9.1	183.9	70.35	183.9	68.96	182.6	67.02	182.6	65.34	182.6	63.29	181.0	61.84
	-7.0	-7.6	189.4	68.76	189.4	67.36	188.2	65.51	188.2	63.89	188.0	61.99	186.1	60.60
	-5.0	-5.6	196.8	66.63	196.8	65.22	195.5	63.49	195.5	61.95	195.5	60.25	192.7	58.94
	-3.0	-3.7	204.0	64.50	204.0	63.10	202.7	61.46	202.7	60.04	202.7	58.53	197.7	57.28
	0.0	-0.7	215.0	61.31	215.0	59.89	213.5	58.43	213.5	57.13	212.3	55.94	197.7	54.80
	3.0	2.2	225.9	58.12	225.9	56.68	223.7	55.40	219.5	54.24	212.7	53.35	197.7	52.33
	5.0	4.1	232.7	55.99	232.2	54.54	227.1	53.39	219.5	52.31	212.7	51.63	197.7	50.67
	7.0	6.0	238.3	53.86	236.6	52.40	227.1	51.37	219.5	50.37	212.7	49.91	197.7	49.01
	9.0	7.9	239.1	52.24	236.6	50.83	227.1	49.84	219.5	48.89	212.7	48.43	197.7	47.55
	11.0	9.8	239.1	51.11	236.6	49.72	227.1	48.73	219.5	47.81	212.7	47.35	197.7	46.51
	13.0	11.8	239.1	49.87	236.6	48.51	227.1	47.57	219.5	46.66	212.7	46.22	197.7	45.40
15.0	13.7	239.1	48.56	236.6	47.24	227.1	46.31	219.5	45.42	212.7	44.99	197.7	44.19	
110	-24.8	-25	113.4	64.05	113.4	64.87	112.7	65.69	112.7	66.96	112.7	67.84	110.8	68.26
	-21.8	-22	138.7	65.30	138.7	66.14	137.7	66.96	137.7	68.20	137.7	69.10	135.6	69.51
	-19.8	-20	146.6	66.14	146.6	66.99	145.7	67.78	145.7	69.05	145.7	69.93	143.3	70.35
	-18.8	-19	149.9	66.57	149.9	67.41	148.9	68.20	148.9	69.47	148.9	70.35	146.6	69.44
	-16.7	-17	157.0	67.45	157.0	68.29	156.0	69.10	156.0	70.35	156.0	68.49	153.4	67.51
	-13.7	-15	166.9	68.72	166.9	69.56	165.8	70.35	165.8	67.52	165.8	65.79	165.8	64.77
	-11.8	-13	172.4	69.51	172.4	70.35	171.3	68.35	171.3	65.71	171.3	64.09	171.3	63.03
	-9.8	-11	178.1	70.35	178.1	68.09	177.1	66.25	177.1	63.82	177.1	62.31	176.5	61.20
	-9.5	-10	179.2	69.98	179.2	67.74	178.2	65.91	178.2	63.53	178.2	62.05	177.6	60.93
	-8.5	-9.1	182.9	68.77	182.9	66.61	181.8	64.86	181.8	62.58	181.8	61.13	177.9	60.00
	-7.0	-7.6	188.4	66.92	188.4	64.92	187.2	63.28	187.2	61.16	187.2	59.80	177.9	58.64
	-5.0	-5.6	195.6	64.48	195.6	62.63	194.3	61.17	194.3	59.27	190.4	58.01	177.9	56.79
	-3.0	-3.7	202.9	62.03	202.9	60.37	201.5	59.04	197.2	57.36	190.4	56.21	177.9	54.97
	0.0	-0.7	213.8	58.35	213.4	56.97	203.7	55.88	197.2	54.52	190.4	53.54	177.9	52.23
	3.0	2.2	224.2	54.68	217.2	53.56	203.7	52.70	197.2	51.69	190.4	50.84	177.9	49.47
	5.0	4.1	229.8	52.22	217.2	51.30	203.7	50.60	197.2	49.78	190.4	49.06	177.9	47.64
	7.0	6.0	229.8	49.76	217.2	49.03	203.7	48.47	197.2	47.88	190.4	47.27	177.9	45.81
	9.0	7.9	229.8	48.07	217.2	47.36	203.7	46.83	197.2	46.25	190.4	45.66	177.9	44.25
	11.0	9.8	229.8	46.80	217.2	46.10	203.7	45.57	197.2	45.01	190.4	44.43	177.9	43.07
	13.0	11.8	229.8	45.41	217.2	44.74	203.7	44.23	197.2	43.70	190.4	43.14	177.9	41.82
15.0	13.7	229.8	43.97	217.2	43.30	203.7	42.81	197.2	42.29	190.4	41.76	177.9	40.46	

# 7. Capacity Tables

Heating Capacity (60HP)

Combination (%)	Outdoor air temp.		Indoor air temp. °C DB											
			16		18		20		21		22		24	
	°C DB	°C WB	TC	PI	TC	PI	TC	PI	TC	PI	TC	PI	TC	PI
100	-24.8	-25	112.9	71.30	112.9	71.18	112.2	66.81	112.2	70.87	112.2	70.74	110.3	70.68
	-21.8	-22	137.9	71.11	137.9	70.99	137.2	68.92	137.2	70.68	137.2	71.56	134.8	70.49
	-19.8	-20	145.9	70.99	145.9	70.85	145.1	70.25	145.1	70.56	145.1	70.76	142.8	70.35
	-18.8	-19	149.2	70.93	148.4	70.80	148.4	70.68	148.4	70.48	148.4	70.35	145.9	69.24
	-16.7	-17	155.3	70.80	155.3	70.67	155.3	71.56	154.5	70.35	154.5	68.05	151.9	66.90
	-13.7	-15	166.1	70.61	166.1	70.47	165.1	70.35	165.1	67.01	165.1	64.75	162.6	63.53
	-11.8	-13	171.6	70.49	170.6	70.35	170.6	68.11	170.6	64.88	170.6	62.65	162.6	61.41
	-9.8	-11	177.1	70.35	177.1	67.84	176.4	65.74	176.4	62.65	174.4	60.46	162.6	59.17
	-9.5	-10	178.2	69.96	178.2	67.45	177.4	65.39	177.4	62.31	174.4	60.12	162.6	58.84
	-8.5	-9.1	181.9	68.64	181.9	66.20	181.1	64.20	180.4	61.19	174.4	59.03	162.6	57.71
	-7.0	-7.6	190.4	66.67	189.7	64.31	186.4	62.42	180.4	59.53	174.4	57.38	162.6	56.03
	-5.0	-5.6	198.7	64.02	196.7	61.80	186.4	60.07	180.4	57.28	174.4	55.18	162.6	53.79
	-3.0	-3.7	204.5	61.39	198.4	59.27	186.4	57.70	180.4	55.04	174.4	52.99	162.6	51.55
	0.0	-0.7	210.2	57.43	198.4	55.50	186.4	54.15	180.4	51.70	174.4	49.68	162.6	48.20
	3.0	2.2	210.2	53.46	198.4	51.71	186.4	50.60	180.4	48.35	174.4	46.38	162.6	44.85
	5.0	4.1	210.2	50.83	198.4	49.20	186.4	48.23	180.4	46.11	174.4	44.18	162.6	42.61
	7.0	6.0	210.2	48.18	198.4	46.67	186.4	45.86	180.4	43.88	174.4	41.98	162.6	40.37
	9.0	7.9	210.2	46.29	198.4	44.83	186.4	44.05	180.4	42.16	174.4	40.34	162.6	38.78
	11.0	9.8	210.2	44.78	198.4	43.38	186.4	42.63	180.4	40.77	174.4	39.01	162.6	37.53
	13.0	11.8	210.2	43.19	198.4	41.82	186.4	41.10	180.4	39.32	174.4	37.62	162.6	36.17
15.0	13.7	210.2	41.50	198.4	40.18	186.4	39.49	180.4	37.77	174.4	36.15	162.6	34.76	
90	-24.8	-25	112.4	63.18	112.4	64.43	111.7	65.33	111.7	65.73	111.7	66.58	110.0	67.85
	-21.8	-22	137.4	64.43	137.4	65.70	136.7	66.58	136.7	67.00	136.7	67.85	134.3	64.91
	-19.8	-20	145.4	65.28	145.4	66.54	144.4	67.42	144.4	67.85	144.4	68.85	142.1	62.95
	-18.8	-19	149.2	65.70	148.4	66.97	147.7	67.85	147.7	66.82	147.7	64.83	145.4	61.98
	-16.7	-17	155.3	66.58	155.3	67.85	154.7	65.71	154.7	64.64	154.7	62.73	148.5	59.92
	-13.7	-15	166.1	67.85	166.1	64.65	164.6	62.65	164.6	61.54	160.0	59.71	148.5	56.98
	-11.8	-13	171.6	65.65	170.6	62.64	169.9	60.70	165.3	59.57	160.0	57.81	148.5	55.12
	-9.8	-11	177.1	63.37	177.1	60.53	170.6	58.67	165.3	57.49	160.0	55.80	148.5	53.16
	-9.5	-10	178.2	63.01	178.2	60.19	170.6	58.36	165.3	57.18	160.0	55.49	148.5	52.86
	-8.5	-9.1	181.9	61.87	180.6	59.14	170.6	57.33	165.3	56.15	160.0	54.49	148.5	51.88
	-7.0	-7.6	190.4	60.14	181.1	57.54	170.6	55.81	165.3	54.59	160.0	52.98	148.5	50.41
	-5.0	-5.6	192.4	57.84	181.1	55.42	170.6	53.78	165.3	52.54	160.0	50.98	148.5	48.47
	-3.0	-3.7	192.4	55.54	181.1	53.31	170.6	51.73	165.3	50.46	160.0	48.96	148.5	46.50
	0.0	-0.7	192.4	52.10	181.1	50.11	170.6	48.67	165.3	47.36	160.0	45.95	148.5	43.57
	3.0	2.2	192.4	48.63	181.1	46.92	170.6	45.61	165.3	44.26	160.0	42.95	148.5	40.62
	5.0	4.1	192.4	46.33	181.1	44.80	170.6	43.57	165.3	42.18	160.0	40.93	148.5	38.65
	7.0	6.0	192.4	44.03	181.1	42.69	170.6	41.54	165.3	40.13	160.0	38.93	148.5	36.71
	9.0	7.9	192.4	41.87	181.1	40.58	170.6	39.49	165.3	38.15	160.0	37.01	148.5	34.91
	11.0	9.8	192.4	39.71	181.1	38.50	170.6	37.45	165.3	36.17	160.0	35.10	148.5	33.09
	13.0	11.8	192.4	37.55	181.1	36.39	170.6	35.42	165.3	34.21	160.0	33.20	148.5	31.29
15.0	13.7	192.4	35.39	181.1	34.30	170.6	33.37	165.3	32.23	160.0	31.27	148.5	29.49	
80	-24.8	-25	111.9	55.49	111.9	56.76	111.2	57.64	111.2	58.06	111.2	60.16	109.5	57.58
	-21.8	-22	135.9	56.76	135.9	58.01	135.9	58.89	135.9	60.16	135.9	57.58	132.7	55.09
	-19.8	-20	143.9	57.59	143.9	58.85	143.9	60.16	143.9	58.34	142.5	55.85	132.7	53.44
	-18.8	-19	147.2	58.01	147.2	60.16	147.2	59.23	147.2	57.42	142.7	54.98	132.7	52.62
	-16.7	-17	152.5	60.16	152.5	58.23	152.5	57.29	148.0	55.51	142.7	53.19	132.7	50.89
	-13.7	-15	159.5	57.30	156.3	55.46	152.5	54.52	148.0	52.77	142.7	50.59	132.7	48.40
	-11.8	-13	163.4	55.47	158.6	53.71	152.5	52.75	148.0	51.03	142.7	48.96	132.7	46.82
	-9.8	-11	167.7	53.56	160.9	51.88	152.5	50.90	148.0	49.22	142.7	47.23	132.7	45.17
	-9.5	-10	168.9	53.28	161.8	51.60	152.5	50.62	148.0	48.94	142.7	46.97	132.7	44.93
	-8.5	-9.1	170.7	52.33	162.6	50.68	152.5	49.70	148.0	48.02	142.7	46.12	132.7	44.10
	-7.0	-7.6	172.4	50.89	162.6	49.29	152.5	48.31	148.0	46.66	142.7	44.83	132.7	42.85
	-5.0	-5.6	172.4	48.98	162.6	47.47	152.5	46.45	148.0	44.82	142.7	43.09	132.7	41.20
	-3.0	-3.7	172.4	47.07	162.6	45.62	152.5	44.60	148.0	43.01	142.7	41.38	132.7	39.54
	0.0	-0.7	172.4	44.19	162.6	42.87	152.5	41.83	148.0	40.27	142.7	38.78	132.7	37.07
	3.0	2.2	172.4	41.33	162.6	40.09	152.5	39.04	148.0	37.51	142.7	36.20	132.7	34.58
	5.0	4.1	172.4	39.42	162.6	38.27	152.5	37.19	148.0	35.70	142.7	34.47	132.7	32.93
	7.0	6.0	172.4	37.52	162.6	36.42	152.5	35.35	148.0	33.88	142.7	32.76	132.7	31.27
	9.0	7.9	172.4	35.22	162.6	34.20	152.5	33.18	148.0	31.81	142.7	30.76	132.7	29.37
	11.0	9.8	172.4	32.69	162.6	31.74	152.5	30.81	148.0	29.52	142.7	28.54	132.7	27.25
	13.0	11.8	172.4	30.52	162.6	29.62	152.5	28.76	148.0	27.56	142.7	26.64	132.7	25.44
15.0	13.7	172.4	28.71	162.6	27.88	152.5	27.05	148.0	25.93	142.7	25.08	132.7	23.95	

# 7. Capacity Tables

Heating Capacity (60HP)

Combination (%)	Outdoor air temp.		Indoor air temp. °C DB													
			16		18		20		21		22		24			
	°C DB	°C WB	TC	PI	TC	PI	TC	PI	TC	PI	TC	PI	TC	PI		
70	-24.8	-25	111.9	56.07	111.9	56.49	111.2	57.34	111.2	58.61	111.2	58.61	111.2	55.81	109.4	53.18
	-21.8	-22	130.7	57.34	130.7	57.76	129.9	58.61	129.9	58.61	125.4	55.81	121.7	53.18	113.6	50.66
	-19.8	-20	143.2	58.19	138.0	58.61	129.9	56.64	125.4	53.94	121.7	51.44	113.6	48.98		
	-18.8	-19	146.0	58.61	138.0	57.59	129.9	55.65	125.4	53.00	121.7	50.56	113.6	48.12		
	-16.7	-17	146.2	56.48	138.0	55.44	129.9	53.60	125.4	51.04	121.7	48.74	113.6	46.36		
	-13.7	-15	146.2	53.48	138.0	52.40	129.9	50.64	125.4	48.25	121.7	46.12	113.6	43.82		
	-11.8	-13	146.2	51.55	138.0	50.47	129.9	48.77	125.4	46.46	121.7	44.45	113.6	42.23		
	-9.8	-11	146.2	49.55	138.0	48.43	129.9	46.82	125.4	44.59	121.7	42.71	113.6	40.54		
	-9.5	-10	146.2	49.24	138.0	48.12	129.9	46.52	125.4	44.32	121.7	42.46	113.6	40.29		
	-8.5	-9.1	146.2	48.25	138.0	47.11	129.9	45.53	125.4	43.38	121.7	41.58	113.6	39.44		
	-7.0	-7.6	146.2	46.73	138.0	45.59	129.9	44.06	125.4	41.99	121.7	40.27	113.6	38.18		
	-5.0	-5.6	146.2	44.72	138.0	43.56	129.9	42.09	125.4	40.12	121.7	38.52	113.6	36.49		
	-3.0	-3.7	146.2	42.72	138.0	41.51	129.9	40.12	125.4	38.25	121.7	36.78	113.6	34.80		
	0.0	-0.7	146.2	39.70	138.0	38.47	129.9	37.18	125.4	35.45	121.7	34.16	113.6	32.28		
	3.0	2.2	146.2	36.68	138.0	35.42	129.9	34.22	125.4	32.67	121.7	31.54	113.6	29.74		
	5.0	4.1	146.2	34.67	138.0	33.37	129.9	32.27	125.4	30.80	121.7	29.79	113.6	28.06		
	7.0	6.0	146.2	32.66	138.0	31.35	129.9	30.30	125.4	28.93	121.7	28.05	113.6	26.37		
	9.0	7.9	146.2	29.49	138.0	28.30	129.9	27.37	125.4	26.12	121.7	25.34	113.6	23.81		
11.0	9.8	146.2	27.47	138.0	26.35	129.9	25.47	125.4	24.32	121.7	23.59	113.6	22.17			
13.0	11.8	146.2	25.69	138.0	24.66	129.9	23.83	125.4	22.76	121.7	22.07	113.6	20.76			
15.0	13.7	146.2	24.22	138.0	23.25	129.9	22.47	125.4	21.44	121.7	20.81	113.6	19.56			
60	-24.8	-25	111.3	55.22	111.3	56.07	110.6	57.34	107.6	54.37	103.9	51.59	97.3	48.97		
	-21.8	-22	119.7	56.49	118.7	57.34	111.4	54.37	107.6	51.59	103.9	48.97	97.3	46.45		
	-19.8	-20	125.4	57.34	118.7	55.24	111.4	52.39	107.6	49.74	103.9	47.22	97.3	44.76		
	-18.8	-19	125.4	56.29	118.7	54.19	111.4	51.39	107.6	48.79	103.9	46.35	97.3	43.91		
	-16.7	-17	125.4	54.06	118.7	51.98	111.4	49.32	107.6	46.85	103.9	44.53	97.3	42.14		
	-13.7	-15	125.4	50.87	118.7	48.85	111.4	46.36	107.6	44.07	103.9	41.91	97.3	39.62		
	-11.8	-13	125.4	48.87	118.7	46.85	111.4	44.46	107.6	42.30	103.9	40.26	97.3	38.03		
	-9.8	-11	125.4	46.76	118.7	44.75	111.4	42.49	107.6	40.45	103.9	38.51	97.3	36.33		
	-9.5	-10	125.4	46.43	118.7	44.45	111.4	42.19	107.6	40.17	103.9	38.24	97.3	36.08		
	-8.5	-9.1	125.4	45.38	118.7	43.40	111.4	41.21	107.6	39.25	103.9	37.36	97.3	35.24		
	-7.0	-7.6	125.4	43.80	118.7	41.82	111.4	39.73	107.6	37.85	103.9	36.06	97.3	33.97		
	-5.0	-5.6	125.4	41.67	118.7	39.72	111.4	37.74	107.6	36.00	103.9	34.32	97.3	32.29		
	-3.0	-3.7	125.4	39.56	118.7	37.62	111.4	35.76	107.6	34.15	103.9	32.57	97.3	30.60		
	0.0	-0.7	125.4	36.38	118.7	34.48	111.4	32.81	107.6	31.35	103.9	29.95	97.3	28.08		
	3.0	2.2	125.4	33.20	118.7	31.33	111.4	29.83	107.6	28.58	103.9	27.35	97.3	25.54		
	5.0	4.1	125.4	31.09	118.7	29.23	111.4	27.86	107.6	26.73	103.9	25.60	97.3	23.87		
	7.0	6.0	125.4	28.98	118.7	27.13	111.4	25.88	107.6	24.86	103.9	23.86	97.3	22.17		
	9.0	7.9	125.4	25.86	118.7	24.22	111.4	23.08	107.6	22.18	103.9	21.27	97.3	19.78		
11.0	9.8	125.4	24.13	118.7	22.61	111.4	21.56	107.6	20.71	103.9	19.88	97.3	18.47			
13.0	11.8	125.4	22.61	118.7	21.17	111.4	20.20	107.6	19.40	103.9	18.61	97.3	17.32			
15.0	13.7	125.4	21.37	118.7	20.03	111.4	19.08	107.6	18.34	103.9	17.59	97.3	16.37			
50	-24.8	-25	104.6	48.68	98.6	49.95	92.8	47.30	89.8	44.82	86.8	42.48	80.8	40.31		
	-21.8	-22	104.6	49.95	98.6	47.30	92.8	44.82	89.8	42.48	86.8	40.31	80.8	38.22		
	-19.8	-20	104.6	48.10	98.6	45.53	92.8	43.18	89.8	40.91	86.8	38.85	80.8	36.81		
	-18.8	-19	104.6	47.17	98.6	44.64	92.8	42.35	89.8	40.15	86.8	38.12	80.8	36.11		
	-16.7	-17	104.6	45.24	98.6	42.80	92.8	40.63	89.8	38.51	86.8	36.60	80.8	34.65		
	-13.7	-15	104.6	42.48	98.6	40.14	92.8	38.15	89.8	36.17	86.8	34.43	80.8	32.56		
	-11.8	-13	104.6	40.73	98.6	38.47	92.8	36.58	89.8	34.68	86.8	33.05	80.8	31.23		
	-9.8	-11	104.6	38.88	98.6	36.70	92.8	34.92	89.8	33.12	86.8	31.59	80.8	29.82		
	-9.5	-10	104.6	38.60	98.6	36.45	92.8	34.69	89.8	32.89	86.8	31.39	80.8	29.62		
	-8.5	-9.1	104.6	37.66	98.6	35.56	92.8	33.86	89.8	32.11	86.8	30.66	80.8	28.92		
	-7.0	-7.6	104.6	36.29	98.6	34.25	92.8	32.62	89.8	30.95	86.8	29.57	80.8	27.88		
	-5.0	-5.6	104.6	34.44	98.6	32.48	92.8	30.98	89.8	29.38	86.8	28.11	80.8	26.48		
	-3.0	-3.7	104.6	32.59	98.6	30.71	92.8	29.31	89.8	27.82	86.8	26.65	80.8	25.09		
	0.0	-0.7	104.6	29.83	98.6	28.05	92.8	26.84	89.8	25.48	86.8	24.48	80.8	22.98		
	3.0	2.2	104.6	27.07	98.6	25.42	92.8	24.38	89.8	23.13	86.8	22.31	80.8	20.89		
	5.0	4.1	104.6	25.22	98.6	23.65	92.8	22.72	89.8	21.59	86.8	20.85	80.8	19.51		
	7.0	6.0	104.6	23.37	98.6	21.88	92.8	21.08	89.8	20.03	86.8	19.39	80.8	18.10		
	9.0	7.9	104.6	21.10	98.6	19.76	92.8	19.03	89.8	18.08	86.8	17.52	80.8	16.34		
11.0	9.8	104.6	19.74	98.6	18.49	92.8	17.81	89.8	16.93	86.8	16.39	80.8	15.29			
13.0	11.8	104.6	18.54	98.6	17.37	92.8	16.71	89.8	15.88	86.8	15.39	80.8	14.37			
15.0	13.7	104.6	17.54	98.6	16.42	92.8	15.83	89.8	15.03	86.8	14.56	80.8	13.59			

**Note**

1. TC: Total Capacity(kW), PI : Power Input(kW, Comp. + Outdoor fan motor)
2. Capacity tables show the average value of conditions which may occur.
3. The heating capacity table is based on the values expressed as Max. in the specification of the outdoor unit. (When measuring the Max. heating capacity, the setting status of the indoor unit is the same as that for measuring the heating capacity of the indoor unit.)

# 7. Capacity Tables

## ◆ ARUM620LTE5

Heating Capacity (62HP)

Combination (%)	Outdoor air temp.		Indoor air temp. °C DB											
			16		18		20		21		22		24	
	°C DB	°C WB	TC	PI	TC	PI	TC	PI	TC	PI	TC	PI	TC	PI
130	-24.8	-25	118.1	64.5	118.1	65.06	117.4	65.54	117.4	66.26	117.4	66.97	115.2	68.08
	-21.8	-22	145.3	65.60	145.3	66.15	144.2	66.63	144.2	67.37	144.2	68.08	141.4	69.17
	-19.8	-20	153.9	66.34	153.9	66.89	152.9	67.37	152.9	68.11	152.9	68.80	150.0	69.91
	-18.8	-19	157.5	66.71	157.5	67.26	156.5	67.74	156.5	68.48	156.5	69.17	153.4	70.28
	-16.7	-17	164.9	67.48	164.9	68.03	163.8	68.51	163.8	69.25	163.8	69.96	160.7	71.05
	-13.7	-15	175.3	68.59	175.3	69.14	174.3	69.62	174.3	70.36	174.3	71.05	170.9	68.47
	-11.8	-13	181.0	69.30	181.0	69.83	180.0	70.31	180.0	71.05	180.0	69.33	177.4	66.83
	-9.8	-11	187.0	70.02	187.0	70.57	185.9	71.05	185.9	69.23	185.9	67.51	184.2	65.11
	-9.5	-10	188.1	70.15	188.1	70.68	187.0	70.77	187.0	68.95	186.8	67.23	185.3	64.83
	-8.5	-9.1	191.7	70.50	191.7	71.05	190.6	69.84	190.6	68.01	189.8	66.32	188.7	63.97
	-7.0	-7.6	197.1	71.05	197.1	69.71	195.8	68.44	195.8	66.64	195.8	64.93	193.7	62.68
	-5.0	-5.6	204.4	69.32	204.4	67.88	203.1	66.57	203.1	64.80	203.1	63.11	200.5	60.96
	-3.0	-3.7	211.6	67.60	211.6	66.08	210.3	64.70	210.3	62.95	210.3	61.29	207.3	59.22
	0.0	-0.7	222.5	64.99	222.5	63.37	221.0	61.91	221.0	60.19	221.0	58.55	217.4	56.64
	3.0	2.2	233.4	62.40	233.4	60.64	231.8	59.10	231.8	57.43	231.8	55.80	217.6	54.05
	5.0	4.1	240.4	60.65	240.4	58.83	239.1	57.23	239.1	55.59	233.7	53.98	217.6	52.31
	7.0	6.0	247.7	58.92	247.7	57.01	246.1	55.37	242.2	53.76	233.7	52.15	217.6	50.59
	9.0	7.9	249.0	57.50	249.0	55.64	248.2	54.03	242.2	52.47	233.7	50.91	217.6	49.37
	11.0	9.8	249.0	56.58	249.0	54.77	248.2	53.18	242.2	51.63	233.7	50.09	217.6	48.58
	13.0	11.8	249.0	55.61	249.0	53.80	248.2	52.24	242.2	50.73	233.7	49.22	217.6	47.74
15.0	13.7	249.0	54.54	249.0	52.78	248.2	51.25	242.2	49.74	233.7	48.28	217.6	46.82	
120	-24.8	-25	117.3	65.06	117.3	65.54	116.6	66.26	116.6	66.97	116.6	68.08	114.4	68.85
	-21.8	-22	144.2	66.15	144.2	66.63	143.2	67.37	143.2	68.08	143.2	69.17	140.6	69.96
	-19.8	-20	152.8	66.89	152.8	67.37	151.8	68.11	151.8	68.80	151.8	69.91	148.9	70.68
	-18.8	-19	156.3	67.26	156.3	67.74	155.2	68.48	155.2	69.17	155.2	70.28	152.3	71.05
	-16.7	-17	163.6	68.03	163.6	68.51	162.6	69.25	162.6	69.96	162.6	71.05	159.4	69.38
	-13.7	-15	174.0	69.14	174.0	69.62	173.0	70.36	173.0	71.05	173.0	68.57	169.6	67.00
	-11.8	-13	179.7	69.83	179.7	70.31	178.7	71.05	178.7	69.30	178.7	67.00	176.1	65.51
	-9.8	-11	185.7	70.57	185.7	71.05	184.6	69.13	184.6	67.46	184.6	65.36	182.9	63.92
	-9.5	-10	186.8	70.68	186.8	70.75	185.7	68.85	185.7	67.18	185.7	65.11	184.0	63.67
	-8.5	-9.1	190.4	71.05	190.4	69.74	189.1	67.89	189.1	66.27	189.1	64.29	187.2	62.88
	-7.0	-7.6	195.8	69.56	195.8	68.22	194.5	66.45	194.5	64.88	194.5	63.06	192.4	61.69
	-5.0	-5.6	203.0	67.56	203.0	66.19	201.7	64.52	201.7	63.03	201.7	61.39	199.2	60.10
	-3.0	-3.7	210.1	65.56	210.1	64.19	208.8	62.60	208.8	61.21	208.8	59.74	204.4	58.51
	0.0	-0.7	220.9	62.57	220.9	61.15	219.4	59.72	219.4	58.43	219.4	57.27	204.4	56.13
	3.0	2.2	231.6	59.57	231.6	58.11	230.2	56.83	227.0	55.67	219.9	54.79	204.4	53.75
	5.0	4.1	238.8	57.57	238.8	56.09	234.7	54.93	227.0	53.82	219.9	53.14	204.4	52.16
	7.0	6.0	246.1	55.57	244.5	54.07	234.7	53.01	227.0	51.98	219.9	51.50	204.4	50.57
	9.0	7.9	247.1	54.08	244.5	52.62	234.7	51.59	227.0	50.61	219.9	50.13	204.4	49.22
	11.0	9.8	247.1	53.09	244.5	51.65	234.7	50.62	227.0	49.66	219.9	49.19	204.4	48.31
	13.0	11.8	247.1	52.00	244.5	50.59	234.7	49.60	227.0	48.65	219.9	48.19	204.4	47.34
15.0	13.7	247.1	50.85	244.5	49.46	234.7	48.49	227.0	47.56	219.9	47.10	204.4	46.27	
110	-24.8	-25	116.8	65.54	116.8	66.26	116.0	66.97	116.0	68.08	116.0	68.85	113.7	69.22
	-21.8	-22	143.4	66.63	143.4	67.37	142.4	68.08	142.4	69.17	142.4	69.96	139.8	70.31
	-19.8	-20	152.1	67.37	152.1	68.11	151.0	68.80	151.0	69.91	151.0	70.68	148.2	71.05
	-18.8	-19	155.5	67.74	155.5	68.48	154.4	69.17	154.4	70.28	154.4	71.05	151.6	70.17
	-16.7	-17	162.8	68.51	162.8	69.25	161.8	69.96	161.8	71.05	161.8	69.25	158.6	68.30
	-13.7	-15	173.0	69.62	173.0	70.36	172.0	71.05	172.0	68.32	172.0	66.65	172.0	65.64
	-11.8	-13	178.7	70.31	178.7	71.05	177.7	69.13	177.7	66.58	177.7	65.01	177.7	63.95
	-9.8	-11	184.7	71.05	184.7	68.88	183.6	67.10	183.6	64.75	183.6	63.29	183.0	62.18
	-9.5	-10	185.7	70.70	185.7	68.55	184.7	66.78	184.7	64.48	184.7	63.03	183.9	61.92
	-8.5	-9.1	189.3	69.53	189.3	67.46	188.3	65.77	188.3	63.57	188.3	62.15	183.9	61.02
	-7.0	-7.6	194.8	67.76	194.8	65.84	193.5	64.25	193.5	62.20	193.5	60.86	183.9	59.70
	-5.0	-5.6	201.8	65.43	201.8	63.64	200.5	62.22	200.5	60.38	196.9	59.14	183.9	57.91
	-3.0	-3.7	209.0	63.08	209.0	61.47	207.7	60.18	203.8	58.54	196.9	57.40	183.9	56.14
	0.0	-0.7	219.7	59.57	219.7	58.20	210.6	57.14	203.8	55.80	196.9	54.82	183.9	53.49
	3.0	2.2	230.3	56.05	224.6	54.94	210.6	54.08	203.8	53.07	196.9	52.22	183.9	50.81
	5.0	4.1	237.5	53.70	224.6	52.77	210.6	52.06	203.8	51.23	196.9	50.50	183.9	49.04
	7.0	6.0	237.6	51.35	224.6	50.59	210.6	50.01	203.8	49.41	196.9	48.78	183.9	47.27
	9.0	7.9	237.6	49.75	224.6	49.02	210.6	48.47	203.8	47.87	196.9	47.26	183.9	45.80
	11.0	9.8	237.6	48.61	224.6	47.88	210.6	47.33	203.8	46.75	196.9	46.15	183.9	44.73
	13.0	11.8	237.6	47.34	224.6	46.64	210.6	46.11	203.8	45.55	196.9	44.97	183.9	43.59
15.0	13.7	237.6	46.02	224.6	45.32	210.6	44.81	203.8	44.26	196.9	43.71	183.9	42.35	

# 7. Capacity Tables

Heating Capacity (62HP)

Combination (%)	Outdoor air temp.		Indoor air temp. °C DB											
			16		18		20		21		22		24	
	°C DB	°C WB	TC	PI	TC	PI	TC	PI	TC	PI	TC	PI	TC	PI
100	-24.8	-25	116.3	72.63	116.3	72.43	115.5	67.75	115.5	71.91	115.5	71.69	113.2	71.59
	-21.8	-22	142.7	72.31	142.7	72.11	141.9	69.88	141.9	71.59	141.9	72.36	139.1	71.27
	-19.8	-20	151.3	72.11	151.3	71.89	150.5	71.22	150.5	71.39	150.5	71.49	147.6	71.05
	-18.8	-19	154.7	72.01	153.9	71.79	153.9	71.59	153.9	71.27	153.9	71.05	150.8	69.96
	-16.7	-17	161.0	71.79	161.0	71.57	161.0	72.36	160.2	71.05	160.2	68.80	157.1	67.66
	-13.7	-15	172.2	71.47	172.2	71.25	171.2	71.05	171.2	67.79	171.2	65.57	168.1	64.36
	-11.8	-13	177.9	71.27	176.9	71.05	176.9	68.88	176.9	65.72	176.9	63.52	168.1	62.29
	-9.8	-11	183.7	71.05	183.7	68.62	182.8	66.58	182.8	63.55	180.3	61.38	168.1	60.09
	-9.5	-10	184.7	70.67	184.7	68.25	183.9	66.25	183.9	63.22	180.3	61.05	168.1	59.76
	-8.5	-9.1	188.3	69.41	188.3	67.03	187.5	65.09	186.5	62.13	180.3	59.99	168.1	58.65
	-7.0	-7.6	196.9	67.51	196.1	65.21	192.7	63.37	186.5	60.51	180.3	58.37	168.1	57.01
	-5.0	-5.6	205.4	64.96	203.4	62.78	192.7	61.09	186.5	58.32	180.3	56.22	168.1	54.81
	-3.0	-3.7	211.4	62.43	205.1	60.33	192.7	58.79	186.5	56.15	180.3	54.08	168.1	52.62
	0.0	-0.7	217.3	58.61	205.1	56.69	192.7	55.35	186.5	52.89	180.3	50.84	168.1	49.33
	3.0	2.2	217.3	54.79	205.1	53.03	192.7	51.92	186.5	49.63	180.3	47.61	168.1	46.05
	5.0	4.1	217.3	52.26	205.1	50.60	192.7	49.62	186.5	47.45	180.3	45.46	168.1	43.85
	7.0	6.0	217.3	49.71	205.1	48.15	192.7	47.32	186.5	45.28	180.3	43.32	168.1	41.66
	9.0	7.9	217.3	47.94	205.1	46.43	192.7	45.63	186.5	43.66	180.3	41.77	168.1	40.17
	11.0	9.8	217.3	46.57	205.1	45.11	192.7	44.33	186.5	42.40	180.3	40.56	168.1	39.03
	13.0	11.8	217.3	45.12	205.1	43.69	192.7	42.93	186.5	41.08	180.3	39.29	168.1	37.79
15.0	13.7	217.3	43.57	205.1	42.19	192.7	41.46	186.5	39.66	180.3	37.95	168.1	36.49	
90	-24.8	-25	115.8	64.53	115.8	65.62	115.0	66.41	115.0	66.76	115.0	67.50	112.9	68.61
	-21.8	-22	142.2	65.62	142.2	66.73	141.4	67.50	141.4	67.87	141.4	68.61	138.5	65.71
	-19.8	-20	150.8	66.36	150.8	67.47	149.8	68.24	149.8	68.61	149.8	66.62	146.9	63.78
	-18.8	-19	154.7	66.73	153.9	67.84	153.2	68.61	153.2	67.60	153.2	65.64	150.3	62.82
	-16.7	-17	161.0	67.50	161.0	68.61	160.4	66.52	160.4	65.46	160.4	63.58	153.5	60.78
	-13.7	-15	172.2	68.61	172.2	65.49	170.7	63.52	170.7	62.42	165.4	60.61	153.5	57.89
	-11.8	-13	177.9	66.47	176.9	63.53	176.1	61.62	170.9	60.48	165.4	58.74	153.5	56.05
	-9.8	-11	183.7	64.25	183.7	61.46	176.4	59.63	170.9	58.45	165.4	56.76	153.5	54.11
	-9.5	-10	184.7	63.90	184.7	61.14	176.4	59.32	170.9	58.14	165.4	56.46	153.5	53.81
	-8.5	-9.1	188.3	62.80	187.0	60.10	176.4	58.32	170.9	57.13	165.4	55.47	153.5	52.86
	-7.0	-7.6	196.9	61.11	187.3	58.55	176.4	56.83	170.9	55.60	165.4	53.99	153.5	51.40
	-5.0	-5.6	199.0	58.87	187.3	56.48	176.4	54.84	170.9	53.58	165.4	52.02	153.5	49.48
	-3.0	-3.7	199.0	56.63	187.3	54.41	176.4	52.83	170.9	51.55	165.4	50.04	153.5	47.54
	0.0	-0.7	199.0	53.28	187.3	51.30	176.4	49.84	170.9	48.50	165.4	47.07	153.5	44.65
	3.0	2.2	199.0	49.91	187.3	48.18	176.4	46.84	170.9	45.46	165.4	44.12	153.5	41.73
	5.0	4.1	199.0	47.67	187.3	46.11	176.4	44.85	170.9	43.42	165.4	42.14	153.5	39.80
	7.0	6.0	199.0	45.43	187.3	44.05	176.4	42.86	170.9	41.40	165.4	40.17	153.5	37.88
	9.0	7.9	199.0	43.32	187.3	41.98	176.4	40.85	170.9	39.47	165.4	38.29	153.5	36.12
	11.0	9.8	199.0	41.20	187.3	39.94	176.4	38.86	170.9	37.53	165.4	36.42	153.5	34.33
	13.0	11.8	199.0	39.09	187.3	37.88	176.4	36.87	170.9	35.61	165.4	34.56	153.5	32.57
15.0	13.7	199.0	36.97	187.3	35.84	176.4	34.86	170.9	33.68	165.4	32.67	153.5	30.81	
80	-24.8	-25	115.3	56.75	115.3	57.86	114.5	58.63	114.5	59.00	114.5	60.83	112.4	58.29
	-21.8	-22	140.6	57.86	140.6	58.95	140.6	59.72	140.6	60.83	140.6	58.29	137.2	55.83
	-19.8	-20	149.2	58.58	149.2	59.69	149.2	60.83	149.2	59.04	147.5	56.58	137.2	54.19
	-18.8	-19	152.6	58.95	152.6	60.83	152.6	59.93	152.6	58.14	147.5	55.73	137.2	53.38
	-16.7	-17	157.7	60.83	157.7	58.95	157.7	58.02	153.0	56.25	147.5	53.96	137.2	51.67
	-13.7	-15	164.9	58.04	161.6	56.23	157.7	55.30	153.0	53.56	147.5	51.40	137.2	49.21
	-11.8	-13	168.9	56.25	163.9	54.52	157.7	53.56	153.0	51.85	147.5	49.78	137.2	47.65
	-9.8	-11	173.3	54.39	166.3	52.73	157.7	51.75	153.0	50.06	147.5	48.08	137.2	46.01
	-9.5	-10	174.6	54.11	167.3	52.45	157.7	51.47	153.0	49.78	147.5	47.82	137.2	45.78
	-8.5	-9.1	176.4	53.18	168.0	51.55	157.7	50.56	153.0	48.88	147.5	46.99	137.2	44.95
	-7.0	-7.6	178.2	51.77	168.0	50.19	157.7	49.20	153.0	47.54	147.5	45.71	137.2	43.72
	-5.0	-5.6	178.2	49.91	168.0	48.40	157.7	47.37	153.0	45.73	147.5	44.00	137.2	42.08
	-3.0	-3.7	178.2	48.05	168.0	46.59	157.7	45.56	153.0	43.94	147.5	42.31	137.2	40.45
	0.0	-0.7	178.2	45.23	168.0	43.89	157.7	42.84	153.0	41.25	147.5	39.74	137.2	38.01
	3.0	2.2	178.2	42.44	168.0	41.18	157.7	40.10	153.0	38.54	147.5	37.20	137.2	35.54
	5.0	4.1	178.2	40.57	168.0	39.39	157.7	38.28	153.0	36.75	147.5	35.49	137.2	33.91
	7.0	6.0	178.2	38.71	168.0	37.58	157.7	36.47	153.0	34.96	147.5	33.80	137.2	32.27
	9.0	7.9	178.2	36.34	168.0	35.29	157.7	34.23	153.0	32.82	147.5	31.74	137.2	30.30
	11.0	9.8	178.2	33.73	168.0	32.75	157.7	31.79	153.0	30.46	147.5	29.45	137.2	28.12
	13.0	11.8	178.2	31.49	168.0	30.56	157.7	29.67	153.0	28.44	147.5	27.49	137.2	26.25
15.0	13.7	178.2	29.63	168.0	28.77	157.7	27.92	153.0	26.76	147.5	25.88	137.2	24.72	

# 7. Capacity Tables

Heating Capacity (62HP)

Combination (%)	Outdoor air temp.		Indoor air temp. °C DB											
			16		18		20		21		22		24	
	°C DB	°C WB	TC	PI	TC	PI	TC	PI	TC	PI	TC	PI	TC	PI
70	-24.8	-25	115.3	57.20	115.3	57.57	114.5	58.31	114.5	59.42	114.5	56.63	112.4	54.01
	-21.8	-22	135.1	58.31	135.1	58.68	134.3	59.42	129.7	56.63	125.8	54.01	117.5	51.49
	-19.8	-20	148.4	59.05	142.7	59.42	134.3	57.46	129.7	54.77	125.8	52.28	117.5	49.81
	-18.8	-19	151.2	59.42	142.7	58.41	134.3	56.48	129.7	53.84	125.8	51.40	117.5	48.95
	-16.7	-17	151.2	57.31	142.7	56.28	134.3	54.44	129.7	51.88	125.8	49.58	117.5	47.19
	-13.7	-15	151.2	54.34	142.7	53.26	134.3	51.50	129.7	49.10	125.8	46.97	117.5	44.65
	-11.8	-13	151.2	52.43	142.7	51.34	134.3	49.63	129.7	47.32	125.8	45.31	117.5	43.06
	-9.8	-11	151.2	50.44	142.7	49.31	134.3	47.69	129.7	45.46	125.8	43.57	117.5	41.38
	-9.5	-10	151.2	50.14	142.7	49.01	134.3	47.39	129.7	45.18	125.8	43.31	117.5	41.13
	-8.5	-9.1	151.2	49.15	142.7	48.00	134.3	46.41	129.7	44.25	125.8	42.44	117.5	40.27
	-7.0	-7.6	151.2	47.65	142.7	46.49	134.3	44.95	129.7	42.86	125.8	41.13	117.5	39.01
	-5.0	-5.6	151.2	45.66	142.7	44.47	134.3	42.99	129.7	41.00	125.8	39.39	117.5	37.33
	-3.0	-3.7	151.2	43.67	142.7	42.44	134.3	41.03	129.7	39.14	125.8	37.65	117.5	35.64
	0.0	-0.7	151.2	40.67	142.7	39.42	134.3	38.11	129.7	36.35	125.8	35.04	117.5	33.12
	3.0	2.2	151.2	37.68	142.7	36.39	134.3	35.16	129.7	33.57	125.8	32.42	117.5	30.58
	5.0	4.1	151.2	35.69	142.7	34.36	134.3	33.22	129.7	31.71	125.8	30.68	117.5	28.90
	7.0	6.0	151.2	33.70	142.7	32.34	134.3	31.26	129.7	29.85	125.8	28.95	117.5	27.21
	9.0	7.9	151.2	30.43	142.7	29.20	134.3	28.24	129.7	26.96	125.8	26.15	117.5	24.57
	11.0	9.8	151.2	28.34	142.7	27.19	134.3	26.28	129.7	25.09	125.8	24.34	117.5	22.88
	13.0	11.8	151.2	26.51	142.7	25.45	134.3	24.59	129.7	23.48	125.8	22.78	117.5	21.42
15.0	13.7	151.2	24.99	142.7	23.99	134.3	23.18	129.7	22.13	125.8	21.47	117.5	20.19	
60	-24.8	-25	115.1	56.46	115.1	57.20	114.3	58.31	111.3	55.32	107.4	52.53	100.6	49.89
	-21.8	-22	123.8	57.57	122.7	58.31	115.1	55.32	111.3	52.53	107.4	49.89	100.6	47.35
	-19.8	-20	129.7	58.31	122.7	56.20	115.1	53.34	111.3	50.67	107.4	48.14	100.6	45.65
	-18.8	-19	129.7	57.26	122.7	55.15	115.1	52.33	111.3	49.72	107.4	47.26	100.6	44.79
	-16.7	-17	129.7	55.02	122.7	52.94	115.1	50.25	111.3	47.76	107.4	45.42	100.6	43.01
	-13.7	-15	129.7	51.83	122.7	49.79	115.1	47.28	111.3	44.97	107.4	42.78	100.6	40.47
	-11.8	-13	129.7	49.82	122.7	47.79	115.1	45.38	111.3	43.19	107.4	41.12	100.6	38.86
	-9.8	-11	129.7	47.71	122.7	45.68	115.1	43.39	111.3	41.33	107.4	39.36	100.6	37.15
	-9.5	-10	129.7	47.39	122.7	45.37	115.1	43.09	111.3	41.05	107.4	39.09	100.6	36.90
	-8.5	-9.1	129.7	46.33	122.7	44.32	115.1	42.11	111.3	40.12	107.4	38.21	100.6	36.05
	-7.0	-7.6	129.7	44.75	122.7	42.74	115.1	40.62	111.3	38.71	107.4	36.90	100.6	34.77
	-5.0	-5.6	129.7	42.61	122.7	40.63	115.1	38.62	111.3	36.85	107.4	35.15	100.6	33.08
	-3.0	-3.7	129.7	40.50	122.7	38.52	115.1	36.63	111.3	34.99	107.4	33.39	100.6	31.37
	0.0	-0.7	129.7	37.31	122.7	35.37	115.1	33.66	111.3	32.18	107.4	30.75	100.6	28.83
	3.0	2.2	129.7	34.12	122.7	32.21	115.1	30.67	111.3	29.39	107.4	28.13	100.6	26.27
	5.0	4.1	129.7	32.01	122.7	30.10	115.1	28.69	111.3	27.53	107.4	26.37	100.6	24.59
	7.0	6.0	129.7	29.90	122.7	27.99	115.1	26.70	111.3	25.65	107.4	24.62	100.6	22.88
	9.0	7.9	129.7	26.68	122.7	24.99	115.1	23.81	111.3	22.88	107.4	21.95	100.6	20.41
	11.0	9.8	129.7	24.90	122.7	23.33	115.1	22.25	111.3	21.37	107.4	20.51	100.6	19.06
	13.0	11.8	129.7	23.33	122.7	21.85	115.1	20.84	111.3	20.01	107.4	19.21	100.6	17.87
15.0	13.7	129.7	22.05	122.7	20.66	115.1	19.68	111.3	18.93	107.4	18.15	100.6	16.89	
50	-24.8	-25	108.2	49.40	102.0	50.51	95.9	47.87	92.8	45.40	89.7	43.07	83.5	40.90
	-21.8	-22	108.2	50.51	102.0	47.87	95.9	45.40	92.8	43.07	89.7	40.90	83.5	38.81
	-19.8	-20	108.2	48.68	102.0	46.11	95.9	43.77	92.8	41.51	89.7	39.44	83.5	37.40
	-18.8	-19	108.2	47.75	102.0	45.23	95.9	42.94	92.8	40.75	89.7	38.71	83.5	36.70
	-16.7	-17	108.2	45.83	102.0	43.39	95.9	41.22	92.8	39.11	89.7	37.20	83.5	35.24
	-13.7	-15	108.2	43.09	102.0	40.75	95.9	38.76	92.8	36.77	89.7	35.03	83.5	33.15
	-11.8	-13	108.2	41.35	102.0	39.09	95.9	37.20	92.8	35.29	89.7	33.65	83.5	31.81
	-9.8	-11	108.2	39.51	102.0	37.33	95.9	35.54	92.8	33.73	89.7	32.19	83.5	30.41
	-9.5	-10	108.2	39.24	102.0	37.07	95.9	35.31	92.8	33.50	89.7	31.99	83.5	30.20
	-8.5	-9.1	108.2	38.31	102.0	36.19	95.9	34.48	92.8	32.72	89.7	31.26	83.5	29.50
	-7.0	-7.6	108.2	36.95	102.0	34.88	95.9	33.25	92.8	31.56	89.7	30.18	83.5	28.47
	-5.0	-5.6	108.2	35.11	102.0	33.12	95.9	31.61	92.8	30.00	89.7	28.72	83.5	27.06
	-3.0	-3.7	108.2	33.27	102.0	31.36	95.9	29.95	92.8	28.44	89.7	27.26	83.5	25.67
	0.0	-0.7	108.2	30.53	102.0	28.72	95.9	27.49	92.8	26.10	89.7	25.09	83.5	23.56
	3.0	2.2	108.2	27.79	102.0	26.10	95.9	25.04	92.8	23.76	89.7	22.93	83.5	21.47
	5.0	4.1	108.2	25.95	102.0	24.34	95.9	23.38	92.8	22.22	89.7	21.47	83.5	20.08
	7.0	6.0	108.2	24.11	102.0	22.58	95.9	21.75	92.8	20.66	89.7	20.01	83.5	18.68
	9.0	7.9	108.2	21.77	102.0	20.39	95.9	19.63	92.8	18.65	89.7	18.07	83.5	16.86
	11.0	9.8	108.2	20.37	102.0	19.08	95.9	18.37	92.8	17.47	89.7	16.91	83.5	15.78
	13.0	11.8	108.2	19.13	102.0	17.92	95.9	17.24	92.8	16.39	89.7	15.88	83.5	14.82
15.0	13.7	108.2	18.10	102.0	16.94	95.9	16.33	92.8	15.51	89.7	15.03	83.5	14.02	

**Note**

1. TC: Total Capacity(kW), PI : Power Input(kW, Comp. + Outdoor fan motor)
2. Capacity tables show the average value of conditions which may occur.
3. The heating capacity table is based on the values expressed as Max. in the specification of the outdoor unit. (When measuring the Max. heating capacity, the setting status of the indoor unit is the same as that for measuring the heating capacity of the indoor unit.)



# 7. Capacity Tables

## ◆ ARUM640LTE5

Heating Capacity (64HP)

Combination (%)	Outdoor air temp.		Indoor air temp. °C DB											
			16		18		20		21		22		24	
	°C DB	°C WB	TC	PI	TC	PI	TC	PI	TC	PI	TC	PI	TC	PI
130	-24.8	-25	119.5	66.2	119.5	66.94	118.7	67.54	118.7	68.45	118.7	69.33	117.1	70.73
	-21.8	-22	147.2	67.62	147.2	68.31	146.2	68.91	146.2	69.84	146.2	70.73	144.0	72.10
	-19.8	-20	156.1	68.54	156.1	69.24	155.1	69.84	155.1	70.76	155.1	71.63	152.9	73.02
	-18.8	-19	159.9	69.01	159.9	69.70	158.9	70.30	158.9	71.23	158.9	72.10	156.5	73.49
	-16.7	-17	167.5	69.97	167.5	70.67	166.5	71.27	166.5	72.19	166.5	73.08	164.1	74.45
	-13.7	-15	178.4	71.36	178.4	72.06	177.3	72.66	177.3	73.58	177.3	74.45	174.7	71.80
	-11.8	-13	184.3	72.25	184.3	72.93	183.2	73.53	183.2	74.45	183.2	75.32	181.2	70.12
	-9.8	-11	190.5	73.16	190.5	73.85	189.4	74.45	189.4	75.34	189.4	76.23	187.2	71.49
	-9.5	-10	191.8	73.31	191.8	73.99	190.7	74.17	190.7	75.06	190.7	76.14	188.0	68.07
	-8.5	-9.1	196.5	73.76	196.5	74.45	195.4	75.22	195.4	76.11	195.4	77.00	192.4	67.18
	-7.0	-7.6	203.6	74.45	203.6	75.09	202.2	75.80	202.2	76.51	202.2	77.22	198.6	65.86
	-5.0	-5.6	213.0	75.22	213.0	75.94	211.6	76.71	211.6	77.50	211.6	78.29	205.7	64.09
	-3.0	-3.7	222.4	76.08	222.4	76.92	221.0	77.71	221.0	78.50	221.0	79.29	212.8	62.30
	0.0	-0.7	236.5	77.03	236.5	77.87	234.8	78.72	233.7	79.51	233.7	80.25	223.7	59.65
	3.0	2.2	245.1	78.06	245.1	79.00	243.7	79.89	242.1	80.83	242.1	81.72	224.7	57.00
	5.0	4.1	250.5	79.17	250.5	80.28	249.3	81.23	247.7	82.18	247.7	83.13	224.7	55.21
	7.0	6.0	256.1	80.35	256.1	81.63	254.7	82.04	250.1	83.06	250.1	84.01	224.7	53.45
	9.0	7.9	257.1	81.58	257.1	82.98	256.3	83.47	250.1	84.42	250.1	85.37	224.7	51.66
	11.0	9.8	257.1	82.87	257.1	84.37	256.3	84.88	250.1	85.78	250.1	86.68	224.7	49.91
	13.0	11.8	257.1	84.22	257.1	85.81	256.3	86.39	250.1	87.14	250.1	88.04	224.7	48.22
15.0	13.7	257.1	85.63	257.1	87.30	256.3	87.90	250.1	88.55	250.1	89.45	224.7	46.61	
120	-24.8	-25	118.7	66.94	118.7	67.54	117.9	68.45	117.9	69.33	117.9	70.73	116.3	71.69
	-21.8	-22	146.2	68.31	146.2	68.91	145.2	69.84	145.2	70.73	145.2	72.10	143.2	73.08
	-19.8	-20	155.1	69.24	155.1	69.84	154.0	70.76	154.0	71.63	154.0	73.02	151.8	73.99
	-18.8	-19	158.6	69.70	158.6	70.30	157.6	71.23	157.6	72.10	157.6	73.49	155.4	74.45
	-16.7	-17	166.2	70.67	166.2	71.27	165.2	72.19	165.2	73.08	165.2	74.45	162.8	72.74
	-13.7	-15	177.1	72.06	177.1	72.66	176.0	73.58	176.0	74.45	176.0	75.34	173.4	70.30
	-11.8	-13	183.0	72.93	183.0	73.53	181.9	74.45	181.9	75.34	181.9	76.23	179.9	68.76
	-9.8	-11	189.1	73.85	189.1	74.45	188.0	75.22	188.0	76.11	188.0	77.00	186.6	67.13
	-9.5	-10	190.5	73.99	190.5	74.14	189.4	74.29	189.4	75.18	189.4	76.07	188.0	66.87
	-8.5	-9.1	195.2	74.45	195.2	75.11	193.9	75.92	193.9	76.81	193.9	77.70	191.8	66.06
	-7.0	-7.6	202.2	75.22	202.2	75.94	200.9	76.71	200.9	77.60	200.9	78.49	190.0	64.84
	-5.0	-5.6	211.6	76.08	211.6	76.92	210.2	77.71	210.2	78.50	210.2	79.29	204.3	63.21
	-3.0	-3.7	220.7	76.92	220.7	77.76	219.4	78.55	219.4	79.34	219.4	80.13	210.4	61.57
	0.0	-0.7	234.8	77.87	234.8	78.71	233.7	79.50	232.6	80.29	232.6	81.08	211.0	59.13
	3.0	2.2	243.2	78.80	243.2	79.64	242.1	80.43	241.0	81.22	241.0	82.01	211.0	56.69
	5.0	4.1	248.8	79.81	248.8	80.65	247.4	81.44	246.0	82.23	246.0	83.02	211.0	54.26
	7.0	6.0	254.4	80.89	254.4	81.73	252.4	82.57	250.4	83.41	250.4	84.25	211.0	51.83
	9.0	7.9	255.2	81.92	255.2	82.86	252.4	83.70	250.4	84.54	250.4	85.38	211.0	49.40
	11.0	9.8	255.2	83.06	255.2	84.10	252.4	84.94	250.4	85.78	250.4	86.62	211.0	47.00
	13.0	11.8	255.2	84.25	255.2	85.39	252.4	86.23	250.4	87.07	250.4	87.95	211.0	44.61
15.0	13.7	255.2	85.50	255.2	86.74	252.4	87.62	250.4	88.40	250.4	89.28	211.0	42.28	
110	-24.8	-25	118.1	67.54	118.1	68.45	117.4	69.33	117.4	70.73	117.4	71.69	115.6	72.16
	-21.8	-22	145.4	68.91	145.4	69.84	144.4	70.73	144.4	72.10	144.4	73.08	142.4	73.53
	-19.8	-20	154.3	69.84	154.3	70.76	153.2	71.63	153.2	73.02	153.2	73.99	151.0	74.45
	-18.8	-19	157.8	70.30	157.8	71.23	156.8	72.10	156.8	73.49	156.8	74.45	154.6	73.54
	-16.7	-17	165.4	71.27	165.4	72.19	164.4	73.08	164.4	74.45	164.4	75.34	162.0	71.61
	-13.7	-15	176.1	72.66	176.1	73.58	175.0	74.45	175.0	75.34	175.0	76.23	173.0	68.88
	-11.8	-13	181.9	73.53	181.9	74.45	180.9	75.34	180.9	76.23	180.9	77.12	178.9	67.13
	-9.8	-11	188.1	74.45	188.1	75.34	187.0	76.23	187.0	77.12	187.0	78.01	186.4	65.31
	-9.5	-10	189.4	74.09	189.4	74.88	188.4	75.67	188.4	76.46	188.4	77.25	187.8	65.04
	-8.5	-9.1	194.1	75.00	194.1	75.79	193.0	76.58	193.0	77.37	193.0	78.16	189.3	64.11
	-7.0	-7.6	201.1	75.91	201.1	76.70	199.8	77.46	199.8	78.25	199.8	79.04	189.9	62.75
	-5.0	-5.6	210.3	76.82	210.3	77.61	208.9	78.35	207.9	79.14	207.9	80.03	189.9	60.91
	-3.0	-3.7	219.6	77.73	219.6	78.52	215.3	79.24	210.5	80.13	210.5	81.02	189.9	59.08
	0.0	-0.7	231.5	78.64	231.5	79.43	228.1	80.12	223.3	81.01	223.3	81.90	189.9	56.34
	3.0	2.2	239.7	79.55	239.7	80.44	237.1	81.01	234.5	81.90	234.5	82.79	189.9	53.59
	5.0	4.1	245.3	80.56	245.3	81.45	243.9	82.00	241.3	82.89	241.3	83.78	189.9	50.84
	7.0	6.0	245.3	81.61	245.3	82.50	243.9	83.09	241.3	84.08	241.3	85.07	189.9	48.09
	9.0	7.9	245.3	82.66	245.3	83.65	243.9	84.14	241.3	85.13	241.3	86.12	189.9	45.34
	11.0	9.8	245.3	83.71	245.3	84.70	243.9	85.19	241.3	86.18	241.3	87.27	189.9	42.59
	13.0	11.8	245.3	84.76	245.3	85.75	243.9	86.24	241.3	87.32	241.3	88.36	189.9	39.84
15.0	13.7	245.3	85.81	245.3	86.80	243.9	87.29	241.3	88.37	241.3	89.45	189.9	37.09	

# 7. Capacity Tables

Heating Capacity (64HP)

Combination (%)	Outdoor air temp.		Indoor air temp. °C DB											
			16		18		20		21		22		24	
	°C DB	°C WB	TC	PI	TC	PI	TC	PI	TC	PI	TC	PI	TC	PI
100	-24.8	-25	117.6	74.85	117.6	74.80	116.8	70.49	116.8	74.67	116.8	74.62	115.0	74.60
	-21.8	-22	144.6	74.76	144.6	74.72	143.8	72.72	143.8	74.59	143.8	75.56	141.6	74.52
	-19.8	-20	153.5	74.72	153.5	74.66	152.7	74.13	152.7	74.55	152.7	74.83	150.5	74.45
	-18.8	-19	157.1	74.70	156.2	74.64	156.2	74.59	156.2	74.51	156.2	74.45	153.8	73.33
	-16.7	-17	163.6	74.65	163.6	74.59	163.6	75.56	162.8	74.45	162.8	72.13	160.4	70.94
	-13.7	-15	175.3	74.56	175.3	74.50	174.2	74.45	174.2	71.09	174.2	68.78	171.8	67.52
	-11.8	-13	181.1	74.52	180.1	74.45	180.1	72.21	180.1	68.95	180.1	66.67	173.3	65.37
	-9.8	-11	187.0	74.45	187.0	71.95	186.2	69.84	186.2	66.70	184.2	64.45	173.5	63.10
	-9.5	-10	188.4	74.06	188.4	71.57	187.6	69.50	187.6	66.36	184.8	64.11	173.5	62.76
	-8.5	-9.1	193.0	72.76	193.0	70.31	192.2	68.31	192.6	65.24	186.2	63.01	173.5	61.61
	-7.0	-7.6	203.3	70.81	202.5	68.44	199.0	66.53	192.6	63.57	186.2	61.33	173.5	59.91
	-5.0	-5.6	212.2	68.19	210.0	65.94	199.0	64.18	192.6	61.30	186.2	59.11	173.5	57.64
	-3.0	-3.7	218.3	65.59	211.8	63.42	199.0	61.82	192.6	59.06	186.2	56.89	173.5	55.36
	0.0	-0.7	224.5	61.66	211.8	59.66	199.0	58.27	192.6	55.69	186.2	53.55	173.5	51.96
	3.0	2.2	224.5	57.74	211.8	55.89	199.0	54.73	192.6	52.32	186.2	50.20	173.5	48.56
	5.0	4.1	224.5	55.14	211.8	53.39	199.0	52.36	192.6	50.08	186.2	47.98	173.5	46.28
	7.0	6.0	224.5	52.52	211.8	50.87	199.0	49.99	192.6	47.83	186.2	45.76	173.5	44.01
9.0	7.9	224.5	50.66	211.8	49.07	199.0	48.22	192.6	46.14	186.2	44.15	173.5	42.45	
11.0	9.8	224.5	49.23	211.8	47.69	199.0	46.87	192.6	44.83	186.2	42.89	173.5	41.26	
13.0	11.8	224.5	47.72	211.8	46.21	199.0	45.41	192.6	43.45	186.2	41.56	173.5	39.97	
15.0	13.7	224.5	46.11	211.8	44.65	199.0	43.88	192.6	41.97	186.2	40.16	173.5	38.62	
90	-24.8	-25	117.1	66.52	117.1	67.89	116.3	68.88	116.3	69.32	116.3	70.25	114.7	71.64
	-21.8	-22	144.1	67.89	144.1	69.28	143.3	70.25	143.3	70.71	143.3	71.64	141.1	68.66
	-19.8	-20	153.0	68.82	153.0	70.21	151.9	71.17	151.9	71.64	151.9	69.60	149.7	66.67
	-18.8	-19	157.1	69.28	156.2	70.67	155.5	71.64	155.5	70.60	155.5	68.59	153.3	65.68
	-16.7	-17	163.6	70.25	163.6	71.64	163.0	69.50	163.0	68.41	163.0	66.47	157.6	63.58
	-13.7	-15	175.3	71.64	175.3	68.45	173.7	66.43	173.7	65.29	169.7	63.42	158.6	60.60
	-11.8	-13	181.1	69.46	180.1	66.44	179.3	64.48	175.3	63.30	170.8	61.51	158.6	58.71
	-9.8	-11	187.0	67.19	187.0	64.33	181.0	62.44	176.5	61.21	170.8	59.47	158.6	56.72
	-9.5	-10	188.4	66.84	188.4	64.00	181.6	62.13	176.5	60.90	170.8	59.16	158.6	56.41
	-8.5	-9.1	193.0	65.71	191.7	62.94	182.1	61.10	176.5	59.87	170.8	58.15	158.6	55.43
	-7.0	-7.6	203.3	63.99	193.4	61.35	182.1	59.58	176.5	58.30	170.8	56.63	158.6	53.93
	-5.0	-5.6	205.5	61.70	193.4	59.24	182.1	57.54	176.5	56.23	170.8	54.61	158.6	51.95
	-3.0	-3.7	205.5	59.42	193.4	57.13	182.1	55.49	176.5	54.14	170.8	52.57	158.6	49.96
	0.0	-0.7	205.5	56.00	193.4	53.94	182.1	52.42	176.5	51.02	170.8	49.52	158.6	46.98
	3.0	2.2	205.5	52.57	193.4	50.75	182.1	49.36	176.5	47.90	170.8	46.49	158.6	43.98
	5.0	4.1	205.5	50.28	193.4	48.64	182.1	47.32	176.5	45.81	170.8	44.45	158.6	41.99
	7.0	6.0	205.5	48.00	193.4	46.53	182.1	45.28	176.5	43.74	170.8	42.44	158.6	40.02
9.0	7.9	205.5	45.83	193.4	44.42	182.1	43.22	176.5	41.76	170.8	40.51	158.6	38.21	
11.0	9.8	205.5	43.67	193.4	42.33	182.1	41.19	176.5	39.78	170.8	38.60	158.6	36.39	
13.0	11.8	205.5	41.50	193.4	40.22	182.1	39.15	176.5	37.81	170.8	36.69	158.6	34.58	
15.0	13.7	205.5	39.34	193.4	38.13	182.1	37.09	176.5	35.83	170.8	34.76	158.6	32.78	
80	-24.8	-25	116.6	58.40	116.6	59.79	115.8	60.76	115.8	61.22	115.8	63.52	114.2	60.90
	-21.8	-22	142.5	59.79	142.5	61.16	142.5	62.13	142.5	63.52	142.5	60.90	139.9	58.36
	-19.8	-20	151.4	60.70	151.4	62.09	151.4	63.52	151.4	61.68	150.0	59.14	141.7	56.68
	-18.8	-19	154.9	61.16	154.9	63.52	154.9	62.59	154.9	60.75	150.9	58.26	141.7	55.84
	-16.7	-17	160.8	63.52	160.8	61.58	160.8	60.63	157.2	58.81	152.4	56.45	141.7	54.08
	-13.7	-15	170.3	60.66	166.9	58.80	162.9	57.84	158.0	56.04	152.4	53.81	141.7	51.54
	-11.8	-13	174.4	58.84	169.3	57.05	162.9	56.06	158.0	54.29	152.4	52.15	141.7	49.94
	-9.8	-11	178.6	56.93	171.5	55.22	162.9	54.20	158.0	52.45	152.4	50.39	141.7	48.25
	-9.5	-10	179.9	56.65	172.6	54.93	162.9	53.91	158.0	52.16	152.4	50.13	141.7	48.01
	-8.5	-9.1	181.9	55.69	173.5	54.01	162.9	52.98	158.0	51.24	152.4	49.27	141.7	47.16
	-7.0	-7.6	184.0	54.25	173.5	52.62	162.9	51.59	158.0	49.86	152.4	47.96	141.7	45.89
	-5.0	-5.6	184.0	52.35	173.5	50.78	162.9	49.71	158.0	48.00	152.4	46.20	141.7	44.20
	-3.0	-3.7	184.0	50.44	173.5	48.93	162.9	47.85	158.0	46.16	152.4	44.46	141.7	42.52
	0.0	-0.7	184.0	47.56	173.5	46.17	162.9	45.06	158.0	43.40	152.4	41.82	141.7	40.00
	3.0	2.2	184.0	44.70	173.5	43.39	162.9	42.25	158.0	40.61	152.4	39.21	141.7	37.46
	5.0	4.1	184.0	42.80	173.5	41.55	162.9	40.39	158.0	38.77	152.4	37.45	141.7	35.78
	7.0	6.0	184.0	40.89	173.5	39.70	162.9	38.53	158.0	36.93	152.4	35.71	141.7	34.09
9.0	7.9	184.0	38.39	173.5	37.28	162.9	36.17	158.0	34.67	152.4	33.53	141.7	32.01	
11.0	9.8	184.0	35.63	173.5	34.59	162.9	33.58	158.0	32.17	152.4	31.11	141.7	29.70	
13.0	11.8	184.0	33.26	173.5	32.28	162.9	31.35	158.0	30.04	152.4	29.04	141.7	27.73	
15.0	13.7	184.0	31.30	173.5	30.39	162.9	29.49	158.0	28.27	152.4	27.34	141.7	26.11	

# 7. Capacity Tables

Heating Capacity (64HP)

Combination (%)	Outdoor air temp.		Indoor air temp. °C DB											
			16		18		20		21		22		24	
	°C DB	°C WB	TC	PI	TC	PI	TC	PI	TC	PI	TC	PI	TC	PI
70	-24.8	-25	116.6	59.07	116.6	59.53	115.8	60.46	115.8	61.85	115.8	58.98	114.2	56.30
	-21.8	-22	138.3	60.46	138.6	60.92	137.7	61.85	133.9	58.98	129.9	56.30	121.3	53.71
	-19.8	-20	150.8	61.38	146.2	61.85	138.7	59.84	133.9	57.08	129.9	54.52	121.3	51.98
	-18.8	-19	153.7	61.85	147.1	60.82	138.7	58.84	133.9	56.12	129.9	53.62	121.3	51.10
	-16.7	-17	155.8	59.70	147.3	58.64	138.7	56.75	133.9	54.11	129.9	51.75	121.3	49.29
	-13.7	-15	156.1	56.66	147.3	55.55	138.7	53.74	133.9	51.27	129.9	49.07	121.3	46.68
	-11.8	-13	156.1	54.71	147.3	53.59	138.7	51.83	133.9	49.44	129.9	47.37	121.3	45.04
	-9.8	-11	156.1	52.68	147.3	51.51	138.7	49.84	133.9	47.53	129.9	45.58	121.3	43.31
	-9.5	-10	156.1	52.38	147.3	51.20	138.7	49.54	133.9	47.25	129.9	45.32	121.3	43.05
	-8.5	-9.1	156.1	51.37	147.3	50.17	138.7	48.53	133.9	46.30	129.9	44.42	121.3	42.17
	-7.0	-7.6	156.1	49.83	147.3	48.63	138.7	47.04	133.9	44.87	129.9	43.08	121.3	40.88
	-5.0	-5.6	156.1	47.80	147.3	46.57	138.7	45.03	133.9	42.97	129.9	41.30	121.3	39.15
	-3.0	-3.7	156.1	45.77	147.3	44.49	138.7	43.02	133.9	41.06	129.9	39.51	121.3	37.41
	0.0	-0.7	156.1	42.72	147.3	41.40	138.7	40.03	133.9	38.19	129.9	36.83	121.3	34.82
	3.0	2.2	156.1	39.66	147.3	38.31	138.7	37.02	133.9	35.35	129.9	34.14	121.3	32.21
	5.0	4.1	156.1	37.63	147.3	36.23	138.7	35.03	133.9	33.44	129.9	32.36	121.3	30.48
	7.0	6.0	156.1	35.60	147.3	34.17	138.7	33.03	133.9	31.53	129.9	30.58	121.3	28.75
	9.0	7.9	156.1	32.15	147.3	30.85	138.7	29.83	133.9	28.48	129.9	27.62	121.3	25.95
	11.0	9.8	156.1	29.94	147.3	28.72	138.7	27.76	133.9	26.51	129.9	25.71	121.3	24.17
	13.0	11.8	156.1	28.00	147.3	26.88	138.7	25.98	133.9	24.81	129.9	24.06	121.3	22.63
15.0	13.7	156.1	26.40	147.3	25.34	138.7	24.49	133.9	23.38	129.9	22.68	121.3	21.32	
60	-24.8	-25	116.6	58.14	116.6	59.07	115.8	60.46	113.6	57.41	110.6	54.56	103.9	51.86
	-21.8	-22	126.9	59.53	126.7	60.46	118.9	57.41	114.9	54.56	110.9	51.86	103.9	49.26
	-19.8	-20	133.9	60.46	126.7	58.31	118.9	55.38	114.9	52.66	110.9	50.06	103.9	47.51
	-18.8	-19	133.9	59.38	126.7	57.23	118.9	54.36	114.9	51.69	110.9	49.16	103.9	46.63
	-16.7	-17	133.9	57.11	126.7	54.98	118.9	52.23	114.9	49.68	110.9	47.28	103.9	44.80
	-13.7	-15	133.9	53.87	126.7	51.78	118.9	49.20	114.9	46.83	110.9	44.59	103.9	42.20
	-11.8	-13	133.9	51.83	126.7	49.73	118.9	47.26	114.9	45.01	110.9	42.89	103.9	40.55
	-9.8	-11	133.9	49.68	126.7	47.59	118.9	45.23	114.9	43.11	110.9	41.09	103.9	38.80
	-9.5	-10	133.9	49.35	126.7	47.28	118.9	44.93	114.9	42.83	110.9	40.81	103.9	38.54
	-8.5	-9.1	133.9	48.28	126.7	46.20	118.9	43.92	114.9	41.88	110.9	39.91	103.9	37.67
	-7.0	-7.6	133.9	46.67	126.7	44.59	118.9	42.41	114.9	40.44	110.9	38.57	103.9	36.36
	-5.0	-5.6	133.9	44.51	126.7	42.44	118.9	40.36	114.9	38.54	110.9	36.77	103.9	34.63
	-3.0	-3.7	133.9	42.36	126.7	40.29	118.9	38.34	114.9	36.64	110.9	34.98	103.9	32.88
	0.0	-0.7	133.9	39.12	126.7	37.09	118.9	35.31	114.9	33.77	110.9	32.28	103.9	30.27
	3.0	2.2	133.9	35.88	126.7	33.87	118.9	32.26	114.9	30.92	110.9	29.60	103.9	27.65
	5.0	4.1	133.9	33.73	126.7	31.72	118.9	30.24	114.9	29.02	110.9	27.80	103.9	25.92
	7.0	6.0	133.9	31.59	126.7	29.57	118.9	28.21	114.9	27.10	110.9	26.00	103.9	24.17
	9.0	7.9	133.9	28.18	126.7	26.40	118.9	25.16	114.9	24.17	110.9	23.19	103.9	21.57
	11.0	9.8	133.9	26.30	126.7	24.65	118.9	23.50	114.9	22.58	110.9	21.67	103.9	20.13
	13.0	11.8	133.9	24.65	126.7	23.08	118.9	22.02	114.9	21.14	110.9	20.29	103.9	18.88
15.0	13.7	133.9	23.29	126.7	21.83	118.9	20.80	114.9	19.99	110.9	19.17	103.9	17.84	
50	-24.8	-25	111.7	51.35	105.3	52.74	99.1	50.01	95.9	47.46	92.7	45.03	86.3	42.79
	-21.8	-22	111.7	52.74	105.3	50.01	99.1	47.46	95.9	45.03	92.7	42.79	86.3	40.62
	-19.8	-20	111.7	50.84	105.3	48.19	99.1	45.76	95.9	43.42	92.7	41.28	86.3	39.16
	-18.8	-19	111.7	49.89	105.3	47.28	99.1	44.91	95.9	42.63	92.7	40.52	86.3	38.43
	-16.7	-17	111.7	47.91	105.3	45.38	99.1	43.13	95.9	40.94	92.7	38.96	86.3	36.91
	-13.7	-15	111.7	45.07	105.3	42.65	99.1	40.58	95.9	38.51	92.7	36.71	86.3	34.74
	-11.8	-13	111.7	43.28	105.3	40.93	99.1	38.96	95.9	36.98	92.7	35.28	86.3	33.36
	-9.8	-11	111.7	41.38	105.3	39.11	99.1	37.25	95.9	35.36	92.7	33.77	86.3	31.90
	-9.5	-10	111.7	41.10	105.3	38.84	99.1	37.01	95.9	35.13	92.7	33.55	86.3	31.69
	-8.5	-9.1	111.7	40.14	105.3	37.93	99.1	36.15	95.9	34.32	92.7	32.80	86.3	30.96
	-7.0	-7.6	111.7	38.73	105.3	36.58	99.1	34.88	95.9	33.12	92.7	31.68	86.3	29.89
	-5.0	-5.6	111.7	36.83	105.3	34.76	99.1	33.18	95.9	31.50	92.7	30.16	86.3	28.43
	-3.0	-3.7	111.7	34.94	105.3	32.94	99.1	31.47	95.9	29.89	92.7	28.65	86.3	26.99
	0.0	-0.7	111.7	32.10	105.3	30.20	99.1	28.92	95.9	27.46	92.7	26.41	86.3	24.80
	3.0	2.2	111.7	29.27	105.3	27.49	99.1	26.38	95.9	25.04	92.7	24.16	86.3	22.63
	5.0	4.1	111.7	27.37	105.3	25.67	99.1	24.67	95.9	23.44	92.7	22.65	86.3	21.19
	7.0	6.0	111.7	25.47	105.3	23.85	99.1	22.97	95.9	21.83	92.7	21.14	86.3	19.73
	9.0	7.9	111.7	23.00	105.3	21.54	99.1	20.74	95.9	19.70	92.7	19.09	86.3	17.82
	11.0	9.8	111.7	21.51	105.3	20.16	99.1	19.41	95.9	18.45	92.7	17.87	86.3	16.67
	13.0	11.8	111.7	20.21	105.3	18.93	99.1	18.22	95.9	17.31	92.7	16.78	86.3	15.66
15.0	13.7	111.7	19.12	105.3	17.90	99.1	17.25	95.9	16.38	92.7	15.87	86.3	14.81	

**Note**

1. TC: Total Capacity(kW), PI : Power Input(kW, Comp. + Outdoor fan motor)
2. Capacity tables show the average value of conditions which may occur.
3. The heating capacity table is based on the values expressed as Max. in the specification of the outdoor unit. (When measuring the Max. heating capacity, the setting status of the indoor unit is the same as that for measuring the heating capacity of the indoor unit.)

# 7. Capacity Tables

## ◆ ARUM660LTE5

Heating Capacity (66HP)

Combination (%)	Outdoor air temp.		Indoor air temp. °C DB											
			16		18		20		21		22		24	
	°C DB	°C WB	TC	PI	TC	PI	TC	PI	TC	PI	TC	PI	TC	PI
130	-24.8	-25	128.1	69.1	128.1	69.59	127.2	70.05	127.2	70.74	127.2	71.43	124.9	72.50
	-21.8	-22	156.2	70.11	156.2	70.64	155.1	71.10	155.1	71.81	155.1	72.50	152.1	73.55
	-19.8	-20	164.9	70.82	164.9	71.35	163.8	71.81	163.8	72.53	163.8	73.19	160.7	74.26
	-18.8	-19	168.6	71.17	168.6	71.71	167.5	72.17	167.5	72.88	167.5	73.55	164.2	74.62
	-16.7	-17	176.1	71.92	176.1	72.45	174.9	72.91	174.9	73.62	174.9	74.31	171.6	75.36
	-13.7	-15	186.8	72.98	186.8	73.52	185.6	73.98	185.6	74.69	185.6	75.36	182.1	72.53
	-11.8	-13	192.8	73.67	192.8	74.18	191.7	74.64	191.7	75.36	191.7	73.46	188.7	70.73
	-9.8	-11	199.2	74.36	199.2	74.90	198.1	75.36	198.1	73.34	198.1	71.46	195.7	68.85
	-9.5	-10	200.3	74.49	200.3	75.00	199.2	75.05	199.2	73.03	198.9	71.16	196.8	68.55
	-8.5	-9.1	204.2	74.82	204.2	75.36	203.1	74.01	203.1	72.01	202.2	70.16	200.2	67.61
	-7.0	-7.6	210.0	75.36	210.0	73.85	208.7	72.46	208.7	70.49	208.7	68.63	205.4	66.19
	-5.0	-5.6	217.8	73.41	217.8	71.82	216.4	70.39	216.4	68.46	216.4	66.63	212.3	64.31
	-3.0	-3.7	225.5	71.46	225.5	69.81	224.1	68.31	224.1	66.42	224.1	64.63	219.3	62.41
	0.0	-0.7	237.1	68.52	237.1	66.78	235.5	65.22	235.5	63.38	235.5	61.63	229.9	59.58
	3.0	2.2	248.8	65.60	248.8	63.73	247.1	62.10	247.1	60.33	247.1	58.60	231.8	56.75
	5.0	4.1	256.3	63.63	256.3	61.72	254.9	60.03	254.9	58.30	249.0	56.60	231.8	54.85
	7.0	6.0	264.1	61.69	264.1	59.69	262.4	57.97	258.0	56.28	249.0	54.60	231.8	52.97
	9.0	7.9	265.3	60.08	265.3	58.13	264.5	56.45	258.0	54.81	249.0	53.18	231.8	51.58
	11.0	9.8	265.3	58.99	265.3	57.09	264.5	55.44	258.0	53.82	249.0	52.22	231.8	50.65
	13.0	11.8	265.3	57.83	265.3	55.95	264.5	54.33	258.0	52.76	249.0	51.19	231.8	49.65
15.0	13.7	265.3	56.57	265.3	54.75	264.5	53.16	258.0	51.60	249.0	50.08	231.8	48.57	
120	-24.8	-25	127.2	69.59	127.2	70.05	126.4	70.74	126.4	71.43	126.4	72.50	124.1	73.24
	-21.8	-22	155.1	70.64	155.1	71.10	154.0	71.81	154.0	72.50	154.0	73.55	151.2	74.31
	-19.8	-20	163.7	71.35	163.7	71.81	162.6	72.53	162.6	73.19	162.6	74.26	159.6	75.00
	-18.8	-19	167.2	71.71	167.2	72.17	166.1	72.88	166.1	73.55	166.1	74.62	163.1	75.36
	-16.7	-17	174.7	72.45	174.7	72.91	173.6	73.62	173.6	74.31	173.6	75.36	170.3	73.53
	-13.7	-15	185.4	73.52	185.4	73.98	184.3	74.69	184.3	75.36	184.3	72.64	180.7	70.93
	-11.8	-13	191.5	74.18	191.5	74.64	190.3	75.36	190.3	73.44	190.3	70.92	187.4	69.29
	-9.8	-11	197.8	74.90	197.8	75.36	196.7	73.24	196.7	71.41	196.7	69.11	194.3	67.55
	-9.5	-10	198.9	75.00	198.9	75.02	197.8	72.93	197.8	71.11	197.8	68.84	195.4	67.28
	-8.5	-9.1	202.8	75.36	202.8	73.90	201.5	71.87	201.5	70.10	201.3	67.95	198.7	66.42
	-7.0	-7.6	208.6	73.70	208.6	72.23	207.2	70.29	207.2	68.58	206.8	66.59	204.0	65.11
	-5.0	-5.6	216.3	71.48	216.3	69.99	215.0	68.17	215.0	66.55	215.0	64.76	210.9	63.37
	-3.0	-3.7	223.9	69.26	223.9	67.78	222.5	66.05	222.5	64.55	222.5	62.96	216.9	61.63
	0.0	-0.7	235.5	65.94	235.5	64.42	233.9	62.88	233.9	61.50	233.9	60.24	217.7	59.03
	3.0	2.2	246.9	62.62	246.9	61.07	245.4	59.71	241.8	58.47	234.3	57.52	217.7	56.42
	5.0	4.1	254.6	60.40	254.6	58.84	250.1	57.61	241.8	56.44	234.3	55.72	217.7	54.68
	7.0	6.0	262.3	58.18	260.5	56.60	250.1	55.49	241.8	54.42	234.3	53.91	217.7	52.94
	9.0	7.9	263.3	56.51	260.5	54.98	250.1	53.90	241.8	52.88	234.3	52.38	217.7	51.43
	11.0	9.8	263.3	55.35	260.5	53.86	250.1	52.79	241.8	51.79	234.3	51.29	217.7	50.37
	13.0	11.8	263.3	54.09	260.5	52.63	250.1	51.60	241.8	50.61	234.3	50.14	217.7	49.25
15.0	13.7	263.3	52.77	260.5	51.33	250.1	50.32	241.8	49.35	234.3	48.88	217.7	48.02	
110	-24.8	-25	126.6	70.05	126.6	70.74	125.8	71.43	125.8	72.50	125.8	73.24	123.3	73.59
	-21.8	-22	154.3	71.10	154.3	71.81	153.2	72.50	153.2	73.55	153.2	74.31	150.4	74.64
	-19.8	-20	162.9	71.81	162.9	72.53	161.8	73.19	161.8	74.26	161.8	75.00	158.7	75.36
	-18.8	-19	166.4	72.17	166.4	72.88	165.3	73.55	165.3	74.62	165.3	75.36	162.2	74.39
	-16.7	-17	173.8	72.91	173.8	73.62	172.7	74.31	172.7	75.36	172.7	73.39	169.4	72.36
	-13.7	-15	184.3	73.98	184.3	74.69	183.2	75.36	183.2	72.37	183.2	70.56	183.2	69.47
	-11.8	-13	190.4	74.64	190.4	75.36	189.2	73.25	189.2	70.47	189.2	68.77	189.2	67.63
	-9.8	-11	196.7	75.36	196.7	72.98	195.6	71.04	195.6	68.48	195.6	66.89	194.3	65.71
	-9.5	-10	197.8	74.97	197.8	72.62	196.7	70.69	196.7	68.18	196.7	66.61	195.9	65.43
	-8.5	-9.1	201.7	73.69	201.7	71.43	200.6	69.58	200.6	67.18	200.6	65.65	195.9	64.44
	-7.0	-7.6	207.5	71.75	207.5	69.65	206.1	67.92	206.1	65.69	206.1	64.25	195.9	63.01
	-5.0	-5.6	215.0	69.20	215.0	67.25	213.6	65.71	213.6	63.70	209.7	62.37	195.9	61.06
	-3.0	-3.7	222.7	66.62	222.7	64.87	221.4	63.47	217.2	61.69	209.7	60.47	195.9	59.14
	0.0	-0.7	234.1	62.77	234.1	61.30	224.4	60.15	217.2	58.71	209.7	57.66	195.9	56.25
	3.0	2.2	245.5	58.91	239.3	57.73	224.4	56.81	217.2	55.73	209.7	54.82	195.9	53.34
	5.0	4.1	253.1	56.34	239.3	55.34	224.4	54.59	217.2	53.72	209.7	52.94	195.9	51.41
	7.0	6.0	253.1	53.76	239.3	52.96	224.4	52.36	217.2	51.73	209.7	51.07	195.9	49.49
	9.0	7.9	253.1	51.99	239.3	51.22	224.4	50.65	217.2	50.02	209.7	49.39	195.9	47.86
	11.0	9.8	253.1	50.69	239.3	49.93	224.4	49.35	217.2	48.75	209.7	48.12	195.9	46.65
	13.0	11.8	253.1	49.26	239.3	48.53	224.4	47.98	217.2	47.40	209.7	46.80	195.9	45.36
15.0	13.7	253.1	47.77	239.3	47.04	224.4	46.52	217.2	45.94	209.7	45.37	195.9	43.96	

# 7. Capacity Tables

Heating Capacity (66HP)

Combination (%)	Outdoor air temp.		Indoor air temp. °C DB											
			16		18		20		21		22		24	
	°C DB	°C WB	TC	PI	TC	PI	TC	PI	TC	PI	TC	PI	TC	PI
100	-24.8	-25	126.0	76.49	126.0	76.35	125.2	71.71	125.2	75.97	125.2	75.82	122.7	75.75
	-21.8	-22	153.5	76.26	153.5	76.12	152.6	73.98	152.6	75.74	152.6	76.48	149.6	75.52
	-19.8	-20	162.1	76.12	162.1	75.96	161.2	75.39	161.2	75.60	161.2	75.74	158.2	75.36
	-18.8	-19	165.6	76.05	164.7	75.89	164.7	75.74	164.7	75.51	164.7	75.36	161.4	74.18
	-16.7	-17	171.9	75.89	171.9	75.73	171.9	76.48	171.1	75.36	171.1	72.92	167.8	71.70
	-13.7	-15	183.5	75.66	183.5	75.50	182.4	75.36	182.4	71.82	182.4	69.43	179.0	68.13
	-11.8	-13	189.5	75.52	188.4	75.36	188.4	72.99	188.4	69.57	188.4	67.21	179.0	65.89
	-9.8	-11	195.6	75.36	195.6	72.71	194.8	70.49	194.8	67.22	192.1	64.89	179.0	63.52
	-9.5	-10	196.7	74.94	196.7	72.30	195.9	70.13	195.9	66.86	192.1	64.54	179.0	63.16
	-8.5	-9.1	200.6	73.56	200.6	70.98	199.7	68.87	198.7	65.68	192.1	63.38	179.0	61.97
	-7.0	-7.6	209.7	71.48	208.9	68.99	205.3	67.00	198.7	63.93	192.1	61.64	179.0	60.19
	-5.0	-5.6	218.9	68.70	216.7	66.35	205.3	64.52	198.7	61.55	192.1	59.31	179.0	57.82
	-3.0	-3.7	225.2	65.93	218.5	63.68	205.3	62.02	198.7	59.19	192.1	56.99	179.0	55.45
	0.0	-0.7	231.6	61.77	218.5	59.71	205.3	58.28	198.7	55.65	192.1	53.49	179.0	51.90
	3.0	2.2	231.6	57.60	218.5	55.72	205.3	54.54	198.7	52.12	192.1	50.00	179.0	48.35
	5.0	4.1	231.6	54.83	218.5	53.08	205.3	52.04	198.7	49.76	192.1	47.67	179.0	45.98
	7.0	6.0	231.6	52.05	218.5	50.41	205.3	49.54	198.7	47.40	192.1	45.35	179.0	43.61
	9.0	7.9	231.6	49.96	218.5	48.39	205.3	47.55	198.7	45.50	192.1	43.54	179.0	41.86
	11.0	9.8	231.6	48.29	218.5	46.78	205.3	45.97	198.7	43.97	192.1	42.06	179.0	40.47
	13.0	11.8	231.6	46.53	218.5	45.05	205.3	44.27	198.7	42.36	192.1	40.52	179.0	38.97
15.0	13.7	231.6	44.65	218.5	43.24	205.3	42.49	198.7	40.64	192.1	38.89	179.0	37.40	
90	-24.8	-25	125.5	68.59	125.5	69.64	124.7	70.40	124.7	70.74	124.7	71.45	122.4	72.52
	-21.8	-22	152.9	69.64	152.9	70.71	152.0	71.45	152.0	71.81	152.0	72.52	149.0	69.42
	-19.8	-20	161.5	70.35	161.5	71.42	160.4	72.16	160.4	72.52	160.4	70.39	157.4	67.35
	-18.8	-19	165.6	70.71	164.7	71.78	163.9	72.52	163.9	71.44	163.9	69.34	160.8	66.33
	-16.7	-17	171.9	71.45	171.9	72.52	171.3	70.27	171.3	69.14	171.3	67.13	163.6	64.15
	-13.7	-15	183.5	72.52	183.5	69.17	181.8	67.06	181.8	65.88	176.3	63.95	163.6	61.05
	-11.8	-13	189.5	70.22	188.4	67.05	187.6	65.01	182.1	63.80	176.3	61.95	163.6	59.09
	-9.8	-11	195.6	67.83	195.6	64.83	187.9	62.87	182.1	61.62	176.3	59.82	163.6	57.02
	-9.5	-10	196.7	67.45	196.7	64.49	187.9	62.55	182.1	61.30	176.3	59.50	163.6	56.70
	-8.5	-9.1	200.6	66.26	199.2	63.38	187.9	61.47	182.1	60.21	176.3	58.45	163.6	55.67
	-7.0	-7.6	209.7	64.44	199.5	61.70	187.9	59.87	182.1	58.57	176.3	56.86	163.6	54.11
	-5.0	-5.6	212.0	62.03	199.5	59.48	187.9	57.74	182.1	56.41	176.3	54.75	163.6	52.06
	-3.0	-3.7	212.0	59.62	199.5	57.26	187.9	55.58	182.1	54.22	176.3	52.62	163.6	49.99
	0.0	-0.7	212.0	56.01	199.5	53.91	187.9	52.36	182.1	50.96	176.3	49.45	163.6	46.89
	3.0	2.2	212.0	52.39	199.5	50.55	187.9	49.15	182.1	47.69	176.3	46.29	163.6	43.78
	5.0	4.1	212.0	49.98	199.5	48.33	187.9	47.01	182.1	45.51	176.3	44.16	163.6	41.71
	7.0	6.0	212.0	47.56	199.5	46.11	187.9	44.87	182.1	43.34	176.3	42.05	163.6	39.66
	9.0	7.9	212.0	45.29	199.5	43.90	187.9	42.72	182.1	41.27	176.3	40.03	163.6	37.76
	11.0	9.8	212.0	43.02	199.5	41.71	187.9	40.58	182.1	39.19	176.3	38.03	163.6	35.85
	13.0	11.8	212.0	40.75	199.5	39.49	187.9	38.44	182.1	37.13	176.3	36.03	163.6	33.96
15.0	13.7	212.0	38.48	199.5	37.30	187.9	36.29	182.1	35.05	176.3	34.01	163.6	32.07	
80	-24.8	-25	124.9	60.37	124.9	61.44	124.1	62.18	124.1	62.54	124.1	64.30	121.8	61.58
	-21.8	-22	151.3	61.44	151.3	62.49	151.3	63.23	151.3	64.30	151.3	61.58	146.2	58.95
	-19.8	-20	159.8	62.13	159.8	63.20	159.8	64.30	159.8	62.38	157.2	59.75	146.2	57.20
	-18.8	-19	163.3	62.49	163.3	64.30	163.3	63.33	162.8	61.42	157.2	58.84	146.2	56.34
	-16.7	-17	168.0	64.30	168.0	62.27	168.0	61.28	163.0	59.40	157.2	56.95	146.2	54.51
	-13.7	-15	175.7	61.30	172.2	59.36	168.0	58.36	163.0	56.51	157.2	54.21	146.2	51.88
	-11.8	-13	180.3	59.38	175.0	57.52	168.0	56.50	163.0	54.68	157.2	52.48	146.2	50.21
	-9.8	-11	185.0	57.38	177.3	55.60	168.0	54.56	163.0	52.76	157.2	50.65	146.2	48.46
	-9.5	-10	186.3	57.08	178.4	55.30	168.0	54.26	163.0	52.47	157.2	50.38	146.2	48.22
	-8.5	-9.1	188.1	56.08	179.0	54.33	168.0	53.29	163.0	51.50	157.2	49.49	146.2	47.33
	-7.0	-7.6	189.8	54.56	179.0	52.88	168.0	51.83	163.0	50.07	157.2	48.12	146.2	46.02
	-5.0	-5.6	189.8	52.56	179.0	50.95	168.0	49.87	163.0	48.13	157.2	46.29	146.2	44.27
	-3.0	-3.7	189.8	50.56	179.0	49.01	168.0	47.92	163.0	46.22	157.2	44.49	146.2	42.52
	0.0	-0.7	189.8	47.53	179.0	46.12	168.0	45.01	163.0	43.33	157.2	41.74	146.2	39.91
	3.0	2.2	189.8	44.53	179.0	43.21	168.0	42.07	163.0	40.43	157.2	39.02	146.2	37.28
	5.0	4.1	189.8	42.53	179.0	41.28	168.0	40.13	163.0	38.51	157.2	37.20	146.2	35.53
	7.0	6.0	189.8	40.52	179.0	39.34	168.0	38.18	163.0	36.60	157.2	35.39	146.2	33.78
	9.0	7.9	189.8	38.05	179.0	36.94	168.0	35.84	163.0	34.36	157.2	33.23	146.2	31.73
	11.0	9.8	189.8	35.31	179.0	34.28	168.0	33.28	163.0	31.88	157.2	30.83	146.2	29.44
	13.0	11.8	189.8	32.96	179.0	31.99	168.0	31.07	163.0	29.77	157.2	28.78	146.2	27.48
15.0	13.7	189.8	31.02	179.0	30.12	168.0	29.23	163.0	28.01	157.2	27.09	146.2	25.88	

# 7. Capacity Tables

Heating Capacity (66HP)

Combination (%)	Outdoor air temp.		Indoor air temp. °C DB											
			16		18		20		21		22		24	
	°C DB	°C WB	TC	PI	TC	PI	TC	PI	TC	PI	TC	PI	TC	PI
70	-24.8	-25	124.9	60.67	124.9	61.02	124.1	61.74	124.1	62.81	124.1	59.83	120.9	57.04
	-21.8	-22	144.0	61.74	144.0	62.09	143.1	62.81	138.2	59.83	134.0	57.04	125.1	54.35
	-19.8	-20	156.6	62.45	152.0	62.81	143.1	60.71	138.2	57.84	134.0	55.18	125.1	52.56
	-18.8	-19	159.8	62.81	152.0	61.73	143.1	59.66	138.2	56.85	134.0	54.25	125.1	51.65
	-16.7	-17	161.1	60.55	152.0	59.45	143.1	57.48	138.2	54.75	134.0	52.31	125.1	49.77
	-13.7	-15	161.1	57.37	152.0	56.22	143.1	54.34	138.2	51.79	134.0	49.52	125.1	47.07
	-11.8	-13	161.1	55.32	152.0	54.17	143.1	52.35	138.2	49.89	134.0	47.75	125.1	45.37
	-9.8	-11	161.1	53.20	152.0	52.00	143.1	50.28	138.2	47.91	134.0	45.90	125.1	43.58
	-9.5	-10	161.1	52.87	152.0	51.67	143.1	49.96	138.2	47.61	134.0	45.63	125.1	43.31
	-8.5	-9.1	161.1	51.82	152.0	50.60	143.1	48.91	138.2	46.62	134.0	44.69	125.1	42.40
	-7.0	-7.6	161.1	50.21	152.0	48.98	143.1	47.35	138.2	45.14	134.0	43.30	125.1	41.06
	-5.0	-5.6	161.1	48.08	152.0	46.83	143.1	45.26	138.2	43.15	134.0	41.44	125.1	39.26
	-3.0	-3.7	161.1	45.95	152.0	44.65	143.1	43.16	138.2	41.16	134.0	39.59	125.1	37.47
	0.0	-0.7	161.1	42.74	152.0	41.42	143.1	40.04	138.2	38.18	134.0	36.80	125.1	34.78
	3.0	2.2	161.1	39.54	152.0	38.19	143.1	36.90	138.2	35.22	134.0	34.01	125.1	32.08
	5.0	4.1	161.1	37.41	152.0	36.02	143.1	34.82	138.2	33.24	134.0	32.16	125.1	30.28
	7.0	6.0	161.1	35.28	152.0	33.86	143.1	32.73	138.2	31.25	134.0	30.30	125.1	28.49
	9.0	7.9	161.1	31.86	152.0	30.57	143.1	29.56	138.2	28.22	134.0	27.38	125.1	25.72
	11.0	9.8	161.1	29.67	152.0	28.46	143.1	27.51	138.2	26.27	134.0	25.48	125.1	23.95
	13.0	11.8	161.1	27.75	152.0	26.64	143.1	25.75	138.2	24.58	134.0	23.85	125.1	22.42
15.0	13.7	161.1	26.17	152.0	25.11	143.1	24.27	138.2	23.17	134.0	22.48	125.1	21.13	
60	-24.8	-25	122.7	59.95	122.7	60.67	121.9	61.74	118.5	58.54	114.4	55.56	107.2	52.75
	-21.8	-22	131.9	61.02	130.7	61.74	122.7	58.54	118.5	55.56	114.4	52.75	107.2	50.04
	-19.8	-20	138.2	61.74	130.7	59.45	122.7	56.42	118.5	53.57	114.4	50.87	107.2	48.22
	-18.8	-19	138.2	60.61	130.7	58.35	122.7	55.35	118.5	52.56	114.4	49.93	107.2	47.31
	-16.7	-17	138.2	58.21	130.7	55.99	122.7	53.12	118.5	50.47	114.4	47.97	107.2	45.41
	-13.7	-15	138.2	54.80	130.7	52.62	122.7	49.95	118.5	47.49	114.4	45.16	107.2	42.70
	-11.8	-13	138.2	52.64	130.7	50.48	122.7	47.91	118.5	45.58	114.4	43.39	107.2	40.99
	-9.8	-11	138.2	50.38	130.7	48.22	122.7	45.79	118.5	43.60	114.4	41.51	107.2	39.17
	-9.5	-10	138.2	50.03	130.7	47.90	122.7	45.47	118.5	43.30	114.4	41.22	107.2	38.90
	-8.5	-9.1	138.2	48.90	130.7	46.77	122.7	44.42	118.5	42.31	114.4	40.28	107.2	37.99
	-7.0	-7.6	138.2	47.20	130.7	45.08	122.7	42.83	118.5	40.81	114.4	38.88	107.2	36.63
	-5.0	-5.6	138.2	44.92	130.7	42.82	122.7	40.69	118.5	38.82	114.4	37.01	107.2	34.83
	-3.0	-3.7	138.2	42.66	130.7	40.56	122.7	38.57	118.5	36.83	114.4	35.13	107.2	33.01
	0.0	-0.7	138.2	39.24	130.7	37.20	122.7	35.39	118.5	33.83	114.4	32.32	107.2	30.30
	3.0	2.2	138.2	35.83	130.7	33.82	122.7	32.20	118.5	30.85	114.4	29.52	107.2	27.57
	5.0	4.1	138.2	33.57	130.7	31.56	122.7	30.08	118.5	28.86	114.4	27.65	107.2	25.77
	7.0	6.0	138.2	31.30	130.7	29.31	122.7	27.96	118.5	26.85	114.4	25.77	107.2	23.95
	9.0	7.9	138.2	27.93	130.7	26.16	122.7	24.93	118.5	23.96	114.4	22.98	107.2	21.37
	11.0	9.8	138.2	26.06	130.7	24.43	122.7	23.29	118.5	22.37	114.4	21.47	107.2	19.95
	13.0	11.8	138.2	24.43	130.7	22.87	122.7	21.82	118.5	20.95	114.4	20.11	107.2	18.71
15.0	13.7	138.2	23.08	130.7	21.63	122.7	20.61	118.5	19.81	114.4	19.00	107.2	17.68	
50	-24.8	-25	115.2	52.32	108.6	53.39	102.2	50.58	98.9	47.95	95.6	45.46	89.0	43.16
	-21.8	-22	115.2	53.39	108.6	50.58	102.2	47.95	98.9	45.46	95.6	43.16	89.0	40.94
	-19.8	-20	115.2	51.43	108.6	48.70	102.2	46.21	98.9	43.80	95.6	41.61	89.0	39.44
	-18.8	-19	115.2	50.44	108.6	47.76	102.2	45.33	98.9	43.00	95.6	40.84	89.0	38.70
	-16.7	-17	115.2	48.40	108.6	45.81	102.2	43.50	98.9	41.26	95.6	39.23	89.0	37.14
	-13.7	-15	115.2	45.47	108.6	42.99	102.2	40.88	98.9	38.77	95.6	36.92	89.0	34.92
	-11.8	-13	115.2	43.62	108.6	41.22	102.2	39.21	98.9	37.19	95.6	35.45	89.0	33.51
	-9.8	-11	115.2	41.66	108.6	39.35	102.2	37.45	98.9	35.53	95.6	33.90	89.0	32.01
	-9.5	-10	115.2	41.37	108.6	39.08	102.2	37.20	98.9	35.29	95.6	33.68	89.0	31.80
	-8.5	-9.1	115.2	40.38	108.6	38.14	102.2	36.32	98.9	34.46	95.6	32.91	89.0	31.05
	-7.0	-7.6	115.2	38.93	108.6	36.74	102.2	35.01	98.9	33.22	95.6	31.76	89.0	29.95
	-5.0	-5.6	115.2	36.97	108.6	34.87	102.2	33.27	98.9	31.57	95.6	30.21	89.0	28.46
	-3.0	-3.7	115.2	35.01	108.6	32.99	102.2	31.50	98.9	29.91	95.6	28.66	89.0	26.98
	0.0	-0.7	115.2	32.09	108.6	30.18	102.2	28.88	98.9	27.42	95.6	26.35	89.0	24.74
	3.0	2.2	115.2	29.16	108.6	27.39	102.2	26.27	98.9	24.93	95.6	24.05	89.0	22.52
	5.0	4.1	115.2	27.20	108.6	25.51	102.2	24.51	98.9	23.29	95.6	22.50	89.0	21.05
	7.0	6.0	115.2	25.24	108.6	23.64	102.2	22.77	98.9	21.63	95.6	20.95	89.0	19.55
	9.0	7.9	115.2	22.79	108.6	21.34	102.2	20.56	98.9	19.53	95.6	18.92	89.0	17.66
	11.0	9.8	115.2	21.32	108.6	19.97	102.2	19.24	98.9	18.28	95.6	17.71	89.0	16.52
	13.0	11.8	115.2	20.03	108.6	18.76	102.2	18.05	98.9	17.16	95.6	16.63	89.0	15.52
15.0	13.7	115.2	18.95	108.6	17.74	102.2	17.10	98.9	16.23	95.6	15.73	89.0	14.68	

**Note**

1. TC: Total Capacity(kW), PI: Power Input(kW, Comp. + Outdoor fan motor)
2. Capacity tables show the average value of conditions which may occur.
3. The heating capacity table is based on the values expressed as Max. in the specification of the outdoor unit. (When measuring the Max. heating capacity, the setting status of the indoor unit is the same as that for measuring the heating capacity of the indoor unit.)

# 7. Capacity Tables

## ◆ ARUM680LTE5

Heating Capacity (68HP)

Combination (%)	Outdoor air temp.		Indoor air temp. °C DB											
			16		18		20		21		22		24	
	°C DB	°C WB	TC	PI	TC	PI	TC	PI	TC	PI	TC	PI	TC	PI
130	-24.8	-25	130.3	72.7	130.3	73.15	129.4	73.57	129.4	74.20	129.4	74.83	127.1	75.80
	-21.8	-22	160.0	73.62	160.0	74.11	158.9	74.53	158.9	75.18	158.9	75.80	155.8	76.76
	-19.8	-20	169.5	74.27	169.5	74.76	168.3	75.18	168.3	75.83	168.3	76.43	165.2	77.41
	-18.8	-19	173.3	74.59	173.3	75.08	172.2	75.50	172.2	76.15	172.2	76.76	168.8	77.73
	-16.7	-17	181.2	75.27	181.2	75.76	180.1	76.18	180.1	76.83	180.1	77.45	176.7	78.41
	-13.7	-15	192.5	76.25	192.5	76.73	191.4	77.15	191.4	77.80	191.4	78.41	187.7	75.57
	-11.8	-13	198.8	76.87	198.8	77.34	197.6	77.76	197.6	78.41	197.6	79.07	194.7	73.76
	-9.8	-11	205.3	77.50	205.3	77.99	204.2	78.41	204.2	79.07	204.2	79.72	202.0	71.87
	-9.5	-10	206.5	77.62	206.5	78.08	205.3	78.10	205.3	78.71	205.1	79.20	203.1	71.57
	-8.5	-9.1	210.5	77.92	210.5	78.41	209.3	77.07	209.3	77.68	208.4	78.20	206.8	70.62
	-7.0	-7.6	216.5	78.41	216.5	78.93	215.1	78.54	215.1	79.15	215.1	79.76	212.2	69.20
	-5.0	-5.6	224.4	78.51	224.4	79.03	223.0	79.15	223.0	79.76	223.0	80.37	219.5	67.31
	-3.0	-3.7	232.4	78.62	232.4	79.15	231.0	79.27	231.0	80.51	231.0	81.12	226.8	65.39
	0.0	-0.7	244.3	78.76	244.3	79.27	242.7	79.39	242.7	81.48	242.7	82.09	238.0	62.55
	3.0	2.2	256.3	78.92	256.3	79.39	254.6	79.51	254.6	82.63	254.6	83.24	238.9	59.71
	5.0	4.1	264.1	79.07	264.1	79.51	262.6	79.63	262.6	84.12	262.6	84.73	238.9	57.80
	7.0	6.0	272.0	79.11	272.0	79.63	270.3	79.75	270.3	85.41	270.3	86.02	238.9	55.91
9.0	7.9	273.4	79.15	273.4	79.75	272.6	79.87	272.6	86.70	272.6	87.31	238.9	54.57	
11.0	9.8	273.4	79.19	273.4	79.87	272.6	79.99	272.6	88.00	272.6	88.61	238.9	53.71	
13.0	11.8	273.4	79.23	273.4	79.99	272.6	80.11	272.6	89.30	272.6	89.91	238.9	52.79	
15.0	13.7	273.4	79.27	273.4	80.11	272.6	80.23	272.6	90.60	272.6	91.21	238.9	51.79	
120	-24.8	-25	129.4	73.15	129.4	73.57	128.5	74.20	128.5	74.83	128.5	75.80	126.2	76.48
	-21.8	-22	158.9	74.11	158.9	74.53	157.8	75.18	157.8	75.80	157.8	76.76	154.9	77.45
	-19.8	-20	168.3	74.76	168.3	75.18	167.2	75.83	167.2	76.43	167.2	77.41	164.0	78.08
	-18.8	-19	172.0	75.08	172.0	75.50	170.9	76.15	170.9	76.76	170.9	77.37	167.7	78.41
	-16.7	-17	179.9	75.76	179.9	76.18	178.7	76.83	178.7	77.45	178.7	78.41	175.3	76.57
	-13.7	-15	191.1	76.73	191.1	77.15	190.0	77.80	190.0	78.41	190.0	79.02	186.3	73.96
	-11.8	-13	197.4	77.34	197.4	77.76	196.2	78.41	196.2	79.02	196.2	79.63	193.3	72.31
	-9.8	-11	203.9	77.99	203.9	78.41	202.7	79.02	202.7	79.63	202.7	80.24	200.6	70.56
	-9.5	-10	205.1	78.08	205.1	78.50	203.9	79.09	203.9	79.70	203.9	80.31	201.7	70.29
	-8.5	-9.1	209.0	78.41	209.0	79.02	207.7	79.63	207.7	80.24	207.7	80.85	205.2	69.42
	-7.0	-7.6	215.0	78.51	215.0	79.14	213.6	79.75	213.6	80.36	213.6	80.97	210.7	68.11
	-5.0	-5.6	223.0	78.62	223.0	79.26	221.5	79.86	221.5	81.57	221.5	82.18	218.1	66.36
	-3.0	-3.7	230.7	78.76	230.7	79.38	229.3	80.47	229.3	82.78	229.3	83.39	224.4	64.61
	0.0	-0.7	242.6	78.90	242.6	79.50	241.0	81.08	241.0	83.99	241.0	84.60	232.4	62.00
	3.0	2.2	254.4	79.04	254.4	79.62	252.9	81.69	252.9	85.20	252.9	85.81	241.5	59.38
	5.0	4.1	262.3	79.18	262.3	79.74	260.9	82.30	260.9	86.81	260.9	87.42	241.5	57.63
	7.0	6.0	270.3	79.22	270.3	79.86	269.2	82.91	269.2	88.02	269.2	88.63	241.5	55.88
9.0	7.9	271.4	79.26	271.4	79.98	268.5	83.52	268.5	89.63	268.5	90.24	241.5	54.41	
11.0	9.8	271.4	79.30	271.4	80.10	268.5	84.13	268.5	91.24	268.5	91.85	241.5	53.41	
13.0	11.8	271.4	79.34	271.4	80.22	268.5	84.74	268.5	92.85	268.5	93.46	241.5	52.34	
15.0	13.7	271.4	79.38	271.4	80.34	268.5	85.35	268.5	94.46	268.5	95.07	241.5	51.18	
110	-24.8	-25	128.8	73.57	128.8	74.20	127.9	74.83	127.9	75.80	127.9	76.48	125.4	76.80
	-21.8	-22	158.0	74.53	158.0	75.18	156.9	75.80	156.9	76.76	156.9	77.45	154.0	77.76
	-19.8	-20	167.4	75.18	167.4	75.83	166.3	76.43	166.3	77.41	166.3	78.08	163.1	78.41
	-18.8	-19	171.1	75.50	171.1	76.15	170.0	76.76	170.0	77.37	170.0	78.02	166.8	77.43
	-16.7	-17	179.0	76.18	179.0	76.83	177.8	77.45	177.8	78.02	177.8	78.63	174.4	75.38
	-13.7	-15	190.0	77.15	190.0	77.80	188.8	78.41	188.8	79.02	188.8	79.63	188.8	72.45
	-11.8	-13	196.2	77.76	196.2	78.41	195.1	79.02	195.1	79.63	195.1	80.24	195.1	70.59
	-9.8	-11	202.8	78.41	202.8	79.02	201.6	79.63	201.6	80.24	201.6	80.85	200.6	68.64
	-9.5	-10	203.9	78.50	203.9	79.14	202.8	79.75	202.8	80.36	202.8	80.97	201.9	68.36
	-8.5	-9.1	207.9	78.74	207.9	79.38	206.7	79.99	206.7	81.57	206.7	82.18	201.9	67.37
	-7.0	-7.6	213.9	78.88	213.9	79.50	212.5	80.11	212.5	81.72	212.5	82.33	201.9	65.92
	-5.0	-5.6	221.6	79.02	221.6	79.62	220.2	80.72	220.2	82.33	220.2	82.94	201.9	63.95
	-3.0	-3.7	229.5	79.16	229.5	79.74	228.1	81.33	228.1	83.94	228.1	84.55	201.9	62.00
	0.0	-0.7	241.2	79.30	241.2	79.86	239.3	81.94	239.3	85.55	239.3	86.16	201.9	59.07
	3.0	2.2	252.9	79.44	252.9	80.00	251.3	82.55	251.3	87.16	251.3	87.77	201.9	56.13
	5.0	4.1	260.9	79.58	260.9	80.12	260.3	83.16	260.3	88.77	260.3	89.38	201.9	54.18
	7.0	6.0	269.9	79.62	269.9	80.24	260.3	83.77	260.3	90.38	260.3	90.99	201.9	52.23
9.0	7.9	269.9	79.66	269.9	80.36	260.3	84.38	260.3	91.99	260.3	92.60	201.9	50.62	
11.0	9.8	269.9	79.70	269.9	80.48	260.3	84.99	260.3	93.60	260.3	94.21	201.9	49.45	
13.0	11.8	269.9	79.74	269.9	80.60	260.3	85.60	260.3	95.21	260.3	95.82	201.9	48.20	
15.0	13.7	269.9	79.78	269.9	80.72	260.3	86.21	260.3	96.82	260.3	97.43	201.9	46.84	

# 7. Capacity Tables

Heating Capacity (68HP)

Combination (%)	Outdoor air temp.		Indoor air temp. °C DB											
			16		18		20		21		22		24	
	°C DB	°C WB	TC	PI	TC	PI	TC	PI	TC	PI	TC	PI	TC	PI
100	-24.8	-25	128.2	81.31	128.2	80.94	127.4	75.23	127.4	79.98	127.4	79.58	124.8	79.39
	-21.8	-22	157.2	80.73	157.2	80.35	156.3	77.60	156.3	79.40	156.3	80.07	153.2	78.81
	-19.8	-20	166.6	80.35	166.6	79.95	165.7	79.07	165.7	79.02	165.7	78.97	162.5	78.41
	-18.8	-19	170.3	80.16	169.4	79.77	169.4	79.40	169.4	78.81	169.4	78.41	166.0	77.21
	-16.7	-17	177.0	79.76	177.0	79.36	177.0	80.07	176.1	78.41	176.1	75.93	172.7	74.68
	-13.7	-15	189.1	79.17	189.1	78.78	188.0	78.41	188.0	74.82	188.0	72.37	184.5	71.04
	-11.8	-13	195.3	78.81	194.2	78.41	194.2	76.02	194.2	72.54	194.2	70.12	184.5	68.75
	-9.8	-11	201.7	78.41	201.7	75.74	200.8	73.49	200.8	70.15	198.0	67.75	184.5	66.33
	-9.5	-10	202.8	77.99	202.8	75.32	201.9	73.12	201.9	69.79	198.0	67.40	184.5	65.97
	-8.5	-9.1	206.8	76.60	206.8	73.99	205.9	71.85	204.8	68.59	198.0	66.22	184.5	64.75
	-7.0	-7.6	216.2	74.51	215.3	71.98	211.6	69.95	204.8	66.80	198.0	64.44	184.5	62.94
	-5.0	-5.6	225.6	71.70	223.3	69.31	211.6	67.44	204.8	64.39	198.0	62.08	184.5	60.53
	-3.0	-3.7	232.1	68.92	225.2	66.62	211.6	64.92	204.8	62.00	198.0	59.71	184.5	58.11
	0.0	-0.7	238.7	64.72	225.2	62.61	211.6	61.13	204.8	58.41	198.0	56.15	184.5	54.49
	3.0	2.2	238.7	60.52	225.2	58.58	211.6	57.35	204.8	54.82	198.0	52.60	184.5	50.87
	5.0	4.1	238.7	57.74	225.2	55.90	211.6	54.82	204.8	52.43	198.0	50.23	184.5	48.45
	7.0	6.0	238.7	54.93	225.2	53.21	211.6	52.29	204.8	50.03	198.0	47.87	184.5	46.03
	9.0	7.9	238.7	53.01	225.2	51.35	211.6	50.46	204.8	48.28	198.0	46.20	184.5	44.42
	11.0	9.8	238.7	51.54	225.2	49.92	211.6	49.06	204.8	46.92	198.0	44.89	184.5	43.19
	13.0	11.8	238.7	49.98	225.2	48.40	211.6	47.56	204.8	45.50	198.0	43.53	184.5	41.86
15.0	13.7	238.7	48.31	225.2	46.78	211.6	45.97	204.8	43.98	198.0	42.08	184.5	40.47	
90	-24.8	-25	127.7	72.34	127.7	73.29	126.8	73.99	126.8	74.29	126.8	74.95	124.5	75.92
	-21.8	-22	156.6	73.29	156.6	74.27	155.7	74.95	155.7	75.27	155.7	75.92	152.6	72.71
	-19.8	-20	166.0	73.95	166.0	74.92	164.9	75.60	164.9	75.92	164.9	75.92	161.8	70.57
	-18.8	-19	170.3	74.27	169.4	75.25	168.6	75.92	168.6	74.80	168.6	72.63	165.4	69.50
	-16.7	-17	177.0	74.95	177.0	75.92	176.4	73.60	176.4	72.43	176.4	70.34	168.6	67.24
	-13.7	-15	189.1	75.92	189.1	72.46	187.4	70.28	187.4	69.06	181.7	67.05	168.6	64.04
	-11.8	-13	195.3	73.55	194.2	70.28	193.4	68.16	187.7	66.91	181.7	64.98	168.6	62.00
	-9.8	-11	201.7	71.09	201.7	67.99	193.6	65.96	187.7	64.65	181.7	62.78	168.6	59.85
	-9.5	-10	202.8	70.70	202.8	67.63	193.6	65.62	187.7	64.31	181.7	62.45	168.6	59.52
	-8.5	-9.1	206.8	69.47	205.3	66.49	193.6	64.51	187.7	63.20	181.7	61.36	168.6	58.46
	-7.0	-7.6	216.2	67.60	205.6	64.76	193.6	62.86	187.7	61.50	181.7	59.71	168.6	56.84
	-5.0	-5.6	218.5	65.11	205.6	62.47	193.6	60.65	187.7	59.26	181.7	57.53	168.6	54.72
	-3.0	-3.7	218.5	62.63	205.6	60.17	193.6	58.42	187.7	57.00	181.7	55.33	168.6	52.57
	0.0	-0.7	218.5	58.91	205.6	56.71	193.6	55.10	187.7	53.62	181.7	52.04	168.6	49.36
	3.0	2.2	218.5	55.18	205.6	53.26	193.6	51.78	187.7	50.25	181.7	48.77	168.6	46.13
	5.0	4.1	218.5	52.69	205.6	50.96	193.6	49.57	187.7	47.99	181.7	46.57	168.6	43.98
	7.0	6.0	218.5	50.21	205.6	48.67	193.6	47.36	187.7	45.75	181.7	44.39	168.6	41.86
	9.0	7.9	218.5	47.86	205.6	46.39	193.6	45.14	187.7	43.60	181.7	42.30	168.6	39.90
	11.0	9.8	218.5	45.51	205.6	44.12	193.6	42.93	187.7	41.46	181.7	40.23	168.6	37.93
	13.0	11.8	218.5	43.17	205.6	41.84	193.6	40.72	187.7	39.33	181.7	38.16	168.6	35.97
15.0	13.7	218.5	40.82	205.6	39.57	193.6	38.49	187.7	37.18	181.7	36.07	168.6	34.02	
80	-24.8	-25	127.1	63.73	127.1	64.71	126.3	65.39	126.3	65.71	126.3	67.32	123.9	64.50
	-21.8	-22	154.9	64.71	154.9	65.67	154.9	66.34	154.9	67.32	154.9	64.50	150.7	61.77
	-19.8	-20	164.3	65.34	164.3	66.32	164.3	67.32	164.3	65.33	162.0	62.60	150.7	59.95
	-18.8	-19	168.0	65.67	168.0	67.32	168.0	66.31	167.8	64.33	162.0	61.66	150.7	59.06
	-16.7	-17	173.2	67.32	173.2	65.22	173.2	64.19	168.0	62.24	162.0	59.70	150.7	57.16
	-13.7	-15	181.1	64.22	177.5	62.21	173.2	61.17	168.0	59.25	162.0	56.86	150.7	54.43
	-11.8	-13	185.5	62.24	180.1	60.31	173.2	59.25	168.0	57.36	162.0	55.07	150.7	52.70
	-9.8	-11	190.4	60.17	182.6	58.33	173.2	57.24	168.0	55.37	162.0	53.18	150.7	50.89
	-9.5	-10	191.8	59.86	183.7	58.02	173.2	56.93	168.0	55.07	162.0	52.90	150.7	50.63
	-8.5	-9.1	193.7	58.83	184.5	57.02	173.2	55.93	168.0	54.06	162.0	51.97	150.7	49.72
	-7.0	-7.6	195.7	57.27	184.5	55.51	173.2	54.42	168.0	52.58	162.0	50.55	150.7	48.35
	-5.0	-5.6	195.7	55.20	184.5	53.53	173.2	52.39	168.0	50.58	162.0	48.65	150.7	46.54
	-3.0	-3.7	195.7	53.13	184.5	51.52	173.2	50.38	168.0	48.59	162.0	46.78	150.7	44.72
	0.0	-0.7	195.7	50.01	184.5	48.53	173.2	47.36	168.0	45.61	162.0	43.94	150.7	42.01
	3.0	2.2	195.7	46.91	184.5	45.52	173.2	44.32	168.0	42.60	162.0	41.12	150.7	39.29
	5.0	4.1	195.7	44.84	184.5	43.53	173.2	42.31	168.0	40.61	162.0	39.23	150.7	37.47
	7.0	6.0	195.7	42.77	184.5	41.52	173.2	40.30	168.0	38.63	162.0	37.35	150.7	35.66
	9.0	7.9	195.7	40.16	184.5	38.99	173.2	37.83	168.0	36.27	162.0	35.07	150.7	33.49
	11.0	9.8	195.7	37.27	184.5	36.19	173.2	35.13	168.0	33.65	162.0	32.54	150.7	31.07
	13.0	11.8	195.7	34.79	184.5	33.77	173.2	32.79	168.0	31.43	162.0	30.38	150.7	29.01
15.0	13.7	195.7	32.74	184.5	31.79	173.2	30.85	168.0	29.57	162.0	28.60	150.7	27.31	



# 7. Capacity Tables

Heating Capacity (68HP)

Combination (%)	Outdoor air temp.		Indoor air temp. °C DB											
			16		18		20		21		22		24	
	°C DB	°C WB	TC	PI	TC	PI	TC	PI	TC	PI	TC	PI	TC	PI
70	-24.8	-25	127.1	63.80	127.1	64.13	126.3	64.78	126.3	65.75	126.3	62.66	123.9	59.76
	-21.8	-22	148.4	64.78	148.4	65.10	147.5	65.75	142.4	62.66	138.1	59.76	129.0	56.97
	-19.8	-20	162.6	65.43	156.7	65.75	147.5	63.58	142.4	60.60	138.1	57.84	129.0	55.10
	-18.8	-19	166.0	65.75	156.7	64.64	147.5	62.49	142.4	59.56	138.1	56.86	129.0	54.16
	-16.7	-17	166.0	63.42	156.7	62.27	147.5	60.23	142.4	57.39	138.1	54.85	129.0	52.20
	-13.7	-15	166.0	60.12	156.7	58.92	147.5	56.97	142.4	54.32	138.1	51.95	129.0	49.39
	-11.8	-13	166.0	58.00	156.7	56.80	147.5	54.91	142.4	52.34	138.1	50.11	129.0	47.63
	-9.8	-11	166.0	55.80	156.7	54.54	147.5	52.75	142.4	50.28	138.1	48.19	129.0	45.76
	-9.5	-10	166.0	55.46	156.7	54.21	147.5	52.42	142.4	49.97	138.1	47.91	129.0	45.48
	-8.5	-9.1	166.0	54.37	156.7	53.09	147.5	51.34	142.4	48.94	138.1	46.93	129.0	44.54
	-7.0	-7.6	166.0	52.70	156.7	51.42	147.5	49.72	142.4	47.41	138.1	45.48	129.0	43.14
	-5.0	-5.6	166.0	50.50	156.7	49.18	147.5	47.54	142.4	45.34	138.1	43.56	129.0	41.28
	-3.0	-3.7	166.0	48.29	156.7	46.93	147.5	45.37	142.4	43.28	138.1	41.63	129.0	39.41
	0.0	-0.7	166.0	44.97	156.7	43.58	147.5	42.13	142.4	40.19	138.1	38.73	129.0	36.62
	3.0	2.2	166.0	41.65	156.7	40.23	147.5	38.87	142.4	37.11	138.1	35.84	129.0	33.80
	5.0	4.1	166.0	39.45	156.7	37.97	147.5	36.72	142.4	35.05	138.1	33.91	129.0	31.94
	7.0	6.0	166.0	37.24	156.7	35.74	147.5	34.54	142.4	32.99	138.1	31.99	129.0	30.07
	9.0	7.9	166.0	33.63	156.7	32.27	147.5	31.20	142.4	29.79	138.1	28.89	129.0	27.15
	11.0	9.8	166.0	31.32	156.7	30.04	147.5	29.04	142.4	27.73	138.1	26.90	129.0	25.28
	13.0	11.8	166.0	29.29	156.7	28.12	147.5	27.17	142.4	25.95	138.1	25.17	129.0	23.67
15.0	13.7	166.0	27.62	156.7	26.51	147.5	25.62	142.4	24.45	138.1	23.72	129.0	22.31	
60	-24.8	-25	126.5	63.08	126.5	63.73	125.6	64.71	122.2	61.38	117.9	58.27	110.5	55.34
	-21.8	-22	136.0	64.06	134.7	64.71	126.4	61.38	122.2	58.27	117.9	55.34	110.5	52.51
	-19.8	-20	142.4	64.71	134.7	62.36	126.4	59.17	122.2	56.20	117.9	53.38	110.5	50.61
	-18.8	-19	142.4	63.53	134.7	61.19	126.4	58.06	122.2	55.15	117.9	52.40	110.5	49.66
	-16.7	-17	142.4	61.04	134.7	58.72	126.4	55.73	122.2	52.96	117.9	50.36	110.5	47.68
	-13.7	-15	142.4	57.49	134.7	55.22	126.4	52.42	122.2	49.86	117.9	47.42	110.5	44.85
	-11.8	-13	142.4	55.25	134.7	52.98	126.4	50.30	122.2	47.87	117.9	45.57	110.5	43.06
	-9.8	-11	142.4	52.89	134.7	50.63	126.4	48.09	122.2	45.80	117.9	43.62	110.5	41.16
	-9.5	-10	142.4	52.53	134.7	50.29	126.4	47.76	122.2	45.49	117.9	43.31	110.5	40.88
	-8.5	-9.1	142.4	51.35	134.7	49.12	126.4	46.66	122.2	44.46	117.9	42.34	110.5	39.93
	-7.0	-7.6	142.4	49.59	134.7	47.36	126.4	45.01	122.2	42.89	117.9	40.88	110.5	38.51
	-5.0	-5.6	142.4	47.21	134.7	45.01	126.4	42.78	122.2	40.82	117.9	38.92	110.5	36.63
	-3.0	-3.7	142.4	44.86	134.7	42.66	126.4	40.57	122.2	38.75	117.9	36.96	110.5	34.73
	0.0	-0.7	142.4	41.30	134.7	39.15	126.4	37.26	122.2	35.62	117.9	34.03	110.5	31.91
	3.0	2.2	142.4	37.75	134.7	35.63	126.4	33.93	122.2	32.51	117.9	31.11	110.5	29.06
	5.0	4.1	142.4	35.40	134.7	33.28	126.4	31.72	122.2	30.44	117.9	29.16	110.5	27.18
	7.0	6.0	142.4	33.04	134.7	30.93	126.4	29.51	122.2	28.34	117.9	27.20	110.5	25.28
	9.0	7.9	142.4	29.48	134.7	27.62	126.4	26.31	122.2	25.29	117.9	24.26	110.5	22.56
	11.0	9.8	142.4	27.51	134.7	25.78	126.4	24.58	122.2	23.62	117.9	22.67	110.5	21.06
	13.0	11.8	142.4	25.78	134.7	24.14	126.4	23.03	122.2	22.12	117.9	21.22	110.5	19.74
15.0	13.7	142.4	24.36	134.7	22.83	126.4	21.75	122.2	20.91	117.9	20.06	110.5	18.66	
50	-24.8	-25	118.8	54.92	112.0	55.89	105.4	52.97	102.0	50.24	98.5	47.65	91.7	45.25
	-21.8	-22	118.8	55.89	112.0	52.97	105.4	50.24	102.0	47.65	98.5	45.25	91.7	42.93
	-19.8	-20	118.8	53.86	112.0	51.02	105.4	48.42	102.0	45.92	98.5	43.63	91.7	41.37
	-18.8	-19	118.8	52.83	112.0	50.04	105.4	47.51	102.0	45.08	98.5	42.83	91.7	40.60
	-16.7	-17	118.8	50.71	112.0	48.01	105.4	45.61	102.0	43.26	98.5	41.15	91.7	38.98
	-13.7	-15	118.8	47.67	112.0	45.08	105.4	42.87	102.0	40.67	98.5	38.75	91.7	36.66
	-11.8	-13	118.8	45.74	112.0	43.24	105.4	41.15	102.0	39.03	98.5	37.22	91.7	35.19
	-9.8	-11	118.8	43.71	112.0	41.29	105.4	39.31	102.0	37.30	98.5	35.60	91.7	33.63
	-9.5	-10	118.8	43.40	112.0	41.01	105.4	39.05	102.0	37.05	98.5	35.38	91.7	33.40
	-8.5	-9.1	118.8	42.38	112.0	40.03	105.4	38.14	102.0	36.19	98.5	34.57	91.7	32.62
	-7.0	-7.6	118.8	40.86	112.0	38.58	105.4	36.77	102.0	34.90	98.5	33.37	91.7	31.48
	-5.0	-5.6	118.8	38.83	112.0	36.63	105.4	34.96	102.0	33.18	98.5	31.76	91.7	29.92
	-3.0	-3.7	118.8	36.80	112.0	34.68	105.4	33.12	102.0	31.45	98.5	30.14	91.7	28.38
	0.0	-0.7	118.8	33.76	112.0	31.75	105.4	30.39	102.0	28.86	98.5	27.74	91.7	26.05
	3.0	2.2	118.8	30.71	112.0	28.85	105.4	27.68	102.0	26.27	98.5	25.34	91.7	23.73
	5.0	4.1	118.8	28.68	112.0	26.90	105.4	25.85	102.0	24.56	98.5	23.73	91.7	22.19
	7.0	6.0	118.8	26.65	112.0	24.95	105.4	24.03	102.0	22.83	98.5	22.11	91.7	20.64
	9.0	7.9	118.8	24.06	112.0	22.53	105.4	21.70	102.0	20.61	98.5	19.97	91.7	18.64
	11.0	9.8	118.8	22.51	112.0	21.08	105.4	20.30	102.0	19.30	98.5	18.69	91.7	17.44
	13.0	11.8	118.8	21.14	112.0	19.80	105.4	19.06	102.0	18.11	98.5	17.55	91.7	16.38
15.0	13.7	118.8	20.00	112.0	18.72	105.4	18.05	102.0	17.13	98.5	16.61	91.7	15.49	

**Note**

1. TC: Total Capacity(kW), PI : Power Input(kW, Comp. + Outdoor fan motor)
2. Capacity tables show the average value of conditions which may occur.
3. The heating capacity table is based on the values expressed as Max. in the specification of the outdoor unit. (When measuring the Max. heating capacity, the setting status of the indoor unit is the same as that for measuring the heating capacity of the indoor unit.)

# 7. Capacity Tables

## ◆ ARUM700LTE5

Heating Capacity (70HP)

Combination (%)	Outdoor air temp.		Indoor air temp. °C DB											
			16		18		20		21		22		24	
	°C DB	°C WB	TC	PI	TC	PI	TC	PI	TC	PI	TC	PI	TC	PI
130	-24.8	-25	134.2	75.6	134.2	76.12	133.4	76.55	133.4	77.20	133.4	77.84	130.9	78.84
	-21.8	-22	164.8	76.60	164.8	77.10	163.7	77.53	163.7	78.20	163.7	78.84	160.5	79.82
	-19.8	-20	174.5	77.27	174.5	77.77	173.3	78.20	173.3	78.86	173.3	79.49	170.1	80.49
	-18.8	-19	178.5	77.60	178.5	78.10	177.3	78.53	177.3	79.20	177.3	79.82	173.9	80.82
	-16.7	-17	186.6	78.29	186.6	78.79	185.4	79.22	185.4	79.89	185.4	80.53	181.9	81.51
	-13.7	-15	198.2	79.29	198.2	79.79	197.0	80.22	197.0	80.89	197.0	81.51	193.2	78.56
	-11.8	-13	204.7	79.94	204.7	80.42	203.5	80.85	203.5	81.51	203.5	79.54	200.5	76.68
	-9.8	-11	211.5	80.58	211.5	81.08	210.2	81.51	210.2	79.43	210.2	77.46	208.0	74.71
	-9.5	-10	212.7	80.70	212.7	81.18	211.4	81.19	211.4	79.11	211.2	77.14	209.2	74.40
	-8.5	-9.1	216.8	81.01	216.8	81.51	215.5	80.13	215.5	78.04	214.7	76.10	212.9	73.42
	-7.0	-7.6	222.9	81.51	222.9	79.98	221.5	78.53	221.5	76.48	221.5	74.52	218.5	71.94
	-5.0	-5.6	231.1	79.54	231.1	77.90	229.6	76.40	229.6	74.37	229.6	72.43	226.1	69.97
	-3.0	-3.7	239.3	77.58	239.3	75.84	237.8	74.26	237.8	72.26	237.8	70.35	233.6	67.98
	0.0	-0.7	251.6	74.60	251.6	72.75	249.9	71.07	249.9	69.11	249.9	67.22	245.1	65.03
	3.0	2.2	263.9	71.65	263.9	69.63	262.2	67.86	262.2	65.96	262.2	64.08	246.0	62.08
	5.0	4.1	271.9	69.66	271.9	67.57	270.4	65.73	270.4	63.85	264.2	62.00	246.0	60.09
	7.0	6.0	280.1	67.69	280.1	65.50	278.3	63.61	273.9	61.76	264.2	59.91	246.0	58.12
	9.0	7.9	281.6	66.07	281.6	63.93	280.7	62.08	273.9	60.28	264.2	58.49	246.0	56.73
	11.0	9.8	281.6	65.03	281.6	62.95	280.7	61.12	273.9	59.33	264.2	57.57	246.0	55.84
	13.0	11.8	281.6	63.93	281.6	61.85	280.7	60.06	273.9	58.32	264.2	56.58	246.0	54.88
15.0	13.7	281.6	62.71	281.6	60.69	280.7	58.93	273.9	57.20	264.2	55.51	246.0	53.84	
120	-24.8	-25	133.3	76.12	133.3	76.55	132.5	77.20	132.5	77.84	132.5	78.84	130.0	79.53
	-21.8	-22	163.6	77.10	163.6	77.53	162.5	78.20	162.5	78.84	162.5	79.82	159.5	80.53
	-19.8	-20	173.3	77.77	173.3	78.20	172.1	78.86	172.1	79.49	172.1	80.49	168.9	81.18
	-18.8	-19	177.1	78.10	177.1	78.53	175.9	79.20	175.9	79.82	175.9	80.82	172.7	81.51
	-16.7	-17	185.2	78.79	185.2	79.22	184.0	79.89	184.0	80.53	184.0	81.51	180.5	79.61
	-13.7	-15	196.8	79.79	196.8	80.22	195.6	80.89	195.6	81.51	195.6	78.68	191.8	76.89
	-11.8	-13	203.2	80.42	203.2	80.85	202.0	81.51	202.0	79.52	202.0	76.89	199.0	75.17
	-9.8	-11	210.0	81.08	210.0	81.51	208.8	79.32	208.8	77.41	208.8	75.01	206.6	73.35
	-9.5	-10	211.2	81.18	211.2	81.17	210.0	79.00	210.0	77.09	210.0	74.72	207.7	73.07
	-8.5	-9.1	215.3	81.51	215.3	80.01	213.8	77.90	213.8	76.05	213.8	73.79	211.3	72.17
	-7.0	-7.6	221.4	79.81	221.4	78.28	220.0	76.25	220.0	74.46	220.0	72.37	217.0	70.81
	-5.0	-5.6	229.6	77.52	229.6	75.96	228.1	74.05	228.1	72.35	228.1	70.47	224.5	68.99
	-3.0	-3.7	237.6	75.24	237.6	73.67	236.1	71.86	236.1	70.26	236.1	68.59	231.1	67.17
	0.0	-0.7	249.8	71.82	249.8	70.20	248.1	68.56	248.1	67.09	248.1	65.75	231.1	64.45
	3.0	2.2	261.9	68.41	261.9	66.73	260.4	65.26	256.6	63.93	248.7	62.92	231.1	61.73
	5.0	4.1	270.1	66.13	270.1	64.42	265.5	63.09	256.6	61.82	248.7	61.04	231.1	59.91
	7.0	6.0	278.3	63.84	276.5	62.11	265.5	60.89	256.6	59.71	248.7	59.16	231.1	58.09
	9.0	7.9	279.4	62.14	276.5	60.46	265.5	59.28	256.6	58.15	248.7	57.60	231.1	56.56
	11.0	9.8	279.4	61.01	276.5	59.36	265.5	58.18	256.6	57.08	248.7	56.53	231.1	55.52
	13.0	11.8	279.4	59.77	276.5	58.15	265.5	57.02	256.6	55.92	248.7	55.40	231.1	54.41
15.0	13.7	279.4	58.46	276.5	56.87	265.5	55.75	256.6	54.68	248.7	54.16	231.1	53.20	
110	-24.8	-25	132.7	76.55	132.7	77.20	131.8	77.84	131.8	78.84	131.8	79.53	129.2	79.87
	-21.8	-22	162.7	77.53	162.7	78.20	161.6	78.84	161.6	79.82	161.6	80.53	158.6	80.85
	-19.8	-20	172.4	78.20	172.4	78.86	171.3	79.49	171.3	80.49	171.3	81.18	168.0	81.51
	-18.8	-19	176.2	78.53	176.2	79.20	175.0	79.82	175.0	80.82	175.0	81.51	171.8	80.50
	-16.7	-17	184.3	79.22	184.3	79.89	183.1	80.53	183.1	81.51	183.1	79.45	179.6	78.36
	-13.7	-15	195.6	80.22	195.6	80.89	194.5	81.51	194.5	78.39	194.5	76.48	194.5	75.32
	-11.8	-13	202.1	80.85	202.1	81.51	200.9	79.31	200.9	76.40	200.9	74.60	200.9	73.39
	-9.8	-11	208.8	81.51	208.8	79.03	207.6	77.00	207.6	74.31	207.6	72.63	206.5	71.36
	-9.5	-10	210.0	81.11	210.0	78.65	208.8	76.63	208.8	73.99	208.8	72.34	207.9	71.07
	-8.5	-9.1	214.1	79.78	214.1	77.41	212.9	75.47	212.9	72.95	212.9	71.34	207.9	70.04
	-7.0	-7.6	220.2	77.76	220.2	75.55	218.8	73.73	218.8	71.39	218.8	69.86	207.9	68.53
	-5.0	-5.6	228.2	75.09	228.2	73.04	226.7	71.42	226.7	69.31	222.6	67.89	207.9	66.48
	-3.0	-3.7	236.4	72.40	236.4	70.56	234.9	69.08	230.5	67.20	222.6	65.90	207.9	64.45
	0.0	-0.7	248.4	68.38	248.4	66.82	238.2	65.60	230.5	64.07	222.6	62.95	207.9	61.41
	3.0	2.2	260.5	64.36	253.9	63.09	238.2	62.11	230.5	60.95	222.6	59.97	207.9	58.35
	5.0	4.1	268.6	61.68	253.9	60.60	238.2	59.79	230.5	58.84	222.6	58.00	207.9	56.33
	7.0	6.0	268.6	58.99	253.9	58.12	238.2	57.46	230.5	56.76	222.6	56.04	207.9	54.30
	9.0	7.9	268.6	57.17	253.9	56.32	238.2	55.69	230.5	55.00	222.6	54.30	207.9	52.63
	11.0	9.8	268.6	55.86	253.9	55.02	238.2	54.39	230.5	53.73	222.6	53.03	207.9	51.41
	13.0	11.8	268.6	54.42	253.9	53.61	238.2	53.00	230.5	52.36	222.6	51.70	207.9	50.11
15.0	13.7	268.6	52.91	253.9	52.11	238.2	51.53	230.5	50.89	222.6	50.25	207.9	48.69	

# 7. Capacity Tables

Heating Capacity (70HP)

Combination (%)	Outdoor air temp.		Indoor air temp. °C DB											
			16		18		20		21		22		24	
	°C DB	°C WB	TC	PI	TC	PI	TC	PI	TC	PI	TC	PI	TC	PI
100	-24.8	-25	132.1	84.58	132.1	84.18	131.2	78.23	131.2	83.18	131.2	82.75	128.6	82.55
	-21.8	-22	161.9	83.97	161.9	83.57	161.0	80.70	161.0	82.56	161.0	83.25	157.8	81.93
	-19.8	-20	171.6	83.57	171.6	83.15	170.6	82.23	170.6	82.16	170.6	82.10	167.4	81.51
	-18.8	-19	175.3	83.37	174.4	82.95	174.4	82.56	174.4	81.94	174.4	81.51	170.9	80.27
	-16.7	-17	182.3	82.94	182.3	82.52	182.3	83.25	181.3	81.51	181.3	78.94	177.8	77.63
	-13.7	-15	194.7	82.32	194.7	81.90	193.6	81.51	193.6	77.78	193.6	75.24	190.0	73.85
	-11.8	-13	201.1	81.93	200.0	81.51	200.0	79.03	200.0	75.41	200.0	72.90	190.0	71.48
	-9.8	-11	207.7	81.51	207.7	78.73	206.7	76.40	206.7	72.92	203.9	70.44	190.0	68.96
	-9.5	-10	208.8	81.08	208.8	78.31	207.9	76.01	207.9	72.55	203.9	70.06	190.0	68.58
	-8.5	-9.1	212.9	79.63	212.9	76.92	212.0	74.69	210.9	71.31	203.9	68.84	190.0	67.32
	-7.0	-7.6	222.6	77.46	221.7	74.83	217.9	72.72	210.9	69.45	203.9	66.99	190.0	65.44
	-5.0	-5.6	232.3	74.54	230.0	72.05	217.9	70.11	210.9	66.94	203.9	64.54	190.0	62.92
	-3.0	-3.7	239.0	71.65	231.9	69.25	217.9	67.49	210.9	64.45	203.9	62.08	190.0	60.41
	0.0	-0.7	245.8	67.28	231.9	65.08	217.9	63.55	210.9	60.72	203.9	58.38	190.0	56.65
	3.0	2.2	245.8	62.92	231.9	60.90	217.9	59.62	210.9	56.99	203.9	54.68	190.0	52.88
	5.0	4.1	245.8	60.03	231.9	58.12	217.9	56.99	210.9	54.50	203.9	52.22	190.0	50.37
	7.0	6.0	245.8	57.11	231.9	55.32	217.9	54.36	210.9	52.01	203.9	49.76	190.0	47.85
	9.0	7.9	245.8	55.11	231.9	53.38	217.9	52.45	210.9	50.19	203.9	48.02	190.0	46.18
	11.0	9.8	245.8	53.58	231.9	51.90	217.9	51.00	210.9	48.78	203.9	46.67	190.0	44.90
	13.0	11.8	245.8	51.96	231.9	50.31	217.9	49.44	210.9	47.30	203.9	45.25	190.0	43.52
15.0	13.7	245.8	50.22	231.9	48.64	217.9	47.79	210.9	45.72	203.9	43.75	190.0	42.07	
90	-24.8	-25	131.5	75.26	131.5	76.24	130.7	76.95	130.7	77.27	130.7	77.93	128.3	78.94
	-21.8	-22	161.3	76.24	161.3	77.24	160.4	77.93	160.4	78.27	160.4	78.94	157.2	75.60
	-19.8	-20	170.9	76.91	170.9	77.91	169.8	78.60	169.8	78.94	169.8	76.65	166.6	73.37
	-18.8	-19	175.3	77.24	174.4	78.24	173.6	78.94	173.6	77.77	173.6	75.51	170.3	72.26
	-16.7	-17	182.3	77.93	182.3	78.94	181.6	76.52	181.6	75.31	181.6	73.13	173.6	69.91
	-13.7	-15	194.7	78.94	194.7	75.34	192.9	73.07	192.9	71.80	187.1	69.71	173.6	66.58
	-11.8	-13	201.1	76.47	200.0	73.07	199.2	70.87	193.2	69.56	187.1	67.56	173.6	64.46
	-9.8	-11	207.7	73.91	207.7	70.69	199.4	68.57	193.2	67.22	187.1	65.27	173.6	62.23
	-9.5	-10	208.8	73.51	208.8	70.32	199.4	68.23	193.2	66.87	187.1	64.92	173.6	61.88
	-8.5	-9.1	212.9	72.22	211.5	69.12	199.4	67.07	193.2	65.70	187.1	63.79	173.6	60.78
	-7.0	-7.6	222.6	70.28	211.8	67.33	199.4	65.35	193.2	63.94	187.1	62.08	173.6	59.10
	-5.0	-5.6	225.0	67.70	211.8	64.94	199.4	63.05	193.2	61.61	187.1	59.81	173.6	56.89
	-3.0	-3.7	225.0	65.11	211.8	62.56	199.4	60.74	193.2	59.26	187.1	57.52	173.6	54.65
	0.0	-0.7	225.0	61.25	211.8	58.96	199.4	57.28	193.2	55.75	187.1	54.10	173.6	51.32
	3.0	2.2	225.0	57.36	211.8	55.37	199.4	53.83	193.2	52.24	187.1	50.70	173.6	47.96
	5.0	4.1	225.0	54.78	211.8	52.98	199.4	51.53	193.2	49.89	187.1	48.41	173.6	45.73
	7.0	6.0	225.0	52.19	211.8	50.60	199.4	49.24	193.2	47.56	187.1	46.15	173.6	43.51
	9.0	7.9	225.0	49.75	211.8	48.22	199.4	46.92	193.2	45.33	187.1	43.97	173.6	41.48
	11.0	9.8	225.0	47.31	211.8	45.87	199.4	44.63	193.2	43.10	187.1	41.82	173.6	39.43
	13.0	11.8	225.0	44.88	211.8	43.49	199.4	42.33	193.2	40.89	187.1	39.67	173.6	37.40
15.0	13.7	225.0	42.44	211.8	41.13	199.4	40.01	193.2	38.65	187.1	37.50	173.6	35.36	
80	-24.8	-25	131.0	66.31	131.0	67.32	130.1	68.01	130.1	68.34	130.1	69.99	127.7	67.06
	-21.8	-22	159.6	67.32	159.6	68.30	159.6	68.99	159.6	69.99	159.6	67.06	155.1	64.22
	-19.8	-20	169.2	67.96	169.2	68.96	169.2	69.99	169.2	67.93	166.8	65.09	155.1	62.33
	-18.8	-19	172.9	68.30	172.9	69.99	172.9	68.94	172.8	66.88	166.8	64.10	155.1	61.40
	-16.7	-17	178.3	69.99	178.3	67.81	178.3	66.74	173.0	64.71	166.8	62.06	155.1	59.43
	-13.7	-15	186.5	66.76	182.7	64.68	178.3	63.60	173.0	61.60	166.8	59.11	155.1	56.59
	-11.8	-13	191.0	64.71	185.4	62.71	178.3	61.60	173.0	59.63	166.8	57.25	155.1	54.79
	-9.8	-11	196.1	62.56	188.1	60.64	178.3	59.51	173.0	57.57	166.8	55.28	155.1	52.91
	-9.5	-10	197.5	62.24	189.2	60.32	178.3	59.19	173.0	57.25	166.8	54.99	155.1	52.64
	-8.5	-9.1	199.5	61.16	190.0	59.28	178.3	58.15	173.0	56.21	166.8	54.03	155.1	51.69
	-7.0	-7.6	201.5	59.54	190.0	57.71	178.3	56.58	173.0	54.67	166.8	52.55	155.1	50.27
	-5.0	-5.6	201.5	57.39	190.0	55.65	178.3	54.47	173.0	52.58	166.8	50.58	155.1	48.38
	-3.0	-3.7	201.5	55.24	190.0	53.56	178.3	52.37	173.0	50.52	166.8	48.64	155.1	46.50
	0.0	-0.7	201.5	51.99	190.0	50.45	178.3	49.24	173.0	47.41	166.8	45.68	155.1	43.68
	3.0	2.2	201.5	48.77	190.0	47.32	178.3	46.08	173.0	44.29	166.8	42.75	155.1	40.84
	5.0	4.1	201.5	46.62	190.0	45.26	178.3	43.99	173.0	42.22	166.8	40.78	155.1	38.96
	7.0	6.0	201.5	44.47	190.0	43.17	178.3	41.90	173.0	40.16	166.8	38.83	155.1	37.07
	9.0	7.9	201.5	41.75	190.0	40.54	178.3	39.33	173.0	37.70	166.8	36.46	155.1	34.81
	11.0	9.8	201.5	38.74	190.0	37.62	178.3	36.52	173.0	34.99	166.8	33.83	155.1	32.30
	13.0	11.8	201.5	36.17	190.0	35.11	178.3	34.09	173.0	32.67	166.8	31.58	155.1	30.16
15.0	13.7	201.5	34.04	190.0	33.05	178.3	32.07	173.0	30.74	166.8	29.73	155.1	28.39	

# 7. Capacity Tables

Heating Capacity (70HP)

Combination (%)	Outdoor air temp.		Indoor air temp. °C DB											
			16		18		20		21		22		24	
	°C DB	°C WB	TC	PI	TC	PI	TC	PI	TC	PI	TC	PI	TC	PI
70	-24.8	-25	131.0	66.36	131.0	66.69	130.1	67.36	130.1	68.36	130.1	65.15	127.7	62.13
	-21.8	-22	152.8	67.36	152.8	67.70	151.9	68.36	146.6	65.15	142.3	62.13	132.8	59.23
	-19.8	-20	167.3	68.03	161.3	68.36	151.9	66.10	146.6	63.00	142.3	60.13	132.8	57.29
	-18.8	-19	171.0	68.36	161.3	67.20	151.9	64.97	146.6	61.93	142.3	59.12	132.8	56.31
	-16.7	-17	171.0	65.93	161.3	64.74	151.9	62.62	146.6	59.67	142.3	57.03	132.8	54.27
	-13.7	-15	171.0	62.50	161.3	61.26	151.9	59.23	146.6	56.47	142.3	54.01	132.8	51.35
	-11.8	-13	171.0	60.30	161.3	59.05	151.9	57.09	146.6	54.42	142.3	52.10	132.8	49.52
	-9.8	-11	171.0	58.01	161.3	56.71	151.9	54.85	146.6	52.28	142.3	50.10	132.8	47.58
	-9.5	-10	171.0	57.66	161.3	56.36	151.9	54.50	146.6	51.96	142.3	49.81	132.8	47.29
	-8.5	-9.1	171.0	56.53	161.3	55.20	151.9	53.37	146.6	50.88	142.3	48.79	132.8	46.31
	-7.0	-7.6	171.0	54.79	161.3	53.46	151.9	51.69	146.6	49.29	142.3	47.29	132.8	44.85
	-5.0	-5.6	171.0	52.50	161.3	51.13	151.9	49.43	146.6	47.14	142.3	45.29	132.8	42.91
	-3.0	-3.7	171.0	50.20	161.3	48.79	151.9	47.17	146.6	45.00	142.3	43.28	132.8	40.97
	0.0	-0.7	171.0	46.75	161.3	45.31	151.9	43.80	146.6	41.78	142.3	40.27	132.8	38.07
	3.0	2.2	171.0	43.30	161.3	41.82	151.9	40.41	146.6	38.58	142.3	37.26	132.8	35.14
	5.0	4.1	171.0	41.01	161.3	39.48	151.9	38.17	146.6	36.44	142.3	35.25	132.8	33.20
	7.0	6.0	171.0	38.72	161.3	37.16	151.9	35.91	146.6	34.29	142.3	33.25	132.8	31.26
	9.0	7.9	171.0	34.96	161.3	33.55	151.9	32.44	146.6	30.97	142.3	30.04	132.8	28.22
	11.0	9.8	171.0	32.56	161.3	31.23	151.9	30.19	146.6	28.83	142.3	27.96	132.8	26.28
	13.0	11.8	171.0	30.45	161.3	29.23	151.9	28.25	146.6	26.98	142.3	26.16	132.8	24.60
15.0	13.7	171.0	28.71	161.3	27.56	151.9	26.63	146.6	25.42	142.3	24.66	132.8	23.19	
60	-24.8	-25	130.2	65.62	130.2	66.29	129.4	67.29	125.8	63.83	121.4	60.60	113.7	57.54
	-21.8	-22	140.0	66.62	138.7	67.29	130.2	63.83	125.8	60.60	121.4	57.54	113.7	54.60
	-19.8	-20	146.6	67.29	138.7	64.85	130.2	61.53	125.8	58.44	121.4	55.51	113.7	52.63
	-18.8	-19	146.6	66.07	138.7	63.63	130.2	60.37	125.8	57.34	121.4	54.49	113.7	51.64
	-16.7	-17	146.6	63.48	138.7	61.06	130.2	57.95	125.8	55.07	121.4	52.36	113.7	49.58
	-13.7	-15	146.6	59.78	138.7	57.42	130.2	54.51	125.8	51.84	121.4	49.31	113.7	46.64
	-11.8	-13	146.6	57.45	138.7	55.09	130.2	52.31	125.8	49.78	121.4	47.39	113.7	44.77
	-9.8	-11	146.6	55.00	138.7	52.65	130.2	50.01	125.8	47.62	121.4	45.35	113.7	42.80
	-9.5	-10	146.6	54.62	138.7	52.30	130.2	49.66	125.8	47.30	121.4	45.04	113.7	42.51
	-8.5	-9.1	146.6	53.40	138.7	51.07	130.2	48.52	125.8	46.22	121.4	44.02	113.7	41.52
	-7.0	-7.6	146.6	51.56	138.7	49.24	130.2	46.80	125.8	44.60	121.4	42.50	113.7	40.04
	-5.0	-5.6	146.6	49.09	138.7	46.80	130.2	44.48	125.8	42.44	121.4	40.47	113.7	38.09
	-3.0	-3.7	146.6	46.64	138.7	44.35	130.2	42.18	125.8	40.29	121.4	38.43	113.7	36.11
	0.0	-0.7	146.6	42.94	138.7	40.71	130.2	38.74	125.8	37.03	121.4	35.38	113.7	33.17
	3.0	2.2	146.6	39.25	138.7	37.04	130.2	35.28	125.8	33.80	121.4	32.35	113.7	30.21
	5.0	4.1	146.6	36.80	138.7	34.60	130.2	32.98	125.8	31.64	121.4	30.31	113.7	28.26
	7.0	6.0	146.6	34.35	138.7	32.16	130.2	30.67	125.8	29.47	121.4	28.28	113.7	26.29
	9.0	7.9	146.6	30.65	138.7	28.71	130.2	27.36	125.8	26.29	121.4	25.22	113.7	23.45
	11.0	9.8	146.6	28.60	138.7	26.80	130.2	25.56	125.8	24.55	121.4	23.56	113.7	21.89
	13.0	11.8	146.6	26.80	138.7	25.10	130.2	23.94	125.8	22.99	121.4	22.06	113.7	20.53
15.0	13.7	146.6	25.33	138.7	23.73	130.2	22.61	125.8	21.74	121.4	20.85	113.7	19.40	
50	-24.8	-25	122.3	57.11	115.3	58.11	108.5	55.07	105.0	52.23	101.5	49.54	94.5	47.04
	-21.8	-22	122.3	58.11	115.3	55.07	108.5	52.23	105.0	49.54	101.5	47.04	94.5	44.63
	-19.8	-20	122.3	56.00	115.3	53.04	108.5	50.34	105.0	47.74	101.5	45.36	94.5	43.02
	-18.8	-19	122.3	54.93	115.3	52.03	108.5	49.39	105.0	46.86	101.5	44.53	94.5	42.21
	-16.7	-17	122.3	52.72	115.3	49.91	108.5	47.42	105.0	44.98	101.5	42.78	94.5	40.52
	-13.7	-15	122.3	49.56	115.3	46.87	108.5	44.57	105.0	42.29	101.5	40.29	94.5	38.11
	-11.8	-13	122.3	47.56	115.3	44.95	108.5	42.78	105.0	40.58	101.5	38.69	94.5	36.58
	-9.8	-11	122.3	45.44	115.3	42.93	108.5	40.87	105.0	38.78	101.5	37.02	94.5	34.96
	-9.5	-10	122.3	45.12	115.3	42.63	108.5	40.60	105.0	38.52	101.5	36.78	94.5	34.73
	-8.5	-9.1	122.3	44.06	115.3	41.62	108.5	39.65	105.0	37.62	101.5	35.94	94.5	33.92
	-7.0	-7.6	122.3	42.49	115.3	40.11	108.5	38.23	105.0	36.29	101.5	34.69	94.5	32.72
	-5.0	-5.6	122.3	40.37	115.3	38.08	108.5	36.34	105.0	34.49	101.5	33.02	94.5	31.11
	-3.0	-3.7	122.3	38.26	115.3	36.05	108.5	34.44	105.0	32.70	101.5	31.34	94.5	29.51
	0.0	-0.7	122.3	35.09	115.3	33.01	108.5	31.60	105.0	30.00	101.5	28.84	94.5	27.08
	3.0	2.2	122.3	31.93	115.3	29.99	108.5	28.78	105.0	27.31	101.5	26.35	94.5	24.67
	5.0	4.1	122.3	29.82	115.3	27.96	108.5	26.87	105.0	25.53	101.5	24.67	94.5	23.07
	7.0	6.0	122.3	27.70	115.3	25.94	108.5	24.98	105.0	23.74	101.5	22.99	94.5	21.45
	9.0	7.9	122.3	25.01	115.3	23.42	108.5	22.56	105.0	21.43	101.5	20.76	94.5	19.37
	11.0	9.8	122.3	23.40	115.3	21.92	108.5	21.11	105.0	20.06	101.5	19.43	94.5	18.13
	13.0	11.8	122.3	21.98	115.3	20.58	108.5	19.81	105.0	18.83	101.5	18.25	94.5	17.03
15.0	13.7	122.3	20.79	115.3	19.46	108.5	18.76	105.0	17.81	101.5	17.26	94.5	16.11	

**Note**

1. TC: Total Capacity(kW), PI: Power Input(kW, Comp. + Outdoor fan motor)
2. Capacity tables show the average value of conditions which may occur.
3. The heating capacity table is based on the values expressed as Max. in the specification of the outdoor unit. (When measuring the Max. heating capacity, the setting status of the indoor unit is the same as that for measuring the heating capacity of the indoor unit.)

# 7. Capacity Tables

## ◆ ARUM720LTE5

Heating Capacity (72HP)

Combination (%)	Outdoor air temp.		Indoor air temp. °C DB											
			16		18		20		21		22		24	
	°C DB	°C WB	TC	PI	TC	PI	TC	PI	TC	PI	TC	PI	TC	PI
130	-24.8	-25	136.2	77.2	136.2	77.79	135.3	78.33	135.3	79.14	135.3	79.95	132.9	81.21
	-21.8	-22	168.0	78.39	168.0	79.02	166.8	79.56	166.8	80.40	166.8	81.21	163.5	82.44
	-19.8	-20	178.2	79.23	178.2	79.86	177.0	80.40	177.0	81.24	177.0	82.02	173.7	83.28
	-18.8	-19	182.4	79.65	182.4	80.28	181.2	80.82	181.2	81.66	181.2	82.44	177.6	83.70
	-16.7	-17	190.8	80.52	190.8	81.15	189.6	81.69	189.6	82.53	189.6	83.34	186.0	84.57
	-13.7	-15	202.8	81.78	202.8	82.41	201.6	82.95	201.6	83.79	201.6	84.57	197.7	81.51
	-11.8	-13	209.4	82.59	209.4	83.19	208.2	83.73	208.2	84.57	208.2	85.39	205.2	79.56
	-9.8	-11	216.3	83.40	216.3	84.03	215.1	84.57	215.1	85.41	215.1	86.24	213.0	77.52
	-9.5	-10	217.5	83.55	217.5	84.15	216.3	84.74	216.3	85.58	216.3	86.42	214.2	77.19
	-8.5	-9.1	221.7	83.94	221.7	84.57	220.5	85.13	220.5	85.97	219.6	86.81	218.1	76.17
	-7.0	-7.6	228.0	84.57	228.0	85.28	226.5	85.82	226.5	86.66	226.5	87.50	223.8	74.64
	-5.0	-5.6	236.4	85.23	236.4	85.82	234.9	86.37	234.9	87.21	234.9	88.05	231.6	72.60
	-3.0	-3.7	244.8	85.89	244.8	86.44	243.3	86.98	243.3	87.82	243.3	88.66	239.4	70.53
	0.0	-0.7	257.4	87.40	257.4	88.05	255.6	88.60	255.6	89.44	255.6	90.28	251.4	67.47
	3.0	2.2	270.0	89.00	270.0	89.65	268.2	90.20	268.2	91.04	268.2	91.88	257.2	64.41
	5.0	4.1	278.1	90.27	278.1	90.92	276.6	91.47	276.6	92.31	276.6	93.15	265.0	62.34
	7.0	6.0	286.5	91.54	286.5	92.19	284.7	92.74	284.7	93.58	284.7	94.42	272.8	60.30
	9.0	7.9	288.0	92.19	288.0	92.84	287.1	93.39	287.1	94.23	287.1	95.07	280.6	58.26
	11.0	9.8	288.0	92.84	288.0	93.49	287.1	94.04	287.1	94.88	287.1	95.72	280.6	57.93
	13.0	11.8	288.0	93.49	288.0	94.14	287.1	94.69	287.1	95.53	287.1	96.37	280.6	57.60
15.0	13.7	288.0	94.14	288.0	94.79	287.1	95.34	287.1	96.18	287.1	97.02	280.6	57.27	
120	-24.8	-25	135.3	77.79	135.3	78.33	134.4	79.14	134.4	79.95	134.4	81.21	132.0	82.08
	-21.8	-22	166.8	79.02	166.8	79.56	165.6	80.40	165.6	81.21	165.6	82.44	162.6	83.34
	-19.8	-20	177.0	79.86	177.0	80.40	175.8	81.24	175.8	82.02	175.8	83.28	172.5	84.15
	-18.8	-19	180.9	80.28	180.9	80.82	179.7	81.66	179.7	82.44	179.7	83.70	176.4	84.57
	-16.7	-17	189.3	81.15	189.3	81.69	188.1	82.53	188.1	83.34	188.1	84.57	184.5	82.59
	-13.7	-15	201.3	82.41	201.3	82.95	200.1	83.79	200.1	84.57	200.1	85.41	196.2	79.77
	-11.8	-13	207.9	83.19	207.9	83.73	206.7	84.57	206.7	85.41	206.7	86.24	203.7	78.00
	-9.8	-11	214.8	84.03	214.8	84.57	213.6	85.41	213.6	86.24	213.6	87.08	211.5	76.11
	-9.5	-10	216.0	84.15	216.0	84.74	214.8	85.58	214.8	86.42	214.8	87.26	212.7	75.81
	-8.5	-9.1	220.2	84.57	220.2	85.28	218.7	85.82	218.7	86.66	218.7	87.50	216.3	74.88
	-7.0	-7.6	226.5	85.28	226.5	85.92	225.0	86.47	225.0	87.31	225.0	88.15	222.3	73.47
	-5.0	-5.6	234.9	85.92	234.9	86.57	233.4	87.12	233.4	87.96	233.4	88.80	230.1	71.58
	-3.0	-3.7	243.0	86.57	243.0	87.22	241.5	87.81	241.5	88.65	241.5	89.49	237.9	69.69
	0.0	-0.7	255.6	88.05	255.6	88.70	253.8	89.25	253.8	90.09	253.8	90.93	245.7	66.87
	3.0	2.2	267.9	89.65	267.9	90.30	266.4	90.90	266.4	91.74	266.4	92.58	253.5	64.05
	5.0	4.1	276.3	90.92	276.3	91.57	275.1	92.12	275.1	92.96	275.1	93.80	261.3	62.16
	7.0	6.0	284.7	92.19	284.7	92.84	283.5	93.39	283.5	94.23	283.5	95.07	269.1	60.27
	9.0	7.9	285.9	92.84	285.9	93.49	284.7	94.04	284.7	94.88	284.7	95.72	269.1	58.68
	11.0	9.8	285.9	93.49	285.9	94.14	284.7	94.69	284.7	95.53	284.7	96.37	269.1	57.60
	13.0	11.8	285.9	94.14	285.9	94.79	284.7	95.34	284.7	96.18	284.7	97.02	269.1	56.46
15.0	13.7	285.9	94.79	285.9	95.44	284.7	96.03	284.7	96.87	284.7	97.71	269.1	55.20	
110	-24.8	-25	134.7	78.33	134.7	79.14	133.8	79.95	133.8	81.21	133.8	82.08	131.1	82.50
	-21.8	-22	165.9	79.56	165.9	80.40	164.7	81.21	164.7	82.44	164.7	83.34	161.7	83.73
	-19.8	-20	176.1	80.40	176.1	81.24	174.9	82.02	174.9	83.28	174.9	84.15	171.6	84.57
	-18.8	-19	180.0	80.82	180.0	81.66	178.8	82.44	178.8	83.70	178.8	84.57	175.5	83.52
	-16.7	-17	188.4	81.69	188.4	82.53	187.2	83.34	187.2	84.57	187.2	85.41	183.6	81.30
	-13.7	-15	200.1	82.95	200.1	83.79	198.9	84.57	198.9	85.41	198.9	86.24	195.6	78.15
	-11.8	-13	206.7	83.73	206.7	84.57	205.5	85.41	205.5	86.24	205.5	87.08	202.2	76.14
	-9.8	-11	213.6	84.57	213.6	85.41	212.4	86.24	212.4	87.08	212.4	87.92	209.0	74.04
	-9.5	-10	214.8	84.74	214.8	85.58	213.6	86.42	213.6	87.26	213.6	88.10	210.2	73.74
	-8.5	-9.1	219.0	85.28	219.0	86.02	217.8	86.86	217.8	87.70	217.8	88.54	217.4	72.66
	-7.0	-7.6	225.3	86.02	225.3	86.76	223.8	87.60	223.8	88.44	223.8	89.28	225.0	71.10
	-5.0	-5.6	233.4	86.76	233.4	87.50	231.9	88.34	231.9	89.18	231.9	90.02	233.1	69.69
	-3.0	-3.7	241.8	87.50	241.8	88.24	240.3	89.08	240.3	90.02	240.3	90.96	241.5	66.87
	0.0	-0.7	254.1	89.05	254.1	89.79	252.6	90.63	252.6	91.57	252.6	92.51	253.8	63.72
	3.0	2.2	266.4	90.74	266.4	91.48	264.9	92.32	264.9	93.26	264.9	94.20	266.1	60.54
	5.0	4.1	274.8	92.19	274.8	92.93	273.6	93.77	273.6	94.71	273.6	95.65	274.8	58.44
	7.0	6.0	278.8	93.49	278.8	94.23	277.6	95.07	277.6	96.01	277.6	96.95	278.8	56.34
	9.0	7.9	278.8	94.14	278.8	94.88	277.6	95.72	277.6	96.66	277.6	97.60	278.8	54.60
	11.0	9.8	278.8	94.79	278.8	95.53	277.6	96.47	277.6	97.41	277.6	98.35	278.8	53.34
	13.0	11.8	278.8	95.44	278.8	96.18	277.6	97.12	277.6	98.06	277.6	99.00	278.8	51.99
15.0	13.7	278.8	96.09	278.8	96.83	277.6	97.77	277.6	98.71	277.6	99.65	278.8	50.52	

# 7. Capacity Tables

Heating Capacity (72HP)

Combination (%)	Outdoor air temp.		Indoor air temp. °C DB											
			16		18		20		21		22		24	
	°C DB	°C WB	TC	PI	TC	PI	TC	PI	TC	PI	TC	PI	TC	PI
100	-24.8	-25	134.1	86.94	134.1	86.64	133.2	80.82	133.2	85.86	133.2	85.53	130.5	85.38
	-21.8	-22	165.0	86.46	165.0	86.16	164.1	83.37	164.1	85.38	164.1	86.25	160.8	84.90
	-19.8	-20	175.2	86.16	175.2	85.83	174.3	84.96	174.3	85.08	174.3	85.14	171.0	84.57
	-18.8	-19	179.1	86.01	178.2	85.68	178.2	85.38	178.2	84.90	178.2	84.57	174.6	83.28
	-16.7	-17	186.3	85.68	186.3	85.35	186.3	86.25	185.4	84.57	185.4	81.90	181.8	80.55
	-13.7	-15	199.2	85.20	199.2	84.87	198.0	84.57	198.0	80.70	198.0	78.06	194.4	76.62
	-11.8	-13	205.8	84.90	204.6	84.57	204.6	81.99	204.6	78.24	204.6	75.63	194.4	74.16
	-9.8	-11	212.4	84.57	212.4	81.69	211.5	79.26	211.5	75.66	208.5	73.08	194.4	71.55
	-9.5	-10	213.6	84.12	213.6	81.24	212.7	78.87	212.7	75.27	208.5	72.69	194.4	71.16
	-8.5	-9.1	217.8	82.62	217.8	79.80	216.9	77.49	215.7	73.98	208.5	71.43	194.4	69.84
	-7.0	-7.6	227.7	80.37	226.8	77.64	222.9	75.45	215.7	72.06	208.5	69.51	194.4	67.89
	-5.0	-5.6	237.6	77.34	235.2	74.76	222.9	72.75	215.7	69.45	208.5	66.96	194.4	65.28
	-3.0	-3.7	244.5	74.34	237.3	71.85	222.9	70.02	215.7	66.87	208.5	64.41	194.4	62.67
	0.0	-0.7	251.4	69.81	237.3	67.53	222.9	65.94	215.7	63.00	208.5	60.57	194.4	58.77
	3.0	2.2	251.4	65.28	237.3	63.18	222.9	61.86	215.7	59.13	208.5	56.73	194.4	54.87
	5.0	4.1	251.4	62.28	237.3	60.30	222.9	59.13	215.7	56.55	208.5	54.18	194.4	52.26
	7.0	6.0	251.4	59.25	237.3	57.39	222.9	56.40	215.7	53.97	208.5	51.63	194.4	49.65
	9.0	7.9	251.4	57.18	237.3	55.38	222.9	54.42	215.7	52.08	208.5	49.83	194.4	47.91
	11.0	9.8	251.4	55.59	237.3	53.85	222.9	52.92	215.7	50.61	208.5	48.42	194.4	46.59
	13.0	11.8	251.4	53.91	237.3	52.20	222.9	51.30	215.7	49.08	208.5	46.95	194.4	45.15
15.0	13.7	251.4	52.11	237.3	50.46	222.9	49.59	215.7	47.43	208.5	45.39	194.4	43.65	
90	-24.8	-25	133.5	77.16	133.5	78.39	132.6	79.29	132.6	79.68	132.6	80.52	130.2	81.78
	-21.8	-22	164.4	78.39	164.4	79.65	163.5	80.52	163.5	80.94	163.5	81.78	160.2	78.33
	-19.8	-20	174.6	79.23	174.6	80.49	173.4	81.36	173.4	81.78	173.4	79.41	170.1	76.02
	-18.8	-19	179.1	79.65	178.2	80.91	177.3	81.78	177.3	80.58	177.3	78.24	174.0	74.88
	-16.7	-17	186.3	80.52	186.3	81.78	185.7	79.29	185.7	78.03	185.7	75.78	177.6	72.45
	-13.7	-15	199.2	81.78	199.2	78.06	197.4	75.72	197.4	74.40	191.4	72.24	177.6	69.00
	-11.8	-13	205.8	79.23	204.6	75.72	203.7	73.44	197.7	72.09	191.4	70.02	177.6	66.81
	-9.8	-11	212.4	76.59	212.4	73.26	204.0	71.07	197.7	69.66	191.4	67.65	177.6	64.50
	-9.5	-10	213.6	76.17	213.6	72.87	204.0	70.71	197.7	69.30	191.4	67.29	177.6	64.14
	-8.5	-9.1	217.8	74.85	216.3	71.64	204.0	69.51	197.7	68.10	191.4	66.12	177.6	63.00
	-7.0	-7.6	227.7	72.84	216.6	69.78	204.0	67.74	197.7	66.27	191.4	64.35	177.6	61.26
	-5.0	-5.6	230.1	70.17	216.6	67.32	204.0	65.37	197.7	63.87	191.4	62.01	177.6	58.98
	-3.0	-3.7	230.1	67.50	216.6	64.86	204.0	62.97	197.7	61.44	191.4	59.64	177.6	56.67
	0.0	-0.7	230.1	63.51	216.6	61.14	204.0	59.40	197.7	57.81	191.4	56.10	177.6	53.22
	3.0	2.2	230.1	59.49	216.6	57.42	204.0	55.83	197.7	54.18	191.4	52.59	177.6	49.74
	5.0	4.1	230.1	56.82	216.6	54.96	204.0	53.46	197.7	51.75	191.4	50.22	177.6	47.43
	7.0	6.0	230.1	54.15	216.6	52.50	204.0	51.09	197.7	49.35	191.4	47.88	177.6	45.15
	9.0	7.9	230.1	51.63	216.6	50.04	204.0	48.69	197.7	47.04	191.4	45.63	177.6	43.05
	11.0	9.8	230.1	49.11	216.6	47.61	204.0	46.32	197.7	44.73	191.4	43.41	177.6	40.92
	13.0	11.8	230.1	46.59	216.6	45.15	204.0	43.95	197.7	42.45	191.4	41.19	177.6	38.82
15.0	13.7	230.1	44.07	216.6	42.72	204.0	41.55	197.7	40.14	191.4	38.94	177.6	36.72	
80	-24.8	-25	132.9	67.89	132.9	69.15	132.0	70.02	132.0	70.44	132.0	72.51	129.6	69.48
	-21.8	-22	162.6	69.15	162.6	70.38	162.6	71.25	162.6	72.51	162.6	69.48	158.7	66.54
	-19.8	-20	172.8	69.96	172.8	71.22	172.8	72.51	172.8	70.38	170.7	67.44	158.7	64.59
	-18.8	-19	176.7	70.38	176.7	72.51	176.7	71.43	176.7	69.30	170.7	66.42	158.7	63.63
	-16.7	-17	182.4	72.51	182.4	70.26	182.4	69.15	177.0	67.05	170.7	64.32	158.7	61.59
	-13.7	-15	190.8	69.18	186.9	67.02	182.4	65.91	177.0	63.84	170.7	61.26	158.7	58.65
	-11.8	-13	195.3	67.05	189.6	64.98	182.4	63.84	177.0	61.80	170.7	59.34	158.7	56.79
	-9.8	-11	200.4	64.83	192.3	62.85	182.4	61.68	177.0	59.67	170.7	57.30	158.7	54.84
	-9.5	-10	201.9	64.50	193.5	62.52	182.4	61.35	177.0	59.34	170.7	57.00	158.7	54.57
	-8.5	-9.1	204.0	63.39	194.4	61.44	182.4	60.27	177.0	58.26	170.7	56.01	158.7	53.58
	-7.0	-7.6	206.1	61.71	194.4	59.82	182.4	58.65	177.0	56.67	170.7	54.48	158.7	52.11
	-5.0	-5.6	206.1	59.49	194.4	57.69	182.4	56.46	177.0	54.51	170.7	52.44	158.7	50.16
	-3.0	-3.7	206.1	57.27	194.4	55.53	182.4	54.30	177.0	52.38	170.7	50.43	158.7	48.21
	0.0	-0.7	206.1	53.91	194.4	52.32	182.4	51.06	177.0	49.17	170.7	47.37	158.7	45.30
	3.0	2.2	206.1	50.58	194.4	49.08	182.4	47.79	177.0	45.93	170.7	44.34	158.7	42.36
	5.0	4.1	206.1	48.36	194.4	46.95	182.4	45.63	177.0	43.80	170.7	42.30	158.7	40.41
	7.0	6.0	206.1	46.14	194.4	44.79	182.4	43.47	177.0	41.67	170.7	40.29	158.7	38.46
	9.0	7.9	206.1	43.32	194.4	42.06	182.4	40.80	177.0	39.12	170.7	37.83	158.7	36.12
	11.0	9.8	206.1	40.20	194.4	39.03	182.4	37.89	177.0	36.30	170.7	35.10	158.7	33.51
	13.0	11.8	206.1	37.53	194.4	36.42	182.4	35.37	177.0	33.90	170.7	32.76	158.7	31.29
15.0	13.7	206.1	35.31	194.4	34.29	182.4	33.27	177.0	31.89	170.7	30.84	158.7	29.46	

# 7. Capacity Tables

Heating Capacity (72HP)

Combination (%)	Outdoor air temp.		Indoor air temp. °C DB											
			16		18		20		21		22		24	
	°C DB	°C WB	TC	PI	TC	PI	TC	PI	TC	PI	TC	PI	TC	PI
70	-24.8	-25	132.9	68.31	132.9	68.73	132.0	69.57	132.0	70.83	132.0	67.50	129.6	64.38
	-21.8	-22	156.3	69.57	156.3	69.99	155.4	70.83	150.0	67.50	145.5	64.38	135.9	61.38
	-19.8	-20	171.9	70.41	165.0	70.83	155.4	68.49	150.0	65.28	145.5	62.31	135.9	59.37
	-18.8	-19	174.9	70.83	165.0	69.63	155.4	67.32	150.0	64.17	145.5	61.26	135.9	58.35
	-16.7	-17	174.9	68.31	165.0	67.08	155.4	64.89	150.0	61.83	145.5	59.10	135.9	56.25
	-13.7	-15	174.9	64.77	165.0	63.48	155.4	61.38	150.0	58.53	145.5	55.98	135.9	53.22
	-11.8	-13	174.9	62.49	165.0	61.20	155.4	59.16	150.0	56.40	145.5	54.00	135.9	51.33
	-9.8	-11	174.9	60.12	165.0	58.77	155.4	56.85	150.0	54.18	145.5	51.93	135.9	49.32
	-9.5	-10	174.9	59.76	165.0	58.41	155.4	56.49	150.0	53.85	145.5	51.63	135.9	49.02
	-8.5	-9.1	174.9	58.59	165.0	57.21	155.4	55.32	150.0	52.74	145.5	50.58	135.9	48.00
	-7.0	-7.6	174.9	56.79	165.0	55.41	155.4	53.58	150.0	51.09	145.5	49.02	135.9	46.50
	-5.0	-5.6	174.9	54.42	165.0	53.01	155.4	51.24	150.0	48.87	145.5	46.95	135.9	44.49
	-3.0	-3.7	174.9	52.05	165.0	50.58	155.4	48.90	150.0	46.65	145.5	44.88	135.9	42.48
	0.0	-0.7	174.9	48.48	165.0	46.98	155.4	45.42	150.0	43.32	145.5	41.76	135.9	39.48
	3.0	2.2	174.9	44.91	165.0	43.38	155.4	41.91	150.0	40.02	145.5	38.64	135.9	36.45
	5.0	4.1	174.9	42.54	165.0	40.95	155.4	39.60	150.0	37.80	145.5	36.57	135.9	34.44
	7.0	6.0	174.9	40.17	165.0	38.55	155.4	37.26	150.0	35.58	145.5	34.50	135.9	32.43
	9.0	7.9	174.9	36.27	165.0	34.80	155.4	33.66	150.0	32.13	145.5	31.17	135.9	29.28
	11.0	9.8	174.9	33.78	165.0	32.40	155.4	31.32	150.0	29.91	145.5	29.01	135.9	27.27
	13.0	11.8	174.9	31.59	165.0	30.33	155.4	29.31	150.0	27.99	145.5	27.15	135.9	25.53
15.0	13.7	174.9	29.79	165.0	28.59	155.4	27.63	150.0	26.37	145.5	25.59	135.9	24.06	
60	-24.8	-25	132.9	67.47	132.9	68.31	132.0	69.57	128.7	66.00	124.2	62.67	116.4	59.52
	-21.8	-22	143.1	68.73	141.9	69.57	133.2	66.00	128.7	62.67	124.2	59.52	116.4	56.49
	-19.8	-20	150.0	69.57	141.9	67.05	133.2	63.63	128.7	60.45	124.2	57.42	116.4	54.45
	-18.8	-19	150.0	68.31	141.9	65.79	133.2	62.43	128.7	59.31	124.2	56.37	116.4	53.43
	-16.7	-17	150.0	65.64	141.9	63.15	133.2	59.94	128.7	56.97	124.2	54.18	116.4	51.30
	-13.7	-15	150.0	61.83	141.9	59.40	133.2	56.40	128.7	53.64	124.2	51.03	116.4	48.27
	-11.8	-13	150.0	59.43	141.9	57.00	133.2	54.12	128.7	51.51	124.2	49.05	116.4	46.35
	-9.8	-11	150.0	56.91	141.9	54.48	133.2	51.75	128.7	49.29	124.2	46.95	116.4	44.31
	-9.5	-10	150.0	56.52	141.9	54.12	133.2	51.39	128.7	48.96	124.2	46.62	116.4	44.01
	-8.5	-9.1	150.0	55.26	141.9	52.86	133.2	50.22	128.7	47.85	124.2	45.57	116.4	42.99
	-7.0	-7.6	150.0	53.37	141.9	50.97	133.2	48.45	128.7	46.17	124.2	44.01	116.4	41.46
	-5.0	-5.6	150.0	50.82	141.9	48.45	133.2	46.05	128.7	43.95	124.2	41.91	116.4	39.45
	-3.0	-3.7	150.0	48.30	141.9	45.93	133.2	43.68	128.7	41.73	124.2	39.81	116.4	37.41
	0.0	-0.7	150.0	44.49	141.9	42.18	133.2	40.14	128.7	38.37	124.2	36.66	116.4	34.38
	3.0	2.2	150.0	40.68	141.9	38.40	133.2	36.57	128.7	35.04	124.2	33.54	116.4	31.32
	5.0	4.1	150.0	38.16	141.9	35.88	133.2	34.20	128.7	32.82	124.2	31.44	116.4	29.31
	7.0	6.0	150.0	35.64	141.9	33.36	133.2	31.83	128.7	30.57	124.2	29.34	116.4	27.27
	9.0	7.9	150.0	31.80	141.9	29.79	133.2	28.38	128.7	27.27	124.2	26.16	116.4	24.33
	11.0	9.8	150.0	29.67	141.9	27.81	133.2	26.52	128.7	25.47	124.2	24.45	116.4	22.71
	13.0	11.8	150.0	27.81	141.9	26.04	133.2	24.84	128.7	23.85	124.2	22.89	116.4	21.30
15.0	13.7	150.0	26.28	141.9	24.63	133.2	23.46	128.7	22.56	124.2	21.63	116.4	20.13	
50	-24.8	-25	125.1	58.95	117.9	60.21	111.0	57.06	107.4	54.12	103.8	51.33	96.6	48.75
	-21.8	-22	125.1	60.21	117.9	57.06	111.0	54.12	107.4	51.33	103.8	48.75	96.6	46.26
	-19.8	-20	125.1	58.02	117.9	54.96	111.0	52.17	107.4	49.47	103.8	47.01	96.6	44.58
	-18.8	-19	125.1	56.91	117.9	53.91	111.0	51.18	107.4	48.57	103.8	46.14	96.6	43.74
	-16.7	-17	125.1	54.63	117.9	51.72	111.0	49.14	107.4	46.62	103.8	44.34	96.6	42.00
	-13.7	-15	125.1	51.36	117.9	48.57	111.0	46.20	107.4	43.83	103.8	41.76	96.6	39.51
	-11.8	-13	125.1	49.29	117.9	46.59	111.0	44.34	107.4	42.06	103.8	40.11	96.6	37.92
	-9.8	-11	125.1	47.10	117.9	44.49	111.0	42.36	107.4	40.20	103.8	38.37	96.6	36.24
	-9.5	-10	125.1	46.77	117.9	44.19	111.0	42.09	107.4	39.93	103.8	38.13	96.6	36.00
	-8.5	-9.1	125.1	45.66	117.9	43.14	111.0	41.10	107.4	39.00	103.8	37.26	96.6	35.16
	-7.0	-7.6	125.1	44.04	117.9	41.58	111.0	39.63	107.4	37.62	103.8	35.97	96.6	33.93
	-5.0	-5.6	125.1	41.85	117.9	39.48	111.0	37.68	107.4	35.76	103.8	34.23	96.6	32.25
	-3.0	-3.7	125.1	39.66	117.9	37.38	111.0	35.70	107.4	33.90	103.8	32.49	96.6	30.60
	0.0	-0.7	125.1	36.39	117.9	34.23	111.0	32.76	107.4	31.11	103.8	29.91	96.6	28.08
	3.0	2.2	125.1	33.12	117.9	31.11	111.0	29.85	107.4	28.32	103.8	27.33	96.6	25.59
	5.0	4.1	125.1	30.93	117.9	29.01	111.0	27.87	107.4	26.49	103.8	25.59	96.6	23.94
	7.0	6.0	125.1	28.74	117.9	26.91	111.0	25.92	107.4	24.63	103.8	23.85	96.6	22.26
	9.0	7.9	125.1	25.95	117.9	24.30	111.0	23.40	107.4	22.23	103.8	21.54	96.6	20.10
	11.0	9.8	125.1	24.27	117.9	22.74	111.0	21.90	107.4	20.82	103.8	20.16	96.6	18.81
	13.0	11.8	125.1	22.80	117.9	21.36	111.0	20.55	107.4	19.53	103.8	18.93	96.6	17.67
15.0	13.7	125.1	21.57	117.9	20.19	111.0	19.47	107.4	18.48	103.8	17.91	96.6	16.71	

**Note**

1. TC: Total Capacity(kW), PI : Power Input(kW, Comp. + Outdoor fan motor)
2. Capacity tables show the average value of conditions which may occur.
3. The heating capacity table is based on the values expressed as Max. in the specification of the outdoor unit. (When measuring the Max. heating capacity, the setting status of the indoor unit is the same as that for measuring the heating capacity of the indoor unit.)

# 7. Capacity Tables

## ◆ ARUM740LTE5

Heating Capacity (74HP)

Combination (%)	Outdoor air temp.		Indoor air temp. °C DB											
			16		18		20		21		22		24	
	°C DB	°C WB	TC	PI	TC	PI	TC	PI	TC	PI	TC	PI	TC	PI
130	-24.8	-25	142.0	75.9	142.0	76.70	141.2	77.37	141.2	78.37	141.2	79.36	138.9	80.90
	-21.8	-22	173.7	77.46	173.7	78.22	172.4	78.89	172.4	79.91	172.4	80.90	169.5	82.41
	-19.8	-20	183.5	78.48	183.5	79.25	182.3	79.91	182.3	80.94	182.3	81.90	179.3	83.44
	-18.8	-19	187.8	79.00	187.8	79.76	186.6	80.43	186.6	81.45	186.6	82.41	183.4	83.95
	-16.7	-17	196.7	80.07	196.7	80.83	195.4	81.50	195.4	82.52	195.4	83.50	192.1	85.02
	-13.7	-15	209.2	81.61	209.2	82.37	208.0	83.04	208.0	84.06	208.0	85.02	204.4	81.79
	-11.8	-13	216.0	82.59	216.0	83.33	214.8	84.00	214.8	85.02	214.8	82.86	212.2	79.74
	-9.8	-11	223.2	83.59	223.2	84.36	221.8	85.02	221.8	82.72	221.8	80.57	220.1	77.59
	-9.5	-10	224.5	83.77	224.5	84.51	223.2	84.67	223.2	82.36	222.9	80.22	221.4	77.24
	-8.5	-9.1	229.0	84.26	229.0	85.02	227.7	83.48	227.7	81.18	226.5	79.07	225.4	76.16
	-7.0	-7.6	235.8	85.02	235.8	83.29	234.2	81.70	234.2	79.44	234.2	77.33	231.9	74.55
	-5.0	-5.6	244.9	82.77	244.9	80.95	243.3	79.31	243.3	77.11	243.3	75.04	240.0	72.39
	-3.0	-3.7	253.9	80.52	253.9	78.63	252.3	76.93	252.3	74.77	252.3	72.75	248.2	70.22
	0.0	-0.7	267.4	77.12	267.4	75.14	265.7	73.37	265.7	71.28	265.7	69.30	260.1	66.99
	3.0	2.2	281.0	73.74	281.0	71.63	279.1	69.79	279.1	67.79	277.6	65.84	260.3	63.75
	5.0	4.1	289.3	71.46	289.3	69.30	287.8	67.41	286.6	65.46	279.5	63.55	260.3	61.57
	7.0	6.0	296.6	69.20	296.6	66.96	294.8	65.03	289.7	63.14	279.5	61.25	260.3	59.42
	9.0	7.9	297.9	67.34	297.9	65.16	296.9	63.27	289.7	61.44	279.5	59.62	260.3	57.82
	11.0	9.8	297.9	66.05	297.9	63.93	296.9	62.08	289.7	60.27	279.5	58.47	260.3	56.71
	13.0	11.8	297.9	64.69	297.9	62.59	296.9	60.77	289.7	59.01	279.5	57.26	260.3	55.54
15.0	13.7	297.9	63.21	297.9	61.17	296.9	59.39	289.7	57.65	279.5	55.95	260.3	54.26	
120	-24.8	-25	141.1	76.70	141.1	77.37	140.2	78.37	140.2	79.36	140.2	80.90	137.9	81.97
	-21.8	-22	172.4	78.22	172.4	78.89	171.2	79.91	171.2	80.90	171.2	82.41	168.5	83.50
	-19.8	-20	182.2	79.25	182.2	79.91	181.0	80.94	181.0	81.90	181.0	83.44	178.0	84.51
	-18.8	-19	186.4	79.76	186.4	80.43	185.1	81.45	185.1	82.41	185.1	83.95	182.1	85.02
	-16.7	-17	195.2	80.83	195.2	81.50	194.0	82.52	194.0	83.50	194.0	85.02	190.6	82.94
	-13.7	-15	207.6	82.37	207.6	83.04	206.4	84.06	206.4	85.02	206.4	81.91	202.9	79.96
	-11.8	-13	214.4	83.33	214.4	84.00	213.2	85.02	213.2	82.82	213.2	79.94	210.6	78.09
	-9.8	-11	221.6	84.36	221.6	85.02	220.3	82.60	220.3	80.51	220.3	77.88	218.6	76.10
	-9.5	-10	223.0	84.51	223.0	84.64	221.7	82.25	221.7	80.16	221.7	77.57	220.0	75.79
	-8.5	-9.1	227.5	85.02	227.5	83.36	225.9	81.03	225.9	79.01	225.9	76.54	224.0	74.80
	-7.0	-7.6	234.2	83.12	234.2	81.44	232.7	79.22	232.7	77.27	232.5	74.99	230.3	73.81
	-5.0	-5.6	243.2	80.57	243.2	78.87	241.6	76.79	241.6	74.94	241.6	72.90	238.5	71.32
	-3.0	-3.7	252.1	78.02	252.1	76.33	250.5	74.36	250.5	72.65	250.5	70.83	244.5	69.33
	0.0	-0.7	265.5	74.20	265.5	72.48	263.7	70.73	263.7	69.16	262.5	67.73	244.5	66.35
	3.0	2.2	278.9	70.37	278.9	68.63	276.3	67.09	271.5	65.69	263.0	64.62	244.5	63.38
	5.0	4.1	287.3	67.82	286.8	66.07	280.8	64.68	271.5	63.37	263.0	62.55	244.5	61.39
	7.0	6.0	294.6	65.27	292.5	63.51	280.8	62.26	271.5	61.05	263.0	60.49	244.5	59.40
	9.0	7.9	295.6	63.34	292.5	61.63	280.8	60.43	271.5	59.28	263.0	58.72	244.5	57.65
	11.0	9.8	295.6	62.00	292.5	60.31	280.8	59.11	271.5	57.99	263.0	57.44	244.5	56.42
	13.0	11.8	295.6	60.53	292.5	58.88	280.8	57.73	271.5	56.63	263.0	56.09	244.5	55.10
15.0	13.7	295.6	58.97	292.5	57.36	280.8	56.24	271.5	55.16	263.0	54.63	244.5	53.66	
110	-24.8	-25	140.4	77.37	140.4	78.37	139.5	79.36	139.5	80.90	139.5	81.97	137.1	82.48
	-21.8	-22	171.5	78.89	171.5	79.91	170.3	80.90	170.3	82.41	170.3	83.50	167.6	84.00
	-19.8	-20	181.3	79.91	181.3	80.94	180.1	81.90	180.1	83.44	180.1	84.51	177.1	85.02
	-18.8	-19	185.4	80.43	185.4	81.45	184.1	82.41	184.1	83.95	184.1	85.02	181.2	83.93
	-16.7	-17	194.2	81.50	194.2	82.52	193.0	83.50	193.0	85.02	193.0	82.78	189.6	81.61
	-13.7	-15	206.5	83.04	206.5	84.06	205.2	85.02	205.2	81.62	205.2	79.54	205.2	78.31
	-11.8	-13	213.3	84.00	213.3	85.02	212.0	82.62	212.0	79.45	212.0	77.50	212.0	76.22
	-9.8	-11	220.4	85.02	220.4	82.31	219.1	80.09	219.1	77.17	219.1	75.36	218.5	74.02
	-9.5	-10	221.7	84.58	221.7	81.89	220.5	79.69	220.5	76.83	220.5	75.04	219.7	73.69
	-8.5	-9.1	226.2	83.12	226.2	80.53	224.9	78.43	224.9	75.69	224.9	73.94	220.0	72.58
	-7.0	-7.6	233.0	80.90	233.0	78.50	231.5	76.53	231.5	73.98	231.5	72.34	220.0	70.94
	-5.0	-5.6	241.8	77.97	241.8	75.75	240.2	73.99	240.2	71.71	235.5	70.19	220.0	68.72
	-3.0	-3.7	250.7	75.03	250.7	73.04	249.0	71.44	243.8	69.42	235.5	68.03	220.0	66.53
	0.0	-0.7	264.1	70.62	263.7	68.95	251.9	67.64	243.8	66.00	235.5	64.82	220.0	63.24
	3.0	2.2	276.9	66.21	268.6	64.86	251.9	63.82	243.8	62.60	235.5	61.58	220.0	59.92
	5.0	4.1	284.1	63.26	268.6	62.15	251.9	61.30	243.8	60.31	235.5	59.44	220.0	57.72
	7.0	6.0	284.2	60.31	268.6	59.42	251.9	58.74	243.8	58.03	235.5	57.29	220.0	55.52
	9.0	7.9	284.2	58.28	268.6	57.42	251.9	56.78	243.8	56.08	235.5	55.36	220.0	53.65
	11.0	9.8	284.2	56.77	268.6	55.92	251.9	55.28	243.8	54.60	235.5	53.90	220.0	52.24
	13.0	11.8	284.2	55.11	268.6	54.30	251.9	53.68	243.8	53.03	235.5	52.35	220.0	50.75
15.0	13.7	284.2	53.39	268.6	52.58	251.9	51.98	243.8	51.35	235.5	50.71	220.0	49.13	



# 7. Capacity Tables

Heating Capacity (74HP)

Combination (%)	Outdoor air temp.		Indoor air temp. °C DB											
			16		18		20		21		22		24	
	°C DB	°C WB	TC	PI	TC	PI	TC	PI	TC	PI	TC	PI	TC	PI
100	-24.8	-25	139.8	85.97	139.8	85.85	138.9	80.68	138.9	85.54	138.9	85.41	136.5	85.35
	-21.8	-22	170.6	85.78	170.6	85.66	169.7	83.22	169.7	85.35	169.7	86.42	166.7	85.16
	-19.8	-20	180.4	85.66	180.4	85.52	179.4	84.83	179.4	85.23	179.4	85.49	176.4	85.02
	-18.8	-19	184.5	85.60	183.5	85.47	183.5	85.35	183.5	85.15	183.5	85.02	180.3	83.68
	-16.7	-17	192.1	85.47	192.1	85.34	192.1	86.42	191.1	85.02	191.1	82.25	187.8	80.86
	-13.7	-15	205.5	85.28	205.5	85.14	204.3	85.02	204.3	81.00	204.3	78.28	201.1	76.81
	-11.8	-13	212.3	85.16	211.1	85.02	211.1	82.33	211.1	78.44	211.1	75.75	201.1	74.26
	-9.8	-11	219.2	85.02	219.2	82.00	218.2	79.48	218.2	75.76	215.7	73.12	201.1	71.56
	-9.5	-10	220.5	84.55	220.5	81.54	219.5	79.06	219.5	75.35	215.7	72.71	201.1	71.16
	-8.5	-9.1	225.0	82.97	225.0	80.03	224.0	77.63	223.1	74.00	215.7	71.40	201.1	69.80
	-7.0	-7.6	235.5	80.60	234.6	77.76	230.5	75.49	223.1	72.00	215.7	69.41	201.1	67.78
	-5.0	-5.6	245.7	77.42	243.3	74.74	230.5	72.66	223.1	69.30	215.7	66.76	201.1	65.08
	-3.0	-3.7	252.9	74.26	245.3	71.70	230.5	69.81	223.1	66.61	215.7	64.13	201.1	62.39
	0.0	-0.7	259.9	69.50	245.3	67.17	230.5	65.54	223.1	62.59	215.7	60.14	201.1	58.35
	3.0	2.2	259.9	64.73	245.3	62.62	230.5	61.28	223.1	58.56	215.7	56.17	201.1	54.32
	5.0	4.1	259.9	61.57	245.3	59.60	230.5	58.43	223.1	55.86	215.7	53.52	201.1	51.62
	7.0	6.0	259.9	58.39	245.3	56.56	230.5	55.58	223.1	53.18	215.7	50.88	201.1	48.93
	9.0	7.9	259.9	56.11	245.3	54.34	230.5	53.40	223.1	51.10	215.7	48.89	201.1	47.01
	11.0	9.8	259.9	54.29	245.3	52.59	230.5	51.68	223.1	49.43	215.7	47.29	201.1	45.50
	13.0	11.8	259.9	52.37	245.3	50.71	230.5	49.83	223.1	47.68	215.7	45.61	201.1	43.86
15.0	13.7	259.9	50.33	245.3	48.73	230.5	47.89	223.1	45.81	215.7	43.84	201.1	42.15	
90	-24.8	-25	139.2	76.27	139.2	77.79	138.3	78.88	138.3	79.37	138.3	80.40	136.1	81.94
	-21.8	-22	170.0	77.79	170.0	79.33	169.1	80.40	169.1	80.91	169.1	81.94	166.0	78.40
	-19.8	-20	179.8	78.82	179.8	80.35	178.6	81.42	178.6	81.94	178.6	79.51	175.6	76.05
	-18.8	-19	184.5	79.33	183.5	80.87	182.7	81.94	182.7	80.70	182.7	78.31	179.7	74.88
	-16.7	-17	192.1	80.40	192.1	81.94	191.3	79.37	191.3	78.08	191.3	75.79	183.6	72.40
	-13.7	-15	205.5	81.94	205.5	78.10	203.7	75.69	203.7	74.36	197.8	72.16	183.6	68.87
	-11.8	-13	212.3	79.30	211.1	75.69	210.2	73.36	204.4	71.99	197.8	69.87	183.6	66.63
	-9.8	-11	219.2	76.56	219.2	73.15	211.0	70.92	204.4	69.50	197.8	67.46	183.6	64.27
	-9.5	-10	220.5	76.13	220.5	72.75	211.0	70.54	204.4	69.12	197.8	67.09	183.6	63.91
	-8.5	-9.1	225.0	74.77	223.4	71.48	211.0	69.31	204.4	67.88	197.8	65.88	183.6	62.74
	-7.0	-7.6	235.5	72.69	224.0	69.57	211.0	67.48	204.4	66.01	197.8	64.07	183.6	60.97
	-5.0	-5.6	238.0	69.93	224.0	67.02	211.0	65.04	204.4	63.54	197.8	61.66	183.6	58.63
	-3.0	-3.7	238.0	67.17	224.0	64.48	211.0	62.58	204.4	61.05	197.8	59.24	183.6	56.26
	0.0	-0.7	238.0	63.04	224.0	60.65	211.0	58.91	204.4	57.32	197.8	55.62	183.6	52.74
	3.0	2.2	238.0	58.88	224.0	56.82	211.0	55.23	204.4	53.60	197.8	52.01	183.6	49.19
	5.0	4.1	238.0	56.12	224.0	54.27	211.0	52.78	204.4	51.10	197.8	49.59	183.6	46.83
	7.0	6.0	238.0	53.36	224.0	51.74	211.0	50.34	204.4	48.63	197.8	47.18	183.6	44.49
	9.0	7.9	238.0	50.77	224.0	49.20	211.0	47.88	204.4	46.26	197.8	44.88	183.6	42.33
	11.0	9.8	238.0	48.17	224.0	46.70	211.0	45.43	204.4	43.88	197.8	42.58	183.6	40.14
	13.0	11.8	238.0	45.58	224.0	44.17	211.0	42.99	204.4	41.52	197.8	40.30	183.6	37.98
15.0	13.7	238.0	42.98	224.0	41.66	211.0	40.53	204.4	39.15	197.8	37.98	183.6	35.82	
80	-24.8	-25	138.6	66.98	138.6	68.52	137.7	69.59	137.7	70.10	137.7	72.65	135.5	69.55
	-21.8	-22	168.1	68.52	168.1	70.04	168.1	71.11	168.1	72.65	168.1	69.55	164.1	66.56
	-19.8	-20	177.9	69.53	177.9	71.06	177.9	72.65	177.9	70.46	176.2	67.47	164.1	64.57
	-18.8	-19	182.0	70.04	182.0	72.65	182.0	71.54	182.0	69.36	176.4	66.43	164.1	63.58
	-16.7	-17	188.6	72.65	188.6	70.34	188.6	69.21	183.0	67.06	176.4	64.27	164.1	61.50
	-13.7	-15	197.2	69.22	193.3	67.01	188.6	65.88	183.0	63.77	176.4	61.15	164.1	58.51
	-11.8	-13	202.1	67.02	196.1	64.91	188.6	63.75	183.0	61.68	176.4	59.18	164.1	56.61
	-9.8	-11	207.4	64.73	199.0	62.71	188.6	61.53	183.0	59.50	176.4	57.11	164.1	54.62
	-9.5	-10	208.9	64.39	200.1	62.37	188.6	61.19	183.0	59.16	176.4	56.79	164.1	54.33
	-8.5	-9.1	211.1	63.25	201.0	61.27	188.6	60.08	183.0	58.06	176.4	55.77	164.1	53.33
	-7.0	-7.6	213.2	61.52	201.0	59.60	188.6	58.41	183.0	56.42	176.4	54.22	164.1	51.83
	-5.0	-5.6	213.2	59.23	201.0	57.41	188.6	56.18	183.0	54.21	176.4	52.13	164.1	49.84
	-3.0	-3.7	213.2	56.94	201.0	55.19	188.6	53.96	183.0	52.03	176.4	50.07	164.1	47.85
	0.0	-0.7	213.2	53.48	201.0	51.88	188.6	50.63	183.0	48.74	176.4	46.94	164.1	44.88
	3.0	2.2	213.2	50.05	201.0	48.55	188.6	47.28	183.0	45.43	176.4	43.84	164.1	41.88
	5.0	4.1	213.2	47.75	201.0	46.36	188.6	45.05	183.0	43.25	176.4	41.76	164.1	39.90
	7.0	6.0	213.2	45.47	201.0	44.14	188.6	42.84	183.0	41.06	176.4	39.70	164.1	37.90
	9.0	7.9	213.2	42.68	201.0	41.45	188.6	40.21	183.0	38.55	176.4	37.28	164.1	35.59
	11.0	9.8	213.2	39.62	201.0	38.47	188.6	37.34	183.0	35.78	176.4	34.59	164.1	33.03
	13.0	11.8	213.2	36.99	201.0	35.90	188.6	34.85	183.0	33.40	176.4	32.29	164.1	30.83
15.0	13.7	213.2	34.80	201.0	33.79	188.6	32.79	183.0	31.43	176.4	30.40	164.1	29.03	

# 7. Capacity Tables

Heating Capacity (74HP)

Combination (%)	Outdoor air temp.		Indoor air temp. °C DB											
			16		18		20		21		22		24	
	°C DB	°C WB	TC	PI	TC	PI	TC	PI	TC	PI	TC	PI	TC	PI
70	-24.8	-25	138.6	67.73	138.6	68.24	137.7	69.27	137.7	70.81	137.7	67.44	135.4	64.27
	-21.8	-22	161.6	69.27	161.6	69.78	160.6	70.81	155.1	67.44	150.5	62.18	140.5	61.23
	-19.8	-20	177.0	70.30	170.7	70.81	160.6	68.44	155.1	65.19	150.5	62.18	140.5	59.21
	-18.8	-19	180.6	70.81	170.7	69.58	160.6	67.25	155.1	64.06	150.5	61.12	140.5	58.17
	-16.7	-17	180.8	68.25	170.7	67.00	160.6	64.78	155.1	61.70	150.5	58.92	140.5	56.05
	-13.7	-15	180.8	64.64	170.7	63.34	160.6	61.22	155.1	58.33	150.5	55.77	140.5	52.99
	-11.8	-13	180.8	62.32	170.7	61.01	160.6	58.96	155.1	56.18	150.5	53.76	140.5	51.07
	-9.8	-11	180.8	59.91	170.7	58.56	160.6	56.61	155.1	53.93	150.5	51.66	140.5	49.04
	-9.5	-10	180.8	59.54	170.7	58.19	160.6	56.25	155.1	53.60	150.5	51.35	140.5	48.74
	-8.5	-9.1	180.8	58.34	170.7	56.97	160.6	55.06	155.1	52.47	150.5	50.30	140.5	47.71
	-7.0	-7.6	180.8	56.52	170.7	55.14	160.6	53.29	155.1	50.79	150.5	48.72	140.5	46.19
	-5.0	-5.6	180.8	54.10	170.7	52.69	160.6	50.92	155.1	48.54	150.5	46.61	140.5	44.16
	-3.0	-3.7	180.8	51.69	170.7	50.23	160.6	48.55	155.1	46.29	150.5	44.51	140.5	42.12
	0.0	-0.7	180.8	48.05	170.7	46.57	160.6	45.01	155.1	42.92	150.5	41.36	140.5	39.08
	3.0	2.2	180.8	44.42	170.7	42.89	160.6	41.44	155.1	39.56	150.5	38.20	140.5	36.02
	5.0	4.1	180.8	42.00	170.7	40.43	160.6	39.09	155.1	37.31	150.5	36.09	140.5	34.00
	7.0	6.0	180.8	39.58	170.7	37.99	160.6	36.72	155.1	35.06	150.5	34.00	140.5	31.96
	9.0	7.9	180.8	35.74	170.7	34.30	160.6	33.17	155.1	31.66	150.5	30.71	140.5	28.86
	11.0	9.8	180.8	33.29	170.7	31.94	160.6	30.87	155.1	29.47	150.5	28.59	140.5	26.87
	13.0	11.8	180.8	31.14	170.7	29.89	160.6	28.88	155.1	27.58	150.5	26.75	140.5	25.16
15.0	13.7	180.8	29.35	170.7	28.18	160.6	27.23	155.1	25.99	150.5	25.22	140.5	23.71	
60	-24.8	-25	137.8	66.70	137.8	67.73	136.9	69.27	133.1	65.69	128.5	62.34	120.3	59.18
	-21.8	-22	148.1	68.24	146.8	69.27	137.7	65.69	133.1	62.34	128.5	59.18	120.3	56.14
	-19.8	-20	155.1	69.27	146.8	66.74	137.7	63.31	133.1	60.11	128.5	57.08	120.3	54.11
	-18.8	-19	155.1	68.01	146.8	65.48	137.7	62.10	133.1	58.97	128.5	56.03	120.3	53.08
	-16.7	-17	155.1	65.32	146.8	62.82	137.7	59.61	133.1	56.63	128.5	53.83	120.3	50.95
	-13.7	-15	155.1	61.48	146.8	59.04	137.7	56.04	133.1	53.28	128.5	50.67	120.3	47.91
	-11.8	-13	155.1	59.07	146.8	56.64	137.7	53.76	133.1	51.15	128.5	48.68	120.3	45.99
	-9.8	-11	155.1	56.53	146.8	54.11	137.7	51.38	133.1	48.92	128.5	46.57	120.3	43.94
	-9.5	-10	155.1	56.14	146.8	53.74	137.7	51.02	133.1	48.58	128.5	46.25	120.3	43.64
	-8.5	-9.1	155.1	54.87	146.8	52.48	137.7	49.84	133.1	47.47	128.5	45.19	120.3	42.63
	-7.0	-7.6	155.1	52.97	146.8	50.58	137.7	48.05	133.1	45.78	128.5	43.62	120.3	41.10
	-5.0	-5.6	155.1	50.40	146.8	48.05	137.7	45.66	133.1	43.55	128.5	41.53	120.3	39.07
	-3.0	-3.7	155.1	47.86	146.8	45.52	137.7	43.27	133.1	41.32	128.5	39.42	120.3	37.03
	0.0	-0.7	155.1	44.03	146.8	41.73	137.7	39.71	133.1	37.95	128.5	36.26	120.3	33.99
	3.0	2.2	155.1	40.20	146.8	37.94	137.7	36.12	133.1	34.61	128.5	33.12	120.3	30.93
	5.0	4.1	155.1	37.66	146.8	35.41	137.7	33.75	133.1	32.38	128.5	31.01	120.3	28.92
	7.0	6.0	155.1	35.12	146.8	32.88	137.7	31.36	133.1	30.13	128.5	28.92	120.3	26.87
	9.0	7.9	155.1	31.34	146.8	29.35	137.7	27.97	133.1	26.88	128.5	25.78	120.3	23.97
	11.0	9.8	155.1	29.25	146.8	27.40	137.7	26.13	133.1	25.10	128.5	24.09	120.3	22.39
	13.0	11.8	155.1	27.40	146.8	25.66	137.7	24.48	133.1	23.51	128.5	22.56	120.3	20.99
15.0	13.7	155.1	25.90	146.8	24.27	137.7	23.12	133.1	22.23	128.5	21.32	120.3	19.84	
50	-24.8	-25	129.4	58.78	122.0	60.32	114.7	57.13	111.0	54.14	107.3	51.33	99.9	48.71
	-21.8	-22	129.4	60.32	122.0	57.13	114.7	54.14	111.0	51.33	107.3	48.71	99.9	46.19
	-19.8	-20	129.4	58.10	122.0	55.00	114.7	52.17	111.0	49.44	107.3	46.95	99.9	44.49
	-18.8	-19	129.4	56.98	122.0	53.93	114.7	51.17	111.0	48.52	107.3	46.07	99.9	43.65
	-16.7	-17	129.4	54.65	122.0	51.71	114.7	49.09	111.0	46.54	107.3	44.24	99.9	41.89
	-13.7	-15	129.4	51.33	122.0	48.51	114.7	46.11	111.0	43.72	107.3	41.62	99.9	39.37
	-11.8	-13	129.4	49.22	122.0	46.50	114.7	44.22	111.0	41.93	107.3	39.96	99.9	37.76
	-9.8	-11	129.4	46.99	122.0	44.37	114.7	42.22	111.0	40.05	107.3	38.20	99.9	36.07
	-9.5	-10	129.4	46.66	122.0	44.06	114.7	41.94	111.0	39.77	107.3	37.96	99.9	35.82
	-8.5	-9.1	129.4	45.53	122.0	42.99	114.7	40.94	111.0	38.83	107.3	37.08	99.9	34.98
	-7.0	-7.6	129.4	43.88	122.0	41.41	114.7	39.45	111.0	37.43	107.3	35.77	99.9	33.73
	-5.0	-5.6	129.4	41.65	122.0	39.28	114.7	37.47	111.0	35.54	107.3	34.01	99.9	32.04
	-3.0	-3.7	129.4	39.42	122.0	37.15	114.7	35.46	111.0	33.66	107.3	32.25	99.9	30.36
	0.0	-0.7	129.4	36.10	122.0	33.95	114.7	32.49	111.0	30.84	107.3	29.63	99.9	27.82
	3.0	2.2	129.4	32.78	122.0	30.78	114.7	29.52	111.0	28.01	107.3	27.02	99.9	25.30
	5.0	4.1	129.4	30.55	122.0	28.65	114.7	27.52	111.0	26.15	107.3	25.26	99.9	23.63
	7.0	6.0	129.4	28.32	122.0	26.52	114.7	25.55	111.0	24.27	107.3	23.50	99.9	21.94
	9.0	7.9	129.4	25.57	122.0	23.95	114.7	23.06	111.0	21.91	107.3	21.23	99.9	19.80
	11.0	9.8	129.4	23.93	122.0	22.41	114.7	21.58	111.0	20.52	107.3	19.86	99.9	18.53
	13.0	11.8	129.4	22.47	122.0	21.05	114.7	20.25	111.0	19.25	107.3	18.65	99.9	17.41
15.0	13.7	129.4	21.26	122.0	19.90	114.7	19.18	111.0	18.22	107.3	17.65	99.9	16.47	

**Note**

1. TC: Total Capacity(kW), PI : Power Input(kW, Comp. + Outdoor fan motor)
2. Capacity tables show the average value of conditions which may occur.
3. The heating capacity table is based on the values expressed as Max. in the specification of the outdoor unit. (When measuring the Max. heating capacity, the setting status of the indoor unit is the same as that for measuring the heating capacity of the indoor unit.)

# 7. Capacity Tables

## ◆ ARUM760LTE5

Heating Capacity (76HP)

Combination (%)	Outdoor air temp.		Indoor air temp. °C DB											
			16		18		20		21		22		24	
	°C DB	°C WB	TC	PI	TC	PI	TC	PI	TC	PI	TC	PI	TC	PI
130	-24.8	-25	143.4	77.7	143.4	78.58	142.5	79.37	142.5	80.56	142.5	81.72	140.8	83.55
	-21.8	-22	175.6	79.48	175.6	80.38	174.4	81.17	174.4	82.38	174.4	83.55	172.1	85.34
	-19.8	-20	185.7	80.68	185.7	81.60	184.5	82.38	184.5	83.59	184.5	84.73	182.2	86.55
	-18.8	-19	190.2	81.30	190.2	82.20	189.0	82.99	189.0	84.20	189.0	85.34	186.5	87.16
	-16.7	-17	199.3	82.56	199.3	83.47	198.1	84.26	198.1	85.46	198.1	86.62	195.5	88.42
	-13.7	-15	212.3	84.38	212.3	85.29	211.0	86.08	211.0	87.28	211.0	88.42	208.2	85.12
	-11.8	-13	219.3	85.54	219.3	86.43	218.0	87.22	218.0	88.42	218.0	86.22	216.0	83.03
	-9.8	-11	226.7	86.73	226.7	87.64	225.3	88.42	225.3	86.08	225.3	83.88	223.9	80.83
	-9.5	-10	228.2	86.93	228.2	87.82	226.9	88.07	226.9	85.71	226.3	83.53	225.1	80.48
	-8.5	-9.1	233.8	87.52	233.8	88.42	232.5	86.86	232.5	84.52	230.1	82.35	229.1	79.37
	-7.0	-7.6	242.3	88.42	242.3	86.67	240.6	85.06	240.6	82.75	240.6	80.58	236.8	77.73
	-5.0	-5.6	253.5	86.17	253.5	84.31	251.8	82.63	251.8	80.38	251.8	78.25	245.2	75.52
	-3.0	-3.7	264.7	83.90	264.7	81.97	263.0	80.22	263.0	78.00	263.0	75.91	253.7	73.30
	0.0	-0.7	281.4	80.48	281.4	78.44	279.5	76.61	278.4	74.45	276.2	72.40	266.4	70.00
	3.0	2.2	292.7	77.08	292.7	74.89	291.0	72.98	289.4	70.91	285.7	68.87	267.4	66.70
	5.0	4.1	299.4	74.80	299.4	72.55	298.0	70.56	295.2	68.53	287.1	66.53	267.4	64.47
	7.0	6.0	305.0	72.53	305.0	70.18	303.4	68.16	297.6	66.17	287.1	64.20	267.4	62.28
	9.0	7.9	306.0	70.66	306.0	68.38	305.0	66.39	297.6	64.47	287.1	62.56	267.4	60.68
	11.0	9.8	306.0	69.41	306.0	67.17	305.0	65.23	297.6	63.32	287.1	61.44	267.4	59.59
	13.0	11.8	306.0	68.07	306.0	65.86	305.0	63.95	297.6	62.10	287.1	60.25	267.4	58.44
15.0	13.7	306.0	66.62	306.0	64.47	305.0	62.59	297.6	60.76	287.1	58.96	267.4	57.19	
120	-24.8	-25	142.5	78.58	142.5	79.37	141.5	80.56	141.5	81.72	141.5	83.55	139.8	84.81
	-21.8	-22	174.4	80.38	174.4	81.17	173.2	82.38	173.2	83.55	173.2	85.34	171.1	86.62
	-19.8	-20	184.5	81.60	184.5	82.38	183.2	83.59	183.2	84.73	183.2	86.55	180.9	87.82
	-18.8	-19	188.7	82.20	188.7	82.99	187.5	84.20	187.5	85.34	187.5	87.16	185.2	88.42
	-16.7	-17	197.8	83.47	197.8	84.26	196.6	85.46	196.6	86.62	196.6	88.42	194.0	86.30
	-13.7	-15	210.7	85.29	210.7	86.08	209.4	87.28	209.4	88.42	209.4	85.25	206.7	83.26
	-11.8	-13	217.7	86.43	217.7	87.22	216.4	88.42	216.4	86.18	216.4	83.24	214.4	81.34
	-9.8	-11	225.0	87.64	225.0	88.42	223.7	85.96	223.7	83.82	223.7	81.14	222.3	79.31
	-9.5	-10	226.7	87.82	226.7	88.03	225.4	85.60	225.4	83.47	225.4	80.82	224.0	78.99
	-8.5	-9.1	232.3	88.42	232.3	86.73	230.7	84.36	230.7	82.29	230.2	79.78	228.6	77.98
	-7.0	-7.6	240.6	86.49	240.6	84.78	239.1	82.51	239.1	80.52	237.0	78.18	235.1	76.46
	-5.0	-5.6	251.8	83.91	251.8	82.17	250.1	80.05	250.1	78.15	250.1	76.06	243.6	74.43
	-3.0	-3.7	262.7	81.32	262.7	79.59	261.1	77.57	261.1	75.81	260.2	73.95	250.5	72.39
	0.0	-0.7	279.4	77.45	278.9	75.68	274.9	73.87	272.9	72.25	269.8	70.78	251.1	69.35
	3.0	2.2	290.5	73.58	289.8	71.77	285.1	70.17	278.9	68.71	270.2	67.61	251.1	66.32
	5.0	4.1	297.3	70.99	296.1	69.16	288.5	67.71	278.9	66.35	270.2	65.50	251.1	64.29
	7.0	6.0	302.9	68.41	300.5	66.56	288.5	65.25	278.9	63.98	270.2	63.39	251.1	62.25
	9.0	7.9	303.7	66.46	300.5	64.67	288.5	63.40	278.9	62.20	270.2	61.61	251.1	60.49
	11.0	9.8	303.7	65.13	300.5	63.36	288.5	62.10	278.9	60.93	270.2	60.34	251.1	59.27
	13.0	11.8	303.7	63.67	300.5	61.94	288.5	60.73	278.9	59.57	270.2	59.01	251.1	57.96
15.0	13.7	303.7	62.12	300.5	60.44	288.5	59.25	278.9	58.11	270.2	57.56	251.1	56.54	
110	-24.8	-25	141.7	79.37	141.7	80.56	140.9	81.72	140.9	83.55	140.9	84.81	139.0	85.42
	-21.8	-22	173.5	81.17	173.5	82.38	172.3	83.55	172.3	85.34	172.3	86.62	170.2	87.22
	-19.8	-20	183.5	82.38	183.5	83.59	182.3	84.73	182.3	86.55	182.3	87.82	179.9	88.42
	-18.8	-19	187.7	82.99	187.7	84.20	186.5	85.34	186.5	87.16	186.5	88.42	184.2	87.30
	-16.7	-17	196.8	84.26	196.8	85.46	195.6	86.62	195.6	88.42	195.6	86.13	193.0	84.92
	-13.7	-15	209.6	86.08	209.6	87.28	208.2	88.42	208.2	84.94	208.2	82.82	208.2	81.55
	-11.8	-13	216.5	87.22	216.5	88.42	215.2	85.97	215.2	82.72	215.2	80.72	215.2	79.40
	-9.8	-11	223.8	88.42	223.8	85.65	222.5	83.39	222.5	80.40	222.5	78.53	221.9	77.15
	-9.5	-10	225.4	87.97	225.4	85.22	224.2	82.97	224.2	80.04	224.2	78.21	223.6	76.81
	-8.5	-9.1	231.0	86.49	231.0	83.84	229.6	81.68	229.6	78.88	229.3	77.09	225.4	75.67
	-7.0	-7.6	239.3	84.22	239.3	81.76	237.8	79.74	237.8	77.13	236.3	75.45	226.0	73.99
	-5.0	-5.6	250.3	81.23	250.3	78.96	248.6	77.15	247.6	74.81	241.0	73.25	226.0	71.72
	-3.0	-3.7	261.3	78.23	261.3	76.18	256.6	74.54	250.5	72.46	241.9	71.04	226.0	69.47
	0.0	-0.7	275.9	73.72	272.1	72.01	258.8	70.66	250.5	68.97	241.9	67.75	226.0	66.09
	3.0	2.2	286.3	69.23	275.9	67.83	258.8	66.76	250.5	65.49	241.9	64.43	226.0	62.70
	5.0	4.1	291.9	66.22	275.9	65.06	258.8	64.18	250.5	63.15	241.9	62.24	226.0	60.44
	7.0	6.0	291.9	63.21	275.9	62.27	258.8	61.57	250.5	60.82	241.9	60.04	226.0	58.19
	9.0	7.9	291.9	61.15	275.9	60.25	258.8	59.57	250.5	58.84	241.9	58.09	226.0	56.29
	11.0	9.8	291.9	59.63	275.9	58.74	258.8	58.07	250.5	57.36	241.9	56.62	226.0	54.88
	13.0	11.8	291.9	57.97	275.9	57.12	258.8	56.47	250.5	55.79	241.9	55.07	226.0	53.38
15.0	13.7	291.9	56.24	275.9	55.39	258.8	54.76	250.5	54.10	241.9	53.42	226.0	51.76	

# 7. Capacity Tables

Heating Capacity (76HP)

Combination (%)	Outdoor air temp.		Indoor air temp. °C DB											
			16		18		20		21		22		24	
	°C DB	°C WB	TC	PI	TC	PI	TC	PI	TC	PI	TC	PI	TC	PI
100	-24.8	-25	141.1	88.19	141.1	88.22	140.2	83.42	140.2	88.30	140.2	88.34	138.3	88.36
	-21.8	-22	172.5	88.23	172.5	88.27	171.6	86.06	171.6	88.35	171.6	89.62	169.2	88.41
	-19.8	-20	182.6	88.27	182.6	88.29	181.6	87.74	181.6	88.39	181.6	88.83	179.3	88.42
	-18.8	-19	186.9	88.29	185.8	88.32	185.8	88.35	185.8	88.39	185.8	88.42	183.3	87.05
	-16.7	-17	194.7	88.33	194.7	88.36	194.7	89.62	193.7	88.42	193.7	85.58	191.1	84.14
	-13.7	-15	208.6	88.37	208.6	88.39	207.3	88.42	207.3	84.30	207.3	81.49	204.8	79.97
	-11.8	-13	215.5	88.41	214.3	88.42	214.3	85.66	214.3	81.67	214.3	78.90	206.3	77.34
	-9.8	-11	222.5	88.42	222.5	85.33	221.6	82.74	221.6	78.91	219.6	76.19	206.5	74.57
	-9.5	-10	224.2	87.94	224.2	84.86	223.2	82.31	223.2	78.49	220.2	75.77	206.5	74.16
	-8.5	-9.1	229.7	86.32	229.7	83.31	228.7	80.85	229.2	77.11	221.6	74.42	206.5	72.76
	-7.0	-7.6	241.9	83.90	241.0	80.99	236.8	78.65	229.2	75.06	221.6	72.37	206.5	70.68
	-5.0	-5.6	252.5	80.65	249.9	77.90	236.8	75.75	229.2	72.28	221.6	69.65	206.5	67.91
	-3.0	-3.7	259.8	77.42	252.0	74.79	236.8	72.84	229.2	69.52	221.6	66.94	206.5	65.13
	0.0	-0.7	267.1	72.55	252.0	70.14	236.8	68.46	229.2	65.39	221.6	62.85	206.5	60.98
	3.0	2.2	267.1	67.68	252.0	65.48	236.8	64.09	229.2	61.25	221.6	58.76	206.5	56.83
	5.0	4.1	267.1	64.45	252.0	62.39	236.8	61.17	229.2	58.49	221.6	56.04	206.5	54.05
	7.0	6.0	267.1	61.20	252.0	59.28	236.8	58.25	229.2	55.73	221.6	53.32	206.5	51.28
	9.0	7.9	267.1	58.83	252.0	56.98	236.8	55.99	229.2	53.58	221.6	51.27	206.5	49.29
	11.0	9.8	267.1	56.95	252.0	55.17	236.8	54.22	229.2	51.86	221.6	49.62	206.5	47.73
	13.0	11.8	267.1	54.97	252.0	53.23	236.8	52.31	229.2	50.05	221.6	47.88	206.5	46.04
15.0	13.7	267.1	52.87	252.0	51.19	236.8	50.31	229.2	48.12	221.6	46.05	206.5	44.28	
90	-24.8	-25	140.5	78.26	140.5	80.06	139.6	81.35	139.6	81.93	139.6	83.15	137.9	84.97
	-21.8	-22	171.9	80.06	171.9	81.88	171.0	83.15	171.0	83.75	171.0	84.97	168.6	81.35
	-19.8	-20	182.0	81.28	182.0	83.09	180.7	84.35	180.7	84.97	180.7	82.49	178.4	78.94
	-18.8	-19	186.9	81.88	185.8	83.70	185.0	84.97	185.0	83.70	185.0	81.26	182.7	77.74
	-16.7	-17	194.7	83.15	194.7	84.97	193.9	82.35	193.9	81.03	193.9	78.68	187.7	75.20
	-13.7	-15	208.6	84.97	208.6	81.06	206.7	78.60	206.7	77.23	202.1	74.97	188.7	71.58
	-11.8	-13	215.5	82.29	214.3	78.60	213.4	76.22	208.8	74.81	203.2	72.64	188.7	69.29
	-9.8	-11	222.5	79.50	222.5	76.02	215.6	73.73	210.0	72.26	203.2	70.17	188.7	66.88
	-9.5	-10	224.2	79.07	224.2	75.61	216.2	73.35	210.0	71.88	203.2	69.79	188.7	66.51
	-8.5	-9.1	229.7	77.68	228.1	74.32	216.7	72.09	210.0	70.62	203.2	68.56	188.7	65.31
	-7.0	-7.6	241.9	75.57	230.1	72.37	216.7	70.23	210.0	68.71	203.2	66.71	188.7	63.50
	-5.0	-5.6	244.5	72.76	230.1	69.78	216.7	67.74	210.0	66.19	203.2	64.25	188.7	61.10
	-3.0	-3.7	244.5	69.96	230.1	67.20	216.7	65.24	210.0	63.64	203.2	61.77	188.7	58.68
	0.0	-0.7	244.5	65.76	230.1	63.29	216.7	61.49	210.0	59.84	203.2	58.07	188.7	55.07
	3.0	2.2	244.5	61.54	230.1	59.39	216.7	57.75	210.0	56.04	203.2	54.38	188.7	51.44
	5.0	4.1	244.5	58.73	230.1	56.80	216.7	55.25	210.0	53.49	203.2	51.90	188.7	49.02
	7.0	6.0	244.5	55.93	230.1	54.22	216.7	52.76	210.0	50.97	203.2	49.45	188.7	46.63
	9.0	7.9	244.5	53.28	230.1	51.64	216.7	50.25	210.0	48.55	203.2	47.10	188.7	44.42
	11.0	9.8	244.5	50.64	230.1	49.09	216.7	47.76	210.0	46.13	203.2	44.76	188.7	42.20
	13.0	11.8	244.5	47.99	230.1	46.51	216.7	45.27	210.0	43.72	203.2	42.43	188.7	39.99
15.0	13.7	244.5	45.35	230.1	43.95	216.7	42.76	210.0	41.30	203.2	40.07	188.7	37.79	
80	-24.8	-25	139.9	68.63	139.9	70.45	139.0	71.72	139.0	72.32	139.0	75.34	137.3	72.16
	-21.8	-22	170.0	70.45	170.0	72.25	170.0	73.52	170.0	75.34	170.0	72.16	166.8	69.09
	-19.8	-20	180.1	71.65	180.1	73.46	180.1	75.34	180.1	73.10	178.7	70.03	168.6	67.06
	-18.8	-19	184.3	72.25	184.3	75.34	184.3	74.20	184.3	71.97	179.8	68.96	168.6	66.04
	-16.7	-17	191.7	75.34	191.7	72.97	191.7	71.82	187.2	69.62	181.3	66.76	168.6	63.91
	-13.7	-15	202.6	71.84	198.6	69.58	193.8	68.42	188.0	66.25	181.3	63.56	168.6	60.84
	-11.8	-13	207.6	69.61	201.5	67.44	193.8	66.25	188.0	64.12	181.3	61.55	168.6	58.90
	-9.8	-11	212.7	67.27	204.2	65.20	193.8	63.98	188.0	61.89	181.3	59.42	168.6	56.86
	-9.5	-10	214.2	66.93	205.4	64.85	193.8	63.63	188.0	61.54	181.3	59.10	168.6	56.56
	-8.5	-9.1	216.6	65.76	206.5	63.73	193.8	62.50	188.0	60.42	181.3	58.05	168.6	55.54
	-7.0	-7.6	219.0	64.00	206.5	62.03	193.8	60.80	188.0	58.74	181.3	56.47	168.6	54.00
	-5.0	-5.6	219.0	61.67	206.5	59.79	193.8	58.52	188.0	56.48	181.3	54.33	168.6	51.96
	-3.0	-3.7	219.0	59.33	206.5	57.53	193.8	56.25	188.0	54.25	181.3	52.22	168.6	49.92
	0.0	-0.7	219.0	55.81	206.5	54.16	193.8	52.85	188.0	50.89	181.3	49.02	168.6	46.87
	3.0	2.2	219.0	52.31	206.5	50.76	193.8	49.43	188.0	47.50	181.3	45.85	168.6	43.80
	5.0	4.1	219.0	49.98	206.5	48.52	193.8	47.16	188.0	45.27	181.3	43.72	168.6	41.77
	7.0	6.0	219.0	47.65	206.5	46.26	193.8	44.90	188.0	43.03	181.3	41.61	168.6	39.72
	9.0	7.9	219.0	44.73	206.5	43.44	193.8	42.15	188.0	40.40	181.3	39.07	168.6	37.30
	11.0	9.8	219.0	41.52	206.5	40.31	193.8	39.13	188.0	37.49	181.3	36.25	168.6	34.61
	13.0	11.8	219.0	38.76	206.5	37.62	193.8	36.53	188.0	35.00	181.3	33.84	168.6	32.31
15.0	13.7	219.0	36.47	206.5	35.41	193.8	34.36	188.0	32.94	181.3	31.86	168.6	30.42	

# 7. Capacity Tables

Heating Capacity (76HP)

Combination (%)	Outdoor air temp.		Indoor air temp. °C DB											
			16		18		20		21		22		24	
	°C DB	°C WB	TC	PI	TC	PI	TC	PI	TC	PI	TC	PI	TC	PI
70	-24.8	-25	139.9	69.60	139.9	70.20	139.0	71.42	139.0	73.24	139.0	69.79	137.2	66.56
	-21.8	-22	164.8	71.42	165.1	72.02	164.0	73.24	159.3	69.79	154.6	66.56	144.3	63.45
	-19.8	-20	179.4	72.63	174.2	73.24	165.0	70.82	159.3	67.50	154.6	64.42	144.3	61.38
	-18.8	-19	183.1	73.24	175.1	71.99	165.0	69.61	159.3	66.34	154.6	63.34	144.3	60.32
	-16.7	-17	185.4	70.64	175.3	69.36	165.0	67.09	159.3	63.93	154.6	61.09	144.3	58.15
	-13.7	-15	185.7	66.96	175.3	65.63	165.0	63.46	159.3	60.50	154.6	57.87	144.3	55.02
	-11.8	-13	185.7	64.60	175.3	63.26	165.0	61.16	159.3	58.30	154.6	55.82	144.3	53.05
	-9.8	-11	185.7	62.15	175.3	60.76	165.0	58.76	159.3	56.00	154.6	53.67	144.3	50.97
	-9.5	-10	185.7	61.78	175.3	60.38	165.0	58.40	159.3	55.67	154.6	53.36	144.3	50.66
	-8.5	-9.1	185.7	60.56	175.3	59.14	165.0	57.18	159.3	54.52	154.6	52.28	144.3	49.61
	-7.0	-7.6	185.7	58.70	175.3	57.28	165.0	55.38	159.3	52.80	154.6	50.67	144.3	48.06
	-5.0	-5.6	185.7	56.24	175.3	54.79	165.0	52.96	159.3	50.51	154.6	48.52	144.3	45.98
	-3.0	-3.7	185.7	53.79	175.3	52.28	165.0	50.54	159.3	48.21	154.6	46.37	144.3	43.89
	0.0	-0.7	185.7	50.10	175.3	48.55	165.0	46.93	159.3	44.76	154.6	43.15	144.3	40.78
	3.0	2.2	185.7	46.40	175.3	44.81	165.0	43.30	159.3	41.34	154.6	39.92	144.3	37.65
	5.0	4.1	185.7	43.94	175.3	42.30	165.0	40.90	159.3	39.04	154.6	37.77	144.3	35.58
	7.0	6.0	185.7	41.48	175.3	39.82	165.0	38.49	159.3	36.74	154.6	35.63	144.3	33.50
	9.0	7.9	185.7	37.46	175.3	35.95	165.0	34.76	159.3	33.18	154.6	32.18	144.3	30.24
	11.0	9.8	185.7	34.89	175.3	33.47	165.0	32.35	159.3	30.89	154.6	29.96	144.3	28.16
	13.0	11.8	185.7	32.63	175.3	31.32	165.0	30.27	159.3	28.91	154.6	28.03	144.3	26.37
15.0	13.7	185.7	30.76	175.3	29.53	165.0	28.54	159.3	27.24	154.6	26.43	144.3	24.84	
60	-24.8	-25	139.3	68.38	139.3	69.60	138.4	71.42	135.4	67.78	131.7	64.37	123.6	61.15
	-21.8	-22	151.2	70.20	150.8	71.42	141.5	67.78	136.7	64.37	132.0	61.15	123.6	58.05
	-19.8	-20	159.3	71.42	150.8	68.85	141.5	65.35	136.7	62.10	132.0	59.00	123.6	55.97
	-18.8	-19	159.3	70.13	150.8	67.56	141.5	64.13	136.7	60.94	132.0	57.93	123.6	54.92
	-16.7	-17	159.3	67.41	150.8	64.86	141.5	61.59	136.7	58.55	132.0	55.69	123.6	52.74
	-13.7	-15	159.3	63.52	150.8	61.03	141.5	57.96	136.7	55.14	132.0	52.48	123.6	49.64
	-11.8	-13	159.3	61.08	150.8	58.58	141.5	55.64	136.7	52.97	132.0	50.45	123.6	47.68
	-9.8	-11	159.3	58.50	150.8	56.02	141.5	53.22	136.7	50.70	132.0	48.30	123.6	45.59
	-9.5	-10	159.3	58.10	150.8	55.65	141.5	52.86	136.7	50.36	132.0	47.97	123.6	45.28
	-8.5	-9.1	159.3	56.82	150.8	54.36	141.5	51.65	136.7	49.23	132.0	46.89	123.6	44.25
	-7.0	-7.6	159.3	54.89	150.8	52.43	141.5	49.84	136.7	47.51	132.0	45.29	123.6	42.69
	-5.0	-5.6	159.3	52.30	150.8	49.86	141.5	47.40	136.7	45.24	132.0	43.15	123.6	40.62
	-3.0	-3.7	159.3	49.72	150.8	47.29	141.5	44.98	136.7	42.97	132.0	41.01	123.6	38.54
	0.0	-0.7	159.3	45.84	150.8	43.45	141.5	41.36	136.7	39.54	132.0	37.79	123.6	35.43
	3.0	2.2	159.3	41.96	150.8	39.60	141.5	37.71	136.7	36.14	132.0	34.59	123.6	32.31
	5.0	4.1	159.3	39.38	150.8	37.03	141.5	35.30	136.7	33.87	132.0	32.44	123.6	30.25
	7.0	6.0	159.3	36.81	150.8	34.46	141.5	32.87	136.7	31.58	132.0	30.30	123.6	28.16
	9.0	7.9	159.3	32.84	150.8	30.76	141.5	29.32	136.7	28.17	132.0	27.02	123.6	25.13
	11.0	9.8	159.3	30.65	150.8	28.72	141.5	27.38	136.7	26.31	132.0	25.25	123.6	23.46
	13.0	11.8	159.3	28.72	150.8	26.89	141.5	25.66	136.7	24.64	132.0	23.64	123.6	22.00
15.0	13.7	159.3	27.14	150.8	25.44	141.5	24.24	136.7	23.29	132.0	22.34	123.6	20.79	
50	-24.8	-25	132.9	60.73	125.3	62.55	117.9	59.27	114.1	56.20	110.3	53.29	102.7	50.60
	-21.8	-22	132.9	62.55	125.3	59.27	117.9	56.20	114.1	53.29	110.3	50.60	102.7	48.00
	-19.8	-20	132.9	60.26	125.3	57.08	117.9	54.16	114.1	51.35	110.3	48.79	102.7	46.25
	-18.8	-19	132.9	59.12	125.3	55.98	117.9	53.14	114.1	50.40	110.3	47.88	102.7	45.38
	-16.7	-17	132.9	56.73	125.3	53.70	117.9	51.00	114.1	48.37	110.3	46.00	102.7	43.56
	-13.7	-15	132.9	53.31	125.3	50.41	117.9	47.93	114.1	45.46	110.3	43.30	102.7	40.96
	-11.8	-13	132.9	51.15	125.3	48.34	117.9	45.98	114.1	43.62	110.3	41.59	102.7	39.31
	-9.8	-11	132.9	48.86	125.3	46.15	117.9	43.93	114.1	41.68	110.3	39.78	102.7	37.56
	-9.5	-10	132.9	48.52	125.3	45.83	117.9	43.64	114.1	41.40	110.3	39.52	102.7	37.31
	-8.5	-9.1	132.9	47.36	125.3	44.73	117.9	42.61	114.1	40.43	110.3	38.62	102.7	36.44
	-7.0	-7.6	132.9	45.66	125.3	43.11	117.9	41.08	114.1	38.99	110.3	37.27	102.7	35.15
	-5.0	-5.6	132.9	43.37	125.3	40.92	117.9	39.04	114.1	37.04	110.3	35.45	102.7	33.41
	-3.0	-3.7	132.9	41.09	125.3	38.73	117.9	36.98	114.1	35.11	110.3	33.64	102.7	31.68
	0.0	-0.7	132.9	37.67	125.3	35.43	117.9	33.92	114.1	32.20	110.3	30.95	102.7	29.06
	3.0	2.2	132.9	34.26	125.3	32.17	117.9	30.86	114.1	29.29	110.3	28.25	102.7	26.46
	5.0	4.1	132.9	31.97	125.3	29.98	117.9	28.81	114.1	27.37	110.3	26.44	102.7	24.74
	7.0	6.0	132.9	29.68	125.3	27.79	117.9	26.77	114.1	25.44	110.3	24.63	102.7	22.99
	9.0	7.9	132.9	26.80	125.3	25.10	117.9	24.17	114.1	22.96	110.3	22.25	102.7	20.76
	11.0	9.8	132.9	25.07	125.3	23.49	117.9	22.62	114.1	21.50	110.3	20.82	102.7	19.42
	13.0	11.8	132.9	23.55	125.3	22.06	117.9	21.23	114.1	20.17	110.3	19.55	102.7	18.25
15.0	13.7	132.9	22.28	125.3	20.86	117.9	20.10	114.1	19.09	110.3	18.49	102.7	17.26	

**Note**

1. TC: Total Capacity(kW), PI : Power Input(kW, Comp. + Outdoor fan motor)
2. Capacity tables show the average value of conditions which may occur.
3. The heating capacity table is based on the values expressed as Max. in the specification of the outdoor unit. (When measuring the Max. heating capacity, the setting status of the indoor unit is the same as that for measuring the heating capacity of the indoor unit.)

# 7. Capacity Tables

## ◆ ARUM780LTE5

Heating Capacity (78HP)

Combination (%)	Outdoor air temp.		Indoor air temp. °C DB											
			16		18		20		21		22		24	
	°C DB	°C WB	TC	PI	TC	PI	TC	PI	TC	PI	TC	PI	TC	PI
130	-24.8	-25	152.0	80.5	152.0	81.23	151.0	81.88	151.0	82.85	151.0	83.82	148.6	85.32
	-21.8	-22	184.6	81.97	184.6	82.71	183.3	83.36	183.3	84.35	183.3	85.32	180.2	86.79
	-19.8	-20	194.5	82.96	194.5	83.71	193.2	84.35	193.2	85.36	193.2	86.29	190.0	87.79
	-18.8	-19	198.9	83.46	198.9	84.21	197.6	84.86	197.6	85.85	197.6	86.79	194.2	88.29
	-16.7	-17	207.9	84.51	207.9	85.25	206.5	85.90	206.5	86.89	206.5	87.85	203.0	89.33
	-13.7	-15	220.7	86.00	220.7	86.75	219.3	87.40	219.3	88.39	219.3	89.33	215.6	85.85
	-11.8	-13	227.8	86.96	227.8	87.68	226.5	88.33	226.5	89.33	226.5	86.99	223.5	83.64
	-9.8	-11	235.4	87.93	235.4	88.69	234.0	89.33	234.0	86.83	234.0	84.52	231.6	81.33
	-9.5	-10	236.7	88.11	236.7	88.83	235.4	88.95	235.4	86.44	235.0	84.15	232.9	80.96
	-8.5	-9.1	241.5	88.58	241.5	89.33	240.2	87.65	240.2	85.18	238.9	82.91	236.9	79.80
	-7.0	-7.6	248.7	89.33	248.7	87.43	247.1	85.72	247.1	83.29	247.1	81.03	243.6	78.06
	-5.0	-5.6	258.3	86.86	258.3	84.89	256.6	83.13	256.6	80.77	256.6	78.56	251.8	75.74
	-3.0	-3.7	267.8	84.38	267.8	82.36	266.1	80.54	266.1	78.24	266.1	76.09	260.2	73.41
	0.0	-0.7	282.0	80.65	282.0	78.55	280.2	76.68	280.2	74.47	280.2	72.38	272.6	69.93
	3.0	2.2	296.4	76.94	296.4	74.72	294.4	72.79	294.4	70.69	292.9	68.64	274.5	66.45
	5.0	4.1	305.2	74.44	305.2	72.19	303.6	70.21	302.4	68.17	294.8	66.17	274.5	64.11
	7.0	6.0	313.0	71.97	313.0	69.64	311.1	67.63	305.5	65.66	294.8	63.70	274.5	61.80
9.0	7.9	314.2	69.92	314.2	67.65	313.2	65.69	305.5	63.78	294.8	61.89	274.5	60.03	
11.0	9.8	314.2	68.46	314.2	66.25	313.2	64.34	305.5	62.46	294.8	60.60	274.5	58.78	
13.0	11.8	314.2	66.91	314.2	64.74	313.2	62.86	305.5	61.04	294.8	59.23	274.5	57.45	
15.0	13.7	314.2	65.24	314.2	63.14	313.2	61.30	305.5	59.51	294.8	57.75	274.5	56.01	
120	-24.8	-25	151.0	81.23	151.0	81.88	150.0	82.85	150.0	83.82	150.0	85.32	147.6	86.36
	-21.8	-22	183.3	82.71	183.3	83.36	182.0	84.35	182.0	85.32	182.0	86.79	179.1	87.85
	-19.8	-20	193.1	83.71	193.1	84.35	191.8	85.36	191.8	86.29	191.8	87.79	188.7	88.83
	-18.8	-19	197.3	84.21	197.3	84.86	196.0	85.85	196.0	86.79	196.0	88.29	192.9	89.33
	-16.7	-17	206.3	85.25	206.3	85.90	205.0	86.89	205.0	87.85	205.0	89.33	201.5	87.09
	-13.7	-15	219.0	86.75	219.0	87.40	217.7	88.39	217.7	89.33	217.7	85.98	214.0	83.89
	-11.8	-13	226.2	87.68	226.2	88.33	224.8	89.33	224.8	86.96	224.8	83.86	221.9	81.87
	-9.8	-11	233.7	88.69	233.7	89.33	232.4	86.71	232.4	84.46	232.4	81.63	230.0	79.73
	-9.5	-10	235.1	88.83	235.1	88.91	233.8	86.33	233.8	84.09	233.8	81.30	231.4	79.40
	-8.5	-9.1	239.9	89.33	239.9	87.52	238.3	85.01	238.3	82.84	238.1	80.20	235.5	78.34
	-7.0	-7.6	247.0	87.26	247.0	85.45	245.4	83.06	245.4	80.97	244.8	78.52	241.9	76.73
	-5.0	-5.6	256.5	84.49	256.5	82.67	254.9	80.44	254.9	78.46	254.9	76.27	250.2	74.59
	-3.0	-3.7	265.9	81.72	265.9	79.92	264.2	77.81	264.2	75.99	264.2	74.05	257.0	72.45
	0.0	-0.7	280.1	77.57	280.1	75.75	278.2	73.89	278.2	72.23	277.0	70.70	257.8	69.25
	3.0	2.2	294.2	73.42	294.2	71.59	291.5	69.97	286.3	68.49	277.4	67.35	257.8	66.05
	5.0	4.1	303.1	70.65	302.6	68.82	296.2	67.36	286.3	65.99	277.4	65.13	257.8	63.91
	7.0	6.0	310.8	67.88	308.5	66.04	296.2	64.74	286.3	63.49	277.4	62.90	257.8	61.77
9.0	7.9	311.8	65.77	308.5	63.99	296.2	62.74	286.3	61.55	277.4	60.97	257.8	59.86	
11.0	9.8	311.8	64.26	308.5	62.52	296.2	61.28	286.3	60.12	277.4	59.54	257.8	58.48	
13.0	11.8	311.8	62.62	308.5	60.92	296.2	59.73	286.3	58.59	277.4	58.04	257.8	57.01	
15.0	13.7	311.8	60.89	308.5	59.23	296.2	58.07	286.3	56.95	277.4	56.41	257.8	55.41	
110	-24.8	-25	150.2	81.88	150.2	82.85	149.3	83.82	149.3	85.32	149.3	86.36	146.7	86.85
	-21.8	-22	182.4	83.36	182.4	84.35	181.1	85.32	181.1	86.79	181.1	87.85	178.2	88.33
	-19.8	-20	192.1	84.35	192.1	85.36	190.9	86.29	190.9	87.79	190.9	88.83	187.6	89.33
	-18.8	-19	196.3	84.86	196.3	85.85	195.0	86.79	195.0	88.29	195.0	89.33	191.8	88.15
	-16.7	-17	205.2	85.90	205.2	86.89	203.9	87.85	203.9	89.33	203.9	86.92	200.4	85.67
	-13.7	-15	217.8	87.40	217.8	88.39	216.4	89.33	216.4	85.67	216.4	83.45	216.4	82.14
	-11.8	-13	225.0	88.33	225.0	89.33	223.5	86.74	223.5	83.34	223.5	81.26	223.5	79.90
	-9.8	-11	232.4	89.33	232.4	86.41	231.1	84.03	231.1	80.90	231.1	78.96	229.8	77.55
	-9.5	-10	233.8	88.85	233.8	85.96	232.5	83.60	232.5	80.53	232.5	78.62	231.7	77.20
	-8.5	-9.1	238.6	87.28	238.6	84.50	237.2	82.24	237.2	79.30	237.2	77.44	232.0	76.00
	-7.0	-7.6	245.7	84.89	245.7	82.31	244.1	80.20	244.1	77.47	244.1	75.73	232.0	74.25
	-5.0	-5.6	255.0	81.74	255.0	79.36	253.3	77.48	253.3	75.03	248.3	73.42	232.0	71.87
	-3.0	-3.7	264.4	78.57	264.4	76.44	262.7	74.73	257.2	72.57	248.3	71.10	232.0	69.53
	0.0	-0.7	278.5	73.82	278.1	72.05	265.7	70.65	257.2	68.91	248.3	67.66	232.0	66.00
	3.0	2.2	292.1	69.07	283.3	67.65	265.7	66.55	257.2	65.26	248.3	64.18	232.0	62.45
	5.0	4.1	299.7	65.90	283.3	64.72	265.7	63.83	257.2	62.80	248.3	61.88	232.0	60.09
	7.0	6.0	299.7	62.72	283.3	61.79	265.7	61.09	257.2	60.35	248.3	59.58	232.0	57.74
9.0	7.9	299.7	60.52	283.3	59.62	265.7	58.96	257.2	58.23	248.3	57.49	232.0	55.71	
11.0	9.8	299.7	58.85	283.3	57.97	265.7	57.30	257.2	56.60	248.3	55.87	232.0	54.16	
13.0	11.8	299.7	57.03	283.3	56.19	265.7	55.55	257.2	54.88	248.3	54.18	232.0	52.52	
15.0	13.7	299.7	55.14	283.3	54.30	265.7	53.69	257.2	53.03	248.3	52.37	232.0	50.74	

# 7. Capacity Tables

Heating Capacity (78HP)

Combination (%)	Outdoor air temp.		Indoor air temp. °C DB											
			16		18		20		21		22		24	
	°C DB	°C WB	TC	PI	TC	PI	TC	PI	TC	PI	TC	PI	TC	PI
100	-24.8	-25	149.5	89.83	149.5	89.77	148.6	84.64	148.6	89.60	148.6	89.54	146.0	89.51
	-21.8	-22	181.4	89.73	181.4	89.67	180.4	87.32	180.4	89.50	180.4	90.54	177.2	89.41
	-19.8	-20	191.2	89.67	191.2	89.59	190.1	89.00	190.1	89.44	190.1	89.74	187.0	89.33
	-18.8	-19	195.4	89.64	194.3	89.57	194.3	89.50	194.3	89.39	194.3	89.33	190.9	87.90
	-16.7	-17	203.0	89.57	203.0	89.50	203.0	90.54	202.0	89.33	202.0	86.37	198.5	84.90
	-13.7	-15	216.8	89.47	216.8	89.39	215.5	89.33	215.5	85.03	215.5	82.14	212.0	80.58
	-11.8	-13	223.9	89.41	222.6	89.33	222.6	86.44	222.6	82.29	222.6	79.44	212.0	77.86
	-9.8	-11	231.1	89.33	231.1	86.09	230.2	83.39	230.2	79.43	227.5	76.63	212.0	74.99
	-9.5	-10	232.5	88.82	232.5	85.59	231.5	82.94	231.5	78.99	227.5	76.20	212.0	74.56
	-8.5	-9.1	237.3	87.12	237.3	83.98	236.2	81.41	235.3	77.55	227.5	74.79	212.0	73.12
	-7.0	-7.6	248.3	84.57	247.4	81.54	243.1	79.12	235.3	75.42	227.5	72.68	212.0	70.96
	-5.0	-5.6	259.2	81.16	256.6	78.31	243.1	76.09	235.3	72.53	227.5	69.85	212.0	68.09
	-3.0	-3.7	266.7	77.76	258.7	75.05	243.1	73.04	235.3	69.65	227.5	67.04	212.0	65.22
	0.0	-0.7	274.2	72.66	258.7	70.19	243.1	68.47	235.3	65.35	227.5	62.79	212.0	60.92
	3.0	2.2	274.2	67.54	258.7	65.31	243.1	63.90	235.3	61.05	227.5	58.56	212.0	56.62
	5.0	4.1	274.2	64.14	258.7	62.08	243.1	60.85	235.3	58.17	227.5	55.73	212.0	53.75
	7.0	6.0	274.2	60.73	258.7	58.82	243.1	57.80	235.3	55.30	227.5	52.91	212.0	50.88
9.0	7.9	274.2	58.13	258.7	56.30	243.1	55.32	235.3	52.94	227.5	50.66	212.0	48.70	
11.0	9.8	274.2	56.01	258.7	54.26	243.1	53.32	235.3	51.00	227.5	48.79	212.0	46.94	
13.0	11.8	274.2	53.78	258.7	52.07	243.1	51.17	235.3	48.96	227.5	46.84	212.0	45.04	
15.0	13.7	274.2	51.41	258.7	49.78	243.1	48.92	235.3	46.79	227.5	44.78	212.0	43.06	
90	-24.8	-25	148.9	80.33	148.9	81.81	148.0	82.87	148.0	83.35	148.0	84.35	145.6	85.85
	-21.8	-22	180.7	81.81	180.7	83.31	179.7	84.35	179.7	84.85	179.7	85.85	176.5	82.11
	-19.8	-20	190.5	82.81	190.5	84.30	189.2	85.34	189.2	85.85	189.2	83.28	186.1	79.62
	-18.8	-19	195.4	83.31	194.3	84.81	193.4	85.85	193.4	84.54	193.4	82.01	190.2	78.39
	-16.7	-17	203.0	84.35	203.0	85.85	202.2	83.12	202.2	81.76	202.2	79.34	193.7	75.77
	-13.7	-15	216.8	85.85	216.8	81.78	214.8	79.23	214.8	77.82	208.7	75.50	193.7	72.03
	-11.8	-13	223.9	83.05	222.6	79.21	221.7	76.75	215.6	75.31	208.7	73.08	193.7	69.67
	-9.8	-11	231.1	80.14	231.1	76.52	222.5	74.16	215.6	72.67	208.7	70.52	193.7	67.18
	-9.5	-10	232.5	79.68	232.5	76.10	222.5	73.77	215.6	72.28	208.7	70.13	193.7	66.80
	-8.5	-9.1	237.3	78.23	235.6	74.76	222.5	72.46	215.6	70.96	208.7	68.86	193.7	65.55
	-7.0	-7.6	248.3	76.02	236.2	72.72	222.5	70.52	215.6	68.98	208.7	66.94	193.7	63.68
	-5.0	-5.6	251.0	73.09	236.2	70.02	222.5	67.94	215.6	66.37	208.7	64.39	193.7	61.21
	-3.0	-3.7	251.0	70.16	236.2	67.33	222.5	65.33	215.6	63.72	208.7	61.82	193.7	58.71
	0.0	-0.7	251.0	65.77	236.2	63.26	222.5	61.43	215.6	59.78	208.7	58.00	193.7	54.98
	3.0	2.2	251.0	61.36	236.2	59.19	222.5	57.54	215.6	55.83	208.7	54.18	193.7	51.24
	5.0	4.1	251.0	58.43	236.2	56.49	222.5	54.94	215.6	53.19	208.7	51.61	193.7	48.74
	7.0	6.0	251.0	55.49	236.2	53.80	222.5	52.35	215.6	50.57	208.7	49.06	193.7	46.27
9.0	7.9	251.0	52.74	236.2	51.12	222.5	49.75	215.6	48.06	208.7	46.62	193.7	43.97	
11.0	9.8	251.0	49.99	236.2	48.47	222.5	47.15	215.6	45.54	208.7	44.19	193.7	41.66	
13.0	11.8	251.0	47.24	236.2	45.78	222.5	44.56	215.6	43.04	208.7	41.77	193.7	39.37	
15.0	13.7	251.0	44.49	236.2	43.12	222.5	41.96	215.6	40.52	208.7	39.32	193.7	37.08	
80	-24.8	-25	148.2	70.60	148.2	72.10	147.3	73.14	147.3	73.64	147.3	76.12	144.9	72.84
	-21.8	-22	178.8	72.10	178.8	73.58	178.8	74.62	178.8	76.12	178.8	72.84	173.1	69.68
	-19.8	-20	188.5	73.08	188.5	74.57	188.5	76.12	188.5	73.80	185.9	70.64	173.1	67.58
	-18.8	-19	192.7	73.58	192.7	76.12	192.7	74.94	192.2	72.64	186.1	69.54	173.1	66.54
	-16.7	-17	198.9	76.12	198.9	73.66	198.9	72.47	193.0	70.21	186.1	67.26	173.1	64.34
	-13.7	-15	208.0	72.48	203.9	70.14	198.9	68.94	193.0	66.72	186.1	63.96	173.1	61.18
	-11.8	-13	213.5	70.15	207.2	67.91	198.9	66.69	193.0	64.51	186.1	61.88	173.1	59.17
	-9.8	-11	219.1	67.72	210.0	65.58	198.9	64.34	193.0	62.20	186.1	59.68	173.1	57.07
	-9.5	-10	220.6	67.36	211.2	65.22	198.9	63.98	193.0	61.85	186.1	59.35	173.1	56.77
	-8.5	-9.1	222.8	66.15	212.0	64.05	198.9	62.81	193.0	60.68	186.1	58.27	173.1	55.71
	-7.0	-7.6	224.8	64.31	212.0	62.29	198.9	61.04	193.0	58.95	186.1	56.63	173.1	54.13
	-5.0	-5.6	224.8	61.88	212.0	59.96	198.9	58.68	193.0	56.61	186.1	54.42	173.1	52.03
	-3.0	-3.7	224.8	59.45	212.0	57.61	198.9	56.32	193.0	54.31	186.1	52.25	173.1	49.92
	0.0	-0.7	224.8	55.78	212.0	54.11	198.9	52.80	193.0	50.82	186.1	48.94	173.1	46.78
	3.0	2.2	224.8	52.14	212.0	50.58	198.9	49.25	193.0	47.32	186.1	45.66	173.1	43.62
	5.0	4.1	224.8	49.71	212.0	48.25	198.9	46.90	193.0	45.01	186.1	43.47	173.1	41.52
	7.0	6.0	224.8	47.28	212.0	45.90	198.9	44.55	193.0	42.70	186.1	41.29	173.1	39.41
9.0	7.9	224.8	44.39	212.0	43.10	198.9	41.82	193.0	40.09	186.1	38.77	173.1	37.02	
11.0	9.8	224.8	41.20	212.0	40.00	198.9	38.83	193.0	37.20	186.1	35.97	173.1	34.35	
13.0	11.8	224.8	38.46	212.0	37.33	198.9	36.25	193.0	34.73	186.1	33.58	173.1	32.06	
15.0	13.7	224.8	36.19	212.0	35.14	198.9	34.10	193.0	32.68	186.1	31.61	173.1	30.19	

# 7. Capacity Tables

Heating Capacity (78HP)

Combination (%)	Outdoor air temp.		Indoor air temp. °C DB											
			16		18		20		21		22		24	
	°C DB	°C WB	TC	PI	TC	PI	TC	PI	TC	PI	TC	PI	TC	PI
70	-24.8	-25	148.2	71.20	148.2	71.69	147.3	72.70	147.3	74.20	147.3	70.64	143.9	67.30
	-21.8	-22	170.5	72.70	170.5	73.19	169.4	74.20	163.6	70.64	158.7	67.30	148.1	64.09
	-19.8	-20	185.2	73.70	180.0	74.20	169.4	71.69	163.6	68.26	158.7	65.08	148.1	61.96
	-18.8	-19	189.2	74.20	180.0	72.90	169.4	70.43	163.6	67.07	158.7	63.97	148.1	60.87
	-16.7	-17	190.7	71.49	180.0	70.17	169.4	67.82	163.6	64.57	158.7	61.65	148.1	58.63
	-13.7	-15	190.7	67.67	180.0	66.30	169.4	64.06	163.6	61.02	158.7	58.32	148.1	55.41
	-11.8	-13	190.7	65.21	180.0	63.84	169.4	61.68	163.6	58.75	158.7	56.20	148.1	53.38
	-9.8	-11	190.7	62.67	180.0	61.25	169.4	59.20	163.6	56.38	158.7	53.99	148.1	51.24
	-9.5	-10	190.7	62.27	180.0	60.85	169.4	58.82	163.6	56.03	158.7	53.67	148.1	50.92
	-8.5	-9.1	190.7	61.01	180.0	59.57	169.4	57.56	163.6	54.84	158.7	52.55	148.1	49.84
	-7.0	-7.6	190.7	59.08	180.0	57.63	169.4	55.69	163.6	53.07	158.7	50.89	148.1	48.24
	-5.0	-5.6	190.7	56.52	180.0	55.05	169.4	53.19	163.6	50.69	158.7	48.66	148.1	46.09
	-3.0	-3.7	190.7	53.97	180.0	52.44	169.4	50.68	163.6	48.31	158.7	46.45	148.1	43.95
	0.0	-0.7	190.7	50.12	180.0	48.57	169.4	46.94	163.6	44.75	158.7	43.12	148.1	40.74
	3.0	2.2	190.7	46.28	180.0	44.69	169.4	43.18	163.6	41.21	158.7	39.79	148.1	37.52
	5.0	4.1	190.7	43.72	180.0	42.09	169.4	40.69	163.6	38.84	158.7	37.57	148.1	35.38
	7.0	6.0	190.7	41.16	180.0	39.51	169.4	38.19	163.6	36.46	158.7	35.35	148.1	33.24
	9.0	7.9	190.7	37.17	180.0	35.67	169.4	34.49	163.6	32.92	158.7	31.94	148.1	30.01
	11.0	9.8	190.7	34.62	180.0	33.21	169.4	32.10	163.6	30.65	158.7	29.73	148.1	27.94
	13.0	11.8	190.7	32.38	180.0	31.08	169.4	30.04	163.6	28.68	158.7	27.82	148.1	26.16
15.0	13.7	190.7	30.53	180.0	29.30	169.4	28.32	163.6	27.03	158.7	26.23	148.1	24.65	
60	-24.8	-25	145.4	70.19	145.4	71.20	144.5	72.70	140.3	68.91	135.5	65.37	126.9	62.04
	-21.8	-22	156.2	71.69	154.8	72.70	145.3	68.91	140.3	65.37	135.5	62.04	126.9	58.83
	-19.8	-20	163.6	72.70	154.8	70.02	145.3	66.39	140.3	63.01	135.5	59.81	126.9	56.68
	-18.8	-19	163.6	71.36	154.8	68.68	145.3	65.12	140.3	61.81	135.5	58.70	126.9	55.60
	-16.7	-17	163.6	68.51	154.8	65.87	145.3	62.48	140.3	59.34	135.5	56.38	126.9	53.35
	-13.7	-15	163.6	64.45	154.8	61.87	145.3	58.71	140.3	55.80	135.5	53.05	126.9	50.14
	-11.8	-13	163.6	61.89	154.8	59.33	145.3	56.29	140.3	53.54	135.5	50.95	126.9	48.12
	-9.8	-11	163.6	59.20	154.8	56.65	145.3	53.78	140.3	51.19	135.5	48.72	126.9	45.96
	-9.5	-10	163.6	58.78	154.8	56.27	145.3	53.40	140.3	50.83	135.5	48.38	126.9	45.64
	-8.5	-9.1	163.6	57.44	154.8	54.93	145.3	52.15	140.3	49.66	135.5	47.26	126.9	44.57
	-7.0	-7.6	163.6	55.42	154.8	52.92	145.3	50.26	140.3	47.88	135.5	45.60	126.9	42.96
	-5.0	-5.6	163.6	52.71	154.8	50.24	145.3	47.73	140.3	45.52	135.5	43.39	126.9	40.82
	-3.0	-3.7	163.6	50.02	154.8	47.56	145.3	45.21	140.3	43.16	135.5	41.16	126.9	38.67
	0.0	-0.7	163.6	45.96	154.8	43.56	145.3	41.44	140.3	39.60	135.5	37.83	126.9	35.46
	3.0	2.2	163.6	41.91	154.8	39.55	145.3	37.65	140.3	36.07	135.5	34.51	126.9	32.23
	5.0	4.1	163.6	39.22	154.8	36.87	145.3	35.14	140.3	33.71	135.5	32.29	126.9	30.10
	7.0	6.0	163.6	36.52	154.8	34.20	145.3	32.62	140.3	31.33	135.5	30.07	126.9	27.94
	9.0	7.9	163.6	32.59	154.8	30.52	145.3	29.09	140.3	27.96	135.5	26.81	126.9	24.93
	11.0	9.8	163.6	30.41	154.8	28.50	145.3	27.17	140.3	26.10	135.5	25.05	126.9	23.28
	13.0	11.8	163.6	28.50	154.8	26.68	145.3	25.46	140.3	24.45	135.5	23.46	126.9	21.83
15.0	13.7	163.6	26.93	154.8	25.24	145.3	24.05	140.3	23.11	135.5	22.17	126.9	20.63	
50	-24.8	-25	136.4	61.70	128.6	63.20	121.0	59.84	117.1	56.69	113.2	53.72	105.4	50.97
	-21.8	-22	136.4	63.20	128.6	59.84	121.0	56.69	117.1	53.72	113.2	50.97	105.4	48.32
	-19.8	-20	136.4	60.85	128.6	57.59	121.0	54.61	117.1	51.73	113.2	49.12	105.4	46.53
	-18.8	-19	136.4	59.67	128.6	56.46	121.0	53.56	117.1	50.77	113.2	48.20	105.4	45.65
	-16.7	-17	136.4	57.22	128.6	54.13	121.0	51.37	117.1	48.69	113.2	46.27	105.4	43.79
	-13.7	-15	136.4	53.71	128.6	50.75	121.0	48.23	117.1	45.72	113.2	43.51	105.4	41.14
	-11.8	-13	136.4	51.49	128.6	48.63	121.0	46.23	117.1	43.83	113.2	41.76	105.4	39.46
	-9.8	-11	136.4	49.14	128.6	46.39	121.0	44.13	117.1	41.85	113.2	39.91	105.4	37.67
	-9.5	-10	136.4	48.79	128.6	46.07	121.0	43.83	117.1	41.56	113.2	39.65	105.4	37.42
	-8.5	-9.1	136.4	47.60	128.6	44.94	121.0	42.78	117.1	40.57	113.2	38.73	105.4	36.53
	-7.0	-7.6	136.4	45.86	128.6	43.27	121.0	41.21	117.1	39.09	113.2	37.35	105.4	35.21
	-5.0	-5.6	136.4	43.51	128.6	41.03	121.0	39.13	117.1	37.11	113.2	35.50	105.4	33.44
	-3.0	-3.7	136.4	41.16	128.6	38.78	121.0	37.01	117.1	35.13	113.2	33.65	105.4	31.67
	0.0	-0.7	136.4	37.66	128.6	35.41	121.0	33.88	117.1	32.16	113.2	30.89	105.4	29.00
	3.0	2.2	136.4	34.15	128.6	32.07	121.0	30.75	117.1	29.18	113.2	28.14	105.4	26.35
	5.0	4.1	136.4	31.80	128.6	29.82	121.0	28.65	117.1	27.22	113.2	26.29	105.4	24.60
	7.0	6.0	136.4	29.45	128.6	27.58	121.0	26.57	117.1	25.24	113.2	24.44	105.4	22.81
	9.0	7.9	136.4	26.59	128.6	24.90	121.0	23.99	117.1	22.79	113.2	22.08	105.4	20.60
	11.0	9.8	136.4	24.88	128.6	23.30	121.0	22.45	117.1	21.33	113.2	20.66	105.4	19.27
	13.0	11.8	136.4	23.37	128.6	21.89	121.0	21.06	117.1	20.02	113.2	19.40	105.4	18.11
15.0	13.7	136.4	22.11	128.6	20.70	121.0	19.95	117.1	18.94	113.2	18.35	105.4	17.13	

**Note**

1. TC: Total Capacity(kW), PI : Power Input(kW, Comp. + Outdoor fan motor)
2. Capacity tables show the average value of conditions which may occur.
3. The heating capacity table is based on the values expressed as Max. in the specification of the outdoor unit. (When measuring the Max. heating capacity, the setting status of the indoor unit is the same as that for measuring the heating capacity of the indoor unit.)



# 7. Capacity Tables

## ◆ ARUM800LTE5

Heating Capacity (80HP)

Combination (%)	Outdoor air temp.		Indoor air temp. °C DB											
			16		18		20		21		22		24	
	°C DB	°C WB	TC	PI	TC	PI	TC	PI	TC	PI	TC	PI	TC	PI
130	-24.8	-25	154.2	84.1	154.2	84.79	153.2	85.40	153.2	86.31	153.2	87.22	150.8	88.62
	-21.8	-22	188.4	85.48	188.4	86.18	187.1	86.79	187.1	87.72	187.1	88.62	183.9	90.00
	-19.8	-20	199.1	86.41	199.1	87.12	197.7	87.72	197.7	88.66	197.7	89.53	194.5	90.94
	-18.8	-19	203.6	86.88	203.6	87.58	202.3	88.19	202.3	89.12	202.3	90.00	198.8	91.40
	-16.7	-17	213.0	87.86	213.0	88.56	211.7	89.17	211.7	90.10	211.7	90.99	208.1	92.38
	-13.7	-15	226.4	89.27	226.4	89.96	225.1	90.57	225.1	91.50	225.1	92.38	221.2	88.89
	-11.8	-13	233.8	90.16	233.8	90.84	232.4	91.45	232.4	92.38	232.4	93.04	229.5	86.67
	-9.8	-11	241.5	91.07	241.5	91.78	240.1	92.38	240.1	93.04	240.1	93.75	237.9	84.35
	-9.5	-10	242.9	91.24	242.9	91.91	241.5	92.00	241.5	92.67	241.5	93.34	239.2	83.98
	-8.5	-9.1	247.8	91.68	247.8	92.38	246.4	93.04	246.4	93.71	246.4	94.38	243.5	82.81
	-7.0	-7.6	255.2	92.38	255.2	93.04	253.8	93.71	253.8	94.38	253.8	95.04	250.4	81.07
	-5.0	-5.6	264.9	89.96	264.9	88.00	263.2	86.23	263.2	83.85	263.2	81.61	259.0	78.74
	-3.0	-3.7	274.7	87.54	274.7	85.50	273.0	83.66	273.0	81.33	273.0	79.13	267.7	76.39
	0.0	-0.7	289.2	83.89	289.2	81.75	287.4	79.82	287.4	77.57	287.4	75.42	280.7	72.90
	3.0	2.2	303.9	80.26	303.9	77.97	301.9	75.97	301.9	73.80	300.4	71.68	281.6	69.41
	5.0	4.1	313.0	77.82	313.0	75.47	311.3	73.40	310.1	71.29	302.4	69.20	281.6	67.06
	7.0	6.0	320.9	75.39	320.9	72.95	319.0	70.85	313.5	68.79	302.4	66.73	281.6	64.74
9.0	7.9	322.3	73.39	322.3	71.02	321.3	68.96	313.5	66.96	302.4	64.97	281.6	63.02	
11.0	9.8	322.3	72.03	322.3	69.71	321.3	67.70	313.5	65.71	302.4	63.76	281.6	61.84	
13.0	11.8	322.3	70.57	322.3	68.29	321.3	66.30	313.5	64.38	302.4	62.47	281.6	60.59	
15.0	13.7	322.3	69.00	322.3	66.77	321.3	64.82	313.5	62.93	302.4	61.07	281.6	59.23	
120	-24.8	-25	153.2	84.79	153.2	85.40	152.1	86.31	152.1	87.22	152.1	88.62	149.7	89.60
	-21.8	-22	187.1	86.18	187.1	86.79	185.8	87.72	185.8	88.62	185.8	90.00	182.8	90.99
	-19.8	-20	197.7	87.12	197.7	87.72	196.4	88.66	196.4	89.53	196.4	90.94	193.1	91.91
	-18.8	-19	202.1	87.58	202.1	88.19	200.8	89.12	200.8	90.00	200.8	91.40	197.5	92.38
	-16.7	-17	211.5	88.56	211.5	89.17	210.1	90.10	210.1	90.99	210.1	92.38	206.5	90.13
	-13.7	-15	224.7	89.96	224.7	90.57	223.4	91.50	223.4	92.38	223.4	93.04	219.6	86.92
	-11.8	-13	232.1	90.84	232.1	91.45	230.7	92.38	230.7	93.04	230.7	93.71	227.8	84.89
	-9.8	-11	239.8	91.78	239.8	92.38	238.4	89.77	238.4	87.51	238.4	84.67	236.3	82.74
	-9.5	-10	241.3	91.91	241.3	91.97	239.9	89.39	239.9	87.13	239.9	84.33	237.7	82.41
	-8.5	-9.1	246.1	92.38	246.1	90.58	244.5	88.07	244.5	85.89	244.5	83.23	242.0	81.34
	-7.0	-7.6	253.4	90.33	253.4	88.51	251.8	86.12	251.8	84.01	251.8	81.55	248.6	79.73
	-5.0	-5.6	263.2	87.58	263.2	85.75	261.4	83.50	261.4	81.50	261.4	79.30	257.4	77.58
	-3.0	-3.7	272.7	84.83	272.7	83.01	271.0	80.88	271.0	79.02	271.0	77.07	264.5	75.43
	0.0	-0.7	287.2	80.72	287.2	78.86	285.3	76.96	285.3	75.26	284.1	73.71	264.5	72.22
	3.0	2.2	301.7	76.60	301.7	74.71	299.0	73.04	293.7	71.52	284.6	70.36	264.5	69.01
	5.0	4.1	310.8	73.86	310.3	71.95	303.9	70.44	293.7	69.02	284.6	68.13	264.5	66.86
	7.0	6.0	318.8	71.11	316.5	69.18	303.9	67.82	293.7	66.51	284.6	65.90	264.5	64.71
9.0	7.9	319.9	69.04	316.5	67.17	303.9	65.86	293.7	64.60	284.6	63.99	264.5	62.84	
11.0	9.8	319.9	67.60	316.5	65.76	303.9	64.45	293.7	63.23	284.6	62.63	264.5	61.52	
13.0	11.8	319.9	66.02	316.5	64.23	303.9	62.98	293.7	61.77	284.6	61.19	264.5	60.10	
15.0	13.7	319.9	64.36	316.5	62.61	303.9	61.38	293.7	60.20	284.6	59.63	264.5	58.57	
110	-24.8	-25	152.4	85.40	152.4	86.31	151.4	87.22	151.4	88.62	151.4	89.60	148.8	90.06
	-21.8	-22	186.1	86.79	186.1	87.72	184.8	88.62	184.8	90.00	184.8	90.99	181.8	91.45
	-19.8	-20	196.6	87.72	196.6	88.66	195.4	89.53	195.4	90.94	195.4	91.91	192.0	92.38
	-18.8	-19	201.0	88.19	201.0	89.12	199.7	90.00	199.7	91.40	199.7	92.38	196.4	91.19
	-16.7	-17	210.4	89.17	210.4	90.10	209.0	90.99	209.0	92.38	209.0	93.04	205.4	88.69
	-13.7	-15	223.5	90.57	223.5	91.50	222.0	92.38	222.0	93.04	222.0	93.71	220.0	85.12
	-11.8	-13	230.8	91.45	230.8	92.38	229.4	89.78	229.4	86.36	229.4	84.25	229.4	82.86
	-9.8	-11	238.5	92.38	238.5	89.45	237.1	87.05	237.1	83.90	237.1	81.94	236.1	80.48
	-9.5	-10	239.9	91.90	239.9	88.99	238.6	86.62	238.6	83.53	238.6	81.60	237.7	80.13
	-8.5	-9.1	244.8	90.33	244.8	87.53	243.3	85.26	243.3	82.29	243.3	80.41	238.0	78.93
	-7.0	-7.6	252.1	87.93	252.1	85.33	250.5	83.20	250.5	80.45	250.5	78.68	238.0	77.16
	-5.0	-5.6	261.6	84.77	261.6	82.37	259.9	80.47	259.9	78.00	254.8	76.36	238.0	74.76
	-3.0	-3.7	271.2	81.60	271.2	79.44	269.4	77.71	263.8	75.52	254.8	74.02	238.0	72.39
	0.0	-0.7	285.6	76.83	285.2	75.03	272.6	73.61	263.8	71.83	254.8	70.55	238.0	68.82
	3.0	2.2	299.5	72.07	290.6	70.61	272.6	69.48	263.8	68.16	254.8	67.05	238.0	65.24
	5.0	4.1	307.5	68.89	290.6	67.68	272.6	66.76	263.8	65.68	254.8	64.74	238.0	62.86
	7.0	6.0	307.5	65.70	290.6	64.73	272.6	64.00	263.8	63.22	254.8	62.41	238.0	60.48
9.0	7.9	307.5	63.52	290.6	62.58	272.6	61.88	263.8	61.12	254.8	60.33	238.0	58.47	
11.0	9.8	307.5	61.89	290.6	60.97	272.6	60.27	263.8	59.53	254.8	58.76	238.0	56.96	
13.0	11.8	307.5	60.12	290.6	59.23	272.6	58.56	263.8	57.85	254.8	57.11	238.0	55.36	
15.0	13.7	307.5	58.27	290.6	57.38	272.6	56.74	263.8	56.05	254.8	55.34	238.0	53.62	

# 7. Capacity Tables

Heating Capacity (80HP)

Combination (%)	Outdoor air temp.		Indoor air temp. °C DB											
			16		18		20		21		22		24	
	°C DB	°C WB	TC	PI	TC	PI	TC	PI	TC	PI	TC	PI	TC	PI
100	-24.8	-25	151.7	94.65	151.7	94.36	150.8	88.16	150.8	93.61	150.8	93.30	148.1	93.15
	-21.8	-22	185.1	94.20	185.1	93.90	184.1	90.94	184.1	93.16	184.1	94.13	180.8	92.70
	-19.8	-20	195.7	93.90	195.7	93.58	194.6	92.68	194.6	92.86	194.6	92.97	191.3	92.38
	-18.8	-19	200.1	93.75	199.0	93.45	199.0	93.16	199.0	92.69	199.0	92.38	195.5	90.93
	-16.7	-17	208.1	93.44	208.1	93.13	208.1	94.13	207.0	92.38	207.0	89.38	203.4	87.88
	-13.7	-15	222.4	92.98	222.4	92.67	221.1	92.38	221.1	88.03	221.1	85.08	217.5	83.49
	-11.8	-13	229.7	92.70	228.4	92.38	228.4	89.47	228.4	85.26	228.4	82.35	217.5	80.72
	-9.8	-11	237.2	92.38	237.2	89.12	236.2	86.39	236.2	82.36	233.4	79.49	217.5	77.80
	-9.5	-10	238.6	91.87	238.6	88.61	237.5	85.93	237.5	81.92	233.4	79.06	217.5	77.37
	-8.5	-9.1	243.5	90.16	243.5	86.99	242.4	84.39	241.4	80.46	233.4	77.63	217.5	75.90
	-7.0	-7.6	254.8	87.60	253.8	84.53	249.4	82.07	241.4	78.29	233.4	75.48	217.5	73.71
	-5.0	-5.6	265.9	84.16	263.2	81.27	249.4	79.01	241.4	75.37	233.4	72.62	217.5	70.80
	-3.0	-3.7	273.6	80.75	265.4	77.99	249.4	75.94	241.4	72.46	233.4	69.76	217.5	67.88
	0.0	-0.7	281.3	75.61	265.4	73.09	249.4	71.32	241.4	68.11	233.4	65.45	217.5	63.51
	3.0	2.2	281.3	70.46	265.4	68.17	249.4	66.71	241.4	63.75	233.4	61.16	217.5	59.14
	5.0	4.1	281.3	67.05	265.4	64.90	249.4	63.63	241.4	60.84	233.4	58.29	217.5	56.22
	7.0	6.0	281.3	63.61	265.4	61.62	249.4	60.55	241.4	57.93	233.4	55.43	217.5	53.30
	9.0	7.9	281.3	61.18	265.4	59.26	249.4	58.23	241.4	55.72	233.4	53.32	217.5	51.26
	11.0	9.8	281.3	59.26	265.4	57.40	249.4	56.41	241.4	53.95	233.4	51.62	217.5	49.66
	13.0	11.8	281.3	57.23	265.4	55.42	249.4	54.46	241.4	52.10	233.4	49.85	217.5	47.93
15.0	13.7	281.3	55.07	265.4	53.32	249.4	52.40	241.4	50.13	233.4	47.97	217.5	46.13	
90	-24.8	-25	151.1	84.08	151.1	85.46	150.1	86.46	150.1	86.90	150.1	87.85	147.7	89.25
	-21.8	-22	184.4	85.46	184.4	86.87	183.4	87.85	183.4	88.31	183.4	89.25	180.1	85.40
	-19.8	-20	195.0	86.41	195.0	87.80	193.7	88.78	193.7	89.25	193.7	86.61	190.5	82.84
	-18.8	-19	200.1	86.87	199.0	88.28	198.1	89.25	198.1	87.90	198.1	85.30	194.8	81.56
	-16.7	-17	208.1	87.85	208.1	89.25	207.3	86.45	207.3	85.05	207.3	82.55	198.7	78.86
	-13.7	-15	222.4	89.25	222.4	85.07	220.4	82.45	220.4	81.00	214.1	78.60	198.7	75.02
	-11.8	-13	229.7	86.38	228.4	82.44	227.5	79.90	221.2	78.42	214.1	76.11	198.7	72.58
	-9.8	-11	237.2	83.40	237.2	79.68	228.2	77.25	221.2	75.70	214.1	73.48	198.7	70.01
	-9.5	-10	238.6	82.93	238.6	79.24	228.2	76.84	221.2	75.29	214.1	73.08	198.7	69.62
	-8.5	-9.1	243.5	81.44	241.7	77.87	228.2	75.50	221.2	73.95	214.1	71.77	198.7	68.34
	-7.0	-7.6	254.8	79.18	242.3	75.78	228.2	73.51	221.2	71.91	214.1	69.79	198.7	66.41
	-5.0	-5.6	257.5	76.17	242.3	73.01	228.2	70.85	221.2	69.22	214.1	67.17	198.7	63.87
	-3.0	-3.7	257.5	73.17	242.3	70.24	228.2	68.17	221.2	66.50	214.1	64.53	198.7	61.29
	0.0	-0.7	257.5	68.67	242.3	66.06	228.2	64.17	221.2	62.44	214.1	60.59	198.7	57.45
	3.0	2.2	257.5	64.15	242.3	61.90	228.2	60.17	221.2	58.39	214.1	56.66	198.7	53.59
	5.0	4.1	257.5	61.14	242.3	59.12	228.2	57.50	221.2	55.67	214.1	54.02	198.7	51.01
	7.0	6.0	257.5	58.14	242.3	56.36	228.2	54.84	221.2	52.98	214.1	51.40	198.7	48.47
	9.0	7.9	257.5	55.31	242.3	53.61	228.2	52.17	221.2	50.39	214.1	48.89	198.7	46.11
	11.0	9.8	257.5	52.48	242.3	50.88	228.2	49.50	221.2	47.81	214.1	46.39	198.7	43.74
	13.0	11.8	257.5	49.66	242.3	48.13	228.2	46.84	221.2	45.24	214.1	43.90	198.7	41.38
15.0	13.7	257.5	46.83	242.3	45.39	228.2	44.16	221.2	42.65	214.1	41.38	198.7	39.03	
80	-24.8	-25	150.4	73.96	150.4	75.37	149.5	76.35	149.5	76.81	149.5	79.14	147.0	75.76
	-21.8	-22	182.4	75.37	182.4	76.76	182.4	77.73	182.4	79.14	182.4	75.76	177.6	72.50
	-19.8	-20	193.0	76.29	193.0	77.69	193.0	79.14	193.0	76.75	190.7	73.49	177.6	70.33
	-18.8	-19	197.4	76.76	197.4	79.14	197.4	77.92	197.2	75.55	190.9	72.36	177.6	69.26
	-16.7	-17	204.1	79.14	204.1	76.61	204.1	75.38	198.0	73.05	190.9	70.01	177.6	66.99
	-13.7	-15	213.4	75.40	209.2	72.99	204.1	71.75	198.0	69.46	190.9	66.61	177.6	63.73
	-11.8	-13	218.7	73.01	212.3	70.70	204.1	69.44	198.0	67.19	190.9	64.47	177.6	61.66
	-9.8	-11	224.5	70.51	215.3	68.31	204.1	67.02	198.0	64.81	190.9	62.21	177.6	59.50
	-9.5	-10	226.1	70.14	216.5	67.94	204.1	66.65	198.0	64.45	190.9	61.87	177.6	59.18
	-8.5	-9.1	228.4	68.90	217.5	66.74	204.1	65.45	198.0	63.24	190.9	60.75	177.6	58.10
	-7.0	-7.6	230.7	67.02	217.5	64.92	204.1	63.63	198.0	61.46	190.9	59.06	177.6	56.46
	-5.0	-5.6	230.7	64.52	217.5	62.54	204.1	61.20	198.0	59.06	190.9	56.78	177.6	54.30
	-3.0	-3.7	230.7	62.02	217.5	60.12	204.1	58.78	198.0	56.68	190.9	54.54	177.6	52.12
	0.0	-0.7	230.7	58.26	217.5	56.52	204.1	55.15	198.0	53.10	190.9	51.14	177.6	48.88
	3.0	2.2	230.7	54.52	217.5	52.89	204.1	51.50	198.0	49.49	190.9	47.76	177.6	45.63
	5.0	4.1	230.7	52.02	217.5	50.50	204.1	49.08	198.0	47.11	190.9	45.50	177.6	43.46
	7.0	6.0	230.7	49.53	217.5	48.08	204.1	46.67	198.0	44.73	190.9	43.25	177.6	41.29
	9.0	7.9	230.7	46.50	217.5	45.15	204.1	43.81	198.0	42.00	190.9	40.61	177.6	38.78
	11.0	9.8	230.7	43.16	217.5	41.91	204.1	40.68	198.0	38.97	190.9	37.68	177.6	35.98
	13.0	11.8	230.7	40.29	217.5	39.11	204.1	37.97	198.0	36.39	190.9	35.18	177.6	33.59
15.0	13.7	230.7	37.91	217.5	36.81	204.1	35.72	198.0	34.24	190.9	33.12	177.6	31.62	

# 7. Capacity Tables

Heating Capacity (80HP)

Combination (%)	Outdoor air temp.		Indoor air temp. °C DB											
			16		18		20		21		22		24	
	°C DB	°C WB	TC	PI	TC	PI	TC	PI	TC	PI	TC	PI	TC	PI
70	-24.8	-25	150.4	74.33	150.4	74.80	149.5	75.74	149.5	77.14	149.5	73.47	146.9	70.02
	-21.8	-22	174.9	75.74	174.9	76.20	173.8	77.14	167.8	73.47	162.8	70.02	152.0	66.71
	-19.8	-20	191.2	76.68	184.7	77.14	173.8	74.56	167.8	71.02	162.8	67.74	152.0	64.50
	-18.8	-19	195.4	77.14	184.7	75.81	173.8	73.26	167.8	69.78	162.8	66.58	152.0	63.38
	-16.7	-17	195.6	74.36	184.7	72.99	173.8	70.57	167.8	67.21	162.8	64.19	152.0	61.06
	-13.7	-15	195.6	70.42	184.7	69.00	173.8	66.69	167.8	63.55	162.8	60.75	152.0	57.73
	-11.8	-13	195.6	67.89	184.7	66.47	173.8	64.24	167.8	61.20	162.8	58.56	152.0	55.64
	-9.8	-11	195.6	65.27	184.7	63.79	173.8	61.67	167.8	58.75	162.8	56.28	152.0	53.42
	-9.5	-10	195.6	64.86	184.7	63.39	173.8	61.28	167.8	58.39	162.8	55.95	152.0	53.09
	-8.5	-9.1	195.6	63.56	184.7	62.06	173.8	59.99	167.8	57.16	162.8	54.79	152.0	51.98
	-7.0	-7.6	195.6	61.57	184.7	60.07	173.8	58.06	167.8	55.34	162.8	53.07	152.0	50.32
	-5.0	-5.6	195.6	58.94	184.7	57.40	173.8	55.47	167.8	52.88	162.8	50.78	152.0	48.11
	-3.0	-3.7	195.6	56.31	184.7	54.72	173.8	52.89	167.8	50.43	162.8	48.49	152.0	45.89
	0.0	-0.7	195.6	52.35	184.7	50.73	173.8	49.03	167.8	46.76	162.8	45.05	152.0	42.58
	3.0	2.2	195.6	48.39	184.7	46.73	173.8	45.15	167.8	43.10	162.8	41.62	152.0	39.24
	5.0	4.1	195.6	45.76	184.7	44.04	173.8	42.59	167.8	40.65	162.8	39.32	152.0	37.04
	7.0	6.0	195.6	43.12	184.7	41.39	173.8	40.00	167.8	38.20	162.8	37.04	152.0	34.82
	9.0	7.9	195.6	38.94	184.7	37.37	173.8	36.13	167.8	34.49	162.8	33.45	152.0	31.44
	11.0	9.8	195.6	36.27	184.7	34.79	173.8	33.63	167.8	32.11	162.8	31.15	152.0	29.27
	13.0	11.8	195.6	33.92	184.7	32.56	173.8	31.46	167.8	30.05	162.8	29.14	152.0	27.41
15.0	13.7	195.6	31.98	184.7	30.70	173.8	29.67	167.8	28.31	162.8	27.47	152.0	25.83	
60	-24.8	-25	149.2	73.32	149.2	74.26	148.2	75.67	144.0	71.75	139.0	68.08	130.2	64.63
	-21.8	-22	160.3	74.73	158.8	75.67	149.0	71.75	144.0	68.08	139.0	64.63	130.2	61.30
	-19.8	-20	167.8	75.67	158.8	72.90	149.0	69.14	144.0	65.64	139.0	62.32	130.2	59.07
	-18.8	-19	167.8	74.28	158.8	71.52	149.0	67.83	144.0	64.40	139.0	61.17	130.2	57.95
	-16.7	-17	167.8	71.34	158.8	68.60	149.0	65.09	144.0	61.83	139.0	58.77	130.2	55.62
	-13.7	-15	167.8	67.14	158.8	64.47	149.0	61.18	144.0	58.17	139.0	55.31	130.2	52.29
	-11.8	-13	167.8	64.50	158.8	61.83	149.0	58.68	144.0	55.83	139.0	53.13	130.2	50.19
	-9.8	-11	167.8	61.71	158.8	59.06	149.0	56.08	144.0	53.39	139.0	50.83	130.2	47.95
	-9.5	-10	167.8	61.28	158.8	58.66	149.0	55.69	144.0	53.02	139.0	50.47	130.2	47.62
	-8.5	-9.1	167.8	59.89	158.8	57.28	149.0	54.39	144.0	51.81	139.0	49.32	130.2	46.51
	-7.0	-7.6	167.8	57.81	158.8	55.20	149.0	52.44	144.0	49.96	139.0	47.60	130.2	44.84
	-5.0	-5.6	167.8	55.00	158.8	52.43	149.0	49.82	144.0	47.52	139.0	45.30	130.2	42.62
	-3.0	-3.7	167.8	52.22	158.8	49.66	149.0	47.21	144.0	45.08	139.0	42.99	130.2	40.39
	0.0	-0.7	167.8	48.02	158.8	45.51	149.0	43.31	144.0	41.39	139.0	39.54	130.2	37.07
	3.0	2.2	167.8	43.83	158.8	41.36	149.0	39.38	144.0	37.73	139.0	36.10	130.2	33.72
	5.0	4.1	167.8	41.05	158.8	38.59	149.0	36.78	144.0	35.29	139.0	33.80	130.2	31.51
	7.0	6.0	167.8	38.26	158.8	35.82	149.0	34.17	144.0	32.82	139.0	31.50	130.2	29.27
	9.0	7.9	167.8	34.14	158.8	31.98	149.0	30.47	144.0	29.29	139.0	28.09	130.2	26.12
	11.0	9.8	167.8	31.86	158.8	29.85	149.0	28.46	144.0	27.35	139.0	26.25	130.2	24.39
	13.0	11.8	167.8	29.85	158.8	27.95	149.0	26.67	144.0	25.62	139.0	24.57	130.2	22.86
15.0	13.7	167.8	28.21	158.8	26.44	149.0	25.19	144.0	24.21	139.0	23.23	130.2	21.61	
50	-24.8	-25	140.0	64.30	132.0	65.70	124.2	62.23	120.2	58.98	116.1	55.91	108.1	53.06
	-21.8	-22	140.0	65.70	132.0	62.23	124.2	58.98	120.2	55.91	116.1	53.06	108.1	50.31
	-19.8	-20	140.0	63.28	132.0	59.91	124.2	56.82	120.2	53.85	116.1	51.14	108.1	48.46
	-18.8	-19	140.0	62.06	132.0	58.74	124.2	55.74	120.2	52.85	116.1	50.19	108.1	47.55
	-16.7	-17	140.0	59.53	132.0	56.33	124.2	53.48	120.2	50.69	116.1	48.19	108.1	45.63
	-13.7	-15	140.0	55.91	132.0	52.84	124.2	50.22	120.2	47.62	116.1	45.34	108.1	42.88
	-11.8	-13	140.0	53.61	132.0	50.65	124.2	48.17	120.2	45.67	116.1	43.53	108.1	41.14
	-9.8	-11	140.0	51.19	132.0	48.33	124.2	45.99	120.2	43.62	116.1	41.61	108.1	39.29
	-9.5	-10	140.0	50.82	132.0	48.00	124.2	45.68	120.2	43.32	116.1	41.35	108.1	39.02
	-8.5	-9.1	140.0	49.60	132.0	46.83	124.2	44.60	120.2	42.30	116.1	40.39	108.1	38.10
	-7.0	-7.6	140.0	47.79	132.0	45.11	124.2	42.97	120.2	40.77	116.1	38.96	108.1	36.74
	-5.0	-5.6	140.0	45.37	132.0	42.79	124.2	40.82	120.2	38.72	116.1	37.05	108.1	34.90
	-3.0	-3.7	140.0	42.95	132.0	40.47	124.2	38.63	120.2	36.67	116.1	35.13	108.1	33.07
	0.0	-0.7	140.0	39.33	132.0	36.98	124.2	35.39	120.2	33.60	116.1	32.28	108.1	30.31
	3.0	2.2	140.0	35.70	132.0	33.53	124.2	32.16	120.2	30.52	116.1	29.43	108.1	27.56
	5.0	4.1	140.0	33.28	132.0	31.21	124.2	29.99	120.2	28.49	116.1	27.52	108.1	25.74
	7.0	6.0	140.0	30.86	132.0	28.89	124.2	27.83	120.2	26.44	116.1	25.60	108.1	23.90
	9.0	7.9	140.0	27.86	132.0	26.09	124.2	25.13	120.2	23.87	116.1	23.13	108.1	21.58
	11.0	9.8	140.0	26.07	132.0	24.41	124.2	23.51	120.2	22.35	116.1	21.64	108.1	20.19
	13.0	11.8	140.0	24.48	132.0	22.93	124.2	22.07	120.2	20.97	116.1	20.32	108.1	18.97
15.0	13.7	140.0	23.16	132.0	21.68	124.2	20.90	120.2	19.84	116.1	19.23	108.1	17.94	

**Note**

1. TC: Total Capacity(kW), PI : Power Input(kW, Comp. + Outdoor fan motor)
2. Capacity tables show the average value of conditions which may occur.
3. The heating capacity table is based on the values expressed as Max. in the specification of the outdoor unit. (When measuring the Max. heating capacity, the setting status of the indoor unit is the same as that for measuring the heating capacity of the indoor unit.)

# 7. Capacity Tables

## ◆ ARUM820LTE5

Heating Capacity (82HP)

Combination (%)	Outdoor air temp.		Indoor air temp. °C DB											
			16		18		20		21		22		24	
	°C DB	°C WB	TC	PI	TC	PI	TC	PI	TC	PI	TC	PI	TC	PI
130	-24.8	-25	158.1	87.1	158.1	87.76	157.2	88.38	157.2	89.31	157.2	90.23	154.6	91.66
	-21.8	-22	193.2	88.46	193.2	89.17	191.9	89.79	191.9	90.74	191.9	91.66	188.6	93.06
	-19.8	-20	204.1	89.41	204.1	90.13	202.7	90.74	202.7	91.69	202.7	92.59	199.4	94.02
	-18.8	-19	208.8	89.89	208.8	90.60	207.4	91.22	207.4	92.17	207.4	93.06	203.9	94.49
	-16.7	-17	218.4	90.88	218.4	91.59	217.0	92.21	217.0	93.16	217.0	94.07	213.3	95.48
	-13.7	-15	232.1	92.31	232.1	93.02	230.7	93.64	230.7	94.59	230.7	95.48	226.7	91.88
	-11.8	-13	239.7	93.23	239.7	93.92	238.3	94.54	238.3	95.48	238.3	96.42	235.3	89.59
	-9.8	-11	247.7	94.15	247.7	94.87	246.1	95.48	246.1	96.42	246.1	97.31	243.9	87.19
	-9.5	-10	249.1	94.32	249.1	95.01	247.6	95.09	247.6	95.92	247.6	96.75	245.3	86.81
	-8.5	-9.1	254.1	94.77	254.1	95.48	252.6	93.77	252.6	91.21	251.4	88.85	249.6	85.61
	-7.0	-7.6	261.6	95.48	261.6	93.56	259.9	91.79	259.9	89.28	259.9	86.92	256.7	83.81
	-5.0	-5.6	271.6	92.99	271.6	90.97	269.8	89.14	269.8	86.68	269.8	84.36	265.6	81.40
	-3.0	-3.7	281.6	90.50	281.6	88.39	279.8	86.49	279.8	84.08	279.8	81.81	274.5	78.98
	0.0	-0.7	296.5	86.73	296.5	84.52	294.6	82.53	294.6	80.20	294.6	77.97	287.8	75.38
	3.0	2.2	311.5	82.99	311.5	80.62	309.5	78.55	309.5	76.32	308.0	74.12	288.7	71.78
	5.0	4.1	320.8	80.47	320.8	78.04	319.1	75.91	319.1	73.72	310.0	71.57	288.7	69.35
	7.0	6.0	329.0	77.97	329.0	75.45	327.0	73.27	321.4	71.14	310.0	69.01	288.7	66.95
9.0	7.9	330.5	75.91	330.5	73.45	329.4	71.32	321.4	69.25	310.0	67.20	288.7	65.18	
11.0	9.8	330.5	74.50	330.5	72.11	329.4	70.02	321.4	67.97	310.0	65.95	288.7	63.97	
13.0	11.8	330.5	73.01	330.5	70.64	329.4	68.59	321.4	66.60	310.0	64.62	288.7	62.68	
15.0	13.7	330.5	71.38	330.5	69.08	329.4	67.07	321.4	65.11	310.0	63.18	288.7	61.28	
120	-24.8	-25	157.1	87.76	157.1	88.38	156.1	89.31	156.1	90.23	156.1	91.66	153.5	92.65
	-21.8	-22	191.8	89.17	191.8	89.79	190.5	90.74	190.5	91.66	190.5	93.06	187.4	94.07
	-19.8	-20	202.7	90.13	202.7	90.74	201.3	91.69	201.3	92.59	201.3	94.02	198.0	95.01
	-18.8	-19	207.2	90.60	207.2	91.22	205.8	92.17	205.8	93.06	205.8	94.49	202.5	95.48
	-16.7	-17	216.8	91.59	216.8	92.21	215.4	93.16	215.4	94.07	215.4	95.48	211.7	93.17
	-13.7	-15	230.4	93.02	230.4	93.64	229.0	94.59	229.0	95.48	229.0	96.42	225.1	89.85
	-11.8	-13	237.9	93.92	237.9	94.54	236.5	95.48	236.5	96.42	236.5	97.31	233.5	87.75
	-9.8	-11	245.9	94.87	245.9	95.48	244.5	92.79	244.5	90.46	244.5	87.53	242.3	85.53
	-9.5	-10	247.4	95.01	247.4	95.06	246.0	92.40	246.0	90.07	246.0	87.18	243.7	85.19
	-8.5	-9.1	252.4	95.48	252.4	93.63	250.6	91.04	250.6	88.79	250.6	86.04	248.1	84.09
	-7.0	-7.6	259.8	93.37	259.8	91.50	258.2	89.02	258.2	86.85	258.0	84.30	254.9	82.43
	-5.0	-5.6	269.8	90.53	269.8	88.64	268.0	86.32	268.0	84.26	268.0	81.98	263.8	80.21
	-3.0	-3.7	279.6	87.70	279.6	85.81	277.8	83.62	277.8	81.70	277.8	79.68	271.2	77.99
	0.0	-0.7	294.4	83.45	294.4	81.53	292.4	79.57	292.4	77.82	291.2	76.21	271.2	74.67
	3.0	2.2	309.2	79.21	309.2	77.25	306.5	75.52	301.1	73.95	291.8	72.75	271.2	71.36
	5.0	4.1	318.6	76.38	318.1	74.40	311.6	72.84	301.1	71.37	291.8	70.45	271.2	69.14
	7.0	6.0	326.8	73.54	324.5	71.55	311.6	70.14	301.1	68.78	291.8	68.15	271.2	66.92
9.0	7.9	327.9	71.40	324.5	69.47	311.6	68.12	301.1	66.82	291.8	66.19	271.2	64.99	
11.0	9.8	327.9	69.92	324.5	68.02	311.6	66.67	301.1	65.41	291.8	64.78	271.2	63.63	
13.0	11.8	327.9	68.30	324.5	66.44	311.6	65.15	301.1	63.90	291.8	63.30	271.2	62.17	
15.0	13.7	327.9	66.58	324.5	64.77	311.6	63.50	301.1	62.28	291.8	61.69	271.2	60.59	
110	-24.8	-25	156.3	88.38	156.3	89.31	155.3	90.23	155.3	91.66	155.3	92.65	152.6	93.13
	-21.8	-22	190.8	89.79	190.8	90.74	189.5	91.66	189.5	93.06	189.5	94.07	186.4	94.54
	-19.8	-20	201.6	90.74	201.6	91.69	200.4	92.59	200.4	94.02	200.4	95.01	196.9	95.48
	-18.8	-19	206.1	91.22	206.1	92.17	204.7	93.06	204.7	94.49	204.7	95.48	201.4	94.26
	-16.7	-17	215.7	92.21	215.7	93.16	214.3	94.07	214.3	95.48	214.3	96.92	210.6	91.67
	-13.7	-15	229.1	93.64	229.1	94.59	227.7	95.48	227.7	96.42	227.7	97.31	223.7	87.99
	-11.8	-13	236.7	94.54	236.7	95.48	235.2	92.80	235.2	89.27	235.2	87.09	235.2	85.66
	-9.8	-11	244.5	95.48	244.5	92.46	243.1	89.99	243.1	86.73	243.1	84.70	242.0	83.20
	-9.5	-10	246.0	94.99	246.0	91.99	244.6	89.54	244.6	86.34	244.6	84.35	243.7	82.84
	-8.5	-9.1	251.0	93.37	251.0	90.48	249.5	88.13	249.5	85.07	249.5	83.13	244.0	81.60
	-7.0	-7.6	258.4	90.90	258.4	88.21	256.8	86.01	256.8	83.17	256.8	81.34	244.0	79.77
	-5.0	-5.6	268.2	87.63	268.2	85.15	266.4	83.19	266.4	80.64	261.2	78.94	244.0	77.29
	-3.0	-3.7	278.1	84.35	278.1	82.13	276.2	80.34	270.5	78.08	261.2	76.53	244.0	74.84
	0.0	-0.7	292.8	79.43	292.4	77.57	279.5	76.10	270.5	74.27	261.2	72.95	244.0	71.16
	3.0	2.2	307.1	74.52	297.9	73.01	279.5	71.85	270.5	70.48	261.2	69.33	244.0	67.46
	5.0	4.1	315.2	71.24	297.9	69.98	279.5	69.03	270.5	67.92	261.2	66.94	244.0	65.01
	7.0	6.0	315.2	67.95	297.9	66.95	279.5	66.19	270.5	65.38	261.2	64.55	244.0	62.55
9.0	7.9	315.2	65.70	297.9	64.72	279.5	64.00	270.5	63.21	261.2	62.40	244.0	60.48	
11.0	9.8	315.2	64.02	297.9	63.06	279.5	62.34	270.5	61.58	261.2	60.78	244.0	58.92	
13.0	11.8	315.2	62.19	297.9	61.27	279.5	60.57	270.5	59.84	261.2	59.08	244.0	57.27	
15.0	13.7	315.2	60.28	297.9	59.37	279.5	58.70	270.5	57.98	261.2	57.25	244.0	55.47	

# 7. Capacity Tables

Heating Capacity (82HP)

Combination (%)	Outdoor air temp.		Indoor air temp. °C DB											
			16		18		20		21		22		24	
	°C DB	°C WB	TC	PI	TC	PI	TC	PI	TC	PI	TC	PI	TC	PI
100	-24.8	-25	155.6	97.92	155.6	97.60	154.6	91.16	154.6	96.81	154.6	96.47	151.9	96.31
	-21.8	-22	189.8	97.44	189.8	97.12	188.8	94.04	188.8	96.32	188.8	97.31	185.4	95.82
	-19.8	-20	200.7	97.12	200.7	96.78	199.5	95.84	199.5	96.00	199.5	96.10	196.2	95.48
	-18.8	-19	205.1	96.96	204.0	96.63	204.0	96.32	204.0	95.82	204.0	95.48	200.4	93.99
	-16.7	-17	213.4	96.62	213.4	96.29	213.4	97.31	212.2	95.48	212.2	92.39	208.5	90.83
	-13.7	-15	228.0	96.13	228.0	95.79	226.7	95.48	226.7	90.99	226.7	87.95	223.0	86.30
	-11.8	-13	235.5	95.82	234.2	95.48	234.2	92.48	234.2	88.13	234.2	85.13	223.0	83.45
	-9.8	-11	243.2	95.48	243.2	92.11	242.1	89.30	242.1	85.13	239.3	82.18	223.0	80.43
	-9.5	-10	244.6	94.96	244.6	91.60	243.5	88.82	243.5	84.68	239.3	81.72	223.0	79.98
	-8.5	-9.1	249.6	93.19	249.6	89.92	248.5	87.23	247.5	83.18	239.3	80.25	223.0	78.47
	-7.0	-7.6	261.2	90.55	260.2	87.38	255.7	84.84	247.5	80.94	239.3	78.03	223.0	76.21
	-5.0	-5.6	272.6	87.00	269.9	84.01	255.7	81.68	247.5	77.92	239.3	75.08	223.0	73.19
	-3.0	-3.7	280.5	83.48	272.1	80.62	255.7	78.51	247.5	74.91	239.3	72.13	223.0	70.18
	0.0	-0.7	288.4	78.17	272.1	75.56	255.7	73.74	247.5	70.42	239.3	67.68	223.0	65.67
	3.0	2.2	288.4	72.86	272.1	70.49	255.7	68.98	247.5	65.92	239.3	63.24	223.0	61.15
	5.0	4.1	288.4	69.34	272.1	67.12	255.7	65.80	247.5	62.91	239.3	60.28	223.0	58.14
	7.0	6.0	288.4	65.79	272.1	63.73	255.7	62.62	247.5	59.91	239.3	57.32	223.0	55.12
	9.0	7.9	288.4	63.28	272.1	61.29	255.7	60.22	247.5	57.63	239.3	55.14	223.0	53.02
	11.0	9.8	288.4	61.30	272.1	59.38	255.7	58.35	247.5	55.81	239.3	53.40	223.0	51.37
	13.0	11.8	288.4	59.21	272.1	57.33	255.7	56.34	247.5	53.90	239.3	51.57	223.0	49.59
15.0	13.7	288.4	56.98	272.1	55.18	255.7	54.22	247.5	51.87	239.3	49.64	223.0	47.73	
90	-24.8	-25	154.9	87.00	154.9	88.41	154.0	89.42	154.0	89.88	154.0	90.83	151.5	92.27
	-21.8	-22	189.1	88.41	189.1	89.84	188.1	90.83	188.1	91.31	188.1	92.27	184.7	88.29
	-19.8	-20	199.9	89.37	199.9	90.79	198.6	91.78	198.6	92.27	198.6	89.54	195.3	85.64
	-18.8	-19	205.1	89.84	204.0	91.27	203.1	92.27	203.1	90.87	203.1	88.18	199.7	84.32
	-16.7	-17	213.4	90.83	213.4	92.27	212.5	89.37	212.5	87.93	212.5	85.34	203.7	81.53
	-13.7	-15	228.0	92.27	228.0	87.95	225.9	85.24	225.9	83.74	219.5	81.26	203.7	77.56
	-11.8	-13	235.5	89.30	234.2	85.23	233.3	82.61	226.7	81.07	219.5	78.69	203.7	75.04
	-9.8	-11	243.2	86.22	243.2	82.38	234.0	79.86	226.7	78.27	219.5	75.97	203.7	72.39
	-9.5	-10	244.6	85.74	244.6	81.93	234.0	79.45	226.7	77.85	219.5	75.55	203.7	71.98
	-8.5	-9.1	249.6	84.19	247.9	80.50	234.0	78.06	226.7	76.45	219.5	74.20	203.7	70.66
	-7.0	-7.6	261.2	81.86	248.5	78.35	234.0	76.00	226.7	74.35	219.5	72.16	203.7	68.67
	-5.0	-5.6	264.0	78.76	248.5	75.48	234.0	73.25	226.7	71.57	219.5	69.45	203.7	66.04
	-3.0	-3.7	264.0	75.65	248.5	72.63	234.0	70.49	226.7	68.76	219.5	66.72	203.7	63.37
	0.0	-0.7	264.0	71.01	248.5	68.31	234.0	66.35	226.7	64.57	219.5	62.65	203.7	59.41
	3.0	2.2	264.0	66.33	248.5	64.01	234.0	62.22	226.7	60.38	219.5	58.59	203.7	55.42
	5.0	4.1	264.0	63.23	248.5	61.14	234.0	59.46	226.7	57.57	219.5	55.86	203.7	52.76
	7.0	6.0	264.0	60.12	248.5	58.29	234.0	56.72	226.7	54.79	219.5	53.16	203.7	50.12
	9.0	7.9	264.0	57.20	248.5	55.44	234.0	53.95	226.7	52.12	219.5	50.56	203.7	47.69
	11.0	9.8	264.0	54.28	248.5	52.63	234.0	51.20	226.7	49.45	219.5	47.98	203.7	45.24
	13.0	11.8	264.0	51.37	248.5	49.78	234.0	48.45	226.7	46.80	219.5	45.41	203.7	42.81
15.0	13.7	264.0	48.45	248.5	46.95	234.0	45.68	226.7	44.12	219.5	42.81	203.7	40.37	
80	-24.8	-25	154.3	76.54	154.3	77.98	153.3	78.97	153.3	79.44	153.3	81.81	150.8	78.32
	-21.8	-22	187.1	77.98	187.1	79.39	187.1	80.38	187.1	81.81	187.1	78.32	182.0	74.95
	-19.8	-20	197.9	78.91	197.9	80.33	197.9	81.81	197.9	79.35	195.5	75.98	182.0	72.71
	-18.8	-19	202.3	79.39	202.3	81.81	202.3	80.55	202.2	78.10	195.7	74.80	182.0	71.60
	-16.7	-17	209.2	81.81	209.2	79.20	209.2	77.93	203.0	75.52	195.7	72.37	182.0	69.26
	-13.7	-15	218.8	77.94	214.4	75.46	209.2	74.18	203.0	71.81	195.7	68.86	182.0	65.89
	-11.8	-13	224.2	75.48	217.6	73.10	209.2	71.79	203.0	69.46	195.7	66.65	182.0	63.75
	-9.8	-11	230.2	72.90	220.8	70.62	209.2	69.29	203.0	67.01	195.7	64.31	182.0	61.52
	-9.5	-10	231.8	72.52	222.0	70.24	209.2	68.91	203.0	66.63	195.7	63.96	182.0	61.19
	-8.5	-9.1	234.2	71.23	223.0	69.00	209.2	67.67	203.0	65.39	195.7	62.81	182.0	60.07
	-7.0	-7.6	236.5	69.29	223.0	67.12	209.2	65.79	203.0	63.55	195.7	61.06	182.0	58.38
	-5.0	-5.6	236.5	66.71	223.0	64.66	209.2	63.28	203.0	61.06	195.7	58.71	182.0	56.14
	-3.0	-3.7	236.5	64.13	223.0	62.16	209.2	60.77	203.0	58.61	195.7	56.40	182.0	53.90
	0.0	-0.7	236.5	60.24	223.0	58.44	209.2	57.03	203.0	54.90	195.7	52.88	182.0	50.55
	3.0	2.2	236.5	56.38	223.0	54.69	209.2	53.26	203.0	51.18	195.7	49.39	182.0	47.18
	5.0	4.1	236.5	53.80	223.0	52.23	209.2	50.76	203.0	48.72	195.7	47.05	182.0	44.95
	7.0	6.0	236.5	51.23	223.0	49.73	209.2	48.27	203.0	46.26	195.7	44.73	182.0	42.70
	9.0	7.9	236.5	48.09	223.0	46.70	209.2	45.31	203.0	43.43	195.7	42.00	182.0	40.10
	11.0	9.8	236.5	44.63	223.0	43.34	209.2	42.07	203.0	40.31	195.7	38.97	182.0	37.21
	13.0	11.8	236.5	41.67	223.0	40.45	209.2	39.27	203.0	37.63	195.7	36.38	182.0	34.74
15.0	13.7	236.5	39.21	223.0	38.07	209.2	36.94	203.0	35.41	195.7	34.25	182.0	32.70	

## 7. Capacity Tables

Heating Capacity (82HP)

Combination (%)	Outdoor air temp.		Indoor air temp. °C DB											
			16		18		20		21		22		24	
	°C DB	°C WB	TC	PI	TC	PI	TC	PI	TC	PI	TC	PI	TC	PI
70	-24.8	-25	154.3	76.89	154.3	77.36	153.3	78.32	153.3	79.75	153.3	75.96	150.7	72.39
	-21.8	-22	179.3	78.32	179.3	78.80	178.2	79.75	172.0	75.96	167.0	72.39	155.8	68.97
	-19.8	-20	195.9	79.28	189.3	79.75	178.2	77.08	172.0	73.42	167.0	70.03	155.8	66.69
	-18.8	-19	200.4	79.75	189.3	78.37	178.2	75.74	172.0	72.15	167.0	68.84	155.8	65.53
	-16.7	-17	200.6	76.87	189.3	75.46	178.2	72.96	172.0	69.49	167.0	66.37	155.8	63.13
	-13.7	-15	200.6	72.80	189.3	71.34	178.2	68.95	172.0	65.70	167.0	62.81	155.8	59.69
	-11.8	-13	200.6	70.19	189.3	68.72	178.2	66.42	172.0	63.28	167.0	60.55	155.8	57.53
	-9.8	-11	200.6	67.48	189.3	65.96	178.2	63.77	172.0	60.75	167.0	58.19	155.8	55.24
	-9.5	-10	200.6	67.06	189.3	65.54	178.2	63.36	172.0	60.38	167.0	57.85	155.8	54.90
	-8.5	-9.1	200.6	65.72	189.3	64.17	178.2	62.02	172.0	59.10	167.0	56.65	155.8	53.75
	-7.0	-7.6	200.6	63.66	189.3	62.11	178.2	60.03	172.0	57.22	167.0	54.88	155.8	52.03
	-5.0	-5.6	200.6	60.94	189.3	59.35	178.2	57.36	172.0	54.68	167.0	52.51	155.8	49.74
	-3.0	-3.7	200.6	58.22	189.3	56.58	178.2	54.69	172.0	52.15	167.0	50.14	155.8	47.45
	0.0	-0.7	200.6	54.13	189.3	52.46	178.2	50.70	172.0	48.35	167.0	46.59	155.8	44.03
	3.0	2.2	200.6	50.04	189.3	48.32	178.2	46.69	172.0	44.57	167.0	43.04	155.8	40.58
	5.0	4.1	200.6	47.32	189.3	45.55	178.2	44.04	172.0	42.04	167.0	40.66	155.8	38.30
	7.0	6.0	200.6	44.60	189.3	42.81	178.2	41.37	172.0	39.50	167.0	38.30	155.8	36.01
	9.0	7.9	200.6	40.27	189.3	38.65	178.2	37.37	172.0	35.67	167.0	34.60	155.8	32.51
	11.0	9.8	200.6	37.51	189.3	35.98	178.2	34.78	172.0	33.21	167.0	32.21	155.8	30.27
	13.0	11.8	200.6	35.08	189.3	33.67	178.2	32.54	172.0	31.08	167.0	30.13	155.8	28.34
15.0	13.7	200.6	33.07	189.3	31.75	178.2	30.68	172.0	29.28	167.0	28.41	155.8	26.71	
60	-24.8	-25	152.9	75.86	152.9	76.82	152.0	78.25	147.6	74.20	142.5	70.41	133.4	66.83
	-21.8	-22	164.3	77.29	162.8	78.25	152.8	74.20	147.6	70.41	142.5	66.83	133.4	63.39
	-19.8	-20	172.0	78.25	162.8	75.39	152.8	71.50	147.6	67.88	142.5	64.45	133.4	61.09
	-18.8	-19	172.0	76.82	162.8	73.96	152.8	70.14	147.6	66.59	142.5	63.26	133.4	59.93
	-16.7	-17	172.0	73.78	162.8	70.94	152.8	67.31	147.6	63.94	142.5	60.77	133.4	57.52
	-13.7	-15	172.0	69.43	162.8	66.67	152.8	63.27	147.6	60.15	142.5	57.20	133.4	54.08
	-11.8	-13	172.0	66.70	162.8	63.94	152.8	60.69	147.6	57.74	142.5	54.95	133.4	51.90
	-9.8	-11	172.0	63.82	162.8	61.08	152.8	58.00	147.6	55.21	142.5	52.56	133.4	49.59
	-9.5	-10	172.0	63.37	162.8	60.67	152.8	57.59	147.6	54.83	142.5	52.20	133.4	49.25
	-8.5	-9.1	172.0	61.94	162.8	59.23	152.8	56.25	147.6	53.57	142.5	51.00	133.4	48.10
	-7.0	-7.6	172.0	59.78	162.8	57.08	152.8	54.23	147.6	51.67	142.5	49.22	133.4	46.37
	-5.0	-5.6	172.0	56.88	162.8	54.22	152.8	51.52	147.6	49.14	142.5	46.85	133.4	44.08
	-3.0	-3.7	172.0	54.00	162.8	51.35	152.8	48.82	147.6	46.62	142.5	44.46	133.4	41.77
	0.0	-0.7	172.0	49.66	162.8	47.07	152.8	44.79	147.6	42.80	142.5	40.89	133.4	38.33
	3.0	2.2	172.0	45.33	162.8	42.77	152.8	40.73	147.6	39.02	142.5	37.34	133.4	34.87
	5.0	4.1	172.0	42.45	162.8	39.91	152.8	38.04	147.6	36.49	142.5	34.95	133.4	32.59
	7.0	6.0	172.0	39.57	162.8	37.05	152.8	35.33	147.6	33.95	142.5	32.58	133.4	30.28
	9.0	7.9	172.0	35.31	162.8	33.07	152.8	31.52	147.6	30.29	142.5	29.05	133.4	27.01
	11.0	9.8	172.0	32.95	162.8	30.87	152.8	29.44	147.6	28.28	142.5	27.14	133.4	25.22
	13.0	11.8	172.0	30.87	162.8	28.91	152.8	27.58	147.6	26.49	142.5	25.41	133.4	23.65
15.0	13.7	172.0	29.18	162.8	27.34	152.8	26.05	147.6	25.04	142.5	24.02	133.4	22.35	
50	-24.8	-25	143.5	66.49	135.3	67.92	127.3	64.33	123.2	60.97	119.1	57.80	110.9	54.85
	-21.8	-22	143.5	67.92	135.3	64.33	127.3	60.97	123.2	57.80	119.1	54.85	110.9	52.01
	-19.8	-20	143.5	65.42	135.3	61.93	127.3	58.74	123.2	55.67	119.1	52.87	110.9	50.11
	-18.8	-19	143.5	64.16	135.3	60.73	127.3	57.62	123.2	54.63	119.1	51.89	110.9	49.16
	-16.7	-17	143.5	61.54	135.3	58.23	127.3	55.29	123.2	52.41	119.1	49.82	110.9	47.17
	-13.7	-15	143.5	57.80	135.3	54.63	127.3	51.92	123.2	49.24	119.1	46.88	110.9	44.33
	-11.8	-13	143.5	55.43	135.3	52.36	127.3	49.80	123.2	47.22	119.1	45.00	110.9	42.53
	-9.8	-11	143.5	52.92	135.3	49.97	127.3	47.55	123.2	45.10	119.1	43.03	110.9	40.62
	-9.5	-10	143.5	52.54	135.3	49.62	127.3	47.23	123.2	44.79	119.1	42.75	110.9	40.35
	-8.5	-9.1	143.5	51.28	135.3	48.42	127.3	46.11	123.2	43.73	119.1	41.76	110.9	39.40
	-7.0	-7.6	143.5	49.42	135.3	46.64	127.3	44.43	123.2	42.16	119.1	40.28	110.9	37.98
	-5.0	-5.6	143.5	46.91	135.3	44.24	127.3	42.20	123.2	40.03	119.1	38.31	110.9	36.09
	-3.0	-3.7	143.5	44.41	135.3	41.84	127.3	39.95	123.2	37.92	119.1	36.33	110.9	34.20
	0.0	-0.7	143.5	40.66	135.3	38.24	127.3	36.60	123.2	34.74	119.1	33.38	110.9	31.34
	3.0	2.2	143.5	36.92	135.3	34.67	127.3	33.26	123.2	31.56	119.1	30.44	110.9	28.50
	5.0	4.1	143.5	34.42	135.3	32.27	127.3	31.01	123.2	29.46	119.1	28.46	110.9	26.62
	7.0	6.0	143.5	31.91	135.3	29.88	127.3	28.78	123.2	27.35	119.1	26.48	110.9	24.71
	9.0	7.9	143.5	28.81	135.3	26.98	127.3	25.99	123.2	24.69	119.1	23.92	110.9	22.31
	11.0	9.8	143.5	26.96	135.3	25.25	127.3	24.32	123.2	23.11	119.1	22.38	110.9	20.88
	13.0	11.8	143.5	25.32	135.3	23.71	127.3	22.82	123.2	21.69	119.1	21.02	110.9	19.62
15.0	13.7	143.5	23.95	135.3	22.42	127.3	21.61	123.2	20.52	119.1	19.88	110.9	18.56	

## Note

1. TC: Total Capacity(kW), PI: Power Input(kW, Comp. + Outdoor fan motor)
2. Capacity tables show the average value of conditions which may occur.
3. The heating capacity table is based on the values expressed as Max. in the specification of the outdoor unit. (When measuring the Max. heating capacity, the setting status of the indoor unit is the same as that for measuring the heating capacity of the indoor unit.)

# 7. Capacity Tables

## ◆ ARUM840LTE5

Heating Capacity (84HP)

Combination (%)	Outdoor air temp.		Indoor air temp. °C DB											
			16		18		20		21		22		24	
	°C DB	°C WB	TC	PI	TC	PI	TC	PI	TC	PI	TC	PI	TC	PI
130	-24.8	-25	160.1	88.6	160.1	89.43	159.1	90.16	159.1	91.25	159.1	92.34	156.6	94.03
	-21.8	-22	196.4	90.25	196.4	91.09	195.0	91.82	195.0	92.94	195.0	94.03	191.6	95.68
	-19.8	-20	207.8	91.37	207.8	92.22	206.4	92.94	206.4	94.07	206.4	95.12	203.0	96.81
	-18.8	-19	212.7	91.94	212.7	92.78	211.3	93.51	211.3	94.63	211.3	95.68	207.6	97.37
	-16.7	-17	222.6	93.11	222.6	93.95	221.2	94.68	221.2	95.80	221.2	96.88	217.4	98.54
	-13.7	-15	236.7	94.80	236.7	95.64	235.3	96.37	235.3	97.49	235.3	98.54	231.2	94.83
	-11.8	-13	244.4	95.88	244.4	96.69	243.0	97.42	243.0	98.54	243.0	99.66	240.0	92.47
	-9.8	-11	252.5	96.97	252.5	97.82	251.0	98.54	251.0	99.66	251.0	100.78	248.9	90.00
	-9.5	-10	253.9	97.17	253.9	97.98	252.5	98.14	252.5	99.26	252.5	100.38	250.3	89.60
	-8.5	-9.1	259.0	97.70	259.0	98.54	257.6	96.77	257.6	94.14	256.3	91.71	254.8	88.36
	-7.0	-7.6	266.7	98.54	266.7	96.56	264.9	94.74	264.9	92.15	264.9	89.71	262.0	86.51
	-5.0	-5.6	276.9	95.98	276.9	93.89	275.1	92.00	275.1	89.47	275.1	87.08	271.1	84.03
	-3.0	-3.7	287.1	93.41	287.1	91.24	285.3	89.27	285.3	86.79	285.3	84.45	280.3	81.53
	0.0	-0.7	302.3	89.53	302.3	87.25	300.3	85.20	300.3	82.79	300.3	80.50	294.1	77.82
	3.0	2.2	317.6	85.68	317.6	83.23	315.5	81.10	315.5	78.79	314.0	76.52	294.4	74.11
	5.0	4.1	327.0	83.08	327.0	80.58	325.3	78.37	324.1	76.11	316.1	73.89	294.4	71.60
	7.0	6.0	335.4	80.51	335.4	77.90	333.4	75.66	327.7	73.46	316.1	71.26	294.4	69.13
9.0	7.9	336.9	78.39	336.9	75.85	335.8	73.65	327.7	71.52	316.1	69.40	294.4	67.31	
11.0	9.8	336.9	76.94	336.9	74.47	335.8	72.32	327.7	70.20	316.1	68.11	294.4	66.06	
13.0	11.8	336.9	75.41	336.9	72.96	335.8	70.84	327.7	68.79	316.1	66.75	294.4	64.74	
15.0	13.7	336.9	73.74	336.9	71.36	335.8	69.28	327.7	67.25	316.1	65.27	294.4	63.30	
120	-24.8	-25	159.1	89.43	159.1	90.16	158.0	91.25	158.0	92.34	158.0	94.03	155.5	95.20
	-21.8	-22	195.0	91.09	195.0	91.82	193.6	92.94	193.6	94.03	193.6	95.68	190.5	96.88
	-19.8	-20	206.4	92.22	206.4	92.94	205.0	94.07	205.0	95.12	205.0	96.81	201.6	97.98
	-18.8	-19	211.0	92.78	211.0	93.51	209.6	94.63	209.6	95.68	209.6	97.37	206.2	98.54
	-16.7	-17	220.9	93.95	220.9	94.68	219.5	95.80	219.5	96.88	219.5	98.54	215.7	96.15
	-13.7	-15	234.9	95.64	234.9	96.37	233.5	97.49	233.5	98.54	233.5	99.66	229.5	92.73
	-11.8	-13	242.6	96.69	242.6	97.42	241.2	98.54	241.2	99.66	241.2	100.78	238.2	90.58
	-9.8	-11	250.7	97.82	250.7	98.54	249.3	95.76	249.3	93.36	249.3	90.34	247.2	88.29
	-9.5	-10	252.2	97.98	252.2	98.10	250.8	95.36	250.8	92.96	250.8	89.98	248.7	87.93
	-8.5	-9.1	257.3	98.54	257.3	96.63	255.5	93.96	255.5	91.64	255.5	88.81	253.1	86.80
	-7.0	-7.6	264.9	96.36	264.9	94.43	263.2	91.88	263.2	89.64	263.0	87.02	260.2	85.09
	-5.0	-5.6	275.1	93.44	275.1	91.49	273.3	89.10	273.3	86.97	273.3	84.62	269.4	82.80
	-3.0	-3.7	285.0	90.52	285.0	88.58	283.2	86.31	283.2	84.34	283.2	82.25	276.5	80.51
	0.0	-0.7	300.2	86.15	300.2	84.17	298.1	82.14	298.1	80.33	296.9	78.68	276.5	77.09
	3.0	2.2	315.2	81.78	315.2	79.76	312.5	77.97	307.0	76.35	297.5	75.11	276.5	73.68
	5.0	4.1	324.8	78.86	324.3	76.82	317.6	75.21	307.0	73.69	297.5	72.74	276.5	71.39
	7.0	6.0	333.2	75.94	330.9	73.88	317.6	72.43	307.0	71.02	297.5	70.37	276.5	69.10
9.0	7.9	334.4	73.73	330.9	71.74	317.6	70.34	307.0	69.00	297.5	68.35	276.5	67.11	
11.0	9.8	334.4	72.21	330.9	70.25	317.6	68.85	307.0	67.55	297.5	66.90	276.5	65.71	
13.0	11.8	334.4	70.54	330.9	68.62	317.6	67.29	307.0	66.00	297.5	65.38	276.5	64.22	
15.0	13.7	334.4	68.78	330.9	66.91	317.6	65.59	307.0	64.33	297.5	63.72	276.5	62.59	
110	-24.8	-25	158.3	90.16	158.3	91.25	157.3	92.34	157.3	94.03	157.3	95.20	154.5	95.76
	-21.8	-22	194.0	91.82	194.0	92.94	192.6	94.03	192.6	95.68	192.6	96.88	189.5	97.42
	-19.8	-20	205.3	92.94	205.3	94.07	204.0	95.12	204.0	96.81	204.0	97.98	200.5	98.54
	-18.8	-19	209.9	93.51	209.9	94.63	208.5	95.68	208.5	97.37	208.5	98.54	205.1	97.28
	-16.7	-17	219.8	94.68	219.8	95.80	218.4	96.88	218.4	98.54	218.4	99.66	214.6	94.61
	-13.7	-15	233.6	96.37	233.6	97.49	232.1	98.54	232.1	94.63	232.1	92.24	232.1	90.82
	-11.8	-13	241.3	97.42	241.3	98.54	239.8	95.78	239.8	92.13	239.8	89.89	239.8	88.41
	-9.8	-11	249.3	98.54	249.3	95.42	247.9	92.88	247.9	89.52	247.9	87.43	247.0	85.88
	-9.5	-10	250.8	98.03	250.8	94.94	249.4	92.41	249.4	89.12	249.4	87.07	248.5	85.51
	-8.5	-9.1	255.9	96.36	255.9	93.38	254.4	90.96	254.4	87.81	254.4	85.80	248.8	84.22
	-7.0	-7.6	263.5	93.81	263.5	91.05	261.8	88.78	261.8	85.85	261.8	83.96	248.8	82.34
	-5.0	-5.6	273.4	90.45	273.4	87.89	271.6	85.87	271.6	83.24	266.3	81.49	248.8	79.78
	-3.0	-3.7	283.5	87.07	283.5	84.77	281.6	82.93	275.8	80.60	266.3	79.00	248.8	77.26
	0.0	-0.7	298.5	82.00	298.1	80.08	284.9	78.57	275.8	76.68	266.3	75.31	248.8	73.47
	3.0	2.2	313.0	76.94	303.8	75.38	284.9	74.18	275.8	72.77	266.3	71.58	248.8	69.65
	5.0	4.1	321.4	73.55	303.8	72.26	284.9	71.28	275.8	70.13	266.3	69.12	248.8	67.12
	7.0	6.0	321.4	70.16	303.8	69.13	284.9	68.34	275.8	67.51	266.3	66.65	248.8	64.59
9.0	7.9	321.4	67.84	303.8	66.84	284.9	66.09	275.8	65.27	266.3	64.44	248.8	62.45	
11.0	9.8	321.4	66.12	303.8	65.13	284.9	64.38	275.8	63.59	266.3	62.77	248.8	60.85	
13.0	11.8	321.4	64.23	303.8	63.28	284.9	62.56	275.8	61.81	266.3	61.02	248.8	59.15	
15.0	13.7	321.4	62.27	303.8	61.32	284.9	60.63	275.8	59.89	266.3	59.14	248.8	57.30	

# 7. Capacity Tables

Heating Capacity (84HP)

Combination (%)	Outdoor air temp.		Indoor air temp. °C DB											
			16		18		20		21		22		24	
	°C DB	°C WB	TC	PI	TC	PI	TC	PI	TC	PI	TC	PI	TC	PI
100	-24.8	-25	157.6	100.28	157.6	100.06	156.6	93.75	156.6	99.49	156.6	99.25	153.8	99.14
	-21.8	-22	192.9	99.93	192.9	99.71	191.9	96.71	191.9	99.14	191.9	100.31	188.4	98.79
	-19.8	-20	204.3	99.71	204.3	99.46	203.2	98.57	203.2	98.92	203.2	99.14	199.8	98.54
	-18.8	-19	208.9	99.60	207.8	99.36	207.8	99.14	207.8	98.78	207.8	98.54	204.1	97.00
	-16.7	-17	217.4	99.36	217.4	99.12	217.4	100.31	216.3	98.54	216.3	98.54	212.5	93.75
	-13.7	-15	232.5	99.01	232.5	98.76	231.1	98.54	231.1	93.91	231.1	90.77	227.4	89.07
	-11.8	-13	240.2	98.79	238.8	98.54	238.8	95.44	238.8	90.96	238.8	87.86	227.4	86.13
	-9.8	-11	247.9	98.54	247.9	95.07	246.9	92.16	246.9	87.87	243.9	84.82	227.4	83.02
	-9.5	-10	249.4	98.00	249.4	94.53	248.3	91.68	248.3	87.40	243.9	84.35	227.4	82.56
	-8.5	-9.1	254.5	96.18	254.5	92.80	253.4	90.03	252.3	85.85	243.9	82.84	227.4	80.99
	-7.0	-7.6	266.3	93.46	265.3	90.19	260.7	87.57	252.3	83.55	243.9	80.55	227.4	78.66
	-5.0	-5.6	277.9	89.80	275.1	86.72	260.7	84.32	252.3	80.43	243.9	77.50	227.4	75.55
	-3.0	-3.7	286.0	86.17	277.5	83.22	260.7	81.04	252.3	77.33	243.9	74.46	227.4	72.44
	0.0	-0.7	294.0	80.70	277.5	78.01	260.7	76.13	252.3	72.70	243.9	69.87	227.4	67.79
	3.0	2.2	294.0	75.22	277.5	72.77	260.7	71.22	252.3	68.06	243.9	65.29	227.4	63.14
	5.0	4.1	294.0	71.59	277.5	69.30	260.7	67.94	252.3	64.96	243.9	62.24	227.4	60.03
	7.0	6.0	294.0	67.93	277.5	65.80	260.7	64.66	252.3	61.87	243.9	59.19	227.4	56.92
	9.0	7.9	294.0	65.35	277.5	63.29	260.7	62.19	252.3	59.52	243.9	56.95	227.4	54.75
	11.0	9.8	294.0	63.31	277.5	61.33	260.7	60.27	252.3	57.64	243.9	55.15	227.4	53.06
	13.0	11.8	294.0	61.16	277.5	59.22	260.7	58.20	252.3	55.68	243.9	53.27	227.4	51.22
15.0	13.7	294.0	58.87	277.5	57.00	260.7	56.02	252.3	53.58	243.9	51.28	227.4	49.31	
90	-24.8	-25	156.9	88.90	156.9	90.56	155.9	91.76	155.9	92.29	155.9	93.42	153.4	95.11
	-21.8	-22	192.2	90.56	192.2	92.25	191.2	93.42	191.2	93.98	191.2	95.11	187.7	91.02
	-19.8	-20	203.6	91.69	203.6	93.37	202.2	94.54	202.2	95.11	202.2	96.30	198.8	88.29
	-18.8	-19	208.9	92.25	207.8	93.94	206.8	95.11	206.8	93.68	206.8	90.91	203.4	86.94
	-16.7	-17	217.4	93.42	217.4	95.11	216.6	92.14	216.6	90.65	216.6	87.99	207.7	84.07
	-13.7	-15	232.5	95.11	232.5	90.67	230.4	87.89	230.4	86.34	223.8	83.79	207.7	79.98
	-11.8	-13	240.2	92.06	238.8	87.88	237.8	85.18	231.2	83.60	223.8	81.15	207.7	77.39
	-9.8	-11	247.9	88.90	247.9	84.95	238.6	82.36	231.2	80.71	223.8	78.35	207.7	74.66
	-9.5	-10	249.4	88.40	249.4	84.48	238.6	81.93	231.2	80.28	223.8	77.92	207.7	74.24
	-8.5	-9.1	254.5	86.82	252.7	83.02	238.6	80.50	231.2	78.85	223.8	76.53	207.7	72.88
	-7.0	-7.6	266.3	84.42	253.3	80.80	238.6	78.39	231.2	76.68	223.8	74.43	207.7	70.83
	-5.0	-5.6	269.1	81.23	253.3	77.86	238.6	75.57	231.2	73.83	223.8	71.65	207.7	68.13
	-3.0	-3.7	269.1	78.04	253.3	74.93	238.6	72.72	231.2	70.94	223.8	68.84	207.7	65.39
	0.0	-0.7	269.1	73.27	253.3	70.49	238.6	68.47	231.2	66.63	223.8	64.65	207.7	61.31
	3.0	2.2	269.1	68.46	253.3	66.06	238.6	64.22	231.2	62.32	223.8	60.48	207.7	57.20
	5.0	4.1	269.1	65.27	253.3	63.12	238.6	61.39	231.2	59.43	223.8	57.67	207.7	54.46
	7.0	6.0	269.1	62.08	253.3	60.19	238.6	58.57	231.2	56.58	223.8	54.89	207.7	51.76
	9.0	7.9	269.1	59.08	253.3	57.26	238.6	55.72	231.2	53.83	223.8	52.22	207.7	49.26
	11.0	9.8	269.1	56.08	253.3	54.37	238.6	52.89	231.2	51.08	223.8	49.57	207.7	46.73
	13.0	11.8	269.1	53.08	253.3	51.44	238.6	50.07	231.2	48.36	223.8	46.93	207.7	44.23
15.0	13.7	269.1	50.08	253.3	48.54	238.6	47.22	231.2	45.61	223.8	44.25	207.7	41.73	
80	-24.8	-25	156.2	78.12	156.2	79.81	155.2	80.98	155.2	81.54	155.2	84.33	152.7	80.74
	-21.8	-22	190.1	79.81	190.1	81.47	190.1	82.64	190.1	84.33	190.1	80.74	185.6	77.27
	-19.8	-20	201.5	80.91	201.5	82.59	201.5	84.33	201.5	81.80	199.4	78.33	185.6	74.97
	-18.8	-19	206.1	81.47	206.1	84.33	206.1	83.04	206.1	80.52	199.6	77.12	185.6	73.83
	-16.7	-17	213.3	84.33	213.3	81.65	213.3	80.34	207.0	77.86	199.6	74.63	185.6	71.42
	-13.7	-15	223.1	80.36	218.6	77.80	213.3	76.49	207.0	74.05	199.6	71.01	185.6	67.95
	-11.8	-13	228.5	77.82	221.8	75.37	213.3	74.03	207.0	71.63	199.6	68.74	185.6	65.75
	-9.8	-11	234.5	75.17	225.0	72.83	213.3	71.46	207.0	69.11	199.6	66.33	185.6	63.45
	-9.5	-10	236.2	74.78	226.3	72.44	213.3	71.07	207.0	68.72	199.6	65.97	185.6	63.12
	-8.5	-9.1	238.7	73.46	227.4	71.16	213.3	69.79	207.0	67.44	199.6	64.79	185.6	61.96
	-7.0	-7.6	241.1	71.46	227.4	69.23	213.3	67.86	207.0	65.55	199.6	62.99	185.6	60.22
	-5.0	-5.6	241.1	68.81	227.4	66.70	213.3	65.27	207.0	62.99	199.6	60.57	185.6	57.92
	-3.0	-3.7	241.1	66.16	227.4	64.13	213.3	62.70	207.0	60.47	199.6	58.19	185.6	55.61
	0.0	-0.7	241.1	62.16	227.4	60.31	213.3	58.85	207.0	56.66	199.6	54.57	185.6	52.17
	3.0	2.2	241.1	58.19	227.4	56.45	213.3	54.97	207.0	52.82	199.6	50.98	185.6	48.70
	5.0	4.1	241.1	55.54	227.4	53.92	213.3	52.40	207.0	50.30	199.6	48.57	185.6	46.40
	7.0	6.0	241.1	52.90	227.4	51.35	213.3	49.84	207.0	47.77	199.6	46.19	185.6	44.09
	9.0	7.9	241.1	49.66	227.4	48.22	213.3	46.78	207.0	44.85	199.6	43.37	185.6	41.41
	11.0	9.8	241.1	46.09	227.4	44.75	213.3	43.44	207.0	41.62	199.6	40.24	185.6	38.42
	13.0	11.8	241.1	43.03	227.4	41.76	213.3	40.55	207.0	38.86	199.6	37.56	185.6	35.87
15.0	13.7	241.1	40.48	227.4	39.31	213.3	38.14	207.0	36.56	199.6	35.36	185.6	33.77	



# 7. Capacity Tables

Heating Capacity (84HP)

Combination (%)	Outdoor air temp.		Indoor air temp. °C DB											
			16		18		20		21		22		24	
	°C DB	°C WB	TC	PI	TC	PI	TC	PI	TC	PI	TC	PI	TC	PI
70	-24.8	-25	156.2	78.84	156.2	79.40	155.2	80.53	155.2	82.22	155.2	78.31	152.6	74.64
	-21.8	-22	182.8	80.53	182.8	81.09	181.7	82.22	175.4	78.31	170.2	74.64	158.9	71.12
	-19.8	-20	200.5	81.66	193.0	82.22	181.7	79.47	175.4	75.70	170.2	72.21	158.9	68.77
	-18.8	-19	204.3	82.22	193.0	80.80	181.7	78.09	175.4	74.39	170.2	70.98	158.9	67.57
	-16.7	-17	204.5	79.25	193.0	77.80	181.7	75.23	175.4	71.65	170.2	68.44	158.9	65.11
	-13.7	-15	204.5	75.07	193.0	73.56	181.7	71.10	175.4	67.76	170.2	64.78	158.9	61.56
	-11.8	-13	204.5	72.38	193.0	70.87	181.7	68.49	175.4	65.26	170.2	62.45	158.9	59.34
	-9.8	-11	204.5	69.59	193.0	68.02	181.7	65.77	175.4	62.65	170.2	60.02	158.9	56.98
	-9.5	-10	204.5	69.16	193.0	67.59	181.7	65.35	175.4	62.27	170.2	59.67	158.9	56.63
	-8.5	-9.1	204.5	67.78	193.0	66.18	181.7	63.97	175.4	60.96	170.2	58.44	158.9	55.44
	-7.0	-7.6	204.5	65.66	193.0	64.06	181.7	61.92	175.4	59.02	170.2	56.61	158.9	53.68
	-5.0	-5.6	204.5	62.86	193.0	61.23	181.7	59.17	175.4	56.41	170.2	54.17	158.9	51.32
	-3.0	-3.7	204.5	60.07	193.0	58.37	181.7	56.42	175.4	53.80	170.2	51.74	158.9	48.96
	0.0	-0.7	204.5	55.86	193.0	54.13	181.7	52.32	175.4	49.89	170.2	48.08	158.9	45.44
	3.0	2.2	204.5	51.65	193.0	49.88	181.7	48.19	175.4	46.01	170.2	44.42	158.9	41.89
	5.0	4.1	204.5	48.85	193.0	47.02	181.7	45.47	175.4	43.40	170.2	41.98	158.9	39.54
	7.0	6.0	204.5	46.05	193.0	44.20	181.7	42.72	175.4	40.79	170.2	39.55	158.9	37.18
	9.0	7.9	204.5	41.58	193.0	39.90	181.7	38.59	175.4	36.83	170.2	35.73	158.9	33.57
	11.0	9.8	204.5	38.73	193.0	37.15	181.7	35.91	175.4	34.29	170.2	33.26	158.9	31.26
	13.0	11.8	204.5	36.22	193.0	34.77	181.7	33.60	175.4	32.09	170.2	31.12	158.9	29.27
15.0	13.7	204.5	34.15	193.0	32.78	181.7	31.68	175.4	30.23	170.2	29.34	158.9	27.58	
60	-24.8	-25	155.6	77.71	155.6	78.84	154.6	80.53	150.5	76.37	145.3	72.48	136.1	68.81
	-21.8	-22	167.4	79.40	166.0	80.53	155.8	76.37	150.5	72.48	145.3	68.81	136.1	65.28
	-19.8	-20	175.4	80.53	166.0	77.59	155.8	73.60	150.5	69.89	145.3	66.36	136.1	62.91
	-18.8	-19	175.4	79.06	166.0	76.12	155.8	72.20	150.5	68.56	145.3	65.14	136.1	61.72
	-16.7	-17	175.4	75.94	166.0	73.03	155.8	69.30	150.5	65.84	145.3	62.59	136.1	59.24
	-13.7	-15	175.4	71.48	166.0	68.65	155.8	65.16	150.5	61.95	145.3	58.92	136.1	55.71
	-11.8	-13	175.4	68.68	166.0	65.85	155.8	62.50	150.5	59.47	145.3	56.61	136.1	53.48
	-9.8	-11	175.4	65.73	166.0	62.91	155.8	59.74	150.5	56.88	145.3	54.16	136.1	51.10
	-9.5	-10	175.4	65.27	166.0	62.49	155.8	59.32	150.5	56.49	145.3	53.78	136.1	50.75
	-8.5	-9.1	175.4	63.80	166.0	61.02	155.8	57.95	150.5	55.20	145.3	52.55	136.1	49.57
	-7.0	-7.6	175.4	61.59	166.0	58.81	155.8	55.88	150.5	53.24	145.3	50.73	136.1	47.79
	-5.0	-5.6	175.4	58.61	166.0	55.87	155.8	53.09	150.5	50.65	145.3	48.29	136.1	45.44
	-3.0	-3.7	175.4	55.66	166.0	52.93	155.8	50.32	150.5	48.06	145.3	45.84	136.1	43.07
	0.0	-0.7	175.4	51.21	166.0	48.54	155.8	46.19	150.5	44.14	145.3	42.17	136.1	39.54
	3.0	2.2	175.4	46.76	166.0	44.13	155.8	42.02	150.5	40.26	145.3	38.53	136.1	35.98
	5.0	4.1	175.4	43.81	166.0	41.19	155.8	39.26	150.5	37.67	145.3	36.08	136.1	33.64
	7.0	6.0	175.4	40.86	166.0	38.25	155.8	36.49	150.5	35.05	145.3	33.64	136.1	31.26
	9.0	7.9	175.4	36.46	166.0	34.15	155.8	32.54	150.5	31.27	145.3	29.99	136.1	27.89
	11.0	9.8	175.4	34.02	166.0	31.88	155.8	30.40	150.5	29.20	145.3	28.03	136.1	26.04
	13.0	11.8	175.4	31.88	166.0	29.85	155.8	28.48	150.5	27.35	145.3	26.24	136.1	24.42
15.0	13.7	175.4	30.13	166.0	28.24	155.8	26.90	150.5	25.86	145.3	24.80	136.1	23.08	
50	-24.8	-25	146.3	68.33	137.9	70.02	129.8	66.32	125.6	62.86	121.4	59.59	113.0	56.56
	-21.8	-22	146.3	70.02	137.9	66.32	129.8	62.86	125.6	59.59	121.4	56.56	113.0	53.64
	-19.8	-20	146.3	67.44	137.9	63.85	129.8	60.57	125.6	57.40	121.4	54.52	113.0	51.67
	-18.8	-19	146.3	66.14	137.9	62.61	129.8	59.41	125.6	56.34	121.4	53.50	113.0	50.69
	-16.7	-17	146.3	63.45	137.9	60.04	129.8	57.01	125.6	54.05	121.4	51.38	113.0	48.65
	-13.7	-15	146.3	59.60	137.9	56.33	129.8	53.55	125.6	50.78	121.4	48.35	113.0	45.73
	-11.8	-13	146.3	57.16	137.9	54.00	129.8	51.36	125.6	48.70	121.4	46.42	113.0	43.87
	-9.8	-11	146.3	54.58	137.9	51.53	129.8	49.04	125.6	46.52	121.4	44.38	113.0	41.90
	-9.5	-10	146.3	54.19	137.9	51.18	129.8	48.72	125.6	46.20	121.4	44.10	113.0	41.62
	-8.5	-9.1	146.3	52.88	137.9	49.94	129.8	47.56	125.6	45.11	121.4	43.08	113.0	40.64
	-7.0	-7.6	146.3	50.97	137.9	48.11	129.8	45.83	125.6	43.49	121.4	41.56	113.0	39.19
	-5.0	-5.6	146.3	48.39	137.9	45.64	129.8	43.54	125.6	41.30	121.4	39.52	113.0	37.23
	-3.0	-3.7	146.3	45.81	137.9	43.17	129.8	41.21	125.6	39.12	121.4	37.48	113.0	35.29
	0.0	-0.7	146.3	41.96	137.9	39.46	129.8	37.76	125.6	35.85	121.4	34.45	113.0	32.34
	3.0	2.2	146.3	38.11	137.9	35.79	129.8	34.33	125.6	32.57	121.4	31.42	113.0	29.42
	5.0	4.1	146.3	35.53	137.9	33.32	129.8	32.01	125.6	30.42	121.4	29.38	113.0	27.49
	7.0	6.0	146.3	32.95	137.9	30.85	129.8	29.72	125.6	28.24	121.4	27.34	113.0	25.52
	9.0	7.9	146.3	29.75	137.9	27.86	129.8	26.83	125.6	25.49	121.4	24.70	113.0	23.04
	11.0	9.8	146.3	27.83	137.9	26.07	129.8	25.11	125.6	23.87	121.4	23.11	113.0	21.56
	13.0	11.8	146.3	26.14	137.9	24.49	129.8	23.56	125.6	22.39	121.4	21.70	113.0	20.26
15.0	13.7	146.3	24.73	137.9	23.15	129.8	22.32	125.6	21.19	121.4	20.53	113.0	19.16	

**Note**

1. TC: Total Capacity(kW), PI : Power Input(kW, Comp. + Outdoor fan motor)
2. Capacity tables show the average value of conditions which may occur.
3. The heating capacity table is based on the values expressed as Max. in the specification of the outdoor unit. (When measuring the Max. heating capacity, the setting status of the indoor unit is the same as that for measuring the heating capacity of the indoor unit.)

# 7. Capacity Tables

## ◆ ARUM860LTE5

Heating Capacity (86HP)

Combination (%)	Outdoor air temp.		Indoor air temp. °C DB											
			16		18		20		21		22		24	
	°C DB	°C WB	TC	PI	TC	PI	TC	PI	TC	PI	TC	PI	TC	PI
130	-24.8	-25	163.5	90.2	163.5	90.99	162.5	91.65	162.5	92.64	162.5	93.62	159.5	95.15
	-21.8	-22	201.3	91.73	201.3	92.49	199.8	93.15	199.8	94.17	199.8	95.15	195.9	96.65
	-19.8	-20	213.3	92.75	213.3	93.51	211.9	94.17	211.9	95.19	211.9	96.14	207.9	97.67
	-18.8	-19	218.3	93.26	218.3	94.02	216.9	94.68	216.9	95.70	216.9	96.65	212.6	98.18
	-16.7	-17	228.5	94.32	228.5	95.08	227.0	95.74	227.0	96.76	227.0	97.74	222.7	99.24
	-13.7	-15	242.9	95.85	242.9	96.61	241.5	97.27	241.5	98.29	241.5	99.24	236.8	95.64
	-11.8	-13	250.8	96.83	250.8	97.56	249.4	98.22	249.4	99.24	249.4	99.84	245.8	93.35
	-9.8	-11	259.1	97.82	259.1	98.58	257.6	99.24	257.6	99.70	257.6	99.84	255.2	90.95
	-9.5	-10	260.6	98.00	260.6	98.73	259.1	98.85	259.1	99.31	258.8	99.31	256.7	90.56
	-8.5	-9.1	265.6	98.48	265.6	99.24	264.1	97.55	264.1	98.00	263.0	98.00	261.4	89.36
	-7.0	-7.6	273.1	99.24	273.1	97.37	271.3	95.60	271.3	93.09	271.3	90.70	268.3	87.56
	-5.0	-5.6	283.2	96.83	283.2	94.82	281.4	92.99	281.4	90.52	281.4	88.16	277.7	85.16
	-3.0	-3.7	293.2	94.43	293.2	92.31	291.4	90.38	291.4	87.94	291.4	85.62	287.1	82.73
	0.0	-0.7	308.3	90.79	308.3	88.53	306.2	86.49	306.2	84.09	306.2	81.80	301.2	79.13
	3.0	2.2	323.4	87.18	323.4	84.72	321.2	82.57	321.2	80.24	321.2	77.96	301.5	75.52
	5.0	4.1	333.1	84.74	333.1	82.20	331.3	79.96	331.3	77.67	331.3	75.42	301.5	73.09
	7.0	6.0	343.2	82.33	343.2	79.66	341.0	77.37	335.6	75.12	323.8	72.87	301.5	70.69
	9.0	7.9	345.0	80.35	345.0	77.75	343.9	75.50	335.6	73.32	323.8	71.14	301.5	68.99
11.0	9.8	345.0	79.07	345.0	76.54	343.9	74.32	335.6	72.15	323.8	70.00	301.5	67.89	
13.0	11.8	345.0	77.72	345.0	75.19	343.9	73.01	335.6	70.90	323.8	68.79	301.5	66.72	
15.0	13.7	345.0	76.23	345.0	73.77	343.9	71.63	335.6	69.52	323.8	67.48	301.5	65.44	
120	-24.8	-25	162.4	90.99	162.4	91.65	161.4	92.64	161.4	93.62	161.4	95.15	158.4	96.21
	-21.8	-22	199.8	92.49	199.8	93.15	198.4	94.17	198.4	95.15	198.4	96.65	194.8	97.74
	-19.8	-20	211.8	93.51	211.8	94.17	210.4	95.19	210.4	96.14	210.4	97.67	206.4	98.73
	-18.8	-19	216.6	94.02	216.6	94.68	215.1	95.70	215.1	96.65	215.1	98.18	211.1	99.24
	-16.7	-17	226.7	95.08	226.7	95.74	225.3	96.76	225.3	97.74	225.3	99.24	220.9	96.91
	-13.7	-15	241.1	96.61	241.1	97.27	239.7	98.29	239.7	99.24	239.7	95.78	235.0	93.59
	-11.8	-13	249.0	97.56	249.0	98.22	247.6	99.24	247.6	96.80	247.6	93.59	244.0	91.51
	-9.8	-11	257.3	98.58	257.3	99.24	255.8	96.56	255.8	94.23	255.8	91.30	253.4	89.29
	-9.5	-10	258.8	98.73	258.8	98.82	257.3	96.17	257.3	93.84	257.3	90.95	254.9	88.94
	-8.5	-9.1	263.8	99.24	263.8	97.41	262.0	94.83	262.0	92.57	262.0	89.81	259.3	87.84
	-7.0	-7.6	271.3	97.16	271.3	95.29	269.5	92.82	269.5	90.63	269.5	88.09	266.5	86.18
	-5.0	-5.6	281.3	94.37	281.3	92.46	279.5	90.13	279.5	88.05	279.5	85.76	275.9	83.96
	-3.0	-3.7	291.1	91.58	291.1	89.67	289.3	87.45	289.3	85.51	289.3	83.46	283.2	81.74
	0.0	-0.7	306.1	87.41	306.1	85.43	304.0	83.43	304.0	81.63	304.0	80.01	283.2	78.42
	3.0	2.2	320.9	83.23	320.9	81.19	319.0	79.40	314.5	77.78	304.7	76.55	283.2	75.10
	5.0	4.1	330.9	80.44	330.9	78.37	325.2	76.75	314.5	75.20	304.7	74.25	283.2	72.88
	7.0	6.0	341.0	77.65	338.8	75.55	325.2	74.07	314.5	72.63	304.7	71.96	283.2	70.66
	9.0	7.9	342.4	75.57	338.8	73.53	325.2	72.09	314.5	70.72	304.7	70.05	283.2	68.78
11.0	9.8	342.4	74.19	338.8	72.18	325.2	70.74	314.5	69.40	304.7	68.74	283.2	67.51	
13.0	11.8	342.4	72.67	338.8	70.70	325.2	69.32	314.5	67.99	304.7	67.35	283.2	66.16	
15.0	13.7	342.4	71.07	338.8	69.13	325.2	67.77	314.5	66.47	304.7	65.83	283.2	64.67	
110	-24.8	-25	161.7	91.65	161.7	92.64	160.6	93.62	160.6	95.15	160.6	96.21	157.4	96.72
	-21.8	-22	198.7	93.15	198.7	94.17	197.3	95.15	197.3	96.65	197.3	97.74	193.7	98.22
	-19.8	-20	210.8	94.17	210.8	95.19	209.3	96.14	209.3	97.67	209.3	98.73	205.4	99.24
	-18.8	-19	215.5	94.68	215.5	95.70	214.0	96.65	214.0	98.18	214.0	99.24	210.1	98.01
	-16.7	-17	225.6	95.74	225.6	96.76	224.2	97.74	224.2	99.24	224.2	96.73	219.8	95.40
	-13.7	-15	239.7	97.27	239.7	98.29	238.3	99.24	238.3	95.43	238.3	93.10	238.3	91.69
	-11.8	-13	247.6	98.22	247.6	99.24	246.2	96.56	246.2	93.00	246.2	90.81	246.2	89.33
	-9.8	-11	255.9	99.24	255.9	96.21	254.4	93.73	254.4	90.45	254.4	88.41	253.5	86.86
	-9.5	-10	257.3	98.75	257.3	95.75	255.9	93.28	255.9	90.07	255.9	88.05	254.8	86.50
	-8.5	-9.1	262.3	97.12	262.3	94.23	260.9	91.87	260.9	88.80	260.9	86.82	254.8	85.24
	-7.0	-7.6	269.9	94.65	269.9	91.97	268.1	89.75	268.1	86.89	268.1	85.02	254.8	83.40
	-5.0	-5.6	279.6	91.40	279.6	88.90	277.8	86.92	277.8	84.35	272.8	82.62	254.8	80.90
	-3.0	-3.7	289.6	88.12	289.6	85.87	287.8	84.07	282.4	81.78	272.8	80.19	254.8	78.43
	0.0	-0.7	304.4	83.22	304.4	81.31	291.8	79.83	282.4	77.96	272.8	76.59	254.8	74.73
	3.0	2.2	319.1	78.31	311.2	76.76	291.8	75.56	282.4	74.15	272.8	72.96	254.8	70.99
	5.0	4.1	329.1	75.03	311.2	73.73	291.8	72.74	282.4	71.58	272.8	70.56	254.8	68.52
	7.0	6.0	329.2	71.75	311.2	70.69	291.8	69.88	282.4	69.04	272.8	68.16	254.8	66.05
	9.0	7.9	329.2	69.52	311.2	68.50	291.8	67.73	282.4	66.89	272.8	66.04	254.8	64.00
11.0	9.8	329.2	67.93	311.2	66.91	291.8	66.14	282.4	65.33	272.8	64.49	254.8	62.51	
13.0	11.8	329.2	66.16	311.2	65.18	291.8	64.44	282.4	63.66	272.8	62.85	254.8	60.92	
15.0	13.7	329.2	64.32	311.2	63.34	291.8	62.63	282.4	61.86	272.8	61.09	254.8	59.19	

# 7. Capacity Tables

Heating Capacity (86HP)

Combination (%)	Outdoor air temp.		Indoor air temp. °C DB											
			16		18		20		21		22		24	
	°C DB	°C WB	TC	PI	TC	PI	TC	PI	TC	PI	TC	PI	TC	PI
100	-24.8	-25	161.0	101.61	161.0	101.31	159.9	94.69	159.9	100.53	159.9	100.20	156.7	100.05
	-21.8	-22	197.7	101.13	197.7	100.83	196.6	97.67	196.6	100.05	196.6	101.11	192.7	99.57
	-19.8	-20	209.7	100.83	209.7	100.50	208.6	99.54	208.6	99.75	208.6	99.87	204.6	99.24
	-18.8	-19	214.4	100.68	213.3	100.35	213.3	100.05	213.3	99.57	213.3	99.24	209.0	97.72
	-16.7	-17	223.1	100.35	223.1	100.02	223.1	101.11	222.0	99.24	222.0	96.10	217.7	94.51
	-13.7	-15	238.6	99.87	238.6	99.54	237.2	99.24	237.2	94.69	237.2	91.59	232.9	89.90
	-11.8	-13	246.5	99.57	245.1	99.24	245.1	96.21	245.1	91.80	245.1	88.73	232.9	87.01
	-9.8	-11	254.5	99.24	254.5	95.85	253.3	93.00	253.3	88.77	249.8	85.74	232.9	83.94
	-9.5	-10	255.9	98.71	255.9	95.33	254.8	92.54	254.8	88.31	249.8	85.28	232.9	83.48
	-8.5	-9.1	260.9	96.95	260.9	93.63	259.8	90.92	258.4	86.79	249.8	83.80	232.9	81.93
	-7.0	-7.6	272.8	94.30	271.7	91.09	267.0	88.52	258.4	84.53	249.8	81.54	232.9	79.64
	-5.0	-5.6	284.6	90.74	281.8	87.70	267.0	85.34	258.4	81.47	249.8	78.54	232.9	76.57
	-3.0	-3.7	292.9	87.21	284.2	84.28	267.0	82.13	258.4	78.44	249.8	75.55	232.9	73.51
	0.0	-0.7	301.1	81.88	284.2	79.20	267.0	77.33	258.4	73.89	249.8	71.03	232.9	68.92
	3.0	2.2	301.1	76.55	284.2	74.09	267.0	72.54	258.4	69.34	249.8	66.52	232.9	64.34
	5.0	4.1	301.1	73.02	284.2	70.70	267.0	69.33	258.4	66.30	249.8	63.52	232.9	61.27
	7.0	6.0	301.1	69.46	284.2	67.28	267.0	66.12	258.4	63.27	249.8	60.53	232.9	58.21
	9.0	7.9	301.1	67.00	284.2	64.89	267.0	63.77	258.4	61.02	249.8	58.38	232.9	56.14
	11.0	9.8	301.1	65.10	284.2	63.06	267.0	61.97	258.4	59.27	249.8	56.70	232.9	54.56
	13.0	11.8	301.1	63.09	284.2	61.09	267.0	60.03	258.4	57.44	249.8	54.94	232.9	52.84
15.0	13.7	301.1	60.94	284.2	59.01	267.0	57.99	258.4	55.47	249.8	53.08	232.9	51.04	
90	-24.8	-25	160.3	90.25	160.3	91.75	159.2	92.84	159.2	93.32	159.2	94.34	156.3	95.87
	-21.8	-22	197.0	91.75	197.0	93.28	195.9	94.34	195.9	94.85	195.9	95.87	191.9	91.82
	-19.8	-20	209.0	92.77	209.0	94.30	207.6	95.36	207.6	95.87	207.6	96.90	203.6	89.12
	-18.8	-19	214.4	93.28	213.3	94.81	212.3	95.87	212.3	94.46	212.3	91.72	208.3	87.78
	-16.7	-17	223.1	94.34	223.1	95.87	222.3	92.95	222.3	91.47	222.3	88.84	212.7	84.93
	-13.7	-15	238.6	95.87	238.6	91.51	236.5	88.76	236.5	87.22	229.2	84.69	212.7	80.89
	-11.8	-13	246.5	92.88	245.1	88.77	244.0	86.10	236.8	84.51	229.2	82.08	212.7	78.32
	-9.8	-11	254.5	89.78	254.5	85.88	244.4	83.32	236.8	81.67	229.2	79.31	212.7	75.61
	-9.5	-10	255.9	89.29	255.9	85.43	244.4	82.89	236.8	81.24	229.2	78.89	212.7	75.19
	-8.5	-9.1	260.9	87.75	259.1	83.98	244.4	81.49	236.8	79.83	229.2	77.51	212.7	73.86
	-7.0	-7.6	272.8	85.39	259.5	81.81	244.4	79.41	236.8	77.69	229.2	75.44	212.7	71.82
	-5.0	-5.6	275.7	82.26	259.5	78.92	244.4	76.63	236.8	74.87	229.2	72.69	212.7	69.14
	-3.0	-3.7	275.7	79.13	259.5	76.03	244.4	73.82	236.8	72.03	229.2	69.92	212.7	66.43
	0.0	-0.7	275.7	74.45	259.5	71.68	244.4	69.64	236.8	67.77	229.2	65.77	212.7	62.39
	3.0	2.2	275.7	69.74	259.5	67.32	244.4	65.45	236.8	63.52	229.2	61.65	212.7	58.31
	5.0	4.1	275.7	66.61	259.5	64.43	244.4	62.67	236.8	60.67	229.2	58.88	212.7	55.61
	7.0	6.0	275.7	63.48	259.5	61.55	244.4	59.89	236.8	57.85	229.2	56.13	212.7	52.93
	9.0	7.9	275.7	60.53	259.5	58.66	244.4	57.08	236.8	55.15	229.2	53.50	212.7	50.47
	11.0	9.8	275.7	57.57	259.5	55.81	244.4	54.30	236.8	52.44	229.2	50.89	212.7	47.97
	13.0	11.8	275.7	54.62	259.5	52.93	244.4	51.52	236.8	49.76	229.2	48.29	212.7	45.51
15.0	13.7	275.7	51.66	259.5	50.08	244.4	48.71	236.8	47.06	229.2	45.65	212.7	43.05	
80	-24.8	-25	159.6	79.38	159.6	80.91	158.5	81.97	158.5	82.48	158.5	85.00	155.6	81.45
	-21.8	-22	194.8	80.91	194.8	82.41	194.8	83.47	194.8	85.00	194.8	81.45	190.1	78.01
	-19.8	-20	206.8	81.90	206.8	83.43	206.8	85.00	206.8	82.50	204.4	79.06	190.1	75.72
	-18.8	-19	211.5	82.41	211.5	85.00	211.5	83.74	211.5	81.24	204.4	77.87	190.1	74.59
	-16.7	-17	218.5	85.00	218.5	82.37	218.5	81.07	212.0	78.60	204.4	75.40	190.1	72.20
	-13.7	-15	228.5	81.10	223.9	78.57	218.5	77.27	212.0	74.84	204.4	71.82	190.1	68.76
	-11.8	-13	234.0	78.60	227.1	76.18	218.5	74.84	212.0	72.45	204.4	69.56	190.1	66.58
	-9.8	-11	240.1	76.00	230.4	73.68	218.5	72.31	212.0	69.95	204.4	67.18	190.1	64.29
	-9.5	-10	241.9	75.61	231.8	73.29	218.5	71.92	212.0	69.56	204.4	66.82	190.1	63.97
	-8.5	-9.1	244.4	74.31	232.8	72.03	218.5	70.65	212.0	68.30	204.4	65.66	190.1	62.81
	-7.0	-7.6	246.9	72.34	232.8	70.13	218.5	68.75	212.0	66.43	204.4	63.87	190.1	61.09
	-5.0	-5.6	246.9	69.74	232.8	67.63	218.5	66.19	212.0	63.90	204.4	61.48	190.1	58.80
	-3.0	-3.7	246.9	67.14	232.8	65.10	218.5	63.66	212.0	61.40	204.4	59.12	190.1	56.52
	0.0	-0.7	246.9	63.20	232.8	61.33	218.5	59.86	212.0	57.64	204.4	55.53	190.1	53.11
	3.0	2.2	246.9	59.30	232.8	57.54	218.5	56.03	212.0	53.85	204.4	51.98	190.1	49.66
	5.0	4.1	246.9	56.69	232.8	55.04	218.5	53.49	212.0	51.35	204.4	49.59	190.1	47.38
	7.0	6.0	246.9	54.09	232.8	52.51	218.5	50.96	212.0	48.85	204.4	47.23	190.1	45.09
	9.0	7.9	246.9	50.78	232.8	49.31	218.5	47.83	212.0	45.86	204.4	44.35	190.1	42.34
	11.0	9.8	246.9	47.13	232.8	45.76	218.5	44.42	212.0	42.56	204.4	41.15	190.1	39.29
	13.0	11.8	246.9	44.00	232.8	42.70	218.5	41.46	212.0	39.74	204.4	38.41	190.1	36.68
15.0	13.7	246.9	41.40	232.8	40.20	218.5	39.01	212.0	37.39	204.4	36.16	190.1	34.54	

# 7. Capacity Tables

Heating Capacity (86HP)

Combination (%)	Outdoor air temp.		Indoor air temp. °C DB											
			16		18		20		21		22		24	
	°C DB	°C WB	TC	PI	TC	PI	TC	PI	TC	PI	TC	PI	TC	PI
70	-24.8	-25	159.6	79.97	159.6	80.48	158.5	81.50	158.5	83.03	158.5	79.13	155.6	75.47
	-21.8	-22	187.2	81.50	187.2	82.01	186.1	83.03	179.7	79.13	174.3	75.47	162.8	71.95
	-19.8	-20	205.7	82.52	197.7	83.03	186.1	80.29	179.7	76.53	174.3	73.05	162.8	69.60
	-18.8	-19	209.5	83.03	197.7	81.62	186.1	78.92	179.7	75.23	174.3	71.82	162.8	68.40
	-16.7	-17	209.5	80.08	197.7	78.64	186.1	76.07	179.7	72.49	174.3	69.28	162.8	65.94
	-13.7	-15	209.5	75.93	197.7	74.42	186.1	71.96	179.7	68.61	174.3	65.63	162.8	62.39
	-11.8	-13	209.5	73.26	197.7	71.74	186.1	69.35	179.7	66.12	174.3	63.31	162.8	60.17
	-9.8	-11	209.5	70.48	197.7	68.90	186.1	66.64	179.7	63.52	174.3	60.88	162.8	57.82
	-9.5	-10	209.5	70.06	197.7	68.48	186.1	66.22	179.7	63.13	174.3	60.52	162.8	57.47
	-8.5	-9.1	209.5	68.68	197.7	67.07	186.1	64.85	179.7	61.83	174.3	59.30	162.8	56.27
	-7.0	-7.6	209.5	66.58	197.7	64.96	186.1	62.81	179.7	59.89	174.3	57.47	162.8	54.51
	-5.0	-5.6	209.5	63.80	197.7	62.14	186.1	60.07	179.7	57.29	174.3	55.04	162.8	52.16
	-3.0	-3.7	209.5	61.02	197.7	59.30	186.1	57.33	179.7	54.69	174.3	52.61	162.8	49.80
	0.0	-0.7	209.5	56.83	197.7	55.08	186.1	53.25	179.7	50.79	174.3	48.96	162.8	46.28
	3.0	2.2	209.5	52.65	197.7	50.85	186.1	49.13	179.7	46.91	174.3	45.30	162.8	42.73
	5.0	4.1	209.5	49.87	197.7	48.01	186.1	46.42	179.7	44.31	174.3	42.87	162.8	40.38
	7.0	6.0	209.5	47.09	197.7	45.19	186.1	43.68	179.7	41.71	174.3	40.45	162.8	38.02
	9.0	7.9	209.5	42.52	197.7	40.80	186.1	39.46	179.7	37.67	174.3	36.54	162.8	34.33
	11.0	9.8	209.5	39.60	197.7	37.99	186.1	36.72	179.7	35.06	174.3	34.01	162.8	31.97
	13.0	11.8	209.5	37.04	197.7	35.56	186.1	34.36	179.7	32.81	174.3	31.83	162.8	29.93
15.0	13.7	209.5	34.92	197.7	33.52	186.1	32.39	179.7	30.92	174.3	30.00	162.8	28.21	
60	-24.8	-25	159.4	78.95	159.4	79.97	158.3	81.50	154.2	77.32	148.8	73.42	139.4	69.73
	-21.8	-22	171.5	80.48	170.0	81.50	159.5	77.32	154.2	73.42	148.8	69.73	139.4	66.18
	-19.8	-20	179.7	81.50	170.0	78.55	159.5	74.55	154.2	70.82	148.8	67.28	139.4	63.80
	-18.8	-19	179.7	80.03	170.0	77.08	159.5	73.14	154.2	69.49	148.8	66.05	139.4	62.60
	-16.7	-17	179.7	76.90	170.0	73.99	159.5	70.23	154.2	66.75	148.8	63.48	139.4	60.11
	-13.7	-15	179.7	72.44	170.0	69.59	159.5	66.08	154.2	62.85	148.8	59.79	139.4	56.56
	-11.8	-13	179.7	69.63	170.0	66.79	159.5	63.42	154.2	60.36	148.8	57.47	139.4	54.31
	-9.8	-11	179.7	66.68	170.0	63.84	159.5	60.64	154.2	57.76	148.8	55.01	139.4	51.92
	-9.5	-10	179.7	66.23	170.0	63.41	159.5	60.22	154.2	57.37	148.8	54.63	139.4	51.57
	-8.5	-9.1	179.7	64.75	170.0	61.94	159.5	58.85	154.2	56.07	148.8	53.40	139.4	50.38
	-7.0	-7.6	179.7	62.54	170.0	59.73	159.5	56.77	154.2	54.10	148.8	51.57	139.4	48.59
	-5.0	-5.6	179.7	59.55	170.0	56.78	159.5	53.97	154.2	51.50	148.8	49.12	139.4	46.23
	-3.0	-3.7	179.7	56.60	170.0	53.83	159.5	51.19	154.2	48.90	148.8	46.66	139.4	43.84
	0.0	-0.7	179.7	52.14	170.0	49.43	159.5	47.04	154.2	44.97	148.8	42.97	139.4	40.29
	3.0	2.2	179.7	47.68	170.0	45.01	159.5	42.86	154.2	41.07	148.8	39.31	139.4	36.71
	5.0	4.1	179.7	44.73	170.0	42.06	159.5	40.09	154.2	38.47	148.8	36.85	139.4	34.36
	7.0	6.0	179.7	41.78	170.0	39.11	159.5	37.31	154.2	35.84	148.8	34.40	139.4	31.97
	9.0	7.9	179.7	37.28	170.0	34.92	159.5	33.27	154.2	31.97	148.8	30.67	139.4	28.52
	11.0	9.8	179.7	34.79	170.0	32.60	159.5	31.09	154.2	29.86	148.8	28.66	139.4	26.63
	13.0	11.8	179.7	32.60	170.0	30.53	159.5	29.12	154.2	27.96	148.8	26.84	139.4	24.97
15.0	13.7	179.7	30.81	170.0	28.87	159.5	27.50	154.2	26.45	148.8	25.36	139.4	23.60	
50	-24.8	-25	149.9	69.05	141.3	70.58	132.9	66.89	128.6	63.44	124.3	60.18	115.7	57.15
	-21.8	-22	149.9	70.58	141.3	66.89	132.9	63.44	128.6	60.18	124.3	57.15	115.7	54.23
	-19.8	-20	149.9	68.02	141.3	64.43	132.9	61.16	128.6	58.00	124.3	55.11	115.7	52.26
	-18.8	-19	149.9	66.72	141.3	63.20	132.9	60.00	128.6	56.94	124.3	54.09	115.7	51.28
	-16.7	-17	149.9	64.04	141.3	60.63	132.9	57.60	128.6	54.65	124.3	51.98	115.7	49.24
	-13.7	-15	149.9	60.21	141.3	56.94	132.9	54.16	128.6	51.38	124.3	48.95	115.7	46.32
	-11.8	-13	149.9	57.78	141.3	54.62	132.9	51.98	128.6	49.31	124.3	47.02	115.7	44.45
	-9.8	-11	149.9	55.21	141.3	52.16	132.9	49.66	128.6	47.13	124.3	44.98	115.7	42.49
	-9.5	-10	149.9	54.83	141.3	51.80	132.9	49.34	128.6	46.81	124.3	44.70	115.7	42.20
	-8.5	-9.1	149.9	53.53	141.3	50.57	132.9	48.18	128.6	45.72	124.3	43.68	115.7	41.22
	-7.0	-7.6	149.9	51.63	141.3	48.74	132.9	46.46	128.6	44.10	124.3	42.17	115.7	39.78
	-5.0	-5.6	149.9	49.06	141.3	46.28	132.9	44.17	128.6	41.92	124.3	40.13	115.7	37.81
	-3.0	-3.7	149.9	46.49	141.3	43.82	132.9	41.85	128.6	39.74	124.3	38.09	115.7	35.87
	0.0	-0.7	149.9	42.66	141.3	40.13	132.9	38.41	128.6	36.47	124.3	35.06	115.7	32.92
	3.0	2.2	149.9	38.83	141.3	36.47	132.9	34.99	128.6	33.20	124.3	32.04	115.7	30.00
	5.0	4.1	149.9	36.26	141.3	34.01	132.9	32.67	128.6	31.05	124.3	30.00	115.7	28.06
	7.0	6.0	149.9	33.69	141.3	31.55	132.9	30.39	128.6	28.87	124.3	27.96	115.7	26.10
	9.0	7.9	149.9	30.42	141.3	28.49	132.9	27.43	128.6	26.06	124.3	25.25	115.7	23.56
	11.0	9.8	149.9	28.46	141.3	26.66	132.9	25.67	128.6	24.41	124.3	23.63	115.7	22.05
	13.0	11.8	149.9	26.73	141.3	25.04	132.9	24.09	128.6	22.90	124.3	22.19	115.7	20.71
15.0	13.7	149.9	25.29	141.3	23.67	132.9	22.82	128.6	21.67	124.3	21.00	115.7	19.59	

**Note**

1. TC: Total Capacity(kW), PI : Power Input(kW, Comp. + Outdoor fan motor)
2. Capacity tables show the average value of conditions which may occur.
3. The heating capacity table is based on the values expressed as Max. in the specification of the outdoor unit. (When measuring the Max. heating capacity, the setting status of the indoor unit is the same as that for measuring the heating capacity of the indoor unit.)

# 7. Capacity Tables

## ◆ ARUM880LTE5

Heating Capacity (88HP)

Combination (%)	Outdoor air temp.		Indoor air temp. °C DB											
			16		18		20		21		22		24	
	°C DB	°C WB	TC	PI	TC	PI	TC	PI	TC	PI	TC	PI	TC	PI
130	-24.8	-25	164.9	92.0	164.9	92.87	163.8	93.65	163.8	94.83	163.8	95.98	161.4	97.80
	-21.8	-22	203.2	93.75	203.2	94.65	201.8	95.43	201.8	96.64	201.8	97.80	198.5	99.58
	-19.8	-20	215.5	94.95	215.5	95.86	214.1	96.64	214.1	97.84	214.1	98.97	210.8	100.8
	-18.8	-19	220.7	95.56	220.7	96.46	219.3	97.24	219.3	98.45	219.3	99.58	215.7	101.4
	-16.7	-17	231.1	96.81	231.1	97.72	229.7	98.50	229.7	99.70	229.7	100.9	226.1	102.6
	-13.7	-15	246.0	98.62	246.0	99.53	244.5	100.3	244.5	101.5	244.5	102.6	240.6	98.97
	-11.8	-13	254.1	99.78	254.1	100.7	252.6	101.4	252.6	102.6	252.6	100.2	249.6	96.64
	-9.8	-11	262.6	101.0	262.6	101.9	261.1	102.6	261.1	100.1	261.1	97.61	259.0	94.19
	-9.5	-10	264.3	101.2	264.3	102.0	262.8	102.3	262.8	99.66	262.2	97.22	260.4	93.80
	-8.5	-9.1	270.4	101.7	270.4	102.6	268.9	100.9	268.9	98.34	266.6	95.92	265.1	92.57
	-7.0	-7.6	279.6	102.6	279.6	100.8	277.7	98.96	277.7	96.40	277.7	93.95	273.2	90.74
	-5.0	-5.6	291.8	100.2	291.8	98.18	289.9	96.31	289.9	93.79	289.9	91.37	282.9	88.29
	-3.0	-3.7	304.0	97.81	304.0	95.65	302.1	93.67	302.1	91.17	302.1	88.78	292.6	85.81
	0.0	-0.7	322.3	94.15	322.3	91.83	320.0	89.73	318.9	87.26	316.7	84.90	307.5	82.14
	3.0	2.2	335.1	90.52	335.1	87.98	333.1	85.76	331.5	83.36	329.3	80.99	308.6	78.47
	5.0	4.1	343.2	88.08	343.2	85.45	341.5	83.11	339.9	80.74	331.4	78.40	308.6	75.99
	7.0	6.0	351.6	85.66	351.6	82.88	349.6	80.50	343.5	78.15	331.4	75.82	308.6	73.55
	9.0	7.9	353.1	83.67	353.1	80.97	352.0	78.62	343.5	76.35	331.4	74.08	308.6	71.85
11.0	9.8	353.1	82.43	353.1	79.78	352.0	77.47	343.5	75.20	331.4	72.97	308.6	70.77	
13.0	11.8	353.1	81.10	353.1	78.46	352.0	76.19	343.5	73.99	331.4	71.78	308.6	69.62	
15.0	13.7	353.1	79.64	353.1	77.07	352.0	74.83	343.5	72.63	331.4	70.49	308.6	68.37	
120	-24.8	-25	163.8	92.87	163.8	93.65	162.7	94.83	162.7	95.98	162.7	97.80	160.3	99.05
	-21.8	-22	201.8	94.65	201.8	95.43	200.4	96.64	200.4	97.80	200.4	99.58	197.4	100.9
	-19.8	-20	214.1	95.86	214.1	96.64	212.6	97.84	212.6	98.97	212.6	100.8	209.3	102.0
	-18.8	-19	218.9	96.46	218.9	97.24	217.5	98.45	217.5	99.58	217.5	101.4	214.2	102.6
	-16.7	-17	229.3	97.72	229.3	98.50	227.9	99.70	227.9	100.9	227.9	102.6	224.3	100.3
	-13.7	-15	244.2	99.53	244.2	100.3	242.7	101.5	242.7	102.6	242.7	99.12	238.8	96.89
	-11.8	-13	252.3	100.7	252.3	101.4	250.8	102.6	250.8	100.2	250.8	96.89	247.8	94.76
	-9.8	-11	260.7	101.9	260.7	102.6	259.2	99.92	259.2	97.54	259.2	94.56	257.1	92.50
	-9.5	-10	262.5	102.0	262.5	102.2	261.0	99.52	261.0	97.15	261.0	94.20	258.9	92.14
	-8.5	-9.1	268.6	102.6	268.6	100.8	266.8	98.16	266.8	95.85	266.3	93.05	263.9	91.02
	-7.0	-7.6	277.7	100.5	277.7	98.63	275.9	96.11	275.9	93.88	274.0	91.28	271.3	89.33
	-5.0	-5.6	289.9	97.71	289.9	95.76	288.0	93.39	288.0	91.26	288.0	88.92	281.0	87.07
	-3.0	-3.7	301.7	94.88	301.7	92.93	299.9	90.66	299.9	88.67	299.0	86.58	289.2	84.80
	0.0	-0.7	320.0	90.66	319.5	88.63	315.2	86.57	313.2	84.72	311.3	83.06	289.8	81.42
	3.0	2.2	332.5	86.44	331.8	84.33	327.8	82.48	321.9	80.80	311.9	79.54	289.8	78.04
	5.0	4.1	340.9	83.61	340.2	81.46	332.9	79.78	321.9	78.18	311.9	77.20	289.8	75.78
	7.0	6.0	349.3	80.79	346.8	78.60	332.9	77.06	321.9	75.56	311.9	74.86	289.8	73.51
	9.0	7.9	350.5	78.69	346.8	76.57	332.9	75.06	321.9	73.64	311.9	72.94	289.8	71.62
11.0	9.8	350.5	77.32	346.8	75.23	332.9	73.73	321.9	72.34	311.9	71.64	289.8	70.36	
13.0	11.8	350.5	75.81	346.8	73.76	332.9	72.32	321.9	70.93	311.9	70.27	289.8	69.02	
15.0	13.7	350.5	74.22	346.8	72.21	332.9	70.78	321.9	69.42	311.9	68.76	289.8	67.55	
110	-24.8	-25	163.0	93.65	163.0	94.83	162.0	95.98	162.0	97.80	162.0	99.05	159.3	99.66
	-21.8	-22	200.7	95.43	200.7	96.64	199.3	97.80	199.3	99.58	199.3	100.9	196.3	101.4
	-19.8	-20	213.0	96.64	213.0	97.84	211.5	98.97	211.5	100.8	211.5	102.0	208.2	102.6
	-18.8	-19	217.8	97.24	217.8	98.45	216.4	99.58	216.4	101.4	216.4	102.6	213.1	101.4
	-16.7	-17	228.2	98.50	228.2	99.70	226.8	100.9	226.8	102.6	226.8	100.1	223.2	98.71
	-13.7	-15	242.8	100.3	242.8	101.5	241.3	102.6	241.3	98.75	241.3	96.38	241.3	94.93
	-11.8	-13	250.8	101.4	250.8	102.6	249.4	99.91	249.4	96.27	249.4	94.03	249.4	92.51
	-9.8	-11	259.3	102.6	259.3	99.55	257.8	97.03	257.8	93.68	257.8	91.58	256.9	89.99
	-9.5	-10	261.0	102.1	261.0	99.08	259.6	96.56	259.6	93.28	259.6	91.22	258.7	89.62
	-8.5	-9.1	267.1	100.5	267.1	97.54	265.6	95.12	265.6	91.99	265.3	89.97	260.2	88.33
	-7.0	-7.6	276.2	97.97	276.2	95.23	274.4	92.96	274.4	90.04	272.9	88.13	260.8	86.45
	-5.0	-5.6	288.1	94.66	288.1	92.11	286.2	90.08	285.2	87.45	278.3	85.68	260.8	83.90
	-3.0	-3.7	300.2	91.32	300.2	89.01	295.4	87.17	289.1	84.82	279.2	83.20	260.8	81.37
	0.0	-0.7	316.2	86.32	312.8	84.37	298.7	82.85	289.1	80.93	279.2	79.52	260.8	77.58
	3.0	2.2	328.5	81.33	318.5	79.73	298.7	78.50	289.1	77.04	279.2	75.81	260.8	73.77
	5.0	4.1	336.9	77.99	318.5	76.64	298.7	75.62	289.1	74.42	279.2	73.36	260.8	71.24
	7.0	6.0	336.9	74.65	318.5	73.54	298.7	72.71	289.1	71.83	279.2	70.91	260.8	68.72
	9.0	7.9	336.9	72.39	318.5	71.33	298.7	70.52	289.1	69.65	279.2	68.77	260.8	66.64
11.0	9.8	336.9	70.79	318.5	69.73	298.7	68.93	289.1	68.09	279.2	67.21	260.8	65.15	
13.0	11.8	336.9	69.02	318.5	68.00	298.7	67.23	289.1	66.42	279.2	65.57	260.8	63.55	
15.0	13.7	336.9	67.17	318.5	66.15	298.7	65.41	289.1	64.61	279.2	63.80	260.8	61.82	

# 7. Capacity Tables

Heating Capacity (88HP)

Combination (%)	Outdoor air temp.		Indoor air temp. °C DB											
			16		18		20		21		22		24	
	°C DB	°C WB	TC	PI	TC	PI	TC	PI	TC	PI	TC	PI	TC	PI
100	-24.8	-25	162.3	103.8	162.3	103.7	161.2	97.43	161.2	103.3	161.2	103.1	158.5	103.1
	-21.8	-22	199.6	103.6	199.6	103.4	198.5	100.5	198.5	103.1	198.5	104.3	195.2	102.8
	-19.8	-20	211.9	103.4	211.9	103.3	210.8	102.5	210.8	102.9	210.8	103.2	207.5	102.6
	-18.8	-19	216.8	103.4	215.6	103.2	215.6	103.1	215.6	102.8	215.6	102.6	212.0	101.1
	-16.7	-17	225.7	103.2	225.7	103.0	225.7	104.3	224.6	102.6	224.6	99.43	221.0	97.79
	-13.7	-15	241.7	103.0	241.7	102.8	240.2	102.6	240.2	97.99	240.2	94.80	236.6	93.06
	-11.8	-13	249.7	102.8	248.3	102.6	248.3	99.54	248.3	95.03	248.3	91.88	238.1	90.09
	-9.8	-11	257.8	102.6	257.8	99.18	256.7	96.26	256.7	91.92	253.7	88.81	238.3	86.95
	-9.5	-10	259.6	102.1	259.6	98.65	258.5	95.79	258.5	91.45	254.3	88.34	238.3	86.48
	-8.5	-9.1	265.6	100.3	265.6	96.91	264.5	94.14	264.5	89.90	255.7	86.82	238.3	84.89
	-7.0	-7.6	279.2	97.60	278.1	94.32	273.3	91.68	264.5	87.59	255.7	84.50	238.3	82.54
	-5.0	-5.6	291.4	93.97	288.4	90.86	273.3	88.43	264.5	84.45	255.7	81.43	238.3	79.40
	-3.0	-3.7	299.8	90.37	290.9	87.37	273.3	85.16	264.5	81.35	255.7	78.36	238.3	76.25
	0.0	-0.7	308.3	84.93	290.9	82.17	273.3	80.25	264.5	76.69	255.7	73.74	238.3	71.55
	3.0	2.2	308.3	79.50	290.9	76.95	273.3	75.35	264.5	72.03	255.7	69.11	238.3	66.85
	5.0	4.1	308.3	75.90	290.9	73.49	273.3	72.07	264.5	68.93	255.7	66.04	238.3	63.70
	7.0	6.0	308.3	72.27	290.9	70.00	273.3	68.79	264.5	65.82	255.7	62.97	238.3	60.56
	9.0	7.9	308.3	69.72	290.9	67.53	273.3	66.36	264.5	63.50	255.7	60.76	238.3	58.42
	11.0	9.8	308.3	67.76	290.9	65.64	273.3	64.51	264.5	61.70	255.7	59.03	238.3	56.79
	13.0	11.8	308.3	65.69	290.9	63.61	273.3	62.51	264.5	59.81	255.7	57.21	238.3	55.02
15.0	13.7	308.3	63.48	290.9	61.47	273.3	60.41	264.5	57.78	255.7	55.29	238.3	53.17	
90	-24.8	-25	161.6	92.24	161.6	94.02	160.5	95.31	160.5	95.88	160.5	97.09	158.1	98.90
	-21.8	-22	198.9	94.02	198.9	95.83	197.8	97.09	197.8	97.69	197.8	98.90	194.5	94.77
	-19.8	-20	211.2	95.23	211.2	97.04	209.7	98.29	209.7	98.90	209.7	96.07	206.4	92.01
	-18.8	-19	216.8	95.83	215.6	97.64	214.6	98.90	214.6	97.46	214.6	94.67	211.3	90.64
	-16.7	-17	225.7	97.09	225.7	98.90	224.9	95.93	224.9	94.42	224.9	91.73	216.8	87.73
	-13.7	-15	241.7	98.90	241.7	94.47	239.5	91.67	239.5	90.09	233.5	87.50	217.8	83.60
	-11.8	-13	249.7	95.87	248.3	91.68	247.2	88.96	241.2	87.33	234.6	84.85	217.8	80.98
	-9.8	-11	257.8	92.72	257.8	88.75	249.0	86.13	242.4	84.43	234.6	82.02	217.8	78.22
	-9.5	-10	259.6	92.23	259.6	88.29	249.6	85.70	242.4	84.00	234.6	81.59	217.8	77.79
	-8.5	-9.1	265.6	90.66	263.8	86.82	250.1	84.27	242.4	82.57	234.6	80.19	217.8	76.43
	-7.0	-7.6	279.2	88.27	265.6	84.61	250.1	82.16	242.4	80.39	234.6	78.08	217.8	74.35
	-5.0	-5.6	282.2	85.09	265.6	81.68	250.1	79.33	242.4	77.52	234.6	75.28	217.8	71.61
	-3.0	-3.7	282.2	81.92	265.6	78.75	250.1	76.48	242.4	74.62	234.6	72.45	217.8	68.85
	0.0	-0.7	282.2	77.17	265.6	74.32	250.1	72.22	242.4	70.29	234.6	68.22	217.8	64.72
	3.0	2.2	282.2	72.40	265.6	69.89	250.1	67.97	242.4	65.96	234.6	64.02	217.8	60.56
	5.0	4.1	282.2	69.22	265.6	66.96	250.1	65.14	242.4	63.06	234.6	61.19	217.8	57.80
	7.0	6.0	282.2	66.05	265.6	64.03	250.1	62.31	242.4	60.19	234.6	58.40	217.8	55.07
	9.0	7.9	282.2	63.04	265.6	61.10	250.1	59.45	242.4	57.44	234.6	55.72	217.8	52.56
	11.0	9.8	282.2	60.04	265.6	58.20	250.1	56.63	242.4	54.69	234.6	53.07	217.8	50.03
	13.0	11.8	282.2	57.03	265.6	55.27	250.1	53.80	242.4	51.96	234.6	50.42	217.8	47.52
15.0	13.7	282.2	54.03	265.6	52.37	250.1	50.94	242.4	49.21	234.6	47.74	217.8	45.02	
80	-24.8	-25	160.9	81.03	160.9	82.84	159.8	84.10	159.8	84.70	159.8	87.69	157.4	84.06
	-21.8	-22	196.7	82.84	196.7	84.62	196.7	85.88	196.7	87.69	196.7	84.06	192.8	80.54
	-19.8	-20	209.0	84.02	209.0	85.83	209.0	87.69	209.0	85.14	206.9	81.62	194.6	78.21
	-18.8	-19	213.8	84.62	213.8	87.69	213.8	86.40	213.8	83.85	207.8	80.40	194.6	77.05
	-16.7	-17	221.6	87.69	221.6	85.00	221.6	83.68	216.2	81.16	209.3	77.89	194.6	74.61
	-13.7	-15	233.9	83.72	229.2	81.14	223.7	79.81	217.0	77.32	209.3	74.23	194.6	71.09
	-11.8	-13	239.5	81.19	232.5	78.71	223.7	77.34	217.0	74.89	209.3	71.93	194.6	68.87
	-9.8	-11	245.4	78.54	235.6	76.17	223.7	74.76	217.0	72.34	209.3	69.49	194.6	66.53
	-9.5	-10	247.2	78.15	237.1	75.77	223.7	74.36	217.0	71.94	209.3	69.13	194.6	66.20
	-8.5	-9.1	249.9	76.82	238.3	74.49	223.7	73.07	217.0	70.66	209.3	67.94	194.6	65.02
	-7.0	-7.6	252.7	74.82	238.3	72.56	223.7	71.14	217.0	68.75	209.3	66.12	194.6	63.26
	-5.0	-5.6	252.7	72.18	238.3	70.01	223.7	68.53	217.0	66.17	209.3	63.68	194.6	60.92
	-3.0	-3.7	252.7	69.53	238.3	67.44	223.7	65.95	217.0	63.62	209.3	61.27	194.6	58.59
	0.0	-0.7	252.7	65.53	238.3	63.61	223.7	62.08	217.0	59.79	209.3	57.61	194.6	55.10
	3.0	2.2	252.7	61.56	238.3	59.75	223.7	58.18	217.0	55.92	209.3	53.99	194.6	51.58
	5.0	4.1	252.7	58.92	238.3	57.20	223.7	55.60	217.0	53.37	209.3	51.55	194.6	49.25
	7.0	6.0	252.7	56.27	238.3	54.63	223.7	53.02	217.0	50.82	209.3	49.14	194.6	46.91
	9.0	7.9	252.7	52.83	238.3	51.30	223.7	49.77	217.0	47.71	209.3	46.14	194.6	44.05
	11.0	9.8	252.7	49.03	238.3	47.60	223.7	46.21	217.0	44.27	209.3	42.81	194.6	40.87
	13.0	11.8	252.7	45.77	238.3	44.42	223.7	43.14	217.0	41.34	209.3	39.96	194.6	38.16
15.0	13.7	252.7	43.07	238.3	41.82	223.7	40.58	217.0	38.90	209.3	37.62	194.6	35.93	

# 7. Capacity Tables

Heating Capacity (88HP)

Combination (%)	Outdoor air temp.		Indoor air temp. °C DB											
			16		18		20		21		22		24	
	°C DB	°C WB	TC	PI	TC	PI	TC	PI	TC	PI	TC	PI	TC	PI
70	-24.8	-25	160.9	81.84	160.9	82.44	159.8	83.65	159.8	85.46	159.8	81.48	157.4	77.76
	-21.8	-22	190.4	83.65	190.7	84.25	189.5	85.46	183.9	81.48	178.4	77.76	166.6	74.17
	-19.8	-20	208.1	84.85	201.2	85.46	190.5	82.67	183.9	78.84	178.4	75.29	166.6	71.77
	-18.8	-19	212.0	85.46	202.1	84.03	190.5	81.28	183.9	77.51	178.4	74.04	166.6	70.55
	-16.7	-17	214.1	82.47	202.3	81.00	190.5	78.38	183.9	74.72	178.4	71.45	166.6	68.04
	-13.7	-15	214.4	78.25	202.3	76.71	190.5	74.20	183.9	70.78	178.4	67.73	166.6	64.42
	-11.8	-13	214.4	75.54	202.3	73.99	190.5	71.55	183.9	68.24	178.4	65.37	166.6	62.15
	-9.8	-11	214.4	72.72	202.3	71.10	190.5	68.79	183.9	65.59	178.4	62.89	166.6	59.75
	-9.5	-10	214.4	72.30	202.3	70.67	190.5	68.37	183.9	65.20	178.4	62.53	166.6	59.39
	-8.5	-9.1	214.4	70.90	202.3	69.24	190.5	66.97	183.9	63.88	178.4	61.28	166.6	58.17
	-7.0	-7.6	214.4	68.76	202.3	67.10	190.5	64.90	183.9	61.90	178.4	59.42	166.6	56.38
	-5.0	-5.6	214.4	65.94	202.3	64.24	190.5	62.11	183.9	59.26	178.4	56.95	166.6	53.98
	-3.0	-3.7	214.4	63.12	202.3	61.35	190.5	59.32	183.9	56.61	178.4	54.47	166.6	51.57
	0.0	-0.7	214.4	58.88	202.3	57.06	190.5	55.17	183.9	52.63	178.4	50.75	166.6	47.98
	3.0	2.2	214.4	54.63	202.3	52.77	190.5	50.99	183.9	48.69	178.4	47.02	166.6	44.36
	5.0	4.1	214.4	51.81	202.3	49.88	190.5	48.23	183.9	46.04	178.4	44.55	166.6	41.96
	7.0	6.0	214.4	48.99	202.3	47.02	190.5	45.45	183.9	43.39	178.4	42.08	166.6	39.56
	9.0	7.9	214.4	44.24	202.3	42.45	190.5	41.05	183.9	39.19	178.4	38.01	166.6	35.71
	11.0	9.8	214.4	41.20	202.3	39.52	190.5	38.20	183.9	36.48	178.4	35.38	166.6	33.26
	13.0	11.8	214.4	38.53	202.3	36.99	190.5	35.75	183.9	34.14	178.4	33.11	166.6	31.14
15.0	13.7	214.4	36.33	202.3	34.87	190.5	33.70	183.9	32.17	178.4	31.21	166.6	29.34	
60	-24.8	-25	160.9	80.63	160.9	81.84	159.8	83.65	156.5	79.41	152.0	75.45	142.7	71.70
	-21.8	-22	174.6	82.44	174.0	83.65	163.3	79.41	157.8	75.45	152.3	71.70	142.7	68.09
	-19.8	-20	183.9	83.65	174.0	80.66	163.3	76.59	157.8	72.81	152.3	69.20	142.7	65.66
	-18.8	-19	183.9	82.15	174.0	79.16	163.3	75.17	157.8	71.46	152.3	67.95	142.7	64.44
	-16.7	-17	183.9	78.99	174.0	76.03	163.3	72.21	157.8	68.67	152.3	65.34	142.7	61.90
	-13.7	-15	183.9	74.48	174.0	71.58	163.3	68.00	157.8	64.71	152.3	61.60	142.7	58.29
	-11.8	-13	183.9	71.64	174.0	68.73	163.3	65.30	157.8	62.18	152.3	59.24	142.7	56.00
	-9.8	-11	183.9	68.65	174.0	65.75	163.3	62.48	157.8	59.54	152.3	56.74	142.7	53.57
	-9.5	-10	183.9	68.19	174.0	65.32	163.3	62.06	157.8	59.15	152.3	56.35	142.7	53.21
	-8.5	-9.1	183.9	66.70	174.0	63.82	163.3	60.66	157.8	57.83	152.3	55.10	142.7	52.00
	-7.0	-7.6	183.9	64.46	174.0	61.58	163.3	58.56	157.8	55.83	152.3	53.24	142.7	50.18
	-5.0	-5.6	183.9	61.45	174.0	58.59	163.3	55.71	157.8	53.19	152.3	50.74	142.7	47.78
	-3.0	-3.7	183.9	58.46	174.0	55.60	163.3	52.90	157.8	50.55	152.3	48.25	142.7	45.35
	0.0	-0.7	183.9	53.95	174.0	51.15	163.3	48.69	157.8	46.56	152.3	44.50	142.7	41.73
	3.0	2.2	183.9	49.44	174.0	46.67	163.3	44.45	157.8	42.60	152.3	40.78	142.7	38.09
	5.0	4.1	183.9	46.45	174.0	43.68	163.3	41.64	157.8	39.96	152.3	38.28	142.7	35.69
	7.0	6.0	183.9	43.47	174.0	40.69	163.3	38.82	157.8	37.29	152.3	35.78	142.7	33.26
	9.0	7.9	183.9	38.78	174.0	36.33	163.3	34.62	157.8	33.26	152.3	31.91	142.7	29.68
	11.0	9.8	183.9	36.19	174.0	33.92	163.3	32.34	157.8	31.07	152.3	29.82	142.7	27.70
	13.0	11.8	183.9	33.92	174.0	31.76	163.3	30.30	157.8	29.09	152.3	27.92	142.7	25.98
15.0	13.7	183.9	32.05	174.0	30.04	163.3	28.62	157.8	27.51	152.3	26.38	142.7	24.55	
50	-24.8	-25	153.4	71.00	144.6	72.81	136.1	69.03	131.7	65.50	127.3	62.14	118.5	59.04
	-21.8	-22	153.4	72.81	144.6	69.03	136.1	65.50	131.7	62.14	127.3	59.04	118.5	56.04
	-19.8	-20	153.4	70.18	144.6	66.51	136.1	63.15	131.7	59.91	127.3	56.95	118.5	54.02
	-18.8	-19	153.4	68.86	144.6	65.25	136.1	61.97	131.7	58.82	127.3	55.90	118.5	53.01
	-16.7	-17	153.4	66.12	144.6	62.62	136.1	59.51	131.7	56.48	127.3	53.74	118.5	50.91
	-13.7	-15	153.4	62.19	144.6	58.84	136.1	55.98	131.7	53.12	127.3	50.63	118.5	47.91
	-11.8	-13	153.4	59.71	144.6	56.46	136.1	53.74	131.7	51.00	127.3	48.65	118.5	46.00
	-9.8	-11	153.4	57.08	144.6	53.94	136.1	51.37	131.7	48.76	127.3	46.56	118.5	43.98
	-9.5	-10	153.4	56.69	144.6	53.57	136.1	51.04	131.7	48.44	127.3	46.26	118.5	43.69
	-8.5	-9.1	153.4	55.36	144.6	52.31	136.1	49.85	131.7	47.32	127.3	45.22	118.5	42.68
	-7.0	-7.6	153.4	53.41	144.6	50.44	136.1	48.09	131.7	45.66	127.3	43.67	118.5	41.20
	-5.0	-5.6	153.4	50.78	144.6	47.92	136.1	45.74	131.7	43.42	127.3	41.57	118.5	39.18
	-3.0	-3.7	153.4	48.16	144.6	45.40	136.1	43.37	131.7	41.19	127.3	39.48	118.5	37.19
	0.0	-0.7	153.4	44.23	144.6	41.61	136.1	39.84	131.7	37.83	127.3	36.38	118.5	34.16
	3.0	2.2	153.4	40.31	144.6	37.86	136.1	36.33	131.7	34.48	127.3	33.27	118.5	31.16
	5.0	4.1	153.4	37.68	144.6	35.34	136.1	33.96	131.7	32.27	127.3	31.18	118.5	29.17
	7.0	6.0	153.4	35.05	144.6	32.82	136.1	31.61	131.7	30.04	127.3	29.09	118.5	27.15
	9.0	7.9	153.4	31.65	144.6	29.64	136.1	28.54	131.7	27.11	127.3	26.27	118.5	24.52
	11.0	9.8	153.4	29.60	144.6	27.74	136.1	26.71	131.7	25.39	127.3	24.59	118.5	22.94
	13.0	11.8	153.4	27.81	144.6	26.05	136.1	25.07	131.7	23.82	127.3	23.09	118.5	21.55
15.0	13.7	153.4	26.31	144.6	24.63	136.1	23.74	131.7	22.54	127.3	21.84	118.5	20.38	

**Note**

1. TC: Total Capacity(kW), PI: Power Input(kW, Comp. + Outdoor fan motor)
2. Capacity tables show the average value of conditions which may occur.
3. The heating capacity table is based on the values expressed as Max. in the specification of the outdoor unit. (When measuring the Max. heating capacity, the setting status of the indoor unit is the same as that for measuring the heating capacity of the indoor unit.)

# 7. Capacity Tables

## ◆ ARUM900LTE5

Heating Capacity (90HP)

Combination (%)	Outdoor air temp.		Indoor air temp. °C DB											
			16		18		20		21		22		24	
	°C DB	°C WB	TC	PI	TC	PI	TC	PI	TC	PI	TC	PI	TC	PI
130	-24.8	-25	173.5	94.8	173.5	95.52	172.3	96.16	172.3	97.12	172.3	98.08	169.2	99.57
	-21.8	-22	212.2	96.24	212.2	96.98	210.7	97.62	210.7	98.61	210.7	99.57	206.6	101.0
	-19.8	-20	224.3	97.23	224.3	97.97	222.8	98.61	222.8	99.61	222.8	100.5	218.6	102.0
	-18.8	-19	229.4	97.72	229.4	98.47	227.9	99.11	227.9	100.1	227.9	101.0	223.4	102.5
	-16.7	-17	239.7	98.76	239.7	99.50	238.1	100.1	238.1	101.1	238.1	102.1	233.6	103.6
	-13.7	-15	254.4	100.2	254.4	101.0	252.8	101.6	252.8	102.6	252.8	103.6	248.0	99.70
	-11.8	-13	262.6	101.2	262.6	101.9	261.1	102.6	261.1	103.6	261.1	104.6	257.1	97.25
	-9.8	-11	271.3	102.2	271.3	102.9	269.8	103.6	269.8	104.6	269.8	105.6	266.7	94.69
	-9.5	-10	272.8	102.3	272.8	103.1	271.3	103.1	271.3	104.1	270.9	105.1	268.2	94.28
	-8.5	-9.1	278.1	102.8	278.1	103.6	276.6	104.1	276.6	105.1	275.4	106.1	272.9	93.00
	-7.0	-7.6	286.0	103.6	286.0	104.5	284.2	105.2	284.2	106.2	284.2	107.2	280.0	91.07
	-5.0	-5.6	296.6	104.9	296.6	105.8	294.7	106.5	294.7	107.5	294.7	108.5	289.5	88.51
	-3.0	-3.7	307.1	106.2	307.1	106.7	305.2	107.2	305.2	108.2	305.2	109.2	299.1	85.92
	0.0	-0.7	322.9	107.6	322.9	107.2	320.7	107.8	320.7	108.8	320.7	109.8	313.7	82.07
	3.0	2.2	338.8	108.0	338.8	107.8	336.5	108.4	336.5	109.4	336.5	110.4	315.7	78.22
	5.0	4.1	349.0	107.2	349.0	107.0	347.1	107.6	347.1	108.6	347.1	109.6	315.7	75.63
	7.0	6.0	359.6	106.0	359.6	106.3	357.3	106.9	357.3	107.9	357.3	108.9	315.7	73.07
	9.0	7.9	361.3	105.3	361.3	106.2	360.2	106.8	360.2	107.8	360.2	108.8	315.7	71.20
	11.0	9.8	361.3	104.6	361.3	106.1	360.2	106.7	360.2	107.7	360.2	108.7	315.7	69.96
	13.0	11.8	361.3	103.9	361.3	106.0	360.2	106.6	360.2	107.6	360.2	108.6	315.7	68.63
15.0	13.7	361.3	103.2	361.3	105.9	360.2	106.5	360.2	107.5	360.2	108.5	315.7	67.19	
120	-24.8	-25	172.3	95.52	172.3	96.16	171.2	97.12	171.2	98.08	171.2	99.57	168.1	100.6
	-21.8	-22	210.7	96.98	210.7	97.62	209.2	98.61	209.2	99.57	209.2	101.0	205.4	102.1
	-19.8	-20	222.7	97.97	222.7	98.61	221.2	99.61	221.2	100.5	221.2	102.0	217.1	103.1
	-18.8	-19	227.5	98.47	227.5	99.11	226.0	100.1	226.0	101.0	226.0	102.5	221.9	103.6
	-16.7	-17	237.8	99.50	237.8	100.1	236.3	101.1	236.3	102.1	236.3	103.6	231.8	101.1
	-13.7	-15	252.5	101.0	252.5	101.6	251.0	102.6	251.0	103.6	251.0	104.6	246.1	97.52
	-11.8	-13	260.8	101.9	260.8	102.6	259.2	103.6	259.2	104.6	259.2	105.6	255.3	95.29
	-9.8	-11	269.4	102.9	269.4	103.6	267.9	104.6	267.9	105.6	267.9	106.6	264.8	92.92
	-9.5	-10	270.9	103.1	270.9	103.1	269.4	103.3	269.4	104.3	269.4	105.3	266.3	92.55
	-8.5	-9.1	276.2	103.6	276.2	104.1	274.4	104.6	274.4	105.6	274.4	106.6	270.8	91.38
	-7.0	-7.6	284.1	104.3	284.1	104.9	282.2	105.6	282.2	106.6	282.2	107.6	278.1	89.60
	-5.0	-5.6	294.6	105.8	294.6	106.7	292.8	107.4	292.8	108.4	292.8	109.4	287.6	87.23
	-3.0	-3.7	304.9	107.2	304.9	108.1	303.0	109.0	303.0	110.0	303.0	111.0	295.7	84.86
	0.0	-0.7	320.7	108.6	320.7	108.2	318.5	108.8	318.5	109.8	318.5	110.8	296.5	81.32
	3.0	2.2	336.2	108.0	336.2	108.4	334.2	109.0	334.2	109.8	334.2	110.8	296.5	77.77
	5.0	4.1	346.7	107.2	346.7	108.1	340.6	108.7	340.6	109.7	340.6	110.7	296.5	75.40
	7.0	6.0	357.2	106.0	357.2	108.0	350.6	108.6	350.6	109.6	350.6	110.6	296.5	73.03
	9.0	7.9	358.6	105.3	358.6	107.9	354.6	108.5	354.6	109.5	354.6	110.5	296.5	70.99
	11.0	9.8	358.6	104.6	358.6	107.8	350.6	108.4	350.6	109.4	350.6	110.4	296.5	69.57
	13.0	11.8	358.6	103.9	358.6	107.7	350.6	108.3	350.6	109.3	350.6	110.3	296.5	68.07
15.0	13.7	358.6	103.2	358.6	107.6	350.6	108.2	350.6	109.2	350.6	110.2	296.5	66.42	
110	-24.8	-25	171.5	96.16	171.5	97.12	170.4	98.08	170.4	99.57	170.4	100.6	167.0	101.1
	-21.8	-22	209.6	97.62	209.6	98.61	208.1	99.57	208.1	101.0	208.1	102.1	204.3	102.6
	-19.8	-20	221.6	98.61	221.6	99.61	220.1	100.5	220.1	102.0	220.1	103.1	215.9	103.6
	-18.8	-19	226.4	99.11	226.4	100.1	224.9	101.0	224.9	102.5	224.9	103.6	220.7	102.2
	-16.7	-17	236.6	100.1	236.6	101.1	235.1	102.1	235.1	103.6	235.1	104.6	230.6	99.46
	-13.7	-15	251.0	101.6	251.0	102.6	249.5	103.6	249.5	104.6	249.5	105.6	249.5	95.52
	-11.8	-13	259.3	102.6	259.3	103.6	257.7	104.6	257.7	105.6	257.7	106.6	257.7	93.01
	-9.8	-11	267.9	103.6	267.9	104.6	266.4	105.6	266.4	106.6	266.4	107.6	264.8	90.39
	-9.5	-10	269.4	103.8	269.4	104.8	267.9	105.8	267.9	106.8	267.9	107.8	266.8	90.01
	-8.5	-9.1	274.7	104.3	274.7	105.3	273.2	106.3	273.2	107.3	273.2	108.3	266.8	88.66
	-7.0	-7.6	282.6	105.3	282.6	106.3	280.7	107.3	280.7	108.3	280.7	109.3	266.8	86.71
	-5.0	-5.6	292.8	106.8	292.8	107.8	290.9	108.4	290.9	109.4	290.9	110.4	266.8	84.05
	-3.0	-3.7	303.3	108.2	303.3	109.2	301.5	109.8	301.5	110.8	301.5	111.8	266.8	81.43
	0.0	-0.7	318.8	109.6	318.8	110.2	306.6	110.8	306.6	111.8	306.6	112.8	266.8	77.49
	3.0	2.2	334.3	111.0	334.3	111.6	306.6	112.2	306.6	113.2	306.6	114.2	266.8	73.52
	5.0	4.1	344.7	110.4	344.7	112.0	306.6	113.0	306.6	114.0	306.6	115.0	266.8	70.89
	7.0	6.0	344.7	111.6	344.7	112.9	306.6	113.9	306.6	114.9	306.6	115.9	266.8	68.27
	9.0	7.9	344.7	112.8	344.7	113.8	306.6	114.8	306.6	115.8	306.6	116.8	266.8	66.06
	11.0	9.8	344.7	114.0	344.7	114.7	306.6	115.7	306.6	116.7	306.6	117.7	266.8	64.43
	13.0	11.8	344.7	115.2	344.7	115.6	306.6	116.6	306.6	117.6	306.6	118.6	266.8	62.69
15.0	13.7	344.7	116.4	344.7	116.5	306.6	117.5	306.6	118.5	306.6	119.5	266.8	60.80	



# 7. Capacity Tables

Heating Capacity (90HP)

Combination (%)	Outdoor air temp.		Indoor air temp. °C DB											
			16		18		20		21		22		24	
	°C DB	°C WB	TC	PI	TC	PI	TC	PI	TC	PI	TC	PI	TC	PI
100	-24.8	-25	170.7	105.5	170.7	105.2	169.6	98.65	169.6	104.6	169.6	104.3	166.2	104.2
	-21.8	-22	208.5	105.1	208.5	104.8	207.3	101.8	207.3	104.2	207.3	105.2	203.2	103.8
	-19.8	-20	220.5	104.8	220.5	104.6	219.3	103.7	219.3	104.0	219.3	104.1	215.2	103.6
	-18.8	-19	225.3	104.7	224.1	104.5	224.1	104.2	224.1	103.8	224.1	103.6	219.6	101.9
	-16.7	-17	234.0	104.5	234.0	104.2	234.0	105.2	232.9	103.6	232.9	100.2	228.4	98.55
	-13.7	-15	249.9	104.1	249.9	103.8	248.4	103.6	248.4	98.72	248.4	95.45	243.8	93.67
	-11.8	-13	258.1	103.8	256.6	103.6	256.6	100.3	256.6	95.65	256.6	92.42	243.8	90.61
	-9.8	-11	266.4	103.6	266.4	99.94	265.3	96.91	265.3	92.44	261.6	89.25	243.8	87.37
	-9.5	-10	267.9	103.0	267.9	99.38	266.8	96.42	266.8	91.95	261.6	88.77	243.8	86.88
	-8.5	-9.1	273.2	101.1	273.2	97.58	272.0	94.70	270.6	90.34	261.6	87.19	243.8	85.25
	-7.0	-7.6	285.6	98.27	284.5	94.87	279.6	92.15	270.6	87.95	261.6	84.81	243.8	82.82
	-5.0	-5.6	298.1	94.48	295.1	91.27	279.6	88.77	270.6	84.70	261.6	81.63	243.8	79.58
	-3.0	-3.7	306.7	90.71	297.6	87.63	279.6	85.36	270.6	81.48	261.6	78.46	243.8	76.34
	0.0	-0.7	315.4	85.04	297.6	82.22	279.6	80.26	270.6	76.65	261.6	73.68	243.8	71.49
	3.0	2.2	315.4	79.36	297.6	76.78	279.6	75.16	270.6	71.83	261.6	68.91	243.8	66.64
	5.0	4.1	315.4	75.59	297.6	73.18	279.6	71.75	270.6	68.61	261.6	65.73	243.8	63.40
	7.0	6.0	315.4	71.80	297.6	69.54	279.6	68.34	270.6	65.39	261.6	62.56	243.8	60.16
	9.0	7.9	315.4	69.02	297.6	66.85	279.6	65.69	270.6	62.86	261.6	60.15	243.8	57.83
	11.0	9.8	315.4	66.82	297.6	64.73	279.6	63.61	270.6	60.84	261.6	58.20	243.8	56.00
	13.0	11.8	315.4	64.50	297.6	62.45	279.6	61.37	270.6	58.72	261.6	56.17	243.8	54.02
15.0	13.7	315.4	62.02	297.6	60.06	279.6	59.02	270.6	56.45	261.6	54.02	243.8	51.95	
90	-24.8	-25	170.0	94.31	170.0	95.77	168.9	96.83	168.9	97.30	168.9	98.29	165.8	99.78
	-21.8	-22	207.7	95.77	207.7	97.26	206.5	98.29	206.5	98.79	206.5	99.78	202.4	95.53
	-19.8	-20	219.7	96.76	219.7	98.25	218.2	99.28	218.2	99.78	218.2	96.86	214.1	92.69
	-18.8	-19	225.3	97.26	224.1	98.75	223.0	99.78	223.0	98.30	223.0	95.42	218.8	91.29
	-16.7	-17	234.0	98.29	234.0	99.78	233.2	96.70	233.2	95.15	233.2	92.39	222.8	88.30
	-13.7	-15	249.9	99.78	249.9	95.19	247.6	92.30	247.6	90.68	240.1	88.03	222.8	84.05
	-11.8	-13	258.1	96.63	256.6	92.29	255.5	89.49	248.0	87.83	240.1	85.29	222.8	81.36
	-9.8	-11	266.4	93.36	266.4	89.25	255.9	86.56	248.0	84.84	240.1	82.37	222.8	78.52
	-9.5	-10	267.9	92.84	267.9	88.78	255.9	86.12	248.0	84.40	240.1	81.93	222.8	78.08
	-8.5	-9.1	273.2	91.21	271.3	87.26	255.9	84.64	248.0	82.91	240.1	80.49	222.8	76.67
	-7.0	-7.6	285.6	88.72	271.7	84.96	255.9	82.45	248.0	80.66	240.1	78.31	222.8	74.53
	-5.0	-5.6	288.7	85.42	271.7	81.92	255.9	79.53	248.0	77.70	240.1	75.42	222.8	71.72
	-3.0	-3.7	288.7	82.12	271.7	78.88	255.9	76.57	248.0	74.70	240.1	72.50	222.8	68.88
	0.0	-0.7	288.7	77.18	271.7	74.29	255.9	72.16	248.0	70.23	240.1	68.15	222.8	64.63
	3.0	2.2	288.7	72.22	271.7	69.69	255.9	67.76	248.0	65.75	240.1	63.82	222.8	60.36
	5.0	4.1	288.7	68.92	271.7	66.65	255.9	64.83	248.0	62.76	240.1	60.90	222.8	57.52
	7.0	6.0	288.7	65.61	271.7	63.61	255.9	61.90	248.0	59.79	240.1	58.01	222.8	54.71
	9.0	7.9	288.7	62.50	271.7	60.58	255.9	58.95	248.0	56.95	240.1	55.24	222.8	52.11
	11.0	9.8	288.7	59.39	271.7	57.58	255.9	56.02	248.0	54.10	240.1	52.50	222.8	49.49
	13.0	11.8	288.7	56.28	271.7	54.54	255.9	53.09	248.0	51.28	240.1	49.76	222.8	46.90
15.0	13.7	288.7	53.17	271.7	51.54	255.9	50.14	248.0	48.43	240.1	46.99	222.8	44.31	
80	-24.8	-25	169.2	83.00	169.2	84.49	168.1	85.52	168.1	86.02	168.1	88.47	165.0	84.74
	-21.8	-22	205.5	84.49	205.5	85.95	205.5	86.98	205.5	88.47	205.5	84.74	199.1	81.13
	-19.8	-20	217.4	85.45	217.4	86.94	217.4	88.47	217.4	85.84	214.1	82.23	199.1	78.73
	-18.8	-19	222.2	85.95	222.2	88.47	222.2	87.14	221.7	84.52	214.1	80.98	199.1	77.55
	-16.7	-17	228.8	88.47	228.8	85.69	228.8	84.33	222.0	81.75	214.1	78.39	199.1	75.04
	-13.7	-15	239.3	84.36	234.5	81.70	228.8	80.33	222.0	77.79	214.1	74.63	199.1	71.43
	-11.8	-13	245.4	81.73	238.2	79.18	228.8	77.78	222.0	75.28	214.1	72.26	199.1	69.14
	-9.8	-11	251.8	78.99	241.4	76.55	228.8	75.12	222.0	72.65	214.1	69.75	199.1	66.74
	-9.5	-10	253.6	78.58	242.9	76.14	228.8	74.71	222.0	72.25	214.1	69.38	199.1	66.41
	-8.5	-9.1	256.1	77.21	243.8	74.81	228.8	73.38	222.0	70.92	214.1	68.16	199.1	65.19
	-7.0	-7.6	258.5	75.13	243.8	72.82	228.8	71.38	222.0	68.96	214.1	66.28	199.1	63.39
	-5.0	-5.6	258.5	72.39	243.8	70.18	228.8	68.69	222.0	66.30	214.1	63.77	199.1	60.99
	-3.0	-3.7	258.5	69.65	243.8	67.52	228.8	66.02	222.0	63.68	214.1	61.30	199.1	58.59
	0.0	-0.7	258.5	65.50	243.8	63.56	228.8	62.03	222.0	59.72	214.1	57.53	199.1	55.01
	3.0	2.2	258.5	61.39	243.8	59.57	228.8	58.00	222.0	55.74	214.1	53.80	199.1	51.40
	5.0	4.1	258.5	58.65	243.8	56.93	228.8	55.34	222.0	53.11	214.1	51.30	199.1	49.00
	7.0	6.0	258.5	55.90	243.8	54.27	228.8	52.67	222.0	50.49	214.1	48.82	199.1	46.60
	9.0	7.9	258.5	52.49	243.8	50.96	228.8	49.44	222.0	47.40	214.1	45.84	199.1	43.77
	11.0	9.8	258.5	48.71	243.8	47.29	228.8	45.91	222.0	43.98	214.1	42.53	199.1	40.61
	13.0	11.8	258.5	45.47	243.8	44.13	228.8	42.86	222.0	41.07	214.1	39.70	199.1	37.91
15.0	13.7	258.5	42.79	243.8	41.55	228.8	40.32	222.0	38.64	214.1	37.37	199.1	35.70	

## 7. Capacity Tables

Heating Capacity (90HP)

Combination (%)	Outdoor air temp.		Indoor air temp. °C DB											
			16		18		20		21		22		24	
	°C DB	°C WB	TC	PI	TC	PI	TC	PI	TC	PI	TC	PI	TC	PI
70	-24.8	-25	169.2	83.44	169.2	83.93	168.1	84.93	168.1	86.42	168.1	82.33	164.1	78.50
	-21.8	-22	196.1	84.93	196.1	85.42	194.9	86.42	188.2	82.33	182.5	78.50	170.4	74.81
	-19.8	-20	213.9	85.92	207.0	86.42	194.9	83.54	188.2	79.60	182.5	75.95	170.4	72.35
	-18.8	-19	218.1	86.42	207.0	84.94	194.9	82.10	188.2	78.24	182.5	74.67	170.4	71.10
	-16.7	-17	219.4	83.32	207.0	81.81	194.9	79.11	188.2	75.36	182.5	72.01	170.4	68.52
	-13.7	-15	219.4	78.96	207.0	77.38	194.9	74.80	188.2	71.30	182.5	68.18	170.4	64.81
	-11.8	-13	219.4	76.15	207.0	74.57	194.9	72.07	188.2	68.69	182.5	65.75	170.4	62.48
	-9.8	-11	219.4	73.24	207.0	71.59	194.9	69.23	188.2	65.97	182.5	63.21	170.4	60.02
	-9.5	-10	219.4	72.79	207.0	71.14	194.9	68.79	188.2	65.56	182.5	62.84	170.4	59.65
	-8.5	-9.1	219.4	71.35	207.0	69.67	194.9	67.35	188.2	64.20	182.5	61.55	170.4	58.40
	-7.0	-7.6	219.4	69.14	207.0	67.45	194.9	65.21	188.2	62.17	182.5	59.64	170.4	56.56
	-5.0	-5.6	219.4	66.22	207.0	64.50	194.9	62.34	188.2	59.44	182.5	57.09	170.4	54.09
	-3.0	-3.7	219.4	63.30	207.0	61.51	194.9	59.46	188.2	56.71	182.5	54.55	170.4	51.63
	0.0	-0.7	219.4	58.90	207.0	57.08	194.9	55.18	188.2	52.62	182.5	50.72	170.4	47.94
	3.0	2.2	219.4	54.51	207.0	52.65	194.9	50.87	188.2	48.56	182.5	46.89	170.4	44.23
	5.0	4.1	219.4	51.59	207.0	49.67	194.9	48.02	188.2	45.84	182.5	44.35	170.4	41.76
	7.0	6.0	219.4	48.67	207.0	46.71	194.9	45.15	188.2	43.11	182.5	41.80	170.4	39.30
	9.0	7.9	219.4	43.95	207.0	42.17	194.9	40.78	188.2	38.93	182.5	37.77	170.4	35.48
	11.0	9.8	219.4	40.93	207.0	39.26	194.9	37.95	188.2	36.24	182.5	35.15	170.4	33.04
	13.0	11.8	219.4	38.28	207.0	36.75	194.9	35.52	188.2	33.91	182.5	32.90	170.4	30.93
15.0	13.7	219.4	36.10	207.0	34.64	194.9	33.48	188.2	31.96	182.5	31.01	170.4	29.15	
60	-24.8	-25	167.0	82.44	167.0	83.44	165.9	84.93	161.4	80.54	155.8	76.45	146.0	72.59
	-21.8	-22	179.6	83.93	178.0	84.93	167.1	80.54	161.4	76.45	155.8	72.59	146.0	68.87
	-19.8	-20	188.2	84.93	178.0	81.83	167.1	77.63	161.4	73.72	155.8	70.01	146.0	66.37
	-18.8	-19	188.2	83.38	178.0	80.28	167.1	76.16	161.4	72.33	155.8	68.72	146.0	65.12
	-16.7	-17	188.2	80.09	178.0	77.04	167.1	73.10	161.4	69.46	155.8	66.03	146.0	62.51
	-13.7	-15	188.2	75.41	178.0	72.42	167.1	68.75	161.4	65.37	155.8	62.17	146.0	58.79
	-11.8	-13	188.2	72.45	178.0	69.48	167.1	65.95	161.4	62.75	155.8	59.74	146.0	56.44
	-9.8	-11	188.2	69.35	178.0	66.38	167.1	63.04	161.4	60.03	155.8	57.16	146.0	53.94
	-9.5	-10	188.2	68.87	178.0	65.94	167.1	62.60	161.4	59.62	155.8	56.76	146.0	53.57
	-8.5	-9.1	188.2	67.32	178.0	64.39	167.1	61.16	161.4	58.26	155.8	55.47	146.0	52.32
	-7.0	-7.6	188.2	64.99	178.0	62.07	167.1	58.98	161.4	56.20	155.8	53.55	146.0	50.45
	-5.0	-5.6	188.2	61.86	178.0	58.97	167.1	56.04	161.4	53.47	155.8	50.98	146.0	47.98
	-3.0	-3.7	188.2	58.76	178.0	55.87	167.1	53.13	161.4	50.74	155.8	48.40	146.0	45.48
	0.0	-0.7	188.2	54.07	178.0	51.26	167.1	48.77	161.4	46.62	155.8	44.54	146.0	41.76
	3.0	2.2	188.2	49.39	178.0	46.62	167.1	44.39	161.4	42.53	155.8	40.70	146.0	38.01
	5.0	4.1	188.2	46.29	178.0	43.52	167.1	41.48	161.4	39.80	155.8	38.13	146.0	35.54
	7.0	6.0	188.2	43.18	178.0	40.43	167.1	38.57	161.4	37.04	155.8	35.55	146.0	33.04
	9.0	7.9	188.2	38.53	178.0	36.09	167.1	34.39	161.4	33.05	155.8	31.70	146.0	29.48
	11.0	9.8	188.2	35.95	178.0	33.70	167.1	32.13	161.4	30.86	155.8	29.62	146.0	27.52
	13.0	11.8	188.2	33.70	178.0	31.55	167.1	30.10	161.4	28.90	155.8	27.74	146.0	25.81
15.0	13.7	188.2	31.84	178.0	29.84	167.1	28.43	161.4	27.33	155.8	26.21	146.0	24.39	
50	-24.8	-25	156.9	71.97	147.9	73.46	139.2	69.60	134.7	65.99	130.2	62.57	121.2	59.41
	-21.8	-22	156.9	73.46	147.9	69.60	139.2	65.99	134.7	62.57	130.2	59.41	121.2	56.36
	-19.8	-20	156.9	70.77	147.9	67.02	139.2	63.60	134.7	60.29	130.2	57.28	121.2	54.30
	-18.8	-19	156.9	69.41	147.9	65.73	139.2	62.39	134.7	59.19	130.2	56.22	121.2	53.28
	-16.7	-17	156.9	66.61	147.9	63.05	139.2	59.88	134.7	56.80	130.2	54.01	121.2	51.14
	-13.7	-15	156.9	62.59	147.9	59.18	139.2	56.28	134.7	53.38	130.2	50.84	121.2	48.09
	-11.8	-13	156.9	60.05	147.9	56.75	139.2	53.99	134.7	51.21	130.2	48.82	121.2	46.15
	-9.8	-11	156.9	57.36	147.9	54.18	139.2	51.57	134.7	48.93	130.2	46.69	121.2	44.09
	-9.5	-10	156.9	56.96	147.9	53.81	139.2	51.23	134.7	48.60	130.2	46.39	121.2	43.80
	-8.5	-9.1	156.9	55.60	147.9	52.52	139.2	50.02	134.7	47.46	130.2	45.33	121.2	42.77
	-7.0	-7.6	156.9	53.61	147.9	50.60	139.2	48.22	134.7	45.76	130.2	43.75	121.2	41.26
	-5.0	-5.6	156.9	50.92	147.9	48.03	139.2	45.83	134.7	43.49	130.2	41.62	121.2	39.21
	-3.0	-3.7	156.9	48.23	147.9	45.45	139.2	43.40	134.7	41.21	130.2	39.49	121.2	37.18
	0.0	-0.7	156.9	44.22	147.9	41.59	139.2	39.80	134.7	37.79	130.2	36.32	121.2	34.10
	3.0	2.2	156.9	40.20	147.9	37.76	139.2	36.22	134.7	34.37	130.2	33.16	121.2	31.05
	5.0	4.1	156.9	37.51	147.9	35.18	139.2	33.80	134.7	32.12	130.2	31.03	121.2	29.03
	7.0	6.0	156.9	34.82	147.9	32.61	139.2	31.41	134.7	29.84	130.2	28.90	121.2	26.97
	9.0	7.9	156.9	31.44	147.9	29.44	139.2	28.36	134.7	26.94	130.2	26.10	121.2	24.36
	11.0	9.8	156.9	29.41	147.9	27.55	139.2	26.54	134.7	25.22	130.2	24.43	121.2	22.79
	13.0	11.8	156.9	27.63	147.9	25.88	139.2	24.90	134.7	23.67	130.2	22.94	121.2	21.41
15.0	13.7	156.9	26.14	147.9	24.47	139.2	23.59	134.7	22.39	130.2	21.70	121.2	20.25	

## Note

1. TC: Total Capacity(kW), PI: Power Input(kW, Comp. + Outdoor fan motor)
2. Capacity tables show the average value of conditions which may occur.
3. The heating capacity table is based on the values expressed as Max. in the specification of the outdoor unit. (When measuring the Max. heating capacity, the setting status of the indoor unit is the same as that for measuring the heating capacity of the indoor unit.)

# 7. Capacity Tables

## ◆ ARUM920LTE5

Heating Capacity (92HP)

Combination (%)	Outdoor air temp.		Indoor air temp. °C DB											
			16		18		20		21		22		24	
	°C DB	°C WB	TC	PI	TC	PI	TC	PI	TC	PI	TC	PI	TC	PI
130	-24.8	-25	175.7	98.4	175.7	99.08	174.5	99.68	174.5	100.6	174.5	101.5	171.4	102.9
	-21.8	-22	216.0	99.75	216.0	100.5	214.5	101.1	214.5	102.0	214.5	102.9	210.3	104.2
	-19.8	-20	228.9	100.7	228.9	101.4	227.3	102.0	227.3	102.9	227.3	103.8	223.1	105.2
	-18.8	-19	234.1	101.1	234.1	101.8	232.6	102.4	232.6	103.4	232.6	104.2	228.0	105.6
	-16.7	-17	244.8	102.1	244.8	102.8	243.3	103.4	243.3	104.3	243.3	105.2	238.7	106.6
	-13.7	-15	260.1	103.5	260.1	104.2	258.6	104.8	258.6	105.7	258.6	106.6	253.6	102.7
	-11.8	-13	268.6	104.4	268.6	105.1	267.0	105.7	267.0	106.6	267.0	104.0	263.1	100.3
	-9.8	-11	277.4	105.3	277.4	106.0	275.9	106.6	275.9	103.9	275.9	101.3	273.0	97.71
	-9.5	-10	279.0	105.5	279.0	106.1	277.4	106.2	277.4	103.5	277.1	100.9	274.5	97.30
	-8.5	-9.1	284.4	105.9	284.4	106.6	282.8	104.8	282.8	102.1	281.6	99.52	279.5	96.01
	-7.0	-7.6	292.5	106.6	292.5	104.6	290.6	102.7	290.6	100.0	290.6	97.45	286.8	94.08
	-5.0	-5.6	303.2	104.0	303.2	101.9	301.3	99.91	301.3	97.26	301.3	94.73	296.7	91.51
	-3.0	-3.7	314.0	101.5	314.0	99.18	312.1	97.11	312.1	94.50	312.1	92.00	306.6	88.90
	0.0	-0.7	330.1	97.56	330.1	95.14	327.9	92.94	327.9	90.38	327.9	87.92	321.8	85.04
	3.0	2.2	346.3	93.70	346.3	91.06	344.0	88.75	344.0	86.25	344.0	83.80	322.8	81.18
	5.0	4.1	356.8	91.10	356.8	88.37	354.8	85.95	354.8	83.50	346.7	81.07	322.8	78.58
	7.0	6.0	367.5	88.52	367.5	85.65	365.2	83.19	359.4	80.77	346.7	78.35	322.8	76.01
	9.0	7.9	369.4	86.40	369.4	83.61	368.3	81.19	359.4	78.84	346.7	76.49	322.8	74.19
	11.0	9.8	369.4	85.05	369.4	82.32	368.3	79.94	359.4	77.59	346.7	75.29	322.8	73.02
	13.0	11.8	369.4	83.60	369.4	80.89	368.3	78.54	359.4	76.27	346.7	74.00	322.8	71.77
15.0	13.7	369.4	82.02	369.4	79.37	368.3	77.06	359.4	74.80	346.7	72.60	322.8	70.41	
120	-24.8	-25	174.5	99.08	174.5	99.68	173.3	100.6	173.3	101.5	173.3	102.9	170.2	103.8
	-21.8	-22	214.5	100.5	214.5	101.1	213.0	102.0	213.0	102.9	213.0	104.2	209.1	105.2
	-19.8	-20	227.3	101.4	227.3	102.0	225.8	102.9	225.8	103.8	225.8	105.2	221.5	106.1
	-18.8	-19	232.3	101.8	232.3	102.4	230.8	103.4	230.8	104.2	230.8	105.6	226.5	106.6
	-16.7	-17	243.0	102.8	243.0	103.4	241.4	104.3	241.4	105.2	241.4	106.6	236.8	104.1
	-13.7	-15	258.2	104.2	258.2	104.8	256.7	105.7	256.7	106.6	256.7	102.9	251.7	100.6
	-11.8	-13	266.7	105.1	266.7	105.7	265.1	106.6	265.1	104.0	265.1	100.6	261.2	98.31
	-9.8	-11	275.5	106.0	275.5	106.6	273.9	103.7	273.9	101.2	273.9	98.09	271.1	95.93
	-9.5	-10	277.1	106.1	277.1	106.2	275.5	103.3	275.5	100.8	275.5	97.71	272.6	95.56
	-8.5	-9.1	282.4	106.6	282.4	104.6	280.6	101.9	280.6	99.45	280.6	96.50	277.3	94.38
	-7.0	-7.6	290.5	104.4	290.5	102.4	288.6	99.72	288.6	97.37	288.6	94.65	284.8	92.60
	-5.0	-5.6	301.3	101.4	301.3	99.34	299.3	96.84	299.3	94.61	299.3	92.16	294.8	90.22
	-3.0	-3.7	311.7	98.39	311.7	96.35	309.8	93.97	309.8	91.88	309.8	89.70	303.2	87.84
	0.0	-0.7	327.8	93.93	327.8	91.81	325.6	89.66	325.6	87.73	325.6	85.99	303.2	84.29
	3.0	2.2	343.7	89.46	343.7	87.27	341.7	85.35	336.7	83.61	326.3	82.29	303.2	80.73
	5.0	4.1	354.4	86.48	354.4	84.25	348.3	82.51	336.7	80.85	326.3	79.83	303.2	78.35
	7.0	6.0	365.2	83.49	362.8	81.22	348.3	79.63	336.7	78.09	326.3	77.37	303.2	75.97
	9.0	7.9	366.7	81.27	362.8	79.07	348.3	77.52	336.7	76.04	326.3	75.32	303.2	73.97
	11.0	9.8	366.7	79.79	362.8	77.63	348.3	76.08	336.7	74.64	326.3	73.93	303.2	72.61
	13.0	11.8	366.7	78.16	362.8	76.05	348.3	74.57	336.7	73.13	326.3	72.45	303.2	71.16
15.0	13.7	366.7	76.46	362.8	74.38	348.3	72.91	336.7	71.51	326.3	70.83	303.2	69.58	
110	-24.8	-25	173.7	99.68	173.7	100.6	172.5	101.5	172.5	102.9	172.5	103.8	169.1	104.3
	-21.8	-22	213.3	101.1	213.3	102.0	211.8	102.9	211.8	104.2	211.8	105.2	207.9	105.7
	-19.8	-20	226.1	102.0	226.1	102.9	224.6	103.8	224.6	105.2	224.6	106.1	220.3	106.6
	-18.8	-19	231.1	102.4	231.1	103.4	229.6	104.2	229.6	105.6	229.6	106.6	225.3	105.3
	-16.7	-17	241.8	103.4	241.8	104.3	240.2	105.2	240.2	106.6	240.2	103.9	235.6	102.5
	-13.7	-15	256.7	104.8	256.7	105.7	255.1	106.6	255.1	102.5	255.1	100.0	255.1	98.50
	-11.8	-13	265.1	105.7	265.1	106.6	263.6	103.7	263.6	99.91	263.6	97.56	263.6	95.97
	-9.8	-11	274.0	106.6	274.0	103.4	272.4	100.7	272.4	97.18	272.4	94.99	271.1	93.32
	-9.5	-10	275.5	106.1	275.5	102.9	274.0	100.2	274.0	96.77	274.0	94.61	272.8	92.94
	-8.5	-9.1	280.9	104.3	280.9	101.2	279.3	98.70	279.3	95.40	279.3	93.29	272.8	91.59
	-7.0	-7.6	289.0	101.7	289.0	98.80	287.1	96.42	287.1	93.36	287.1	91.36	272.8	89.62
	-5.0	-5.6	299.4	98.20	299.4	95.52	297.5	93.40	297.5	90.64	292.1	88.79	272.8	86.94
	-3.0	-3.7	310.1	94.69	310.1	92.27	308.2	90.34	302.4	87.88	292.1	86.18	272.8	84.29
	0.0	-0.7	325.9	89.43	325.9	87.39	312.5	85.80	302.4	83.79	292.1	82.32	272.8	80.31
	3.0	2.2	341.7	84.17	333.2	82.51	312.5	81.22	302.4	79.71	292.1	78.43	272.8	76.31
	5.0	4.1	352.5	80.66	333.2	79.26	312.5	78.20	302.4	76.95	292.1	75.86	272.8	73.66
	7.0	6.0	352.5	77.14	333.2	76.00	312.5	75.14	302.4	74.23	292.1	73.28	272.8	71.01
	9.0	7.9	352.5	74.76	333.2	73.66	312.5	72.83	302.4	71.93	292.1	71.01	272.8	68.82
	11.0	9.8	352.5	73.05	333.2	71.96	312.5	71.13	302.4	70.26	292.1	69.35	272.8	67.23
	13.0	11.8	352.5	71.17	333.2	70.11	312.5	69.32	302.4	68.48	292.1	67.61	272.8	65.53
15.0	13.7	352.5	69.20	333.2	68.14	312.5	67.39	302.4	66.56	292.1	65.72	272.8	63.68	

# 7. Capacity Tables

Heating Capacity (92HP)

Combination (%)	Outdoor air temp.		Indoor air temp. °C DB											
			16		18		20		21		22		24	
	°C DB	°C WB	TC	PI	TC	PI	TC	PI	TC	PI	TC	PI	TC	PI
100	-24.8	-25	172.9	110.3	172.9	109.8	171.8	102.2	171.8	108.6	171.8	108.1	168.3	107.9
	-21.8	-22	212.2	109.6	212.2	109.1	211.0	105.4	211.0	107.9	211.0	108.8	206.8	107.1
	-19.8	-20	225.0	109.1	225.0	108.6	223.8	107.4	223.8	107.4	223.8	107.4	219.5	106.6
	-18.8	-19	230.0	108.8	228.8	108.3	228.8	107.9	228.8	107.1	228.8	106.6	224.2	105.0
	-16.7	-17	239.1	108.3	239.1	107.8	239.1	108.8	237.9	106.6	237.9	103.2	233.3	101.5
	-13.7	-15	255.5	107.6	255.5	107.1	254.0	106.6	254.0	101.7	254.0	98.39	249.3	96.58
	-11.8	-13	263.9	107.1	262.4	106.6	262.4	103.4	262.4	98.62	262.4	95.33	249.3	93.47
	-9.8	-11	272.5	106.6	272.5	103.0	271.3	99.91	271.3	95.37	267.5	92.11	249.3	90.18
	-9.5	-10	274.0	106.0	274.0	102.4	272.8	99.41	272.8	94.88	267.5	91.63	249.3	89.69
	-8.5	-9.1	279.4	104.1	279.4	100.6	278.2	97.68	276.7	93.25	267.5	90.03	249.3	88.03
	-7.0	-7.6	292.1	101.3	290.9	97.86	285.9	95.10	276.7	90.82	267.5	87.61	249.3	85.57
	-5.0	-5.6	304.8	97.48	301.7	94.23	285.9	91.69	276.7	87.54	267.5	84.40	249.3	82.29
	-3.0	-3.7	313.6	93.70	304.3	90.57	285.9	88.26	276.7	84.29	267.5	81.18	249.3	79.00
	0.0	-0.7	322.5	87.99	304.3	85.12	285.9	83.11	276.7	79.41	267.5	76.34	249.3	74.08
	3.0	2.2	322.5	82.28	304.3	79.64	285.9	77.97	276.7	74.53	267.5	71.51	249.3	69.16
	5.0	4.1	322.5	78.50	304.3	76.00	285.9	74.53	276.7	71.28	267.5	68.29	249.3	65.87
	7.0	6.0	322.5	74.68	304.3	72.34	285.9	71.09	276.7	68.02	267.5	65.08	249.3	62.58
	9.0	7.9	322.5	72.07	304.3	69.81	285.9	68.60	276.7	65.64	267.5	62.81	249.3	60.39
	11.0	9.8	322.5	70.07	304.3	67.87	285.9	66.70	276.7	63.79	267.5	61.03	249.3	58.72
	13.0	11.8	322.5	67.95	304.3	65.80	285.9	64.66	276.7	61.86	267.5	59.18	249.3	56.91
15.0	13.7	322.5	65.68	304.3	63.60	285.9	62.50	276.7	59.79	267.5	57.21	249.3	55.02	
90	-24.8	-25	172.2	98.06	172.2	99.42	171.0	100.4	171.0	100.9	171.0	101.8	167.9	103.2
	-21.8	-22	211.4	99.42	211.4	100.8	210.2	101.8	210.2	102.3	210.2	103.2	206.0	98.82
	-19.8	-20	224.2	100.4	224.2	101.8	222.7	102.7	222.7	103.2	222.7	102.2	218.5	95.91
	-18.8	-19	230.0	100.8	228.8	102.2	227.7	103.2	227.7	101.7	227.7	98.71	223.4	94.46
	-16.7	-17	239.1	101.8	239.1	103.2	238.3	100.0	238.3	98.44	238.3	95.60	227.8	91.39
	-13.7	-15	255.5	103.2	255.5	98.48	253.2	95.52	253.2	93.86	245.5	91.13	227.8	87.04
	-11.8	-13	263.9	99.96	262.4	95.52	261.3	92.64	253.6	90.94	245.5	88.32	227.8	84.27
	-9.8	-11	272.5	96.62	272.5	92.41	261.6	89.65	253.6	87.87	245.5	85.33	227.8	81.35
	-9.5	-10	274.0	96.09	274.0	91.92	261.6	89.19	253.6	87.41	245.5	84.88	227.8	80.90
	-8.5	-9.1	279.4	94.42	277.4	90.37	261.6	87.68	253.6	85.90	245.5	83.40	227.8	79.46
	-7.0	-7.6	292.1	91.88	277.8	88.02	261.6	85.44	253.6	83.59	245.5	81.16	227.8	77.26
	-5.0	-5.6	295.2	88.50	277.8	84.91	261.6	82.44	253.6	80.55	245.5	78.20	227.8	74.38
	-3.0	-3.7	295.2	85.13	277.8	81.79	261.6	79.41	253.6	77.48	245.5	75.21	227.8	71.46
	0.0	-0.7	295.2	80.08	277.8	77.09	261.6	74.90	253.6	72.89	245.5	70.74	227.8	67.10
	3.0	2.2	295.2	75.01	277.8	72.40	261.6	70.39	253.6	68.31	245.5	66.30	227.8	62.71
	5.0	4.1	295.2	71.63	277.8	69.28	261.6	67.39	253.6	65.24	245.5	63.31	227.8	59.79
	7.0	6.0	295.2	68.26	277.8	66.17	261.6	64.39	253.6	62.20	245.5	60.35	227.8	56.91
	9.0	7.9	295.2	65.07	277.8	63.07	261.6	61.37	253.6	59.28	245.5	57.51	227.8	54.25
	11.0	9.8	295.2	61.88	277.8	59.99	261.6	58.37	253.6	56.37	245.5	54.70	227.8	51.57
	13.0	11.8	295.2	58.70	277.8	56.89	261.6	55.37	253.6	53.48	245.5	51.89	227.8	48.91
15.0	13.7	295.2	55.51	277.8	53.81	261.6	52.34	253.6	50.56	245.5	49.05	227.8	46.26	
80	-24.8	-25	171.4	86.36	171.4	87.76	170.3	88.73	170.3	89.19	170.3	91.49	167.1	87.66
	-21.8	-22	209.1	87.76	209.1	89.13	209.1	90.09	209.1	91.49	209.1	87.66	203.6	83.95
	-19.8	-20	221.9	88.66	221.9	90.06	221.9	91.49	221.9	88.79	218.9	85.08	203.6	81.48
	-18.8	-19	226.9	89.13	226.9	91.49	226.9	90.12	226.7	87.43	218.9	83.80	203.6	80.27
	-16.7	-17	234.0	91.49	234.0	88.64	234.0	87.24	227.0	84.59	218.9	81.14	203.6	77.69
	-13.7	-15	244.7	87.28	239.8	84.55	234.0	83.14	227.0	80.53	218.9	77.28	203.6	73.98
	-11.8	-13	250.6	84.59	243.3	81.97	234.0	80.53	227.0	77.96	218.9	74.85	203.6	71.63
	-9.8	-11	257.2	81.78	246.7	79.28	234.0	77.80	227.0	75.26	218.9	72.28	203.6	69.17
	-9.5	-10	259.1	81.36	248.2	78.86	234.0	77.38	227.0	74.85	218.9	71.90	203.6	68.82
	-8.5	-9.1	261.7	79.96	249.3	77.50	234.0	76.02	227.0	73.48	218.9	70.64	203.6	67.58
	-7.0	-7.6	264.4	77.84	249.3	75.45	234.0	73.97	227.0	71.47	218.9	68.71	203.6	65.72
	-5.0	-5.6	264.4	75.03	249.3	72.76	234.0	71.21	227.0	68.75	218.9	66.13	203.6	63.26
	-3.0	-3.7	264.4	72.22	249.3	70.03	234.0	68.48	227.0	66.05	218.9	63.59	203.6	60.79
	0.0	-0.7	264.4	67.98	249.3	65.97	234.0	64.38	227.0	62.00	218.9	59.73	203.6	57.11
	3.0	2.2	264.4	63.77	249.3	61.88	234.0	60.25	227.0	57.91	218.9	55.90	203.6	53.41
	5.0	4.1	264.4	60.96	249.3	59.18	234.0	57.52	227.0	55.21	218.9	53.33	203.6	50.94
	7.0	6.0	264.4	58.15	249.3	56.45	234.0	54.79	227.0	52.52	218.9	50.78	203.6	48.48
	9.0	7.9	264.4	54.60	249.3	53.01	234.0	51.43	227.0	49.31	218.9	47.68	203.6	45.53
	11.0	9.8	264.4	50.67	249.3	49.20	234.0	47.76	227.0	45.75	218.9	44.24	203.6	42.24
	13.0	11.8	264.4	47.30	249.3	45.91	234.0	44.58	227.0	42.73	218.9	41.30	203.6	39.44
15.0	13.7	264.4	44.51	249.3	43.22	234.0	41.94	227.0	40.20	218.9	38.88	203.6	37.13	

# 7. Capacity Tables

Heating Capacity (92HP)

Combination (%)	Outdoor air temp.		Indoor air temp. °C DB											
			16		18		20		21		22		24	
	°C DB	°C WB	TC	PI	TC	PI	TC	PI	TC	PI	TC	PI	TC	PI
70	-24.8	-25	171.4	86.57	171.4	87.04	170.3	87.97	170.3	89.36	170.3	85.16	167.1	81.22
	-21.8	-22	200.5	87.97	200.5	88.43	199.3	89.36	192.4	85.16	186.6	81.22	174.3	77.43
	-19.8	-20	219.9	88.90	211.7	89.36	199.3	86.41	192.4	82.36	186.6	78.61	174.3	74.89
	-18.8	-19	224.3	89.36	211.7	87.85	199.3	84.93	192.4	80.95	186.6	77.28	174.3	73.61
	-16.7	-17	224.3	86.19	211.7	84.63	199.3	81.86	192.4	78.00	186.6	74.55	174.3	70.95
	-13.7	-15	224.3	81.71	211.7	80.08	199.3	77.43	192.4	73.83	186.6	70.61	174.3	67.13
	-11.8	-13	224.3	78.83	211.7	77.20	199.3	74.63	192.4	71.14	186.6	68.11	174.3	64.74
	-9.8	-11	224.3	75.84	211.7	74.13	199.3	71.70	192.4	68.34	186.6	65.50	174.3	62.20
	-9.5	-10	224.3	75.38	211.7	73.68	199.3	71.25	192.4	67.92	186.6	65.12	174.3	61.82
	-8.5	-9.1	224.3	73.90	211.7	72.16	199.3	69.78	192.4	66.52	186.6	63.79	174.3	60.54
	-7.0	-7.6	224.3	71.63	211.7	69.89	199.3	67.58	192.4	64.44	186.6	61.82	174.3	58.64
	-5.0	-5.6	224.3	68.64	211.7	66.85	199.3	64.62	192.4	61.63	186.6	59.21	174.3	56.11
	-3.0	-3.7	224.3	65.64	211.7	63.79	199.3	61.67	192.4	58.83	186.6	56.59	174.3	53.57
	0.0	-0.7	224.3	61.13	211.7	59.24	199.3	57.27	192.4	54.63	186.6	52.65	174.3	49.78
	3.0	2.2	224.3	56.62	211.7	54.69	199.3	52.84	192.4	50.45	186.6	48.72	174.3	45.95
	5.0	4.1	224.3	53.63	211.7	51.62	199.3	49.92	192.4	47.65	186.6	46.10	174.3	43.42
	7.0	6.0	224.3	50.63	211.7	48.59	199.3	46.96	192.4	44.85	186.6	43.49	174.3	40.88
	9.0	7.9	224.3	45.72	211.7	43.87	199.3	42.42	192.4	40.50	186.6	39.28	174.3	36.91
	11.0	9.8	224.3	42.58	211.7	40.84	199.3	39.48	192.4	37.70	186.6	36.57	174.3	34.37
	13.0	11.8	224.3	39.82	211.7	38.23	199.3	36.94	192.4	35.28	186.6	34.22	174.3	32.18
15.0	13.7	224.3	37.55	211.7	36.04	199.3	34.83	192.4	33.24	186.6	32.25	174.3	30.33	
60	-24.8	-25	170.8	85.57	170.8	86.50	169.6	87.90	165.1	83.38	159.3	79.16	149.3	75.18
	-21.8	-22	183.7	86.97	182.0	87.90	170.8	83.38	165.1	79.16	159.3	75.18	149.3	71.34
	-19.8	-20	192.4	87.90	182.0	84.71	170.8	80.38	165.1	76.35	159.3	72.52	149.3	68.76
	-18.8	-19	192.4	86.30	182.0	83.12	170.8	78.87	165.1	74.92	159.3	71.19	149.3	67.47
	-16.7	-17	192.4	82.92	182.0	79.77	170.8	75.71	165.1	71.95	159.3	68.42	149.3	64.78
	-13.7	-15	192.4	78.10	182.0	75.02	170.8	71.22	165.1	67.74	159.3	64.43	149.3	60.94
	-11.8	-13	192.4	75.06	182.0	71.98	170.8	68.34	165.1	65.04	159.3	61.92	149.3	58.51
	-9.8	-11	192.4	71.86	182.0	68.79	170.8	65.34	165.1	62.23	159.3	59.27	149.3	55.93
	-9.5	-10	192.4	71.37	182.0	68.33	170.8	64.89	165.1	61.81	159.3	58.85	149.3	55.55
	-8.5	-9.1	192.4	69.77	182.0	66.74	170.8	63.40	165.1	60.41	159.3	57.53	149.3	54.26
	-7.0	-7.6	192.4	67.38	182.0	64.35	170.8	61.16	165.1	58.28	159.3	55.55	149.3	52.33
	-5.0	-5.6	192.4	64.15	182.0	61.16	170.8	58.13	165.1	55.47	159.3	52.89	149.3	49.78
	-3.0	-3.7	192.4	60.96	182.0	57.97	170.8	55.13	165.1	52.66	159.3	50.23	149.3	47.20
	0.0	-0.7	192.4	56.13	182.0	53.21	170.8	50.64	165.1	48.41	159.3	46.25	149.3	43.37
	3.0	2.2	192.4	51.31	182.0	48.43	170.8	46.12	165.1	44.19	159.3	42.29	149.3	39.50
	5.0	4.1	192.4	48.12	182.0	45.24	170.8	43.12	165.1	41.38	159.3	39.64	149.3	36.95
	7.0	6.0	192.4	44.92	182.0	42.05	170.8	40.12	165.1	38.53	159.3	36.98	149.3	34.37
	9.0	7.9	192.4	40.08	182.0	37.55	170.8	35.77	165.1	34.38	159.3	32.98	149.3	30.67
	11.0	9.8	192.4	37.40	182.0	35.05	170.8	33.42	165.1	32.11	159.3	30.82	149.3	28.63
	13.0	11.8	192.4	35.05	182.0	32.82	170.8	31.31	165.1	30.07	159.3	28.85	149.3	26.84
15.0	13.7	192.4	33.12	182.0	31.04	170.8	29.57	165.1	28.43	159.3	27.27	149.3	25.37	
50	-24.8	-25	160.5	74.57	151.3	75.96	142.4	71.99	137.8	68.28	133.1	64.76	123.9	61.50
	-21.8	-22	160.5	75.96	151.3	71.99	142.4	68.28	137.8	64.76	133.1	61.50	123.9	58.35
	-19.8	-20	160.5	73.20	151.3	69.34	142.4	65.81	137.8	62.41	133.1	59.30	123.9	56.23
	-18.8	-19	160.5	71.80	151.3	68.01	142.4	64.57	137.8	61.27	133.1	58.21	123.9	55.18
	-16.7	-17	160.5	68.92	151.3	65.25	142.4	61.99	137.8	58.80	133.1	55.93	123.9	52.98
	-13.7	-15	160.5	64.79	151.3	61.27	142.4	58.27	137.8	55.28	133.1	52.67	123.9	49.83
	-11.8	-13	160.5	62.17	151.3	58.77	142.4	55.93	137.8	53.05	133.1	50.59	123.9	47.83
	-9.8	-11	160.5	59.41	151.3	56.12	142.4	53.43	137.8	50.70	133.1	48.39	123.9	45.71
	-9.5	-10	160.5	58.99	151.3	55.74	142.4	53.08	137.8	50.36	133.1	48.09	123.9	45.40
	-8.5	-9.1	160.5	57.60	151.3	54.41	142.4	51.84	137.8	49.19	133.1	46.99	123.9	44.34
	-7.0	-7.6	160.5	55.54	151.3	52.44	142.4	49.98	137.8	47.44	133.1	45.36	123.9	42.79
	-5.0	-5.6	160.5	52.78	151.3	49.79	142.4	47.52	137.8	45.10	133.1	43.17	123.9	40.67
	-3.0	-3.7	160.5	50.02	151.3	47.14	142.4	45.02	137.8	42.75	133.1	40.97	123.9	38.58
	0.0	-0.7	160.5	45.89	151.3	43.16	142.4	41.31	137.8	39.23	133.1	37.71	123.9	35.41
	3.0	2.2	160.5	41.75	151.3	39.22	142.4	37.63	137.8	35.71	133.1	34.45	123.9	32.26
	5.0	4.1	160.5	38.99	151.3	36.57	142.4	35.14	137.8	33.39	133.1	32.26	123.9	30.17
	7.0	6.0	160.5	36.23	151.3	33.92	142.4	32.67	137.8	31.04	133.1	30.06	123.9	28.06
	9.0	7.9	160.5	32.71	151.3	30.63	142.4	29.50	137.8	28.02	133.1	27.15	123.9	25.34
	11.0	9.8	160.5	30.60	151.3	28.66	142.4	27.60	137.8	26.24	133.1	25.41	123.9	23.71
	13.0	11.8	160.5	28.74	151.3	26.92	142.4	25.91	137.8	24.62	133.1	23.86	123.9	22.27
15.0	13.7	160.5	27.19	151.3	25.45	142.4	24.54	137.8	23.29	133.1	22.58	123.9	21.06	

**Note**

1. TC: Total Capacity(kW), PI : Power Input(kW, Comp. + Outdoor fan motor)
2. Capacity tables show the average value of conditions which may occur.
3. The heating capacity table is based on the values expressed as Max. in the specification of the outdoor unit. (When measuring the Max. heating capacity, the setting status of the indoor unit is the same as that for measuring the heating capacity of the indoor unit.)

# 7. Capacity Tables

## ◆ ARUM940LTE5

Heating Capacity (94HP)

Combination (%)	Outdoor air temp.		Indoor air temp. °C DB											
			16		18		20		21		22		24	
	°C DB	°C WB	TC	PI	TC	PI	TC	PI	TC	PI	TC	PI	TC	PI
130	-24.8	-25	179.6	101.3	179.6	102.1	178.5	102.7	178.5	103.6	178.5	104.5	175.2	105.9
	-21.8	-22	220.8	102.7	220.8	103.4	219.3	104.1	219.3	105.0	219.3	105.9	215.0	107.3
	-19.8	-20	233.9	103.7	233.9	104.4	232.3	105.0	232.3	105.9	232.3	106.8	228.0	108.3
	-18.8	-19	239.3	104.2	239.3	104.9	237.7	105.5	237.7	106.4	237.7	107.3	233.1	108.7
	-16.7	-17	250.2	105.1	250.2	105.8	248.6	106.5	248.6	107.4	248.6	108.3	243.9	109.7
	-13.7	-15	265.8	106.6	265.8	107.3	264.2	107.9	264.2	108.8	264.2	109.7	259.1	105.7
	-11.8	-13	274.5	107.5	274.5	108.2	272.9	108.8	272.9	109.7	272.9	107.1	268.9	103.2
	-9.8	-11	283.6	108.4	283.6	109.1	281.9	109.7	281.9	106.9	281.9	104.3	279.0	100.6
	-9.5	-10	285.2	108.6	285.2	109.2	283.5	109.3	283.5	106.5	283.2	103.8	280.6	100.1
	-8.5	-9.1	290.7	109.0	290.7	109.7	289.0	107.8	289.0	105.0	287.9	102.4	285.6	98.81
	-7.0	-7.6	298.9	109.7	298.9	107.6	297.0	105.7	297.0	102.9	297.0	100.3	293.1	96.82
	-5.0	-5.6	309.9	107.1	309.9	104.8	307.9	102.8	307.9	100.1	307.9	97.48	303.3	94.17
	-3.0	-3.7	320.9	104.4	320.9	102.1	318.9	99.94	318.9	97.25	318.9	94.68	313.4	91.49
	0.0	-0.7	337.4	100.4	337.4	97.91	335.1	95.65	335.1	93.01	335.1	90.47	328.9	87.52
	3.0	2.2	353.9	96.43	353.9	93.71	351.6	91.33	351.6	88.77	351.6	86.24	329.9	83.55
	5.0	4.1	364.6	93.75	364.6	90.94	362.6	88.46	362.6	85.93	354.3	83.44	329.9	80.87
	7.0	6.0	375.6	91.10	375.6	88.15	373.2	85.61	367.3	83.12	354.3	80.63	329.9	78.22
	9.0	7.9	377.6	88.92	377.6	86.04	376.4	83.55	367.3	81.13	354.3	78.72	329.9	76.35
	11.0	9.8	377.6	87.52	377.6	84.72	376.4	82.26	367.3	79.85	354.3	77.48	329.9	75.15
	13.0	11.8	377.6	86.04	377.6	83.24	376.4	80.83	367.3	78.49	354.3	76.15	329.9	73.86
15.0	13.7	377.6	84.40	377.6	81.68	376.4	79.31	367.3	76.98	354.3	74.71	329.9	72.46	
120	-24.8	-25	178.4	102.1	178.4	102.7	177.3	103.6	177.3	104.5	177.3	105.9	174.0	106.9
	-21.8	-22	219.2	103.4	219.2	104.1	217.7	105.0	217.7	105.9	217.7	107.3	213.7	108.3
	-19.8	-20	232.3	104.4	232.3	105.0	230.7	105.9	230.7	106.8	230.7	108.3	226.4	109.2
	-18.8	-19	237.4	104.9	237.4	105.5	235.8	106.4	235.8	107.3	235.8	108.7	231.5	109.7
	-16.7	-17	248.3	105.8	248.3	106.5	246.7	107.4	246.7	108.3	246.7	109.7	242.0	107.1
	-13.7	-15	263.9	107.3	263.9	107.9	262.3	108.8	262.3	109.7	262.3	105.9	257.2	103.5
	-11.8	-13	272.5	108.2	272.5	108.8	270.9	109.7	270.9	107.0	270.9	103.5	266.9	101.2
	-9.8	-11	281.6	109.1	281.6	109.7	280.0	106.8	280.0	104.2	280.0	101.0	277.1	98.72
	-9.5	-10	283.2	109.2	283.2	109.2	281.6	106.3	281.6	103.8	281.6	100.6	278.6	98.34
	-8.5	-9.1	288.7	109.7	288.7	107.7	286.7	104.8	286.7	102.4	286.7	99.31	283.4	97.13
	-7.0	-7.6	296.9	107.4	296.9	105.4	295.0	102.6	295.0	100.2	295.0	97.40	291.1	95.30
	-5.0	-5.6	307.9	104.3	307.9	102.2	305.9	99.66	305.9	97.37	305.9	94.84	301.2	92.85
	-3.0	-3.7	318.6	101.3	318.6	99.15	316.6	96.71	316.6	94.56	316.6	92.31	309.9	90.40
	0.0	-0.7	335.0	96.66	335.0	94.48	332.7	92.27	332.7	90.29	332.7	88.49	309.9	86.74
	3.0	2.2	351.2	92.07	351.2	89.81	349.2	87.83	344.1	86.04	333.5	84.68	309.9	83.08
	5.0	4.1	362.2	89.00	362.2	86.70	356.0	84.91	344.1	83.20	333.5	82.15	309.9	80.63
	7.0	6.0	373.2	85.92	370.8	83.59	356.0	81.95	344.1	80.36	333.5	79.62	309.9	78.18
	9.0	7.9	374.7	83.63	370.8	81.37	356.0	79.78	344.1	78.26	333.5	77.52	309.9	76.12
	11.0	9.8	374.7	82.11	370.8	79.89	356.0	78.30	344.1	76.82	333.5	76.08	309.9	74.72
	13.0	11.8	374.7	80.44	370.8	78.26	356.0	76.74	344.1	75.26	333.5	74.56	309.9	73.23
15.0	13.7	374.7	78.68	370.8	76.54	356.0	75.03	344.1	73.59	333.5	72.89	309.9	71.60	
110	-24.8	-25	177.6	102.7	177.6	103.6	176.4	104.5	176.4	105.9	176.4	106.9	172.9	107.4
	-21.8	-22	218.0	104.1	218.0	105.0	216.5	105.9	216.5	107.3	216.5	108.3	212.5	108.8
	-19.8	-20	231.1	105.0	231.1	105.9	229.6	106.8	229.6	108.3	229.6	109.2	225.2	109.7
	-18.8	-19	236.2	105.5	236.2	106.4	234.6	107.3	234.6	108.7	234.6	109.7	230.3	108.3
	-16.7	-17	247.1	106.5	247.1	107.4	245.5	108.3	245.5	109.7	245.5	106.9	240.8	105.5
	-13.7	-15	262.3	107.9	262.3	108.8	260.8	109.7	260.8	105.5	260.8	102.9	260.8	101.4
	-11.8	-13	271.0	108.8	271.0	109.7	269.4	106.7	269.4	102.8	269.4	100.4	269.4	98.77
	-9.8	-11	280.0	109.7	280.0	106.4	278.4	103.6	278.4	100.0	278.4	97.75	277.0	96.04
	-9.5	-10	281.6	109.2	281.6	105.9	280.0	103.1	280.0	99.58	280.0	97.36	278.8	95.65
	-8.5	-9.1	287.1	107.4	287.1	104.2	285.5	101.6	285.5	98.18	285.5	96.01	278.8	94.26
	-7.0	-7.6	295.3	104.7	295.3	101.7	293.4	99.23	293.4	96.08	293.4	94.02	278.8	92.23
	-5.0	-5.6	306.0	101.1	306.0	98.30	304.0	96.12	304.0	93.28	298.5	91.37	278.8	89.47
	-3.0	-3.7	317.0	97.44	317.0	94.96	315.0	92.97	309.1	90.44	298.5	88.69	278.8	86.74
	0.0	-0.7	333.1	92.03	333.1	89.93	319.4	88.29	309.1	86.23	298.5	84.72	278.8	82.65
	3.0	2.2	349.3	86.62	340.5	84.91	319.4	83.59	309.1	82.03	298.5	80.71	278.8	78.53
	5.0	4.1	360.2	83.01	340.5	81.56	319.4	80.47	309.1	79.19	298.5	78.06	278.8	75.81
	7.0	6.0	360.2	79.39	340.5	78.22	319.4	77.33	309.1	76.39	298.5	75.42	278.8	73.08
	9.0	7.9	360.2	76.94	340.5	75.80	319.4	74.95	309.1	74.02	298.5	73.08	278.8	70.83
	11.0	9.8	360.2	75.18	340.5	74.05	319.4	73.20	309.1	72.31	298.5	71.37	278.8	69.19
	13.0	11.8	360.2	73.24	340.5	72.15	319.4	71.33	309.1	70.47	298.5	69.58	278.8	67.44
15.0	13.7	360.2	71.21	340.5	70.13	319.4	69.35	309.1	68.49	298.5	67.63	278.8	65.53	

# 7. Capacity Tables

Heating Capacity (94HP)

Combination (%)	Outdoor air temp.		Indoor air temp. °C DB											
			16		18		20		21		22		24	
	°C DB	°C WB	TC	PI	TC	PI	TC	PI	TC	PI	TC	PI	TC	PI
100	-24.8	-25	176.8	113.6	176.8	113.1	175.6	105.2	175.6	111.8	175.6	111.3	172.1	111.0
	-21.8	-22	216.9	112.8	216.9	112.3	215.7	108.5	215.7	111.0	215.7	112.0	211.4	110.2
	-19.8	-20	230.0	112.3	230.0	111.8	228.7	110.6	228.7	110.5	228.7	110.5	224.4	109.7
	-18.8	-19	235.0	112.0	233.8	111.5	233.8	111.0	233.8	110.2	233.8	109.7	229.1	108.0
	-16.7	-17	244.4	111.5	244.4	111.0	244.4	112.0	243.1	109.7	243.1	106.2	238.4	104.5
	-13.7	-15	261.1	110.7	261.1	110.2	259.6	109.7	259.6	104.7	259.6	101.3	254.8	99.39
	-11.8	-13	269.7	110.2	268.2	109.7	268.2	106.4	268.2	101.5	268.2	98.11	254.8	96.20
	-9.8	-11	278.5	109.7	278.5	106.0	277.2	102.8	277.2	98.14	273.4	94.80	254.8	92.81
	-9.5	-10	280.0	109.1	280.0	105.4	278.8	102.3	278.8	97.64	273.4	94.29	254.8	92.30
	-8.5	-9.1	285.5	107.2	285.5	103.5	284.3	100.5	282.8	95.97	273.4	92.65	254.8	90.60
	-7.0	-7.6	298.5	104.3	297.3	100.7	292.2	97.87	282.8	93.47	273.4	90.16	254.8	88.07
	-5.0	-5.6	311.5	100.3	308.4	96.97	292.2	94.36	282.8	90.09	273.4	86.86	254.8	84.68
	-3.0	-3.7	320.5	96.43	311.0	93.20	292.2	90.83	282.8	86.74	273.4	83.55	254.8	81.30
	0.0	-0.7	329.6	90.55	311.0	87.59	292.2	85.53	282.8	81.72	273.4	78.57	254.8	76.24
	3.0	2.2	329.6	84.68	311.0	81.96	292.2	80.24	282.8	76.70	273.4	73.59	254.8	71.17
	5.0	4.1	329.6	80.79	311.0	78.22	292.2	76.70	282.8	73.35	273.4	70.28	254.8	67.79
	7.0	6.0	329.6	76.86	311.0	74.45	292.2	73.16	282.8	70.00	273.4	66.97	254.8	64.40
	9.0	7.9	329.6	74.17	311.0	71.84	292.2	70.59	282.8	67.55	273.4	64.63	254.8	62.15
	11.0	9.8	329.6	72.11	311.0	69.85	292.2	68.64	282.8	65.65	273.4	62.81	254.8	60.43
	13.0	11.8	329.6	69.93	311.0	67.71	292.2	66.54	282.8	63.66	273.4	60.90	254.8	58.57
15.0	13.7	329.6	67.59	311.0	65.46	292.2	64.32	282.8	61.53	273.4	58.88	254.8	56.62	
90	-24.8	-25	176.0	101.0	176.0	102.4	174.9	103.4	174.9	103.8	174.9	104.8	171.7	106.2
	-21.8	-22	216.1	102.4	216.1	103.8	214.9	104.8	214.9	105.3	214.9	106.2	210.6	101.7
	-19.8	-20	229.1	103.3	229.1	104.7	227.6	105.7	227.6	106.2	227.6	106.2	223.3	98.71
	-18.8	-19	235.0	103.8	233.8	105.2	232.7	106.2	232.7	104.6	232.7	101.6	228.3	97.22
	-16.7	-17	244.4	104.8	244.4	106.2	243.5	103.0	243.5	101.3	243.5	98.39	232.8	94.06
	-13.7	-15	261.1	106.2	261.1	101.4	258.7	98.31	258.7	96.60	250.9	93.79	232.8	89.58
	-11.8	-13	269.7	102.9	268.2	98.31	267.1	95.35	259.1	93.59	250.9	90.90	232.8	86.73
	-9.8	-11	278.5	99.44	278.5	95.11	267.4	92.26	259.1	90.44	250.9	87.82	232.8	83.73
	-9.5	-10	280.0	98.90	280.0	94.61	267.4	91.80	259.1	89.97	250.9	87.35	232.8	83.26
	-8.5	-9.1	285.5	97.17	283.6	93.00	267.4	90.24	259.1	88.40	250.9	85.83	232.8	81.78
	-7.0	-7.6	298.5	94.56	284.0	90.59	267.4	87.93	259.1	86.03	250.9	83.53	232.8	79.52
	-5.0	-5.6	301.7	91.09	284.0	87.38	267.4	84.84	259.1	82.90	250.9	80.48	232.8	76.55
	-3.0	-3.7	301.7	87.61	284.0	84.18	267.4	81.73	259.1	79.74	250.9	77.40	232.8	73.54
	0.0	-0.7	301.7	82.42	284.0	79.34	267.4	77.08	259.1	75.02	250.9	72.80	232.8	69.06
	3.0	2.2	301.7	77.19	284.0	74.51	267.4	72.44	259.1	70.30	250.9	68.23	232.8	64.54
	5.0	4.1	301.7	73.72	284.0	71.30	267.4	69.35	259.1	67.14	250.9	65.15	232.8	61.54
	7.0	6.0	301.7	70.24	284.0	68.10	267.4	66.27	259.1	64.01	250.9	62.11	232.8	58.56
	9.0	7.9	301.7	66.96	284.0	64.90	267.4	63.15	259.1	61.01	250.9	59.18	232.8	55.83
	11.0	9.8	301.7	63.68	284.0	61.74	267.4	60.07	259.1	58.01	250.9	56.29	232.8	53.07
	13.0	11.8	301.7	60.41	284.0	58.54	267.4	56.98	259.1	55.04	250.9	53.40	232.8	50.34
15.0	13.7	301.7	57.13	284.0	55.37	267.4	53.86	259.1	52.03	250.9	50.48	232.8	47.60	
80	-24.8	-25	175.3	88.94	175.3	90.37	174.1	91.35	174.1	91.82	174.1	94.16	170.9	90.22
	-21.8	-22	213.8	90.37	213.8	91.76	213.8	92.74	213.8	94.16	213.8	90.22	208.0	86.40
	-19.8	-20	226.8	91.28	226.8	92.70	226.8	94.16	226.8	91.39	223.7	87.57	208.0	83.86
	-18.8	-19	231.8	91.76	231.8	94.16	231.8	92.75	231.7	89.98	223.7	86.24	208.0	82.61
	-16.7	-17	239.1	94.16	239.1	91.23	239.1	89.79	232.0	87.06	223.7	83.50	208.0	79.96
	-13.7	-15	250.1	89.82	245.0	87.02	239.1	85.57	232.0	82.88	223.7	79.53	208.0	76.14
	-11.8	-13	256.1	87.06	248.6	84.37	239.1	82.88	232.0	80.23	223.7	77.03	208.0	73.72
	-9.8	-11	262.9	84.17	252.2	81.59	239.1	80.07	232.0	77.46	223.7	74.38	208.0	71.19
	-9.5	-10	264.8	83.74	253.7	81.16	239.1	79.64	232.0	77.03	223.7	73.99	208.0	70.83
	-8.5	-9.1	267.5	82.29	254.8	79.76	239.1	78.24	232.0	75.63	223.7	72.70	208.0	69.55
	-7.0	-7.6	270.2	80.11	254.8	77.65	239.1	76.13	232.0	73.56	223.7	70.71	208.0	67.64
	-5.0	-5.6	270.2	77.22	254.8	74.88	239.1	73.29	232.0	70.75	223.7	68.06	208.0	65.10
	-3.0	-3.7	270.2	74.33	254.8	72.07	239.1	70.47	232.0	67.98	223.7	65.45	208.0	62.57
	0.0	-0.7	270.2	69.96	254.8	67.89	239.1	66.26	232.0	63.80	223.7	61.47	208.0	58.78
	3.0	2.2	270.2	65.63	254.8	63.68	239.1	62.01	232.0	59.60	223.7	57.53	208.0	54.96
	5.0	4.1	270.2	62.74	254.8	60.91	239.1	59.20	232.0	56.82	223.7	54.88	208.0	52.43
	7.0	6.0	270.2	59.85	254.8	58.10	239.1	56.39	232.0	54.05	223.7	52.26	208.0	49.89
	9.0	7.9	270.2	56.19	254.8	54.56	239.1	52.93	232.0	50.74	223.7	49.07	208.0	46.85
	11.0	9.8	270.2	52.14	254.8	50.63	239.1	49.15	232.0	47.09	223.7	45.53	208.0	43.47
	13.0	11.8	270.2	48.68	254.8	47.25	239.1	45.88	232.0	43.97	223.7	42.50	208.0	40.59
15.0	13.7	270.2	45.81	254.8	44.48	239.1	43.16	232.0	41.37	223.7	40.01	208.0	38.21	

# 7. Capacity Tables

Heating Capacity (94HP)

Combination (%)	Outdoor air temp.		Indoor air temp. °C DB											
			16		18		20		21		22		24	
	°C DB	°C WB	TC	PI	TC	PI	TC	PI	TC	PI	TC	PI	TC	PI
70	-24.8	-25	175.3	89.13	175.3	89.60	174.1	90.55	174.1	91.97	174.1	87.65	170.9	83.59
	-21.8	-22	204.9	90.55	204.9	91.03	203.7	91.97	196.6	87.65	190.8	83.59	178.1	79.69
	-19.8	-20	224.6	91.50	216.3	91.97	203.7	88.93	196.6	84.76	190.8	80.90	178.1	77.08
	-18.8	-19	229.3	91.97	216.3	90.41	203.7	87.41	196.6	83.32	190.8	79.54	178.1	75.76
	-16.7	-17	229.3	88.70	216.3	87.10	203.7	84.25	196.6	80.28	190.8	76.73	178.1	73.02
	-13.7	-15	229.3	84.09	216.3	82.42	203.7	79.69	196.6	75.98	190.8	72.67	178.1	69.09
	-11.8	-13	229.3	81.13	216.3	79.45	203.7	76.81	196.6	73.22	190.8	70.10	178.1	66.63
	-9.8	-11	229.3	78.05	216.3	76.30	203.7	73.80	196.6	70.34	190.8	67.41	178.1	64.02
	-9.5	-10	229.3	77.58	216.3	75.83	203.7	73.33	196.6	69.91	190.8	67.02	178.1	63.63
	-8.5	-9.1	229.3	76.06	216.3	74.27	203.7	71.81	196.6	68.46	190.8	65.65	178.1	62.31
	-7.0	-7.6	229.3	73.72	216.3	71.93	203.7	69.55	196.6	66.32	190.8	63.63	178.1	60.35
	-5.0	-5.6	229.3	70.64	216.3	68.80	203.7	66.51	196.6	63.43	190.8	60.94	178.1	57.74
	-3.0	-3.7	229.3	67.55	216.3	65.65	203.7	63.47	196.6	60.55	190.8	58.24	178.1	55.13
	0.0	-0.7	229.3	62.91	216.3	60.97	203.7	58.94	196.6	56.22	190.8	54.19	178.1	51.23
	3.0	2.2	229.3	58.27	216.3	56.28	203.7	54.38	196.6	51.92	190.8	50.14	178.1	47.29
	5.0	4.1	229.3	55.19	216.3	53.13	203.7	51.37	196.6	49.04	190.8	47.44	178.1	44.68
	7.0	6.0	229.3	52.11	216.3	50.01	203.7	48.33	196.6	46.15	190.8	44.75	178.1	42.07
	9.0	7.9	229.3	47.05	216.3	45.15	203.7	43.66	196.6	41.68	190.8	40.43	178.1	37.98
	11.0	9.8	229.3	43.82	216.3	42.03	203.7	40.63	196.6	38.80	190.8	37.63	178.1	35.37
	13.0	11.8	229.3	40.98	216.3	39.34	203.7	38.02	196.6	36.31	190.8	35.21	178.1	33.11
15.0	13.7	229.3	38.64	216.3	37.09	203.7	35.84	196.6	34.21	190.8	33.19	178.1	31.21	
60	-24.8	-25	174.5	88.11	174.5	89.06	173.4	90.48	168.7	85.83	162.8	81.49	152.5	77.38
	-21.8	-22	187.7	89.53	186.0	90.48	174.6	85.83	168.7	81.49	162.8	77.38	152.5	73.43
	-19.8	-20	196.6	90.48	186.0	87.20	174.6	82.74	168.7	78.59	162.8	74.65	152.5	70.78
	-18.8	-19	196.6	88.84	186.0	85.56	174.6	81.18	168.7	77.11	162.8	73.28	152.5	69.45
	-16.7	-17	196.6	85.36	186.0	82.11	174.6	77.93	168.7	74.06	162.8	70.42	152.5	66.68
	-13.7	-15	196.6	80.39	186.0	77.22	174.6	73.31	168.7	69.72	162.8	66.32	152.5	62.73
	-11.8	-13	196.6	77.26	186.0	74.09	174.6	70.35	168.7	66.95	162.8	63.74	152.5	60.22
	-9.8	-11	196.6	73.97	186.0	70.81	174.6	67.26	168.7	64.05	162.8	61.00	152.5	57.57
	-9.5	-10	196.6	73.46	186.0	70.34	174.6	66.79	168.7	63.62	162.8	60.58	152.5	57.18
	-8.5	-9.1	196.6	71.82	186.0	68.69	174.6	65.26	168.7	62.17	162.8	59.21	152.5	55.85
	-7.0	-7.6	196.6	69.35	186.0	66.23	174.6	62.95	168.7	59.99	162.8	57.17	152.5	53.86
	-5.0	-5.6	196.6	66.03	186.0	62.95	174.6	59.83	168.7	57.09	162.8	54.44	152.5	51.24
	-3.0	-3.7	196.6	62.74	186.0	59.66	174.6	56.74	168.7	54.20	162.8	51.70	152.5	48.58
	0.0	-0.7	196.6	57.77	186.0	54.77	174.6	52.12	168.7	49.82	162.8	47.60	152.5	44.63
	3.0	2.2	196.6	52.81	186.0	49.84	174.6	47.47	168.7	45.48	162.8	43.53	152.5	40.65
	5.0	4.1	196.6	49.52	186.0	46.56	174.6	44.38	168.7	42.58	162.8	40.79	152.5	38.03
	7.0	6.0	196.6	46.23	186.0	43.28	174.6	41.28	168.7	39.66	162.8	38.06	152.5	35.38
	9.0	7.9	196.6	41.25	186.0	38.64	174.6	36.82	168.7	35.38	162.8	33.94	152.5	31.56
	11.0	9.8	196.6	38.49	186.0	36.07	174.6	34.40	168.7	33.04	162.8	31.71	152.5	29.46
	13.0	11.8	196.6	36.07	186.0	33.78	174.6	32.22	168.7	30.94	162.8	29.69	152.5	27.63
15.0	13.7	196.6	34.09	186.0	31.94	174.6	30.43	168.7	29.26	162.8	28.06	152.5	26.11	
50	-24.8	-25	164.0	76.76	154.6	78.18	145.5	74.09	140.8	70.27	136.1	66.65	126.7	63.29
	-21.8	-22	164.0	78.18	154.6	74.09	145.5	70.27	140.8	66.65	136.1	63.29	126.7	60.05
	-19.8	-20	164.0	75.34	154.6	71.36	145.5	67.73	140.8	64.23	136.1	61.03	126.7	57.88
	-18.8	-19	164.0	73.90	154.6	70.00	145.5	66.45	140.8	63.05	136.1	59.91	126.7	56.79
	-16.7	-17	164.0	70.93	154.6	67.15	145.5	63.80	140.8	60.52	136.1	57.56	126.7	54.52
	-13.7	-15	164.0	66.68	154.6	63.06	145.5	59.97	140.8	56.90	136.1	54.21	126.7	51.28
	-11.8	-13	164.0	63.99	154.6	60.48	145.5	57.56	140.8	54.60	136.1	52.06	126.7	49.22
	-9.8	-11	164.0	61.14	154.6	57.76	145.5	54.99	140.8	52.18	136.1	49.81	126.7	47.04
	-9.5	-10	164.0	60.71	154.6	57.36	145.5	54.63	140.8	51.83	136.1	49.49	126.7	46.73
	-8.5	-9.1	164.0	59.28	154.6	56.00	145.5	53.35	140.8	50.62	136.1	48.36	126.7	45.64
	-7.0	-7.6	164.0	57.17	154.6	53.97	145.5	51.44	140.8	48.83	136.1	46.68	126.7	44.03
	-5.0	-5.6	164.0	54.32	154.6	51.24	145.5	48.90	140.8	46.41	136.1	44.43	126.7	41.86
	-3.0	-3.7	164.0	51.48	154.6	48.51	145.5	46.34	140.8	44.00	136.1	42.17	126.7	39.71
	0.0	-0.7	164.0	47.22	154.6	44.42	145.5	42.52	140.8	40.37	136.1	38.81	126.7	36.44
	3.0	2.2	164.0	42.97	154.6	40.36	145.5	38.73	140.8	36.75	136.1	35.46	126.7	33.20
	5.0	4.1	164.0	40.13	154.6	37.63	145.5	36.16	140.8	34.36	136.1	33.20	126.7	31.05
	7.0	6.0	164.0	37.28	154.6	34.91	145.5	33.62	140.8	31.95	136.1	30.94	126.7	28.87
	9.0	7.9	164.0	33.66	154.6	31.52	145.5	30.36	140.8	28.84	136.1	27.94	126.7	26.07
	11.0	9.8	164.0	31.49	154.6	29.50	145.5	28.41	140.8	27.00	136.1	26.15	126.7	24.40
	13.0	11.8	164.0	29.58	154.6	27.70	145.5	26.66	140.8	25.34	136.1	24.56	126.7	22.92
15.0	13.7	164.0	27.98	154.6	26.19	145.5	25.25	140.8	23.97	136.1	23.23	126.7	21.68	

**Note**

1. TC: Total Capacity(kW), PI : Power Input(kW, Comp. + Outdoor fan motor)
2. Capacity tables show the average value of conditions which may occur.
3. The heating capacity table is based on the values expressed as Max. in the specification of the outdoor unit. (When measuring the Max. heating capacity, the setting status of the indoor unit is the same as that for measuring the heating capacity of the indoor unit.)



# 7. Capacity Tables

## ◆ ARUM960LTE5

Heating Capacity (96HP)

Combination (%)	Outdoor air temp.		Indoor air temp. °C DB											
			16		18		20		21		22		24	
	°C DB	°C WB	TC	PI	TC	PI	TC	PI	TC	PI	TC	PI	TC	PI
130	-24.8	-25	181.6	102.9	181.6	103.7	180.4	104.4	180.4	105.5	180.4	106.6	177.2	108.3
	-21.8	-22	224.0	104.5	224.0	105.4	222.4	106.1	222.4	107.2	222.4	108.3	218.0	109.9
	-19.8	-20	237.6	105.6	237.6	106.5	236.0	107.2	236.0	108.3	236.0	109.4	231.6	111.0
	-18.8	-19	243.2	106.2	243.2	107.0	241.6	107.8	241.6	108.9	241.6	109.9	236.8	111.6
	-16.7	-17	254.4	107.4	254.4	108.2	252.8	108.9	252.8	110.0	252.8	111.1	248.0	112.8
	-13.7	-15	270.4	109.0	270.4	109.9	268.8	110.6	268.8	111.7	268.8	112.8	263.6	108.7
	-11.8	-13	279.2	110.1	279.2	110.9	277.6	111.6	277.6	112.8	277.6	110.0	273.6	106.1
	-9.8	-11	288.4	111.2	288.4	112.0	286.8	112.8	286.8	109.9	286.8	107.2	284.0	103.4
	-9.5	-10	290.0	111.4	290.0	112.2	288.4	112.3	288.4	109.4	288.0	106.7	285.6	102.9
	-8.5	-9.1	295.6	111.9	295.6	112.8	294.0	110.8	294.0	108.0	292.8	105.3	290.8	101.6
	-7.0	-7.6	304.0	112.8	304.0	110.6	302.0	108.6	302.0	105.8	302.0	103.1	298.4	99.52
	-5.0	-5.6	315.2	110.0	315.2	107.8	313.2	105.7	313.2	102.9	313.2	100.2	308.8	96.80
	-3.0	-3.7	326.4	107.3	326.4	104.9	324.4	102.7	324.4	99.96	324.4	97.32	319.2	94.04
	0.0	-0.7	343.2	103.2	343.2	100.6	340.8	98.32	340.8	95.60	340.8	93.00	335.2	89.96
	3.0	2.2	360.0	99.12	360.0	96.32	357.6	93.88	357.6	91.24	357.6	88.64	335.6	85.88
	5.0	4.1	370.8	96.36	370.8	93.48	368.8	90.92	368.8	88.32	360.4	85.76	335.6	83.12
	7.0	6.0	382.0	93.64	382.0	90.60	379.6	88.00	373.6	85.44	360.4	82.88	335.6	80.40
	9.0	7.9	384.0	91.40	384.0	88.44	382.8	85.88	373.6	83.40	360.4	80.92	335.6	78.48
	11.0	9.8	384.0	89.96	384.0	87.08	382.8	84.56	373.6	82.08	360.4	79.64	335.6	77.24
	13.0	11.8	384.0	88.44	384.0	85.56	382.8	83.08	373.6	80.68	360.4	78.28	335.6	75.92
15.0	13.7	384.0	86.76	384.0	83.96	382.8	81.52	373.6	79.12	360.4	76.80	335.6	74.48	
120	-24.8	-25	180.4	103.7	180.4	104.4	179.2	105.5	179.2	106.6	179.2	108.3	176.0	109.4
	-21.8	-22	222.4	105.4	222.4	106.1	220.8	107.2	220.8	108.3	220.8	109.9	216.8	111.1
	-19.8	-20	236.0	106.5	236.0	107.2	234.4	108.3	234.4	109.4	234.4	111.0	230.0	112.2
	-18.8	-19	241.2	107.0	241.2	107.8	239.6	108.9	239.6	109.9	239.6	111.6	235.2	112.8
	-16.7	-17	252.4	108.2	252.4	108.9	250.8	110.0	250.8	111.1	250.8	112.8	246.0	110.1
	-13.7	-15	268.4	109.9	268.4	110.6	266.8	111.7	266.8	112.8	266.8	108.8	261.6	106.4
	-11.8	-13	277.2	110.9	277.2	111.6	275.6	112.8	275.6	110.0	275.6	106.4	271.6	104.0
	-9.8	-11	286.4	112.0	286.4	112.8	284.8	109.7	284.8	107.1	284.8	103.8	282.0	101.5
	-9.5	-10	288.0	112.2	288.0	112.3	286.4	109.3	286.4	106.6	286.4	103.4	283.6	101.1
	-8.5	-9.1	293.6	112.8	293.6	110.7	291.6	107.8	291.6	105.2	291.6	102.1	288.4	99.84
	-7.0	-7.6	302.0	110.4	302.0	108.3	300.0	105.5	300.0	103.0	300.0	100.1	296.4	97.96
	-5.0	-5.6	313.2	107.2	313.2	105.1	311.2	102.4	311.2	100.1	311.2	97.48	306.8	95.44
	-3.0	-3.7	324.0	104.1	324.0	101.9	322.0	99.40	322.0	97.20	322.0	94.88	315.2	92.92
	0.0	-0.7	340.8	99.36	340.8	97.12	338.4	94.84	338.4	92.80	338.4	90.96	315.2	89.16
	3.0	2.2	357.2	94.64	357.2	92.32	355.2	90.28	350.0	88.44	339.2	87.04	315.2	85.40
	5.0	4.1	368.4	91.48	368.4	89.12	362.0	87.28	350.0	85.52	339.2	84.44	315.2	82.88
	7.0	6.0	379.6	88.32	377.2	85.92	362.0	84.24	350.0	82.60	339.2	81.84	315.2	80.36
	9.0	7.9	381.2	85.96	377.2	83.64	362.0	82.00	350.0	80.44	339.2	79.68	315.2	78.24
	11.0	9.8	381.2	84.40	377.2	82.12	362.0	80.48	350.0	78.96	339.2	78.20	315.2	76.80
	13.0	11.8	381.2	82.68	377.2	80.44	362.0	78.88	350.0	77.36	339.2	76.64	315.2	75.28
15.0	13.7	381.2	80.88	377.2	78.68	362.0	77.12	350.0	75.64	339.2	74.92	315.2	73.60	
110	-24.8	-25	179.6	104.4	179.6	105.5	178.4	106.6	178.4	108.3	178.4	109.4	174.8	110.0
	-21.8	-22	221.2	106.1	221.2	107.2	219.6	108.3	219.6	109.9	219.6	111.1	215.6	111.6
	-19.8	-20	234.8	107.2	234.8	108.3	233.2	109.4	233.2	111.0	233.2	112.2	228.8	112.8
	-18.8	-19	240.0	107.8	240.0	108.9	238.4	109.9	238.4	111.6	238.4	112.8	234.0	111.4
	-16.7	-17	251.2	108.9	251.2	110.0	249.6	111.1	249.6	112.8	249.6	109.9	244.8	108.4
	-13.7	-15	266.8	110.6	266.8	111.7	265.2	112.8	265.2	108.4	265.2	105.8	265.2	104.2
	-11.8	-13	275.6	111.6	275.6	112.8	274.0	109.7	274.0	105.7	274.0	103.2	274.0	101.5
	-9.8	-11	284.8	112.8	284.8	109.3	283.2	106.5	283.2	102.8	283.2	100.5	282.0	98.72
	-9.5	-10	286.4	112.2	286.4	108.8	284.8	106.0	284.8	102.4	284.8	100.1	283.6	98.32
	-8.5	-9.1	292.0	110.4	292.0	107.1	290.4	104.4	290.4	100.9	290.4	98.68	283.6	96.88
	-7.0	-7.6	300.4	107.6	300.4	104.5	298.4	102.0	298.4	98.76	298.4	96.64	283.6	94.80
	-5.0	-5.6	311.2	103.9	311.2	101.0	309.2	98.80	309.2	95.88	303.6	93.92	283.6	91.96
	-3.0	-3.7	322.4	100.2	322.4	97.60	320.4	95.56	314.4	92.96	303.6	91.16	283.6	89.16
	0.0	-0.7	338.8	94.60	338.8	92.44	324.8	90.76	314.4	88.64	303.6	87.08	283.6	84.96
	3.0	2.2	355.2	89.04	346.4	87.28	324.8	85.92	314.4	84.32	303.6	82.96	283.6	80.72
	5.0	4.1	366.4	85.32	346.4	83.84	324.8	82.72	314.4	81.40	303.6	80.24	283.6	77.92
	7.0	6.0	366.4	81.60	346.4	80.40	324.8	79.48	314.4	78.52	303.6	77.52	283.6	75.12
	9.0	7.9	366.4	79.08	346.4	77.92	324.8	77.04	314.4	76.08	303.6	75.12	283.6	72.80
	11.0	9.8	366.4	77.28	346.4	76.12	324.8	75.24	314.4	74.32	303.6	73.36	283.6	71.12
	13.0	11.8	366.4	75.28	346.4	74.16	324.8	73.32	314.4	72.44	303.6	71.52	283.6	69.32
15.0	13.7	366.4	73.20	346.4	72.08	324.8	71.28	314.4	70.40	303.6	69.52	283.6	67.36	

# 7. Capacity Tables

Heating Capacity (96HP)

Combination (%)	Outdoor air temp.		Indoor air temp. °C DB											
			16		18		20		21		22		24	
	°C DB	°C WB	TC	PI	TC	PI	TC	PI	TC	PI	TC	PI	TC	PI
100	-24.8	-25	178.8	115.9	178.8	115.5	177.6	107.8	177.6	114.5	177.6	114.0	174.0	113.8
	-21.8	-22	220.0	115.3	220.0	114.9	218.8	111.2	218.8	113.8	218.8	115.0	214.4	113.2
	-19.8	-20	233.6	114.9	233.6	114.4	232.4	113.3	232.4	113.4	232.4	113.5	228.0	112.8
	-18.8	-19	238.8	114.7	237.6	114.2	237.6	113.8	237.6	113.2	237.6	112.8	232.8	111.0
	-16.7	-17	248.4	114.2	248.4	113.8	248.4	115.0	247.2	112.8	247.2	109.2	242.4	107.4
	-13.7	-15	265.6	113.6	265.6	113.2	264.0	112.8	264.0	107.6	264.0	104.1	259.2	102.2
	-11.8	-13	274.4	113.2	272.8	112.8	272.8	109.3	272.8	104.3	272.8	100.8	259.2	98.88
	-9.8	-11	283.2	112.8	283.2	108.9	282.0	105.7	282.0	100.9	278.0	97.44	259.2	95.40
	-9.5	-10	284.8	112.2	284.8	108.3	283.6	105.2	283.6	100.4	278.0	96.92	259.2	94.88
	-8.5	-9.1	290.4	110.2	290.4	106.4	289.2	103.3	287.6	98.64	278.0	95.24	259.2	93.12
	-7.0	-7.6	303.6	107.2	302.4	103.5	297.2	100.6	287.6	96.08	278.0	92.68	259.2	90.52
	-5.0	-5.6	316.8	103.1	313.6	99.68	297.2	97.00	287.6	92.60	278.0	89.28	259.2	87.04
	-3.0	-3.7	326.0	99.12	316.4	95.80	297.2	93.36	287.6	89.16	278.0	85.88	259.2	83.56
	0.0	-0.7	335.2	93.08	316.4	90.04	297.2	87.92	287.6	84.00	278.0	80.76	259.2	78.36
	3.0	2.2	335.2	87.04	316.4	84.24	297.2	82.48	287.6	78.84	278.0	75.64	259.2	73.16
	5.0	4.1	335.2	83.04	316.4	80.40	297.2	78.84	287.6	75.40	278.0	72.24	259.2	69.68
	7.0	6.0	335.2	79.00	316.4	76.52	297.2	75.20	287.6	71.96	278.0	68.84	259.2	66.20
	9.0	7.9	335.2	76.24	316.4	73.84	297.2	72.56	287.6	69.44	278.0	66.44	259.2	63.88
	11.0	9.8	335.2	74.12	316.4	71.80	297.2	70.56	287.6	67.48	278.0	64.56	259.2	62.12
	13.0	11.8	335.2	71.88	316.4	69.60	297.2	68.40	287.6	65.44	278.0	62.60	259.2	60.20
15.0	13.7	335.2	69.48	316.4	67.28	297.2	66.12	287.6	63.24	278.0	60.52	259.2	58.20	
90	-24.8	-25	178.0	102.9	178.0	104.5	176.8	105.7	176.8	106.2	176.8	107.4	173.6	109.0
	-21.8	-22	219.2	104.5	219.2	106.2	218.0	107.4	218.0	107.9	218.0	109.0	213.6	104.4
	-19.8	-20	232.8	105.6	232.8	107.3	231.2	108.5	231.2	109.0	231.2	109.9	226.8	101.4
	-18.8	-19	238.8	106.2	237.6	107.9	236.4	109.0	236.4	107.4	236.4	104.3	232.0	99.84
	-16.7	-17	248.4	107.4	248.4	109.0	247.6	105.7	247.6	104.0	247.6	101.0	236.8	96.60
	-13.7	-15	265.6	109.0	265.6	104.1	263.2	101.0	263.2	99.20	255.2	96.32	236.8	92.00
	-11.8	-13	274.4	105.6	272.8	101.0	271.6	97.92	263.6	96.12	255.2	93.36	236.8	89.08
	-9.8	-11	283.2	102.1	283.2	97.68	272.0	94.76	263.6	92.88	255.2	90.20	236.8	86.00
	-9.5	-10	284.8	101.6	284.8	97.16	272.0	94.28	263.6	92.40	255.2	89.72	236.8	85.52
	-8.5	-9.1	290.4	99.80	288.4	95.52	272.0	92.68	263.6	90.80	255.2	88.16	236.8	84.00
	-7.0	-7.6	303.6	97.12	288.8	93.04	272.0	90.32	263.6	88.36	255.2	85.80	236.8	81.68
	-5.0	-5.6	306.8	93.56	288.8	89.76	272.0	87.16	263.6	85.16	255.2	82.68	236.8	78.64
	-3.0	-3.7	306.8	90.00	288.8	86.48	272.0	83.96	263.6	81.92	255.2	79.52	236.8	75.56
	0.0	-0.7	306.8	84.68	288.8	81.52	272.0	79.20	263.6	77.08	255.2	74.80	236.8	70.96
	3.0	2.2	306.8	79.32	288.8	76.56	272.0	74.44	263.6	72.24	255.2	70.12	236.8	66.32
	5.0	4.1	306.8	75.76	288.8	73.28	272.0	71.28	263.6	69.00	255.2	66.96	236.8	63.24
	7.0	6.0	306.8	72.20	288.8	70.00	272.0	68.12	263.6	65.80	255.2	63.84	236.8	60.20
	9.0	7.9	306.8	68.84	288.8	66.72	272.0	64.92	263.6	62.72	255.2	60.84	236.8	57.40
	11.0	9.8	306.8	65.48	288.8	63.48	272.0	61.76	263.6	59.64	255.2	57.88	236.8	54.56
	13.0	11.8	306.8	62.12	288.8	60.20	272.0	58.60	263.6	56.60	255.2	54.92	236.8	51.76
15.0	13.7	306.8	58.76	288.8	56.96	272.0	55.40	263.6	53.52	255.2	51.92	236.8	48.96	
80	-24.8	-25	177.2	90.52	177.2	92.20	176.0	93.36	176.0	93.92	176.0	96.68	172.8	92.64
	-21.8	-22	216.8	92.20	216.8	93.84	216.8	95.00	216.8	96.68	216.8	92.64	211.6	88.72
	-19.8	-20	230.4	93.28	230.4	94.96	230.4	96.68	230.4	93.84	227.6	89.92	211.6	86.12
	-18.8	-19	235.6	93.84	235.6	96.68	235.6	95.24	235.6	92.40	227.6	88.56	211.6	84.84
	-16.7	-17	243.2	96.68	243.2	93.68	243.2	92.20	236.0	89.40	227.6	85.76	211.6	82.12
	-13.7	-15	254.4	92.24	249.2	89.36	243.2	87.88	236.0	85.12	227.6	81.68	211.6	78.20
	-11.8	-13	260.4	89.40	252.8	86.64	243.2	85.12	236.0	82.40	227.6	79.12	211.6	75.72
	-9.8	-11	267.2	86.44	256.4	83.80	243.2	82.24	236.0	79.56	227.6	76.40	211.6	73.12
	-9.5	-10	269.2	86.00	258.0	83.36	243.2	81.80	236.0	79.12	227.6	76.00	211.6	72.76
	-8.5	-9.1	272.0	84.52	259.2	81.92	243.2	80.36	236.0	77.68	227.6	74.68	211.6	71.44
	-7.0	-7.6	274.8	82.28	259.2	79.76	243.2	78.20	236.0	75.56	227.6	72.64	211.6	69.48
	-5.0	-5.6	274.8	79.32	259.2	76.92	243.2	75.28	236.0	72.68	227.6	69.92	211.6	66.88
	-3.0	-3.7	274.8	76.36	259.2	74.04	243.2	72.40	236.0	69.84	227.6	67.24	211.6	64.28
	0.0	-0.7	274.8	71.88	259.2	69.76	243.2	68.08	236.0	65.56	227.6	63.16	211.6	60.40
	3.0	2.2	274.8	67.44	259.2	65.44	243.2	63.72	236.0	61.24	227.6	59.12	211.6	56.48
	5.0	4.1	274.8	64.48	259.2	62.60	243.2	60.84	236.0	58.40	227.6	56.40	211.6	53.88
	7.0	6.0	274.8	61.52	259.2	59.72	243.2	57.96	236.0	55.56	227.6	53.72	211.6	51.28
	9.0	7.9	274.8	57.76	259.2	56.08	243.2	54.40	236.0	52.16	227.6	50.44	211.6	48.16
	11.0	9.8	274.8	53.60	259.2	52.04	243.2	50.52	236.0	48.40	227.6	46.80	211.6	44.68
	13.0	11.8	274.8	50.04	259.2	48.56	243.2	47.16	236.0	45.20	227.6	43.68	211.6	41.72
15.0	13.7	274.8	47.08	259.2	45.72	243.2	44.36	236.0	42.52	227.6	41.12	211.6	39.28	

# 7. Capacity Tables

Heating Capacity (96HP)

Combination (%)	Outdoor air temp.		Indoor air temp. °C DB											
			16		18		20		21		22		24	
	°C DB	°C WB	TC	PI	TC	PI	TC	PI	TC	PI	TC	PI	TC	PI
70	-24.8	-25	177.2	91.08	177.2	91.64	176.0	92.76	176.0	94.44	176.0	90.00	172.8	85.84
	-21.8	-22	208.4	92.76	208.4	93.32	207.2	94.44	200.0	90.00	194.0	85.84	181.2	81.84
	-19.8	-20	229.2	93.88	220.0	94.44	207.2	91.32	200.0	87.04	194.0	83.08	181.2	79.16
	-18.8	-19	233.2	94.44	220.0	92.84	207.2	89.76	200.0	85.56	194.0	81.68	181.2	77.80
	-16.7	-17	233.2	91.08	220.0	89.44	207.2	86.52	200.0	82.44	194.0	78.80	181.2	75.00
	-13.7	-15	233.2	86.36	220.0	84.64	207.2	81.84	200.0	78.04	194.0	74.64	181.2	70.96
	-11.8	-13	233.2	83.32	220.0	81.60	207.2	78.88	200.0	75.20	194.0	72.00	181.2	68.44
	-9.8	-11	233.2	80.16	220.0	78.36	207.2	75.80	200.0	72.24	194.0	69.24	181.2	65.76
	-9.5	-10	233.2	79.68	220.0	77.88	207.2	75.32	200.0	71.80	194.0	68.84	181.2	65.36
	-8.5	-9.1	233.2	78.12	220.0	76.28	207.2	73.76	200.0	70.32	194.0	67.44	181.2	64.00
	-7.0	-7.6	233.2	75.72	220.0	73.88	207.2	71.44	200.0	68.12	194.0	65.36	181.2	62.00
	-5.0	-5.6	233.2	72.56	220.0	70.68	207.2	68.32	200.0	65.16	194.0	62.60	181.2	59.32
	-3.0	-3.7	233.2	69.40	220.0	67.44	207.2	65.20	200.0	62.20	194.0	59.84	181.2	56.64
	0.0	-0.7	233.2	64.64	220.0	62.64	207.2	60.56	200.0	57.76	194.0	55.68	181.2	52.64
	3.0	2.2	233.2	59.88	220.0	57.84	207.2	55.88	200.0	53.36	194.0	51.52	181.2	48.60
	5.0	4.1	233.2	56.72	220.0	54.60	207.2	52.80	200.0	50.40	194.0	48.76	181.2	45.92
	7.0	6.0	233.2	53.56	220.0	51.40	207.2	49.68	200.0	47.44	194.0	46.00	181.2	43.24
	9.0	7.9	233.2	48.36	220.0	46.40	207.2	44.88	200.0	42.84	194.0	41.56	181.2	39.04
	11.0	9.8	233.2	45.04	220.0	43.20	207.2	41.76	200.0	39.88	194.0	38.68	181.2	36.36
	13.0	11.8	233.2	42.12	220.0	40.44	207.2	39.08	200.0	37.32	194.0	36.20	181.2	34.04
15.0	13.7	233.2	39.72	220.0	38.12	207.2	36.84	200.0	35.16	194.0	34.12	181.2	32.08	
60	-24.8	-25	177.2	89.96	177.2	91.08	176.0	92.76	171.6	88.00	165.6	83.56	155.2	79.36
	-21.8	-22	190.8	91.64	189.2	92.76	177.6	88.00	171.6	83.56	165.6	79.36	155.2	75.32
	-19.8	-20	200.0	92.76	189.2	89.40	177.6	84.84	171.6	80.60	165.6	76.56	155.2	72.60
	-18.8	-19	200.0	91.08	189.2	87.72	177.6	83.24	171.6	79.08	165.6	75.16	155.2	71.24
	-16.7	-17	200.0	87.52	189.2	84.20	177.6	79.92	171.6	75.96	165.6	72.24	155.2	68.40
	-13.7	-15	200.0	82.44	189.2	79.20	177.6	75.20	171.6	71.52	165.6	68.04	155.2	64.36
	-11.8	-13	200.0	79.24	189.2	76.00	177.6	72.16	171.6	68.88	165.6	65.40	155.2	61.80
	-9.8	-11	200.0	75.88	189.2	72.64	177.6	69.00	171.6	65.72	165.6	62.60	155.2	59.08
	-9.5	-10	200.0	75.36	189.2	72.16	177.6	68.52	171.6	65.28	165.6	62.16	155.2	58.68
	-8.5	-9.1	200.0	73.68	189.2	70.48	177.6	66.96	171.6	63.80	165.6	60.76	155.2	57.32
	-7.0	-7.6	200.0	71.16	189.2	67.96	177.6	64.60	171.6	61.56	165.6	58.68	155.2	55.28
	-5.0	-5.6	200.0	67.76	189.2	64.60	177.6	61.40	171.6	58.60	165.6	55.88	155.2	52.60
	-3.0	-3.7	200.0	64.40	189.2	61.24	177.6	58.24	171.6	55.64	165.6	53.08	155.2	49.88
	0.0	-0.7	200.0	59.32	189.2	56.24	177.6	53.52	171.6	51.16	165.6	48.88	155.2	45.84
	3.0	2.2	200.0	54.24	189.2	51.20	177.6	48.76	171.6	46.72	165.6	44.72	155.2	41.76
	5.0	4.1	200.0	50.88	189.2	47.84	177.6	45.60	171.6	43.76	165.6	41.92	155.2	39.08
	7.0	6.0	200.0	47.52	189.2	44.48	177.6	42.44	171.6	40.76	165.6	39.12	155.2	36.36
	9.0	7.9	200.0	42.40	189.2	39.72	177.6	37.84	171.6	36.36	165.6	34.88	155.2	32.44
	11.0	9.8	200.0	39.56	189.2	37.08	177.6	35.36	171.6	33.96	165.6	32.60	155.2	30.28
	13.0	11.8	200.0	37.08	189.2	34.72	177.6	33.12	171.6	31.80	165.6	30.52	155.2	28.40
15.0	13.7	200.0	35.04	189.2	32.84	177.6	31.28	171.6	30.08	165.6	28.84	155.2	26.84	
50	-24.8	-25	166.8	78.60	157.2	80.28	148.0	76.08	143.2	72.16	138.4	68.44	128.8	65.00
	-21.8	-22	166.8	80.28	157.2	76.08	148.0	72.16	143.2	68.44	138.4	65.00	128.8	61.68
	-19.8	-20	166.8	77.36	157.2	73.28	148.0	69.56	143.2	65.96	138.4	62.68	128.8	59.44
	-18.8	-19	166.8	75.88	157.2	71.88	148.0	68.24	143.2	64.76	138.4	61.52	128.8	58.32
	-16.7	-17	166.8	72.84	157.2	68.96	148.0	65.52	143.2	62.16	138.4	59.12	128.8	56.00
	-13.7	-15	166.8	68.48	157.2	64.76	148.0	61.60	143.2	58.44	138.4	55.68	128.8	52.68
	-11.8	-13	166.8	65.72	157.2	62.12	148.0	59.12	143.2	56.08	138.4	53.48	128.8	50.56
	-9.8	-11	166.8	62.80	157.2	59.32	148.0	56.48	143.2	53.60	138.4	51.16	128.8	48.32
	-9.5	-10	166.8	62.36	157.2	58.92	148.0	56.12	143.2	53.24	138.4	50.84	128.8	48.00
	-8.5	-9.1	166.8	60.88	157.2	57.52	148.0	54.80	143.2	52.00	138.4	49.68	128.8	46.88
	-7.0	-7.6	166.8	58.72	157.2	55.44	148.0	52.84	143.2	50.16	138.4	47.96	128.8	45.24
	-5.0	-5.6	166.8	55.80	157.2	52.64	148.0	50.24	143.2	47.68	138.4	45.64	128.8	43.00
	-3.0	-3.7	166.8	52.88	157.2	49.84	148.0	47.60	143.2	45.20	138.4	43.32	128.8	40.80
	0.0	-0.7	166.8	48.52	157.2	45.64	148.0	43.68	143.2	41.48	138.4	39.88	128.8	37.44
	3.0	2.2	166.8	44.16	157.2	41.48	148.0	39.80	143.2	37.76	138.4	36.44	128.8	34.12
	5.0	4.1	166.8	41.24	157.2	38.68	148.0	37.16	143.2	35.32	138.4	34.12	128.8	31.92
	7.0	6.0	166.8	38.32	157.2	35.88	148.0	34.56	143.2	32.84	138.4	31.80	128.8	29.68
	9.0	7.9	166.8	34.60	157.2	32.40	148.0	31.20	143.2	29.64	138.4	28.72	128.8	26.80
	11.0	9.8	166.8	32.36	157.2	30.32	148.0	29.20	143.2	27.76	138.4	26.88	128.8	25.08
	13.0	11.8	166.8	30.40	157.2	28.48	148.0	27.40	143.2	26.04	138.4	25.24	128.8	23.56
15.0	13.7	166.8	28.76	157.2	26.92	148.0	25.96	143.2	24.64	138.4	23.88	128.8	22.28	

**Note**

1. TC: Total Capacity(kW), PI : Power Input(kW, Comp. + Outdoor fan motor)
2. Capacity tables show the average value of conditions which may occur.
3. The heating capacity table is based on the values expressed as Max. in the specification of the outdoor unit. (When measuring the Max. heating capacity, the setting status of the indoor unit is the same as that for measuring the heating capacity of the indoor unit.)

# 7. Capacity Tables

## 7.2.2 SLC Mode

### ◆ ARUM080LTE5

Heating Capacity (8HP)

Combination (%)	Outdoor air temp.		Indoor air temp. °C DB											
			16		18		20		21		22		24	
	°C DB	°C WB	TC	PI	TC	PI	TC	PI	TC	PI	TC	PI	TC	PI
130	-24.8	-25	15.6	7.34	15.6	7.39	15.5	7.43	15.5	7.50	15.5	7.56	15.2	7.66
	-21.8	-22	19.0	7.44	19.0	7.49	18.9	7.53	18.9	7.60	18.9	7.66	18.5	7.76
	-19.8	-20	20.1	7.50	20.1	7.55	19.9	7.60	19.9	7.66	19.9	7.72	19.5	7.82
	-18.8	-19	20.5	7.54	20.5	7.59	20.4	7.63	20.4	7.69	20.4	7.76	20.0	7.85
	-16.7	-17	21.5	7.61	21.5	7.65	21.4	7.70	21.4	7.76	21.4	7.82	21.0	7.92
	-13.7	-15	22.9	7.70	22.9	7.75	22.8	7.79	22.8	7.86	22.8	7.92	22.3	7.97
	-11.8	-13	23.7	7.77	23.7	7.81	23.5	7.86	23.5	7.92	23.5	7.98	23.2	7.94
	-9.8	-11	24.5	7.83	24.5	7.88	24.3	7.92	24.3	7.98	24.3	8.04	24.1	7.90
	-9.5	-10	24.6	7.84	24.6	7.89	24.5	7.88	24.5	7.92	24.4	7.96	24.3	7.97
	-8.5	-9.1	25.1	7.87	25.1	7.92	24.9	7.74	24.9	7.48	24.8	7.26	24.7	6.95
	-7.0	-7.6	25.8	7.92	25.8	7.71	25.6	7.53	25.6	7.29	25.6	7.06	25.4	6.77
	-5.0	-5.6	26.7	7.64	26.7	7.43	26.5	7.26	26.5	7.02	26.5	6.81	26.3	6.53
	-3.0	-3.7	27.6	7.36	27.6	7.15	27.5	6.98	27.5	6.76	27.5	6.55	27.3	6.30
	0.0	-0.7	29.0	6.94	29.0	6.74	28.9	6.56	28.9	6.36	28.9	6.17	28.4	5.94
	3.0	2.2	30.4	6.51	30.4	6.32	30.2	6.15	30.2	5.96	30.2	5.78	28.4	5.58
	5.0	4.1	30.8	5.67	30.7	5.49	30.6	5.33	30.6	5.16	29.9	5.00	27.9	4.83
	7.0	6.0	30.9	5.30	30.8	5.13	30.7	4.98	30.2	4.83	29.2	4.69	27.2	4.55
9.0	7.9	30.0	4.85	30.0	4.69	29.9	4.56	29.1	4.42	28.1	4.29	26.2	4.16	
11.0	9.8	28.4	4.46	28.3	4.32	28.2	4.20	27.5	4.07	26.6	3.95	24.8	3.83	
13.0	11.8	26.7	4.02	26.6	3.89	26.5	3.78	25.9	3.67	25.0	3.56	23.2	3.45	
15.0	13.7	25.2	3.63	25.2	3.52	25.1	3.41	24.5	3.32	23.6	3.22	22.0	3.12	
120	-24.8	-25	15.5	7.39	15.5	7.43	15.4	7.50	15.4	7.56	15.4	7.66	15.1	7.73
	-21.8	-22	18.9	7.49	18.9	7.53	18.8	7.60	18.8	7.66	18.8	7.76	18.4	7.82
	-19.8	-20	19.9	7.55	19.9	7.60	19.8	7.66	19.8	7.72	19.8	7.82	19.4	7.89
	-18.8	-19	20.4	7.59	20.4	7.63	20.3	7.69	20.3	7.76	20.3	7.85	19.9	7.92
	-16.7	-17	21.4	7.65	21.4	7.70	21.2	7.76	21.2	7.82	21.2	7.92	20.8	7.69
	-13.7	-15	22.8	7.75	22.8	7.79	22.6	7.86	22.6	7.92	22.6	7.98	22.2	7.37
	-11.8	-13	23.5	7.81	23.5	7.86	23.4	7.92	23.4	7.98	23.4	8.04	23.1	7.16
	-9.8	-11	24.3	7.88	24.3	7.92	24.2	7.98	24.2	8.04	24.2	8.10	24.0	6.94
	-9.5	-10	24.4	7.89	24.4	7.88	24.3	7.61	24.3	7.38	24.3	7.10	24.1	6.91
	-8.5	-9.1	24.9	7.92	24.9	7.73	24.8	7.47	24.8	7.25	24.8	6.98	24.6	6.80
	-7.0	-7.6	25.6	7.70	25.6	7.51	25.4	7.27	25.4	7.06	25.4	6.81	25.2	6.64
	-5.0	-5.6	26.5	7.40	26.5	7.22	26.4	6.99	26.4	6.80	26.4	6.58	26.2	6.42
	-3.0	-3.7	27.5	7.10	27.5	6.93	27.3	6.72	27.3	6.54	27.3	6.35	26.7	6.20
	0.0	-0.7	28.8	6.66	28.8	6.49	28.7	6.31	28.7	6.15	28.7	6.00	26.7	5.87
	3.0	2.2	30.2	6.21	30.2	6.05	30.0	5.90	29.7	5.77	28.8	5.66	26.7	5.54
	5.0	4.1	30.6	5.37	30.5	5.22	30.1	5.10	29.1	4.99	28.2	4.91	26.2	4.81
	7.0	6.0	30.7	5.00	30.5	4.86	29.3	4.76	28.4	4.67	27.5	4.63	25.5	4.55
9.0	7.9	29.8	4.57	29.4	4.44	28.3	4.36	27.3	4.27	26.5	4.23	24.6	4.16	
11.0	9.8	28.2	4.19	27.8	4.08	26.7	4.00	25.8	3.92	25.0	3.89	23.2	3.82	
13.0	11.8	26.5	3.77	26.1	3.67	25.1	3.59	24.3	3.52	23.5	3.49	21.8	3.43	
15.0	13.7	25.0	3.40	24.7	3.30	23.7	3.24	22.9	3.18	22.2	3.15	20.7	3.09	
110	-24.8	-25	15.4	7.43	15.4	7.50	15.3	7.56	15.3	7.66	15.3	7.73	15.0	7.76
	-21.8	-22	18.8	7.53	18.8	7.60	18.7	7.66	18.7	7.76	18.7	7.82	18.3	7.86
	-19.8	-20	19.8	7.60	19.8	7.66	19.7	7.72	19.7	7.82	19.7	7.89	19.3	7.92
	-18.8	-19	20.3	7.63	20.3	7.69	20.2	7.76	20.2	7.85	20.2	7.92	19.7	7.80
	-16.7	-17	21.3	7.70	21.3	7.76	21.1	7.82	21.1	7.92	21.1	7.98	20.7	7.56
	-13.7	-15	22.7	7.79	22.7	7.86	22.5	7.92	22.5	7.98	22.5	8.04	22.5	7.21
	-11.8	-13	23.4	7.86	23.4	7.92	23.3	7.98	23.3	8.04	23.3	8.10	23.3	6.98
	-9.8	-11	24.2	7.92	24.2	7.98	24.0	8.04	24.0	8.10	24.0	8.16	24.0	6.75
	-9.5	-10	24.3	7.87	24.3	7.81	24.2	7.75	24.2	7.69	24.2	7.63	24.0	6.71
	-8.5	-9.1	24.8	7.71	24.8	7.65	24.6	7.59	24.6	7.53	24.6	7.47	24.0	6.59
	-7.0	-7.6	25.5	7.47	25.5	7.41	25.3	7.35	25.3	7.29	25.3	7.23	24.0	6.42
	-5.0	-5.6	26.4	7.14	26.4	7.08	26.2	7.02	26.2	6.96	26.2	6.90	24.0	6.18
	-3.0	-3.7	27.3	6.82	27.3	6.76	27.1	6.70	27.1	6.64	27.1	6.58	24.0	5.95
	0.0	-0.7	28.7	6.33	28.7	6.27	28.6	6.21	28.6	6.15	28.6	6.09	24.0	5.60
	3.0	2.2	30.1	5.84	29.4	5.71	27.6	5.61	26.7	5.49	25.8	5.39	24.0	5.24
	5.0	4.1	30.4	5.01	28.8	4.91	27.0	4.83	26.1	4.74	25.2	4.66	23.6	4.52
	7.0	6.0	29.7	4.62	28.0	4.55	26.3	4.50	25.5	4.44	24.6	4.39	23.0	4.25
9.0	7.9	28.6	4.20	27.0	4.14	25.4	4.09	24.5	4.04	23.7	3.99	22.1	3.87	
11.0	9.8	27.0	3.84	25.5	3.78	24.0	3.74	23.2	3.69	22.4	3.64	20.9	3.53	
13.0	11.8	25.4	3.42	24.0	3.37	22.5	3.33	21.8	3.29	21.0	3.25	19.6	3.15	
15.0	13.7	24.0	3.06	22.7	3.02	21.3	2.98	20.6	2.95	19.9	2.91	18.6	2.82	

# 7. Capacity Tables

Heating Capacity (8HP)

Combination (%)	Outdoor air temp.		Indoor air temp. °C DB											
			16		18		20		21		22		24	
	°C DB	°C WB	TC	PI	TC	PI	TC	PI	TC	PI	TC	PI	TC	PI
100	-24.8	-25	15.4	8.23	15.4	8.19	15.3	7.60	15.3	8.09	15.3	8.05	15.0	8.03
	-21.8	-22	18.7	8.17	18.7	8.13	18.6	7.84	18.6	8.03	18.6	8.10	18.2	7.96
	-19.8	-20	19.7	8.13	19.7	8.09	19.6	7.99	19.6	7.99	19.6	7.98	19.2	7.92
	-18.8	-19	20.2	8.11	20.1	8.07	20.1	8.03	20.1	7.97	20.1	7.92	19.7	7.78
	-16.7	-17	21.0	8.06	21.0	8.02	21.0	8.10	20.9	7.92	20.9	7.63	20.5	7.49
	-13.7	-15	22.6	8.00	22.6	7.96	22.4	7.92	22.4	7.50	22.4	7.22	22.0	7.08
	-11.8	-13	23.3	7.96	23.2	7.92	23.2	7.63	23.2	7.23	23.2	6.96	22.0	6.81
	-9.8	-11	24.0	7.92	24.0	7.60	23.9	7.33	23.9	6.95	23.6	6.68	22.0	6.54
	-9.5	-10	24.2	7.87	24.2	7.55	24.1	7.28	24.1	6.90	23.6	6.64	22.0	6.49
	-8.5	-9.1	24.6	7.70	24.6	7.38	24.5	7.13	24.4	6.76	23.6	6.51	22.0	6.36
	-7.0	-7.6	25.8	7.44	25.6	7.14	25.2	6.90	24.4	6.55	23.6	6.30	22.0	6.15
	-5.0	-5.6	26.9	7.09	26.6	6.82	25.2	6.60	24.4	6.27	23.6	6.02	22.0	5.87
	-3.0	-3.7	27.7	6.75	26.8	6.49	25.2	6.30	24.4	5.99	23.6	5.75	22.0	5.59
	0.0	-0.7	28.4	6.23	26.8	6.00	25.2	5.84	24.4	5.56	23.6	5.34	22.0	5.18
	3.0	2.2	28.4	5.71	26.8	5.51	25.2	5.39	24.4	5.14	23.6	4.93	22.0	4.76
	5.0	4.1	27.9	4.88	26.3	4.71	24.7	4.61	23.9	4.39	23.1	4.21	21.5	4.06
	7.0	6.0	27.1	4.47	25.6	4.33	24.1	4.25	23.3	4.07	22.5	3.89	21.0	3.75
	9.0	7.9	26.2	4.04	24.7	3.91	23.2	3.84	22.4	3.67	21.7	3.52	20.2	3.38
11.0	9.8	24.7	3.65	23.3	3.54	21.9	3.48	21.2	3.33	20.5	3.18	19.1	3.06	
13.0	11.8	23.2	3.22	21.9	3.12	20.6	3.07	19.9	2.94	19.3	2.81	18.0	2.70	
15.0	13.7	22.0	2.85	20.7	2.76	19.5	2.71	18.9	2.59	18.2	2.48	17.0	2.38	
90	-24.8	-25	15.3	7.31	15.3	7.41	15.2	7.48	15.2	7.51	15.2	7.58	14.9	7.68
	-21.8	-22	18.6	7.41	18.6	7.51	18.5	7.58	18.5	7.61	18.5	7.68	18.1	7.31
	-19.8	-20	19.7	7.48	19.7	7.57	19.5	7.64	19.5	7.68	19.5	7.72	19.1	7.07
	-18.8	-19	20.2	7.51	20.1	7.61	20.0	7.68	20.0	7.54	20.0	7.30	19.6	6.95
	-16.7	-17	21.0	7.58	21.0	7.68	21.0	7.40	21.0	7.27	21.0	7.03	20.1	6.69
	-13.7	-15	22.6	7.68	22.6	7.27	22.3	7.01	22.3	6.88	21.6	6.66	20.1	6.33
	-11.8	-13	23.3	7.39	23.2	7.01	23.1	6.77	22.3	6.63	21.6	6.42	20.1	6.10
	-9.8	-11	24.0	7.09	24.0	6.74	23.1	6.51	22.3	6.37	21.6	6.17	20.1	5.86
	-9.5	-10	24.2	7.05	24.2	6.69	23.1	6.47	22.3	6.33	21.6	6.13	20.1	5.82
	-8.5	-9.1	24.6	6.90	24.5	6.56	23.1	6.34	22.3	6.20	21.6	6.00	20.1	5.70
	-7.0	-7.6	25.8	6.68	24.5	6.35	23.1	6.14	22.3	6.01	21.6	5.82	20.1	5.52
	-5.0	-5.6	26.0	6.38	24.5	6.08	23.1	5.89	22.3	5.75	21.6	5.56	20.1	5.28
	-3.0	-3.7	26.0	6.08	24.5	5.81	23.1	5.63	22.3	5.49	21.6	5.31	20.1	5.04
	0.0	-0.7	26.0	5.63	24.5	5.40	23.1	5.24	22.3	5.09	21.6	4.94	20.1	4.67
	3.0	2.2	26.0	5.19	24.5	4.99	23.1	4.85	22.3	4.70	21.6	4.56	20.1	4.31
	5.0	4.1	25.5	4.43	24.0	4.27	22.6	4.15	21.9	4.02	21.2	3.89	19.7	3.67
	7.0	6.0	24.9	4.08	23.4	3.96	22.0	3.85	21.3	3.72	20.6	3.61	19.2	3.40
	9.0	7.9	23.9	3.69	22.5	3.57	21.2	3.48	20.6	3.36	19.9	3.26	18.5	3.07
11.0	9.8	22.6	3.31	21.3	3.20	20.1	3.12	19.4	3.01	18.8	2.92	17.5	2.76	
13.0	11.8	21.3	2.86	20.0	2.77	18.8	2.70	18.3	2.60	17.7	2.53	16.4	2.38	
15.0	13.7	20.1	2.50	18.9	2.42	17.8	2.35	17.3	2.27	16.7	2.21	15.5	2.08	
80	-24.8	-25	15.2	6.44	15.2	6.54	15.1	6.61	15.1	6.64	15.1	6.81	14.8	6.49
	-21.8	-22	18.4	6.54	18.4	6.64	18.4	6.71	18.4	6.81	18.4	6.49	17.9	6.18
	-19.8	-20	19.4	6.61	19.4	6.70	19.4	6.81	19.4	6.58	19.3	6.27	17.9	5.98
	-18.8	-19	19.9	6.64	19.9	6.81	19.9	6.69	19.9	6.46	19.3	6.17	17.9	5.88
	-16.7	-17	20.6	6.81	20.6	6.56	20.6	6.44	20.0	6.23	19.3	5.94	17.9	5.66
	-13.7	-15	21.6	6.44	21.1	6.21	20.6	6.10	20.0	5.88	19.3	5.62	17.9	5.36
	-11.8	-13	22.1	6.21	21.5	5.99	20.6	5.87	20.0	5.67	19.3	5.42	17.9	5.17
	-9.8	-11	22.7	5.96	21.8	5.76	20.6	5.64	20.0	5.44	19.3	5.21	17.9	4.96
	-9.5	-10	22.8	5.93	21.9	5.72	20.6	5.61	20.0	5.41	19.3	5.17	17.9	4.93
	-8.5	-9.1	23.1	5.80	22.0	5.60	20.6	5.49	20.0	5.29	19.3	5.07	17.9	4.83
	-7.0	-7.6	23.3	5.62	22.0	5.43	20.6	5.31	20.0	5.12	19.3	4.91	17.9	4.68
	-5.0	-5.6	23.3	5.38	22.0	5.20	20.6	5.08	20.0	4.90	19.3	4.69	17.9	4.48
	-3.0	-3.7	23.3	5.13	22.0	4.96	20.6	4.85	20.0	4.67	19.3	4.48	17.9	4.27
	0.0	-0.7	23.3	4.76	22.0	4.61	20.6	4.50	20.0	4.33	19.3	4.16	17.9	3.97
	3.0	2.2	23.3	4.40	22.0	4.26	20.6	4.15	20.0	3.99	19.3	3.84	17.9	3.67
	5.0	4.1	22.8	3.76	21.5	3.64	20.2	3.54	19.6	3.40	18.9	3.28	17.6	3.13
	7.0	6.0	22.3	3.48	21.0	3.38	19.7	3.28	19.1	3.14	18.4	3.04	17.1	2.90
	9.0	7.9	21.4	3.05	20.2	2.96	19.0	2.89	18.4	2.78	17.7	2.68	16.5	2.55
11.0	9.8	20.3	2.65	19.1	2.57	17.9	2.51	17.4	2.42	16.8	2.33	15.6	2.22	
13.0	11.8	19.0	2.24	17.9	2.17	16.9	2.12	16.3	2.04	15.8	1.97	14.7	1.87	
15.0	13.7	18.0	1.95	17.0	1.90	15.9	1.85	15.5	1.78	14.9	1.72	13.9	1.64	

# 7. Capacity Tables

Heating Capacity (8HP)

Combination (%)	Outdoor air temp.		Indoor air temp. °C DB													
			16		18		20		21		22		24			
	°C DB	°C WB	TC	PI	TC	PI	TC	PI	TC	PI	TC	PI	TC	PI		
70	-24.8	-25	15.2	6.45	15.2	6.48	15.1	6.55	15.1	6.65	15.1	6.65	15.1	6.30	14.8	5.99
	-21.8	-22	17.7	6.55	17.7	6.58	17.6	6.65	17.0	6.30	16.5	5.99	15.4	5.68		
	-19.8	-20	19.3	6.61	18.7	6.65	17.6	6.40	17.0	6.08	16.5	5.77	15.4	5.48		
	-18.8	-19	19.8	6.65	18.7	6.52	17.6	6.28	17.0	5.96	16.5	5.67	15.4	5.37		
	-16.7	-17	19.8	6.38	18.7	6.26	17.6	6.03	17.0	5.72	16.5	5.44	15.4	5.16		
	-13.7	-15	19.8	6.01	18.7	5.88	17.6	5.67	17.0	5.38	16.5	5.12	15.4	4.86		
	-11.8	-13	19.8	5.77	18.7	5.64	17.6	5.44	17.0	5.16	16.5	4.92	15.4	4.66		
	-9.8	-11	19.8	5.52	18.7	5.39	17.6	5.19	17.0	4.93	16.5	4.71	15.4	4.46		
	-9.5	-10	19.8	5.48	18.7	5.35	17.6	5.16	17.0	4.90	16.5	4.68	15.4	4.43		
	-8.5	-9.1	19.8	5.35	18.7	5.22	17.6	5.04	17.0	4.79	16.5	4.57	15.4	4.33		
	-7.0	-7.6	19.8	5.16	18.7	5.03	17.6	4.85	17.0	4.61	16.5	4.41	15.4	4.17		
	-5.0	-5.6	19.8	4.91	18.7	4.78	17.6	4.61	17.0	4.39	16.5	4.20	15.4	3.97		
	-3.0	-3.7	19.8	4.66	18.7	4.53	17.6	4.37	17.0	4.16	16.5	3.99	15.4	3.77		
	0.0	-0.7	19.8	4.28	18.7	4.15	17.6	4.01	17.0	3.81	16.5	3.67	15.4	3.46		
	3.0	2.2	19.8	3.91	18.7	3.77	17.6	3.64	17.0	3.47	16.5	3.35	15.4	3.16		
	5.0	4.1	19.8	3.38	18.3	3.19	17.2	3.08	16.6	2.93	16.1	2.84	15.0	2.67		
	7.0	6.0	19.8	3.18	17.8	2.91	16.8	2.81	16.2	2.68	15.7	2.60	14.7	2.45		
	9.0	7.9	19.1	2.70	17.2	2.47	16.2	2.39	15.6	2.28	15.1	2.21	14.1	2.08		
	11.0	9.8	18.0	2.34	16.2	2.14	15.3	2.07	14.8	1.97	14.3	1.91	13.4	1.80		
	13.0	11.8	16.9	2.00	15.2	1.83	14.3	1.76	13.9	1.68	13.4	1.63	12.5	1.54		
15.0	13.7	16.0	1.72	14.4	1.57	13.6	1.52	13.1	1.45	12.7	1.41	11.9	1.32			
60	-24.8	-25	15.1	6.39	15.1	6.45	15.1	6.55	14.5	6.19	14.0	5.85	13.1	5.53		
	-21.8	-22	16.2	6.48	16.1	6.55	15.1	6.19	14.5	5.85	14.0	5.53	13.1	5.23		
	-19.8	-20	17.0	6.55	16.1	6.29	15.1	5.94	14.5	5.62	14.0	5.32	13.1	5.02		
	-18.8	-19	17.0	6.42	16.1	6.16	15.1	5.82	14.5	5.51	14.0	5.21	13.1	4.92		
	-16.7	-17	17.0	6.14	16.1	5.89	15.1	5.57	14.5	5.27	14.0	4.99	13.1	4.71		
	-13.7	-15	17.0	5.75	16.1	5.50	15.1	5.20	14.5	4.93	14.0	4.67	13.1	4.41		
	-11.8	-13	17.0	5.50	16.1	5.26	15.1	4.97	14.5	4.72	14.0	4.47	13.1	4.21		
	-9.8	-11	17.0	5.23	16.1	5.00	15.1	4.73	14.5	4.49	14.0	4.26	13.1	4.01		
	-9.5	-10	17.0	5.19	16.1	4.96	15.1	4.70	14.5	4.46	14.0	4.23	13.1	3.98		
	-8.5	-9.1	17.0	5.06	16.1	4.83	15.1	4.57	14.5	4.34	14.0	4.12	13.1	3.88		
	-7.0	-7.6	17.0	4.86	16.1	4.64	15.1	4.39	14.5	4.17	14.0	3.97	13.1	3.73		
	-5.0	-5.6	17.0	4.60	16.1	4.38	15.1	4.15	14.5	3.95	14.0	3.75	13.1	3.53		
	-3.0	-3.7	17.0	4.34	16.1	4.12	15.1	3.91	14.5	3.72	14.0	3.54	13.1	3.32		
	0.0	-0.7	17.0	3.94	16.1	3.73	15.1	3.54	14.5	3.38	14.0	3.23	13.1	3.02		
	3.0	2.2	17.0	3.55	16.1	3.35	15.1	3.18	14.5	3.04	14.0	2.91	13.1	2.72		
	5.0	4.1	16.6	2.98	15.7	2.80	14.7	2.66	14.3	2.55	13.8	2.44	12.9	2.28		
	7.0	6.0	16.2	2.69	15.3	2.52	14.4	2.40	13.9	2.31	13.4	2.21	12.6	2.06		
	9.0	7.9	15.6	2.26	14.8	2.11	13.8	2.02	13.4	1.94	12.9	1.86	12.1	1.73		
	11.0	9.8	14.8	1.96	14.0	1.83	13.1	1.75	12.7	1.68	12.2	1.61	11.4	1.50		
	13.0	11.8	13.9	1.67	13.1	1.56	12.3	1.49	11.9	1.43	11.5	1.37	10.7	1.28		
15.0	13.7	13.1	1.45	12.4	1.36	11.6	1.28	11.2	1.23	10.9	1.18	10.2	1.11			
50	-24.8	-25	14.1	5.55	13.3	5.65	12.5	5.33	12.1	5.04	11.7	4.76	10.9	4.50		
	-21.8	-22	14.1	5.65	13.3	5.33	12.5	5.04	12.1	4.76	11.7	4.50	10.9	4.25		
	-19.8	-20	14.1	5.43	13.3	5.12	12.5	4.84	12.1	4.57	11.7	4.33	10.9	4.09		
	-18.8	-19	14.1	5.32	13.3	5.01	12.5	4.74	12.1	4.48	11.7	4.24	10.9	4.01		
	-16.7	-17	14.1	5.08	13.3	4.79	12.5	4.53	12.1	4.28	11.7	4.06	10.9	3.83		
	-13.7	-15	14.1	4.75	13.3	4.47	12.5	4.24	12.1	4.01	11.7	3.80	10.9	3.59		
	-11.8	-13	14.1	4.53	13.3	4.27	12.5	4.05	12.1	3.83	11.7	3.64	10.9	3.43		
	-9.8	-11	14.1	4.31	13.3	4.06	12.5	3.85	12.1	3.65	11.7	3.47	10.9	3.27		
	-9.5	-10	14.1	4.28	13.3	4.03	12.5	3.82	12.1	3.62	11.7	3.44	10.9	3.24		
	-8.5	-9.1	14.1	4.17	13.3	3.92	12.5	3.72	12.1	3.52	11.7	3.36	10.9	3.16		
	-7.0	-7.6	14.1	4.00	13.3	3.76	12.5	3.58	12.1	3.39	11.7	3.23	10.9	3.04		
	-5.0	-5.6	14.1	3.77	13.3	3.55	12.5	3.38	12.1	3.20	11.7	3.05	10.9	2.87		
	-3.0	-3.7	14.1	3.55	13.3	3.34	12.5	3.18	12.1	3.01	11.7	2.88	10.9	2.71		
	0.0	-0.7	14.1	3.22	13.3	3.02	12.5	2.89	12.1	2.74	11.7	2.62	10.9	2.46		
	3.0	2.2	14.1	2.88	13.3	2.70	12.5	2.59	12.1	2.46	11.7	2.37	10.9	2.22		
	5.0	4.1	13.9	2.41	13.1	2.26	12.3	2.17	11.9	2.06	11.5	1.99	10.7	1.86		
	7.0	6.0	13.5	2.17	12.7	2.03	12.0	1.96	11.6	1.86	11.2	1.80	10.4	1.68		
	9.0	7.9	13.0	1.84	12.3	1.72	11.5	1.66	11.2	1.58	10.8	1.53	10.1	1.43		
	11.0	9.8	12.4	1.61	11.7	1.51	11.0	1.45	10.6	1.38	10.2	1.34	9.5	1.25		
	13.0	11.8	11.6	1.36	10.9	1.27	10.2	1.23	9.9	1.17	9.6	1.13	8.9	1.06		
15.0	13.7	10.9	1.19	10.3	1.11	9.7	1.07	9.4	1.02	9.1	0.99	8.5	0.92			

**Note**

1. TC: Total Capacity(kW), PI : Power Input(kW, Comp. + Outdoor fan motor)
2. Capacity tables show the average value of conditions which may occur.
3. The heating capacity table is based on the values expressed as Max. in the specification of the outdoor unit. (When measuring the Max. heating capacity, the setting status of the indoor unit is the same as that for measuring the heating capacity of the indoor unit.)

# 7. Capacity Tables

## ◆ ARUM100LTE5

Heating Capacity (10HP)

Combination (%)	Outdoor air temp.		Indoor air temp. °C DB											
			16		18		20		21		22		24	
	°C DB	°C WB	TC	PI	TC	PI	TC	PI	TC	PI	TC	PI	TC	PI
130	-24.8	-25	20.4	9.67	20.4	9.77	20.2	9.86	20.2	9.99	20.2	10.11	19.7	10.31
	-21.8	-22	24.7	9.87	24.7	9.97	24.6	10.05	24.6	10.18	24.6	10.31	24.0	10.50
	-19.8	-20	26.1	10.00	26.1	10.10	25.9	10.18	25.9	10.31	25.9	10.44	25.3	10.63
	-18.8	-19	26.6	10.07	26.6	10.16	26.4	10.25	26.4	10.38	26.4	10.50	25.7	10.70
	-16.7	-17	27.5	10.20	27.5	10.30	27.3	10.39	27.3	10.52	27.3	10.64	26.6	10.84
	-13.7	-15	28.8	10.40	28.8	10.50	28.7	10.58	28.7	10.71	28.7	10.84	27.9	10.27
	-11.8	-13	29.7	10.52	29.7	10.62	29.5	10.71	29.5	10.84	29.5	10.44	28.8	9.90
	-9.8	-11	30.5	10.65	30.5	10.75	30.3	10.84	30.3	10.40	30.3	10.02	29.6	9.52
	-9.5	-10	30.7	10.67	30.7	10.77	30.5	10.77	30.5	10.33	30.5	9.96	29.8	9.47
	-8.5	-9.1	31.3	10.74	31.3	10.84	31.1	10.53	31.1	10.11	30.9	9.75	30.2	9.28
	-7.0	-7.6	32.2	10.84	32.2	10.48	32.0	10.18	32.0	9.79	32.0	9.44	30.8	8.99
	-5.0	-5.6	33.4	10.34	33.4	10.00	33.2	9.72	33.2	9.35	33.2	9.02	31.7	8.61
	-3.0	-3.7	34.7	9.85	34.7	9.52	34.4	9.25	34.4	8.91	34.4	8.61	32.6	8.23
	0.0	-0.7	36.5	9.10	36.5	8.81	36.3	8.56	36.3	8.26	36.3	7.98	33.9	7.66
	3.0	2.2	38.3	8.36	38.3	8.09	38.1	7.86	38.1	7.60	38.1	7.36	35.2	7.09
	5.0	4.1	38.8	7.17	38.7	6.93	38.5	6.72	38.5	6.50	37.4	6.29	34.9	6.07
	7.0	6.0	39.0	6.56	38.9	6.35	38.7	6.16	37.8	5.98	36.5	5.81	34.0	5.63
9.0	7.9	37.5	5.88	37.5	5.69	37.3	5.52	36.4	5.36	35.1	5.20	32.7	5.05	
11.0	9.8	35.5	5.27	35.4	5.10	35.3	4.96	34.4	4.81	33.2	4.67	30.9	4.53	
13.0	11.8	33.3	4.60	33.3	4.45	33.2	4.33	32.3	4.20	31.2	4.07	29.1	3.95	
15.0	13.7	31.5	4.00	31.5	3.88	31.4	3.76	30.6	3.65	29.5	3.54	27.5	3.44	
120	-24.8	-25	20.2	9.77	20.2	9.86	20.1	9.99	20.1	10.11	20.1	10.31	19.6	10.44
	-21.8	-22	24.6	9.97	24.6	10.05	24.4	10.18	24.4	10.31	24.4	10.50	23.8	10.64
	-19.8	-20	25.9	10.10	25.9	10.18	25.8	10.31	25.8	10.44	25.8	10.63	25.1	10.77
	-18.8	-19	26.4	10.16	26.4	10.25	26.2	10.38	26.2	10.50	26.2	10.70	25.5	10.84
	-16.7	-17	27.3	10.30	27.3	10.39	27.1	10.52	27.1	10.64	27.1	10.84	26.4	10.47
	-13.7	-15	28.6	10.50	28.6	10.58	28.5	10.71	28.5	10.84	28.5	10.28	27.7	9.95
	-11.8	-13	29.5	10.62	29.5	10.71	29.3	10.84	29.3	10.44	29.3	9.93	28.6	9.61
	-9.8	-11	30.3	10.75	30.3	10.84	30.1	10.39	30.1	10.02	30.1	9.56	29.4	9.26
	-9.5	-10	30.5	10.77	30.5	10.76	30.3	10.32	30.3	9.96	30.3	9.50	29.5	9.21
	-8.5	-9.1	31.1	10.84	31.1	10.52	30.9	10.10	30.9	9.75	30.8	9.32	30.0	9.04
	-7.0	-7.6	32.0	10.46	32.0	10.16	31.8	9.76	31.8	9.43	31.4	9.04	30.6	8.77
	-5.0	-5.6	33.2	9.96	33.2	9.67	33.0	9.32	33.0	9.02	33.0	8.67	31.5	8.42
	-3.0	-3.7	34.4	9.46	34.4	9.19	34.2	8.87	34.2	8.60	34.2	8.30	32.3	8.07
	0.0	-0.7	36.2	8.71	36.2	8.46	36.0	8.20	36.0	7.97	35.8	7.74	33.4	7.55
	3.0	2.2	38.0	7.95	38.0	7.73	37.8	7.53	37.1	7.34	35.8	7.18	33.4	7.03
	5.0	4.1	38.6	6.79	38.5	6.59	37.6	6.43	36.4	6.28	35.2	6.16	32.7	6.03
	7.0	6.0	38.7	6.19	38.2	6.02	36.7	5.90	35.4	5.79	34.3	5.73	31.9	5.63
9.0	7.9	37.3	5.54	36.8	5.39	35.3	5.29	34.1	5.19	33.1	5.14	30.7	5.04	
11.0	9.8	35.2	4.97	34.8	4.84	33.4	4.74	32.3	4.65	31.3	4.61	29.1	4.52	
13.0	11.8	33.1	4.34	32.6	4.22	31.4	4.13	30.3	4.06	29.4	4.02	27.3	3.95	
15.0	13.7	31.3	3.77	30.9	3.67	29.7	3.59	28.7	3.53	27.8	3.49	25.8	3.43	
110	-24.8	-25	20.1	9.86	20.1	9.99	20.0	10.11	20.0	10.31	20.0	10.44	19.5	10.51
	-21.8	-22	24.4	10.05	24.4	10.18	24.3	10.31	24.3	10.50	24.3	10.64	23.7	10.71
	-19.8	-20	25.8	10.18	25.8	10.31	25.6	10.44	25.6	10.63	25.6	10.77	25.0	10.84
	-18.8	-19	26.2	10.25	26.2	10.38	26.1	10.50	26.1	10.70	26.1	10.84	25.4	10.65
	-16.7	-17	27.2	10.39	27.2	10.52	27.0	10.64	27.0	10.84	27.0	10.45	26.3	10.27
	-13.7	-15	28.5	10.58	28.5	10.71	28.3	10.84	28.3	10.25	28.3	9.90	28.3	9.72
	-11.8	-13	29.3	10.71	29.3	10.84	29.1	10.42	29.1	9.87	29.1	9.55	29.1	9.37
	-9.8	-11	30.1	10.84	30.1	10.36	30.0	9.97	30.0	9.48	30.0	9.18	29.4	9.00
	-9.5	-10	30.3	10.76	30.3	10.28	30.1	9.91	30.1	9.42	30.1	9.13	29.8	8.94
	-8.5	-9.1	30.9	10.50	30.9	10.05	30.7	9.69	30.7	9.23	30.7	8.95	30.1	8.76
	-7.0	-7.6	31.8	10.10	31.8	9.69	31.6	9.35	31.6	8.93	31.6	8.67	30.1	8.49
	-5.0	-5.6	33.0	9.58	33.0	9.21	32.8	8.91	32.8	8.54	32.2	8.30	30.1	8.12
	-3.0	-3.7	34.2	9.05	34.2	8.73	34.0	8.47	33.3	8.15	32.2	7.94	30.1	7.75
	0.0	-0.7	36.0	8.26	36.0	8.01	34.4	7.81	33.3	7.56	32.2	7.39	30.1	7.20
	3.0	2.2	37.8	7.48	36.7	7.29	34.4	7.14	33.3	6.97	32.2	6.84	30.1	6.65
	5.0	4.1	38.1	6.33	36.0	6.19	33.8	6.08	32.7	5.95	31.5	5.85	29.5	5.68
	7.0	6.0	37.1	5.72	35.0	5.63	32.9	5.57	31.8	5.50	30.7	5.43	28.7	5.26
9.0	7.9	35.7	5.10	33.8	5.03	31.7	4.97	30.7	4.91	29.6	4.85	27.7	4.70	
11.0	9.8	33.8	4.55	31.9	4.48	30.0	4.43	29.0	4.38	28.0	4.32	26.2	4.19	
13.0	11.8	31.7	3.95	30.0	3.89	28.1	3.84	27.2	3.80	26.3	3.75	24.6	3.63	
15.0	13.7	30.0	3.40	28.4	3.35	26.6	3.32	25.8	3.28	24.9	3.23	23.2	3.13	

# 7. Capacity Tables

Heating Capacity (10HP)

Combination (%)	Outdoor air temp.		Indoor air temp. °C DB											
			16		18		20		21		22		24	
	°C DB	°C WB	TC	PI	TC	PI	TC	PI	TC	PI	TC	PI	TC	PI
100	-24.8	-25	20.0	10.27	20.0	10.34	19.9	10.06	19.9	10.53	19.9	10.61	19.4	10.65
	-21.8	-22	24.3	10.38	24.3	10.46	24.2	10.37	24.2	10.64	24.2	10.78	23.6	10.76
	-19.8	-20	25.7	10.46	25.7	10.53	25.5	10.58	25.5	10.72	25.5	10.82	24.9	10.84
	-18.8	-19	26.1	10.49	25.9	10.57	25.9	10.64	25.9	10.76	25.9	10.84	25.3	10.63
	-16.7	-17	26.9	10.57	26.9	10.65	26.9	10.78	26.7	10.84	26.7	10.40	26.0	10.19
	-13.7	-15	28.3	10.69	28.3	10.76	28.2	10.84	28.2	10.18	28.2	9.77	27.5	9.56
	-11.8	-13	29.1	10.76	29.0	10.84	29.0	10.39	29.0	9.77	29.0	9.37	27.5	9.16
	-9.8	-11	30.0	10.84	30.0	10.32	29.8	9.91	29.8	9.33	29.5	8.95	27.5	8.74
	-9.5	-10	30.2	10.75	30.2	10.25	30.0	9.84	30.0	9.26	29.5	8.88	27.5	8.67
	-8.5	-9.1	30.8	10.48	30.8	9.99	30.6	9.60	30.5	9.05	29.5	8.67	27.5	8.46
	-7.0	-7.6	32.2	10.07	32.0	9.61	31.5	9.25	30.5	8.72	29.5	8.36	27.5	8.15
	-5.0	-5.6	33.6	9.52	33.3	9.10	31.5	8.77	30.5	8.28	29.5	7.94	27.5	7.73
	-3.0	-3.7	34.6	8.97	33.5	8.58	31.5	8.30	30.5	7.85	29.5	7.52	27.5	7.31
	0.0	-0.7	35.5	8.14	33.5	7.82	31.5	7.58	30.5	7.19	29.5	6.89	27.5	6.68
	3.0	2.2	35.5	7.32	33.5	7.05	31.5	6.87	30.5	6.54	29.5	6.26	27.5	6.05
	5.0	4.1	34.8	6.17	32.8	5.94	30.9	5.81	29.9	5.53	28.9	5.29	26.9	5.10
	7.0	6.0	33.9	5.54	32.0	5.36	30.1	5.27	29.1	5.04	28.2	4.82	26.2	4.64
	9.0	7.9	32.7	4.79	30.8	4.64	29.0	4.56	28.1	4.37	27.1	4.18	25.3	4.02
	11.0	9.8	30.9	4.12	29.2	3.99	27.4	3.92	26.5	3.75	25.7	3.59	23.9	3.45
	13.0	11.8	29.0	3.39	27.4	3.29	25.7	3.23	24.9	3.09	24.1	2.96	22.4	2.84
15.0	13.7	27.5	2.73	25.9	2.65	24.3	2.60	23.6	2.49	22.8	2.38	21.2	2.29	
90	-24.8	-25	19.9	9.49	19.9	9.69	19.8	9.83	19.8	9.89	19.8	10.02	19.3	10.22
	-21.8	-22	24.2	9.69	24.2	9.89	24.1	10.02	24.1	10.09	24.1	10.22	23.5	9.70
	-19.8	-20	25.6	9.82	25.6	10.02	25.4	10.15	25.4	10.22	25.4	9.86	24.8	9.36
	-18.8	-19	26.1	9.89	25.9	10.08	25.8	10.22	25.8	10.03	25.8	9.68	25.1	9.19
	-16.7	-17	26.9	10.02	26.9	10.22	26.8	9.82	26.8	9.64	26.8	9.30	25.1	8.82
	-13.7	-15	28.3	10.22	28.3	9.62	28.1	9.26	27.9	9.07	27.0	8.76	25.1	8.31
	-11.8	-13	29.1	9.80	29.0	9.25	28.8	8.90	27.9	8.72	27.0	8.42	25.1	7.98
	-9.8	-11	30.0	9.37	30.0	8.85	28.8	8.53	27.9	8.34	27.0	8.06	25.1	7.63
	-9.5	-10	30.2	9.30	30.2	8.79	28.8	8.47	27.9	8.28	27.0	8.00	25.1	7.58
	-8.5	-9.1	30.8	9.08	30.5	8.59	28.8	8.28	27.9	8.09	27.0	7.82	25.1	7.41
	-7.0	-7.6	32.2	8.75	30.6	8.29	28.8	8.00	27.9	7.81	27.0	7.55	25.1	7.15
	-5.0	-5.6	32.5	8.31	30.6	7.89	28.8	7.62	27.9	7.44	27.0	7.19	25.1	6.81
	-3.0	-3.7	32.5	7.88	30.6	7.50	28.8	7.24	27.9	7.06	27.0	6.83	25.1	6.46
	0.0	-0.7	32.5	7.22	30.6	6.90	28.8	6.68	27.9	6.50	27.0	6.29	25.1	5.94
	3.0	2.2	32.5	6.56	30.6	6.30	28.8	6.11	27.9	5.93	27.0	5.75	25.1	5.43
	5.0	4.1	31.9	5.56	30.0	5.35	28.2	5.19	27.4	5.03	26.5	4.87	24.6	4.59
	7.0	6.0	31.1	5.06	29.2	4.90	27.5	4.77	26.7	4.61	25.8	4.47	24.0	4.22
	9.0	7.9	29.9	4.38	28.2	4.25	26.5	4.13	25.7	3.99	24.9	3.87	23.1	3.65
	11.0	9.8	28.3	3.73	26.6	3.61	25.1	3.51	24.3	3.39	23.5	3.29	21.8	3.11
	13.0	11.8	26.6	3.01	25.0	2.92	23.5	2.84	22.8	2.74	22.1	2.66	20.5	2.51
15.0	13.7	25.2	2.40	23.7	2.32	22.3	2.26	21.6	2.18	20.9	2.12	19.4	2.00	
80	-24.8	-25	19.9	8.34	19.9	8.53	19.7	8.67	19.7	8.74	19.7	9.06	19.2	8.61
	-21.8	-22	24.0	8.53	24.0	8.73	24.0	8.87	24.0	9.06	24.0	8.61	22.4	8.18
	-19.8	-20	25.3	8.66	25.3	8.86	25.3	9.06	25.0	8.74	24.1	8.30	22.4	7.89
	-18.8	-19	25.7	8.73	25.7	9.06	25.7	8.89	25.0	8.57	24.1	8.15	22.4	7.74
	-16.7	-17	25.8	9.06	25.8	8.71	25.8	8.54	25.0	8.23	24.1	7.83	22.4	7.44
	-13.7	-15	27.0	8.53	26.4	8.20	25.8	8.04	25.0	7.74	24.1	7.38	22.4	7.01
	-11.8	-13	27.8	8.19	27.0	7.88	25.8	7.72	25.0	7.43	24.1	7.09	22.4	6.74
	-9.8	-11	28.5	7.83	27.3	7.54	25.8	7.38	25.0	7.11	24.1	6.78	22.4	6.45
	-9.5	-10	28.7	7.78	27.4	7.49	25.8	7.33	25.0	7.06	24.1	6.74	22.4	6.41
	-8.5	-9.1	28.9	7.60	27.5	7.32	25.8	7.16	25.0	6.90	24.1	6.58	22.4	6.26
	-7.0	-7.6	29.1	7.33	27.5	7.07	25.8	6.91	25.0	6.65	24.1	6.36	22.4	6.05
	-5.0	-5.6	29.1	6.98	27.5	6.73	25.8	6.58	25.0	6.33	24.1	6.05	22.4	5.76
	-3.0	-3.7	29.1	6.62	27.5	6.39	25.8	6.24	25.0	6.00	24.1	5.75	22.4	5.47
	0.0	-0.7	29.1	6.09	27.5	5.88	25.8	5.74	25.0	5.51	24.1	5.29	22.4	5.04
	3.0	2.2	29.1	5.55	27.5	5.38	25.8	5.23	25.0	5.02	24.1	4.84	22.4	4.61
	5.0	4.1	28.6	4.71	26.9	4.56	25.3	4.43	24.5	4.25	23.6	4.10	22.0	3.91
	7.0	6.0	27.8	4.31	26.2	4.18	24.6	4.06	23.9	3.89	23.0	3.76	21.4	3.59
	9.0	7.9	26.8	3.59	25.3	3.49	23.7	3.41	23.0	3.29	22.2	3.17	20.6	3.02
	11.0	9.8	25.3	2.96	23.9	2.88	22.4	2.81	21.8	2.71	21.0	2.61	19.5	2.49
	13.0	11.8	23.8	2.33	22.4	2.27	21.1	2.22	20.4	2.14	19.7	2.06	18.3	1.96
15.0	13.7	22.5	1.86	21.2	1.81	19.9	1.77	19.3	1.70	18.6	1.64	17.3	1.56	



## 7. Capacity Tables

Heating Capacity (10HP)

Combination (%)	Outdoor air temp.		Indoor air temp. °C DB											
			16		18		20		21		22		24	
	°C DB	°C WB	TC	PI	TC	PI	TC	PI	TC	PI	TC	PI	TC	PI
70	-24.8	-25	19.9	8.46	19.9	8.52	19.7	8.65	19.7	8.85	19.7	8.37	19.2	7.92
	-21.8	-22	22.1	8.65	22.1	8.72	21.9	8.85	21.2	8.37	20.6	7.92	19.2	7.49
	-19.8	-20	23.6	8.79	23.3	8.85	21.9	8.51	21.2	8.05	20.6	7.62	19.2	7.21
	-18.8	-19	24.3	8.85	23.3	8.67	21.9	8.34	21.2	7.89	20.6	7.47	19.2	7.07
	-16.7	-17	24.7	8.47	23.3	8.29	21.9	7.98	21.2	7.55	20.6	7.16	19.2	6.77
	-13.7	-15	24.7	7.93	23.3	7.76	21.9	7.46	21.2	7.06	20.6	6.71	19.2	6.34
	-11.8	-13	24.7	7.59	23.3	7.42	21.9	7.14	21.2	6.76	20.6	6.43	19.2	6.07
	-9.8	-11	24.7	7.23	23.3	7.06	21.9	6.79	21.2	6.44	20.6	6.13	19.2	5.79
	-9.5	-10	24.7	7.18	23.3	7.00	21.9	6.74	21.2	6.39	20.6	6.08	19.2	5.75
	-8.5	-9.1	24.7	7.00	23.3	6.82	21.9	6.57	21.2	6.23	20.6	5.93	19.2	5.61
	-7.0	-7.6	24.7	6.73	23.3	6.56	21.9	6.31	21.2	5.99	20.6	5.71	19.2	5.39
	-5.0	-5.6	24.7	6.37	23.3	6.20	21.9	5.97	21.2	5.66	20.6	5.41	19.2	5.11
	-3.0	-3.7	24.7	6.01	23.3	5.84	21.9	5.63	21.2	5.34	20.6	5.11	19.2	4.82
	0.0	-0.7	24.7	5.47	23.3	5.30	21.9	5.11	21.2	4.86	20.6	4.67	19.2	4.40
	3.0	2.2	24.7	4.93	23.3	4.76	21.9	4.60	21.2	4.38	20.6	4.22	19.2	3.97
	5.0	4.1	24.7	4.23	22.9	3.99	21.5	3.85	20.8	3.67	20.2	3.55	18.8	3.34
	7.0	6.0	24.7	3.94	22.3	3.60	21.0	3.48	20.2	3.32	19.6	3.22	18.3	3.03
	9.0	7.9	23.8	3.21	21.5	2.93	20.2	2.83	19.5	2.71	18.9	2.62	17.7	2.47
	11.0	9.8	22.5	2.64	20.3	2.41	19.1	2.33	18.4	2.22	17.9	2.16	16.7	2.03
	13.0	11.8	21.2	2.10	19.1	1.92	17.9	1.86	17.3	1.77	16.8	1.72	15.7	1.62
15.0	13.7	20.0	1.65	18.0	1.51	17.0	1.46	16.4	1.39	15.9	1.35	14.8	1.27	
60	-24.8	-25	18.9	8.33	18.9	8.46	18.8	8.65	18.2	8.15	17.6	7.69	16.4	7.25
	-21.8	-22	20.3	8.52	20.1	8.65	18.8	8.15	18.2	7.69	17.6	7.25	16.4	6.84
	-19.8	-20	21.2	8.65	20.1	8.30	18.8	7.82	18.2	7.38	17.6	6.96	16.4	6.56
	-18.8	-19	21.2	8.47	20.1	8.12	18.8	7.65	18.2	7.22	17.6	6.82	16.4	6.42
	-16.7	-17	21.2	8.09	20.1	7.74	18.8	7.30	18.2	6.89	17.6	6.51	16.4	6.13
	-13.7	-15	21.2	7.54	20.1	7.21	18.8	6.80	18.2	6.43	17.6	6.08	16.4	5.72
	-11.8	-13	21.2	7.19	20.1	6.87	18.8	6.48	18.2	6.13	17.6	5.80	16.4	5.46
	-9.8	-11	21.2	6.82	20.1	6.51	18.8	6.15	18.2	5.82	17.6	5.51	16.4	5.18
	-9.5	-10	21.2	6.77	20.1	6.45	18.8	6.10	18.2	5.77	17.6	5.47	16.4	5.14
	-8.5	-9.1	21.2	6.58	20.1	6.28	18.8	5.93	18.2	5.62	17.6	5.32	16.4	5.00
	-7.0	-7.6	21.2	6.31	20.1	6.01	18.8	5.68	18.2	5.39	17.6	5.11	16.4	4.80
	-5.0	-5.6	21.2	5.94	20.1	5.65	18.8	5.35	18.2	5.08	17.6	4.82	16.4	4.52
	-3.0	-3.7	21.2	5.57	20.1	5.29	18.8	5.01	18.2	4.76	17.6	4.53	16.4	4.24
	0.0	-0.7	21.2	5.02	20.1	4.76	18.8	4.51	18.2	4.30	17.6	4.09	16.4	3.83
	3.0	2.2	21.2	4.47	20.1	4.22	18.8	4.01	18.2	3.83	17.6	3.66	16.4	3.42
	5.0	4.1	20.8	3.73	19.7	3.50	18.4	3.33	17.8	3.19	17.2	3.05	16.1	2.84
	7.0	6.0	20.2	3.33	19.2	3.12	18.0	2.97	17.4	2.86	16.8	2.74	15.7	2.55
	9.0	7.9	19.5	2.68	18.5	2.51	17.3	2.39	16.7	2.30	16.2	2.21	15.1	2.05
	11.0	9.8	18.4	2.20	17.5	2.06	16.4	1.97	15.8	1.89	15.3	1.81	14.3	1.69
	13.0	11.8	17.3	1.76	16.4	1.64	15.4	1.57	14.9	1.51	14.3	1.45	13.4	1.34
15.0	13.7	16.4	1.39	15.5	1.30	14.5	1.23	14.1	1.18	13.6	1.14	12.7	1.07	
50	-24.8	-25	17.7	7.33	16.7	7.52	15.7	7.08	15.2	6.67	14.7	6.28	13.7	5.93
	-21.8	-22	17.7	7.52	16.7	7.08	15.7	6.67	15.2	6.28	14.7	5.93	13.7	5.59
	-19.8	-20	17.7	7.21	16.7	6.78	15.7	6.39	15.2	6.03	14.7	5.69	13.7	5.36
	-18.8	-19	17.7	7.05	16.7	6.64	15.7	6.26	15.2	5.90	14.7	5.57	13.7	5.25
	-16.7	-17	17.7	6.73	16.7	6.33	15.7	5.97	15.2	5.63	14.7	5.32	13.7	5.01
	-13.7	-15	17.7	6.26	16.7	5.88	15.7	5.56	15.2	5.24	14.7	4.96	13.7	4.67
	-11.8	-13	17.7	5.96	16.7	5.60	15.7	5.30	15.2	5.00	14.7	4.74	13.7	4.46
	-9.8	-11	17.7	5.65	16.7	5.31	15.7	5.02	15.2	4.74	14.7	4.50	13.7	4.23
	-9.5	-10	17.7	5.60	16.7	5.26	15.7	4.98	15.2	4.70	14.7	4.47	13.7	4.20
	-8.5	-9.1	17.7	5.44	16.7	5.11	15.7	4.85	15.2	4.58	14.7	4.35	13.7	4.09
	-7.0	-7.6	17.7	5.21	16.7	4.89	15.7	4.64	15.2	4.38	14.7	4.17	13.7	3.92
	-5.0	-5.6	17.7	4.89	16.7	4.60	15.7	4.37	15.2	4.13	14.7	3.93	13.7	3.69
	-3.0	-3.7	17.7	4.58	16.7	4.30	15.7	4.09	15.2	3.87	14.7	3.69	13.7	3.47
	0.0	-0.7	17.7	4.11	16.7	3.86	15.7	3.68	15.2	3.48	14.7	3.34	13.7	3.13
	3.0	2.2	17.7	3.64	16.7	3.42	15.7	3.27	15.2	3.10	14.7	2.98	13.7	2.79
	5.0	4.1	17.3	3.02	16.3	2.83	15.4	2.71	14.9	2.58	14.4	2.48	13.4	2.32
	7.0	6.0	16.9	2.68	15.9	2.51	15.0	2.42	14.5	2.30	14.0	2.23	13.1	2.08
	9.0	7.9	16.3	2.19	15.3	2.05	14.4	1.97	14.0	1.87	13.5	1.81	12.6	1.69
	11.0	9.8	15.5	1.82	14.6	1.70	13.7	1.64	13.2	1.56	12.8	1.51	11.9	1.41
	13.0	11.8	14.4	1.43	13.6	1.34	12.8	1.29	12.4	1.23	12.0	1.19	11.2	1.12
15.0	13.7	13.7	1.14	12.9	1.07	12.1	1.03	11.7	0.98	11.3	0.95	10.6	0.88	

## Note

1. TC: Total Capacity(kW), PI : Power Input(kW, Comp. + Outdoor fan motor)
2. Capacity tables show the average value of conditions which may occur.
3. The heating capacity table is based on the values expressed as Max. in the specification of the outdoor unit. (When measuring the Max. heating capacity, the setting status of the indoor unit is the same as that for measuring the heating capacity of the indoor unit.)

# 7. Capacity Tables

## ◆ ARUM120LTE5

Heating Capacity (12HP)

Combination (%)	Outdoor air temp.		Indoor air temp. °C DB											
			16		18		20		21		22		24	
	°C DB	°C WB	TC	PI	TC	PI	TC	PI	TC	PI	TC	PI	TC	PI
130	-24.8	-25	23.9	11.43	23.9	11.64	23.8	11.83	23.8	12.11	23.8	12.39	23.7	12.82
	-21.8	-22	28.4	11.86	28.4	12.07	28.2	12.26	28.2	12.54	28.2	12.82	28.1	13.24
	-19.8	-20	29.6	12.14	29.6	12.36	29.4	12.54	29.4	12.83	29.4	13.10	29.3	13.53
	-18.8	-19	30.3	12.29	30.3	12.50	30.1	12.69	30.1	12.97	30.1	13.24	30.0	13.67
	-16.7	-17	31.8	12.59	31.8	12.80	31.6	12.99	31.6	13.27	31.6	13.54	31.4	13.97
	-13.7	-15	33.9	13.02	33.9	13.23	33.7	13.42	33.7	13.70	33.7	13.97	33.5	13.32
	-11.8	-13	35.0	13.29	35.0	13.50	34.8	13.69	34.8	13.97	34.8	13.53	34.8	12.91
	-9.8	-11	36.2	13.57	36.2	13.79	35.9	13.97	35.9	13.49	35.9	13.06	35.9	12.48
	-9.5	-10	36.4	13.62	36.4	13.83	36.2	13.90	36.2	13.41	36.1	12.99	36.1	12.41
	-8.5	-9.1	37.3	13.76	37.3	13.97	37.1	13.64	37.1	13.17	36.7	12.75	36.7	12.19
	-7.0	-7.6	38.7	13.97	38.7	13.58	38.4	13.26	38.4	12.80	38.4	12.40	38.2	11.87
	-5.0	-5.6	40.5	13.45	40.5	13.07	40.2	12.74	40.2	12.31	40.2	11.93	39.5	11.43
	-3.0	-3.7	42.3	12.92	42.3	12.55	42.0	12.23	42.0	11.82	42.0	11.46	40.9	11.00
	0.0	-0.7	44.9	12.13	44.9	11.77	44.7	11.46	44.7	11.09	44.7	10.75	42.7	10.35
	3.0	2.2	47.6	11.34	47.6	10.99	47.3	10.69	47.3	10.36	45.8	10.04	42.7	9.70
	5.0	4.1	48.0	9.84	47.9	9.52	47.7	9.24	46.5	8.95	44.9	8.67	41.8	8.38
	7.0	6.0	46.8	9.15	46.7	8.86	46.5	8.60	45.4	8.35	43.8	8.10	40.8	7.86
9.0	7.9	45.0	8.35	44.9	8.08	44.8	7.84	43.7	7.61	42.2	7.39	39.3	7.17	
11.0	9.8	42.6	7.64	42.5	7.40	42.4	7.18	41.3	6.97	39.9	6.77	37.1	6.56	
13.0	11.8	40.0	6.84	39.9	6.62	39.8	6.43	38.8	6.24	37.5	6.06	34.9	5.87	
15.0	13.7	37.8	6.14	37.8	5.94	37.6	5.77	36.7	5.60	35.4	5.44	33.0	5.27	
120	-24.8	-25	23.8	11.64	23.8	11.83	23.6	12.11	23.6	12.39	23.6	12.82	23.5	13.12
	-21.8	-22	28.2	12.07	28.2	12.26	28.0	12.54	28.0	12.82	28.0	13.24	27.9	13.54
	-19.8	-20	29.4	12.36	29.4	12.54	29.2	12.83	29.2	13.10	29.2	13.53	29.1	13.83
	-18.8	-19	30.1	12.50	30.1	12.69	29.9	12.97	29.9	13.24	29.9	13.67	29.8	13.97
	-16.7	-17	31.6	12.80	31.6	12.99	31.4	13.27	31.4	13.54	31.4	13.97	31.2	13.56
	-13.7	-15	33.6	13.23	33.6	13.42	33.4	13.70	33.4	13.97	33.4	13.34	33.3	12.96
	-11.8	-13	34.7	13.50	34.7	13.69	34.5	13.97	34.5	13.52	34.5	12.94	34.5	12.58
	-9.8	-11	35.9	13.79	35.9	13.97	35.7	13.47	35.7	13.05	35.7	12.52	35.7	12.18
	-9.5	-10	36.2	13.83	36.2	13.89	36.0	13.40	36.0	12.98	36.0	12.46	36.0	12.12
	-8.5	-9.1	37.1	13.97	37.1	13.62	36.8	13.14	36.8	12.74	36.8	12.25	36.8	11.92
	-7.0	-7.6	38.4	13.56	38.4	13.22	38.2	12.77	38.2	12.39	38.0	11.93	37.9	11.62
	-5.0	-5.6	40.2	13.01	40.2	12.68	39.9	12.27	39.9	11.91	39.9	11.51	39.3	11.22
	-3.0	-3.7	42.0	12.46	42.0	12.14	41.7	11.76	41.7	11.44	41.7	11.09	40.1	10.82
	0.0	-0.7	44.6	11.63	44.6	11.33	44.3	11.01	44.3	10.73	43.1	10.46	40.1	10.22
	3.0	2.2	47.3	10.80	47.3	10.52	46.1	10.26	44.5	10.02	43.1	9.83	40.1	9.63
	5.0	4.1	47.6	9.32	47.0	9.06	45.1	8.84	43.6	8.65	42.3	8.50	39.3	8.33
	7.0	6.0	46.4	8.63	45.8	8.40	44.0	8.23	42.5	8.08	41.2	8.00	38.3	7.86
9.0	7.9	44.7	7.86	44.1	7.65	42.4	7.50	41.0	7.35	39.7	7.28	36.9	7.15	
11.0	9.8	42.3	7.19	41.7	6.99	40.1	6.85	38.7	6.72	37.5	6.66	34.9	6.54	
13.0	11.8	39.7	6.42	39.2	6.24	37.6	6.12	36.4	6.00	35.3	5.95	32.7	5.84	
15.0	13.7	37.6	5.75	37.1	5.59	35.6	5.48	34.4	5.38	33.4	5.33	31.0	5.23	
110	-24.8	-25	23.6	11.83	23.6	12.11	23.5	12.39	23.5	12.82	23.5	13.12	23.4	13.26
	-21.8	-22	28.1	12.26	28.1	12.54	27.9	12.82	27.9	13.24	27.9	13.54	27.8	13.69
	-19.8	-20	29.2	12.54	29.2	12.83	29.1	13.10	29.1	13.53	29.1	13.83	28.9	13.97
	-18.8	-19	29.9	12.69	29.9	12.97	29.7	13.24	29.7	13.67	29.7	13.97	29.6	13.76
	-16.7	-17	31.4	12.99	31.4	13.27	31.2	13.54	31.2	13.97	31.2	13.53	31.0	13.31
	-13.7	-15	33.5	13.42	33.5	13.70	33.2	13.97	33.2	13.30	33.2	12.89	33.2	12.67
	-11.8	-13	34.6	13.69	34.6	13.97	34.3	13.49	34.3	12.87	34.3	12.49	34.3	12.27
	-9.8	-11	35.7	13.97	35.7	13.43	35.5	12.99	35.5	12.42	35.5	12.07	35.5	11.84
	-9.5	-10	36.0	13.88	36.0	13.34	35.8	12.91	35.8	12.35	35.8	12.01	35.8	11.77
	-8.5	-9.1	36.9	13.59	36.9	13.07	36.6	12.66	36.6	12.12	36.6	11.79	36.1	11.56
	-7.0	-7.6	38.2	13.14	38.2	12.66	38.0	12.28	38.0	11.78	38.0	11.48	36.1	11.24
	-5.0	-5.6	40.0	12.54	40.0	12.11	39.7	11.77	39.7	11.33	38.6	11.05	36.1	10.81
	-3.0	-3.7	41.7	11.95	41.7	11.57	41.3	11.26	40.0	10.88	38.6	10.63	36.1	10.39
	0.0	-0.7	44.4	11.05	44.0	10.75	41.3	10.50	40.0	10.20	38.6	10.00	36.1	9.75
	3.0	2.2	46.6	10.16	44.0	9.92	41.3	9.74	40.0	9.53	38.6	9.36	36.1	9.11
	5.0	4.1	45.7	8.69	43.2	8.51	40.5	8.37	39.2	8.21	37.9	8.07	35.4	7.84
	7.0	6.0	44.5	7.98	42.1	7.86	39.5	7.77	38.2	7.68	36.9	7.58	34.5	7.34
9.0	7.9	42.9	7.23	40.5	7.12	38.0	7.04	36.8	6.96	35.5	6.87	33.2	6.66	
11.0	9.8	40.5	6.58	38.3	6.48	36.0	6.40	34.8	6.33	33.6	6.25	31.4	6.05	
13.0	11.8	38.1	5.84	36.0	5.75	33.8	5.68	32.7	5.61	31.6	5.54	29.5	5.37	
15.0	13.7	36.0	5.18	34.0	5.11	32.0	5.05	30.9	4.99	29.9	4.92	27.9	4.77	

# 7. Capacity Tables

Heating Capacity (12HP)

Combination (%)	Outdoor air temp.		Indoor air temp. °C DB											
			16		18		20		21		22		24	
	°C DB	°C WB	TC	PI	TC	PI	TC	PI	TC	PI	TC	PI	TC	PI
100	-24.8	-25	23.5	13.34	23.5	13.42	23.4	12.93	23.4	13.63	23.4	13.72	23.3	13.76
	-21.8	-22	27.9	13.47	27.9	13.55	27.8	13.34	27.8	13.76	27.8	14.06	27.6	13.89
	-19.8	-20	29.1	13.55	29.1	13.63	28.9	13.61	28.9	13.84	28.9	14.00	28.8	13.97
	-18.8	-19	29.8	13.59	29.6	13.68	29.6	13.76	29.6	13.88	29.6	13.97	29.5	13.72
	-16.7	-17	31.1	13.68	31.1	13.77	31.1	14.06	30.9	13.97	30.9	13.45	30.7	13.20
	-13.7	-15	33.3	13.81	33.3	13.89	33.1	13.97	33.1	13.21	33.1	12.71	33.0	12.45
	-11.8	-13	34.4	13.89	34.2	13.97	34.2	13.45	34.2	12.72	34.2	12.23	33.0	11.97
	-9.8	-11	35.5	13.97	35.5	13.38	35.4	12.90	35.4	12.21	35.4	11.74	33.0	11.47
	-9.5	-10	35.8	13.88	35.8	13.29	35.6	12.81	35.6	12.13	35.4	11.66	33.0	11.40
	-8.5	-9.1	36.7	13.56	36.7	13.00	36.5	12.54	36.6	11.87	35.4	11.41	33.0	11.15
	-7.0	-7.6	38.6	13.09	38.5	12.55	37.8	12.12	36.6	11.49	35.4	11.04	33.0	10.77
	-5.0	-5.6	40.3	12.46	39.9	11.96	37.8	11.57	36.6	10.98	35.4	10.54	33.0	10.27
	-3.0	-3.7	41.5	11.83	40.2	11.37	37.8	11.02	36.6	10.46	35.4	10.05	33.0	9.77
	0.0	-0.7	42.6	10.89	40.2	10.48	37.8	10.19	36.6	9.70	35.4	9.30	33.0	9.02
	3.0	2.2	42.6	9.94	40.2	9.59	37.8	9.36	36.6	8.93	35.4	8.56	33.0	8.27
	5.0	4.1	41.8	8.47	39.4	8.17	37.0	7.99	35.9	7.62	34.7	7.29	32.3	7.03
	7.0	6.0	40.7	7.72	38.4	7.48	36.1	7.35	34.9	7.03	33.8	6.73	31.5	6.47
	9.0	7.9	39.2	6.92	37.0	6.70	34.8	6.58	33.7	6.30	32.6	6.02	30.3	5.79
	11.0	9.8	37.1	6.20	35.0	6.00	32.9	5.90	31.8	5.64	30.8	5.40	28.7	5.19
	13.0	11.8	34.8	5.40	32.9	5.23	30.9	5.14	29.9	4.92	28.9	4.70	26.9	4.52
15.0	13.7	33.0	4.69	31.1	4.54	29.2	4.46	28.3	4.27	27.3	4.09	25.5	3.93	
90	-24.8	-25	23.4	11.74	23.4	12.17	23.3	12.47	23.3	12.61	23.3	12.90	23.2	13.33
	-21.8	-22	27.8	12.17	27.8	12.60	27.7	12.90	27.7	13.04	27.7	13.33	27.5	12.69
	-19.8	-20	29.0	12.46	29.0	12.88	28.8	13.18	28.8	13.33	28.8	12.89	28.7	12.27
	-18.8	-19	29.8	12.60	29.6	13.03	29.5	13.33	29.5	13.10	29.5	12.67	29.4	12.06
	-16.7	-17	31.1	12.90	31.1	13.33	30.9	12.85	30.9	12.62	30.9	12.21	30.1	11.62
	-13.7	-15	33.3	13.33	33.3	12.61	33.0	12.17	33.0	11.94	32.4	11.55	30.1	10.98
	-11.8	-13	34.4	12.83	34.2	12.16	34.1	11.74	33.5	11.51	32.4	11.13	30.1	10.58
	-9.8	-11	35.5	12.31	35.5	11.69	34.6	11.29	33.5	11.05	32.4	10.70	30.1	10.16
	-9.5	-10	35.8	12.23	35.8	11.61	34.6	11.22	33.5	10.98	32.4	10.63	30.1	10.10
	-8.5	-9.1	36.7	11.97	36.4	11.38	34.6	10.99	33.5	10.75	32.4	10.41	30.1	9.88
	-7.0	-7.6	38.6	11.58	36.7	11.02	34.6	10.65	33.5	10.41	32.4	10.08	30.1	9.57
	-5.0	-5.6	39.0	11.06	36.7	10.54	34.6	10.20	33.5	9.96	32.4	9.64	30.1	9.15
	-3.0	-3.7	39.0	10.54	36.7	10.07	34.6	9.75	33.5	9.50	32.4	9.20	30.1	8.72
	0.0	-0.7	39.0	9.76	36.7	9.35	34.6	9.07	33.5	8.82	32.4	8.55	30.1	8.09
	3.0	2.2	39.0	8.97	36.7	8.64	34.6	8.39	33.5	8.14	32.4	7.89	30.1	7.46
	5.0	4.1	38.3	7.66	36.0	7.39	33.9	7.17	32.8	6.95	31.8	6.73	29.5	6.35
	7.0	6.0	37.3	7.06	35.1	6.84	33.0	6.66	32.0	6.43	31.0	6.24	28.8	5.88
	9.0	7.9	35.9	6.32	33.8	6.13	31.8	5.96	30.8	5.76	29.8	5.59	27.7	5.27
	11.0	9.8	34.0	5.61	32.0	5.43	30.1	5.29	29.2	5.11	28.2	4.96	26.2	4.67
	13.0	11.8	31.9	4.79	30.0	4.64	28.3	4.52	27.4	4.36	26.5	4.23	24.6	3.99
15.0	13.7	30.2	4.11	28.4	3.99	26.7	3.88	25.9	3.75	25.1	3.64	23.3	3.43	
80	-24.8	-25	23.3	10.23	23.3	10.66	23.2	10.96	23.2	11.10	23.2	11.82	23.1	11.26
	-21.8	-22	27.5	10.66	27.5	11.09	27.5	11.39	27.5	11.82	27.5	11.26	26.9	10.73
	-19.8	-20	28.7	10.95	28.7	11.37	28.7	11.82	28.7	11.42	28.7	10.89	26.9	10.38
	-18.8	-19	29.4	11.09	29.4	11.82	29.4	11.61	29.4	11.22	28.9	10.70	26.9	10.20
	-16.7	-17	30.9	11.82	30.9	11.39	30.9	11.19	30.0	10.81	28.9	10.31	26.9	9.83
	-13.7	-15	32.3	11.18	31.7	10.78	30.9	10.58	30.0	10.21	28.9	9.75	26.9	9.30
	-11.8	-13	33.2	10.77	32.2	10.39	30.9	10.19	30.0	9.83	28.9	9.40	26.9	8.96
	-9.8	-11	34.1	10.34	32.7	9.98	30.9	9.78	30.0	9.44	28.9	9.03	26.9	8.61
	-9.5	-10	34.3	10.28	32.8	9.92	30.9	9.72	30.0	9.38	28.9	8.97	26.9	8.55
	-8.5	-9.1	34.7	10.07	33.0	9.72	30.9	9.52	30.0	9.18	28.9	8.78	26.9	8.38
	-7.0	-7.6	35.0	9.75	33.0	9.41	30.9	9.21	30.0	8.88	28.9	8.51	26.9	8.11
	-5.0	-5.6	35.0	9.32	33.0	9.01	30.9	8.81	30.0	8.48	28.9	8.13	26.9	7.76
	-3.0	-3.7	35.0	8.89	33.0	8.60	30.9	8.40	30.0	8.09	28.9	7.76	26.9	7.40
	0.0	-0.7	35.0	8.25	33.0	7.99	30.9	7.79	30.0	7.49	28.9	7.20	26.9	6.87
	3.0	2.2	35.0	7.61	33.0	7.37	30.9	7.18	30.0	6.89	28.9	6.64	26.9	6.34
	5.0	4.1	34.3	6.50	32.3	6.30	30.3	6.12	29.4	5.87	28.3	5.66	26.4	5.41
	7.0	6.0	33.4	6.01	31.5	5.84	29.5	5.67	28.7	5.43	27.6	5.25	25.7	5.01
	9.0	7.9	32.2	5.20	30.3	5.06	28.5	4.94	27.6	4.76	26.6	4.59	24.8	4.37
	11.0	9.8	30.4	4.47	28.7	4.35	26.9	4.25	26.1	4.09	25.2	3.94	23.4	3.75
	13.0	11.8	28.6	3.73	26.9	3.63	25.3	3.55	24.5	3.41	23.6	3.29	22.0	3.13
15.0	13.7	27.0	3.20	25.5	3.12	23.9	3.04	23.2	2.93	22.4	2.82	20.8	2.69	

## 7. Capacity Tables

## Heating Capacity (12HP)

Combination (%)	Outdoor air temp.		Indoor air temp. °C DB											
			16		18		20		21		22		24	
	°C DB	°C WB	TC	PI	TC	PI	TC	PI	TC	PI	TC	PI	TC	PI
70	-24.8	-25	23.3	10.53	23.3	10.67	23.2	10.96	23.2	11.39	23.2	10.81	23.0	10.26
	-21.8	-22	26.5	10.96	26.5	11.10	26.3	11.39	25.4	10.42	24.7	10.26	23.0	9.74
	-19.8	-20	28.6	11.25	28.0	11.39	26.3	10.98	25.4	10.42	24.7	9.90	23.0	9.40
	-18.8	-19	29.4	11.39	28.0	11.17	26.3	10.77	25.4	10.22	24.7	9.72	23.0	9.22
	-16.7	-17	29.6	10.94	28.0	10.72	26.3	10.34	25.4	9.82	24.7	9.34	23.0	8.86
	-13.7	-15	29.6	10.30	28.0	10.08	26.3	9.72	25.4	9.23	24.7	8.80	23.0	8.34
	-11.8	-13	29.6	9.89	28.0	9.67	26.3	9.33	25.4	8.86	24.7	8.45	23.0	8.01
	-9.8	-11	29.6	9.47	28.0	9.25	26.3	8.92	25.4	8.47	24.7	8.09	23.0	7.66
	-9.5	-10	29.6	9.40	28.0	9.18	26.3	8.86	25.4	8.42	24.7	8.04	23.0	7.61
	-8.5	-9.1	29.6	9.19	28.0	8.97	26.3	8.65	25.4	8.22	24.7	7.86	23.0	7.44
	-7.0	-7.6	29.6	8.87	28.0	8.65	26.3	8.34	25.4	7.93	24.7	7.59	23.0	7.18
	-5.0	-5.6	29.6	8.44	28.0	8.22	26.3	7.93	25.4	7.54	24.7	7.22	23.0	6.83
	-3.0	-3.7	29.6	8.02	28.0	7.79	26.3	7.52	25.4	7.15	24.7	6.86	23.0	6.48
	0.0	-0.7	29.6	7.38	28.0	7.15	26.3	6.90	25.4	6.57	24.7	6.32	23.0	5.96
	3.0	2.2	29.6	6.74	28.0	6.50	26.3	6.28	25.4	5.99	24.7	5.78	23.0	5.44
	5.0	4.1	29.6	5.83	27.4	5.50	25.8	5.31	24.9	5.06	24.2	4.89	22.6	4.61
	7.0	6.0	29.7	5.50	26.7	5.02	25.2	4.86	24.3	4.64	23.6	4.50	22.0	4.23
9.0	7.9	28.6	4.63	25.8	4.23	24.2	4.09	23.4	3.90	22.7	3.78	21.2	3.56	
11.0	9.8	27.0	3.97	24.4	3.63	22.9	3.51	22.1	3.35	21.5	3.25	20.0	3.05	
13.0	11.8	25.4	3.34	22.9	3.06	21.5	2.95	20.8	2.82	20.2	2.74	18.8	2.57	
15.0	13.7	24.0	2.84	21.6	2.59	20.4	2.51	19.7	2.39	19.1	2.32	17.8	2.18	
60	-24.8	-25	22.7	10.24	22.7	10.53	22.6	10.96	21.8	10.37	21.1	9.81	19.7	9.29
	-21.8	-22	24.3	10.67	24.1	10.96	22.6	10.37	21.8	9.81	21.1	9.29	19.7	8.79
	-19.8	-20	25.4	10.96	24.1	10.54	22.6	9.97	21.8	9.44	21.1	8.94	19.7	8.46
	-18.8	-19	25.4	10.75	24.1	10.33	22.6	9.77	21.8	9.25	21.1	8.77	19.7	8.29
	-16.7	-17	25.4	10.30	24.1	9.88	22.6	9.36	21.8	8.87	21.1	8.41	19.7	7.94
	-13.7	-15	25.4	9.65	24.1	9.25	22.6	8.76	21.8	8.31	21.1	7.89	19.7	7.44
	-11.8	-13	25.4	9.25	24.1	8.85	22.6	8.38	21.8	7.96	21.1	7.56	19.7	7.13
	-9.8	-11	25.4	8.82	24.1	8.43	22.6	7.99	21.8	7.59	21.1	7.21	19.7	6.79
	-9.5	-10	25.4	8.75	24.1	8.37	22.6	7.93	21.8	7.53	21.1	7.16	19.7	6.74
	-8.5	-9.1	25.4	8.54	24.1	8.16	22.6	7.73	21.8	7.35	21.1	6.98	19.7	6.58
	-7.0	-7.6	25.4	8.22	24.1	7.84	22.6	7.43	21.8	7.07	21.1	6.72	19.7	6.33
	-5.0	-5.6	25.4	7.79	24.1	7.42	22.6	7.04	21.8	6.70	21.1	6.38	19.7	5.99
	-3.0	-3.7	25.4	7.36	24.1	7.00	22.6	6.64	21.8	6.33	21.1	6.03	19.7	5.66
	0.0	-0.7	25.4	6.72	24.1	6.36	22.6	6.05	21.8	5.77	21.1	5.51	19.7	5.16
	3.0	2.2	25.4	6.08	24.1	5.73	22.6	5.45	21.8	5.22	21.1	4.99	19.7	4.66
	5.0	4.1	24.9	5.12	23.6	4.81	22.1	4.58	21.4	4.39	20.6	4.20	19.3	3.92
	7.0	6.0	24.3	4.64	23.0	4.35	21.6	4.15	20.8	3.99	20.1	3.82	18.8	3.56
9.0	7.9	23.4	3.87	22.2	3.62	20.8	3.45	20.1	3.32	19.4	3.18	18.1	2.96	
11.0	9.8	22.1	3.32	20.9	3.11	19.6	2.96	19.0	2.85	18.3	2.73	17.2	2.54	
13.0	11.8	20.8	2.79	19.7	2.62	18.4	2.49	17.8	2.40	17.2	2.30	16.1	2.14	
15.0	13.7	19.7	2.39	18.6	2.24	17.5	2.11	16.9	2.03	16.3	1.95	15.2	1.83	
50	-24.8	-25	21.2	9.38	20.0	9.81	18.8	9.26	18.2	8.74	17.6	8.26	16.4	7.81
	-21.8	-22	21.2	9.81	20.0	9.26	18.8	8.74	18.2	8.26	17.6	7.81	16.4	7.38
	-19.8	-20	21.2	9.42	20.0	8.89	18.8	8.40	18.2	7.93	17.6	7.51	16.4	7.09
	-18.8	-19	21.2	9.23	20.0	8.70	18.8	8.23	18.2	7.77	17.6	7.36	16.4	6.95
	-16.7	-17	21.2	8.82	20.0	8.32	18.8	7.87	18.2	7.43	17.6	7.04	16.4	6.65
	-13.7	-15	21.2	8.24	20.0	7.76	18.8	7.35	18.2	6.95	17.6	6.59	16.4	6.22
	-11.8	-13	21.2	7.87	20.0	7.41	18.8	7.02	18.2	6.64	17.6	6.31	16.4	5.95
	-9.8	-11	21.2	7.48	20.0	7.04	18.8	6.68	18.2	6.32	17.6	6.01	16.4	5.66
	-9.5	-10	21.2	7.42	20.0	6.99	18.8	6.63	18.2	6.27	17.6	5.97	16.4	5.62
	-8.5	-9.1	21.2	7.22	20.0	6.80	18.8	6.46	18.2	6.11	17.6	5.82	16.4	5.48
	-7.0	-7.6	21.2	6.93	20.0	6.53	18.8	6.20	18.2	5.87	17.6	5.59	16.4	5.26
	-5.0	-5.6	21.2	6.54	20.0	6.16	18.8	5.86	18.2	5.54	17.6	5.29	16.4	4.98
	-3.0	-3.7	21.2	6.15	20.0	5.79	18.8	5.51	18.2	5.22	17.6	4.99	16.4	4.69
	0.0	-0.7	21.2	5.57	20.0	5.23	18.8	5.00	18.2	4.74	17.6	4.54	16.4	4.26
	3.0	2.2	21.2	4.99	20.0	4.68	18.8	4.48	18.2	4.25	17.6	4.09	16.4	3.83
	5.0	4.1	20.8	4.17	19.6	3.90	18.4	3.75	17.8	3.56	17.3	3.43	16.1	3.21
	7.0	6.0	20.3	3.75	19.1	3.51	18.0	3.38	17.4	3.21	16.8	3.11	15.7	2.90
9.0	7.9	19.5	3.15	18.4	2.95	17.3	2.84	16.8	2.70	16.2	2.62	15.1	2.44	
11.0	9.8	18.6	2.74	17.5	2.56	16.4	2.47	15.8	2.34	15.3	2.27	14.3	2.12	
13.0	11.8	17.3	2.28	16.4	2.13	15.4	2.05	14.9	1.96	14.4	1.89	13.4	1.78	
15.0	13.7	16.4	1.96	15.5	1.83	14.5	1.76	14.1	1.68	13.6	1.62	12.7	1.51	

## Note

1. TC: Total Capacity(kW), PI : Power Input(kW, Comp. + Outdoor fan motor)
2. Capacity tables show the average value of conditions which may occur.
3. The heating capacity table is based on the values expressed as Max. in the specification of the outdoor unit. (When measuring the Max. heating capacity, the setting status of the indoor unit is the same as that for measuring the heating capacity of the indoor unit.)

# 7. Capacity Tables

## ◆ ARUM140LTE5

Heating Capacity (14HP)

Combination (%)	Outdoor air temp.		Indoor air temp. °C DB											
			16		18		20		21		22		24	
	°C DB	°C WB	TC	PI	TC	PI	TC	PI	TC	PI	TC	PI	TC	PI
130	-24.8	-25	27.3	13.07	27.3	13.20	27.2	13.32	27.2	13.50	27.2	13.67	26.6	13.94
	-21.8	-22	33.3	13.34	33.3	13.47	33.0	13.59	33.0	13.77	33.0	13.94	32.4	14.21
	-19.8	-20	35.1	13.52	35.1	13.65	34.9	13.77	34.9	13.95	34.9	14.12	34.2	14.39
	-18.8	-19	35.9	13.61	35.9	13.74	35.7	13.86	35.7	14.04	35.7	14.21	35.0	14.48
	-16.7	-17	37.7	13.80	37.7	13.93	37.4	14.05	37.4	14.23	37.4	14.40	36.7	14.67
	-13.7	-15	40.1	14.07	40.1	14.20	39.9	14.32	39.9	14.50	39.9	14.67	39.1	14.13
	-11.8	-13	41.4	14.24	41.4	14.37	41.2	14.49	41.2	14.67	41.2	14.84	40.6	13.79
	-9.8	-11	42.8	14.42	42.8	14.55	42.5	14.67	42.5	14.29	42.5	13.93	42.2	13.43
	-9.5	-10	43.1	14.45	43.1	14.58	42.8	14.61	42.8	14.23	42.8	13.87	42.5	13.37
	-8.5	-9.1	43.9	14.54	43.9	14.67	43.6	14.42	43.6	14.03	43.4	13.68	43.3	13.19
	-7.0	-7.6	45.1	14.67	45.1	14.39	44.8	14.12	44.8	13.74	44.8	13.39	44.5	12.92
	-5.0	-5.6	46.8	14.30	46.8	14.00	46.5	13.73	46.5	13.36	46.5	13.01	46.1	12.56
	-3.0	-3.7	48.4	13.94	48.4	13.62	48.1	13.34	48.1	12.97	48.1	12.63	47.7	12.20
	0.0	-0.7	50.9	13.39	50.9	13.05	50.6	12.75	50.6	12.39	50.6	12.05	49.8	11.66
	3.0	2.2	53.4	12.84	53.4	12.48	53.0	12.16	53.0	11.81	53.0	11.48	49.8	11.11
	5.0	4.1	54.0	11.33	53.9	10.97	53.6	10.66	53.6	10.34	52.4	10.03	48.8	9.71
	7.0	6.0	54.2	10.77	54.1	10.42	53.8	10.12	52.9	9.83	51.1	9.53	47.5	9.25
	9.0	7.9	52.5	10.04	52.4	9.72	52.3	9.44	51.0	9.16	49.2	8.89	45.8	8.62
	11.0	9.8	49.7	9.44	49.6	9.13	49.4	8.87	48.2	8.61	46.5	8.35	43.3	8.10
	13.0	11.8	46.7	8.70	46.6	8.42	46.4	8.17	45.3	7.94	43.7	7.70	40.7	7.47
15.0	13.7	44.1	8.08	44.1	7.82	43.9	7.60	42.8	7.38	41.3	7.16	38.5	6.94	
120	-24.8	-25	27.1	13.20	27.1	13.32	27.0	13.50	27.0	13.67	27.0	13.94	26.4	14.13
	-21.8	-22	33.0	13.47	33.0	13.59	32.8	13.77	32.8	13.94	32.8	14.21	32.2	14.40
	-19.8	-20	34.8	13.65	34.8	13.77	34.6	13.95	34.6	14.12	34.6	14.39	33.9	14.58
	-18.8	-19	35.7	13.74	35.7	13.86	35.4	14.04	35.4	14.21	35.4	14.48	34.7	14.67
	-16.7	-17	37.4	13.93	37.4	14.05	37.2	14.23	37.2	14.40	37.2	14.67	36.4	14.32
	-13.7	-15	39.8	14.20	39.8	14.32	39.6	14.50	39.6	14.67	39.6	14.15	38.8	13.82
	-11.8	-13	41.1	14.37	41.1	14.49	40.9	14.67	40.9	14.30	40.9	13.82	40.3	13.51
	-9.8	-11	42.5	14.55	42.5	14.67	42.2	14.27	42.2	13.92	42.2	13.48	41.9	13.18
	-9.5	-10	42.8	14.58	42.8	14.61	42.5	14.21	42.5	13.86	42.5	13.43	42.2	13.13
	-8.5	-9.1	43.6	14.67	43.6	14.40	43.3	14.01	43.3	13.67	43.3	13.25	43.0	12.96
	-7.0	-7.6	44.8	14.36	44.8	14.08	44.5	13.71	44.5	13.38	44.5	13.00	44.2	12.71
	-5.0	-5.6	46.4	13.94	46.4	13.65	46.1	13.30	46.1	12.99	46.1	12.65	45.8	12.38
	-3.0	-3.7	48.1	13.52	48.1	13.23	47.8	12.90	47.8	12.61	47.8	12.30	46.8	12.05
	0.0	-0.7	50.5	12.89	50.5	12.59	50.2	12.30	50.2	12.03	50.2	11.79	46.8	11.55
	3.0	2.2	53.0	12.25	53.0	11.95	52.6	11.69	52.0	11.45	50.3	11.27	46.8	11.05
	5.0	4.1	53.7	10.74	53.5	10.45	52.7	10.22	50.9	10.00	49.3	9.86	45.8	9.67
	7.0	6.0	53.9	10.16	53.4	9.88	51.3	9.69	49.6	9.50	48.1	9.41	44.7	9.25
	9.0	7.9	52.2	9.44	51.5	9.19	49.4	9.01	47.8	8.83	46.3	8.75	43.0	8.59
	11.0	9.8	49.3	8.84	48.7	8.60	46.8	8.44	45.2	8.27	43.8	8.20	40.7	8.05
	13.0	11.8	46.3	8.12	45.7	7.90	43.9	7.75	42.4	7.60	41.1	7.53	38.2	7.39
15.0	13.7	43.8	7.52	43.2	7.31	41.5	7.17	40.2	7.03	38.9	6.97	36.1	6.84	
110	-24.8	-25	27.0	13.32	27.0	13.50	26.8	13.67	26.8	13.94	26.8	14.13	26.3	14.22
	-21.8	-22	32.8	13.59	32.8	13.77	32.6	13.94	32.6	14.21	32.6	14.40	32.0	14.49
	-19.8	-20	34.7	13.77	34.7	13.95	34.4	14.12	34.4	14.39	34.4	14.58	33.8	14.67
	-18.8	-19	35.5	13.86	35.5	14.04	35.2	14.21	35.2	14.48	35.2	14.67	34.6	14.49
	-16.7	-17	37.2	14.05	37.2	14.23	37.0	14.40	37.0	14.67	37.0	14.29	36.2	14.10
	-13.7	-15	39.6	14.32	39.6	14.50	39.4	14.67	39.4	14.10	39.4	13.75	39.4	13.54
	-11.8	-13	40.9	14.49	40.9	14.67	40.7	14.27	40.7	13.74	40.7	13.41	40.7	13.19
	-9.8	-11	42.3	14.67	42.3	14.22	42.0	13.84	42.0	13.35	42.0	13.05	42.0	12.82
	-9.5	-10	42.5	14.60	42.5	14.15	42.3	13.78	42.3	13.30	42.3	12.99	42.1	12.76
	-8.5	-9.1	43.3	14.35	43.3	13.92	43.1	13.57	43.1	13.11	43.1	12.81	42.1	12.58
	-7.0	-7.6	44.6	13.98	44.6	13.58	44.3	13.25	44.3	12.82	44.3	12.54	42.1	12.30
	-5.0	-5.6	46.2	13.49	46.2	13.12	45.9	12.82	45.9	12.44	45.1	12.18	42.1	11.93
	-3.0	-3.7	47.8	13.00	47.8	12.67	47.5	12.40	46.6	12.06	45.1	11.82	42.1	11.56
	0.0	-0.7	50.3	12.27	50.3	11.98	48.2	11.76	46.6	11.48	45.1	11.28	42.1	11.01
	3.0	2.2	52.7	11.53	51.4	11.30	48.2	11.12	46.6	10.91	45.1	10.74	42.1	10.45
	5.0	4.1	53.2	10.02	50.4	9.82	47.3	9.68	45.7	9.51	44.2	9.36	41.2	9.09
	7.0	6.0	51.9	9.39	49.1	9.25	46.1	9.14	44.5	9.03	43.0	8.92	40.2	8.64
	9.0	7.9	50.0	8.68	47.3	8.55	44.4	8.46	42.9	8.35	41.5	8.25	38.7	7.99
	11.0	9.8	47.3	8.08	44.7	7.96	42.0	7.87	40.6	7.78	39.2	7.68	36.6	7.44
	13.0	11.8	44.4	7.37	42.0	7.26	39.4	7.18	38.1	7.09	36.8	7.00	34.4	6.79
15.0	13.7	42.0	6.77	39.7	6.67	37.3	6.60	36.1	6.52	34.8	6.43	32.5	6.23	

# 7. Capacity Tables

Heating Capacity (14HP)

Combination (%)	Outdoor air temp.		Indoor air temp. °C DB											
			16		18		20		21		22		24	
	°C DB	°C WB	TC	PI	TC	PI	TC	PI	TC	PI	TC	PI	TC	PI
100	-24.8	-25	26.9	14.67	26.9	14.67	26.7	13.87	26.7	14.67	26.7	14.67	26.2	14.67
	-21.8	-22	32.7	14.67	32.7	14.67	32.5	14.30	32.5	14.67	32.5	14.86	31.9	14.67
	-19.8	-20	34.5	14.67	34.5	14.67	34.3	14.58	34.3	14.67	34.3	14.73	33.6	14.67
	-18.8	-19	35.3	14.67	35.1	14.67	35.1	14.67	35.1	14.67	35.1	14.67	34.4	14.44
	-16.7	-17	36.8	14.67	36.8	14.67	36.8	14.86	36.6	14.67	36.6	14.20	35.9	13.96
	-13.7	-15	39.4	14.67	39.4	14.67	39.2	14.67	39.2	13.99	39.2	13.53	38.5	13.28
	-11.8	-13	40.7	14.67	40.5	14.67	40.5	14.22	40.5	13.56	40.5	13.10	38.5	12.85
	-9.8	-11	42.1	14.67	42.1	14.16	41.8	13.74	41.8	13.11	41.3	12.66	38.5	12.39
	-9.5	-10	42.3	14.59	42.3	14.09	42.1	13.67	42.1	13.04	41.3	12.59	38.5	12.32
	-8.5	-9.1	43.1	14.33	43.1	13.83	42.9	13.43	42.7	12.81	41.3	12.37	38.5	12.09
	-7.0	-7.6	45.1	13.93	44.9	13.45	44.1	13.07	42.7	12.47	41.3	12.03	38.5	11.75
	-5.0	-5.6	47.0	13.40	46.6	12.94	44.1	12.59	42.7	12.02	41.3	11.58	38.5	11.29
	-3.0	-3.7	48.4	12.87	46.9	12.43	44.1	12.11	42.7	11.57	41.3	11.14	38.5	10.84
	0.0	-0.7	49.7	12.07	46.9	11.67	44.1	11.39	42.7	10.89	41.3	10.46	38.5	10.15
	3.0	2.2	49.7	11.27	46.9	10.91	44.1	10.68	42.7	10.21	41.3	9.79	38.5	9.47
	5.0	4.1	48.7	9.75	46.0	9.43	43.2	9.23	41.8	8.82	40.5	8.44	37.7	8.14
	7.0	6.0	47.5	9.09	44.8	8.80	42.1	8.65	40.8	8.28	39.4	7.92	36.7	7.62
	9.0	7.9	45.8	8.34	43.2	8.08	40.6	7.94	39.3	7.59	38.0	7.26	35.4	6.99
	11.0	9.8	43.3	7.69	40.8	7.45	38.4	7.32	37.1	7.01	35.9	6.70	33.5	6.45
	13.0	11.8	40.6	6.94	38.3	6.73	36.0	6.61	34.9	6.32	33.7	6.05	31.4	5.82
15.0	13.7	38.5	6.30	36.3	6.10	34.1	6.00	33.0	5.74	31.9	5.49	29.7	5.28	
90	-24.8	-25	26.8	13.09	26.8	13.36	26.6	13.55	26.6	13.64	26.6	13.82	26.1	14.09
	-21.8	-22	32.6	13.36	32.6	13.63	32.4	13.82	32.4	13.91	32.4	14.09	31.7	13.49
	-19.8	-20	34.4	13.54	34.4	13.81	34.2	14.00	34.2	14.09	34.2	13.68	33.5	13.10
	-18.8	-19	35.3	13.63	35.1	13.90	35.0	14.09	35.0	13.88	35.0	13.48	34.3	12.90
	-16.7	-17	36.8	13.82	36.8	14.09	36.6	13.66	36.6	13.44	36.6	13.06	35.1	12.48
	-13.7	-15	39.4	14.09	39.4	13.45	39.1	13.04	39.1	12.82	37.8	12.45	35.1	11.89
	-11.8	-13	40.7	13.65	40.5	13.05	40.3	12.66	39.1	12.42	37.8	12.06	35.1	11.51
	-9.8	-11	42.1	13.19	42.1	12.62	40.4	12.25	39.1	12.01	37.8	11.66	35.1	11.11
	-9.5	-10	42.3	13.12	42.3	12.56	40.4	12.18	39.1	11.94	37.8	11.60	35.1	11.05
	-8.5	-9.1	43.1	12.90	42.8	12.34	40.4	11.98	39.1	11.73	37.8	11.39	35.1	10.86
	-7.0	-7.6	45.1	12.55	42.9	12.03	40.4	11.67	39.1	11.42	37.8	11.09	35.1	10.56
	-5.0	-5.6	45.6	12.09	42.9	11.60	40.4	11.26	39.1	11.00	37.8	10.68	35.1	10.16
	-3.0	-3.7	45.6	11.63	42.9	11.17	40.4	10.85	39.1	10.59	37.8	10.28	35.1	9.76
	0.0	-0.7	45.6	10.94	42.9	10.54	40.4	10.24	39.1	9.96	37.8	9.67	35.1	9.17
	3.0	2.2	45.6	10.25	42.9	9.90	40.4	9.62	39.1	9.34	37.8	9.06	35.1	8.57
	5.0	4.1	44.6	8.87	42.0	8.56	39.5	8.32	38.3	8.05	37.1	7.81	34.4	7.37
	7.0	6.0	43.5	8.31	40.9	8.05	38.5	7.83	37.3	7.57	36.1	7.34	33.6	6.92
	9.0	7.9	41.9	7.62	39.4	7.39	37.1	7.19	36.0	6.94	34.8	6.74	32.3	6.35
	11.0	9.8	39.6	6.96	37.3	6.75	35.1	6.57	34.0	6.34	32.9	6.15	30.6	5.80
	13.0	11.8	37.2	6.16	35.0	5.97	33.0	5.81	31.9	5.61	30.9	5.44	28.7	5.13
15.0	13.7	35.2	5.53	33.1	5.36	31.2	5.21	30.2	5.03	29.3	4.88	27.2	4.61	
80	-24.8	-25	26.7	11.49	26.7	11.76	26.5	11.95	26.5	12.04	26.5	12.49	26.0	11.97
	-21.8	-22	32.2	11.76	32.2	12.03	32.2	12.22	32.2	12.49	32.2	11.97	31.4	11.47
	-19.8	-20	34.0	11.94	34.0	12.21	34.0	12.49	34.0	12.12	33.7	11.62	31.4	11.13
	-18.8	-19	34.8	12.03	34.8	12.49	34.8	12.31	34.8	11.94	33.7	11.45	31.4	10.96
	-16.7	-17	36.1	12.49	36.1	12.11	36.1	11.92	35.0	11.55	33.7	11.08	31.4	10.61
	-13.7	-15	37.7	11.92	37.0	11.55	36.1	11.36	35.0	11.00	33.7	10.56	31.4	10.11
	-11.8	-13	38.7	11.55	37.5	11.20	36.1	11.00	35.0	10.65	33.7	10.22	31.4	9.79
	-9.8	-11	39.7	11.17	38.1	10.83	36.1	10.63	35.0	10.28	33.7	9.88	31.4	9.45
	-9.5	-10	40.0	11.11	38.3	10.77	36.1	10.57	35.0	10.22	33.7	9.82	31.4	9.40
	-8.5	-9.1	40.4	10.92	38.4	10.59	36.1	10.38	35.0	10.04	33.7	9.65	31.4	9.23
	-7.0	-7.6	40.8	10.63	38.4	10.31	36.1	10.10	35.0	9.76	33.7	9.39	31.4	8.98
	-5.0	-5.6	40.8	10.25	38.4	9.94	36.1	9.73	35.0	9.39	33.7	9.04	31.4	8.64
	-3.0	-3.7	40.8	9.87	38.4	9.57	36.1	9.36	35.0	9.02	33.7	8.69	31.4	8.31
	0.0	-0.7	40.8	9.29	38.4	9.01	36.1	8.80	35.0	8.47	33.7	8.16	31.4	7.81
	3.0	2.2	40.8	8.72	38.4	8.46	36.1	8.24	35.0	7.92	33.7	7.64	31.4	7.30
	5.0	4.1	40.0	7.53	37.7	7.31	35.4	7.10	34.3	6.81	33.1	6.58	30.8	6.28
	7.0	6.0	39.0	7.07	36.7	6.87	34.5	6.67	33.4	6.39	32.2	6.18	30.0	5.90
	9.0	7.9	37.5	6.31	35.4	6.13	33.2	5.98	32.2	5.75	31.0	5.55	28.9	5.28
	11.0	9.8	35.5	5.58	33.4	5.43	31.4	5.29	30.5	5.09	29.4	4.91	27.3	4.68
	13.0	11.8	33.3	4.83	31.4	4.69	29.5	4.58	28.6	4.40	27.6	4.24	25.7	4.04
15.0	13.7	31.5	4.33	29.7	4.21	27.9	4.10	27.1	3.95	26.1	3.80	24.3	3.62	

# 7. Capacity Tables

Heating Capacity (14HP)

Combination (%)	Outdoor air temp.		Indoor air temp. °C DB											
			16		18		20		21		22		24	
	°C DB	°C WB	TC	PI	TC	PI	TC	PI	TC	PI	TC	PI	TC	PI
70	-24.8	-25	26.7	11.66	26.7	11.75	26.5	11.93	26.5	12.20	26.5	11.63	26.0	11.09
	-21.8	-22	30.9	11.93	30.9	12.02	30.7	12.20	29.7	11.63	28.8	11.09	26.9	10.57
	-19.8	-20	33.8	12.11	32.7	12.20	30.7	11.80	29.7	11.25	28.8	10.74	26.9	10.23
	-18.8	-19	34.6	12.20	32.7	11.99	30.7	11.60	29.7	11.06	28.8	10.56	26.9	10.05
	-16.7	-17	34.6	11.77	32.7	11.56	30.7	11.18	29.7	10.66	28.8	10.18	26.9	9.69
	-13.7	-15	34.6	11.16	32.7	10.94	30.7	10.58	29.7	10.08	28.8	9.65	26.9	9.17
	-11.8	-13	34.6	10.77	32.7	10.54	30.7	10.19	29.7	9.72	28.8	9.31	26.9	8.84
	-9.8	-11	34.6	10.36	32.7	10.13	30.7	9.79	29.7	9.34	28.8	8.95	26.9	8.50
	-9.5	-10	34.6	10.30	32.7	10.07	30.7	9.73	29.7	9.28	28.8	8.89	26.9	8.45
	-8.5	-9.1	34.6	10.09	32.7	9.86	30.7	9.53	29.7	9.09	28.8	8.72	26.9	8.27
	-7.0	-7.6	34.6	9.79	32.7	9.55	30.7	9.23	29.7	8.80	28.8	8.45	26.9	8.01
	-5.0	-5.6	34.6	9.38	32.7	9.13	30.7	8.83	29.7	8.42	28.8	8.09	26.9	7.67
	-3.0	-3.7	34.6	8.97	32.7	8.72	30.7	8.43	29.7	8.04	28.8	7.73	26.9	7.32
	0.0	-0.7	34.6	8.35	32.7	8.10	30.7	7.83	29.7	7.47	28.8	7.20	26.9	6.80
	3.0	2.2	34.6	7.74	32.7	7.47	30.7	7.22	29.7	6.89	28.8	6.66	26.9	6.28
	5.0	4.1	34.6	6.77	32.0	6.38	30.1	6.17	29.1	5.88	28.2	5.69	26.3	5.36
	7.0	6.0	34.6	6.47	31.2	5.91	29.3	5.72	28.3	5.46	27.5	5.29	25.7	4.98
	9.0	7.9	33.4	5.58	30.0	5.10	28.3	4.93	27.3	4.71	26.5	4.56	24.7	4.29
	11.0	9.8	31.5	4.93	28.4	4.50	26.7	4.35	25.8	4.16	25.1	4.03	23.4	3.79
	13.0	11.8	29.6	4.30	26.7	3.93	25.1	3.80	24.2	3.63	23.5	3.52	21.9	3.31
15.0	13.7	28.0	3.81	25.2	3.48	23.8	3.37	22.9	3.21	22.3	3.12	20.8	2.93	
60	-24.8	-25	26.5	11.48	26.5	11.66	26.3	11.93	25.5	11.32	24.6	10.75	23.0	10.21
	-21.8	-22	28.4	11.75	28.1	11.93	26.3	11.32	25.5	10.75	24.6	10.21	23.0	9.69
	-19.8	-20	29.7	11.93	28.1	11.50	26.3	10.92	25.5	10.37	24.6	9.86	23.0	9.35
	-18.8	-19	29.7	11.72	28.1	11.29	26.3	10.71	25.5	10.18	24.6	9.68	23.0	9.17
	-16.7	-17	29.7	11.26	28.1	10.84	26.3	10.29	25.5	9.78	24.6	9.30	23.0	8.81
	-13.7	-15	29.7	10.61	28.1	10.19	26.3	9.68	25.5	9.21	24.6	8.76	23.0	8.29
	-11.8	-13	29.7	10.20	28.1	9.79	26.3	9.30	25.5	8.85	24.6	8.42	23.0	7.96
	-9.8	-11	29.7	9.77	28.1	9.36	26.3	8.89	25.5	8.47	24.6	8.06	23.0	7.61
	-9.5	-10	29.7	9.71	28.1	9.29	26.3	8.83	25.5	8.41	24.6	8.01	23.0	7.56
	-8.5	-9.1	29.7	9.49	28.1	9.08	26.3	8.63	25.5	8.22	24.6	7.83	23.0	7.39
	-7.0	-7.6	29.7	9.17	28.1	8.76	26.3	8.32	25.5	7.93	24.6	7.56	23.0	7.13
	-5.0	-5.6	29.7	8.73	28.1	8.33	26.3	7.92	25.5	7.55	24.6	7.21	23.0	6.78
	-3.0	-3.7	29.7	8.30	28.1	7.90	26.3	7.51	25.5	7.17	24.6	6.85	23.0	6.43
	0.0	-0.7	29.7	7.65	28.1	7.25	26.3	6.90	25.5	6.60	24.6	6.31	23.0	5.91
	3.0	2.2	29.7	7.00	28.1	6.61	26.3	6.29	25.5	6.03	24.6	5.77	23.0	5.39
	5.0	4.1	29.1	5.95	27.5	5.59	25.8	5.32	25.0	5.11	24.1	4.89	22.5	4.56
	7.0	6.0	28.3	5.46	26.8	5.12	25.2	4.88	24.3	4.69	23.5	4.50	22.0	4.18
	9.0	7.9	27.3	4.66	25.8	4.37	24.2	4.16	23.4	4.00	22.6	3.84	21.2	3.57
	11.0	9.8	25.8	4.12	24.4	3.86	22.9	3.68	22.1	3.53	21.4	3.39	20.0	3.15
	13.0	11.8	24.2	3.59	23.0	3.36	21.5	3.21	20.8	3.08	20.1	2.96	18.8	2.75
15.0	13.7	22.9	3.21	21.7	3.01	20.4	2.84	19.7	2.73	19.0	2.62	17.8	2.46	
50	-24.8	-25	24.8	10.10	23.4	10.37	21.9	9.83	21.2	9.32	20.5	8.85	19.1	8.40
	-21.8	-22	24.8	10.37	23.4	9.83	21.9	9.32	21.2	8.85	20.5	8.40	19.1	7.97
	-19.8	-20	24.8	10.00	23.4	9.47	21.9	8.99	21.2	8.53	20.5	8.10	19.1	7.68
	-18.8	-19	24.8	9.81	23.4	9.29	21.9	8.82	21.2	8.37	20.5	7.95	19.1	7.54
	-16.7	-17	24.8	9.41	23.4	8.91	21.9	8.46	21.2	8.03	20.5	7.64	19.1	7.24
	-13.7	-15	24.8	8.85	23.4	8.37	21.9	7.96	21.2	7.55	20.5	7.19	19.1	6.81
	-11.8	-13	24.8	8.49	23.4	8.03	21.9	7.64	21.2	7.25	20.5	6.91	19.1	6.53
	-9.8	-11	24.8	8.11	23.4	7.67	21.9	7.30	21.2	6.93	20.5	6.61	19.1	6.25
	-9.5	-10	24.8	8.06	23.4	7.61	21.9	7.25	21.2	6.88	20.5	6.57	19.1	6.20
	-8.5	-9.1	24.8	7.87	23.4	7.43	21.9	7.08	21.2	6.72	20.5	6.42	19.1	6.06
	-7.0	-7.6	24.8	7.59	23.4	7.16	21.9	6.83	21.2	6.48	20.5	6.20	19.1	5.85
	-5.0	-5.6	24.8	7.21	23.4	6.80	21.9	6.49	21.2	6.16	20.5	5.90	19.1	5.56
	-3.0	-3.7	24.8	6.83	23.4	6.44	21.9	6.15	21.2	5.84	20.5	5.60	19.1	5.27
	0.0	-0.7	24.8	6.27	23.4	5.90	21.9	5.65	21.2	5.36	20.5	5.15	19.1	4.84
	3.0	2.2	24.8	5.71	23.4	5.36	21.9	5.14	21.2	4.88	20.5	4.71	19.1	4.41
	5.0	4.1	24.3	4.82	22.9	4.52	21.5	4.34	20.8	4.13	20.1	3.99	18.8	3.73
	7.0	6.0	23.6	4.41	22.3	4.13	21.0	3.98	20.3	3.78	19.6	3.66	18.3	3.41
	9.0	7.9	22.8	3.80	21.5	3.56	20.2	3.43	19.5	3.26	18.9	3.16	17.6	2.94
	11.0	9.8	21.6	3.40	20.4	3.18	19.2	3.06	18.5	2.91	17.9	2.82	16.7	2.63
	13.0	11.8	20.2	2.93	19.1	2.74	17.9	2.64	17.4	2.53	16.8	2.43	15.6	2.28
15.0	13.7	19.1	2.63	18.1	2.46	17.0	2.37	16.4	2.25	15.9	2.18	14.8	2.03	

**Note**

1. TC: Total Capacity(kW), PI : Power Input(kW, Comp. + Outdoor fan motor)
2. Capacity tables show the average value of conditions which may occur.
3. The heating capacity table is based on the values expressed as Max. in the specification of the outdoor unit. (When measuring the Max. heating capacity, the setting status of the indoor unit is the same as that for measuring the heating capacity of the indoor unit.)

# 7. Capacity Tables

## ◆ ARUM160LTE5

Heating Capacity (16HP)

Combination (%)	Outdoor air temp.		Indoor air temp. °C DB											
			16		18		20		21		22		24	
	°C DB	°C WB	TC	PI	TC	PI	TC	PI	TC	PI	TC	PI	TC	PI
130	-24.8	-25	28.7	14.80	28.7	15.08	28.5	15.32	28.5	15.69	28.5	16.03	28.5	16.59
	-21.8	-22	35.2	15.36	35.2	15.63	35.0	15.87	35.0	16.24	35.0	16.59	35.0	17.14
	-19.8	-20	37.3	15.72	37.3	16.00	37.1	16.24	37.1	16.60	37.1	16.95	37.1	17.50
	-18.8	-19	38.3	15.91	38.3	16.18	38.1	16.42	38.1	16.79	38.1	17.14	38.1	17.69
	-16.7	-17	40.3	16.29	40.3	16.57	40.1	16.81	40.1	17.17	40.1	17.52	40.1	18.07
	-13.7	-15	43.2	16.84	43.2	17.12	42.9	17.36	42.9	17.72	42.9	18.07	42.9	17.46
	-11.8	-13	44.7	17.19	44.7	17.47	44.4	17.71	44.4	18.07	44.4	17.67	44.4	17.08
	-9.8	-11	46.3	17.56	46.3	17.83	46.0	18.07	46.0	17.65	46.0	17.24	46.0	16.67
	-9.5	-10	46.8	17.61	46.8	17.89	46.5	18.01	46.5	17.58	46.2	17.18	46.2	16.61
	-8.5	-9.1	48.7	17.80	48.7	18.07	48.4	17.80	48.4	17.37	47.0	16.96	47.0	16.40
	-7.0	-7.6	51.6	18.07	51.6	17.77	51.2	17.48	51.2	17.05	51.2	16.64	49.4	16.10
	-5.0	-5.6	55.4	17.70	55.4	17.36	55.0	17.05	55.0	16.63	55.0	16.22	51.3	15.69
	-3.0	-3.7	59.2	17.32	59.2	16.96	58.8	16.63	58.8	16.20	58.8	15.79	53.2	15.28
	0.0	-0.7	64.9	16.75	64.9	16.35	64.4	15.99	63.3	15.56	61.1	15.15	56.1	14.67
	3.0	2.2	65.1	16.18	65.1	15.74	64.9	15.35	63.3	14.93	61.1	14.51	56.9	14.06
	5.0	4.1	64.0	14.35	63.8	13.91	63.6	13.52	62.1	13.12	59.9	12.73	55.8	12.32
	7.0	6.0	62.3	13.73	62.2	13.29	62.0	12.90	60.5	12.53	58.4	12.15	54.3	11.79
	9.0	7.9	60.0	12.88	59.9	12.46	59.7	12.10	58.3	11.75	56.2	11.40	52.3	11.06
	11.0	9.8	56.8	12.18	56.7	11.79	56.5	11.45	55.1	11.12	53.2	10.78	49.5	10.46
	13.0	11.8	53.3	11.32	53.2	10.95	53.1	10.63	51.7	10.32	49.9	10.02	46.5	9.72
15.0	13.7	50.5	10.61	50.4	10.27	50.2	9.97	49.0	9.68	47.2	9.39	44.0	9.11	
120	-24.8	-25	28.5	15.08	28.5	15.32	28.3	15.69	28.3	16.03	28.3	16.59	28.3	16.97
	-21.8	-22	35.0	15.63	35.0	15.87	34.8	16.24	34.8	16.59	34.8	17.14	34.8	17.52
	-19.8	-20	37.1	16.00	37.1	16.24	36.8	16.60	36.8	16.95	36.8	17.50	36.8	17.89
	-18.8	-19	38.0	16.18	38.0	16.42	37.8	16.79	37.8	17.14	37.8	17.69	37.8	18.07
	-16.7	-17	40.0	16.57	40.0	16.81	39.8	17.17	39.8	17.52	39.8	18.07	39.8	17.68
	-13.7	-15	42.9	17.12	42.9	17.36	42.6	17.72	42.6	18.07	42.6	17.49	42.6	17.12
	-11.8	-13	44.4	17.47	44.4	17.71	44.1	18.07	44.1	17.66	44.1	17.12	44.1	16.76
	-9.8	-11	45.9	17.83	45.9	18.07	45.6	17.63	45.6	17.23	45.6	16.74	45.6	16.39
	-9.5	-10	46.5	17.89	46.5	18.00	46.2	17.56	46.2	17.17	46.2	16.68	46.2	16.33
	-8.5	-9.1	48.4	18.07	48.4	17.77	48.1	17.34	48.1	16.95	47.6	16.49	47.6	16.14
	-7.0	-7.6	51.2	17.73	51.2	17.42	50.9	17.00	50.9	16.63	49.0	16.19	49.0	15.86
	-5.0	-5.6	55.0	17.28	55.0	16.95	54.6	16.56	54.6	16.20	54.6	15.81	50.9	15.49
	-3.0	-3.7	58.7	16.82	58.7	16.49	58.4	16.11	58.4	15.77	57.5	15.42	52.8	15.11
	0.0	-0.7	64.4	16.14	63.9	15.79	61.4	15.44	59.4	15.12	57.5	14.84	53.4	14.55
	3.0	2.2	64.6	15.46	63.9	15.09	61.4	14.77	59.4	14.47	57.5	14.26	53.4	13.99
	5.0	4.1	63.5	13.61	62.7	13.25	60.2	12.96	58.2	12.69	56.4	12.51	52.4	12.27
	7.0	6.0	61.9	12.95	61.1	12.60	58.7	12.35	56.7	12.11	54.9	12.00	51.0	11.79
	9.0	7.9	59.6	12.11	58.8	11.78	56.5	11.55	54.6	11.33	52.9	11.22	49.2	11.02
	11.0	9.8	56.4	11.41	55.6	11.10	53.4	10.88	51.7	10.68	50.1	10.57	46.5	10.39
	13.0	11.8	52.9	10.56	52.2	10.27	50.2	10.07	48.5	9.88	47.0	9.78	43.7	9.61
15.0	13.7	50.1	9.85	49.4	9.58	47.5	9.39	45.9	9.22	44.5	9.13	41.3	8.97	
110	-24.8	-25	28.3	15.32	28.3	15.69	28.2	16.03	28.2	16.59	28.2	16.97	28.2	17.16
	-21.8	-22	34.8	15.87	34.8	16.24	34.6	16.59	34.6	17.14	34.6	17.52	34.6	17.71
	-19.8	-20	36.9	16.24	36.9	16.60	36.6	16.95	36.6	17.50	36.6	17.89	36.6	18.07
	-18.8	-19	37.8	16.42	37.8	16.79	37.6	17.14	37.6	17.69	37.6	18.07	37.6	17.86
	-16.7	-17	39.8	16.81	39.8	17.17	39.6	17.52	39.6	18.07	39.6	17.64	39.6	17.41
	-13.7	-15	42.7	17.36	42.7	17.72	42.4	18.07	42.4	17.42	42.4	17.03	42.4	16.78
	-11.8	-13	44.1	17.71	44.1	18.07	43.9	17.62	43.9	17.01	43.9	16.63	43.9	16.37
	-9.8	-11	45.7	18.07	45.7	17.56	45.4	17.14	45.4	16.58	45.4	16.22	45.4	15.95
	-9.5	-10	46.2	17.99	46.2	17.48	46.0	17.06	46.0	16.51	46.0	16.16	46.0	15.88
	-8.5	-9.1	48.1	17.72	48.1	17.23	47.8	16.82	47.8	16.30	47.5	15.96	47.5	15.67
	-7.0	-7.6	50.9	17.30	50.9	16.84	50.6	16.46	50.6	15.97	49.1	15.65	48.1	15.35
	-5.0	-5.6	54.7	16.75	54.7	16.33	54.3	15.98	53.3	15.54	50.6	15.24	48.1	14.93
	-3.0	-3.7	58.4	16.20	58.4	15.81	55.1	15.50	53.3	15.10	51.5	14.83	48.1	14.50
	0.0	-0.7	62.1	15.37	58.7	15.04	55.1	14.78	53.3	14.45	51.5	14.21	48.1	13.86
	3.0	2.2	62.1	14.55	58.7	14.27	55.1	14.06	53.3	13.80	51.5	13.59	48.1	13.23
	5.0	4.1	60.9	12.69	57.5	12.46	54.0	12.28	52.2	12.07	50.5	11.89	47.1	11.54
	7.0	6.0	59.3	11.97	56.1	11.79	52.6	11.66	50.9	11.51	49.2	11.37	45.9	11.02
	9.0	7.9	57.2	11.13	54.0	10.96	50.7	10.84	49.0	10.71	47.4	10.57	44.3	10.24
	11.0	9.8	54.1	10.43	51.1	10.27	47.9	10.15	46.4	10.03	44.8	9.90	41.8	9.60
	13.0	11.8	50.8	9.58	48.0	9.44	45.0	9.33	43.6	9.22	42.1	9.10	39.3	8.82
15.0	13.7	48.0	8.87	45.4	8.74	42.6	8.64	41.2	8.53	39.8	8.42	37.2	8.16	



# 7. Capacity Tables

Heating Capacity (16HP)

Combination (%)	Outdoor air temp.		Indoor air temp. °C DB											
			16		18		20		21		22		24	
	°C DB	°C WB	TC	PI	TC	PI	TC	PI	TC	PI	TC	PI	TC	PI
100	-24.8	-25	28.2	16.89	28.2	17.04	28.0	16.61	28.0	17.43	28.0	17.60	28.0	17.68
	-21.8	-22	34.6	17.12	34.6	17.28	34.4	17.14	34.4	17.67	34.4	18.06	34.4	17.92
	-19.8	-20	36.7	17.28	36.7	17.44	36.5	17.49	36.5	17.83	36.5	18.07	36.5	18.07
	-18.8	-19	37.7	17.36	37.4	17.52	37.4	17.67	37.4	17.91	37.4	18.07	37.4	17.81
	-16.7	-17	39.4	17.53	39.4	17.69	39.4	18.06	39.2	18.07	39.2	17.53	39.2	17.24
	-13.7	-15	42.5	17.76	42.5	17.92	42.2	18.07	42.2	17.29	42.2	16.74	42.2	16.44
	-11.8	-13	43.9	17.92	43.7	18.07	43.7	17.55	43.7	16.79	43.7	16.25	43.7	15.93
	-9.8	-11	45.4	18.07	45.4	17.49	45.2	17.00	45.2	16.26	45.2	15.73	43.9	15.40
	-9.5	-10	46.0	17.98	46.0	17.41	45.8	16.92	45.8	16.18	45.8	15.65	43.9	15.32
	-8.5	-9.1	47.8	17.68	47.8	17.11	47.6	16.65	48.8	15.92	47.2	15.39	43.9	15.05
	-7.0	-7.6	51.5	17.23	51.3	16.68	50.4	16.23	48.8	15.53	47.2	14.99	43.9	14.65
	-5.0	-5.6	53.8	16.63	53.2	16.10	50.4	15.68	48.8	15.00	47.2	14.47	43.9	14.12
	-3.0	-3.7	55.3	16.03	53.6	15.52	50.4	15.14	48.8	14.48	47.2	13.95	43.9	13.58
	0.0	-0.7	56.9	15.12	53.6	14.64	50.4	14.31	48.8	13.69	47.2	13.17	43.9	12.78
	3.0	2.2	56.9	14.22	53.6	13.77	50.4	13.49	48.8	12.90	47.2	12.38	43.9	11.98
	5.0	4.1	55.7	12.36	52.6	11.95	49.4	11.71	47.8	11.18	46.2	10.71	43.1	10.33
	7.0	6.0	54.3	11.59	51.2	11.22	48.1	11.03	46.6	10.55	45.1	10.09	42.0	9.71
	9.0	7.9	52.3	10.66	49.3	10.32	46.4	10.14	44.9	9.70	43.4	9.28	40.4	8.93
	11.0	9.8	49.5	9.86	46.7	9.55	43.8	9.38	42.4	8.98	41.0	8.59	38.2	8.26
	13.0	11.8	46.4	8.93	43.8	8.65	41.2	8.50	39.9	8.13	38.5	7.78	35.9	7.48
15.0	13.7	43.9	8.13	41.5	7.88	39.0	7.74	37.7	7.40	36.5	7.08	34.0	6.81	
90	-24.8	-25	28.1	15.08	28.1	15.63	27.9	16.02	27.9	16.20	27.9	16.57	27.9	17.12
	-21.8	-22	34.5	15.63	34.5	16.18	34.3	16.57	34.3	16.75	34.3	17.12	34.3	16.44
	-19.8	-20	36.6	16.00	36.6	16.55	36.3	16.93	36.3	17.12	36.3	16.66	36.3	15.99
	-18.8	-19	37.7	16.18	37.4	16.73	37.3	17.12	37.3	16.88	37.3	16.43	37.3	15.76
	-16.7	-17	39.4	16.57	39.4	17.12	39.2	16.64	39.2	16.39	39.2	15.95	39.2	15.28
	-13.7	-15	42.5	17.12	42.5	16.41	42.1	15.95	42.1	15.69	42.1	15.26	40.2	14.60
	-11.8	-13	43.9	16.64	43.7	15.96	43.5	15.52	43.5	15.24	43.2	14.83	40.2	14.17
	-9.8	-11	45.4	16.13	45.4	15.49	45.0	15.06	44.7	14.77	43.2	14.37	40.2	13.72
	-9.5	-10	46.0	16.06	46.0	15.42	45.6	14.99	44.7	14.70	43.2	14.30	40.2	13.65
	-8.5	-9.1	47.8	15.81	47.5	15.18	46.1	14.76	44.7	14.47	43.2	14.07	40.2	13.43
	-7.0	-7.6	51.5	15.43	49.0	14.83	46.1	14.42	44.7	14.12	43.2	13.73	40.2	13.09
	-5.0	-5.6	52.1	14.92	49.0	14.36	46.1	13.96	44.7	13.65	43.2	13.27	40.2	12.63
	-3.0	-3.7	52.1	14.42	49.0	13.89	46.1	13.51	44.7	13.18	43.2	12.81	40.2	12.18
	0.0	-0.7	52.1	13.66	49.0	13.18	46.1	12.82	44.7	12.48	43.2	12.12	40.2	11.50
	3.0	2.2	52.1	12.91	49.0	12.47	46.1	12.14	44.7	11.78	43.2	11.43	40.2	10.82
	5.0	4.1	51.0	11.22	48.0	10.84	45.2	10.54	43.8	10.20	42.4	9.90	39.4	9.35
	7.0	6.0	49.7	10.59	46.8	10.26	44.0	9.99	42.7	9.65	41.3	9.36	38.4	8.83
	9.0	7.9	47.9	9.74	45.1	9.44	42.4	9.19	41.1	8.87	39.8	8.61	37.0	8.12
	11.0	9.8	45.3	8.92	42.6	8.65	40.1	8.41	38.9	8.13	37.6	7.89	34.9	7.44
	13.0	11.8	42.5	7.92	40.0	7.67	37.7	7.47	36.5	7.21	35.3	7.00	32.8	6.60
15.0	13.7	40.2	7.13	37.9	6.92	35.6	6.73	34.5	6.50	33.4	6.31	31.1	5.95	
80	-24.8	-25	28.0	13.14	28.0	13.69	27.8	14.08	27.8	14.26	27.8	15.18	27.8	14.58
	-21.8	-22	34.1	13.69	34.1	14.24	34.1	14.63	34.1	15.18	34.1	14.58	34.1	14.00
	-19.8	-20	36.2	14.06	36.2	14.61	36.2	15.18	36.2	14.76	36.2	14.18	35.9	13.62
	-18.8	-19	37.1	14.24	37.1	15.18	37.1	14.97	37.1	14.55	37.1	13.98	35.9	13.42
	-16.7	-17	39.2	15.18	39.2	14.74	39.2	14.53	39.2	14.11	38.6	13.57	35.9	13.02
	-13.7	-15	43.1	14.54	42.3	14.12	41.3	13.90	40.0	13.48	38.6	12.97	35.9	12.44
	-11.8	-13	44.2	14.14	42.9	13.73	41.3	13.50	40.0	13.09	38.6	12.59	35.9	12.08
	-9.8	-11	45.0	13.71	43.3	13.32	41.3	13.08	40.0	12.67	38.6	12.19	35.9	11.69
	-9.5	-10	45.3	13.65	43.6	13.25	41.3	13.01	40.0	12.60	38.6	12.13	35.9	11.63
	-8.5	-9.1	45.9	13.43	43.9	13.05	41.3	12.80	40.0	12.40	38.6	11.93	35.9	11.44
	-7.0	-7.6	46.6	13.11	43.9	12.74	41.3	12.49	40.0	12.08	38.6	11.64	35.9	11.15
	-5.0	-5.6	46.6	12.69	43.9	12.32	41.3	12.07	40.0	11.66	38.6	11.24	35.9	10.76
	-3.0	-3.7	46.6	12.26	43.9	11.91	41.3	11.65	40.0	11.24	38.6	10.84	35.9	10.38
	0.0	-0.7	46.6	11.62	43.9	11.29	41.3	11.02	40.0	10.62	38.6	10.24	35.9	9.80
	3.0	2.2	46.6	10.98	43.9	10.67	41.3	10.39	40.0	9.99	38.6	9.65	35.9	9.22
	5.0	4.1	45.7	9.54	43.1	9.25	40.4	9.00	39.2	8.63	37.8	8.34	35.2	7.96
	7.0	6.0	44.5	9.02	42.0	8.76	39.4	8.50	38.2	8.14	36.8	7.88	34.3	7.52
	9.0	7.9	42.9	8.06	40.4	7.83	38.0	7.64	36.8	7.34	35.5	7.08	33.0	6.75
	11.0	9.8	40.6	7.15	38.2	6.95	35.9	6.78	34.8	6.51	33.6	6.28	31.2	5.99
	13.0	11.8	38.1	6.20	35.9	6.03	33.7	5.88	32.7	5.65	31.5	5.45	29.3	5.19
15.0	13.7	36.0	5.59	34.0	5.43	31.9	5.29	30.9	5.09	29.8	4.91	27.7	4.68	

# 7. Capacity Tables

Heating Capacity (16HP)

Combination (%)	Outdoor air temp.		Indoor air temp. °C DB													
			16		18		20		21		22		24			
	°C DB	°C WB	TC	PI	TC	PI	TC	PI	TC	PI	TC	PI	TC	PI		
70	-24.8	-25	28.0	13.53	28.0	13.71	27.8	14.08	27.8	14.63	27.8	13.98	27.8	13.38	27.8	13.38
	-21.8	-22	34.1	14.08	34.4	14.26	34.1	14.63	33.9	13.98	32.9	13.38	30.7	12.79	30.7	12.79
	-19.8	-20	36.2	14.44	36.2	14.63	35.1	14.18	33.9	13.56	32.9	12.98	30.7	12.40	30.7	12.40
	-18.8	-19	37.1	14.63	37.1	14.40	35.1	13.96	33.9	13.34	32.9	12.78	30.7	12.20	30.7	12.20
	-16.7	-17	39.2	14.16	37.3	13.92	35.1	13.49	33.9	12.89	32.9	12.35	30.7	11.79	30.7	11.79
	-13.7	-15	39.5	13.48	37.3	13.23	35.1	12.82	33.9	12.25	32.9	11.75	30.7	11.20	30.7	11.20
	-11.8	-13	39.5	13.05	37.3	12.79	35.1	12.39	33.9	11.84	32.9	11.37	30.7	10.82	30.7	10.82
	-9.8	-11	39.5	12.60	37.3	12.33	35.1	11.94	33.9	11.41	32.9	10.96	30.7	10.43	30.7	10.43
	-9.5	-10	39.5	12.54	37.3	12.26	35.1	11.88	33.9	11.35	32.9	10.90	30.7	10.37	30.7	10.37
	-8.5	-9.1	39.5	12.31	37.3	12.03	35.1	11.65	33.9	11.14	32.9	10.70	30.7	10.17	30.7	10.17
	-7.0	-7.6	39.5	11.97	37.3	11.69	35.1	11.32	33.9	10.81	32.9	10.40	30.7	9.88	30.7	9.88
	-5.0	-5.6	39.5	11.52	37.3	11.23	35.1	10.87	33.9	10.39	32.9	10.00	30.7	9.49	30.7	9.49
	-3.0	-3.7	39.5	11.07	37.3	10.77	35.1	10.42	33.9	9.96	32.9	9.59	30.7	9.09	30.7	9.09
	0.0	-0.7	39.5	10.40	37.3	10.08	35.1	9.75	33.9	9.31	32.9	8.99	30.7	8.50	30.7	8.50
	3.0	2.2	39.5	9.72	37.3	9.39	35.1	9.08	33.9	8.67	32.9	8.38	30.7	7.91	30.7	7.91
	5.0	4.1	39.5	8.57	36.6	8.07	34.4	7.79	33.2	7.44	32.3	7.20	30.1	6.78	30.1	6.78
	7.0	6.0	39.6	8.25	35.6	7.54	33.5	7.28	32.4	6.96	31.4	6.75	29.3	6.34	29.3	6.34
	9.0	7.9	38.1	7.13	34.3	6.52	32.3	6.30	31.2	6.01	30.3	5.83	28.2	5.48	28.2	5.48
	11.0	9.8	36.1	6.32	32.5	5.77	30.6	5.58	29.5	5.33	28.6	5.17	26.7	4.86	26.7	4.86
	13.0	11.8	33.9	5.53	30.5	5.05	28.7	4.89	27.7	4.66	26.9	4.52	25.1	4.25	25.1	4.25
15.0	13.7	32.0	4.92	28.9	4.50	27.1	4.35	26.2	4.15	25.4	4.02	23.7	3.78	23.7	3.78	
60	-24.8	-25	28.0	13.16	28.0	13.53	27.8	14.08	27.8	13.41	27.8	12.78	26.3	12.18	26.3	12.18
	-21.8	-22	31.5	13.71	32.1	14.08	30.1	13.41	29.1	12.78	28.1	12.18	26.3	11.60	26.3	11.60
	-19.8	-20	33.9	14.08	32.1	13.61	30.1	12.96	29.1	12.36	28.1	11.78	26.3	11.21	26.3	11.21
	-18.8	-19	33.9	13.84	32.1	13.37	30.1	12.74	29.1	12.15	28.1	11.58	26.3	11.01	26.3	11.01
	-16.7	-17	33.9	13.35	32.1	12.88	30.1	12.27	29.1	11.70	28.1	11.16	26.3	10.60	26.3	10.60
	-13.7	-15	33.9	12.65	32.1	12.18	30.1	11.60	29.1	11.07	28.1	10.57	26.3	10.02	26.3	10.02
	-11.8	-13	33.9	12.21	32.1	11.73	30.1	11.18	29.1	10.67	28.1	10.19	26.3	9.65	26.3	9.65
	-9.8	-11	33.9	11.74	32.1	11.27	30.1	10.73	29.1	10.25	28.1	9.79	26.3	9.26	26.3	9.26
	-9.5	-10	33.9	11.67	32.1	11.20	30.1	10.67	29.1	10.19	28.1	9.73	26.3	9.20	26.3	9.20
	-8.5	-9.1	33.9	11.44	32.1	10.96	30.1	10.44	29.1	9.98	28.1	9.53	26.3	9.01	26.3	9.01
	-7.0	-7.6	33.9	11.09	32.1	10.61	30.1	10.11	29.1	9.66	28.1	9.23	26.3	8.72	26.3	8.72
	-5.0	-5.6	33.9	10.63	32.1	10.14	30.1	9.66	29.1	9.24	28.1	8.83	26.3	8.33	26.3	8.33
	-3.0	-3.7	33.9	10.16	32.1	9.67	30.1	9.22	29.1	8.82	28.1	8.44	26.3	7.94	26.3	7.94
	0.0	-0.7	33.9	9.46	32.1	8.97	30.1	8.55	29.1	8.19	28.1	7.84	26.3	7.35	26.3	7.35
	3.0	2.2	33.9	8.76	32.1	8.27	30.1	7.88	29.1	7.56	28.1	7.24	26.3	6.77	26.3	6.77
	5.0	4.1	33.2	7.50	31.5	7.05	29.5	6.71	28.5	6.45	27.5	6.18	25.8	5.76	25.8	5.76
	7.0	6.0	32.4	6.97	30.7	6.53	28.7	6.22	27.8	5.98	26.8	5.74	25.1	5.33	25.1	5.33
	9.0	7.9	31.2	5.96	29.5	5.58	27.7	5.32	26.8	5.11	25.8	4.91	24.2	4.56	24.2	4.56
	11.0	9.8	29.5	5.28	27.9	4.94	26.2	4.71	25.3	4.53	24.4	4.34	22.9	4.04	22.9	4.04
	13.0	11.8	27.7	4.62	26.2	4.33	24.6	4.12	23.8	3.96	23.0	3.80	21.5	3.54	21.5	3.54
15.0	13.7	26.2	4.15	24.8	3.88	23.3	3.67	22.5	3.53	21.7	3.38	20.3	3.17	20.3	3.17	
50	-24.8	-25	28.3	12.05	26.7	12.60	25.1	11.97	24.3	11.38	23.5	10.81	21.9	10.29	21.9	10.29
	-21.8	-22	28.3	12.60	26.7	11.97	25.1	11.38	24.3	10.81	23.5	10.29	21.9	9.78	21.9	9.78
	-19.8	-20	28.3	12.16	26.7	11.55	25.1	10.98	24.3	10.44	23.5	9.94	21.9	9.44	21.9	9.44
	-18.8	-19	28.3	11.95	26.7	11.34	25.1	10.79	24.3	10.25	23.5	9.76	21.9	9.27	21.9	9.27
	-16.7	-17	28.3	11.49	26.7	10.90	25.1	10.37	24.3	9.86	23.5	9.40	21.9	8.91	21.9	8.91
	-13.7	-15	28.3	10.83	26.7	10.27	25.1	9.78	24.3	9.29	23.5	8.87	21.9	8.40	21.9	8.40
	-11.8	-13	28.3	10.42	26.7	9.87	25.1	9.40	24.3	8.94	23.5	8.54	21.9	8.08	21.9	8.08
	-9.8	-11	28.3	9.98	26.7	9.45	25.1	9.01	24.3	8.56	23.5	8.19	21.9	7.74	21.9	7.74
	-9.5	-10	28.3	9.92	26.7	9.38	25.1	8.95	24.3	8.51	23.5	8.13	21.9	7.69	21.9	7.69
	-8.5	-9.1	28.3	9.70	26.7	9.17	25.1	8.75	24.3	8.32	23.5	7.96	21.9	7.52	21.9	7.52
	-7.0	-7.6	28.3	9.37	26.7	8.86	25.1	8.46	24.3	8.04	23.5	7.70	21.9	7.27	21.9	7.27
	-5.0	-5.6	28.3	8.93	26.7	8.44	25.1	8.06	24.3	7.66	23.5	7.34	21.9	6.93	21.9	6.93
	-3.0	-3.7	28.3	8.50	26.7	8.02	25.1	7.67	24.3	7.29	23.5	6.99	21.9	6.59	21.9	6.59
	0.0	-0.7	28.3	7.84	26.7	7.38	25.1	7.08	24.3	6.72	23.5	6.47	21.9	6.08	21.9	6.08
	3.0	2.2	28.3	7.19	26.7	6.75	25.1	6.48	24.3	6.16	23.5	5.94	21.9	5.57	21.9	5.57
	5.0	4.1	27.7	6.10	26.2	5.72	24.6	5.50	23.8	5.23	23.0	5.05	21.4	4.73	21.4	4.73
	7.0	6.0	27.0	5.62	25.5	5.26	24.0	5.07	23.2	4.81	22.4	4.67	20.9	4.35	20.9	4.35
	9.0	7.9	26.0	4.86	24.6	4.55	23.1	4.38	22.3	4.16	21.6	4.03	20.1	3.76	20.1	3.76
	11.0	9.8	24.7	4.35	23.3	4.07	21.9	3.92	21.1	3.73	20.4	3.61	19.0	3.37	19.0	3.37
	13.0	11.8	23.1	3.77	21.8	3.53	20.5	3.40	19.8	3.25	19.2	3.13	17.9	2.94	17.9	2.94
15.0	13.7	21.9	3.39	20.6	3.18	19.4	3.06	18.8	2.91	18.1	2.82	16.9	2.63	16.9	2.63	

**Note**

1. TC: Total Capacity(kW), PI : Power Input(kW, Comp. + Outdoor fan motor)
2. Capacity tables show the average value of conditions which may occur.
3. The heating capacity table is based on the values expressed as Max. in the specification of the outdoor unit. (When measuring the Max. heating capacity, the setting status of the indoor unit is the same as that for measuring the heating capacity of the indoor unit.)

# 7. Capacity Tables

## ◆ ARUM180LTE5

Heating Capacity (18HP)

Combination (%)	Outdoor air temp.		Indoor air temp. °C DB											
			16		18		20		21		22		24	
	°C DB	°C WB	TC	PI	TC	PI	TC	PI	TC	PI	TC	PI	TC	PI
130	-24.8	-25	37.3	17.62	37.3	17.73	37.0	17.83	37.0	17.98	37.0	18.13	36.3	18.36
	-21.8	-22	44.2	17.85	44.2	17.96	43.9	18.06	43.9	18.21	43.9	18.36	43.1	18.59
	-19.8	-20	46.1	18.00	46.1	18.11	45.8	18.21	45.8	18.37	45.8	18.51	44.9	18.74
	-18.8	-19	47.0	18.07	47.0	18.19	46.7	18.29	46.7	18.44	46.7	18.59	45.8	18.82
	-16.7	-17	48.9	18.24	48.9	18.35	48.5	18.45	48.5	18.60	48.5	18.75	47.6	18.98
	-13.7	-15	51.6	18.46	51.6	18.58	51.2	18.68	51.2	18.83	51.2	18.98	50.3	18.19
	-11.8	-13	53.2	18.61	53.2	18.72	52.9	18.82	52.9	18.98	52.9	18.44	51.9	17.69
	-9.8	-11	55.0	18.76	55.0	18.88	54.7	18.98	54.7	18.40	54.7	17.88	53.7	17.17
	-9.5	-10	55.3	18.79	55.3	18.90	55.0	18.89	55.0	18.31	54.9	17.80	54.0	17.09
	-8.5	-9.1	56.4	18.86	56.4	18.98	56.1	18.59	56.1	18.03	55.8	17.52	54.8	16.83
	-7.0	-7.6	58.0	18.98	58.0	18.53	57.7	18.14	57.7	17.59	57.7	17.09	56.2	16.43
	-5.0	-5.6	60.2	18.39	60.2	17.94	59.8	17.55	59.8	17.02	59.8	16.53	57.9	15.91
	-3.0	-3.7	62.3	17.80	62.3	17.35	61.9	16.95	61.9	16.44	61.9	15.97	59.7	15.39
	0.0	-0.7	65.5	16.92	65.5	16.46	65.1	16.06	65.1	15.58	65.1	15.13	62.3	14.60
	3.0	2.2	68.8	16.04	68.8	15.57	68.3	15.16	68.3	14.71	68.3	14.28	64.0	13.81
	5.0	4.1	69.6	14.05	69.5	13.60	69.1	13.21	69.1	12.81	67.4	12.41	62.7	12.00
	7.0	6.0	69.9	13.23	69.8	12.81	69.3	12.43	68.0	12.07	65.7	11.71	61.1	11.36
9.0	7.9	67.6	12.22	67.4	11.82	67.2	11.48	65.5	11.15	63.3	10.81	58.9	10.49	
11.0	9.8	63.9	11.35	63.8	10.99	63.6	10.67	62.0	10.36	59.8	10.05	55.7	9.75	
13.0	11.8	60.0	10.34	59.9	10.00	59.7	9.71	58.2	9.43	56.2	9.15	52.3	8.87	
15.0	13.7	56.8	9.47	56.6	9.16	56.5	8.90	55.1	8.64	53.2	8.38	49.5	8.13	
120	-24.8	-25	37.0	17.73	37.0	17.83	36.8	17.98	36.8	18.13	36.8	18.36	36.1	18.52
	-21.8	-22	43.9	17.96	43.9	18.06	43.6	18.21	43.6	18.36	43.6	18.59	42.8	18.75
	-19.8	-20	45.7	18.11	45.7	18.21	45.4	18.37	45.4	18.51	45.4	18.74	44.6	18.90
	-18.8	-19	46.6	18.19	46.6	18.29	46.3	18.44	46.3	18.59	46.3	18.82	45.5	18.98
	-16.7	-17	48.5	18.35	48.5	18.45	48.2	18.60	48.2	18.75	48.2	18.98	47.3	18.47
	-13.7	-15	51.2	18.58	51.2	18.68	50.9	18.83	50.9	18.98	50.9	18.22	49.9	17.75
	-11.8	-13	52.9	18.72	52.9	18.82	52.5	18.98	52.5	18.44	52.5	17.74	51.6	17.29
	-9.8	-11	54.6	18.88	54.6	18.98	54.3	18.38	54.3	17.87	54.3	17.23	53.3	16.81
	-9.5	-10	54.9	18.90	54.9	18.88	54.6	18.29	54.6	17.79	54.6	17.16	53.6	16.74
	-8.5	-9.1	56.0	18.98	56.0	18.56	55.7	17.99	55.7	17.50	55.5	16.91	54.5	16.50
	-7.0	-7.6	57.6	18.50	57.6	18.09	57.2	17.55	57.2	17.08	56.8	16.53	55.8	16.13
	-5.0	-5.6	59.7	17.86	59.7	17.45	59.4	16.95	59.4	16.51	59.4	16.02	57.5	15.65
	-3.0	-3.7	61.9	17.22	61.9	16.82	61.5	16.35	61.5	15.95	61.5	15.52	59.3	15.17
	0.0	-0.7	65.1	16.26	65.1	15.86	64.7	15.46	64.7	15.10	64.7	14.76	60.1	14.45
	3.0	2.2	68.3	15.30	68.3	14.91	67.8	14.57	66.8	14.25	64.7	14.00	60.1	13.72
	5.0	4.1	69.2	13.32	69.0	12.95	67.7	12.65	65.5	12.38	63.4	12.19	58.9	11.95
	7.0	6.0	69.5	12.48	68.7	12.14	66.0	11.90	63.8	11.67	61.8	11.56	57.4	11.36
9.0	7.9	67.1	11.50	66.2	11.18	63.6	10.96	61.4	10.75	59.5	10.65	55.3	10.46	
11.0	9.8	63.4	10.66	62.6	10.37	60.1	10.16	58.1	9.97	56.3	9.87	52.3	9.70	
13.0	11.8	59.6	9.67	58.8	9.41	56.5	9.22	54.6	9.05	52.9	8.96	49.1	8.80	
15.0	13.7	56.4	8.83	55.6	8.59	53.4	8.42	51.6	8.26	50.0	8.18	46.5	8.03	
110	-24.8	-25	36.8	17.83	36.8	17.98	36.6	18.13	36.6	18.36	36.6	18.52	35.9	18.59
	-21.8	-22	43.7	18.06	43.7	18.21	43.4	18.36	43.4	18.59	43.4	18.75	42.6	18.82
	-19.8	-20	45.5	18.21	45.5	18.37	45.2	18.51	45.2	18.74	45.2	18.90	44.3	18.98
	-18.8	-19	46.4	18.29	46.4	18.44	46.1	18.59	46.1	18.82	46.1	18.98	45.2	18.71
	-16.7	-17	48.2	18.45	48.2	18.60	47.9	18.75	47.9	18.98	47.9	18.43	47.0	18.16
	-13.7	-15	50.9	18.68	50.9	18.83	50.6	18.98	50.6	18.15	50.6	17.66	50.6	17.37
	-11.8	-13	52.6	18.82	52.6	18.98	52.2	18.39	52.2	17.63	52.2	17.17	52.2	16.87
	-9.8	-11	54.3	18.98	54.3	18.32	54.0	17.78	54.0	17.08	54.0	16.65	53.3	16.35
	-9.5	-10	54.6	18.87	54.6	18.22	54.3	17.69	54.3	17.00	54.3	16.57	54.1	16.27
	-8.5	-9.1	55.7	18.51	55.7	17.89	55.4	17.38	55.4	16.72	55.4	16.31	54.1	16.00
	-7.0	-7.6	57.3	17.97	57.3	17.39	56.9	16.92	56.9	16.31	56.9	15.93	54.1	15.61
	-5.0	-5.6	59.4	17.26	59.4	16.73	59.0	16.31	59.0	15.76	57.9	15.41	54.1	15.08
	-3.0	-3.7	61.5	16.54	61.5	16.07	61.2	15.69	60.0	15.21	57.9	14.89	54.1	14.56
	0.0	-0.7	64.7	15.47	64.7	15.08	62.0	14.77	60.0	14.39	57.9	14.12	54.1	13.77
	3.0	2.2	67.9	14.39	66.1	14.09	62.0	13.85	60.0	13.57	57.9	13.34	54.1	12.98
	5.0	4.1	68.5	12.42	64.7	12.17	60.8	11.98	58.8	11.76	56.8	11.58	53.0	11.24
	7.0	6.0	66.7	11.53	63.1	11.36	59.2	11.23	57.3	11.10	55.3	10.95	51.7	10.62
9.0	7.9	64.3	10.57	60.8	10.41	57.0	10.30	55.2	10.17	53.3	10.04	49.8	9.73	
11.0	9.8	60.8	9.74	57.5	9.60	53.9	9.49	52.2	9.37	50.4	9.25	47.1	8.97	
13.0	11.8	57.1	8.79	54.0	8.65	50.7	8.56	49.0	8.45	47.3	8.34	44.2	8.09	
15.0	13.7	54.0	7.96	51.1	7.84	47.9	7.75	46.4	7.66	44.8	7.56	41.8	7.32	

# 7. Capacity Tables

Heating Capacity (18HP)

Combination (%)	Outdoor air temp.		Indoor air temp. °C DB											
			16		18		20		21		22		24	
	°C DB	°C WB	TC	PI	TC	PI	TC	PI	TC	PI	TC	PI	TC	PI
100	-24.8	-25	36.6	18.53	36.6	18.59	36.4	17.83	36.4	18.73	36.4	18.80	35.7	18.83
	-21.8	-22	43.5	18.62	43.5	18.68	43.2	18.40	43.2	18.82	43.2	18.98	42.4	18.92
	-19.8	-20	45.3	18.68	45.3	18.74	45.0	18.75	45.0	18.88	45.0	18.98	44.2	18.98
	-18.8	-19	46.2	18.71	45.9	18.77	45.9	18.82	45.9	18.91	45.9	18.98	45.0	18.66
	-16.7	-17	47.7	18.77	47.7	18.83	47.7	18.98	47.5	18.98	47.5	18.32	46.6	18.00
	-13.7	-15	50.7	18.86	50.7	18.92	50.4	18.98	50.4	18.02	50.4	17.39	49.4	17.05
	-11.8	-13	52.3	18.92	52.0	18.98	52.0	18.33	52.0	17.41	52.0	16.79	49.4	16.45
	-9.8	-11	54.0	18.98	54.0	18.25	53.8	17.65	53.8	16.78	53.1	16.17	49.4	15.82
	-9.5	-10	54.3	18.86	54.3	18.14	54.1	17.55	54.1	16.68	53.1	16.08	49.4	15.72
	-8.5	-9.1	55.4	18.48	55.4	17.78	55.1	17.21	54.9	16.36	53.1	15.76	49.4	15.41
	-7.0	-7.6	57.9	17.90	57.7	17.23	56.7	16.70	54.9	15.89	53.1	15.30	49.4	14.93
	-5.0	-5.6	60.5	17.14	59.9	16.51	56.7	16.02	54.9	15.25	53.1	14.67	49.4	14.30
	-3.0	-3.7	62.2	16.37	60.3	15.78	56.7	15.34	54.9	14.61	53.1	14.05	49.4	13.67
	0.0	-0.7	64.0	15.23	60.3	14.69	56.7	14.32	54.9	13.65	53.1	13.11	49.4	12.72
	3.0	2.2	64.0	14.08	60.3	13.60	56.7	13.30	54.9	12.70	53.1	12.18	49.4	11.77
	5.0	4.1	62.7	12.10	59.1	11.68	55.6	11.43	53.8	10.91	52.0	10.44	48.5	10.07
	7.0	6.0	61.1	11.17	57.6	10.81	54.1	10.63	52.4	10.17	50.7	9.73	47.2	9.36
	9.0	7.9	58.8	10.03	55.5	9.71	52.2	9.55	50.5	9.13	48.8	8.74	45.5	8.40
	11.0	9.8	55.6	9.02	52.5	8.74	49.3	8.59	47.8	8.22	46.2	7.86	43.0	7.56
	13.0	11.8	52.3	7.90	49.3	7.65	46.3	7.52	44.8	7.20	43.4	6.88	40.4	6.62
15.0	13.7	49.4	6.91	46.6	6.69	43.8	6.57	42.4	6.29	41.0	6.02	38.2	5.79	
90	-24.8	-25	36.5	17.15	36.5	17.38	36.3	17.54	36.3	17.62	36.3	17.77	35.6	18.00
	-21.8	-22	43.3	17.38	43.3	17.61	43.0	17.77	43.0	17.85	43.0	18.00	42.2	17.20
	-19.8	-20	45.1	17.53	45.1	17.76	44.8	17.92	44.8	18.00	44.8	17.45	44.0	16.67
	-18.8	-19	46.2	17.61	45.9	17.84	45.7	18.00	45.7	17.72	45.7	17.18	44.8	16.41
	-16.7	-17	47.7	17.77	47.7	18.00	47.5	17.41	47.5	17.12	47.5	16.61	45.2	15.85
	-13.7	-15	50.7	18.00	50.7	17.13	50.2	16.58	50.2	16.28	48.7	15.79	45.2	15.05
	-11.8	-13	52.3	17.40	52.0	16.57	51.8	16.05	50.3	15.74	48.7	15.27	45.2	14.55
	-9.8	-11	54.0	16.77	54.0	15.99	51.9	15.49	50.3	15.18	48.7	14.72	45.2	14.02
	-9.5	-10	54.3	16.67	54.3	15.91	51.9	15.41	50.3	15.10	48.7	14.64	45.2	13.94
	-8.5	-9.1	55.4	16.36	55.0	15.62	51.9	15.13	50.3	14.81	48.7	14.37	45.2	13.67
	-7.0	-7.6	57.9	15.88	55.1	15.18	51.9	14.71	50.3	14.39	48.7	13.96	45.2	13.27
	-5.0	-5.6	58.6	15.25	55.1	14.60	51.9	14.16	50.3	13.83	48.7	13.41	45.2	12.74
	-3.0	-3.7	58.6	14.62	55.1	14.02	51.9	13.60	50.3	13.26	48.7	12.86	45.2	12.21
	0.0	-0.7	58.6	13.67	55.1	13.15	51.9	12.76	50.3	12.42	48.7	12.05	45.2	11.41
	3.0	2.2	58.6	12.73	55.1	12.27	51.9	11.93	50.3	11.57	48.7	11.23	45.2	10.62
	5.0	4.1	57.4	10.96	54.0	10.57	50.8	10.27	49.3	9.95	47.7	9.64	44.3	9.10
	7.0	6.0	55.9	10.20	52.6	9.89	49.5	9.62	48.0	9.30	46.5	9.02	43.2	8.51
	9.0	7.9	53.9	9.17	50.7	8.88	47.7	8.64	46.2	8.35	44.8	8.10	41.6	7.64
	11.0	9.8	51.0	8.16	47.9	7.91	45.1	7.70	43.7	7.44	42.3	7.22	39.3	6.80
	13.0	11.8	47.8	7.00	45.0	6.79	42.4	6.61	41.1	6.38	39.7	6.19	36.9	5.84
15.0	13.7	45.3	6.06	42.6	5.87	40.1	5.71	38.9	5.52	37.6	5.35	34.9	5.05	
80	-24.8	-25	36.3	15.11	36.3	15.34	36.1	15.50	36.1	15.58	36.1	15.96	35.4	15.26
	-21.8	-22	42.9	15.34	42.9	15.57	42.9	15.73	42.9	15.96	42.9	15.26	40.4	14.59
	-19.8	-20	44.6	15.49	44.6	15.72	44.6	15.96	44.6	15.46	43.4	14.79	40.4	14.14
	-18.8	-19	45.5	15.57	45.5	15.96	45.5	15.71	45.0	15.22	43.4	14.56	40.4	13.92
	-16.7	-17	46.4	15.96	46.4	15.43	46.4	15.18	45.0	14.70	43.4	14.07	40.4	13.45
	-13.7	-15	48.5	15.18	47.6	14.68	46.4	14.42	45.0	13.95	43.4	13.37	40.4	12.78
	-11.8	-13	50.1	14.68	48.6	14.20	46.4	13.94	45.0	13.48	43.4	12.92	40.4	12.35
	-9.8	-11	51.4	14.16	49.1	13.70	46.4	13.44	45.0	12.98	43.4	12.45	40.4	11.90
	-9.5	-10	51.7	14.08	49.4	13.62	46.4	13.36	45.0	12.91	43.4	12.38	40.4	11.84
	-8.5	-9.1	52.1	13.82	49.4	13.37	46.4	13.11	45.0	12.66	43.4	12.15	40.4	11.61
	-7.0	-7.6	52.4	13.42	49.4	13.00	46.4	12.73	45.0	12.29	43.4	11.80	40.4	11.28
	-5.0	-5.6	52.4	12.90	49.4	12.49	46.4	12.23	45.0	11.79	43.4	11.33	40.4	10.83
	-3.0	-3.7	52.4	12.38	49.4	11.99	46.4	11.72	45.0	11.30	43.4	10.87	40.4	10.38
	0.0	-0.7	52.4	11.59	49.4	11.24	46.4	10.97	45.0	10.55	43.4	10.16	40.4	9.71
	3.0	2.2	52.4	10.81	49.4	10.49	46.4	10.21	45.0	9.81	43.4	9.46	40.4	9.04
	5.0	4.1	51.4	9.30	48.4	9.02	45.5	8.77	44.1	8.41	42.5	8.12	39.6	7.75
	7.0	6.0	50.1	8.69	47.2	8.44	44.3	8.19	43.0	7.85	41.4	7.59	38.6	7.25
	9.0	7.9	48.2	7.56	45.5	7.35	42.7	7.17	41.4	6.90	39.9	6.65	37.1	6.34
	11.0	9.8	45.6	6.52	43.0	6.34	40.4	6.19	39.2	5.95	37.8	5.74	35.1	5.47
	13.0	11.8	42.8	5.47	40.4	5.32	37.9	5.19	36.8	4.99	35.5	4.82	33.0	4.59
15.0	13.7	40.5	4.73	38.2	4.60	35.9	4.49	34.8	4.31	33.5	4.16	31.2	3.96	

## 7. Capacity Tables

## Heating Capacity (18HP)

Combination (%)	Outdoor air temp.		Indoor air temp. °C DB											
			16		18		20		21		22		24	
	°C DB	°C WB	TC	PI	TC	PI	TC	PI	TC	PI	TC	PI	TC	PI
70	-24.8	-25	36.3	15.13	36.3	15.20	36.1	15.36	36.1	15.59	36.1	14.83	34.5	14.12
	-21.8	-22	39.8	15.36	39.8	15.43	39.5	15.59	38.2	14.83	37.0	14.12	34.5	13.43
	-19.8	-20	42.0	15.51	42.0	15.59	39.5	15.05	38.2	14.32	37.0	13.64	34.5	12.98
	-18.8	-19	43.2	15.59	42.0	15.31	39.5	14.78	38.2	14.07	37.0	13.41	34.5	12.75
	-16.7	-17	44.5	15.01	42.0	14.73	39.5	14.22	38.2	13.53	37.0	12.91	34.5	12.27
	-13.7	-15	44.5	14.19	42.0	13.90	39.5	13.42	38.2	12.77	37.0	12.20	34.5	11.59
	-11.8	-13	44.5	13.66	42.0	13.37	39.5	12.91	38.2	12.29	37.0	11.75	34.5	11.15
	-9.8	-11	44.5	13.12	42.0	12.82	39.5	12.38	38.2	11.79	37.0	11.28	34.5	10.70
	-9.5	-10	44.5	13.03	42.0	12.73	39.5	12.30	38.2	11.71	37.0	11.21	34.5	10.63
	-8.5	-9.1	44.5	12.76	42.0	12.46	39.5	12.03	38.2	11.46	37.0	10.97	34.5	10.40
	-7.0	-7.6	44.5	12.35	42.0	12.04	39.5	11.63	38.2	11.08	37.0	10.62	34.5	10.06
	-5.0	-5.6	44.5	11.80	42.0	11.49	39.5	11.10	38.2	10.57	37.0	10.14	34.5	9.60
	-3.0	-3.7	44.5	11.25	42.0	10.93	39.5	10.56	38.2	10.06	37.0	9.67	34.5	9.15
	0.0	-0.7	44.5	10.42	42.0	10.10	39.5	9.76	38.2	9.30	37.0	8.96	34.5	8.46
	3.0	2.2	44.5	9.60	42.0	9.27	39.5	8.96	38.2	8.54	37.0	8.25	34.5	7.78
	5.0	4.1	44.5	8.37	41.1	7.88	38.7	7.62	37.4	7.26	36.3	7.02	33.8	6.61
	7.0	6.0	44.5	7.95	40.1	7.26	37.7	7.02	36.4	6.70	35.4	6.50	33.0	6.11
	9.0	7.9	42.9	6.71	38.6	6.13	36.3	5.93	35.1	5.66	34.1	5.49	31.8	5.16
	11.0	9.8	40.6	5.78	36.5	5.28	34.4	5.11	33.2	4.88	32.2	4.73	30.0	4.44
	13.0	11.8	38.1	4.89	34.3	4.47	32.3	4.32	31.2	4.13	30.2	4.00	28.2	3.76
15.0	13.7	36.0	4.18	32.5	3.82	30.5	3.69	29.5	3.52	28.6	3.42	26.7	3.21	
60	-24.8	-25	34.1	14.97	34.1	15.13	33.9	15.36	32.7	14.54	31.6	13.78	29.6	13.07
	-21.8	-22	36.5	15.20	36.1	15.36	33.9	14.54	32.7	13.78	31.6	13.07	29.6	12.38
	-19.8	-20	38.2	15.36	36.1	14.78	33.9	14.00	32.7	13.27	31.6	12.59	29.6	11.92
	-18.8	-19	38.2	15.07	36.1	14.49	33.9	13.73	32.7	13.02	31.6	12.35	29.6	11.69
	-16.7	-17	38.2	14.45	36.1	13.89	33.9	13.16	32.7	12.49	31.6	11.85	29.6	11.21
	-13.7	-15	38.2	13.58	36.1	13.02	33.9	12.35	32.7	11.73	31.6	11.14	29.6	10.52
	-11.8	-13	38.2	13.02	36.1	12.48	33.9	11.83	32.7	11.24	31.6	10.69	29.6	10.09
	-9.8	-11	38.2	12.44	36.1	11.90	33.9	11.29	32.7	10.74	31.6	10.21	29.6	9.63
	-9.5	-10	38.2	12.35	36.1	11.82	33.9	11.21	32.7	10.66	31.6	10.14	29.6	9.56
	-8.5	-9.1	38.2	12.06	36.1	11.53	33.9	10.94	32.7	10.41	31.6	9.90	29.6	9.33
	-7.0	-7.6	38.2	11.62	36.1	11.10	33.9	10.53	32.7	10.03	31.6	9.54	29.6	8.99
	-5.0	-5.6	38.2	11.04	36.1	10.52	33.9	9.99	32.7	9.52	31.6	9.07	29.6	8.53
	-3.0	-3.7	38.2	10.46	36.1	9.94	33.9	9.45	32.7	9.01	31.6	8.59	29.6	8.07
	0.0	-0.7	38.2	9.58	36.1	9.08	33.9	8.63	32.7	8.25	31.6	7.88	29.6	7.38
	3.0	2.2	38.2	8.71	36.1	8.22	33.9	7.82	32.7	7.49	31.6	7.16	29.6	6.69
	5.0	4.1	37.4	7.36	35.4	6.92	33.2	6.58	32.1	6.31	31.0	6.05	29.0	5.64
	7.0	6.0	36.4	6.71	34.5	6.29	32.3	5.99	31.3	5.76	30.2	5.53	28.2	5.14
	9.0	7.9	35.1	5.61	33.2	5.25	31.2	5.01	30.1	4.81	29.1	4.62	27.2	4.29
	11.0	9.8	33.2	4.83	31.4	4.52	29.5	4.31	28.5	4.14	27.5	3.98	25.7	3.70
	13.0	11.8	31.2	4.09	29.5	3.83	27.7	3.65	26.7	3.51	25.8	3.36	24.2	3.13
15.0	13.7	29.5	3.52	27.9	3.30	26.2	3.11	25.3	2.99	24.4	2.87	22.9	2.70	
50	-24.8	-25	31.8	13.02	30.0	13.25	28.2	12.54	27.3	11.87	26.4	11.24	24.6	10.66
	-21.8	-22	31.8	13.25	30.0	12.54	28.2	11.87	27.3	11.24	26.4	10.66	24.6	10.10
	-19.8	-20	31.8	12.75	30.0	12.06	28.2	11.43	27.3	10.82	26.4	10.27	24.6	9.72
	-18.8	-19	31.8	12.50	30.0	11.82	28.2	11.21	27.3	10.62	26.4	10.08	24.6	9.54
	-16.7	-17	31.8	11.98	30.0	11.33	28.2	10.74	27.3	10.18	26.4	9.67	24.6	9.14
	-13.7	-15	31.8	11.23	30.0	10.61	28.2	10.08	27.3	9.55	26.4	9.08	24.6	8.58
	-11.8	-13	31.8	10.76	30.0	10.16	28.2	9.65	27.3	9.15	26.4	8.71	24.6	8.23
	-9.8	-11	31.8	10.26	30.0	9.69	28.2	9.21	27.3	8.73	26.4	8.32	24.6	7.85
	-9.5	-10	31.8	10.19	30.0	9.62	28.2	9.14	27.3	8.67	26.4	8.26	24.6	7.80
	-8.5	-9.1	31.8	9.94	30.0	9.38	28.2	8.92	27.3	8.46	26.4	8.07	24.6	7.61
	-7.0	-7.6	31.8	9.57	30.0	9.02	28.2	8.59	27.3	8.14	26.4	7.78	24.6	7.33
	-5.0	-5.6	31.8	9.07	30.0	8.55	28.2	8.15	27.3	7.73	26.4	7.39	24.6	6.96
	-3.0	-3.7	31.8	8.57	30.0	8.07	28.2	7.70	27.3	7.31	26.4	7.00	24.6	6.58
	0.0	-0.7	31.8	7.83	30.0	7.36	28.2	7.04	27.3	6.68	26.4	6.41	24.6	6.02
	3.0	2.2	31.8	7.08	30.0	6.65	28.2	6.37	27.3	6.05	26.4	5.83	24.6	5.46
	5.0	4.1	31.2	5.96	29.4	5.58	27.7	5.36	26.8	5.09	25.9	4.92	24.1	4.60
	7.0	6.0	30.4	5.42	28.7	5.07	26.9	4.88	26.1	4.64	25.2	4.50	23.5	4.19
	9.0	7.9	29.3	4.57	27.6	4.28	26.0	4.12	25.1	3.92	24.3	3.80	22.6	3.54
	11.0	9.8	27.8	3.98	26.3	3.73	24.7	3.59	23.8	3.41	23.0	3.31	21.4	3.08
	13.0	11.8	26.0	3.33	24.5	3.12	23.1	3.01	22.3	2.87	21.6	2.77	20.1	2.60
15.0	13.7	24.6	2.88	23.2	2.70	21.8	2.60	21.1	2.47	20.4	2.39	19.0	2.23	

## Note

1. TC: Total Capacity(kW), PI : Power Input(kW, Comp. + Outdoor fan motor)
2. Capacity tables show the average value of conditions which may occur.
3. The heating capacity table is based on the values expressed as Max. in the specification of the outdoor unit. (When measuring the Max. heating capacity, the setting status of the indoor unit is the same as that for measuring the heating capacity of the indoor unit.)

# 7. Capacity Tables

## ◆ ARUM200LTE5

Heating Capacity (20HP)

Combination (%)	Outdoor air temp.		Indoor air temp. °C DB											
			16		18		20		21		22		24	
	°C DB	°C WB	TC	PI	TC	PI	TC	PI	TC	PI	TC	PI	TC	PI
130	-24.8	-25	39.5	21.22	39.5	21.29	39.2	21.35	39.2	21.44	39.2	21.53	38.5	21.66
	-21.8	-22	48.0	21.36	48.0	21.43	47.7	21.49	47.7	21.58	47.7	21.66	46.8	21.80
	-19.8	-20	50.7	21.45	50.7	21.52	50.3	21.58	50.3	21.67	50.3	21.75	49.4	21.89
	-18.8	-19	51.7	21.49	51.7	21.56	51.4	21.62	51.4	21.71	51.4	21.80	50.4	21.93
	-16.7	-17	54.0	21.59	54.0	21.66	53.7	21.72	53.7	21.81	53.7	21.89	52.7	22.03
	-13.7	-15	57.3	21.73	57.3	21.79	57.0	21.85	57.0	21.94	57.0	22.03	55.9	21.23
	-11.8	-13	59.2	21.81	59.2	21.88	58.8	21.94	58.8	22.03	58.8	21.49	57.9	20.72
	-9.8	-11	61.1	21.90	61.1	21.97	60.8	22.03	60.8	21.46	60.8	20.93	60.0	20.19
	-9.5	-10	61.5	21.92	61.5	21.98	61.1	21.94	61.1	21.38	61.1	20.84	60.3	20.11
	-8.5	-9.1	62.7	21.96	62.7	22.03	62.3	21.65	62.3	21.09	62.0	20.56	61.4	19.84
	-7.0	-7.6	64.5	22.03	64.5	21.61	64.1	21.22	64.1	20.66	64.1	20.14	63.0	19.44
	-5.0	-5.6	66.8	21.49	66.8	21.05	66.4	20.65	66.4	20.10	66.4	19.58	65.1	18.91
	-3.0	-3.7	69.2	20.96	69.2	20.49	68.8	20.07	68.8	19.53	68.8	19.01	67.2	18.37
	0.0	-0.7	72.7	20.16	72.7	19.66	72.3	19.20	72.3	18.68	72.3	18.17	70.4	17.57
	3.0	2.2	76.3	19.36	76.3	18.82	75.8	18.34	75.8	17.82	75.8	17.32	71.1	16.77
	5.0	4.1	77.2	17.10	77.1	16.56	76.6	16.10	76.6	15.61	74.9	15.15	69.7	14.66
	7.0	6.0	77.5	16.28	77.4	15.75	76.9	15.30	75.6	14.85	73.0	14.41	67.9	13.98
9.0	7.9	75.1	15.19	74.9	14.70	74.7	14.28	72.8	13.86	70.3	13.45	65.4	13.05	
11.0	9.8	71.0	14.30	70.8	13.84	70.6	13.43	68.9	13.04	66.5	12.65	61.9	12.28	
13.0	11.8	66.7	13.20	66.5	12.77	66.3	12.40	64.7	12.04	62.4	11.68	58.1	11.33	
15.0	13.7	63.1	12.29	62.9	11.89	62.7	11.55	61.2	11.21	59.1	10.88	55.0	10.55	
120	-24.8	-25	39.2	21.29	39.2	21.35	38.9	21.44	38.9	21.53	38.9	21.66	38.2	21.76
	-21.8	-22	47.7	21.43	47.7	21.49	47.4	21.58	47.4	21.66	47.4	21.80	46.5	21.89
	-19.8	-20	50.3	21.52	50.3	21.58	50.0	21.67	50.0	21.75	50.0	21.89	49.0	21.98
	-18.8	-19	51.4	21.56	51.4	21.62	51.1	21.71	51.1	21.80	51.1	21.93	50.1	22.03
	-16.7	-17	53.7	21.66	53.7	21.72	53.3	21.81	53.3	21.89	53.3	22.03	52.3	21.51
	-13.7	-15	56.9	21.79	56.9	21.85	56.6	21.94	56.6	22.03	56.6	21.26	55.5	20.78
	-11.8	-13	58.8	21.88	58.8	21.94	58.4	22.03	58.4	21.49	58.4	20.78	57.5	20.31
	-9.8	-11	60.7	21.97	60.7	22.03	60.3	21.44	60.3	20.92	60.3	20.27	59.6	19.82
	-9.5	-10	61.1	21.98	61.1	21.94	60.7	21.35	60.7	20.83	60.7	20.19	59.9	19.75
	-8.5	-9.1	62.2	22.03	62.2	21.62	61.9	21.05	61.9	20.55	61.9	19.94	61.0	19.50
	-7.0	-7.6	64.0	21.57	64.0	21.15	63.6	20.61	63.6	20.12	63.6	19.56	62.5	19.13
	-5.0	-5.6	66.4	20.95	66.4	20.53	65.9	20.01	65.9	19.55	65.9	19.05	64.7	18.64
	-3.0	-3.7	68.7	20.33	68.7	19.91	68.3	19.42	68.3	18.98	68.3	18.54	66.8	18.15
	0.0	-0.7	72.2	19.41	72.2	18.97	71.8	18.53	71.8	18.13	71.8	17.77	66.8	17.42
	3.0	2.2	75.8	18.48	75.8	18.03	75.3	17.64	74.2	17.28	71.9	17.01	66.8	16.68
	5.0	4.1	76.8	16.21	76.5	15.78	75.2	15.43	72.7	15.10	70.5	14.89	65.5	14.60
	7.0	6.0	77.1	15.35	76.3	14.94	73.3	14.64	70.9	14.36	68.7	14.23	63.8	13.97
9.0	7.9	74.5	14.29	73.5	13.90	70.6	13.63	68.3	13.37	66.2	13.24	61.4	13.00	
11.0	9.8	70.5	13.40	69.5	13.03	66.8	12.78	64.6	12.53	62.6	12.42	58.1	12.19	
13.0	11.8	66.2	12.32	65.3	11.99	62.7	11.75	60.6	11.53	58.8	11.42	54.6	11.22	
15.0	13.7	62.6	11.42	61.8	11.11	59.3	10.90	57.4	10.69	55.6	10.59	51.6	10.40	
110	-24.8	-25	39.0	21.35	39.0	21.44	38.7	21.53	38.7	21.66	38.7	21.76	38.0	21.80
	-21.8	-22	47.4	21.49	47.4	21.58	47.1	21.66	47.1	21.80	47.1	21.89	46.2	21.94
	-19.8	-20	50.0	21.58	50.0	21.67	49.7	21.75	49.7	21.89	49.7	21.98	48.7	22.03
	-18.8	-19	51.1	21.62	51.1	21.71	50.8	21.80	50.8	21.93	50.8	22.03	49.8	21.75
	-16.7	-17	53.4	21.72	53.4	21.81	53.0	21.89	53.0	22.03	53.0	21.47	52.0	21.18
	-13.7	-15	56.6	21.85	56.6	21.94	56.2	22.03	56.2	21.18	56.2	20.67	56.2	20.35
	-11.8	-13	58.4	21.94	58.4	22.03	58.1	21.43	58.1	20.65	58.1	20.16	58.1	19.83
	-9.8	-11	60.4	22.03	60.4	21.36	60.0	20.80	60.0	20.08	60.0	19.63	59.6	19.28
	-9.5	-10	60.7	21.92	60.7	21.25	60.4	20.71	60.4	20.00	60.4	19.55	60.1	19.20
	-8.5	-9.1	61.9	21.56	61.9	20.92	61.5	20.40	61.5	19.71	61.5	19.28	60.1	18.93
	-7.0	-7.6	63.7	21.01	63.7	20.41	63.3	19.92	63.3	19.29	63.3	18.88	60.1	18.52
	-5.0	-5.6	66.0	20.29	66.0	19.74	65.6	19.30	65.6	18.73	64.4	18.35	60.1	17.97
	-3.0	-3.7	68.3	19.57	68.3	19.07	67.9	18.67	66.6	18.16	64.4	17.81	60.1	17.42
	0.0	-0.7	71.8	18.48	71.8	18.06	68.9	17.73	66.6	17.31	64.4	17.01	60.1	16.59
	3.0	2.2	75.3	17.39	73.4	17.05	68.9	16.78	66.6	16.47	64.4	16.21	60.1	15.77
	5.0	4.1	76.1	15.12	71.9	14.83	67.5	14.61	65.3	14.36	63.1	14.14	58.9	13.73
	7.0	6.0	74.2	14.19	70.1	13.98	65.8	13.82	63.6	13.65	61.5	13.48	57.4	13.06
9.0	7.9	71.4	13.14	67.5	12.94	63.4	12.79	61.3	12.64	59.2	12.48	55.3	12.09	
11.0	9.8	67.6	12.24	63.9	12.06	59.9	11.93	58.0	11.78	56.0	11.63	52.3	11.27	
13.0	11.8	63.4	11.19	60.0	11.02	56.3	10.89	54.4	10.76	52.6	10.62	49.1	10.30	
15.0	13.7	60.0	10.29	56.7	10.13	53.3	10.02	51.5	9.90	49.8	9.77	46.5	9.47	

# 7. Capacity Tables

Heating Capacity (20HP)

Combination (%)	Outdoor air temp.		Indoor air temp. °C DB											
			16		18		20		21		22		24	
	°C DB	°C WB	TC	PI	TC	PI	TC	PI	TC	PI	TC	PI	TC	PI
100	-24.8	-25	38.8	23.35	38.8	23.18	38.6	21.35	38.6	22.74	38.6	22.56	37.8	22.47
	-21.8	-22	47.2	23.09	47.2	22.91	46.9	22.02	46.9	22.48	46.9	22.57	46.0	22.21
	-19.8	-20	49.8	22.91	49.8	22.73	49.5	22.43	49.5	22.30	49.5	22.21	48.5	22.03
	-18.8	-19	50.9	22.82	50.6	22.65	50.6	22.48	50.6	22.21	50.6	22.03	49.6	21.69
	-16.7	-17	52.8	22.64	52.8	22.46	52.8	22.57	52.5	22.03	52.5	21.33	51.5	20.98
	-13.7	-15	56.3	22.37	56.3	22.20	56.0	22.03	56.0	21.02	56.0	20.33	54.9	19.96
	-11.8	-13	58.1	22.21	57.8	22.03	57.8	21.36	57.8	20.38	57.8	19.70	54.9	19.31
	-9.8	-11	60.1	22.03	60.1	21.28	59.8	20.65	59.8	19.71	59.0	19.03	54.9	18.63
	-9.5	-10	60.4	21.91	60.4	21.16	60.1	20.54	60.1	19.61	59.0	18.94	54.9	18.53
	-8.5	-9.1	61.6	21.52	61.6	20.79	61.3	20.19	61.0	19.27	59.0	18.60	54.9	18.19
	-7.0	-7.6	64.4	20.93	64.1	20.22	63.0	19.65	61.0	18.76	59.0	18.10	54.9	17.68
	-5.0	-5.6	67.2	20.14	66.5	19.47	63.0	18.94	61.0	18.09	59.0	17.44	54.9	17.01
	-3.0	-3.7	69.1	19.36	67.0	18.72	63.0	18.24	61.0	17.42	59.0	16.77	54.9	16.33
	0.0	-0.7	71.1	18.18	67.0	17.59	63.0	17.17	61.0	16.41	59.0	15.77	54.9	15.31
	3.0	2.2	71.1	17.00	67.0	16.46	63.0	16.11	61.0	15.40	59.0	14.78	54.9	14.29
	5.0	4.1	69.6	14.72	65.7	14.23	61.7	13.94	59.8	13.31	57.8	12.75	53.8	12.29
	7.0	6.0	67.9	13.74	64.0	13.31	60.2	13.07	58.2	12.51	56.3	11.97	52.5	11.51
	9.0	7.9	65.4	12.66	61.7	12.26	58.0	12.05	56.1	11.52	54.3	11.03	50.5	10.60
	11.0	9.8	61.8	11.73	58.3	11.36	54.8	11.17	53.1	10.68	51.3	10.22	47.8	9.83
	13.0	11.8	58.1	10.65	54.8	10.32	51.5	10.14	49.8	9.70	48.2	9.28	44.9	8.92
15.0	13.7	54.9	9.73	51.8	9.42	48.7	9.26	47.1	8.86	45.6	8.47	42.5	8.15	
90	-24.8	-25	38.7	20.90	38.7	21.03	38.4	21.13	38.4	21.17	38.4	21.27	37.7	21.40
	-21.8	-22	47.0	21.03	47.0	21.17	46.7	21.27	46.7	21.31	46.7	21.40	45.8	20.49
	-19.8	-20	49.6	21.13	49.6	21.26	49.3	21.36	49.3	21.40	49.3	20.78	48.4	19.89
	-18.8	-19	50.9	21.17	50.6	21.31	50.4	21.40	50.4	21.08	50.4	20.47	49.4	19.58
	-16.7	-17	52.8	21.27	52.8	21.40	52.6	20.74	52.6	20.41	52.6	19.82	50.2	18.94
	-13.7	-15	56.3	21.40	56.3	20.42	55.8	19.80	55.8	19.46	54.1	18.89	50.2	18.04
	-11.8	-13	58.1	20.73	57.8	19.80	57.6	19.20	55.9	18.85	54.1	18.30	50.2	17.46
	-9.8	-11	60.1	20.03	60.1	19.15	57.6	18.58	55.9	18.21	54.1	17.68	50.2	16.85
	-9.5	-10	60.4	19.92	60.4	19.05	57.6	18.48	55.9	18.11	54.1	17.59	50.2	16.76
	-8.5	-9.1	61.6	19.57	61.1	18.73	57.6	18.17	55.9	17.80	54.1	17.28	50.2	16.46
	-7.0	-7.6	64.4	19.04	61.2	18.24	57.6	17.70	55.9	17.32	54.1	16.81	50.2	16.00
	-5.0	-5.6	65.1	18.33	61.2	17.59	57.6	17.07	55.9	16.68	54.1	16.19	50.2	15.40
	-3.0	-3.7	65.1	17.63	61.2	16.93	57.6	16.44	55.9	16.04	54.1	15.57	50.2	14.79
	0.0	-0.7	65.1	16.57	61.2	15.95	57.6	15.50	55.9	15.08	54.1	14.64	50.2	13.88
	3.0	2.2	65.1	15.52	61.2	14.98	57.6	14.56	55.9	14.13	54.1	13.71	50.2	12.97
	5.0	4.1	63.8	13.41	60.0	12.95	56.5	12.58	54.7	12.18	53.0	11.81	49.2	11.15
	7.0	6.0	62.1	12.55	58.5	12.17	55.0	11.84	53.3	11.44	51.6	11.10	48.0	10.46
	9.0	7.9	59.9	11.57	56.3	11.21	53.0	10.91	51.4	10.54	49.7	10.22	46.2	9.64
	11.0	9.8	56.6	10.62	53.3	10.29	50.1	10.01	48.6	9.67	47.0	9.38	43.7	8.85
	13.0	11.8	53.2	9.44	50.0	9.15	47.1	8.91	45.6	8.60	44.2	8.35	41.0	7.87
15.0	13.7	50.3	8.53	47.3	8.27	44.6	8.05	43.2	7.77	41.8	7.54	38.8	7.11	
80	-24.8	-25	38.5	18.47	38.5	18.61	38.3	18.71	38.3	18.75	38.3	18.98	37.5	18.18
	-21.8	-22	46.5	18.61	46.5	18.75	46.5	18.84	46.5	18.98	46.5	18.18	44.9	17.41
	-19.8	-20	49.1	18.70	49.1	18.84	49.1	18.98	49.1	18.41	48.2	17.64	44.9	16.89
	-18.8	-19	50.2	18.75	50.2	18.98	50.2	18.69	50.0	18.13	48.2	17.38	44.9	16.64
	-16.7	-17	51.6	18.98	51.6	18.38	51.6	18.09	50.0	17.54	48.2	16.82	44.9	16.10
	-13.7	-15	53.9	18.10	52.9	17.53	51.6	17.23	50.0	16.69	48.2	16.02	44.9	15.33
	-11.8	-13	55.3	17.54	53.7	16.99	51.6	16.69	50.0	16.16	48.2	15.51	44.9	14.84
	-9.8	-11	56.8	16.95	54.4	16.43	51.6	16.12	50.0	15.59	48.2	14.98	44.9	14.33
	-9.5	-10	57.2	16.86	54.7	16.34	51.6	16.03	50.0	15.51	48.2	14.90	44.9	14.25
	-8.5	-9.1	57.7	16.57	54.9	16.06	51.6	15.75	50.0	15.22	48.2	14.63	44.9	14.00
	-7.0	-7.6	58.3	16.13	54.9	15.63	51.6	15.32	50.0	14.80	48.2	14.23	44.9	13.61
	-5.0	-5.6	58.3	15.54	54.9	15.07	51.6	14.75	50.0	14.24	48.2	13.69	44.9	13.10
	-3.0	-3.7	58.3	14.95	54.9	14.50	51.6	14.18	50.0	13.67	48.2	13.16	44.9	12.58
	0.0	-0.7	58.3	14.07	54.9	13.65	51.6	13.32	50.0	12.83	48.2	12.36	44.9	11.81
	3.0	2.2	58.3	13.19	54.9	12.80	51.6	12.46	50.0	11.98	48.2	11.56	44.9	11.05
	5.0	4.1	57.1	11.39	53.8	11.05	50.5	10.74	49.0	10.30	47.2	9.95	44.0	9.50
	7.0	6.0	55.6	10.69	52.4	10.38	49.2	10.08	47.8	9.66	46.0	9.34	42.8	8.92
	9.0	7.9	53.6	9.60	50.5	9.32	47.4	9.09	46.0	8.74	44.4	8.43	41.3	8.03
	11.0	9.8	50.7	8.53	47.8	8.29	44.9	8.09	43.5	7.77	41.9	7.50	39.0	7.14
	13.0	11.8	47.6	7.42	44.9	7.21	42.1	7.03	40.9	6.76	39.4	6.52	36.7	6.21
15.0	13.7	45.0	6.70	42.5	6.51	39.9	6.35	38.7	6.10	37.3	5.88	34.7	5.60	

## 7. Capacity Tables

Heating Capacity (20HP)

Combination (%)	Outdoor air temp.		Indoor air temp. °C DB											
			16		18		20		21		22		24	
	°C DB	°C WB	TC	PI	TC	PI	TC	PI	TC	PI	TC	PI	TC	PI
70	-24.8	-25	38.5	18.26	38.5	18.31	38.3	18.40	38.3	18.53	38.3	17.66	37.5	16.84
	-21.8	-22	44.2	18.40	44.2	18.44	43.9	18.53	42.4	17.66	41.1	16.84	38.4	16.05
	-19.8	-20	48.0	18.49	46.7	18.53	43.9	17.92	42.4	17.08	41.1	16.30	38.4	15.52
	-18.8	-19	49.4	18.53	46.7	18.22	43.9	17.61	42.4	16.78	41.1	16.02	38.4	15.26
	-16.7	-17	49.4	17.88	46.7	17.55	43.9	16.97	42.4	16.17	41.1	15.45	38.4	14.70
	-13.7	-15	49.4	16.94	46.7	16.60	43.9	16.05	42.4	15.30	41.1	14.63	38.4	13.91
	-11.8	-13	49.4	16.34	46.7	16.00	43.9	15.47	42.4	14.74	41.1	14.11	38.4	13.41
	-9.8	-11	49.4	15.72	46.7	15.36	43.9	14.85	42.4	14.16	41.1	13.57	38.4	12.88
	-9.5	-10	49.4	15.62	46.7	15.27	43.9	14.76	42.4	14.07	41.1	13.49	38.4	12.80
	-8.5	-9.1	49.4	15.31	46.7	14.95	43.9	14.46	42.4	13.78	41.1	13.21	38.4	12.54
	-7.0	-7.6	49.4	14.84	46.7	14.48	43.9	14.00	42.4	13.35	41.1	12.80	38.4	12.14
	-5.0	-5.6	49.4	14.22	46.7	13.84	43.9	13.38	42.4	12.76	41.1	12.26	38.4	11.62
	-3.0	-3.7	49.4	13.59	46.7	13.21	43.9	12.77	42.4	12.18	41.1	11.71	38.4	11.09
	0.0	-0.7	49.4	12.65	46.7	12.26	43.9	11.85	42.4	11.31	41.1	10.89	38.4	10.30
	3.0	2.2	49.4	11.71	46.7	11.31	43.9	10.93	42.4	10.43	41.1	10.08	38.4	9.50
	5.0	4.1	49.4	10.25	45.7	9.65	43.0	9.32	41.5	8.89	40.3	8.61	37.6	8.11
	7.0	6.0	49.5	9.78	44.6	8.94	41.9	8.64	40.5	8.25	39.3	8.00	36.7	7.52
9.0	7.9	47.7	8.47	42.9	7.74	40.4	7.48	39.0	7.14	37.8	6.93	35.3	6.51	
11.0	9.8	45.1	7.52	40.6	6.87	38.2	6.64	36.9	6.34	35.8	6.15	33.4	5.78	
13.0	11.8	42.3	6.60	38.1	6.03	35.9	5.83	34.6	5.56	33.6	5.40	31.4	5.07	
15.0	13.7	40.0	5.88	36.1	5.38	33.9	5.20	32.8	4.96	31.8	4.81	29.7	4.53	
60	-24.8	-25	37.9	18.10	37.9	18.19	37.6	18.33	36.4	17.38	35.1	16.49	32.9	15.66
	-21.8	-22	40.6	18.24	40.1	18.33	37.6	17.38	36.4	16.49	35.1	15.66	32.9	14.85
	-19.8	-20	42.4	18.33	40.1	17.66	37.6	16.75	36.4	15.90	35.1	15.10	32.9	14.31
	-18.8	-19	42.4	17.99	40.1	17.33	37.6	16.44	36.4	15.61	35.1	14.82	32.9	14.04
	-16.7	-17	42.4	17.28	40.1	16.62	37.6	15.77	36.4	14.98	35.1	14.24	32.9	13.48
	-13.7	-15	42.4	16.27	40.1	15.62	37.6	14.82	36.4	14.10	35.1	13.40	32.9	12.67
	-11.8	-13	42.4	15.63	40.1	14.98	37.6	14.22	36.4	13.53	35.1	12.87	32.9	12.16
	-9.8	-11	42.4	14.95	40.1	14.31	37.6	13.59	36.4	12.94	35.1	12.32	32.9	11.62
	-9.5	-10	42.4	14.85	40.1	14.21	37.6	13.50	36.4	12.85	35.1	12.23	32.9	11.54
	-8.5	-9.1	42.4	14.51	40.1	13.88	37.6	13.18	36.4	12.56	35.1	11.96	32.9	11.27
	-7.0	-7.6	42.4	14.01	40.1	13.38	37.6	12.71	36.4	12.11	35.1	11.54	32.9	10.87
	-5.0	-5.6	42.4	13.33	40.1	12.71	37.6	12.08	36.4	11.52	35.1	10.98	32.9	10.33
	-3.0	-3.7	42.4	12.66	40.1	12.04	37.6	11.45	36.4	10.93	35.1	10.42	32.9	9.79
	0.0	-0.7	42.4	11.64	40.1	11.03	37.6	10.50	36.4	10.04	35.1	9.59	32.9	8.99
	3.0	2.2	42.4	10.63	40.1	10.03	37.6	9.55	36.4	9.15	35.1	8.75	32.9	8.18
	5.0	4.1	41.5	9.01	39.3	8.47	36.9	8.06	35.6	7.74	34.4	7.41	32.2	6.91
	7.0	6.0	40.5	8.26	38.3	7.74	35.9	7.38	34.7	7.09	33.5	6.80	31.4	6.32
9.0	7.9	39.0	7.08	36.9	6.63	34.6	6.32	33.5	6.07	32.3	5.83	30.2	5.42	
11.0	9.8	36.9	6.28	34.9	5.88	32.7	5.61	31.6	5.39	30.6	5.17	28.6	4.81	
13.0	11.8	34.6	5.51	32.8	5.16	30.7	4.92	29.7	4.73	28.7	4.53	26.8	4.22	
15.0	13.7	32.8	4.96	31.0	4.65	29.1	4.39	28.1	4.22	27.1	4.04	25.4	3.80	
50	-24.8	-25	35.4	15.62	33.4	15.75	31.4	14.93	30.4	14.16	29.3	13.43	27.3	12.75
	-21.8	-22	35.4	15.75	33.4	14.93	31.4	14.16	30.4	13.43	29.3	12.75	27.3	12.09
	-19.8	-20	35.4	15.18	33.4	14.38	31.4	13.64	30.4	12.94	29.3	12.29	27.3	11.65
	-18.8	-19	35.4	14.89	33.4	14.10	31.4	13.39	30.4	12.70	29.3	12.07	27.3	11.44
	-16.7	-17	35.4	14.29	33.4	13.53	31.4	12.85	30.4	12.18	29.3	11.59	27.3	10.98
	-13.7	-15	35.4	13.43	33.4	12.70	31.4	12.07	30.4	11.45	29.3	10.91	27.3	10.32
	-11.8	-13	35.4	12.88	33.4	12.18	31.4	11.59	30.4	10.99	29.3	10.48	27.3	9.91
	-9.8	-11	35.4	12.31	33.4	11.63	31.4	11.07	30.4	10.50	29.3	10.02	27.3	9.47
	-9.5	-10	35.4	12.22	33.4	11.55	31.4	10.99	30.4	10.43	29.3	9.96	27.3	9.40
	-8.5	-9.1	35.4	11.94	33.4	11.27	31.4	10.74	30.4	10.19	29.3	9.73	27.3	9.18
	-7.0	-7.6	35.4	11.50	33.4	10.86	31.4	10.35	30.4	9.82	29.3	9.39	27.3	8.86
	-5.0	-5.6	35.4	10.93	33.4	10.31	31.4	9.84	30.4	9.34	29.3	8.94	27.3	8.42
	-3.0	-3.7	35.4	10.36	33.4	9.76	31.4	9.32	30.4	8.85	29.3	8.48	27.3	7.98
	0.0	-0.7	35.4	9.50	33.4	8.93	31.4	8.55	30.4	8.12	29.3	7.80	27.3	7.33
	3.0	2.2	35.4	8.63	33.4	8.11	31.4	7.78	30.4	7.39	29.3	7.12	27.3	6.67
	5.0	4.1	34.7	7.29	32.7	6.84	30.7	6.57	29.7	6.24	28.8	6.03	26.8	5.64
	7.0	6.0	33.8	6.66	31.9	6.24	29.9	6.01	29.0	5.71	28.0	5.53	26.1	5.16
9.0	7.9	32.5	5.77	30.7	5.40	28.8	5.20	27.9	4.94	27.0	4.79	25.2	4.47	
11.0	9.8	30.9	5.18	29.2	4.85	27.4	4.67	26.4	4.44	25.5	4.30	23.8	4.01	
13.0	11.8	28.9	4.49	27.3	4.21	25.6	4.05	24.8	3.87	24.0	3.73	22.3	3.50	
15.0	13.7	27.3	4.06	25.8	3.80	24.2	3.66	23.5	3.48	22.7	3.37	21.1	3.14	

## Note

1. TC: Total Capacity(kW), PI : Power Input(kW, Comp. + Outdoor fan motor)
2. Capacity tables show the average value of conditions which may occur.
3. The heating capacity table is based on the values expressed as Max. in the specification of the outdoor unit. (When measuring the Max. heating capacity, the setting status of the indoor unit is the same as that for measuring the heating capacity of the indoor unit.)



# 7. Capacity Tables

## ◆ ARUM220LTE5

Heating Capacity (22HP)

Combination (%)	Outdoor air temp.		Indoor air temp. °C DB											
			16		18		20		21		22		24	
	°C DB	°C WB	TC	PI	TC	PI	TC	PI	TC	PI	TC	PI	TC	PI
130	-24.8	-25	43.4	24.18	43.4	24.26	43.2	24.33	43.2	24.44	43.2	24.54	42.3	24.70
	-21.8	-22	52.8	24.34	52.8	24.42	52.5	24.49	52.5	24.60	52.5	24.70	51.5	24.86
	-19.8	-20	55.7	24.45	55.7	24.53	55.3	24.60	55.3	24.70	55.3	24.81	54.3	24.97
	-18.8	-19	56.9	24.50	56.9	24.58	56.5	24.65	56.5	24.76	56.5	24.86	55.5	25.02
	-16.7	-17	59.4	24.61	59.4	24.69	59.0	24.76	59.0	24.87	59.0	24.97	57.9	25.13
	-13.7	-15	63.0	24.77	63.0	24.85	62.6	24.92	62.6	25.03	62.6	25.13	61.4	24.22
	-11.8	-13	65.1	24.88	65.1	24.96	64.7	25.03	64.7	25.13	64.7	24.52	63.7	23.64
	-9.8	-11	67.3	24.98	67.3	25.06	66.8	25.13	66.8	24.49	66.8	23.88	66.0	23.03
	-9.5	-10	67.7	25.00	67.7	25.08	67.2	25.03	67.2	24.39	67.2	23.78	66.4	22.94
	-8.5	-9.1	69.0	25.05	69.0	25.13	68.5	24.71	68.5	24.06	68.3	23.46	67.5	22.64
	-7.0	-7.6	70.9	25.13	70.9	24.66	70.5	24.21	70.5	23.58	70.5	22.98	69.3	22.18
	-5.0	-5.6	73.5	24.52	73.5	24.02	73.0	23.56	73.0	22.93	73.0	22.33	71.7	21.57
	-3.0	-3.7	76.1	23.92	76.1	23.38	75.6	22.90	75.6	22.28	75.6	21.69	74.0	20.96
	0.0	-0.7	80.0	23.00	80.0	22.43	79.5	21.91	79.5	21.31	79.5	20.72	77.5	20.05
	3.0	2.2	83.9	22.09	83.9	21.47	83.4	20.92	83.4	20.34	83.4	19.76	78.2	19.14
	5.0	4.1	84.9	19.51	84.8	18.90	84.2	18.37	84.2	17.82	84.2	17.28	76.7	16.72
	7.0	6.0	85.3	18.57	85.1	17.97	84.6	17.45	83.2	16.94	80.3	16.44	74.7	15.95
9.0	7.9	82.6	17.34	82.4	16.78	82.1	16.29	80.1	15.82	77.3	15.35	72.0	14.88	
11.0	9.8	78.1	16.31	77.9	15.78	77.7	15.33	75.8	14.88	73.1	14.44	68.1	14.00	
13.0	11.8	73.3	15.06	73.2	14.57	73.0	14.15	71.1	13.74	68.7	13.33	63.9	12.93	
15.0	13.7	69.4	14.02	69.2	13.57	69.0	13.17	67.3	12.79	65.0	12.41	60.5	12.04	
120	-24.8	-25	43.1	24.26	43.1	24.33	42.9	24.44	42.9	24.54	42.9	24.70	42.0	24.81
	-21.8	-22	52.4	24.42	52.4	24.49	52.1	24.60	52.1	24.70	52.1	24.86	51.1	24.97
	-19.8	-20	55.3	24.53	55.3	24.60	54.9	24.70	54.9	24.81	54.9	24.97	53.9	25.08
	-18.8	-19	56.5	24.58	56.5	24.65	56.1	24.76	56.1	24.86	56.1	25.02	55.1	25.13
	-16.7	-17	59.0	24.69	59.0	24.76	58.6	24.87	58.6	24.97	58.6	25.13	57.5	24.55
	-13.7	-15	62.6	24.85	62.6	24.92	62.2	25.03	62.2	25.13	62.2	24.26	61.0	23.71
	-11.8	-13	64.6	24.96	64.6	25.03	64.2	25.13	64.2	24.52	64.2	23.71	63.2	23.17
	-9.8	-11	66.8	25.06	66.8	25.13	66.4	24.46	66.4	23.87	66.4	23.13	65.6	22.61
	-9.5	-10	67.2	25.08	67.2	25.03	66.8	24.36	66.8	23.77	66.8	23.04	65.9	22.53
	-8.5	-9.1	68.5	25.13	68.5	24.67	68.0	24.02	68.0	23.45	68.0	22.75	67.1	22.25
	-7.0	-7.6	70.4	24.61	70.4	24.14	70.0	23.51	70.0	22.96	70.0	22.31	68.8	21.83
	-5.0	-5.6	73.0	23.90	73.0	23.42	72.5	22.83	72.5	22.31	72.5	21.73	71.1	21.27
	-3.0	-3.7	75.6	23.20	75.6	22.71	75.1	22.16	75.1	21.66	75.1	21.15	73.5	20.71
	0.0	-0.7	79.4	22.14	79.4	21.64	78.9	21.14	78.9	20.69	78.9	20.27	73.5	19.87
	3.0	2.2	83.3	21.09	83.3	20.57	82.8	20.12	81.6	19.71	79.1	19.40	73.5	19.03
	5.0	4.1	84.4	18.50	84.2	18.01	82.8	17.60	80.0	17.23	77.5	16.98	72.0	16.65
	7.0	6.0	84.7	17.52	84.0	17.04	80.7	16.71	78.0	16.39	75.5	16.23	70.2	15.94
9.0	7.9	82.0	16.30	80.9	15.86	77.7	15.55	75.1	15.25	72.8	15.11	67.6	14.84	
11.0	9.8	77.5	15.29	76.5	14.87	73.5	14.58	71.0	14.30	68.8	14.16	63.9	13.91	
13.0	11.8	72.8	14.06	71.8	13.68	69.0	13.41	66.7	13.15	64.6	13.03	60.0	12.80	
15.0	13.7	68.9	13.03	68.0	12.68	65.3	12.43	63.1	12.19	61.1	12.08	56.8	11.86	
110	-24.8	-25	42.9	24.33	42.9	24.44	42.6	24.54	42.6	24.70	42.6	24.81	41.8	24.87
	-21.8	-22	52.1	24.49	52.1	24.60	51.8	24.70	51.8	24.86	51.8	24.97	50.8	25.03
	-19.8	-20	55.0	24.60	55.0	24.70	54.7	24.81	54.7	24.97	54.7	25.08	53.6	25.13
	-18.8	-19	56.2	24.65	56.2	24.76	55.8	24.86	55.8	25.02	55.8	25.13	54.8	24.82
	-16.7	-17	58.7	24.76	58.7	24.87	58.3	24.97	58.3	25.13	58.3	24.49	57.2	24.16
	-13.7	-15	62.2	24.92	62.2	25.03	61.9	25.13	61.9	24.17	61.9	23.58	61.9	23.22
	-11.8	-13	64.3	25.03	64.3	25.13	63.9	24.45	63.9	23.56	63.9	23.00	63.9	22.63
	-9.8	-11	66.4	25.13	66.4	24.37	66.0	23.74	66.0	22.91	66.0	22.39	65.5	22.00
	-9.5	-10	66.8	25.01	66.8	24.25	66.4	23.63	66.4	22.81	66.4	22.30	66.1	21.91
	-8.5	-9.1	68.1	24.60	68.1	23.87	67.7	23.27	67.7	22.49	67.7	22.00	66.1	21.60
	-7.0	-7.6	70.0	23.98	70.0	23.29	69.6	22.73	69.6	22.01	69.6	21.54	66.1	21.13
	-5.0	-5.6	72.6	23.15	72.6	22.52	72.1	22.02	72.1	21.37	70.8	20.93	66.1	20.50
	-3.0	-3.7	75.2	22.32	75.2	21.76	74.7	21.30	73.3	20.72	70.8	20.32	66.1	19.87
	0.0	-0.7	79.0	21.08	79.0	20.60	75.8	20.22	73.3	19.75	70.8	19.41	66.1	18.93
	3.0	2.2	82.9	19.84	80.7	19.45	75.8	19.15	73.3	18.79	70.8	18.49	66.1	17.99
	5.0	4.1	83.7	17.25	79.1	16.92	74.3	16.67	71.8	16.38	69.4	16.13	64.8	15.66
	7.0	6.0	81.6	16.19	77.1	15.95	72.4	15.77	70.0	15.57	67.6	15.38	63.2	14.90
9.0	7.9	78.6	14.99	74.3	14.76	69.7	14.60	67.4	14.42	65.2	14.23	60.8	13.79	
11.0	9.8	74.3	13.97	70.2	13.76	65.9	13.61	63.8	13.44	61.6	13.27	57.5	12.86	
13.0	11.8	69.8	12.76	66.0	12.57	61.9	12.43	59.9	12.28	57.9	12.12	54.0	11.75	
15.0	13.7	66.0	11.74	62.4	11.56	58.6	11.43	56.7	11.29	54.7	11.15	51.1	10.80	

# 7. Capacity Tables

Heating Capacity (22HP)

Combination (%)	Outdoor air temp.		Indoor air temp. °C DB											
			16		18		20		21		22		24	
	°C DB	°C WB	TC	PI	TC	PI	TC	PI	TC	PI	TC	PI	TC	PI
100	-24.8	-25	42.7	26.62	42.7	26.42	42.4	24.35	42.4	25.94	42.4	25.73	41.6	25.63
	-21.8	-22	51.9	26.33	51.9	26.13	51.6	25.12	51.6	25.64	51.6	25.75	50.6	25.33
	-19.8	-20	54.8	26.13	54.8	25.93	54.4	25.59	54.4	25.44	54.4	25.34	53.4	25.13
	-18.8	-19	55.9	26.03	55.6	25.83	55.6	25.64	55.6	25.34	55.6	25.13	54.5	24.75
	-16.7	-17	58.1	25.82	58.1	25.62	58.1	25.75	57.7	25.13	57.7	24.34	56.6	23.93
	-13.7	-15	61.9	25.52	61.9	25.32	61.6	25.13	61.6	23.98	61.6	23.20	60.4	22.77
	-11.8	-13	63.9	25.33	63.6	25.13	63.6	24.37	63.6	23.25	63.6	22.48	60.4	22.04
	-9.8	-11	66.1	25.13	66.1	24.27	65.7	23.56	65.7	22.48	64.9	21.72	60.4	21.26
	-9.5	-10	66.4	25.00	66.4	24.15	66.1	23.43	66.1	22.37	64.9	21.60	60.4	21.14
	-8.5	-9.1	67.7	24.55	67.7	23.72	67.4	23.03	67.1	21.99	64.9	21.22	60.4	20.76
	-7.0	-7.6	70.8	23.88	70.5	23.07	69.3	22.42	67.1	21.41	64.9	20.65	60.4	20.18
	-5.0	-5.6	73.9	22.98	73.2	22.21	69.3	21.61	67.1	20.64	64.9	19.90	60.4	19.40
	-3.0	-3.7	76.0	22.09	73.7	21.35	69.3	20.81	67.1	19.87	64.9	19.14	60.4	18.63
	0.0	-0.7	78.2	20.74	73.7	20.06	69.3	19.59	67.1	18.72	64.9	18.00	60.4	17.47
	3.0	2.2	78.2	19.40	73.7	18.78	69.3	18.38	67.1	17.57	64.9	16.86	60.4	16.30
	5.0	4.1	76.6	16.80	72.3	16.24	67.9	15.90	65.7	15.19	63.6	14.54	59.2	14.03
	7.0	6.0	74.7	15.67	70.4	15.18	66.2	14.92	64.1	14.27	61.9	13.65	57.7	13.13
	9.0	7.9	71.9	14.44	67.8	13.99	63.8	13.74	61.7	13.15	59.7	12.58	55.6	12.10
	11.0	9.8	68.0	13.39	64.1	12.97	60.3	12.74	58.4	12.19	56.4	11.66	52.6	11.22
	13.0	11.8	63.9	12.15	60.2	11.77	56.6	11.57	54.8	11.07	53.0	10.59	49.4	10.18
15.0	13.7	60.4	11.10	57.0	10.75	53.6	10.56	51.9	10.10	50.1	9.67	46.7	9.30	
90	-24.8	-25	42.5	23.82	42.5	23.98	42.3	24.09	42.3	24.15	42.3	24.25	41.5	24.42
	-21.8	-22	51.7	23.98	51.7	24.14	51.4	24.25	51.4	24.31	51.4	24.42	50.4	23.38
	-19.8	-20	54.5	24.09	54.5	24.25	54.2	24.36	54.2	24.42	54.2	23.71	53.2	22.69
	-18.8	-19	55.9	24.14	55.6	24.30	55.4	24.42	55.4	24.05	55.4	23.35	54.3	22.34
	-16.7	-17	58.1	24.25	58.1	24.42	57.8	23.66	57.8	23.29	57.8	22.61	55.2	21.61
	-13.7	-15	61.9	24.42	61.9	23.30	61.3	22.59	61.3	22.20	59.5	21.55	55.2	20.58
	-11.8	-13	63.9	23.65	63.6	22.59	63.4	21.91	61.4	21.50	59.5	20.88	55.2	19.92
	-9.8	-11	66.1	22.85	66.1	21.85	63.4	21.19	61.4	20.78	59.5	20.17	55.2	19.23
	-9.5	-10	66.4	22.73	66.4	21.74	63.4	21.09	61.4	20.67	59.5	20.06	55.2	19.12
	-8.5	-9.1	67.7	22.32	67.3	21.36	63.4	20.73	61.4	20.30	59.5	19.71	55.2	18.78
	-7.0	-7.6	70.8	21.72	67.4	20.81	63.4	20.19	61.4	19.76	59.5	19.18	55.2	18.26
	-5.0	-5.6	71.6	20.92	67.4	20.06	63.4	19.47	61.4	19.03	59.5	18.47	55.2	17.57
	-3.0	-3.7	71.6	20.11	67.4	19.32	63.4	18.76	61.4	18.30	59.5	17.76	55.2	16.87
	0.0	-0.7	71.6	18.91	67.4	18.20	63.4	17.68	61.4	17.21	59.5	16.70	55.2	15.84
	3.0	2.2	71.6	17.70	67.4	17.09	63.4	16.61	61.4	16.12	59.5	15.64	55.2	14.80
	5.0	4.1	70.1	15.30	66.0	14.77	62.1	14.35	60.2	13.90	58.3	13.48	54.1	12.72
	7.0	6.0	68.4	14.32	64.3	13.88	60.6	13.51	58.7	13.05	56.8	12.66	52.7	11.94
	9.0	7.9	65.9	13.20	62.0	12.79	58.3	12.45	56.5	12.02	54.7	11.66	50.8	11.00
	11.0	9.8	62.3	12.11	58.6	11.74	55.2	11.42	53.4	11.03	51.7	10.71	48.1	10.10
	13.0	11.8	58.5	10.77	55.0	10.44	51.8	10.16	50.2	9.81	48.6	9.52	45.1	8.98
15.0	13.7	55.3	9.74	52.1	9.44	49.0	9.18	47.5	8.87	46.0	8.61	42.7	8.12	
80	-24.8	-25	42.4	21.05	42.4	21.22	42.1	21.33	42.1	21.38	42.1	21.65	41.3	20.74
	-21.8	-22	51.2	21.22	51.2	21.38	51.2	21.49	51.2	21.65	51.2	20.74	49.3	19.86
	-19.8	-20	54.0	21.32	54.0	21.48	54.0	21.65	54.0	21.01	53.0	20.13	49.3	19.27
	-18.8	-19	55.1	21.38	55.1	21.65	55.1	21.32	55.0	20.68	53.0	19.82	49.3	18.98
	-16.7	-17	56.7	21.65	56.7	20.97	56.7	20.64	55.0	20.01	53.0	19.18	49.3	18.37
	-13.7	-15	59.3	20.64	58.1	20.00	56.7	19.66	55.0	19.04	53.0	18.27	49.3	17.49
	-11.8	-13	60.8	20.01	59.0	19.39	56.7	19.04	55.0	18.43	53.0	17.69	49.3	16.93
	-9.8	-11	62.5	19.34	59.9	18.74	56.7	18.39	55.0	17.79	53.0	17.08	49.3	16.35
	-9.5	-10	62.9	19.24	60.2	18.64	56.7	18.29	55.0	17.69	53.0	16.99	49.3	16.26
	-8.5	-9.1	63.5	18.90	60.4	18.32	56.7	17.97	55.0	17.37	53.0	16.69	49.3	15.97
	-7.0	-7.6	64.1	18.40	60.4	17.83	56.7	17.48	55.0	16.89	53.0	16.23	49.3	15.53
	-5.0	-5.6	64.1	17.73	60.4	17.19	56.7	16.83	55.0	16.24	53.0	15.62	49.3	14.94
	-3.0	-3.7	64.1	17.06	60.4	16.54	56.7	16.17	55.0	15.60	53.0	15.02	49.3	14.36
	0.0	-0.7	64.1	16.05	60.4	15.57	56.7	15.20	55.0	14.63	53.0	14.10	49.3	13.48
	3.0	2.2	64.1	15.05	60.4	14.60	56.7	14.22	55.0	13.67	53.0	13.19	49.3	12.60
	5.0	4.1	62.8	13.00	59.2	12.60	55.6	12.25	53.9	11.76	52.0	11.35	48.4	10.84
	7.0	6.0	61.2	12.20	57.7	11.84	54.2	11.50	52.5	11.02	50.6	10.65	47.1	10.17
	9.0	7.9	59.0	10.95	55.6	10.64	52.2	10.38	50.6	9.97	48.8	9.62	45.4	9.16
	11.0	9.8	55.8	9.74	52.6	9.46	49.3	9.23	47.9	8.87	46.1	8.55	42.9	8.15
	13.0	11.8	52.4	8.46	49.4	8.22	46.3	8.02	45.0	7.71	43.3	7.43	40.3	7.08
15.0	13.7	49.5	7.64	46.7	7.43	43.8	7.24	42.5	6.96	41.0	6.71	38.1	6.39	

# 7. Capacity Tables

Heating Capacity (22HP)

Combination (%)	Outdoor air temp.		Indoor air temp. °C DB											
			16		18		20		21		22		24	
	°C DB	°C WB	TC	PI	TC	PI	TC	PI	TC	PI	TC	PI	TC	PI
70	-24.8	-25	42.4	20.82	42.4	20.87	42.1	20.98	42.1	21.14	42.1	20.15	41.3	19.21
	-21.8	-22	48.6	20.98	48.6	21.04	48.3	21.14	46.6	20.15	45.3	19.21	42.2	18.31
	-19.8	-20	52.7	21.09	51.3	21.14	48.3	20.44	46.6	19.48	45.3	18.59	42.2	17.71
	-18.8	-19	54.4	21.14	51.3	20.78	48.3	20.09	46.6	19.15	45.3	18.28	42.2	17.41
	-16.7	-17	54.4	20.39	51.3	20.02	48.3	19.36	46.6	18.45	45.3	17.63	42.2	16.77
	-13.7	-15	54.4	19.32	51.3	18.94	48.3	18.31	46.6	17.45	45.3	16.69	42.2	15.87
	-11.8	-13	54.4	18.64	51.3	18.25	48.3	17.65	46.6	16.82	45.3	16.10	42.2	15.30
	-9.8	-11	54.4	17.93	51.3	17.53	48.3	16.95	46.6	16.16	45.3	15.48	42.2	14.70
	-9.5	-10	54.4	17.82	51.3	17.42	48.3	16.84	46.6	16.06	45.3	15.39	42.2	14.61
	-8.5	-9.1	54.4	17.47	51.3	17.06	48.3	16.49	46.6	15.72	45.3	15.07	42.2	14.31
	-7.0	-7.6	54.4	16.93	51.3	16.52	48.3	15.97	46.6	15.23	45.3	14.61	42.2	13.85
	-5.0	-5.6	54.4	16.22	51.3	15.79	48.3	15.27	46.6	14.56	45.3	13.99	42.2	13.25
	-3.0	-3.7	54.4	15.50	51.3	15.07	48.3	14.57	46.6	13.90	45.3	13.36	42.2	12.65
	0.0	-0.7	54.4	14.43	51.3	13.99	48.3	13.52	46.6	12.90	45.3	12.43	42.2	11.75
	3.0	2.2	54.4	13.36	51.3	12.90	48.3	12.47	46.6	11.90	45.3	11.50	42.2	10.84
	5.0	4.1	54.4	11.69	50.3	11.01	47.3	10.64	45.7	10.15	44.3	9.82	41.4	9.25
	7.0	6.0	54.4	11.15	49.0	10.20	46.1	9.85	44.5	9.41	43.2	9.12	40.3	8.58
	9.0	7.9	52.4	9.66	47.2	8.83	44.4	8.53	42.9	8.15	41.6	7.90	38.8	7.43
	11.0	9.8	49.6	8.57	44.6	7.84	42.0	7.58	40.6	7.23	39.4	7.01	36.7	6.59
	13.0	11.8	46.6	7.52	41.9	6.88	39.4	6.65	38.1	6.35	37.0	6.16	34.5	5.79
15.0	13.7	44.1	6.71	39.7	6.14	37.3	5.93	36.0	5.66	35.0	5.49	32.6	5.16	
60	-24.8	-25	41.6	20.64	41.6	20.75	41.4	20.91	40.0	19.83	38.6	18.82	36.1	17.86
	-21.8	-22	44.6	20.80	44.1	20.91	41.4	19.83	40.0	18.82	38.6	17.86	36.1	16.94
	-19.8	-20	46.6	20.91	44.1	20.15	41.4	19.11	40.0	18.14	38.6	17.23	36.1	16.33
	-18.8	-19	46.6	20.53	44.1	19.77	41.4	18.75	40.0	17.80	38.6	16.91	36.1	16.02
	-16.7	-17	46.6	19.72	44.1	18.96	41.4	17.99	40.0	17.09	38.6	16.24	36.1	15.38
	-13.7	-15	46.6	18.56	44.1	17.82	41.4	16.91	40.0	16.08	38.6	15.29	36.1	14.46
	-11.8	-13	46.6	17.83	44.1	17.09	41.4	16.23	40.0	15.44	38.6	14.69	36.1	13.87
	-9.8	-11	46.6	17.06	44.1	16.33	41.4	15.51	40.0	14.76	38.6	14.05	36.1	13.26
	-9.5	-10	46.6	16.94	44.1	16.22	41.4	15.40	40.0	14.66	38.6	13.96	36.1	13.17
	-8.5	-9.1	46.6	16.56	44.1	15.83	41.4	15.04	40.0	14.32	38.6	13.64	36.1	12.86
	-7.0	-7.6	46.6	15.98	44.1	15.26	41.4	14.50	40.0	13.82	38.6	13.16	36.1	12.40
	-5.0	-5.6	46.6	15.21	44.1	14.50	41.4	13.78	40.0	13.14	38.6	12.53	36.1	11.79
	-3.0	-3.7	46.6	14.44	44.1	13.73	41.4	13.06	40.0	12.47	38.6	11.89	36.1	11.17
	0.0	-0.7	46.6	13.28	44.1	12.59	41.4	11.98	40.0	11.45	38.6	10.94	36.1	10.25
	3.0	2.2	46.6	12.13	44.1	11.44	41.4	10.90	40.0	10.44	38.6	9.99	36.1	9.33
	5.0	4.1	45.7	10.28	43.3	9.67	40.6	9.20	39.2	8.83	37.9	8.45	35.4	7.88
	7.0	6.0	44.5	9.42	42.2	8.83	39.5	8.41	38.2	8.09	36.9	7.76	34.5	7.21
	9.0	7.9	42.9	8.07	40.6	7.56	38.1	7.21	36.8	6.93	35.5	6.65	33.3	6.18
	11.0	9.8	40.6	7.16	38.4	6.71	36.0	6.40	34.8	6.15	33.6	5.90	31.4	5.48
	13.0	11.8	38.1	6.28	36.1	5.89	33.8	5.61	32.7	5.39	31.6	5.17	29.5	4.81
15.0	13.7	36.0	5.66	34.1	5.30	32.0	5.01	30.9	4.81	29.9	4.61	27.9	4.33	
50	-24.8	-25	38.9	17.81	36.7	17.97	34.5	17.03	33.4	16.15	32.3	15.32	30.1	14.54
	-21.8	-22	38.9	17.97	36.7	17.03	34.5	16.15	33.4	15.32	32.3	14.54	30.1	13.79
	-19.8	-20	38.9	17.32	36.7	16.40	34.5	15.56	33.4	14.76	32.3	14.02	30.1	13.30
	-18.8	-19	38.9	16.99	36.7	16.09	34.5	15.27	33.4	14.48	32.3	13.77	30.1	13.05
	-16.7	-17	38.9	16.30	36.7	15.43	34.5	14.66	33.4	13.90	32.3	13.22	30.1	12.52
	-13.7	-15	38.9	15.32	36.7	14.49	34.5	13.77	33.4	13.07	32.3	12.45	30.1	11.77
	-11.8	-13	38.9	14.70	36.7	13.89	34.5	13.22	33.4	12.54	32.3	11.95	30.1	11.30
	-9.8	-11	38.9	14.04	36.7	13.27	34.5	12.63	33.4	11.98	32.3	11.44	30.1	10.80
	-9.5	-10	38.9	13.94	36.7	13.17	34.5	12.54	33.4	11.90	32.3	11.36	30.1	10.73
	-8.5	-9.1	38.9	13.62	36.7	12.86	34.5	12.25	33.4	11.62	32.3	11.10	30.1	10.48
	-7.0	-7.6	38.9	13.13	36.7	12.39	34.5	11.81	33.4	11.21	32.3	10.71	30.1	10.10
	-5.0	-5.6	38.9	12.47	36.7	11.76	34.5	11.22	33.4	10.65	32.3	10.20	30.1	9.61
	-3.0	-3.7	38.9	11.82	36.7	11.13	34.5	10.64	33.4	10.10	32.3	9.68	30.1	9.11
	0.0	-0.7	38.9	10.83	36.7	10.19	34.5	9.76	33.4	9.26	32.3	8.90	30.1	8.36
	3.0	2.2	38.9	9.85	36.7	9.25	34.5	8.88	33.4	8.43	32.3	8.13	30.1	7.61
	5.0	4.1	38.1	8.32	36.0	7.80	33.8	7.50	32.7	7.12	31.6	6.88	29.5	6.43
	7.0	6.0	37.2	7.60	35.0	7.12	32.9	6.86	31.9	6.51	30.8	6.31	28.7	5.89
	9.0	7.9	35.8	6.58	33.8	6.16	31.7	5.94	30.7	5.64	29.7	5.47	27.7	5.10
	11.0	9.8	34.0	5.91	32.1	5.53	30.2	5.33	29.0	5.06	28.1	4.91	26.2	4.58
	13.0	11.8	31.8	5.13	30.0	4.80	28.2	4.62	27.3	4.42	26.4	4.26	24.6	3.99
15.0	13.7	30.1	4.63	28.4	4.33	26.7	4.17	25.8	3.97	25.0	3.84	23.2	3.59	

**Note**

1. TC: Total Capacity(kW), PI : Power Input(kW, Comp. + Outdoor fan motor)
2. Capacity tables show the average value of conditions which may occur.
3. The heating capacity table is based on the values expressed as Max. in the specification of the outdoor unit. (When measuring the Max. heating capacity, the setting status of the indoor unit is the same as that for measuring the heating capacity of the indoor unit.)

# 7. Capacity Tables

## ◆ ARUM240LTE5

Heating Capacity (24HP)

Combination (%)	Outdoor air temp.		Indoor air temp. °C DB											
			16		18		20		21		22		24	
	°C DB	°C WB	TC	PI	TC	PI	TC	PI	TC	PI	TC	PI	TC	PI
130	-24.8	-25	45.4	25.72	45.4	25.93	45.1	26.11	45.1	26.38	45.1	26.65	44.3	27.07
	-21.8	-22	56.0	26.13	56.0	26.34	55.6	26.52	55.6	26.80	55.6	27.07	54.5	27.48
	-19.8	-20	59.4	26.41	59.4	26.62	59.0	26.80	59.0	27.08	59.0	27.34	57.9	27.76
	-18.8	-19	60.8	26.55	60.8	26.76	60.4	26.94	60.4	27.22	60.4	27.48	59.2	27.90
	-16.7	-17	63.6	26.84	63.6	27.05	63.2	27.23	63.2	27.51	63.2	27.78	62.0	28.19
	-13.7	-15	67.6	27.26	67.6	27.47	67.2	27.65	67.2	27.93	67.2	28.19	65.9	27.17
	-11.8	-13	69.8	27.53	69.8	27.73	69.4	27.91	69.4	28.19	69.4	27.51	68.4	26.52
	-9.8	-11	72.1	27.80	72.1	28.01	71.7	28.19	71.7	27.47	71.7	26.79	71.0	25.84
	-9.5	-10	72.5	27.85	72.5	28.05	72.1	28.08	72.1	27.36	72.0	26.68	71.4	25.73
	-8.5	-9.1	73.9	27.98	73.9	28.19	73.5	27.71	73.5	26.99	73.2	26.32	72.7	25.39
	-7.0	-7.6	76.0	28.19	76.0	27.66	75.5	27.16	75.5	26.45	75.5	25.77	74.6	24.88
	-5.0	-5.6	78.8	27.51	78.8	26.94	78.3	26.42	78.3	25.72	78.3	25.05	77.2	24.20
	-3.0	-3.7	81.6	26.83	81.6	26.23	81.1	25.68	81.1	24.99	81.1	24.33	79.8	23.51
	0.0	-0.7	85.8	25.80	85.8	25.16	85.2	24.58	85.2	23.90	85.2	23.25	83.8	22.49
	3.0	2.2	90.0	24.78	90.0	24.08	89.4	23.47	89.4	22.81	89.4	22.16	83.9	21.47
	5.0	4.1	91.1	21.89	90.9	21.20	90.3	20.60	90.3	19.98	88.3	19.38	82.2	18.76
	7.0	6.0	91.4	20.83	91.2	20.16	90.7	19.58	89.2	19.01	86.0	18.44	80.1	17.89
9.0	7.9	88.5	19.45	88.3	18.82	88.1	18.27	85.9	17.74	82.9	17.21	77.2	16.70	
11.0	9.8	83.7	18.30	83.5	17.71	83.3	17.19	81.2	16.69	78.4	16.20	73.0	15.71	
13.0	11.8	78.6	16.89	78.5	16.35	78.2	15.87	76.3	15.41	73.6	14.95	68.5	14.50	
15.0	13.7	74.4	15.73	74.2	15.22	74.0	14.78	72.2	14.35	69.7	13.92	64.8	13.50	
120	-24.8	-25	45.1	25.93	45.1	26.11	44.8	26.38	44.8	26.65	44.8	27.07	44.0	27.36
	-21.8	-22	55.6	26.34	55.6	26.52	55.2	26.80	55.2	27.07	55.2	27.48	54.2	27.78
	-19.8	-20	59.0	26.62	59.0	26.80	58.6	27.08	58.6	27.34	58.6	27.76	57.5	28.05
	-18.8	-19	60.3	26.76	60.3	26.94	59.9	27.22	59.9	27.48	59.9	27.90	58.8	28.19
	-16.7	-17	63.1	27.05	63.1	27.23	62.7	27.51	62.7	27.78	62.7	28.19	61.5	27.53
	-13.7	-15	67.1	27.47	67.1	27.65	66.7	27.93	66.7	28.19	66.7	27.21	65.4	26.59
	-11.8	-13	69.3	27.73	69.3	27.91	68.9	28.19	68.9	27.50	68.9	26.59	67.9	26.00
	-9.8	-11	71.6	28.01	71.6	28.19	71.2	27.43	71.2	26.77	71.2	25.94	70.5	25.37
	-9.5	-10	72.0	28.05	72.0	28.07	71.6	27.32	71.6	26.66	71.6	25.84	70.9	25.27
	-8.5	-9.1	73.4	28.19	73.4	27.67	72.9	26.94	72.9	26.30	72.9	25.52	72.1	24.96
	-7.0	-7.6	75.5	27.60	75.5	27.07	75.0	26.37	75.0	25.75	75.0	25.03	74.1	24.49
	-5.0	-5.6	78.3	26.81	78.3	26.27	77.8	25.61	77.8	25.02	77.8	24.37	76.7	23.86
	-3.0	-3.7	81.0	26.02	81.0	25.48	80.5	24.85	80.5	24.30	80.5	23.72	78.8	23.23
	0.0	-0.7	85.2	24.84	85.2	24.28	84.6	23.71	84.6	23.20	84.6	22.74	78.8	22.29
	3.0	2.2	89.3	23.66	89.3	23.08	88.8	22.57	87.5	22.11	84.8	21.76	78.8	21.35
	5.0	4.1	90.5	20.75	90.2	20.20	88.7	19.75	85.8	19.33	83.1	19.05	77.2	18.68
	7.0	6.0	90.9	19.65	90.0	19.12	86.5	18.74	83.6	18.38	81.0	18.21	75.2	17.88
9.0	7.9	87.9	18.29	86.7	17.79	83.3	17.44	80.5	17.11	78.0	16.94	72.5	16.64	
11.0	9.8	83.1	17.15	82.0	16.68	78.8	16.35	76.1	16.04	73.8	15.89	68.5	15.61	
13.0	11.8	78.1	15.77	77.0	15.34	74.0	15.04	71.5	14.75	69.3	14.61	64.4	14.35	
15.0	13.7	73.9	14.62	72.9	14.22	70.0	13.94	67.7	13.68	65.6	13.55	60.9	13.31	
110	-24.8	-25	44.9	26.11	44.9	26.38	44.6	26.65	44.6	27.07	44.6	27.36	43.7	27.50
	-21.8	-22	55.3	26.52	55.3	26.80	54.9	27.07	54.9	27.48	54.9	27.78	53.9	27.91
	-19.8	-20	58.7	26.80	58.7	27.08	58.3	27.34	58.3	27.76	58.3	28.05	57.2	28.19
	-18.8	-19	60.0	26.94	60.0	27.22	59.6	27.48	59.6	27.90	59.6	28.19	58.5	27.84
	-16.7	-17	62.8	27.23	62.8	27.51	62.4	27.78	62.4	28.19	62.4	27.48	61.2	27.10
	-13.7	-15	66.7	27.65	66.7	27.93	66.3	28.19	66.3	27.11	66.3	26.45	66.3	26.05
	-11.8	-13	68.9	27.91	68.9	28.19	68.5	27.43	68.5	26.42	68.5	25.80	68.5	25.38
	-9.8	-11	71.2	28.19	71.2	27.33	70.8	26.63	70.8	25.70	70.8	25.12	70.5	24.68
	-9.5	-10	71.6	28.05	71.6	27.20	71.2	26.50	71.2	25.59	71.2	25.02	70.9	24.58
	-8.5	-9.1	73.0	27.59	73.0	26.77	72.6	26.10	72.6	25.23	72.6	24.67	70.9	24.22
	-7.0	-7.6	75.1	26.89	75.1	26.13	74.6	25.50	74.6	24.69	74.6	24.16	70.9	23.70
	-5.0	-5.6	77.8	25.97	77.8	25.26	77.3	24.70	77.3	23.97	75.9	23.48	70.9	22.99
	-3.0	-3.7	80.6	25.04	80.6	24.40	80.1	23.89	78.6	23.24	75.9	22.79	70.9	22.29
	0.0	-0.7	84.7	23.65	84.7	23.11	81.2	22.69	78.6	22.16	75.9	21.77	70.9	21.24
	3.0	2.2	88.8	22.26	86.6	21.82	81.2	21.48	78.6	21.08	75.9	20.74	70.9	20.18
	5.0	4.1	89.8	19.35	84.8	18.98	79.6	18.70	77.0	18.38	74.4	18.10	69.5	17.57
	7.0	6.0	87.5	18.16	82.7	17.89	77.6	17.69	75.1	17.47	72.5	17.25	67.7	16.71
9.0	7.9	84.3	16.81	79.6	16.56	74.7	16.37	72.3	16.17	69.9	15.97	65.2	15.47	
11.0	9.8	79.7	15.67	75.3	15.43	70.7	15.26	68.4	15.08	66.1	14.88	61.7	14.42	
13.0	11.8	74.8	14.32	70.7	14.10	66.4	13.94	64.2	13.77	62.0	13.60	57.9	13.18	
15.0	13.7	70.8	13.17	66.9	12.97	62.8	12.82	60.7	12.67	58.7	12.51	54.8	12.12	

# 7. Capacity Tables

Heating Capacity (24HP)

Combination (%)	Outdoor air temp.		Indoor air temp. °C DB											
			16		18		20		21		22		24	
	°C DB	°C WB	TC	PI	TC	PI	TC	PI	TC	PI	TC	PI	TC	PI
100	-24.8	-25	44.7	28.98	44.7	28.88	44.4	26.94	44.4	28.62	44.4	28.51	43.5	28.46
	-21.8	-22	55.0	28.82	55.0	28.72	54.7	27.79	54.7	28.46	54.7	28.75	53.6	28.30
	-19.8	-20	58.4	28.72	58.4	28.61	58.1	28.32	58.1	28.36	58.1	28.38	57.0	28.19
	-18.8	-19	59.7	28.67	59.4	28.56	59.4	28.46	59.4	28.30	59.4	28.19	58.2	27.76
	-16.7	-17	62.1	28.56	62.1	28.45	62.1	28.75	61.8	28.19	61.8	27.30	60.6	26.85
	-13.7	-15	66.4	28.40	66.4	28.29	66.0	28.19	66.0	26.90	66.0	26.02	64.8	25.54
	-11.8	-13	68.6	28.30	68.2	28.19	68.2	27.33	68.2	26.08	68.2	25.21	64.8	24.72
	-9.8	-11	70.8	28.19	70.8	27.23	70.5	26.42	70.5	25.22	69.5	24.36	64.8	23.85
	-9.5	-10	71.2	28.04	71.2	27.08	70.9	26.29	70.9	25.09	69.5	24.23	64.8	23.72
	-8.5	-9.1	72.6	27.54	72.6	26.60	72.3	25.83	71.9	24.66	69.5	23.81	64.8	23.28
	-7.0	-7.6	75.9	26.79	75.6	25.88	74.3	25.15	71.9	24.02	69.5	23.17	64.8	22.63
	-5.0	-5.6	79.2	25.78	78.4	24.92	74.3	24.25	71.9	23.15	69.5	22.32	64.8	21.76
	-3.0	-3.7	81.5	24.78	79.1	23.95	74.3	23.34	71.9	22.29	69.5	21.47	64.8	20.89
	0.0	-0.7	83.8	23.27	79.1	22.51	74.3	21.98	71.9	21.00	69.5	20.19	64.8	19.59
	3.0	2.2	83.8	21.76	79.1	21.06	74.3	20.62	71.9	19.71	69.5	18.91	64.8	18.29
	5.0	4.1	82.1	18.84	77.5	18.22	72.8	17.84	70.5	17.04	68.2	16.31	63.5	15.73
	7.0	6.0	80.0	17.58	75.5	17.03	71.0	16.73	68.7	16.01	66.4	15.32	61.9	14.73
	9.0	7.9	77.1	16.20	72.7	15.69	68.4	15.42	66.2	14.75	64.0	14.11	59.6	13.57
	11.0	9.8	72.9	15.02	68.8	14.54	64.6	14.29	62.6	13.67	60.5	13.08	56.4	12.58
	13.0	11.8	68.5	13.63	64.6	13.20	60.7	12.97	58.8	12.41	56.8	11.88	52.9	11.42
15.0	13.7	64.8	12.45	61.1	12.06	57.4	11.85	55.6	11.33	53.8	10.84	50.1	10.43	
90	-24.8	-25	44.5	25.72	44.5	26.13	44.2	26.43	44.2	26.56	44.2	26.84	43.4	27.26
	-21.8	-22	54.8	26.13	54.8	26.55	54.5	26.84	54.5	26.98	54.5	27.26	53.4	26.11
	-19.8	-20	58.2	26.41	58.2	26.83	57.8	27.12	57.8	27.26	57.8	26.47	56.7	25.34
	-18.8	-19	59.7	26.55	59.4	26.97	59.1	27.26	59.1	26.86	59.1	26.08	58.0	24.96
	-16.7	-17	62.1	26.84	62.1	27.26	61.9	26.43	61.9	26.01	61.9	25.26	59.2	24.15
	-13.7	-15	66.4	27.26	66.4	26.02	65.8	25.24	65.8	24.80	63.8	24.08	59.2	23.00
	-11.8	-13	68.6	26.41	68.2	25.24	67.9	24.48	65.9	24.03	63.8	23.34	59.2	22.27
	-9.8	-11	70.8	25.53	70.8	24.42	68.0	23.69	65.9	23.22	63.8	22.55	59.2	21.50
	-9.5	-10	71.2	25.39	71.2	24.29	68.0	23.57	65.9	23.10	63.8	22.43	59.2	21.38
	-8.5	-9.1	72.6	24.95	72.1	23.88	68.0	23.17	65.9	22.70	63.8	22.04	59.2	21.00
	-7.0	-7.6	75.9	24.28	72.2	23.26	68.0	22.58	65.9	22.09	63.8	21.45	59.2	20.42
	-5.0	-5.6	76.7	23.39	72.2	22.44	68.0	21.79	65.9	21.29	63.8	20.67	59.2	19.66
	-3.0	-3.7	76.7	22.50	72.2	21.62	68.0	20.99	65.9	20.48	63.8	19.88	59.2	18.89
	0.0	-0.7	76.7	21.17	72.2	20.38	68.0	19.80	65.9	19.27	63.8	18.70	59.2	17.74
	3.0	2.2	76.7	19.83	72.2	19.14	68.0	18.61	65.9	18.06	63.8	17.53	59.2	16.58
	5.0	4.1	75.2	17.15	70.8	16.56	66.6	16.09	64.6	15.58	62.5	15.11	58.0	14.26
	7.0	6.0	73.3	16.07	69.0	15.57	64.9	15.15	62.9	14.64	60.9	14.20	56.6	13.39
	9.0	7.9	70.6	14.80	66.4	14.35	62.5	13.96	60.6	13.48	58.7	13.08	54.5	12.34
	11.0	9.8	66.8	13.59	62.8	13.17	59.1	12.81	57.3	12.38	55.5	12.01	51.5	11.32
	13.0	11.8	62.7	12.08	59.0	11.71	55.5	11.40	53.8	11.01	52.1	10.68	48.4	10.07
15.0	13.7	59.3	10.92	55.8	10.58	52.6	10.30	50.9	9.95	49.3	9.65	45.8	9.10	
80	-24.8	-25	44.3	22.63	44.3	23.05	44.0	23.34	44.0	23.48	44.0	24.17	43.2	23.16
	-21.8	-22	54.2	23.05	54.2	23.46	54.2	23.75	54.2	24.17	54.2	23.16	52.9	22.18
	-19.8	-20	57.6	23.32	57.6	23.74	57.6	24.17	57.6	23.46	56.9	22.48	52.9	21.53
	-18.8	-19	58.9	23.46	58.9	24.17	58.9	23.81	58.9	23.10	56.9	22.14	52.9	21.21
	-16.7	-17	60.8	24.17	60.8	23.42	60.8	23.05	59.0	22.35	56.9	21.44	52.9	20.53
	-13.7	-15	63.6	23.06	62.3	22.34	60.8	21.97	59.0	21.28	56.9	20.42	52.9	19.55
	-11.8	-13	65.1	22.35	63.2	21.66	60.8	21.28	59.0	20.60	56.9	19.78	52.9	18.93
	-9.8	-11	66.8	21.61	64.1	20.95	60.8	20.56	59.0	19.89	56.9	19.10	52.9	18.28
	-9.5	-10	67.3	21.50	64.5	20.84	60.8	20.45	59.0	19.78	56.9	19.00	52.9	18.19
	-8.5	-9.1	68.0	21.13	64.8	20.48	60.8	20.09	59.0	19.42	56.9	18.67	52.9	17.86
	-7.0	-7.6	68.7	20.57	64.8	19.94	60.8	19.55	59.0	18.89	56.9	18.16	52.9	17.37
	-5.0	-5.6	68.7	19.83	64.8	19.23	60.8	18.82	59.0	18.17	56.9	17.48	52.9	16.72
	-3.0	-3.7	68.7	19.09	64.8	18.51	60.8	18.10	59.0	17.46	56.9	16.81	52.9	16.07
	0.0	-0.7	68.7	17.97	64.8	17.44	60.8	17.02	59.0	16.39	56.9	15.79	52.9	15.10
	3.0	2.2	68.7	16.86	64.8	16.36	60.8	15.93	59.0	15.31	56.9	14.78	52.9	14.12
	5.0	4.1	67.3	14.57	63.5	14.13	59.6	13.74	57.8	13.18	55.7	12.72	51.9	12.15
	7.0	6.0	65.6	13.68	61.9	13.29	58.1	12.89	56.3	12.36	54.3	11.95	50.5	11.41
	9.0	7.9	63.2	12.27	59.6	11.93	55.9	11.63	54.3	11.18	52.3	10.78	48.7	10.27
	11.0	9.8	59.8	10.91	56.3	10.61	52.9	10.34	51.3	9.94	49.5	9.59	46.0	9.13
	13.0	11.8	56.1	9.49	52.9	9.22	49.7	8.99	48.2	8.64	46.5	8.33	43.2	7.94
15.0	13.7	53.1	8.57	50.1	8.32	47.0	8.12	45.6	7.80	44.0	7.53	40.9	7.17	

# 7. Capacity Tables

Heating Capacity (24HP)

Combination (%)	Outdoor air temp.		Indoor air temp. °C DB													
			16		18		20		21		22		24			
	°C DB	°C WB	TC	PI	TC	PI	TC	PI	TC	PI	TC	PI	TC	PI		
70	-24.8	-25	44.3	22.77	44.3	22.91	44.0	23.19	44.0	23.61	44.0	22.50	44.0	22.50	43.2	21.46
	-21.8	-22	52.1	23.19	52.1	23.33	51.8	23.61	50.0	22.50	48.5	21.46	45.3	20.46		
	-19.8	-20	57.3	23.47	55.0	23.61	51.8	22.83	50.0	21.76	48.5	20.77	45.3	19.79		
	-18.8	-19	58.3	23.61	55.0	23.21	51.8	22.44	50.0	21.39	48.5	20.42	45.3	19.45		
	-16.7	-17	58.3	22.77	55.0	22.36	51.8	21.63	50.0	20.61	48.5	19.70	45.3	18.75		
	-13.7	-15	58.3	21.59	55.0	21.16	51.8	20.46	50.0	19.51	48.5	18.66	45.3	17.74		
	-11.8	-13	58.3	20.83	55.0	20.40	51.8	19.72	50.0	18.80	48.5	18.00	45.3	17.11		
	-9.8	-11	58.3	20.04	55.0	19.59	51.8	18.95	50.0	18.06	48.5	17.31	45.3	16.44		
	-9.5	-10	58.3	19.92	55.0	19.47	51.8	18.83	50.0	17.95	48.5	17.21	45.3	16.34		
	-8.5	-9.1	58.3	19.53	55.0	19.07	51.8	18.44	50.0	17.58	48.5	16.86	45.3	16.00		
	-7.0	-7.6	58.3	18.93	55.0	18.47	51.8	17.86	50.0	17.03	48.5	16.34	45.3	15.50		
	-5.0	-5.6	58.3	18.14	55.0	17.67	51.8	17.08	50.0	16.29	48.5	15.65	45.3	14.83		
	-3.0	-3.7	58.3	17.35	55.0	16.86	51.8	16.30	50.0	15.55	48.5	14.96	45.3	14.16		
	0.0	-0.7	58.3	16.16	55.0	15.66	51.8	15.14	50.0	14.44	48.5	13.92	45.3	13.16		
	3.0	2.2	58.3	14.97	55.0	14.46	51.8	13.97	50.0	13.34	48.5	12.88	45.3	12.15		
	5.0	4.1	58.3	13.10	53.9	12.34	50.7	11.93	49.0	11.37	47.5	11.01	44.4	10.37		
	7.0	6.0	58.3	12.51	52.5	11.44	49.4	11.05	47.7	10.55	46.3	10.23	43.2	9.62		
	9.0	7.9	56.2	10.84	50.6	9.90	47.6	9.57	46.0	9.14	44.6	8.86	41.6	8.33		
	11.0	9.8	53.2	9.62	47.9	8.79	45.0	8.50	43.5	8.11	42.2	7.87	39.4	7.40		
	13.0	11.8	49.9	8.44	45.0	7.72	42.3	7.46	40.8	7.12	39.6	6.90	37.0	6.49		
15.0	13.7	47.2	7.53	42.5	6.88	40.0	6.65	38.6	6.35	37.5	6.16	35.0	5.79			
60	-24.8	-25	44.3	22.49	44.3	22.77	44.0	23.19	42.9	22.00	41.4	20.89	38.8	19.84		
	-21.8	-22	47.7	22.91	47.3	23.19	44.4	22.00	42.9	20.89	41.4	19.84	38.8	18.83		
	-19.8	-20	50.0	23.19	47.3	22.35	44.4	21.21	42.9	20.15	41.4	19.14	38.8	18.15		
	-18.8	-19	50.0	22.77	47.3	21.93	44.4	20.81	42.9	19.77	41.4	18.79	38.8	17.81		
	-16.7	-17	50.0	21.88	47.3	21.05	44.4	19.98	42.9	18.99	41.4	18.06	38.8	17.10		
	-13.7	-15	50.0	20.61	47.3	19.80	44.4	18.80	42.9	17.88	41.4	17.01	38.8	16.09		
	-11.8	-13	50.0	19.81	47.3	19.00	44.4	18.04	42.9	17.17	41.4	16.35	38.8	15.45		
	-9.8	-11	50.0	18.97	47.3	18.16	44.4	17.25	42.9	16.43	41.4	15.65	38.8	14.77		
	-9.5	-10	50.0	18.84	47.3	18.04	44.4	17.13	42.9	16.32	41.4	15.54	38.8	14.67		
	-8.5	-9.1	50.0	18.42	47.3	17.62	44.4	16.74	42.9	15.95	41.4	15.19	38.8	14.33		
	-7.0	-7.6	50.0	17.79	47.3	16.99	44.4	16.15	42.9	15.39	41.4	14.67	38.8	13.82		
	-5.0	-5.6	50.0	16.94	47.3	16.15	44.4	15.35	42.9	14.65	41.4	13.97	38.8	13.15		
	-3.0	-3.7	50.0	16.10	47.3	15.31	44.4	14.56	42.9	13.91	41.4	13.27	38.8	12.47		
	0.0	-0.7	50.0	14.83	47.3	14.06	44.4	13.38	42.9	12.79	41.4	12.22	38.8	11.46		
	3.0	2.2	50.0	13.56	47.3	12.80	44.4	12.19	42.9	11.68	41.4	11.18	38.8	10.44		
	5.0	4.1	49.0	11.51	46.4	10.82	43.5	10.30	42.0	9.88	40.6	9.47	38.0	8.83		
	7.0	6.0	47.7	10.57	45.2	9.90	42.4	9.44	41.0	9.07	39.6	8.70	37.0	8.09		
	9.0	7.9	46.0	9.06	43.5	8.48	40.8	8.09	39.5	7.77	38.1	7.46	35.7	6.93		
	11.0	9.8	43.5	8.04	41.2	7.53	38.6	7.18	37.3	6.90	36.0	6.62	33.7	6.15		
	13.0	11.8	40.8	7.05	38.7	6.60	36.3	6.29	35.0	6.05	33.8	5.80	31.7	5.40		
15.0	13.7	38.6	6.35	36.6	5.94	34.3	5.61	33.2	5.40	32.0	5.18	30.0	4.86			
50	-24.8	-25	41.7	19.65	39.3	20.07	37.0	19.02	35.8	18.04	34.6	17.11	32.2	16.25		
	-21.8	-22	41.7	20.07	39.3	19.02	37.0	18.04	35.8	17.11	34.6	16.25	32.2	15.42		
	-19.8	-20	41.7	19.34	39.3	18.32	37.0	17.39	35.8	16.49	34.6	15.67	32.2	14.86		
	-18.8	-19	41.7	18.97	39.3	17.97	37.0	17.06	35.8	16.19	34.6	15.38	32.2	14.58		
	-16.7	-17	41.7	18.21	39.3	17.24	37.0	16.38	35.8	15.54	34.6	14.78	32.2	14.00		
	-13.7	-15	41.7	17.12	39.3	16.19	37.0	15.40	35.8	14.61	34.6	13.92	32.2	13.17		
	-11.8	-13	41.7	16.43	39.3	15.53	37.0	14.78	35.8	14.02	34.6	13.37	32.2	12.64		
	-9.8	-11	41.7	15.70	39.3	14.83	37.0	14.12	35.8	13.40	34.6	12.79	32.2	12.08		
	-9.5	-10	41.7	15.59	39.3	14.73	37.0	14.03	35.8	13.31	34.6	12.71	32.2	12.00		
	-8.5	-9.1	41.7	15.22	39.3	14.38	37.0	13.70	35.8	13.00	34.6	12.42	32.2	11.72		
	-7.0	-7.6	41.7	14.68	39.3	13.86	37.0	13.21	35.8	12.54	34.6	11.99	32.2	11.31		
	-5.0	-5.6	41.7	13.95	39.3	13.16	37.0	12.56	35.8	11.92	34.6	11.41	32.2	10.75		
	-3.0	-3.7	41.7	13.22	39.3	12.46	37.0	11.90	35.8	11.30	34.6	10.83	32.2	10.20		
	0.0	-0.7	41.7	12.13	39.3	11.41	37.0	10.92	35.8	10.37	34.6	9.97	32.2	9.36		
	3.0	2.2	41.7	11.04	39.3	10.37	37.0	9.95	35.8	9.44	34.6	9.11	32.2	8.53		
	5.0	4.1	40.9	9.33	38.6	8.74	36.2	8.40	35.1	7.98	33.9	7.71	31.6	7.21		
	7.0	6.0	39.8	8.53	37.6	7.98	35.3	7.69	34.2	7.30	33.1	7.08	30.8	6.60		
	9.0	7.9	38.4	7.38	36.2	6.91	34.0	6.66	32.9	6.33	31.8	6.13	29.7	5.72		
	11.0	9.8	36.5	6.63	34.4	6.21	32.3	5.98	31.1	5.68	30.1	5.50	28.1	5.13		
	13.0	11.8	34.1	5.75	32.1	5.39	30.2	5.19	29.2	4.96	28.3	4.78	26.3	4.48		
15.0	13.7	32.2	5.19	30.4	4.86	28.6	4.68	27.7	4.45	26.8	4.31	24.9	4.02			

**Note**

1. TC: Total Capacity(kW), PI : Power Input(kW, Comp. + Outdoor fan motor)
2. Capacity tables show the average value of conditions which may occur.
3. The heating capacity table is based on the values expressed as Max. in the specification of the outdoor unit. (When measuring the Max. heating capacity, the setting status of the indoor unit is the same as that for measuring the heating capacity of the indoor unit.)

# 7. Capacity Tables

## ◆ ARUM260LTE5

Heating Capacity (26HP)

Combination (%)	Outdoor air temp.		Indoor air temp. °C DB											
			16		18		20		21		22		24	
	°C DB	°C WB	TC	PI	TC	PI	TC	PI	TC	PI	TC	PI	TC	PI
130	-24.8	-25	46.6	26.20	46.6	26.41	46.3	26.59	46.3	26.88	46.3	27.14	45.4	27.57
	-21.8	-22	56.6	26.62	56.6	26.83	56.2	27.02	56.2	27.30	56.2	27.57	55.2	28.00
	-19.8	-20	59.7	26.90	59.7	27.12	59.3	27.30	59.3	27.58	59.3	27.85	58.2	28.28
	-18.8	-19	61.0	27.05	61.0	27.26	60.6	27.44	60.6	27.73	60.6	28.00	59.5	28.42
	-16.7	-17	63.7	27.34	63.7	27.56	63.3	27.74	63.3	28.02	63.3	28.29	62.1	28.72
	-13.7	-15	67.6	27.77	67.6	27.98	67.2	28.17	67.2	28.45	67.2	28.72	65.9	27.67
	-11.8	-13	69.8	28.04	69.8	28.25	69.4	28.43	69.4	28.72	69.4	28.02	68.3	27.01
	-9.8	-11	72.1	28.32	72.1	28.53	71.7	28.72	71.7	27.98	71.7	27.28	70.8	26.32
	-9.5	-10	72.5	28.36	72.5	28.58	72.1	28.61	72.1	27.87	72.0	27.17	71.2	26.21
	-8.5	-9.1	73.9	28.51	73.9	28.72	73.5	28.23	73.5	27.50	73.2	26.81	72.4	25.87
	-7.0	-7.6	76.0	28.72	76.0	28.17	75.5	27.67	75.5	26.94	75.5	26.25	74.3	25.34
	-5.0	-5.6	78.8	28.02	78.8	27.44	78.3	26.91	78.3	26.20	78.3	25.52	76.8	24.65
	-3.0	-3.7	81.6	27.33	81.6	26.72	81.1	26.16	81.1	25.46	81.1	24.78	79.3	23.95
	0.0	-0.7	85.8	26.28	85.8	25.62	85.2	25.04	85.2	24.35	85.2	23.68	83.1	22.91
	3.0	2.2	90.0	25.24	90.0	24.53	89.4	23.91	89.4	23.23	89.4	22.58	83.9	21.86
	5.0	4.1	91.1	22.29	90.9	21.59	90.3	20.99	90.3	20.36	88.3	19.74	82.2	19.11
	7.0	6.0	91.4	21.22	91.2	20.54	90.7	19.94	89.2	19.36	86.0	18.78	80.1	18.22
	9.0	7.9	88.5	19.81	88.3	19.17	88.1	18.61	85.9	18.07	82.9	17.53	77.2	17.01
	11.0	9.8	83.7	18.64	83.5	18.04	83.3	17.51	81.2	17.00	78.4	16.50	73.0	16.00
	13.0	11.8	78.6	17.21	78.5	16.65	78.2	16.17	76.3	15.70	73.6	15.23	68.5	14.77
15.0	13.7	74.4	16.02	74.2	15.50	74.0	15.05	72.2	14.61	69.7	14.18	64.8	13.75	
120	-24.8	-25	46.2	26.41	46.2	26.59	45.9	26.88	45.9	27.14	45.9	27.57	45.1	27.87
	-21.8	-22	56.2	26.83	56.2	27.02	55.8	27.30	55.8	27.57	55.8	28.00	54.8	28.29
	-19.8	-20	59.3	27.12	59.3	27.30	58.9	27.58	58.9	27.85	58.9	28.28	57.8	28.58
	-18.8	-19	60.6	27.26	60.6	27.44	60.2	27.73	60.2	28.00	60.2	28.42	59.0	28.72
	-16.7	-17	63.3	27.56	63.3	27.74	62.9	28.02	62.9	28.29	62.9	28.72	61.7	28.05
	-13.7	-15	67.1	27.98	67.1	28.17	66.7	28.45	66.7	28.72	66.7	27.72	65.4	27.09
	-11.8	-13	69.3	28.25	69.3	28.43	68.9	28.72	68.9	28.01	68.9	27.09	67.8	26.48
	-9.8	-11	71.6	28.53	71.6	28.72	71.2	27.94	71.2	27.27	71.2	26.42	70.3	25.84
	-9.5	-10	72.0	28.58	72.0	28.60	71.6	27.83	71.6	27.16	71.6	26.32	70.7	25.74
	-8.5	-9.1	73.4	28.72	73.4	28.19	72.9	27.44	72.9	26.79	72.9	25.99	71.9	25.42
	-7.0	-7.6	75.5	28.11	75.5	27.58	75.0	26.86	75.0	26.23	75.0	25.49	73.8	24.94
	-5.0	-5.6	78.3	27.31	78.3	26.76	77.8	26.09	77.8	25.49	77.8	24.83	76.3	24.30
	-3.0	-3.7	81.0	26.51	81.0	25.95	80.5	25.31	80.5	24.75	80.5	24.16	78.8	23.66
	0.0	-0.7	85.2	25.30	85.2	24.73	84.6	24.15	84.6	23.63	84.6	23.17	78.8	22.71
	3.0	2.2	89.3	24.10	89.3	23.51	88.8	22.99	87.5	22.52	84.8	22.17	78.8	21.75
	5.0	4.1	90.5	21.14	90.2	20.57	88.7	20.11	85.8	19.69	83.1	19.40	77.2	19.03
	7.0	6.0	90.9	20.01	90.0	19.47	86.5	19.09	83.6	18.72	81.0	18.55	75.2	18.22
	9.0	7.9	87.9	18.63	86.7	18.12	83.3	17.76	80.5	17.42	78.0	17.26	72.5	16.95
	11.0	9.8	83.1	17.47	82.0	16.99	78.8	16.66	76.1	16.34	73.8	16.18	68.5	15.90
	13.0	11.8	78.1	16.06	77.0	15.63	74.0	15.32	71.5	15.03	69.3	14.89	64.4	14.62
15.0	13.7	73.9	14.89	72.9	14.49	70.0	14.20	67.7	13.93	65.6	13.80	60.9	13.55	
110	-24.8	-25	46.0	26.59	46.0	26.88	45.7	27.14	45.7	27.57	45.7	27.87	44.8	28.01
	-21.8	-22	55.9	27.02	55.9	27.30	55.5	27.57	55.5	28.00	55.5	28.29	54.5	28.43
	-19.8	-20	59.0	27.30	59.0	27.58	58.6	27.85	58.6	28.28	58.6	28.58	57.5	28.72
	-18.8	-19	60.2	27.44	60.2	27.73	59.9	28.00	59.9	28.42	59.9	28.72	58.7	28.36
	-16.7	-17	62.9	27.74	62.9	28.02	62.5	28.29	62.5	28.72	62.5	27.99	61.3	27.61
	-13.7	-15	66.7	28.17	66.7	28.45	66.3	28.72	66.3	27.61	66.3	26.94	65.3	26.54
	-11.8	-13	68.9	28.43	68.9	28.72	68.5	27.94	68.5	26.91	68.5	26.28	68.5	25.86
	-9.8	-11	71.2	28.72	71.2	27.84	70.8	27.12	70.8	26.18	70.8	25.59	70.3	25.14
	-9.5	-10	71.6	28.58	71.6	27.71	71.2	27.00	71.2	26.07	71.2	25.48	70.9	25.03
	-8.5	-9.1	73.0	28.10	73.0	27.27	72.6	26.59	72.6	25.70	72.6	25.13	70.9	24.67
	-7.0	-7.6	75.1	27.40	75.1	26.61	74.6	25.97	74.6	25.15	74.6	24.61	70.9	24.14
	-5.0	-5.6	77.8	26.45	77.8	25.73	77.3	25.16	77.3	24.41	75.9	23.92	70.9	23.42
	-3.0	-3.7	80.6	25.51	80.6	24.86	80.1	24.34	78.6	23.68	75.9	23.22	70.9	22.71
	0.0	-0.7	84.7	24.09	84.7	23.54	81.2	23.11	78.6	22.57	75.9	22.18	70.9	21.63
	3.0	2.2	88.8	22.67	86.6	22.23	81.2	21.88	78.6	21.47	75.9	21.13	70.9	20.56
	5.0	4.1	89.8	19.71	84.8	19.34	79.6	19.05	77.0	18.72	74.4	18.43	69.5	17.90
	7.0	6.0	87.5	18.50	82.7	18.22	77.6	18.01	75.1	17.80	72.5	17.57	67.7	17.02
	9.0	7.9	84.3	17.12	79.6	16.87	74.7	16.68	72.3	16.47	69.9	16.26	65.2	15.76
	11.0	9.8	79.7	15.96	75.3	15.72	70.7	15.55	68.4	15.36	66.1	15.16	61.7	14.69
	13.0	11.8	74.8	14.58	70.7	14.36	66.4	14.20	64.2	14.03	62.0	13.85	57.9	13.42
15.0	13.7	70.8	13.41	66.9	13.21	62.8	13.06	60.7	12.90	58.7	12.74	54.8	12.35	

# 7. Capacity Tables

Heating Capacity (26HP)

Combination (%)	Outdoor air temp.		Indoor air temp. °C DB											
			16		18		20		21		22		24	
	°C DB	°C WB	TC	PI	TC	PI	TC	PI	TC	PI	TC	PI	TC	PI
100	-24.8	-25	45.8	29.52	45.8	29.41	45.5	27.44	45.5	29.15	45.5	29.04	44.6	28.99
	-21.8	-22	55.7	29.36	55.7	29.25	55.3	28.30	55.3	28.99	55.3	29.29	54.3	28.82
	-19.8	-20	58.7	29.25	58.7	29.15	58.4	28.85	58.4	28.88	58.4	28.91	57.2	28.72
	-18.8	-19	60.0	29.20	59.6	29.09	59.6	28.99	59.6	28.83	59.6	28.72	58.5	28.28
	-16.7	-17	62.3	29.09	62.3	28.98	62.3	29.29	61.9	28.72	61.9	27.81	60.7	27.35
	-13.7	-15	66.4	28.93	66.4	28.82	66.0	28.72	66.0	27.40	66.0	26.51	64.8	26.02
	-11.8	-13	68.6	28.82	68.2	28.72	68.2	27.84	68.2	26.57	68.2	25.68	64.8	25.18
	-9.8	-11	70.8	28.72	70.8	27.74	70.5	26.92	70.5	25.69	69.5	24.81	64.8	24.29
	-9.5	-10	71.2	28.56	71.2	27.59	70.9	26.78	70.9	25.56	69.5	24.68	64.8	24.16
	-8.5	-9.1	72.6	28.05	72.6	27.10	72.3	26.31	71.9	25.12	69.5	24.25	64.8	23.72
	-7.0	-7.6	75.9	27.28	75.6	26.36	74.3	25.62	71.9	24.46	69.5	23.60	64.8	23.05
	-5.0	-5.6	79.2	26.26	78.4	25.38	74.3	24.70	71.9	23.58	69.5	22.73	64.8	22.17
	-3.0	-3.7	81.5	25.24	79.1	24.40	74.3	23.77	71.9	22.71	69.5	21.87	64.8	21.28
	0.0	-0.7	83.8	23.70	79.1	22.93	74.3	22.39	71.9	21.39	69.5	20.56	64.8	19.96
	3.0	2.2	83.8	22.17	79.1	21.45	74.3	21.00	71.9	20.08	69.5	19.26	64.8	18.63
	5.0	4.1	82.1	19.19	77.5	18.55	72.8	18.17	70.5	17.35	68.2	16.62	63.5	16.03
	7.0	6.0	80.0	17.91	75.5	17.34	71.0	17.04	68.7	16.31	66.4	15.60	61.9	15.00
	9.0	7.9	77.1	16.50	72.7	15.98	68.4	15.70	66.2	15.02	64.0	14.37	59.6	13.82
	11.0	9.8	72.9	15.30	68.8	14.82	64.6	14.56	62.6	13.93	60.5	13.33	56.4	12.82
	13.0	11.8	68.5	13.89	64.6	13.45	60.7	13.22	58.8	12.64	56.8	12.10	52.9	11.63
15.0	13.7	64.8	12.68	61.1	12.28	57.4	12.07	55.6	11.55	53.8	11.05	50.1	10.62	
90	-24.8	-25	45.6	26.19	45.6	26.62	45.3	26.92	45.3	27.06	45.3	27.34	44.5	27.77
	-21.8	-22	55.4	26.62	55.4	27.04	55.1	27.34	55.1	27.48	55.1	27.77	54.0	26.59
	-19.8	-20	58.5	26.90	58.5	27.33	58.1	27.63	58.1	27.77	58.1	26.97	57.0	25.81
	-18.8	-19	60.0	27.04	59.6	27.47	59.4	27.77	59.4	27.36	59.4	26.57	58.2	25.42
	-16.7	-17	62.3	27.34	62.3	27.77	62.0	26.92	62.0	26.49	62.0	25.73	59.2	24.60
	-13.7	-15	66.4	27.77	66.4	26.51	65.8	25.71	65.8	25.26	63.8	24.53	59.2	23.42
	-11.8	-13	68.6	26.91	68.2	25.71	67.9	24.94	65.9	24.48	63.8	23.77	59.2	22.68
	-9.8	-11	70.8	26.00	70.8	24.87	68.0	24.13	65.9	23.66	63.8	22.97	59.2	21.90
	-9.5	-10	71.2	25.86	71.2	24.75	68.0	24.01	65.9	23.53	63.8	22.85	59.2	21.78
	-8.5	-9.1	72.6	25.41	72.1	24.33	68.0	23.61	65.9	23.12	63.8	22.45	59.2	21.39
	-7.0	-7.6	75.9	24.73	72.2	23.70	68.0	23.00	65.9	22.51	63.8	21.85	59.2	20.80
	-5.0	-5.6	76.7	23.83	72.2	22.86	68.0	22.19	65.9	21.68	63.8	21.05	59.2	20.02
	-3.0	-3.7	76.7	22.92	72.2	22.02	68.0	21.38	65.9	20.86	63.8	20.25	59.2	19.24
	0.0	-0.7	76.7	21.56	72.2	20.76	68.0	20.17	65.9	19.63	63.8	19.05	59.2	18.07
	3.0	2.2	76.7	20.20	72.2	19.50	68.0	18.96	65.9	18.40	63.8	17.85	59.2	16.89
	5.0	4.1	75.2	17.47	70.8	16.87	66.6	16.39	64.6	15.87	62.5	15.39	58.0	14.53
	7.0	6.0	73.3	16.37	69.0	15.86	64.9	15.44	62.9	14.91	60.9	14.47	56.6	13.64
	9.0	7.9	70.6	15.08	66.4	14.61	62.5	14.22	60.6	13.74	58.7	13.33	54.5	12.57
	11.0	9.8	66.8	13.84	62.8	13.41	59.1	13.05	57.3	12.61	55.5	12.23	51.5	11.54
	13.0	11.8	62.7	12.31	59.0	11.93	55.5	11.61	53.8	11.21	52.1	10.88	48.4	10.26
15.0	13.7	59.3	11.12	55.8	10.78	52.6	10.49	50.9	10.13	49.3	9.83	45.8	9.27	
80	-24.8	-25	45.4	23.05	45.4	23.47	45.1	23.77	45.1	23.91	45.1	24.62	44.3	23.59
	-21.8	-22	54.9	23.47	54.9	23.90	54.9	24.20	54.9	24.62	54.9	23.59	52.9	22.60
	-19.8	-20	57.9	23.76	57.9	24.18	57.9	24.62	57.9	23.89	56.9	22.90	52.9	21.93
	-18.8	-19	59.1	23.90	59.1	24.62	59.1	24.25	59.0	23.53	56.9	22.56	52.9	21.60
	-16.7	-17	60.8	24.62	60.8	23.86	60.8	23.48	59.0	22.77	56.9	21.83	52.9	20.91
	-13.7	-15	63.6	23.49	62.3	22.76	60.8	22.38	59.0	21.67	56.9	20.80	52.9	19.91
	-11.8	-13	65.2	22.77	63.3	22.07	60.8	21.68	59.0	20.98	56.9	20.15	52.9	19.29
	-9.8	-11	67.0	22.01	64.2	21.34	60.8	20.94	59.0	20.26	56.9	19.46	52.9	18.62
	-9.5	-10	67.4	21.90	64.5	21.23	60.8	20.83	59.0	20.15	56.9	19.36	52.9	18.52
	-8.5	-9.1	68.1	21.52	64.8	20.86	60.8	20.46	59.0	19.78	56.9	19.01	52.9	18.19
	-7.0	-7.6	68.7	20.95	64.8	20.32	60.8	19.91	59.0	19.24	56.9	18.50	52.9	17.70
	-5.0	-5.6	68.7	20.20	64.8	19.59	60.8	19.17	59.0	18.51	56.9	17.81	52.9	17.03
	-3.0	-3.7	68.7	19.44	64.8	18.86	60.8	18.44	59.0	17.78	56.9	17.12	52.9	16.37
	0.0	-0.7	68.7	18.31	64.8	17.76	60.8	17.33	59.0	16.69	56.9	16.09	52.9	15.38
	3.0	2.2	68.7	17.17	64.8	16.67	60.8	16.23	59.0	15.60	56.9	15.06	52.9	14.39
	5.0	4.1	67.3	14.84	63.5	14.39	59.6	13.99	57.8	13.42	55.7	12.96	51.9	12.38
	7.0	6.0	65.6	13.94	61.9	13.53	58.1	13.13	56.3	12.59	54.3	12.17	50.5	11.62
	9.0	7.9	63.2	12.50	59.6	12.15	55.9	11.85	54.3	11.39	52.3	10.98	48.7	10.46
	11.0	9.8	59.8	11.12	56.3	10.80	52.9	10.54	51.3	10.13	49.5	9.77	46.0	9.30
	13.0	11.8	56.1	9.66	52.9	9.39	49.7	9.16	48.2	8.80	46.5	8.49	43.2	8.09
15.0	13.7	53.1	8.73	50.1	8.48	47.0	8.27	45.6	7.95	44.0	7.67	40.9	7.30	



# 7. Capacity Tables

Heating Capacity (26HP)

Combination (%)	Outdoor air temp.		Indoor air temp. °C DB											
			16		18		20		21		22		24	
	°C DB	°C WB	TC	PI	TC	PI	TC	PI	TC	PI	TC	PI	TC	PI
70	-24.8	-25	45.4	23.20	45.4	23.34	45.1	23.62	45.1	24.05	45.1	22.92	44.3	21.86
	-21.8	-22	52.1	23.62	52.1	23.76	51.8	24.05	50.0	22.92	48.5	21.86	45.3	20.84
	-19.8	-20	56.5	23.90	55.0	24.05	51.8	23.25	50.0	22.16	48.5	21.16	45.3	20.15
	-18.8	-19	58.3	24.05	55.0	23.64	51.8	22.86	50.0	21.79	48.5	20.80	45.3	19.81
	-16.7	-17	58.3	23.20	55.0	22.78	51.8	22.03	50.0	21.00	48.5	20.06	45.3	19.10
	-13.7	-15	58.3	21.99	55.0	21.55	51.8	20.84	50.0	19.87	48.5	19.01	45.3	18.07
	-11.8	-13	58.3	21.22	55.0	20.78	51.8	20.09	50.0	19.15	48.5	18.34	45.3	17.43
	-9.8	-11	58.3	20.41	55.0	19.96	51.8	19.30	50.0	18.40	48.5	17.63	45.3	16.74
	-9.5	-10	58.3	20.29	55.0	19.84	51.8	19.18	50.0	18.29	48.5	17.53	45.3	16.64
	-8.5	-9.1	58.3	19.89	55.0	19.43	51.8	18.78	50.0	17.91	48.5	17.17	45.3	16.30
	-7.0	-7.6	58.3	19.29	55.0	18.81	51.8	18.19	50.0	17.35	48.5	16.65	45.3	15.79
	-5.0	-5.6	58.3	18.48	55.0	18.00	51.8	17.40	50.0	16.59	48.5	15.94	45.3	15.11
	-3.0	-3.7	58.3	17.67	55.0	17.18	51.8	16.61	50.0	15.84	48.5	15.24	45.3	14.42
	0.0	-0.7	58.3	16.46	55.0	15.95	51.8	15.42	50.0	14.71	48.5	14.18	45.3	13.40
	3.0	2.2	58.3	15.25	55.0	14.72	51.8	14.23	50.0	13.58	48.5	13.12	45.3	12.38
	5.0	4.1	58.3	13.35	53.9	12.57	50.7	12.15	49.0	11.59	47.5	11.21	44.4	10.56
	7.0	6.0	58.3	12.74	52.5	11.65	49.4	11.26	47.7	10.75	46.3	10.43	43.2	9.80
	9.0	7.9	56.2	11.04	50.6	10.09	47.6	9.75	46.0	9.31	44.6	9.03	41.6	8.49
	11.0	9.8	53.2	9.80	47.9	8.96	45.0	8.66	43.5	8.26	42.2	8.01	39.4	7.54
	13.0	11.8	49.9	8.60	45.0	7.86	42.3	7.60	40.8	7.25	39.6	7.03	37.0	6.61
15.0	13.7	47.2	7.67	42.5	7.01	40.0	6.78	38.6	6.47	37.5	6.27	35.0	5.90	
60	-24.8	-25	44.7	22.91	44.7	23.20	44.4	23.62	42.9	22.41	41.4	21.28	38.8	20.21
	-21.8	-22	47.9	23.34	47.3	23.62	44.4	22.41	42.9	21.28	41.4	20.21	38.8	19.18
	-19.8	-20	50.0	23.62	47.3	22.77	44.4	21.61	42.9	20.52	41.4	19.50	38.8	18.49
	-18.8	-19	50.0	23.19	47.3	22.34	44.4	21.20	42.9	20.14	41.4	19.14	38.8	18.14
	-16.7	-17	50.0	22.29	47.3	21.44	44.4	20.36	42.9	19.35	41.4	18.39	38.8	17.42
	-13.7	-15	50.0	21.00	47.3	20.16	44.4	19.15	42.9	18.21	41.4	17.33	38.8	16.39
	-11.8	-13	50.0	20.18	47.3	19.35	44.4	18.38	42.9	17.49	41.4	16.65	38.8	15.73
	-9.8	-11	50.0	19.32	47.3	18.50	44.4	17.57	42.9	16.74	41.4	15.94	38.8	15.05
	-9.5	-10	50.0	19.19	47.3	18.37	44.4	17.45	42.9	16.62	41.4	15.83	38.8	14.94
	-8.5	-9.1	50.0	18.76	47.3	17.95	44.4	17.05	42.9	16.25	41.4	15.48	38.8	14.60
	-7.0	-7.6	50.0	18.12	47.3	17.31	44.4	16.45	42.9	15.68	41.4	14.94	38.8	14.08
	-5.0	-5.6	50.0	17.26	47.3	16.45	44.4	15.64	42.9	14.92	41.4	14.23	38.8	13.39
	-3.0	-3.7	50.0	16.40	47.3	15.60	44.4	14.83	42.9	14.17	41.4	13.52	38.8	12.70
	0.0	-0.7	50.0	15.11	47.3	14.32	44.4	13.62	42.9	13.03	41.4	12.45	38.8	11.67
	3.0	2.2	50.0	13.82	47.3	13.04	44.4	12.42	42.9	11.90	41.4	11.38	38.8	10.64
	5.0	4.1	49.0	11.73	46.4	11.03	43.5	10.50	42.0	10.07	40.6	9.65	38.0	9.00
	7.0	6.0	47.7	10.77	45.2	10.09	42.4	9.61	41.0	9.24	39.6	8.86	37.0	8.24
	9.0	7.9	46.0	9.23	43.5	8.64	40.8	8.24	39.5	7.92	38.1	7.60	35.7	7.06
	11.0	9.8	43.5	8.19	41.2	7.67	38.6	7.31	37.3	7.02	36.0	6.74	33.7	6.27
	13.0	11.8	40.8	7.18	38.7	6.73	36.3	6.41	35.0	6.16	33.8	5.91	31.7	5.50
15.0	13.7	38.6	6.46	36.6	6.06	34.3	5.72	33.2	5.50	32.0	5.27	30.0	4.95	
50	-24.8	-25	41.7	20.01	39.3	20.44	37.0	19.37	35.8	18.38	34.6	17.43	32.2	16.55
	-21.8	-22	41.7	20.44	39.3	19.37	37.0	18.38	35.8	17.43	34.6	16.55	32.2	15.70
	-19.8	-20	41.7	19.70	39.3	18.66	37.0	17.71	35.8	16.80	34.6	15.96	32.2	15.14
	-18.8	-19	41.7	19.33	39.3	18.31	37.0	17.38	35.8	16.49	34.6	15.67	32.2	14.85
	-16.7	-17	41.7	18.55	39.3	17.56	37.0	16.68	35.8	15.83	34.6	15.05	32.2	14.26
	-13.7	-15	41.7	17.44	39.3	16.49	37.0	15.68	35.8	14.88	34.6	14.17	32.2	13.41
	-11.8	-13	41.7	16.73	39.3	15.82	37.0	15.05	35.8	14.28	34.6	13.62	32.2	12.87
	-9.8	-11	41.7	15.99	39.3	15.11	37.0	14.39	35.8	13.65	34.6	13.03	32.2	12.31
	-9.5	-10	41.7	15.88	39.3	15.00	37.0	14.29	35.8	13.56	34.6	12.94	32.2	12.22
	-8.5	-9.1	41.7	15.51	39.3	14.65	37.0	13.95	35.8	13.24	34.6	12.65	32.2	11.94
	-7.0	-7.6	41.7	14.95	39.3	14.11	37.0	13.46	35.8	12.77	34.6	12.21	32.2	11.52
	-5.0	-5.6	41.7	14.21	39.3	13.40	37.0	12.79	35.8	12.14	34.6	11.62	32.2	10.95
	-3.0	-3.7	41.7	13.47	39.3	12.69	37.0	12.13	35.8	11.51	34.6	11.04	32.2	10.39
	0.0	-0.7	41.7	12.35	39.3	11.63	37.0	11.13	35.8	10.57	34.6	10.16	32.2	9.54
	3.0	2.2	41.7	11.24	39.3	10.56	37.0	10.13	35.8	9.62	34.6	9.28	32.2	8.69
	5.0	4.1	40.9	9.50	38.6	8.91	36.2	8.56	35.1	8.13	33.9	7.85	31.6	7.34
	7.0	6.0	39.8	8.68	37.6	8.13	35.3	7.83	34.2	7.44	33.1	7.21	30.8	6.73
	9.0	7.9	38.4	7.52	36.2	7.04	34.0	6.78	32.9	6.44	31.8	6.24	29.7	5.83
	11.0	9.8	36.5	6.75	34.4	6.32	32.3	6.09	31.1	5.78	30.1	5.60	28.1	5.23
	13.0	11.8	34.1	5.86	32.1	5.49	30.2	5.28	29.2	5.05	28.3	4.86	26.3	4.56
15.0	13.7	32.2	5.29	30.4	4.95	28.6	4.77	27.7	4.53	26.8	4.39	24.9	4.10	

**Note**

1. TC: Total Capacity(kW), PI : Power Input(kW, Comp. + Outdoor fan motor)
2. Capacity tables show the average value of conditions which may occur.
3. The heating capacity table is based on the values expressed as Max. in the specification of the outdoor unit. (When measuring the Max. heating capacity, the setting status of the indoor unit is the same as that for measuring the heating capacity of the indoor unit.)

# 7. Capacity Tables

## ◆ ARUM221LTE5

Heating Capacity (22HP)

Combination (%)	Outdoor air temp.		Indoor air temp. °C DB											
			16		18		20		21		22		24	
	°C DB	°C WB	TC	PI	TC	PI	TC	PI	TC	PI	TC	PI	TC	PI
130	-24.8	-25	44.3	21.1	44.3	21.41	44.0	21.69	44.0	22.10	44.0	22.50	43.4	23.13
	-21.8	-22	53.1	21.73	53.1	22.04	52.8	22.31	52.8	22.72	52.8	23.13	52.1	23.74
	-19.8	-20	55.7	22.14	55.7	22.46	55.3	22.72	55.3	23.14	55.3	23.54	54.6	24.16
	-18.8	-19	56.9	22.36	56.9	22.66	56.5	22.94	56.5	23.35	56.5	23.74	55.7	24.37
	-16.7	-17	59.3	22.79	59.3	23.10	58.9	23.38	58.9	23.79	58.9	24.18	58.0	24.81
	-13.7	-15	62.7	23.42	62.7	23.73	62.4	24.00	62.4	24.41	62.4	24.81	61.4	23.59
	-11.8	-13	64.7	23.81	64.7	24.12	64.3	24.40	64.3	24.81	64.3	23.97	63.6	22.81
	-9.8	-11	66.7	24.22	66.7	24.54	66.2	24.81	66.2	23.89	66.2	23.08	65.5	22.00
	-9.5	-10	67.1	24.29	67.1	24.60	66.7	24.67	66.7	23.74	66.6	22.95	65.9	21.88
	-8.5	-9.1	68.6	24.50	68.6	24.81	68.2	24.17	68.2	23.28	67.6	22.50	66.9	21.47
	-7.0	-7.6	70.9	24.81	70.9	24.06	70.4	23.44	70.4	22.59	70.4	21.84	69.0	20.86
	-5.0	-5.6	73.9	23.79	73.9	23.07	73.4	22.46	73.4	21.66	73.4	20.95	71.2	20.04
	-3.0	-3.7	77.0	22.77	77.0	22.07	76.4	21.48	76.4	20.73	76.4	20.07	73.5	19.23
	0.0	-0.7	81.4	21.23	81.4	20.58	81.0	20.02	81.0	19.35	81.0	18.73	76.6	18.01
	3.0	2.2	85.9	19.70	85.9	19.08	85.4	18.55	85.4	17.96	83.9	17.40	77.9	16.79
	5.0	4.1	86.8	17.01	86.6	16.45	86.2	15.96	85.0	15.45	82.3	14.96	76.7	14.45
	7.0	6.0	85.8	15.71	85.6	15.21	85.2	14.76	83.2	14.33	80.3	13.91	74.8	13.49
	9.0	7.9	82.5	14.23	82.4	13.77	82.1	13.36	80.1	12.97	77.3	12.59	72.0	12.22
	11.0	9.8	78.1	12.91	77.9	12.50	77.7	12.14	75.7	11.78	73.1	11.44	68.0	11.09
	13.0	11.8	73.3	11.44	73.2	11.07	73.0	10.76	71.1	10.44	68.7	10.13	64.0	9.82
15.0	13.7	69.3	10.14	69.3	9.82	69.0	9.53	67.3	9.25	64.9	8.98	60.5	8.71	
120	-24.8	-25	44.0	21.41	44.0	21.69	43.7	22.10	43.7	22.50	43.7	23.13	43.1	23.56
	-21.8	-22	52.8	22.04	52.8	22.31	52.4	22.72	52.4	23.13	52.4	23.74	51.7	24.18
	-19.8	-20	55.3	22.46	55.3	22.72	55.0	23.14	55.0	23.54	55.0	24.16	54.2	24.60
	-18.8	-19	56.5	22.66	56.5	22.94	56.1	23.35	56.1	23.74	56.1	24.37	55.3	24.81
	-16.7	-17	58.9	23.10	58.9	23.38	58.5	23.79	58.5	24.18	58.5	24.81	57.6	24.03
	-13.7	-15	62.2	23.73	62.2	24.00	61.9	24.41	61.9	24.81	61.9	23.62	61.0	22.91
	-11.8	-13	64.2	24.12	64.2	24.40	63.8	24.81	63.8	23.96	63.8	22.87	63.1	22.19
	-9.8	-11	66.2	24.54	66.2	24.81	65.8	23.86	65.8	23.07	65.8	22.08	65.1	21.44
	-9.5	-10	66.7	24.60	66.7	24.65	66.3	23.72	66.3	22.94	66.3	21.96	65.5	21.33
	-8.5	-9.1	68.2	24.81	68.2	24.14	67.7	23.24	67.7	22.49	67.6	21.57	66.8	20.96
	-7.0	-7.6	70.4	24.02	70.4	23.38	70.0	22.53	70.0	21.82	69.4	20.97	68.5	20.39
	-5.0	-5.6	73.4	22.97	73.4	22.35	72.9	21.59	72.9	20.93	72.9	20.18	70.8	19.64
	-3.0	-3.7	76.4	21.92	76.4	21.33	75.9	20.63	75.9	20.04	75.9	19.39	72.4	18.89
	0.0	-0.7	80.8	20.34	80.8	19.79	80.3	19.21	80.3	18.70	78.9	18.20	73.5	17.77
	3.0	2.2	85.3	18.75	85.3	18.25	83.9	17.79	81.6	17.36	78.9	17.01	73.5	16.66
	5.0	4.1	86.2	16.11	85.5	15.65	82.7	15.27	80.0	14.93	77.5	14.66	72.0	14.36
	7.0	6.0	85.1	14.82	84.0	14.42	80.7	14.13	77.9	13.87	75.5	13.73	70.2	13.49
	9.0	7.9	82.0	13.40	80.9	13.04	77.7	12.79	75.1	12.54	72.8	12.42	67.6	12.19
	11.0	9.8	77.5	12.16	76.5	11.83	73.5	11.59	71.0	11.37	68.8	11.27	64.0	11.06
	13.0	11.8	72.8	10.76	71.8	10.46	69.0	10.25	66.7	10.06	64.7	9.97	60.0	9.79
15.0	13.7	68.9	9.52	68.0	9.26	65.3	9.07	63.1	8.91	61.2	8.82	56.8	8.66	
110	-24.8	-25	43.7	21.69	43.7	22.10	43.5	22.50	43.5	23.13	43.5	23.56	42.9	23.77
	-21.8	-22	52.5	22.31	52.5	22.72	52.2	23.13	52.2	23.74	52.2	24.18	51.5	24.40
	-19.8	-20	55.0	22.72	55.0	23.14	54.7	23.54	54.7	24.16	54.7	24.60	53.9	24.81
	-18.8	-19	56.1	22.94	56.1	23.35	55.8	23.74	55.8	24.37	55.8	24.81	55.0	24.41
	-16.7	-17	58.6	23.38	58.6	23.79	58.2	24.18	58.2	24.81	58.2	23.98	57.3	23.58
	-13.7	-15	62.0	24.00	62.0	24.41	61.5	24.81	61.5	23.55	61.5	22.79	61.5	22.39
	-11.8	-13	63.9	24.40	63.9	24.81	63.4	23.91	63.4	22.74	63.4	22.04	63.4	21.64
	-9.8	-11	65.8	24.81	65.8	23.79	65.5	22.96	65.5	21.90	65.5	21.25	64.9	20.84
	-9.5	-10	66.3	24.64	66.3	23.62	65.9	22.82	65.9	21.77	65.9	21.14	65.6	20.71
	-8.5	-9.1	67.8	24.09	67.8	23.12	67.3	22.35	67.3	21.35	67.3	20.74	66.2	20.32
	-7.0	-7.6	70.0	23.24	70.0	22.35	69.6	21.63	69.6	20.71	69.6	20.15	66.2	19.73
	-5.0	-5.6	73.0	22.12	73.0	21.32	72.5	20.68	72.5	19.87	70.8	19.35	66.2	18.93
	-3.0	-3.7	75.9	21.00	75.9	20.30	75.3	19.73	73.3	19.03	70.8	18.57	66.2	18.14
	0.0	-0.7	80.4	19.31	80.0	18.76	75.7	18.31	73.3	17.76	70.8	17.39	66.2	16.95
	3.0	2.2	84.4	17.64	80.7	17.21	75.7	16.88	73.3	16.50	70.8	16.20	66.2	15.76
	5.0	4.1	83.8	15.02	79.2	14.70	74.3	14.45	71.9	14.16	69.4	13.92	64.9	13.52
	7.0	6.0	81.6	13.70	77.1	13.49	72.4	13.34	70.0	13.18	67.6	13.01	63.2	12.60
	9.0	7.9	78.6	12.33	74.3	12.15	69.7	12.01	67.5	11.87	65.1	11.72	60.9	11.36
	11.0	9.8	74.3	11.13	70.2	10.96	66.0	10.83	63.8	10.71	61.6	10.57	57.6	10.24
	13.0	11.8	69.8	9.79	66.0	9.64	61.9	9.52	59.9	9.41	57.9	9.29	54.1	9.00
15.0	13.7	66.0	8.58	62.4	8.46	58.6	8.37	56.7	8.27	54.8	8.15	51.1	7.90	

# 7. Capacity Tables

Heating Capacity (22HP)

Combination (%)	Outdoor air temp.		Indoor air temp. °C DB											
			16		18		20		21		22		24	
	°C DB	°C WB	TC	PI	TC	PI	TC	PI	TC	PI	TC	PI	TC	PI
100	-24.8	-25	43.5	23.61	43.5	23.76	43.3	22.99	43.3	24.16	43.3	24.33	42.7	24.41
	-21.8	-22	52.2	23.85	52.2	24.01	52.0	23.71	52.0	24.40	52.0	24.84	51.2	24.65
	-19.8	-20	54.8	24.01	54.8	24.16	54.4	24.19	54.4	24.56	54.4	24.82	53.7	24.81
	-18.8	-19	55.9	24.08	55.5	24.25	55.5	24.40	55.5	24.64	55.5	24.81	54.8	24.35
	-16.7	-17	58.0	24.25	58.0	24.42	58.0	24.84	57.6	24.81	57.6	23.85	56.7	23.39
	-13.7	-15	61.6	24.50	61.6	24.65	61.3	24.81	61.3	23.39	61.3	22.48	60.5	22.01
	-11.8	-13	63.5	24.65	63.2	24.81	63.2	23.84	63.2	22.49	63.2	21.60	60.5	21.13
	-9.8	-11	65.5	24.81	65.5	23.70	65.2	22.81	65.2	21.54	64.9	20.69	60.5	20.21
	-9.5	-10	66.0	24.63	66.0	23.54	65.6	22.65	65.6	21.39	64.9	20.54	60.5	20.07
	-8.5	-9.1	67.5	24.04	67.5	22.99	67.1	22.14	67.1	20.92	64.9	20.08	60.5	19.61
	-7.0	-7.6	70.8	23.16	70.5	22.16	69.3	21.37	67.1	20.21	64.9	19.40	60.5	18.92
	-5.0	-5.6	73.9	21.98	73.2	21.06	69.3	20.34	67.1	19.26	64.9	18.48	60.5	18.00
	-3.0	-3.7	76.1	20.80	73.7	19.95	69.3	19.32	67.1	18.31	64.9	17.57	60.5	17.08
	0.0	-0.7	78.1	19.03	73.7	18.30	69.3	17.77	67.1	16.89	64.9	16.19	60.5	15.70
	3.0	2.2	78.1	17.26	73.7	16.64	69.3	16.23	67.1	15.47	64.9	14.82	60.5	14.32
	5.0	4.1	76.6	14.64	72.2	14.11	67.9	13.80	65.8	13.15	63.6	12.58	59.2	12.13
	7.0	6.0	74.6	13.26	70.4	12.84	66.2	12.62	64.0	12.07	62.0	11.55	57.7	11.11
	9.0	7.9	71.9	11.71	67.8	11.34	63.8	11.14	61.8	10.67	59.7	10.20	55.6	9.81
	11.0	9.8	68.0	10.32	64.2	9.99	60.3	9.82	58.3	9.39	56.5	8.99	52.6	8.64
	13.0	11.8	63.8	8.79	60.3	8.52	56.6	8.37	54.8	8.01	53.0	7.66	49.3	7.36
15.0	13.7	60.5	7.42	57.0	7.19	53.5	7.06	51.9	6.76	50.1	6.47	46.7	6.22	
90	-24.8	-25	43.3	21.23	43.3	21.86	43.1	22.30	43.1	22.50	43.1	22.92	42.5	23.55
	-21.8	-22	52.0	21.86	52.0	22.49	51.8	22.92	51.8	23.13	51.8	23.55	51.0	22.39
	-19.8	-20	54.6	22.28	54.6	22.90	54.2	23.33	54.2	23.55	54.2	22.75	53.5	21.63
	-18.8	-19	55.9	22.49	55.5	23.11	55.3	23.55	55.3	23.13	55.3	22.35	54.5	21.25
	-16.7	-17	58.0	22.92	58.0	23.55	57.7	22.67	57.7	22.26	57.7	21.51	55.2	20.44
	-13.7	-15	61.6	23.55	61.6	22.23	61.1	21.43	60.9	21.01	59.4	20.31	55.2	19.29
	-11.8	-13	63.5	22.63	63.2	21.41	62.9	20.64	61.4	20.23	59.4	19.55	55.2	18.56
	-9.8	-11	65.5	21.68	65.5	20.54	63.4	19.82	61.4	19.39	59.4	18.76	55.2	17.79
	-9.5	-10	66.0	21.53	66.0	20.40	63.4	19.69	61.4	19.26	59.4	18.63	55.2	17.68
	-8.5	-9.1	67.5	21.05	66.9	19.97	63.4	19.27	61.4	18.84	59.4	18.23	55.2	17.29
	-7.0	-7.6	70.8	20.33	67.3	19.31	63.4	18.65	61.4	18.22	59.4	17.63	55.2	16.72
	-5.0	-5.6	71.5	19.37	67.3	18.43	63.4	17.82	61.4	17.40	59.4	16.83	55.2	15.96
	-3.0	-3.7	71.5	18.42	67.3	17.57	63.4	16.99	61.4	16.56	59.4	16.03	55.2	15.18
	0.0	-0.7	71.5	16.98	67.3	16.25	63.4	15.75	61.4	15.32	59.4	14.84	55.2	14.03
	3.0	2.2	71.5	15.53	67.3	14.94	63.4	14.50	61.4	14.07	59.4	13.64	55.2	12.89
	5.0	4.1	70.2	13.22	66.0	12.74	62.1	12.36	60.2	11.98	58.3	11.60	54.1	10.94
	7.0	6.0	68.4	12.12	64.3	11.74	60.5	11.43	58.7	11.04	56.8	10.71	52.8	10.10
	9.0	7.9	65.8	10.70	62.0	10.38	58.3	10.09	56.5	9.75	54.7	9.46	50.8	8.92
	11.0	9.8	62.3	9.34	58.6	9.04	55.2	8.80	53.5	8.50	51.7	8.25	48.0	7.78
	13.0	11.8	58.5	7.80	55.0	7.56	51.8	7.36	50.2	7.10	48.6	6.89	45.1	6.50
15.0	13.7	55.4	6.51	52.1	6.31	49.0	6.14	47.5	5.93	46.0	5.76	42.7	5.43	
80	-24.8	-25	43.2	18.57	43.2	19.19	42.9	19.63	42.9	19.84	42.9	20.88	42.3	19.87
	-21.8	-22	51.5	19.19	51.5	19.82	51.5	20.26	51.5	20.88	51.5	19.87	49.3	18.91
	-19.8	-20	54.0	19.61	54.0	20.23	54.0	20.88	53.7	20.16	52.8	19.19	49.3	18.27
	-18.8	-19	55.1	19.82	55.1	20.88	55.1	20.50	54.4	19.79	53.0	18.85	49.3	17.94
	-16.7	-17	56.7	20.88	56.7	20.10	56.7	19.73	55.0	19.04	53.0	18.14	49.3	17.27
	-13.7	-15	59.3	19.71	58.1	18.98	56.7	18.62	55.0	17.95	53.0	17.13	49.3	16.31
	-11.8	-13	61.0	18.96	59.2	18.27	56.7	17.91	55.0	17.26	53.0	16.49	49.3	15.70
	-9.8	-11	62.6	18.17	60.0	17.52	56.7	17.16	55.0	16.55	53.0	15.81	49.3	15.06
	-9.5	-10	63.0	18.06	60.2	17.41	56.7	17.05	55.0	16.44	53.0	15.71	49.3	14.96
	-8.5	-9.1	63.6	17.67	60.5	17.04	56.7	16.68	55.0	16.08	53.0	15.36	49.3	14.64
	-7.0	-7.6	64.1	17.08	60.5	16.48	56.7	16.12	55.0	15.53	53.0	14.87	49.3	14.16
	-5.0	-5.6	64.1	16.30	60.5	15.74	56.7	15.39	55.0	14.81	53.0	14.18	49.3	13.52
	-3.0	-3.7	64.1	15.51	60.5	14.99	56.7	14.64	55.0	14.09	53.0	13.51	49.3	12.87
	0.0	-0.7	64.1	14.34	60.5	13.87	56.7	13.53	55.0	13.00	53.0	12.49	49.3	11.91
	3.0	2.2	64.1	13.16	60.5	12.75	56.7	12.41	55.0	11.91	53.0	11.48	49.3	10.95
	5.0	4.1	62.9	11.21	59.2	10.86	55.6	10.55	53.9	10.12	51.9	9.76	48.4	9.32
	7.0	6.0	61.2	10.32	57.7	10.02	54.1	9.73	52.6	9.32	50.6	9.01	47.1	8.60
	9.0	7.9	59.0	8.79	55.6	8.55	52.2	8.35	50.6	8.05	48.8	7.76	45.4	7.39
	11.0	9.8	55.7	7.43	52.6	7.23	49.3	7.06	47.9	6.80	46.2	6.55	42.9	6.24
	13.0	11.8	52.4	6.06	49.3	5.90	46.4	5.77	44.9	5.55	43.3	5.35	40.3	5.09
15.0	13.7	49.5	5.06	46.7	4.93	43.8	4.81	42.5	4.63	41.0	4.46	38.1	4.25	

# 7. Capacity Tables

Heating Capacity (22HP)

Combination (%)	Outdoor air temp.		Indoor air temp. °C DB											
			16		18		20		21		22		24	
	°C DB	°C WB	TC	PI	TC	PI	TC	PI	TC	PI	TC	PI	TC	PI
70	-24.8	-25	43.2	18.99	43.2	19.19	42.9	19.61	42.9	20.24	42.9	19.18	42.2	18.18
	-21.8	-22	48.6	19.61	48.6	19.82	48.2	20.24	46.6	19.18	45.3	18.18	42.2	17.23
	-19.8	-20	52.2	20.04	51.3	20.24	48.2	19.49	46.6	18.47	45.3	17.52	42.2	16.61
	-18.8	-19	53.7	20.24	51.3	19.84	48.2	19.11	46.6	18.11	45.3	17.19	42.2	16.29
	-16.7	-17	54.3	19.41	51.3	19.01	48.2	18.32	46.6	17.37	45.3	16.50	42.2	15.63
	-13.7	-15	54.3	18.23	51.3	17.84	48.2	17.18	46.6	16.29	45.3	15.51	42.2	14.68
	-11.8	-13	54.3	17.48	51.3	17.09	48.2	16.47	46.6	15.62	45.3	14.88	42.2	14.08
	-9.8	-11	54.3	16.70	51.3	16.31	48.2	15.71	46.6	14.91	45.3	14.22	42.2	13.45
	-9.5	-10	54.3	16.58	51.3	16.18	48.2	15.60	46.6	14.81	45.3	14.12	42.2	13.36
	-8.5	-9.1	54.3	16.19	51.3	15.79	48.2	15.22	46.6	14.45	45.3	13.79	42.2	13.05
	-7.0	-7.6	54.3	15.60	51.3	15.21	48.2	14.65	46.6	13.92	45.3	13.30	42.2	12.57
	-5.0	-5.6	54.3	14.81	51.3	14.42	48.2	13.90	46.6	13.20	45.3	12.63	42.2	11.94
	-3.0	-3.7	54.3	14.03	51.3	13.63	48.2	13.15	46.6	12.49	45.3	11.97	42.2	11.30
	0.0	-0.7	54.3	12.85	51.3	12.45	48.2	12.01	46.6	11.43	45.3	10.99	42.2	10.36
	3.0	2.2	54.3	11.67	51.3	11.26	48.2	10.88	46.6	10.37	45.3	10.00	42.2	9.41
	5.0	4.1	54.3	10.06	50.3	9.49	47.3	9.16	45.7	8.73	44.4	8.44	41.4	7.95
	7.0	6.0	54.4	9.44	49.0	8.62	46.2	8.34	44.5	7.96	43.2	7.72	40.3	7.26
	9.0	7.9	52.4	7.84	47.3	7.16	44.4	6.92	42.9	6.61	41.6	6.40	38.9	6.03
	11.0	9.8	49.5	6.61	44.7	6.04	42.0	5.84	40.5	5.57	39.4	5.41	36.7	5.08
	13.0	11.8	46.6	5.44	42.0	4.98	39.4	4.81	38.1	4.59	37.0	4.46	34.5	4.19
15.0	13.7	44.0	4.49	39.6	4.10	37.4	3.97	36.1	3.78	35.0	3.67	32.6	3.45	
60	-24.8	-25	41.6	18.57	41.6	18.99	41.4	19.61	40.0	18.52	38.7	17.50	36.1	16.54
	-21.8	-22	44.6	19.19	44.2	19.61	41.4	18.52	40.0	17.50	38.7	16.54	36.1	15.63
	-19.8	-20	46.6	19.61	44.2	18.84	41.4	17.79	40.0	16.82	38.7	15.90	36.1	15.02
	-18.8	-19	46.6	19.22	44.2	18.45	41.4	17.42	40.0	16.47	38.7	15.59	36.1	14.71
	-16.7	-17	46.6	18.39	44.2	17.62	41.4	16.66	40.0	15.76	38.7	14.92	36.1	14.07
	-13.7	-15	46.6	17.19	44.2	16.46	41.4	15.56	40.0	14.74	38.7	13.97	36.1	13.16
	-11.8	-13	46.6	16.44	44.2	15.72	41.4	14.86	40.0	14.09	38.7	13.36	36.1	12.59
	-9.8	-11	46.6	15.64	44.2	14.94	41.4	14.14	40.0	13.41	38.7	12.72	36.1	11.97
	-9.5	-10	46.6	15.52	44.2	14.82	41.4	14.03	40.0	13.30	38.7	12.63	36.1	11.88
	-8.5	-9.1	46.6	15.12	44.2	14.44	41.4	13.66	40.0	12.97	38.7	12.30	36.1	11.58
	-7.0	-7.6	46.6	14.53	44.2	13.85	41.4	13.11	40.0	12.46	38.7	11.83	36.1	11.13
	-5.0	-5.6	46.6	13.73	44.2	13.07	41.4	12.39	40.0	11.78	38.7	11.20	36.1	10.51
	-3.0	-3.7	46.6	12.93	44.2	12.29	41.4	11.65	40.0	11.09	38.7	10.56	36.1	9.90
	0.0	-0.7	46.6	11.74	44.2	11.12	41.4	10.56	40.0	10.07	38.7	9.60	36.1	8.99
	3.0	2.2	46.6	10.55	44.2	9.95	41.4	9.46	40.0	9.05	38.7	8.65	36.1	8.08
	5.0	4.1	45.7	8.85	43.3	8.31	40.5	7.91	39.2	7.58	37.8	7.25	35.4	6.76
	7.0	6.0	44.5	7.97	42.2	7.47	39.6	7.12	38.2	6.85	36.9	6.56	34.5	6.11
	9.0	7.9	42.9	6.55	40.7	6.13	38.1	5.84	36.8	5.62	35.6	5.39	33.2	5.01
	11.0	9.8	40.5	5.52	38.4	5.17	36.0	4.93	34.8	4.74	33.6	4.54	31.5	4.23
	13.0	11.8	38.1	4.55	36.1	4.26	33.8	4.06	32.7	3.91	31.5	3.75	29.5	3.48
15.0	13.7	36.1	3.78	34.1	3.54	32.0	3.34	31.0	3.21	29.9	3.09	27.9	2.90	
50	-24.8	-25	38.9	16.71	36.7	17.33	34.5	16.34	33.4	15.41	32.3	14.54	30.1	13.74
	-21.8	-22	38.9	17.33	36.7	16.34	34.5	15.41	33.4	14.54	32.3	13.74	30.1	12.97
	-19.8	-20	38.9	16.63	36.7	15.67	34.5	14.79	33.4	13.96	32.3	13.20	30.1	12.45
	-18.8	-19	38.9	16.28	36.7	15.34	34.5	14.49	33.4	13.67	32.3	12.93	30.1	12.20
	-16.7	-17	38.9	15.55	36.7	14.65	34.5	13.84	33.4	13.06	32.3	12.36	30.1	11.66
	-13.7	-15	38.9	14.50	36.7	13.64	34.5	12.91	33.4	12.19	32.3	11.55	30.1	10.89
	-11.8	-13	38.9	13.83	36.7	13.01	34.5	12.32	33.4	11.64	32.3	11.05	30.1	10.41
	-9.8	-11	38.9	13.13	36.7	12.35	34.5	11.70	33.4	11.06	32.3	10.51	30.1	9.89
	-9.5	-10	38.9	13.02	36.7	12.25	34.5	11.61	33.4	10.97	32.3	10.44	30.1	9.82
	-8.5	-9.1	38.9	12.66	36.7	11.91	34.5	11.31	33.4	10.69	32.3	10.17	30.1	9.57
	-7.0	-7.6	38.9	12.14	36.7	11.42	34.5	10.84	33.4	10.25	32.3	9.76	30.1	9.18
	-5.0	-5.6	38.9	11.43	36.7	10.76	34.5	10.23	33.4	9.67	32.3	9.22	30.1	8.67
	-3.0	-3.7	38.9	10.73	36.7	10.09	34.5	9.60	33.4	9.09	32.3	8.68	30.1	8.16
	0.0	-0.7	38.9	9.68	36.7	9.09	34.5	8.68	33.4	8.22	32.3	7.88	30.1	7.39
	3.0	2.2	38.9	8.63	36.7	8.10	34.5	7.75	33.4	7.35	32.3	7.07	30.1	6.62
	5.0	4.1	38.1	7.19	35.9	6.73	33.8	6.46	32.7	6.14	31.7	5.91	29.5	5.53
	7.0	6.0	37.2	6.43	35.0	6.02	33.0	5.80	31.9	5.51	30.8	5.34	28.8	4.98
	9.0	7.9	35.8	5.34	33.7	5.00	31.7	4.81	30.8	4.57	29.7	4.43	27.7	4.13
	11.0	9.8	34.1	4.56	32.1	4.26	30.1	4.11	29.0	3.90	28.1	3.78	26.2	3.53
	13.0	11.8	31.7	3.71	30.0	3.47	28.2	3.34	27.3	3.19	26.4	3.08	24.6	2.90
15.0	13.7	30.1	3.10	28.4	2.90	26.6	2.79	25.8	2.66	24.9	2.57	23.3	2.39	

**Note**

1. TC: Total Capacity(kW), PI : Power Input(kW, Comp. + Outdoor fan motor)
2. Capacity tables show the average value of conditions which may occur.
3. The heating capacity table is based on the values expressed as Max. in the specification of the outdoor unit. (When measuring the Max. heating capacity, the setting status of the indoor unit is the same as that for measuring the heating capacity of the indoor unit.)

# 7. Capacity Tables

## ◆ ARUM241LTE5

Heating Capacity (24HP)

Combination (%)	Outdoor air temp.		Indoor air temp. °C DB											
			16		18		20		21		22		24	
	°C DB	°C WB	TC	PI	TC	PI	TC	PI	TC	PI	TC	PI	TC	PI
130	-24.8	-25	47.8	22.9	47.8	23.28	47.6	23.66	47.6	24.22	47.6	24.78	47.4	25.64
	-21.8	-22	56.8	23.72	56.8	24.14	56.4	24.52	56.4	25.08	56.4	25.64	56.2	26.48
	-19.8	-20	59.2	24.28	59.2	24.72	58.8	25.08	58.8	25.66	58.8	26.20	58.6	27.06
	-18.8	-19	60.6	24.58	60.6	25.00	60.2	25.38	60.2	25.94	60.2	26.48	60.0	27.34
	-16.7	-17	63.6	25.18	63.6	25.60	63.2	25.98	63.2	26.54	63.2	27.08	62.8	27.94
	-13.7	-15	67.8	26.04	67.8	26.46	67.4	26.84	67.4	27.40	67.4	27.94	67.0	28.64
	-11.8	-13	70.0	26.58	70.0	27.00	69.6	27.38	69.6	27.94	69.6	28.48	69.2	29.34
	-9.8	-11	72.4	27.14	72.4	27.58	71.8	27.94	71.8	28.48	71.8	29.02	71.4	29.84
	-9.5	-10	72.8	27.24	72.8	27.66	72.4	28.04	72.4	28.58	72.4	29.12	72.0	29.94
	-8.5	-9.1	74.6	27.52	74.6	27.94	74.2	28.32	74.2	28.86	74.2	29.40	73.8	30.24
	-7.0	-7.6	77.4	27.94	77.4	28.36	76.8	28.74	76.8	29.28	76.8	29.82	76.4	30.64
	-5.0	-5.6	81.0	28.90	81.0	29.34	80.4	29.72	80.4	30.24	80.4	30.82	80.0	31.64
	-3.0	-3.7	84.6	29.86	84.6	30.30	84.0	30.68	84.0	31.12	84.0	31.70	83.6	32.44
	0.0	-0.7	89.8	30.82	89.8	31.26	89.4	31.64	89.4	32.06	89.4	32.58	89.0	33.24
	3.0	2.2	95.2	31.78	95.2	31.80	94.6	32.18	94.6	32.58	94.6	33.06	94.2	33.64
	5.0	4.1	96.0	31.98	96.0	32.00	95.4	32.38	95.4	32.86	95.4	33.34	95.0	33.84
	7.0	6.0	93.6	31.30	93.6	31.72	93.0	32.10	93.0	32.58	93.0	33.06	92.6	33.44
	9.0	7.9	90.0	30.70	90.0	31.16	89.6	31.58	89.6	32.06	89.6	32.54	89.2	33.04
11.0	9.8	85.2	30.28	85.2	30.80	84.8	31.16	84.8	31.64	84.8	32.12	84.4	32.64	
13.0	11.8	80.0	29.82	80.0	30.34	79.6	30.72	79.6	31.18	79.6	31.58	79.2	32.18	
15.0	13.7	75.6	29.36	75.6	29.88	75.2	30.26	75.2	30.70	75.2	31.12	74.8	31.68	
120	-24.8	-25	47.6	23.28	47.6	23.66	47.2	24.22	47.2	24.78	47.2	25.64	47.0	26.24
	-21.8	-22	56.4	24.14	56.4	24.52	56.0	25.08	56.0	25.64	56.0	26.48	55.8	27.08
	-19.8	-20	58.8	24.72	58.8	25.08	58.4	25.66	58.4	26.20	58.4	27.06	58.2	27.66
	-18.8	-19	60.2	25.00	60.2	25.38	59.8	25.94	59.8	26.48	59.8	27.34	59.6	27.94
	-16.7	-17	63.2	25.60	63.2	25.98	62.8	26.54	62.8	27.08	62.8	27.94	62.4	28.54
	-13.7	-15	67.2	26.46	67.2	26.84	66.8	27.40	66.8	27.94	66.8	28.48	66.4	29.04
	-11.8	-13	69.4	27.00	69.4	27.38	69.0	27.94	69.0	28.48	69.0	29.02	68.6	29.62
	-9.8	-11	71.8	27.58	71.8	27.94	71.4	28.48	71.4	29.02	71.4	29.58	71.0	30.18
	-9.5	-10	72.4	27.66	72.4	27.78	72.0	28.16	72.0	28.70	72.0	29.24	71.6	29.78
	-8.5	-9.1	74.2	27.94	74.2	28.32	73.6	28.86	73.6	29.40	73.6	29.98	73.2	30.38
	-7.0	-7.6	76.8	28.36	76.8	28.74	76.4	29.28	76.4	29.82	76.4	30.36	76.0	30.94
	-5.0	-5.6	80.4	29.30	80.4	29.72	79.8	30.14	79.8	30.68	79.8	31.22	79.4	31.82
	-3.0	-3.7	84.0	29.86	84.0	30.30	83.4	30.74	83.4	31.28	83.4	31.86	83.0	32.42
	0.0	-0.7	89.2	30.82	89.2	31.26	88.6	31.64	88.6	32.12	88.6	32.58	88.2	33.02
	3.0	2.2	94.6	31.78	94.6	31.80	92.2	32.18	89.0	32.58	86.2	33.06	83.0	33.64
	5.0	4.1	95.2	31.98	94.0	32.00	90.2	32.38	87.2	32.86	84.6	33.34	82.0	33.84
	7.0	6.0	92.8	31.30	91.6	31.72	88.0	32.10	85.0	32.58	82.4	33.06	80.0	33.44
	9.0	7.9	89.4	30.70	88.2	31.16	84.8	31.58	82.0	32.06	79.4	32.54	77.0	33.04
11.0	9.8	84.6	30.28	83.4	30.80	80.2	31.16	77.4	31.64	75.0	32.12	73.0	32.64	
13.0	11.8	79.4	29.82	78.4	30.34	75.2	30.72	72.8	31.18	70.6	31.58	68.6	32.18	
15.0	13.7	75.2	29.36	74.2	29.88	71.2	30.26	68.8	30.70	66.8	31.12	64.8	31.68	
110	-24.8	-25	47.2	23.66	47.2	24.22	47.0	24.78	47.0	25.64	47.0	26.24	46.8	26.84
	-21.8	-22	56.2	24.52	56.2	25.08	55.8	25.64	55.8	26.48	55.8	27.08	55.6	27.68
	-19.8	-20	58.4	25.08	58.4	25.66	58.2	26.20	58.2	27.06	58.2	27.66	58.0	28.26
	-18.8	-19	59.8	25.38	59.8	25.94	59.4	26.48	59.4	27.34	59.4	27.94	59.2	28.54
	-16.7	-17	62.8	25.98	62.8	26.54	62.4	27.08	62.4	27.94	62.4	28.54	62.0	29.14
	-13.7	-15	67.0	26.84	67.0	27.40	66.4	27.94	66.4	28.48	66.4	29.06	66.0	29.66
	-11.8	-13	69.2	27.38	69.2	27.94	68.6	28.48	68.6	29.02	68.6	29.58	68.2	30.18
	-9.8	-11	71.4	27.94	71.4	28.48	71.0	29.02	71.0	29.58	71.0	30.12	70.6	30.78
	-9.5	-10	72.0	27.76	72.0	28.68	71.6	29.22	71.6	29.76	71.6	30.30	71.2	30.90
	-8.5	-9.1	73.8	28.18	73.8	28.64	73.2	29.10	73.2	29.64	73.2	30.18	72.8	30.78
	-7.0	-7.6	76.4	28.60	76.4	29.06	76.0	29.50	76.0	30.04	76.0	30.52	75.6	31.14
	-5.0	-5.6	80.0	29.54	80.0	29.96	79.4	30.38	79.4	30.86	79.4	31.34	79.0	31.74
	-3.0	-3.7	83.4	30.50	83.4	30.92	82.6	31.30	82.0	31.78	82.0	32.26	81.6	32.74
	0.0	-0.7	88.8	31.46	88.0	31.88	86.6	32.26	84.6	32.74	82.6	33.20	80.6	33.64
	3.0	2.2	93.2	32.42	88.0	32.84	86.6	33.20	84.6	33.64	82.6	34.08	80.6	34.52
	5.0	4.1	91.4	31.86	86.4	32.32	84.6	32.66	82.6	33.10	80.6	33.54	78.6	34.02
	7.0	6.0	89.0	31.26	84.2	31.74	82.0	32.14	80.0	32.58	78.0	32.98	76.0	33.42
	9.0	7.9	85.8	30.66	81.0	31.14	78.0	31.54	76.0	31.98	74.0	32.42	72.0	32.92
11.0	9.8	81.0	30.14	76.6	30.62	72.0	31.02	69.6	31.46	67.2	31.90	65.2	32.34	
13.0	11.8	76.2	29.62	72.0	30.50	67.6	30.46	65.4	30.90	63.2	31.34	61.0	31.76	
15.0	13.7	72.0	29.10	68.0	30.02	64.0	30.00	61.8	30.38	59.8	30.76	57.4	31.18	

# 7. Capacity Tables

Heating Capacity (24HP)

Combination (%)	Outdoor air temp.		Indoor air temp. °C DB											
			16		18		20		21		22		24	
	°C DB	°C WB	TC	PI	TC	PI	TC	PI	TC	PI	TC	PI	TC	PI
100	-24.8	-25	47.0	26.68	47.0	26.84	46.8	25.86	46.8	27.26	46.8	27.44	46.6	27.52
	-21.8	-22	55.8	26.94	55.8	27.10	55.6	26.68	55.6	27.52	55.6	28.12	55.2	27.78
	-19.8	-20	58.2	27.10	58.2	27.26	57.8	27.22	57.8	27.68	57.8	28.00	57.6	27.94
	-18.8	-19	59.6	27.18	59.2	27.36	59.2	27.52	59.2	27.76	59.2	27.94	59.0	27.44
	-16.7	-17	62.2	27.36	62.2	27.54	62.2	28.12	61.8	27.94	61.8	26.90	61.4	26.40
	-13.7	-15	66.6	27.62	66.6	27.78	66.2	27.94	66.2	26.42	66.2	25.42	66.0	24.90
	-11.8	-13	68.8	27.78	68.4	27.94	68.4	26.90	68.4	25.44	68.4	24.46	66.0	23.94
	-9.8	-11	71.0	27.94	71.0	26.76	70.8	25.80	70.8	24.42	70.8	23.48	66.0	22.94
	-9.5	-10	71.6	27.76	71.6	26.58	71.2	25.62	71.2	24.26	70.8	23.32	66.0	22.80
	-8.5	-9.1	73.4	27.12	73.4	26.00	73.0	25.08	73.2	23.74	70.8	22.82	66.0	22.30
	-7.0	-7.6	77.2	26.18	77.0	25.10	75.6	24.24	73.2	22.98	70.8	22.08	66.0	21.54
	-5.0	-5.6	80.6	24.92	79.8	23.92	75.6	23.14	73.2	21.96	70.8	21.08	66.0	20.54
	-3.0	-3.7	83.0	23.66	80.4	22.74	75.6	22.04	73.2	20.92	70.8	20.10	66.0	19.54
	0.0	-0.7	85.2	21.78	80.4	20.96	75.6	20.38	73.2	19.40	70.8	18.60	66.0	18.04
	3.0	2.2	85.2	19.88	80.4	19.18	75.6	18.72	73.2	17.86	70.8	17.12	66.0	16.54
	5.0	4.1	83.6	16.94	78.8	16.34	74.0	15.98	71.8	15.24	69.4	14.58	64.6	14.06
	7.0	6.0	81.4	15.44	76.8	14.96	72.2	14.70	69.8	14.06	67.6	13.46	63.0	12.94
	9.0	7.9	78.4	13.84	74.0	13.40	69.6	13.16	67.4	12.60	65.2	12.04	60.6	11.58
	11.0	9.8	74.2	12.40	70.0	12.00	65.8	11.80	63.6	11.28	61.6	10.80	57.4	10.38
	13.0	11.8	69.6	10.80	65.8	10.46	61.8	10.28	59.8	9.84	57.8	9.40	53.8	9.04
15.0	13.7	66.0	9.38	62.2	9.08	58.4	8.92	56.6	8.54	54.6	8.18	51.0	7.86	
90	-24.8	-25	46.8	23.48	46.8	24.34	46.6	24.94	46.6	25.22	46.6	25.80	46.4	26.66
	-21.8	-22	55.6	24.34	55.6	25.20	55.4	25.80	55.4	26.08	55.4	26.66	55.0	25.38
	-19.8	-20	58.0	24.92	58.0	25.76	57.6	26.36	57.6	26.66	57.6	25.78	57.4	24.54
	-18.8	-19	59.6	25.20	59.2	26.06	59.0	26.66	59.0	26.20	59.0	25.34	58.8	24.12
	-16.7	-17	62.2	25.80	62.2	26.66	61.8	25.70	61.8	25.24	61.8	24.42	60.2	23.24
	-13.7	-15	66.6	26.66	66.6	25.22	66.0	24.34	66.0	23.88	64.8	23.10	60.2	21.96
	-11.8	-13	68.8	25.66	68.4	24.32	68.2	23.48	67.0	23.02	64.8	22.26	60.2	21.16
	-9.8	-11	71.0	24.62	71.0	23.38	69.2	22.58	67.0	22.10	64.8	21.40	60.2	20.32
	-9.5	-10	71.6	24.46	71.6	23.22	69.2	22.44	67.0	21.96	64.8	21.26	60.2	20.20
	-8.5	-9.1	73.4	23.94	72.8	22.76	69.2	21.98	67.0	21.50	64.8	20.82	60.2	19.76
	-7.0	-7.6	77.2	23.16	73.4	22.04	69.2	21.30	67.0	20.82	64.8	20.16	60.2	19.14
	-5.0	-5.6	78.0	22.12	73.4	21.08	69.2	20.40	67.0	19.92	64.8	19.28	60.2	18.30
	-3.0	-3.7	78.0	21.08	73.4	20.14	69.2	19.50	67.0	19.00	64.8	18.40	60.2	17.44
	0.0	-0.7	78.0	19.52	73.4	18.70	69.2	18.14	67.0	17.64	64.8	17.10	60.2	16.18
	3.0	2.2	78.0	17.94	73.4	17.28	69.2	16.78	67.0	16.28	64.8	15.78	60.2	14.92
	5.0	4.1	76.6	15.32	72.0	14.78	67.8	14.34	65.6	13.90	63.6	13.46	59.0	12.70
	7.0	6.0	74.6	14.12	70.2	13.68	66.0	13.32	64.0	12.86	62.0	12.48	57.6	11.76
	9.0	7.9	71.8	12.64	67.6	12.26	63.6	11.92	61.6	11.52	59.6	11.18	55.4	10.54
	11.0	9.8	68.0	11.22	64.0	10.86	60.2	10.58	58.4	10.22	56.4	9.92	52.4	9.34
	13.0	11.8	63.8	9.58	60.0	9.28	56.6	9.04	54.8	8.72	53.0	8.46	49.2	7.98
15.0	13.7	60.4	8.22	56.8	7.98	53.4	7.76	51.8	7.50	50.2	7.28	46.6	6.86	
80	-24.8	-25	46.6	20.46	46.6	21.32	46.4	21.92	46.4	22.20	46.4	23.64	46.2	22.52
	-21.8	-22	55.0	21.32	55.0	22.18	55.0	22.78	55.0	23.64	55.0	22.52	53.8	21.46
	-19.8	-20	57.4	21.90	57.4	22.74	57.4	23.64	57.4	22.84	57.4	21.78	53.8	20.76
	-18.8	-19	58.8	22.18	58.8	23.64	58.8	23.22	58.8	22.44	57.8	21.40	53.8	20.40
	-16.7	-17	61.8	23.64	61.8	22.78	61.8	22.38	60.0	21.62	57.8	20.62	53.8	19.66
	-13.7	-15	64.6	22.36	63.4	21.56	61.8	21.16	60.0	20.42	57.8	19.50	53.8	18.60
	-11.8	-13	66.4	21.54	64.4	20.78	61.8	20.38	60.0	19.66	57.8	18.80	53.8	17.92
	-9.8	-11	68.2	20.68	65.4	19.96	61.8	19.56	60.0	18.88	57.8	18.06	53.8	17.22
	-9.5	-10	68.6	20.56	65.6	19.84	61.8	19.44	60.0	18.76	57.8	17.94	53.8	17.10
	-8.5	-9.1	69.4	20.14	66.0	19.44	61.8	19.04	60.0	18.36	57.8	17.56	53.8	16.76
	-7.0	-7.6	70.0	19.50	66.0	18.82	61.8	18.42	60.0	17.76	57.8	17.02	53.8	16.22
	-5.0	-5.6	70.0	18.64	66.0	18.02	61.8	17.62	60.0	16.96	57.8	16.26	53.8	15.52
	-3.0	-3.7	70.0	17.78	66.0	17.20	61.8	16.80	60.0	16.18	57.8	15.52	53.8	14.80
	0.0	-0.7	70.0	16.50	66.0	15.98	61.8	15.58	60.0	14.98	57.8	14.40	53.8	13.74
	3.0	2.2	70.0	15.22	66.0	14.74	61.8	14.36	60.0	13.78	57.8	13.28	53.8	12.68
	5.0	4.1	68.6	13.00	64.6	12.60	60.6	12.24	58.8	11.74	56.6	11.32	52.8	10.82
	7.0	6.0	66.8	12.02	63.0	11.68	59.0	11.34	57.4	10.86	55.2	10.50	51.4	10.02
	9.0	7.9	64.4	10.40	60.6	10.12	57.0	9.88	55.2	9.52	53.2	9.18	49.6	8.74
	11.0	9.8	60.8	8.94	57.4	8.70	53.8	8.50	52.2	8.18	50.4	7.88	46.8	7.50
	13.0	11.8	57.2	7.46	53.8	7.26	50.6	7.10	49.0	6.82	47.2	6.58	44.0	6.26
15.0	13.7	54.0	6.40	51.0	6.24	47.8	6.08	46.4	5.86	44.8	5.64	41.6	5.38	

# 7. Capacity Tables

Heating Capacity (24HP)

Combination (%)	Outdoor air temp.		Indoor air temp. °C DB													
			16		18		20		21		22		24			
	°C DB	°C WB	TC	PI	TC	PI	TC	PI	TC	PI	TC	PI	TC	PI		
70	-24.8	-25	46.6	21.06	46.6	21.34	46.4	21.92	46.4	22.78	46.4	21.62	46.4	21.62	46.0	20.52
	-21.8	-22	53.0	21.92	53.0	22.20	52.6	22.78	50.8	21.62	49.4	20.52	46.0	19.48	46.0	19.48
	-19.8	-20	57.2	22.50	56.0	22.78	52.6	21.96	50.8	20.84	49.4	19.80	46.0	18.80	46.0	18.80
	-18.8	-19	58.8	22.78	56.0	22.34	52.6	21.54	50.8	20.44	49.4	19.44	46.0	18.44	46.0	18.44
	-16.7	-17	59.2	21.88	56.0	21.44	52.6	20.68	50.8	19.64	49.4	18.68	46.0	17.72	46.0	17.72
	-13.7	-15	59.2	20.60	56.0	20.16	52.6	19.44	50.8	18.46	49.4	17.60	46.0	16.68	46.0	16.68
	-11.8	-13	59.2	19.78	56.0	19.34	52.6	18.66	50.8	17.72	49.4	16.90	46.0	16.02	46.0	16.02
	-9.8	-11	59.2	18.94	56.0	18.50	52.6	17.84	50.8	16.94	49.4	16.18	46.0	15.32	46.0	15.32
	-9.5	-10	59.2	18.80	56.0	18.36	52.6	17.72	50.8	16.84	49.4	16.08	46.0	15.22	46.0	15.22
	-8.5	-9.1	59.2	18.38	56.0	17.94	52.6	17.30	50.8	16.44	49.4	15.72	46.0	14.88	46.0	14.88
	-7.0	-7.6	59.2	17.74	56.0	17.30	52.6	16.68	50.8	15.86	49.4	15.18	46.0	14.36	46.0	14.36
	-5.0	-5.6	59.2	16.88	56.0	16.44	52.6	15.86	50.8	15.08	49.4	14.44	46.0	13.66	46.0	13.66
	-3.0	-3.7	59.2	16.04	56.0	15.58	52.6	15.04	50.8	14.30	49.4	13.72	46.0	12.96	46.0	12.96
	0.0	-0.7	59.2	14.76	56.0	14.30	52.6	13.80	50.8	13.14	49.4	12.64	46.0	11.92	46.0	11.92
	3.0	2.2	59.2	13.48	56.0	13.00	52.6	12.56	50.8	11.98	49.4	11.56	46.0	10.88	46.0	10.88
	5.0	4.1	59.2	11.66	54.8	11.00	51.6	10.62	49.8	10.12	48.4	9.78	45.2	9.22	45.2	9.22
	7.0	6.0	59.4	11.00	53.4	10.04	50.4	9.72	48.6	9.28	47.2	9.00	44.0	8.46	44.0	8.46
	9.0	7.9	57.2	9.26	51.6	8.46	48.4	8.18	46.8	7.80	45.4	7.56	42.4	7.12	42.4	7.12
	11.0	9.8	54.0	7.94	48.8	7.26	45.8	7.02	44.2	6.70	43.0	6.50	40.0	6.10	40.0	6.10
	13.0	11.8	50.8	6.68	45.8	6.12	43.0	5.90	41.6	5.64	40.4	5.48	37.6	5.14	37.6	5.14
15.0	13.7	48.0	5.68	43.2	5.18	40.8	5.02	39.4	4.78	38.2	4.64	35.6	4.36	35.6	4.36	
60	-24.8	-25	45.4	20.48	45.4	21.06	45.2	21.92	43.6	20.74	42.2	19.62	39.4	18.58	39.4	18.58
	-21.8	-22	48.6	21.34	48.2	21.92	45.2	20.74	43.6	19.62	42.2	18.58	39.4	17.58	39.4	17.58
	-19.8	-20	50.8	21.92	48.2	21.08	45.2	19.94	43.6	18.88	42.2	17.88	39.4	16.92	39.4	16.92
	-18.8	-19	50.8	21.50	48.2	20.66	45.2	19.54	43.6	18.50	42.2	17.54	39.4	16.58	39.4	16.58
	-16.7	-17	50.8	20.60	48.2	19.76	45.2	18.72	43.6	17.74	42.2	16.82	39.4	15.88	39.4	15.88
	-13.7	-15	50.8	19.30	48.2	18.50	45.2	17.52	43.6	16.62	42.2	15.78	39.4	14.88	39.4	14.88
	-11.8	-13	50.8	18.50	48.2	17.70	45.2	16.76	43.6	15.92	42.2	15.12	39.4	14.26	39.4	14.26
	-9.8	-11	50.8	17.64	48.2	16.86	45.2	15.98	43.6	15.18	42.2	14.42	39.4	13.58	39.4	13.58
	-9.5	-10	50.8	17.50	48.2	16.74	45.2	15.86	43.6	15.06	42.2	14.32	39.4	13.48	39.4	13.48
	-8.5	-9.1	50.8	17.08	48.2	16.32	45.2	15.46	43.6	14.70	42.2	13.96	39.4	13.16	39.4	13.16
	-7.0	-7.6	50.8	16.44	48.2	15.68	45.2	14.86	43.6	14.14	42.2	13.44	39.4	12.66	39.4	12.66
	-5.0	-5.6	50.8	15.58	48.2	14.84	45.2	14.08	43.6	13.40	42.2	12.76	39.4	11.98	39.4	11.98
	-3.0	-3.7	50.8	14.72	48.2	14.00	45.2	13.28	43.6	12.66	42.2	12.06	39.4	11.32	39.4	11.32
	0.0	-0.7	50.8	13.44	48.2	12.72	45.2	12.10	43.6	11.54	42.2	11.02	39.4	10.32	39.4	10.32
	3.0	2.2	50.8	12.16	48.2	11.46	45.2	10.90	43.6	10.44	42.2	9.98	39.4	9.32	39.4	9.32
	5.0	4.1	49.8	10.24	47.2	9.62	44.2	9.16	42.8	8.78	41.2	8.40	38.6	7.84	38.6	7.84
	7.0	6.0	48.6	9.28	46.0	8.70	43.2	8.30	41.6	7.98	40.2	7.64	37.6	7.12	37.6	7.12
	9.0	7.9	46.8	7.74	44.4	7.24	41.6	6.90	40.2	6.64	38.8	6.36	36.2	5.92	36.2	5.92
	11.0	9.8	44.2	6.64	41.8	6.22	39.2	5.92	38.0	5.70	36.6	5.46	34.4	5.08	34.4	5.08
	13.0	11.8	41.6	5.58	39.4	5.24	36.8	4.98	35.6	4.80	34.4	4.60	32.2	4.28	32.2	4.28
15.0	13.7	39.4	4.78	37.2	4.48	35.0	4.22	33.8	4.06	32.6	3.90	30.4	3.66	30.4	3.66	
50	-24.8	-25	42.4	18.76	40.0	19.62	37.6	18.52	36.4	17.48	35.2	16.52	32.8	15.62	32.8	15.62
	-21.8	-22	42.4	19.62	40.0	18.52	37.6	17.48	36.4	16.52	35.2	15.62	32.8	14.76	32.8	14.76
	-19.8	-20	42.4	18.84	40.0	17.78	37.6	16.80	36.4	15.86	35.2	15.02	32.8	14.18	32.8	14.18
	-18.8	-19	42.4	18.46	40.0	17.40	37.6	16.46	36.4	15.54	35.2	14.72	32.8	13.90	32.8	13.90
	-16.7	-17	42.4	17.64	40.0	16.64	37.6	15.74	36.4	14.86	35.2	14.08	32.8	13.30	32.8	13.30
	-13.7	-15	42.4	16.48	40.0	15.52	37.6	14.70	36.4	13.90	35.2	13.18	32.8	12.44	32.8	12.44
	-11.8	-13	42.4	15.74	40.0	14.82	37.6	14.04	36.4	13.28	35.2	12.62	32.8	11.90	32.8	11.90
	-9.8	-11	42.4	14.96	40.0	14.08	37.6	13.36	36.4	12.64	35.2	12.02	32.8	11.32	32.8	11.32
	-9.5	-10	42.4	14.84	40.0	13.98	37.6	13.26	36.4	12.54	35.2	11.94	32.8	11.24	32.8	11.24
	-8.5	-9.1	42.4	14.44	40.0	13.60	37.6	12.92	36.4	12.22	35.2	11.64	32.8	10.96	32.8	10.96
	-7.0	-7.6	42.4	13.86	40.0	13.06	37.6	12.40	36.4	11.74	35.2	11.18	32.8	10.52	32.8	10.52
	-5.0	-5.6	42.4	13.08	40.0	12.32	37.6	11.72	36.4	11.08	35.2	10.58	32.8	9.96	32.8	9.96
	-3.0	-3.7	42.4	12.30	40.0	11.58	37.6	11.02	36.4	10.44	35.2	9.98	32.8	9.38	32.8	9.38
	0.0	-0.7	42.4	11.14	40.0	10.46	37.6	10.00	36.4	9.48	35.2	9.08	32.8	8.52	32.8	8.52
	3.0	2.2	42.4	9.98	40.0	9.36	37.6	8.96	36.4	8.50	35.2	8.18	32.8	7.66	32.8	7.66
	5.0	4.1	41.6	8.34	39.2	7.80	36.8	7.50	35.6	7.12	34.6	6.86	32.2	6.42	32.2	6.42
	7.0	6.0	40.6	7.50	38.2	7.02	36.0	6.76	34.8	6.42	33.6	6.22	31.4	5.80	31.4	5.80
	9.0	7.9	39.0	6.30	36.8	5.90	34.6	5.68	33.6	5.40	32.4	5.24	30.2	4.88	30.2	4.88
	11.0	9.8	37.2	5.48	35.0	5.12	32.8	4.94	31.6	4.68	30.6	4.54	28.6	4.24	28.6	4.24
	13.0	11.8	34.6	4.56	32.8	4.26	30.8	4.10	29.8	3.92	28.8	3.78	26.8	3.56	26.8	3.56
15.0	13.7	32.8	3.92	31.0	3.66	29.0	3.52	28.2	3.36	27.2	3.24	25.4	3.02	25.4	3.02	

**Note**

1. TC: Total Capacity(kW), PI : Power Input(kW, Comp. + Outdoor fan motor)
2. Capacity tables show the average value of conditions which may occur.
3. The heating capacity table is based on the values expressed as Max. in the specification of the outdoor unit. (When measuring the Max. heating capacity, the setting status of the indoor unit is the same as that for measuring the heating capacity of the indoor unit.)

# 7. Capacity Tables

## ◆ ARUM261LTE5

Heating Capacity (26HP)

Combination (%)	Outdoor air temp.		Indoor air temp. °C DB											
			16		18		20		21		22		24	
	°C DB	°C WB	TC	PI	TC	PI	TC	PI	TC	PI	TC	PI	TC	PI
130	-24.8	-25	51.2	24.5	51.2	24.84	51.0	25.15	51.0	25.61	51.0	26.06	50.3	26.76
	-21.8	-22	61.7	25.20	61.7	25.54	61.2	25.85	61.2	26.31	61.2	26.76	60.5	27.45
	-19.8	-20	64.7	25.66	64.7	26.01	64.3	26.31	64.3	26.78	64.3	27.22	63.5	27.92
	-18.8	-19	66.2	25.90	66.2	26.24	65.8	26.55	65.8	27.01	65.8	27.45	65.0	28.15
	-16.7	-17	69.5	26.39	69.5	26.73	69.0	27.04	69.0	27.50	69.0	27.94	68.1	28.64
	-13.7	-15	74.0	27.09	74.0	27.43	73.6	27.74	73.6	28.20	73.6	28.64	72.6	27.45
	-11.8	-13	76.4	27.53	76.4	27.87	76.0	28.18	76.0	28.64	76.0	27.84	75.4	26.70
	-9.8	-11	79.0	27.99	79.0	28.34	78.4	28.64	78.4	27.78	78.4	26.99	78.1	25.91
	-9.5	-10	79.5	28.07	79.5	28.41	79.0	28.51	79.0	27.64	78.9	26.86	78.6	25.78
	-8.5	-9.1	81.2	28.30	81.2	28.64	80.7	28.06	80.7	27.20	80.1	26.43	80.0	25.38
	-7.0	-7.6	83.8	28.64	83.8	27.97	83.2	27.38	83.2	26.54	83.2	25.79	82.7	24.79
	-5.0	-5.6	87.3	27.75	87.3	27.07	86.7	26.47	86.7	25.67	86.7	24.94	85.6	23.99
	-3.0	-3.7	90.7	26.86	90.7	26.17	90.1	25.57	90.1	24.79	90.1	24.09	88.6	23.20
	0.0	-0.7	95.8	25.52	95.8	24.82	95.3	24.21	95.3	23.48	95.3	22.80	92.5	22.01
	3.0	2.2	101.0	24.18	101.0	23.47	100.3	22.85	100.3	22.17	98.8	21.52	92.5	20.81
	5.0	4.1	102.0	21.17	101.8	20.49	101.3	19.90	100.1	19.29	97.3	18.70	90.6	18.09
	7.0	6.0	101.0	19.92	100.8	19.28	100.3	18.72	98.3	18.18	94.9	17.63	88.3	17.11
	9.0	7.9	97.5	18.39	97.3	17.80	97.1	17.28	94.7	16.77	91.4	16.28	85.1	15.79
	11.0	9.8	92.3	17.08	92.1	16.53	91.8	16.05	89.5	15.58	86.4	15.12	80.4	14.66
	13.0	11.8	86.7	15.54	86.5	15.04	86.2	14.60	84.1	14.18	81.2	13.76	75.6	13.34
15.0	13.7	81.9	14.22	81.9	13.76	81.5	13.37	79.5	12.98	76.7	12.60	71.5	12.21	
120	-24.8	-25	50.9	24.84	50.9	25.15	50.6	25.61	50.6	26.06	50.6	26.76	49.9	27.25
	-21.8	-22	61.2	25.54	61.2	25.85	60.8	26.31	60.8	26.76	60.8	27.45	60.1	27.94
	-19.8	-20	64.2	26.01	64.2	26.31	63.8	26.78	63.8	27.22	63.8	27.92	63.0	28.41
	-18.8	-19	65.8	26.24	65.8	26.55	65.3	27.01	65.3	27.45	65.3	28.15	64.5	28.64
	-16.7	-17	69.0	26.73	69.0	27.04	68.6	27.50	68.6	27.94	68.6	28.64	67.6	27.88
	-13.7	-15	73.4	27.43	73.4	27.74	73.0	28.20	73.0	28.64	73.0	27.49	72.1	26.78
	-11.8	-13	75.8	27.87	75.8	28.18	75.4	28.64	75.4	27.82	75.4	26.76	74.8	26.09
	-9.8	-11	78.4	28.34	78.4	28.64	77.9	27.74	77.9	26.97	77.9	26.00	77.6	25.36
	-9.5	-10	79.0	28.41	79.0	28.50	78.5	27.61	78.5	26.84	78.5	25.89	78.2	25.25
	-8.5	-9.1	80.7	28.64	80.7	28.02	80.1	27.15	80.1	26.41	80.1	25.50	79.8	24.88
	-7.0	-7.6	83.2	27.92	83.2	27.30	82.7	26.48	82.7	25.77	82.5	24.93	82.1	24.33
	-5.0	-5.6	86.6	26.95	86.6	26.33	86.0	25.57	86.0	24.90	86.0	24.16	85.1	23.60
	-3.0	-3.7	90.1	25.98	90.1	25.37	89.5	24.66	89.5	24.05	89.5	23.39	86.9	22.87
	0.0	-0.7	95.1	24.52	95.1	23.92	94.5	23.31	94.5	22.76	93.3	22.25	86.9	21.77
	3.0	2.2	100.3	23.05	100.3	22.47	98.7	21.95	96.5	21.47	93.4	21.10	86.9	20.68
	5.0	4.1	101.3	20.06	100.5	19.51	97.8	19.06	94.5	18.65	91.6	18.36	85.1	18.00
	7.0	6.0	100.3	18.79	99.2	18.28	95.3	17.92	92.1	17.58	89.3	17.41	83.0	17.11
	9.0	7.9	96.9	17.30	95.6	16.84	91.8	16.51	88.8	16.18	86.0	16.03	79.9	15.74
	11.0	9.8	91.6	16.03	90.4	15.59	86.9	15.29	83.9	14.99	81.3	14.86	75.6	14.59
	13.0	11.8	86.0	14.54	84.9	14.14	81.5	13.87	78.8	13.60	76.4	13.48	70.9	13.23
15.0	13.7	81.4	13.27	80.3	12.90	77.1	12.65	74.6	12.41	72.3	12.30	67.1	12.07	
110	-24.8	-25	50.6	25.15	50.6	25.61	50.3	26.06	50.3	26.76	50.3	27.25	49.7	27.48
	-21.8	-22	60.9	25.85	60.9	26.31	60.5	26.76	60.5	27.45	60.5	27.94	59.8	28.18
	-19.8	-20	63.9	26.31	63.9	26.78	63.5	27.22	63.5	27.92	63.5	28.41	62.7	28.64
	-18.8	-19	65.4	26.55	65.4	27.01	64.9	27.45	64.9	28.15	64.9	28.64	64.2	28.25
	-16.7	-17	68.6	27.04	68.6	27.50	68.2	27.94	68.2	28.64	68.2	27.82	67.2	27.41
	-13.7	-15	73.1	27.74	73.1	28.20	72.6	28.64	72.6	27.40	72.6	26.64	72.6	26.21
	-11.8	-13	75.5	28.18	75.5	28.64	75.0	27.76	75.0	26.61	75.0	25.90	75.0	25.46
	-9.8	-11	78.0	28.64	78.0	27.65	77.5	26.83	77.5	25.77	77.5	25.12	77.5	24.66
	-9.5	-10	78.5	28.48	78.5	27.49	78.1	26.69	78.1	25.65	78.1	25.00	77.9	24.53
	-8.5	-9.1	80.2	27.94	80.2	26.99	79.7	26.23	79.7	25.23	79.7	24.60	78.2	24.14
	-7.0	-7.6	82.8	27.12	82.8	26.24	82.3	25.53	82.3	24.60	82.3	24.02	78.2	23.54
	-5.0	-5.6	86.2	26.03	86.2	25.23	85.6	24.59	85.6	23.77	83.7	23.23	78.2	22.74
	-3.0	-3.7	89.5	24.95	89.5	24.24	88.8	23.66	86.6	22.94	83.7	22.45	78.2	21.95
	0.0	-0.7	94.7	23.32	94.3	22.73	89.5	22.26	86.6	21.68	83.7	21.28	78.2	20.76
	3.0	2.2	99.3	21.69	95.4	21.22	89.5	20.86	86.6	20.44	83.7	20.10	78.2	19.56
	5.0	4.1	98.9	18.71	93.6	18.33	87.8	18.05	84.9	17.72	82.1	17.43	76.6	16.93
	7.0	6.0	96.4	17.37	91.2	17.11	85.6	16.91	82.7	16.71	79.9	16.50	74.7	15.98
	9.0	7.9	92.9	15.91	87.8	15.67	82.4	15.50	79.7	15.31	77.0	15.12	71.9	14.65
	11.0	9.8	87.8	14.66	83.0	14.44	78.0	14.27	75.4	14.11	72.8	13.93	68.0	13.49
	13.0	11.8	82.5	13.21	78.0	13.01	73.2	12.86	70.8	12.70	68.4	12.54	63.9	12.16
15.0	13.7	78.0	11.95	73.7	11.78	69.3	11.65	67.0	11.51	64.7	11.35	60.4	11.00	



# 7. Capacity Tables

Heating Capacity (26HP)

Combination (%)	Outdoor air temp.		Indoor air temp. °C DB											
			16		18		20		21		22		24	
	°C DB	°C WB	TC	PI	TC	PI	TC	PI	TC	PI	TC	PI	TC	PI
100	-24.8	-25	50.4	28.01	50.4	28.09	50.1	26.80	50.1	28.30	50.1	28.39	49.5	28.43
	-21.8	-22	60.6	28.14	60.6	28.22	60.3	27.64	60.3	28.43	60.3	28.92	59.5	28.56
	-19.8	-20	63.6	28.22	63.6	28.30	63.2	28.19	63.2	28.51	63.2	28.73	62.4	28.64
	-18.8	-19	65.1	28.26	64.7	28.35	64.7	28.43	64.7	28.55	64.7	28.64	63.9	28.16
	-16.7	-17	67.9	28.35	67.9	28.44	67.9	28.92	67.5	28.64	67.5	27.65	66.6	27.16
	-13.7	-15	72.7	28.48	72.7	28.56	72.3	28.64	72.3	27.20	72.3	26.24	71.5	25.73
	-11.8	-13	75.1	28.56	74.7	28.64	74.7	27.67	74.7	26.28	74.7	25.33	71.5	24.82
	-9.8	-11	77.6	28.64	77.6	27.54	77.2	26.64	77.2	25.32	76.7	24.40	71.5	23.86
	-9.5	-10	78.1	28.47	78.1	27.38	77.7	26.48	77.7	25.17	76.7	24.25	71.5	23.72
	-8.5	-9.1	79.8	27.89	79.8	26.83	79.4	25.97	79.3	24.68	76.7	23.78	71.5	23.24
	-7.0	-7.6	83.7	27.02	83.4	26.00	81.9	25.19	79.3	23.96	76.7	23.07	71.5	22.52
	-5.0	-5.6	87.3	25.86	86.5	24.90	81.9	24.16	79.3	23.00	76.7	22.12	71.5	21.56
	-3.0	-3.7	89.9	24.70	87.1	23.80	81.9	23.13	79.3	22.03	76.7	21.19	71.5	20.61
	0.0	-0.7	92.3	22.96	87.1	22.15	81.9	21.58	79.3	20.59	76.7	19.76	71.5	19.17
	3.0	2.2	92.3	21.21	87.1	20.50	81.9	20.04	79.3	19.14	76.7	18.35	71.5	17.74
	5.0	4.1	90.5	18.22	85.4	17.60	80.2	17.22	77.7	16.44	75.2	15.73	70.0	15.17
	7.0	6.0	88.2	16.81	83.2	16.28	78.2	16.00	75.7	15.31	73.2	14.65	68.2	14.09
	9.0	7.9	85.0	15.26	80.2	14.78	75.4	14.52	73.0	13.89	70.6	13.28	65.7	12.78
	11.0	9.8	80.4	13.89	75.8	13.45	71.3	13.22	68.9	12.65	66.7	12.10	62.2	11.64
	13.0	11.8	75.4	12.34	71.2	11.96	66.9	11.75	64.8	11.24	62.6	10.75	58.3	10.34
15.0	13.7	71.5	10.99	67.4	10.64	63.3	10.46	61.3	10.01	59.2	9.58	55.2	9.21	
90	-24.8	-25	50.2	24.83	50.2	25.53	49.9	26.02	49.9	26.25	49.9	26.72	49.3	27.42
	-21.8	-22	60.4	25.53	60.4	26.23	60.1	26.72	60.1	26.95	60.1	27.42	59.2	26.18
	-19.8	-20	63.4	26.00	63.4	26.69	63.0	27.18	63.0	27.42	63.0	26.57	62.2	25.37
	-18.8	-19	65.1	26.23	64.7	26.93	64.5	27.42	64.5	26.98	64.5	26.15	63.7	24.96
	-16.7	-17	67.9	26.72	67.9	27.42	67.5	26.51	67.5	26.06	67.5	25.27	65.2	24.10
	-13.7	-15	72.7	27.42	72.7	26.06	72.1	25.21	72.1	24.76	70.2	24.00	65.2	22.87
	-11.8	-13	75.1	26.48	74.7	25.21	74.4	24.40	72.6	23.93	70.2	23.19	65.2	22.09
	-9.8	-11	77.6	25.50	77.6	24.31	75.0	23.54	72.6	23.06	70.2	22.36	65.2	21.27
	-9.5	-10	78.1	25.35	78.1	24.17	75.0	23.40	72.6	22.92	70.2	22.23	65.2	21.15
	-8.5	-9.1	79.8	24.87	79.2	23.72	75.0	22.97	72.6	22.48	70.2	21.80	65.2	20.74
	-7.0	-7.6	83.7	24.13	79.6	23.05	75.0	22.32	72.6	21.83	70.2	21.17	65.2	20.13
	-5.0	-5.6	84.6	23.15	79.6	22.14	75.0	21.46	72.6	20.96	70.2	20.32	65.2	19.31
	-3.0	-3.7	84.6	22.17	79.6	21.24	75.0	20.60	72.6	20.09	70.2	19.48	65.2	18.48
	0.0	-0.7	84.6	20.70	79.6	19.89	75.0	19.31	72.6	18.78	70.2	18.22	65.2	17.26
	3.0	2.2	84.6	19.22	79.6	18.54	75.0	18.01	72.6	17.48	70.2	16.95	65.2	16.03
	5.0	4.1	82.9	16.53	78.0	15.95	73.4	15.49	71.1	15.00	68.9	14.54	63.9	13.72
	7.0	6.0	80.8	15.37	76.0	14.89	71.5	14.49	69.3	14.00	67.1	13.58	62.4	12.80
	9.0	7.9	77.8	13.94	73.2	13.52	68.9	13.15	66.8	12.70	64.6	12.33	60.0	11.62
	11.0	9.8	73.6	12.57	69.3	12.18	65.2	11.86	63.2	11.45	61.1	11.11	56.8	10.47
	13.0	11.8	69.1	10.95	65.0	10.61	61.3	10.33	59.3	9.97	57.4	9.67	53.3	9.12
15.0	13.7	65.4	9.64	61.5	9.35	57.9	9.09	56.1	8.78	54.4	8.52	50.5	8.04	
80	-24.8	-25	50.0	21.72	50.0	22.42	49.7	22.91	49.7	23.14	49.7	24.31	49.1	23.23
	-21.8	-22	59.7	22.42	59.7	23.12	59.7	23.61	59.7	24.31	59.7	23.23	58.3	22.20
	-19.8	-20	62.7	22.89	62.7	23.58	62.7	24.31	62.7	23.54	62.4	22.51	58.3	21.51
	-18.8	-19	64.2	23.12	64.2	24.31	64.2	23.92	64.2	23.16	62.6	22.15	58.3	21.16
	-16.7	-17	67.0	24.31	67.0	23.50	67.0	23.11	65.0	22.36	62.6	21.39	58.3	20.44
	-13.7	-15	70.0	23.10	68.7	22.33	67.0	21.94	65.0	21.21	62.6	20.31	58.3	19.41
	-11.8	-13	71.9	22.32	69.7	21.59	67.0	21.19	65.0	20.48	62.6	19.62	58.3	18.75
	-9.8	-11	73.8	21.51	70.8	20.81	67.0	20.41	65.0	19.72	62.6	18.91	58.3	18.06
	-9.5	-10	74.3	21.39	71.1	20.69	67.0	20.29	65.0	19.60	62.6	18.79	58.3	17.95
	-8.5	-9.1	75.1	20.99	71.4	20.31	67.0	19.90	65.0	19.22	62.6	18.43	58.3	17.61
	-7.0	-7.6	75.8	20.38	71.4	19.72	67.0	19.31	65.0	18.64	62.6	17.90	58.3	17.09
	-5.0	-5.6	75.8	19.57	71.4	18.95	67.0	18.54	65.0	17.87	62.6	17.17	58.3	16.40
	-3.0	-3.7	75.8	18.76	71.4	18.17	67.0	17.76	65.0	17.11	62.6	16.45	58.3	15.71
	0.0	-0.7	75.8	17.54	71.4	17.00	67.0	16.59	65.0	15.96	62.6	15.36	58.3	14.68
	3.0	2.2	75.8	16.33	71.4	15.83	67.0	15.42	65.0	14.81	62.6	14.28	58.3	13.64
	5.0	4.1	74.3	14.03	70.0	13.61	65.7	13.22	63.7	12.68	61.4	12.24	57.2	11.69
	7.0	6.0	72.4	13.08	68.2	12.71	64.0	12.34	62.1	11.82	59.8	11.43	55.7	10.91
	9.0	7.9	69.7	11.51	65.7	11.19	61.7	10.92	59.8	10.51	57.6	10.14	53.7	9.65
	11.0	9.8	65.9	10.05	62.1	9.78	58.3	9.54	56.6	9.18	54.6	8.85	50.7	8.43
	13.0	11.8	61.9	8.56	58.3	8.32	54.8	8.13	53.1	7.81	51.2	7.53	47.7	7.17
15.0	13.7	58.5	7.53	55.2	7.33	51.8	7.14	50.3	6.88	48.5	6.62	45.1	6.31	

# 7. Capacity Tables

Heating Capacity (26HP)

Combination (%)	Outdoor air temp.		Indoor air temp. °C DB											
			16		18		20		21		22		24	
	°C DB	°C WB	TC	PI	TC	PI	TC	PI	TC	PI	TC	PI	TC	PI
70	-24.8	-25	50.0	22.19	50.0	22.42	49.7	22.89	49.7	23.59	49.7	22.44	49.7	22.35
	-21.8	-22	57.4	22.89	57.4	23.12	57.0	23.59	55.1	22.44	53.5	21.35	49.9	20.31
	-19.8	-20	62.4	23.36	60.7	23.59	57.0	22.78	55.1	21.67	53.5	20.64	49.9	19.63
	-18.8	-19	64.0	23.59	60.7	23.16	57.0	22.37	55.1	21.28	53.5	20.28	49.9	19.27
	-16.7	-17	64.2	22.71	60.7	22.28	57.0	21.52	55.1	20.48	53.5	19.52	49.9	18.55
	-13.7	-15	64.2	21.46	60.7	21.02	57.0	20.30	55.1	19.31	53.5	18.45	49.9	17.51
	-11.8	-13	64.2	20.66	60.7	20.21	57.0	19.52	55.1	18.58	53.5	17.76	49.9	16.85
	-9.8	-11	64.2	19.83	60.7	19.38	57.0	18.71	55.1	17.81	53.5	17.04	49.9	16.16
	-9.5	-10	64.2	19.70	60.7	19.25	57.0	18.59	55.1	17.70	53.5	16.93	49.9	16.06
	-8.5	-9.1	64.2	19.28	60.7	18.83	57.0	18.18	55.1	17.31	53.5	16.58	49.9	15.71
	-7.0	-7.6	64.2	18.66	60.7	18.20	57.0	17.57	55.1	16.73	53.5	16.04	49.9	15.19
	-5.0	-5.6	64.2	17.82	60.7	17.35	57.0	16.76	55.1	15.96	53.5	15.31	49.9	14.50
	-3.0	-3.7	64.2	16.99	60.7	16.51	57.0	15.95	55.1	15.19	53.5	14.59	49.9	13.80
	0.0	-0.7	64.2	15.73	60.7	15.25	57.0	14.73	55.1	14.04	53.5	13.52	49.9	12.76
	3.0	2.2	64.2	14.48	60.7	13.97	57.0	13.50	55.1	12.88	53.5	12.44	49.9	11.72
	5.0	4.1	64.2	12.60	59.4	11.88	55.9	11.48	54.0	10.94	52.4	10.58	48.9	9.97
	7.0	6.0	64.3	11.97	57.9	10.93	54.5	10.58	52.6	10.10	51.1	9.79	47.7	9.21
	9.0	7.9	62.0	10.21	55.8	9.33	52.5	9.02	50.7	8.61	49.2	8.34	45.9	7.85
	11.0	9.8	58.5	8.90	52.8	8.13	49.6	7.86	47.9	7.51	46.6	7.28	43.4	6.84
	13.0	11.8	55.0	7.64	49.6	6.99	46.6	6.75	45.0	6.45	43.7	6.26	40.7	5.88
15.0	13.7	52.0	6.65	46.8	6.07	44.2	5.88	42.6	5.60	41.4	5.44	38.6	5.11	
60	-24.8	-25	49.2	21.72	49.2	22.19	48.9	22.89	47.3	21.69	45.7	20.56	42.7	19.50
	-21.8	-22	52.7	22.42	52.2	22.89	48.9	21.69	47.3	20.56	45.7	19.50	42.7	18.48
	-19.8	-20	55.1	22.89	52.2	22.04	48.9	20.89	47.3	19.81	45.7	18.80	42.7	17.81
	-18.8	-19	55.1	22.47	52.2	21.62	48.9	20.48	47.3	19.43	45.7	18.45	42.7	17.46
	-16.7	-17	55.1	21.56	52.2	20.72	48.9	19.65	47.3	18.65	45.7	17.71	42.7	16.75
	-13.7	-15	55.1	20.26	52.2	19.44	48.9	18.44	47.3	17.52	45.7	16.65	42.7	15.73
	-11.8	-13	55.1	19.45	52.2	18.64	48.9	17.68	47.3	16.81	45.7	15.98	42.7	15.09
	-9.8	-11	55.1	18.59	52.2	17.79	48.9	16.88	47.3	16.06	45.7	15.27	42.7	14.40
	-9.5	-10	55.1	18.46	52.2	17.66	48.9	16.76	47.3	15.94	45.7	15.17	42.7	14.30
	-8.5	-9.1	55.1	18.03	52.2	17.24	48.9	16.36	47.3	15.57	45.7	14.81	42.7	13.97
	-7.0	-7.6	55.1	17.39	52.2	16.60	48.9	15.75	47.3	15.00	45.7	14.28	42.7	13.46
	-5.0	-5.6	55.1	16.52	52.2	15.75	48.9	14.96	47.3	14.25	45.7	13.59	42.7	12.77
	-3.0	-3.7	55.1	15.66	52.2	14.90	48.9	14.15	47.3	13.50	45.7	12.88	42.7	12.09
	0.0	-0.7	55.1	14.37	52.2	13.61	48.9	12.95	47.3	12.37	45.7	11.82	42.7	11.07
	3.0	2.2	55.1	13.08	52.2	12.34	48.9	11.74	47.3	11.25	45.7	10.76	42.7	10.05
	5.0	4.1	54.0	11.07	51.1	10.40	47.9	9.90	46.4	9.50	44.7	9.09	41.8	8.48
	7.0	6.0	52.6	10.10	49.8	9.47	46.8	9.03	45.1	8.68	43.6	8.32	40.8	7.74
	9.0	7.9	50.7	8.53	48.0	7.99	45.0	7.61	43.5	7.32	42.0	7.02	39.3	6.53
	11.0	9.8	47.9	7.44	45.3	6.97	42.5	6.64	41.1	6.38	39.7	6.12	37.2	5.69
	13.0	11.8	45.0	6.38	42.7	5.98	39.9	5.70	38.6	5.48	37.3	5.26	34.9	4.89
15.0	13.7	42.6	5.60	40.3	5.25	37.9	4.95	36.6	4.76	35.3	4.57	33.0	4.29	
50	-24.8	-25	46.0	19.48	43.4	20.18	40.7	19.09	39.4	18.06	38.1	17.11	35.5	16.21
	-21.8	-22	46.0	20.18	43.4	19.09	40.7	18.06	39.4	17.11	38.1	16.21	35.5	15.35
	-19.8	-20	46.0	19.42	43.4	18.36	40.7	17.39	39.4	16.46	38.1	15.61	35.5	14.77
	-18.8	-19	46.0	19.04	43.4	17.99	40.7	17.05	39.4	16.14	38.1	15.31	35.5	14.49
	-16.7	-17	46.0	18.23	43.4	17.23	40.7	16.33	39.4	15.46	38.1	14.68	35.5	13.89
	-13.7	-15	46.0	17.09	43.4	16.13	40.7	15.31	39.4	14.50	38.1	13.78	35.5	13.03
	-11.8	-13	46.0	16.36	43.4	15.44	40.7	14.66	39.4	13.89	38.1	13.22	35.5	12.48
	-9.8	-11	46.0	15.59	43.4	14.71	40.7	13.98	39.4	13.25	38.1	12.62	35.5	11.91
	-9.5	-10	46.0	15.48	43.4	14.60	40.7	13.88	39.4	13.15	38.1	12.54	35.5	11.82
	-8.5	-9.1	46.0	15.09	43.4	14.23	40.7	13.54	39.4	12.83	38.1	12.24	35.5	11.54
	-7.0	-7.6	46.0	14.52	43.4	13.69	40.7	13.03	39.4	12.35	38.1	11.79	35.5	11.11
	-5.0	-5.6	46.0	13.75	43.4	12.96	40.7	12.35	39.4	11.70	38.1	11.19	35.5	10.54
	-3.0	-3.7	46.0	12.98	43.4	12.23	40.7	11.66	39.4	11.06	38.1	10.59	35.5	9.96
	0.0	-0.7	46.0	11.84	43.4	11.13	40.7	10.65	39.4	10.10	38.1	9.69	35.5	9.10
	3.0	2.2	46.0	10.70	43.4	10.04	40.7	9.62	39.4	9.13	38.1	8.80	35.5	8.24
	5.0	4.1	45.1	8.99	42.5	8.42	39.9	8.09	38.6	7.69	37.4	7.42	34.9	6.94
	7.0	6.0	43.9	8.16	41.4	7.64	39.0	7.36	37.7	6.99	36.4	6.77	34.0	6.31
	9.0	7.9	42.3	6.95	39.9	6.51	37.5	6.27	36.3	5.96	35.1	5.78	32.7	5.38
	11.0	9.8	40.2	6.14	37.9	5.74	35.6	5.53	34.3	5.25	33.2	5.09	31.0	4.75
	13.0	11.8	37.5	5.21	35.5	4.87	33.3	4.69	32.3	4.49	31.2	4.32	29.0	4.06
15.0	13.7	35.5	4.59	33.6	4.29	31.5	4.13	30.5	3.93	29.5	3.80	27.5	3.54	

**Note**

1. TC: Total Capacity(kW), PI : Power Input(kW, Comp. + Outdoor fan motor)
2. Capacity tables show the average value of conditions which may occur.
3. The heating capacity table is based on the values expressed as Max. in the specification of the outdoor unit. (When measuring the Max. heating capacity, the setting status of the indoor unit is the same as that for measuring the heating capacity of the indoor unit.)

# 7. Capacity Tables

## ◆ ARUM280LTE5

Heating Capacity (28HP)

Combination (%)	Outdoor air temp.		Indoor air temp. °C DB											
			16		18		20		21		22		24	
	°C DB	°C WB	TC	PI	TC	PI	TC	PI	TC	PI	TC	PI	TC	PI
130	-24.8	-25	52.6	26.2	52.6	26.72	52.3	27.15	52.3	27.80	52.3	28.42	52.2	29.41
	-21.8	-22	63.6	27.22	63.6	27.70	63.2	28.13	63.2	28.78	63.2	29.41	63.1	30.38
	-19.8	-20	66.9	27.86	66.9	28.36	66.5	28.78	66.5	29.43	66.5	30.05	66.4	31.03
	-18.8	-19	68.6	28.20	68.6	28.68	68.2	29.11	68.2	29.76	68.2	30.38	68.1	31.36
	-16.7	-17	72.1	28.88	72.1	29.37	71.7	29.80	71.7	30.44	71.7	31.06	71.5	32.04
	-13.7	-15	77.1	29.86	77.1	30.35	76.6	30.78	76.6	31.42	76.6	32.04	76.4	30.78
	-11.8	-13	79.7	30.48	79.7	30.97	79.2	31.40	79.2	32.04	79.2	31.20	79.2	29.99
	-9.8	-11	82.5	31.13	82.5	31.62	81.9	32.04	81.9	31.14	81.9	30.30	81.9	29.15
	-9.5	-10	83.2	31.23	83.2	31.72	82.7	31.91	82.7	30.99	82.3	30.17	82.3	29.02
	-8.5	-9.1	86.0	31.56	86.0	32.04	85.5	31.44	85.5	30.54	83.7	29.71	83.7	28.59
	-7.0	-7.6	90.3	32.04	90.3	31.35	89.6	30.74	89.6	29.85	89.6	29.04	87.6	27.97
	-5.0	-5.6	95.9	31.15	95.9	30.43	95.2	29.79	95.2	28.94	95.2	28.15	90.8	27.12
	-3.0	-3.7	101.5	30.24	101.5	29.51	100.8	28.86	100.8	28.02	100.8	27.25	94.1	26.28
	0.0	-0.7	109.8	28.88	109.8	28.12	109.1	27.45	108.0	26.65	105.8	25.90	98.8	25.02
	3.0	2.2	112.7	27.52	112.7	26.73	112.2	26.04	110.6	25.29	106.9	24.55	99.6	23.76
	5.0	4.1	112.0	24.19	111.7	23.43	111.3	22.76	108.6	22.07	104.8	21.40	97.6	20.70
	7.0	6.0	109.1	22.88	108.9	22.15	108.5	21.50	105.9	20.88	102.2	20.25	95.1	19.65
	9.0	7.9	105.0	21.23	104.8	20.54	104.5	19.94	102.0	19.36	98.4	18.79	91.6	18.23
	11.0	9.8	99.4	19.82	99.2	19.19	98.9	18.63	96.4	18.09	93.1	17.55	86.6	17.02
	13.0	11.8	93.3	18.16	93.1	17.57	92.9	17.06	90.5	16.56	87.4	16.08	81.4	15.59
15.0	13.7	88.3	16.75	88.2	16.21	87.8	15.74	85.7	15.28	82.6	14.83	77.0	14.38	
120	-24.8	-25	52.3	26.72	52.3	27.15	51.9	27.80	51.9	28.42	51.9	29.41	51.8	30.09
	-21.8	-22	63.2	27.70	63.2	28.13	62.8	28.78	62.8	29.41	62.8	30.38	62.7	31.06
	-19.8	-20	66.5	28.36	66.5	28.78	66.0	29.43	66.0	30.05	66.0	31.03	65.9	31.72
	-18.8	-19	68.1	28.68	68.1	29.11	67.7	29.76	67.7	30.38	67.7	31.36	67.6	32.04
	-16.7	-17	71.6	29.37	71.6	29.80	71.2	30.44	71.2	31.06	71.2	32.04	71.0	31.24
	-13.7	-15	76.5	30.35	76.5	30.78	76.0	31.42	76.0	32.04	76.0	30.83	75.9	30.08
	-11.8	-13	79.1	30.97	79.1	31.40	78.6	32.04	78.6	31.18	78.6	30.06	78.6	29.34
	-9.8	-11	81.8	31.62	81.8	32.04	81.3	31.10	81.3	30.28	81.3	29.26	81.3	28.57
	-9.5	-10	82.7	31.72	82.7	31.89	82.2	30.96	82.2	30.15	82.2	29.14	82.2	28.45
	-8.5	-9.1	85.5	32.04	85.5	31.39	84.9	30.48	84.9	29.69	84.4	28.74	84.4	28.06
	-7.0	-7.6	89.6	31.29	89.6	30.64	89.1	29.77	89.1	29.02	87.0	28.12	86.9	27.48
	-5.0	-5.6	95.2	30.29	95.2	29.63	94.5	28.83	94.5	28.11	94.5	27.32	90.2	26.71
	-3.0	-3.7	100.7	29.28	100.7	28.63	100.1	27.87	100.1	27.21	99.2	26.51	92.9	25.93
	0.0	-0.7	109.0	27.77	108.5	27.12	105.7	26.45	103.7	25.85	100.6	25.30	93.5	24.77
	3.0	2.2	111.9	26.26	111.2	25.61	107.5	25.03	103.9	24.49	100.6	24.09	93.5	23.62
	5.0	4.1	111.1	22.93	109.7	22.31	105.3	21.80	101.8	21.34	98.7	21.01	91.7	20.60
	7.0	6.0	108.3	21.58	106.9	21.00	102.7	20.58	99.2	20.19	96.1	20.00	89.3	19.65
	9.0	7.9	104.3	19.97	102.9	19.43	98.9	19.05	95.6	18.68	92.6	18.50	86.1	18.17
	11.0	9.8	98.7	18.60	97.3	18.09	93.5	17.73	90.4	17.40	87.6	17.23	81.4	16.93
	13.0	11.8	92.6	16.98	91.4	16.51	87.8	16.19	84.9	15.88	82.3	15.73	76.4	15.45
15.0	13.7	87.7	15.60	86.5	15.17	83.1	14.87	80.3	14.60	77.9	14.46	72.3	14.20	
110	-24.8	-25	51.9	27.15	51.9	27.80	51.7	28.42	51.7	29.41	51.7	30.09	51.6	30.42
	-21.8	-22	62.9	28.13	62.9	28.78	62.5	29.41	62.5	30.38	62.5	31.06	62.4	31.40
	-19.8	-20	66.1	28.78	66.1	29.43	65.7	30.05	65.7	31.03	65.7	31.72	65.5	32.04
	-18.8	-19	67.7	29.11	67.7	29.76	67.3	30.38	67.3	31.36	67.3	32.04	67.2	31.62
	-16.7	-17	71.2	29.80	71.2	30.44	70.8	31.06	70.8	32.04	70.8	31.17	70.6	30.72
	-13.7	-15	76.2	30.78	76.2	31.42	75.6	32.04	75.6	30.72	75.6	29.92	75.6	29.45
	-11.8	-13	78.7	31.40	78.7	32.04	78.2	31.11	78.2	29.88	78.2	29.12	78.2	28.64
	-9.8	-11	81.4	32.04	81.4	30.99	80.9	30.13	80.9	29.00	80.9	28.29	80.9	27.79
	-9.5	-10	82.2	31.87	82.2	30.82	81.8	29.97	81.8	28.86	81.8	28.17	81.8	27.65
	-8.5	-9.1	85.0	31.31	85.0	30.30	84.4	29.48	84.4	28.42	84.1	27.75	83.6	27.23
	-7.0	-7.6	89.1	30.44	89.1	29.50	88.6	28.74	88.6	27.75	87.1	27.13	84.2	26.59
	-5.0	-5.6	94.7	29.29	94.7	28.44	94.0	27.75	93.0	26.87	89.2	26.29	84.2	25.74
	-3.0	-3.7	100.1	28.15	100.1	27.38	96.4	26.76	93.3	25.98	90.1	25.46	84.2	24.89
	0.0	-0.7	106.5	26.42	102.7	25.79	96.4	25.28	93.3	24.65	90.1	24.21	84.2	23.61
	3.0	2.2	108.7	24.71	102.7	24.19	96.4	23.80	93.3	23.33	90.1	22.95	84.2	22.34
	5.0	4.1	106.6	21.38	100.7	20.97	94.5	20.65	91.4	20.28	88.4	19.96	82.5	19.38
	7.0	6.0	103.8	19.95	98.2	19.65	92.1	19.43	89.1	19.19	86.1	18.95	80.4	18.36
	9.0	7.9	100.1	18.36	94.5	18.08	88.7	17.88	85.8	17.67	82.9	17.44	77.5	16.90
	11.0	9.8	94.6	17.01	89.4	16.75	83.9	16.55	81.2	16.36	78.4	16.15	73.2	15.65
	13.0	11.8	88.9	15.42	84.0	15.19	78.8	15.01	76.3	14.83	73.7	14.64	68.8	14.19
15.0	13.7	84.0	14.05	79.4	13.85	74.6	13.69	72.1	13.52	69.7	13.34	65.1	12.93	

# 7. Capacity Tables

Heating Capacity (28HP)

Combination (%)	Outdoor air temp.		Indoor air temp. °C DB											
			16		18		20		21		22		24	
	°C DB	°C WB	TC	PI	TC	PI	TC	PI	TC	PI	TC	PI	TC	PI
100	-24.8	-25	51.7	30.23	51.7	30.46	51.4	29.54	51.4	31.06	51.4	31.32	51.3	31.44
	-21.8	-22	62.5	30.59	62.5	30.83	62.2	30.48	62.2	31.43	62.2	32.12	62.0	31.81
	-19.8	-20	65.8	30.83	65.8	31.07	65.4	31.10	65.4	31.67	65.4	32.07	65.3	32.04
	-18.8	-19	67.5	30.95	67.0	31.20	67.0	31.43	67.0	31.79	67.0	32.04	66.9	31.53
	-16.7	-17	70.5	31.21	70.5	31.46	70.5	32.12	70.1	32.04	70.1	30.98	69.9	30.44
	-13.7	-15	75.8	31.57	75.8	31.81	75.3	32.04	75.3	30.50	75.3	29.45	75.2	28.89
	-11.8	-13	78.3	31.81	77.9	32.04	77.9	31.00	77.9	29.51	77.9	28.48	76.7	27.90
	-9.8	-11	80.9	32.04	80.9	30.87	80.6	29.90	80.6	28.47	80.6	27.47	76.9	26.87
	-9.5	-10	81.8	31.86	81.8	30.70	81.4	29.73	81.4	28.31	81.2	27.31	76.9	26.72
	-8.5	-9.1	84.5	31.24	84.5	30.11	84.1	29.19	85.4	27.79	82.6	26.80	76.9	26.20
	-7.0	-7.6	90.1	30.32	89.8	29.23	88.2	28.35	85.4	27.02	82.6	26.03	76.9	25.42
	-5.0	-5.6	94.1	29.09	93.1	28.06	88.2	27.25	85.4	25.98	82.6	25.01	76.9	24.39
	-3.0	-3.7	96.8	27.86	93.8	26.89	88.2	26.16	85.4	24.94	82.6	24.00	76.9	23.35
	0.0	-0.7	99.5	26.01	93.8	25.12	88.2	24.50	85.4	23.39	82.6	22.47	76.9	21.80
	3.0	2.2	99.5	24.16	93.8	23.36	88.2	22.85	85.4	21.83	82.6	20.94	76.9	20.25
	5.0	4.1	97.5	20.83	92.0	20.12	86.4	19.70	83.7	18.80	80.9	18.00	75.4	17.36
	7.0	6.0	95.0	19.31	89.6	18.70	84.2	18.38	81.5	17.58	78.9	16.82	73.5	16.18
9.0	7.9	91.5	17.58	86.3	17.02	81.2	16.72	78.6	16.00	76.0	15.30	70.7	14.72	
11.0	9.8	86.6	16.06	81.7	15.55	76.7	15.28	74.2	14.62	71.8	13.99	66.9	13.45	
13.0	11.8	81.2	14.33	76.7	13.88	72.1	13.64	69.8	13.05	67.4	12.48	62.8	12.00	
15.0	13.7	76.9	12.82	72.6	12.42	68.2	12.20	66.0	11.67	63.8	11.17	59.5	10.74	
90	-24.8	-25	51.5	26.82	51.5	27.80	51.2	28.49	51.2	28.81	51.2	29.47	51.1	30.45
	-21.8	-22	62.3	27.80	62.3	28.78	62.0	29.47	62.0	29.79	62.0	30.45	61.8	29.13
	-19.8	-20	65.6	28.46	65.6	29.43	65.1	30.11	65.1	30.45	65.1	29.55	65.0	28.26
	-18.8	-19	67.5	28.78	67.0	29.76	66.8	30.45	66.8	29.98	66.8	29.10	66.7	27.82
	-16.7	-17	70.5	29.47	70.5	30.45	70.1	29.49	70.1	29.01	70.1	28.16	69.3	26.90
	-13.7	-15	75.8	30.45	75.8	29.02	75.1	28.12	75.1	27.63	74.5	26.81	70.3	25.58
	-11.8	-13	78.3	29.47	77.9	28.12	77.6	27.26	77.0	26.75	75.6	25.96	70.3	24.75
	-9.8	-11	80.9	28.44	80.9	27.18	79.6	26.35	78.2	25.82	75.6	25.07	70.3	23.88
	-9.5	-10	81.8	28.29	81.8	27.03	80.2	26.21	78.2	25.68	75.6	24.93	70.3	23.75
	-8.5	-9.1	84.5	27.78	83.9	26.56	80.7	25.75	78.2	25.22	75.6	24.48	70.3	23.31
	-7.0	-7.6	90.1	27.01	85.7	25.85	80.7	25.07	78.2	24.53	75.6	23.81	70.3	22.66
	-5.0	-5.6	91.1	25.98	85.7	24.90	80.7	24.16	78.2	23.61	75.6	22.91	70.3	21.78
	-3.0	-3.7	91.1	24.96	85.7	23.96	80.7	23.26	78.2	22.68	75.6	22.01	70.3	20.90
	0.0	-0.7	91.1	23.42	85.7	22.53	80.7	21.89	78.2	21.30	75.6	20.67	70.3	19.59
	3.0	2.2	91.1	21.88	85.7	21.11	80.7	20.53	78.2	19.92	75.6	19.32	70.3	18.28
	5.0	4.1	89.3	18.88	84.0	18.23	79.1	17.71	76.6	17.15	74.2	16.63	68.9	15.70
	7.0	6.0	87.0	17.65	81.9	17.10	77.0	16.65	74.7	16.08	72.3	15.60	67.2	14.71
9.0	7.9	83.8	16.06	78.9	15.57	74.2	15.15	71.9	14.63	69.6	14.20	64.7	13.39	
11.0	9.8	79.3	14.53	74.6	14.08	70.2	13.70	68.1	13.24	65.8	12.85	61.1	12.11	
13.0	11.8	74.4	12.71	70.0	12.31	66.0	11.99	63.9	11.57	61.8	11.23	57.4	10.59	
15.0	13.7	70.4	11.24	66.3	10.91	62.3	10.61	60.4	10.25	58.5	9.95	54.4	9.38	
80	-24.8	-25	51.3	23.37	51.3	24.35	51.0	25.04	51.0	25.36	51.0	27.00	50.9	25.84
	-21.8	-22	61.6	24.35	61.6	25.33	61.6	26.02	61.6	27.00	61.6	25.84	61.0	24.73
	-19.8	-20	64.9	25.01	64.9	25.98	64.9	27.00	64.9	26.18	64.9	25.07	62.8	24.00
	-18.8	-19	66.5	25.33	66.5	27.00	66.5	26.58	66.5	25.77	66.0	24.68	62.8	23.62
	-16.7	-17	70.1	27.00	70.1	26.13	70.1	25.72	69.2	24.92	67.5	23.88	62.8	22.85
	-13.7	-15	75.4	25.72	74.0	24.90	72.2	24.48	70.0	23.69	67.5	22.72	62.8	21.74
	-11.8	-13	77.4	24.91	75.1	24.12	72.2	23.69	70.0	22.92	67.5	21.99	62.8	21.04
	-9.8	-11	79.1	24.05	76.0	23.30	72.2	22.86	70.0	22.11	67.5	21.22	62.8	20.30
	-9.5	-10	79.6	23.93	76.4	23.17	72.2	22.73	70.0	21.98	67.5	21.10	62.8	20.18
	-8.5	-9.1	80.6	23.50	76.9	22.77	72.2	22.32	70.0	21.58	67.5	20.71	62.8	19.82
	-7.0	-7.6	81.6	22.86	76.9	22.15	72.2	21.70	70.0	20.96	67.5	20.15	62.8	19.26
	-5.0	-5.6	81.6	22.01	76.9	21.33	72.2	20.88	70.0	20.14	67.5	19.37	62.8	18.52
	-3.0	-3.7	81.6	21.15	76.9	20.51	72.2	20.05	70.0	19.33	67.5	18.60	62.8	17.78
	0.0	-0.7	81.6	19.87	76.9	19.28	72.2	18.81	70.0	18.11	67.5	17.44	62.8	16.67
	3.0	2.2	81.6	18.59	76.9	18.04	72.2	17.57	70.0	16.88	67.5	16.29	62.8	15.56
	5.0	4.1	80.0	16.04	75.4	15.55	70.7	15.12	68.6	14.50	66.1	14.00	61.6	13.37
	7.0	6.0	77.9	15.03	73.5	14.60	68.9	14.17	66.9	13.57	64.4	13.13	60.0	12.53
9.0	7.9	75.1	13.26	70.7	12.89	66.5	12.58	64.4	12.10	62.1	11.67	57.8	11.12	
11.0	9.8	71.0	11.62	66.9	11.30	62.8	11.03	60.9	10.60	58.8	10.22	54.6	9.74	
13.0	11.8	66.7	9.93	62.8	9.66	59.0	9.43	57.2	9.06	55.1	8.74	51.3	8.32	
15.0	13.7	63.0	8.79	59.5	8.55	55.8	8.33	54.1	8.02	52.2	7.73	48.5	7.37	

# 7. Capacity Tables

Heating Capacity (28HP)

Combination (%)	Outdoor air temp.		Indoor air temp. °C DB															
			16		18		20		21		22		24					
	°C DB	°C WB	TC	PI	TC	PI	TC	PI	TC	PI	TC	PI	TC	PI				
70	-24.8	-25	51.3	24.06	51.3	24.38	51.0	25.04	51.0	26.02	51.0	26.02	51.0	24.79	57.6	23.64	53.7	22.53
	-21.8	-22	60.6	25.04	60.9	25.36	60.4	26.02	60.4	26.02	59.3	24.79	57.6	23.64	53.7	22.53	53.7	21.80
	-19.8	-20	64.8	25.69	64.2	26.02	61.4	25.16	61.4	25.16	59.3	23.98	57.6	22.88	53.7	21.80	53.7	21.42
	-18.8	-19	66.5	26.02	65.1	25.57	61.4	24.73	61.4	24.73	59.3	23.56	57.6	22.50	53.7	21.42	53.7	20.65
	-16.7	-17	68.8	25.10	65.3	24.64	61.4	23.83	61.4	23.83	59.3	22.71	57.6	21.69	53.7	20.65	53.7	19.54
	-13.7	-15	69.1	23.78	65.3	23.31	61.4	22.54	61.4	22.54	59.3	21.48	57.6	20.55	53.7	19.54	53.7	18.83
	-11.8	-13	69.1	22.94	65.3	22.46	61.4	21.72	61.4	21.72	59.3	20.70	57.6	19.82	53.7	18.83	53.7	18.09
	-9.8	-11	69.1	22.07	65.3	21.58	61.4	20.86	61.4	20.86	59.3	19.88	57.6	19.05	53.7	18.09	53.7	17.98
	-9.5	-10	69.1	21.94	65.3	21.44	61.4	20.74	61.4	20.74	59.3	19.77	57.6	18.94	53.7	17.98	53.7	17.61
	-8.5	-9.1	69.1	21.50	65.3	21.00	61.4	20.30	61.4	20.30	59.3	19.36	57.6	18.56	53.7	17.61	53.7	17.06
	-7.0	-7.6	69.1	20.84	65.3	20.34	61.4	19.66	61.4	19.66	59.3	18.74	57.6	17.99	53.7	17.06	53.7	16.32
	-5.0	-5.6	69.1	19.96	65.3	19.45	61.4	18.80	61.4	18.80	59.3	17.93	57.6	17.22	53.7	16.32	53.7	15.57
	-3.0	-3.7	69.1	19.09	65.3	18.56	61.4	17.94	61.4	17.94	59.3	17.11	57.6	16.45	53.7	15.57	53.7	14.46
	0.0	-0.7	69.1	17.78	65.3	17.23	61.4	16.65	61.4	16.65	59.3	15.88	57.6	15.31	53.7	14.46	53.7	13.35
	3.0	2.2	69.1	16.46	65.3	15.89	61.4	15.36	61.4	15.36	59.3	14.66	57.6	14.16	53.7	13.35	53.7	12.57
	5.0	4.1	69.1	14.40	64.0	13.57	60.2	13.10	58.1	12.50	56.5	12.09	52.7	11.25	51.3	10.57	49.4	9.04
	7.0	6.0	69.3	13.75	62.3	12.56	58.7	12.14	56.7	11.60	55.0	11.25	51.3	10.57	49.4	9.04	49.4	8.91
	9.0	7.9	66.7	11.76	60.1	10.75	56.5	10.39	54.6	9.91	53.0	9.61	49.4	8.91	49.4	8.91	49.4	7.91
	11.0	9.8	63.1	10.29	56.9	9.40	53.5	9.09	51.6	8.68	50.1	8.42	46.7	7.91	46.7	7.91	46.7	6.82
	13.0	11.8	59.3	8.87	53.4	8.11	50.2	7.84	48.5	7.48	47.1	7.26	43.9	6.82	43.9	6.82	43.9	5.96
15.0	13.7	56.0	7.76	50.5	7.09	47.5	6.86	45.9	6.54	44.5	6.34	41.5	5.96	41.5	5.96	41.5	5.00	
60	-24.8	-25	50.7	23.40	50.7	24.06	50.4	25.04	49.6	23.78	48.9	22.59	46.0	21.47	46.0	20.39	46.0	19.67
	-21.8	-22	55.8	24.38	56.2	25.04	52.7	23.78	50.9	22.59	49.2	21.47	46.0	20.39	46.0	19.67	46.0	19.30
	-19.8	-20	59.3	25.04	56.2	24.15	52.7	22.93	50.9	21.80	49.2	20.72	46.0	19.30	46.0	18.54	46.0	17.46
	-18.8	-19	59.3	24.59	56.2	23.70	52.7	22.51	50.9	21.40	49.2	20.35	46.0	19.30	46.0	18.54	46.0	17.46
	-16.7	-17	59.3	23.65	56.2	22.76	52.7	21.63	50.9	20.57	49.2	19.57	46.0	18.54	46.0	17.46	46.0	16.05
	-13.7	-15	59.3	22.30	56.2	21.43	52.7	20.36	50.9	19.38	49.2	18.46	46.0	16.05	46.0	15.94	46.0	15.59
	-11.8	-13	59.3	21.46	56.2	20.58	52.7	19.56	50.9	18.63	49.2	17.75	46.0	15.94	46.0	15.05	46.0	14.32
	-9.8	-11	59.3	20.56	56.2	19.70	52.7	18.72	50.9	17.84	49.2	17.00	46.0	14.32	46.0	13.60	46.0	12.51
	-9.5	-10	59.3	20.42	56.2	19.57	52.7	18.60	50.9	17.72	49.2	16.89	46.0	13.60	46.0	12.51	46.0	11.43
	-8.5	-9.1	59.3	19.98	56.2	19.12	52.7	18.17	50.9	17.33	49.2	16.51	46.0	13.60	46.0	12.51	46.0	11.43
	-7.0	-7.6	59.3	19.31	56.2	18.45	52.7	17.54	50.9	16.73	49.2	15.95	46.0	13.60	46.0	12.51	46.0	11.43
	-5.0	-5.6	59.3	18.42	56.2	17.56	52.7	16.70	50.9	15.94	49.2	15.21	46.0	13.60	46.0	12.51	46.0	11.43
	-3.0	-3.7	59.3	17.52	56.2	16.67	52.7	15.86	50.9	15.15	49.2	14.47	46.0	13.60	46.0	12.51	46.0	11.43
	0.0	-0.7	59.3	16.18	56.2	15.33	52.7	14.60	50.9	13.96	49.2	13.35	46.0	12.51	46.0	11.43	46.0	11.43
	3.0	2.2	59.3	14.84	56.2	14.00	52.7	13.33	50.9	12.78	49.2	12.23	46.0	11.43	46.0	11.43	46.0	11.43
	5.0	4.1	58.1	12.62	55.1	11.86	51.6	11.29	49.9	10.84	48.1	10.38	45.1	9.68	45.1	9.68	45.1	8.89
	7.0	6.0	56.7	11.61	53.7	10.88	50.3	10.37	48.6	9.97	46.9	9.56	43.9	8.89	43.9	8.89	43.9	7.52
	9.0	7.9	54.6	9.83	51.7	9.20	48.5	8.77	46.9	8.43	45.2	8.09	42.3	7.52	42.3	7.52	42.3	6.58
	11.0	9.8	51.6	8.60	48.8	8.05	45.8	7.67	44.3	7.38	42.7	7.07	40.1	6.58	40.1	6.58	40.1	5.68
	13.0	11.8	48.5	7.41	45.9	6.95	43.0	6.61	41.6	6.36	40.2	6.10	37.6	5.68	37.6	5.68	37.6	5.00
15.0	13.7	45.9	6.54	43.4	6.12	40.8	5.78	39.4	5.56	38.0	5.33	35.5	5.00	35.5	5.00	35.5	5.00	
50	-24.8	-25	49.5	21.43	46.7	22.41	43.9	21.23	42.5	20.12	41.1	19.07	38.3	18.10	38.3	17.16	38.3	16.22
	-21.8	-22	49.5	22.41	46.7	21.23	43.9	20.12	42.5	19.07	41.1	18.10	38.3	17.16	38.3	16.22	38.3	15.56
	-19.8	-20	49.5	21.58	46.7	20.44	43.9	19.38	42.5	18.37	41.1	17.45	38.3	16.22	38.3	15.56	38.3	14.62
	-18.8	-19	49.5	21.18	46.7	20.04	43.9	19.02	42.5	18.02	41.1	17.12	38.3	16.22	38.3	15.56	38.3	14.03
	-16.7	-17	49.5	20.31	46.7	19.22	43.9	18.24	42.5	17.29	41.1	16.44	38.3	15.56	38.3	14.03	38.3	13.40
	-13.7	-15	49.5	19.07	46.7	18.03	43.9	17.13	42.5	16.24	41.1	15.46	38.3	14.03	38.3	13.40	38.3	13.31
	-11.8	-13	49.5	18.29	46.7	17.28	43.9	16.42	42.5	15.58	41.1	14.85	38.3	13.40	38.3	13.31	38.3	13.00
	-9.8	-11	49.5	17.46	46.7	16.49	43.9	15.69	42.5	14.88	41.1	14.20	38.3	13.40	38.3	13.00	38.3	12.53
	-9.5	-10	49.5	17.34	46.7	16.37	43.9	15.58	42.5	14.78	41.1	14.10	38.3	13.00	38.3	12.53	38.3	11.91
	-8.5	-9.1	49.5	16.92	46.7	15.97	43.9	15.21	42.5	14.43	41.1	13.78	38.3	12.53	38.3	11.91	38.3	11.28
	-7.0	-7.6	49.5	16.30	46.7	15.39	43.9	14.66	42.5	13.91	41.1	13.29	38.3	11.91	38.3	11.28	38.3	10.34
	-5.0	-5.6	49.5	15.47	46.7	14.60	43.9	13.92	42.5	13.20	41.1	12.63	38.3	11.28	38.3	10.34	38.3	9.40
	-3.0	-3.7	49.5	14.65	46.7	13.81	43.9	13.18	42.5	12.51	41.1	11.98	38.3	10.34	38.3	9.40	38.3	8.94
	0.0	-0.7	49.5	13.41	46.7	12.61	43.9	12.08	42.5	11.46	41.1	11.01	38.3	9.40	38.3	8.94	38.3	8.40
	3.0	2.2	49.5	12.18	46.7	11.43	43.9	10.96	42.5	10.41	41.1	10.03	38.3	8.40	38.3	8.40	38.3	7.94
	5.0	4.1	48.5	10.27	45.8	9.62	43.0	9.25	41.6	8.79	40.3	8.48	37.5	7.94	37.5	7.94	37.5	7.25
	7.0	6.0	47.3	9.37	44.6	8.77	42.0	8.45	40.6	8.02	39.2	7.78	36.6	7.25	36.6	7.25	36.6	6.20
	9.0	7.9	45.5	8.01	43.0	7.50	40.4	7.22	39.1	6.86	37.8	6.65	35.2	6.20	35.2	6.20	35.2	5.49
	11.0	9.8	43.3	7.09	40.8	6.63	38.3	6.39	36.9	6.07	35.7	5.88	33.3	5.49	33.3	5.49	33.3	4.72
	13.0	11.8	40.4	6.05	38.2	5.66	35.9	5.45	34.7	5.21	33.6	5.02	31.3	4.72	31.3	4.72	31.3	4.14
15.0	13.7	38.3	5.35	36.1	5.01	33.9	4.82	32.9	4.59	31.7	4.44	29.6	4.14	29.6	4.14	29.6	4.14	

**Note**

1. TC: Total Capacity(kW), PI : Power Input(kW, Comp. + Outdoor fan motor)
2. Capacity tables show the average value of conditions which may occur.
3. The heating capacity table is based on the values expressed as Max. in the specification of the outdoor unit. (When measuring the Max. heating capacity, the setting status of the indoor unit is the same as that for measuring the heating capacity of the indoor unit.)

# 7. Capacity Tables

## ◆ ARUM300LTE5

Heating Capacity (30HP)

Combination (%)	Outdoor air temp.		Indoor air temp. °C DB											
			16		18		20		21		22		24	
	°C DB	°C WB	TC	PI	TC	PI	TC	PI	TC	PI	TC	PI	TC	PI
130	-24.8	-25	61.2	29.1	61.2	29.37	60.8	29.66	60.8	30.09	60.8	30.52	60.0	31.18
	-21.8	-22	72.6	29.71	72.6	30.03	72.1	30.32	72.1	30.75	72.1	31.18	71.2	31.83
	-19.8	-20	75.7	30.14	75.7	30.47	75.2	30.75	75.2	31.20	75.2	31.61	74.2	32.27
	-18.8	-19	77.3	30.36	77.3	30.69	76.8	30.98	76.8	31.41	76.8	31.83	75.8	32.49
	-16.7	-17	80.7	30.83	80.7	31.15	80.1	31.44	80.1	31.87	80.1	32.29	79.0	32.95
	-13.7	-15	85.5	31.48	85.5	31.81	84.9	32.10	84.9	32.53	84.9	32.95	83.8	31.51
	-11.8	-13	88.2	31.90	88.2	32.22	87.7	32.51	87.7	32.95	87.7	31.97	86.7	30.60
	-9.8	-11	91.2	32.33	91.2	32.67	90.6	32.95	90.6	31.89	90.6	30.94	89.6	29.65
	-9.5	-10	91.7	32.41	91.7	32.73	91.2	32.79	91.2	31.72	91.0	30.79	90.1	29.50
	-8.5	-9.1	93.7	32.62	93.7	32.95	93.2	32.23	93.2	31.20	92.5	30.27	91.5	29.02
	-7.0	-7.6	96.7	32.95	96.7	32.11	96.1	31.40	96.1	30.39	96.1	29.49	94.4	28.30
	-5.0	-5.6	100.7	31.84	100.7	31.01	100.0	30.29	100.0	29.33	100.0	28.46	97.4	27.34
	-3.0	-3.7	104.6	30.72	104.6	29.90	103.9	29.18	103.9	28.26	103.9	27.43	100.6	26.39
	0.0	-0.7	110.4	29.05	110.4	28.23	109.8	27.52	109.8	26.67	109.8	25.88	105.0	24.95
	3.0	2.2	116.4	27.38	116.4	26.56	115.6	25.85	115.6	25.07	114.1	24.32	106.7	23.51
	5.0	4.1	117.6	23.89	117.4	23.12	116.8	22.45	115.6	21.76	112.3	21.08	104.5	20.38
	7.0	6.0	116.7	22.38	116.5	21.67	115.8	21.03	113.4	20.42	109.5	19.81	101.9	19.22
	9.0	7.9	112.6	20.57	112.3	19.90	112.0	19.32	109.2	18.76	105.5	18.20	98.2	17.66
	11.0	9.8	106.5	18.99	106.3	18.39	106.0	17.85	103.3	17.33	99.7	16.82	92.8	16.31
	13.0	11.8	100.0	17.18	99.8	16.62	99.5	16.14	97.0	15.67	93.7	15.21	87.2	14.74
15.0	13.7	94.6	15.61	94.4	15.10	94.1	14.67	91.8	14.24	88.6	13.82	82.5	13.40	
120	-24.8	-25	60.8	29.37	60.8	29.66	60.4	30.09	60.4	30.52	60.4	31.18	59.6	31.64
	-21.8	-22	72.1	30.03	72.1	30.32	71.6	30.75	71.6	31.18	71.6	31.83	70.7	32.29
	-19.8	-20	75.1	30.47	75.1	30.75	74.6	31.20	74.6	31.61	74.6	32.27	73.7	32.73
	-18.8	-19	76.7	30.69	76.7	30.98	76.2	31.41	76.2	31.83	76.2	32.49	75.3	32.95
	-16.7	-17	80.1	31.15	80.1	31.44	79.6	31.87	79.6	32.29	79.6	32.95	78.5	32.03
	-13.7	-15	84.8	31.81	84.8	32.10	84.3	32.53	84.3	32.95	84.3	31.56	83.2	30.71
	-11.8	-13	87.6	32.22	87.6	32.51	87.0	32.95	87.0	31.96	87.0	30.68	86.1	29.87
	-9.8	-11	90.5	32.67	90.5	32.95	90.0	31.85	90.0	30.92	90.0	29.75	89.0	28.99
	-9.5	-10	91.1	32.73	91.1	32.77	90.6	31.69	90.6	30.77	90.6	29.62	89.6	28.86
	-8.5	-9.1	93.1	32.95	93.1	32.18	92.5	31.13	92.5	30.24	92.3	29.16	91.3	28.42
	-7.0	-7.6	96.0	32.06	96.0	31.31	95.4	30.32	95.4	29.47	94.8	28.46	93.7	27.75
	-5.0	-5.6	99.9	30.87	99.9	30.13	99.3	29.22	99.3	28.42	99.3	27.53	96.8	26.87
	-3.0	-3.7	103.9	29.68	103.9	28.96	103.2	28.11	103.2	27.39	103.2	26.61	99.4	25.99
	0.0	-0.7	109.7	27.89	109.7	27.19	109.0	26.47	109.0	25.83	107.8	25.22	100.2	24.67
	3.0	2.2	115.6	26.10	115.6	25.43	113.9	24.83	111.3	24.27	107.8	23.83	100.2	23.35
	5.0	4.1	116.8	22.64	116.0	22.01	112.8	21.49	109.1	21.03	105.7	20.69	98.2	20.28
	7.0	6.0	115.9	21.11	114.5	20.54	110.0	20.13	106.3	19.75	103.0	19.56	95.7	19.22
	9.0	7.9	111.8	19.36	110.3	18.83	106.0	18.46	102.4	18.10	99.2	17.93	92.2	17.61
	11.0	9.8	105.7	17.85	104.3	17.36	100.2	17.01	96.8	16.69	93.8	16.53	87.2	16.24
	13.0	11.8	99.3	16.09	98.0	15.65	94.1	15.34	91.0	15.05	88.2	14.91	81.8	14.64
15.0	13.7	94.0	14.58	92.7	14.18	89.0	13.90	86.0	13.64	83.4	13.51	77.5	13.26	
110	-24.8	-25	60.4	29.66	60.4	30.09	60.1	30.52	60.1	31.18	60.1	31.64	59.3	31.85
	-21.8	-22	71.8	30.32	71.8	30.75	71.3	31.18	71.3	31.83	71.3	32.29	70.4	32.51
	-19.8	-20	74.7	30.75	74.7	31.20	74.3	31.61	74.3	32.27	74.3	32.73	73.2	32.95
	-18.8	-19	76.3	30.98	76.3	31.41	75.8	31.83	75.8	32.49	75.8	32.95	74.8	32.47
	-16.7	-17	79.6	31.44	79.6	31.87	79.1	32.29	79.1	32.95	79.1	31.96	78.0	31.47
	-13.7	-15	84.4	32.10	84.4	32.53	83.8	32.95	83.8	31.45	83.8	30.55	83.8	30.04
	-11.8	-13	87.2	32.51	87.2	32.95	86.5	31.88	86.5	30.50	86.5	29.66	86.5	29.14
	-9.8	-11	90.0	32.95	90.0	31.75	89.5	30.77	89.5	29.50	89.5	28.72	88.8	28.19
	-9.5	-10	90.6	32.75	90.6	31.56	90.1	30.60	90.1	29.35	90.1	28.58	89.9	28.04
	-8.5	-9.1	92.6	32.10	92.6	30.96	92.0	30.04	92.0	28.84	92.0	28.10	90.2	27.56
	-7.0	-7.6	95.5	31.11	95.5	30.05	94.9	29.20	94.9	28.09	94.9	27.41	90.2	26.85
	-5.0	-5.6	99.4	29.80	99.4	28.84	98.7	28.08	98.7	27.09	96.5	26.46	90.2	25.89
	-3.0	-3.7	103.2	28.49	103.2	27.64	102.5	26.95	100.0	26.09	96.5	25.52	90.2	24.95
	0.0	-0.7	109.1	26.52	108.7	25.83	103.3	25.27	100.0	24.59	96.5	24.12	90.2	23.52
	3.0	2.2	114.5	24.55	110.1	24.01	103.3	23.59	100.0	23.10	96.5	22.70	90.2	22.09
	5.0	4.1	114.2	21.11	107.9	20.68	101.3	20.35	98.0	19.97	94.7	19.65	88.4	19.08
	7.0	6.0	111.2	19.51	105.2	19.22	98.7	19.00	95.5	18.78	92.2	18.53	86.2	17.96
	9.0	7.9	107.2	17.80	101.3	17.53	95.0	17.34	92.0	17.13	88.8	16.91	83.0	16.39
	11.0	9.8	101.3	16.32	95.8	16.08	89.9	15.89	87.0	15.70	84.0	15.50	78.5	15.02
	13.0	11.8	95.2	14.63	90.0	14.40	84.5	14.24	81.7	14.06	78.9	13.88	73.7	13.46
15.0	13.7	90.0	13.14	85.1	12.95	79.9	12.80	77.3	12.65	74.7	12.48	69.7	12.09	

# 7. Capacity Tables

Heating Capacity (30HP)

Combination (%)	Outdoor air temp.		Indoor air temp. °C DB											
			16		18		20		21		22		24	
	°C DB	°C WB	TC	PI	TC	PI	TC	PI	TC	PI	TC	PI	TC	PI
100	-24.8	-25	60.1	31.87	60.1	32.01	59.8	30.76	59.8	32.36	59.8	32.52	59.0	32.59
	-21.8	-22	71.4	32.09	71.4	32.23	71.0	31.74	71.0	32.58	71.0	33.04	70.0	32.81
	-19.8	-20	74.4	32.23	74.4	32.37	73.9	32.36	73.9	32.72	73.9	32.98	73.0	32.95
	-18.8	-19	76.0	32.30	75.5	32.45	75.5	32.58	75.5	32.79	75.5	32.95	74.5	32.38
	-16.7	-17	78.8	32.45	78.8	32.60	78.8	33.04	78.4	32.95	78.4	31.77	77.3	31.20
	-13.7	-15	84.0	32.67	84.0	32.81	83.5	32.95	83.5	31.23	83.5	30.10	82.4	29.50
	-11.8	-13	86.7	32.81	86.2	32.95	86.2	31.78	86.2	30.13	86.2	29.02	82.4	28.42
	-9.8	-11	89.5	32.95	89.5	31.63	89.2	30.55	89.2	28.99	88.5	27.91	82.4	27.29
	-9.5	-10	90.1	32.74	90.1	31.43	89.7	30.36	89.7	28.81	88.5	27.74	82.4	27.12
	-8.5	-9.1	92.1	32.04	92.1	30.78	91.6	29.75	91.5	28.23	88.5	27.17	82.4	26.56
	-7.0	-7.6	96.5	30.99	96.2	29.78	94.5	28.82	91.5	27.38	88.5	26.34	82.4	25.70
	-5.0	-5.6	100.8	29.60	99.8	28.47	94.5	27.59	91.5	26.23	88.5	25.21	82.4	24.57
	-3.0	-3.7	103.7	28.20	100.5	27.15	94.5	26.36	91.5	25.07	88.5	24.10	82.4	23.44
	0.0	-0.7	106.6	26.12	100.5	25.17	94.5	24.51	91.5	23.35	88.5	22.41	82.4	21.74
	3.0	2.2	106.6	24.02	100.5	23.19	94.5	22.66	91.5	21.63	88.5	20.74	82.4	20.04
	5.0	4.1	104.5	20.57	98.5	19.85	92.6	19.42	89.7	18.53	86.7	17.73	80.8	17.10
	7.0	6.0	101.8	18.89	96.0	18.29	90.2	17.98	87.3	17.20	84.5	16.46	78.7	15.83
	9.0	7.9	98.0	16.95	92.5	16.41	87.0	16.13	84.2	15.43	81.4	14.76	75.8	14.19
	11.0	9.8	92.7	15.22	87.5	14.74	82.2	14.49	79.6	13.86	77.0	13.26	71.7	12.75
	13.0	11.8	87.1	13.30	82.2	12.88	77.2	12.66	74.7	12.12	72.3	11.58	67.3	11.14
15.0	13.7	82.4	11.60	77.7	11.23	73.0	11.03	70.7	10.56	68.3	10.11	63.7	9.72	
90	-24.8	-25	59.9	28.89	59.9	29.55	59.6	30.01	59.6	30.23	59.6	30.67	58.8	31.33
	-21.8	-22	71.1	29.55	71.1	30.21	70.7	30.67	70.7	30.89	70.7	31.33	69.7	29.89
	-19.8	-20	74.1	29.99	74.1	30.64	73.6	31.10	73.6	31.33	73.6	30.34	72.7	28.94
	-18.8	-19	76.0	30.21	75.5	30.87	75.2	31.33	75.2	30.82	75.2	29.85	74.2	28.47
	-16.7	-17	78.8	30.67	78.8	31.33	78.4	30.26	78.4	29.74	78.4	28.82	75.3	27.47
	-13.7	-15	84.0	31.33	84.0	29.74	83.2	28.75	83.2	28.22	81.1	27.34	75.3	26.03
	-11.8	-13	86.7	30.23	86.2	28.73	85.9	27.79	83.8	27.25	81.1	26.40	75.3	25.13
	-9.8	-11	89.5	29.08	89.5	27.68	86.5	26.78	83.8	26.23	81.1	25.42	75.3	24.18
	-9.5	-10	90.1	28.90	90.1	27.52	86.5	26.63	83.8	26.08	81.1	25.27	75.3	24.04
	-8.5	-9.1	92.1	28.33	91.4	27.00	86.5	26.12	83.8	25.56	81.1	24.78	75.3	23.55
	-7.0	-7.6	96.5	27.46	91.8	26.20	86.5	25.36	83.8	24.80	81.1	24.04	75.3	22.84
	-5.0	-5.6	97.6	26.31	91.8	25.14	86.5	24.36	83.8	23.79	81.1	23.05	75.3	21.89
	-3.0	-3.7	97.6	25.16	91.8	24.09	86.5	23.35	83.8	22.76	81.1	22.06	75.3	20.93
	0.0	-0.7	97.6	23.43	91.8	22.50	86.5	21.83	83.8	21.24	81.1	20.60	75.3	19.50
	3.0	2.2	97.6	21.70	91.8	20.91	86.5	20.32	83.8	19.71	81.1	19.12	75.3	18.08
	5.0	4.1	95.7	18.62	90.0	17.96	84.7	17.44	82.1	16.90	79.5	16.37	73.8	15.45
	7.0	6.0	93.2	17.26	87.7	16.73	82.5	16.28	80.0	15.73	77.5	15.26	72.0	14.39
	9.0	7.9	89.8	15.49	84.5	15.01	79.5	14.60	77.0	14.11	74.6	13.69	69.3	12.91
	11.0	9.8	85.0	13.77	79.9	13.34	75.2	12.99	72.9	12.55	70.5	12.18	65.5	11.47
	13.0	11.8	79.7	11.79	75.0	11.43	70.7	11.13	68.5	10.74	66.2	10.42	61.5	9.83
15.0	13.7	75.5	10.17	71.0	9.86	66.8	9.59	64.8	9.27	62.7	8.99	58.2	8.48	
80	-24.8	-25	59.6	25.34	59.6	26.00	59.3	26.46	59.3	26.68	59.3	27.78	58.5	26.52
	-21.8	-22	70.4	26.00	70.4	26.66	70.4	27.12	70.4	27.78	70.4	26.52	67.3	25.32
	-19.8	-20	73.3	26.44	73.3	27.09	73.3	27.78	73.3	26.88	72.1	25.68	67.3	24.52
	-18.8	-19	74.9	26.66	74.9	27.78	74.9	27.32	74.4	26.44	72.3	25.26	67.3	24.12
	-16.7	-17	77.3	27.78	77.3	26.82	77.3	26.37	75.0	25.51	72.3	24.38	67.3	23.28
	-13.7	-15	80.8	26.36	79.3	25.46	77.3	25.00	75.0	24.16	72.3	23.12	67.3	22.08
	-11.8	-13	83.3	25.45	80.8	24.59	77.3	24.13	75.0	23.31	72.3	22.32	67.3	21.31
	-9.8	-11	85.5	24.50	81.8	23.68	77.3	23.22	75.0	22.42	72.3	21.48	67.3	20.51
	-9.5	-10	86.0	24.36	82.2	23.54	77.3	23.08	75.0	22.29	72.3	21.35	67.3	20.39
	-8.5	-9.1	86.8	23.89	82.4	23.09	77.3	22.63	75.0	21.84	72.3	20.93	67.3	19.99
	-7.0	-7.6	87.4	23.17	82.4	22.41	77.3	21.94	75.0	21.17	72.3	20.31	67.3	19.39
	-5.0	-5.6	87.4	22.22	82.4	21.50	77.3	21.04	75.0	20.27	72.3	19.46	67.3	18.59
	-3.0	-3.7	87.4	21.27	82.4	20.59	77.3	20.12	75.0	19.39	72.3	18.63	67.3	17.78
	0.0	-0.7	87.4	19.84	82.4	19.23	77.3	18.76	75.0	18.04	72.3	17.36	67.3	16.58
	3.0	2.2	87.4	18.42	82.4	17.86	77.3	17.39	75.0	16.70	72.3	16.10	67.3	15.38
	5.0	4.1	85.7	15.80	80.7	15.32	75.8	14.89	73.5	14.28	70.8	13.78	66.0	13.16
	7.0	6.0	83.5	14.70	78.7	14.28	73.8	13.86	71.7	13.28	69.0	12.84	64.3	12.26
	9.0	7.9	80.4	12.76	75.8	12.41	71.2	12.11	69.0	11.66	66.5	11.24	61.9	10.71
	11.0	9.8	76.0	10.99	71.7	10.69	67.3	10.44	65.3	10.04	63.0	9.68	58.5	9.22
	13.0	11.8	71.4	9.20	67.3	8.95	63.2	8.74	61.3	8.40	59.1	8.11	55.0	7.72
15.0	13.7	67.5	7.93	63.7	7.72	59.8	7.53	58.0	7.24	55.9	6.98	52.0	6.65	

# 7. Capacity Tables

Heating Capacity (30HP)

Combination (%)	Outdoor air temp.		Indoor air temp. °C DB													
			16		18		20		21		22		24			
	°C DB	°C WB	TC	PI	TC	PI	TC	PI	TC	PI	TC	PI	TC	PI		
70	-24.8	-25	59.6	25.66	59.6	25.87	59.3	26.32	59.3	26.98	59.3	26.98	59.3	25.64	57.5	24.38
	-21.8	-22	66.3	26.32	66.3	26.53	65.8	26.98	63.6	25.64	61.7	24.38	57.5	23.17		
	-19.8	-20	70.6	26.76	70.0	26.98	65.8	26.03	63.6	24.74	61.7	23.54	57.5	22.38		
	-18.8	-19	72.6	26.98	70.0	26.48	65.8	25.55	63.6	24.29	61.7	23.13	57.5	21.97		
	-16.7	-17	74.1	25.95	70.0	25.45	65.8	24.56	63.6	23.35	61.7	22.25	57.5	21.13		
	-13.7	-15	74.1	24.49	70.0	23.98	65.8	23.14	63.6	22.00	61.7	21.00	57.5	19.93		
	-11.8	-13	74.1	23.55	70.0	23.04	65.8	22.24	63.6	21.15	61.7	20.20	57.5	19.16		
	-9.8	-11	74.1	22.59	70.0	22.07	65.8	21.30	63.6	20.26	61.7	19.37	57.5	18.36		
	-9.5	-10	74.1	22.43	70.0	21.91	65.8	21.16	63.6	20.13	61.7	19.25	57.5	18.24		
	-8.5	-9.1	74.1	21.95	70.0	21.43	65.8	20.68	63.6	19.68	61.7	18.83	57.5	17.84		
	-7.0	-7.6	74.1	21.22	70.0	20.69	65.8	19.97	63.6	19.01	61.7	18.21	57.5	17.24		
	-5.0	-5.6	74.1	20.24	70.0	19.71	65.8	19.03	63.6	18.11	61.7	17.36	57.5	16.43		
	-3.0	-3.7	74.1	19.27	70.0	18.72	65.8	18.08	63.6	17.21	61.7	16.53	57.5	15.63		
	0.0	-0.7	74.1	17.80	70.0	17.25	65.8	16.66	63.6	15.87	61.7	15.28	57.5	14.42		
	3.0	2.2	74.1	16.34	70.0	15.77	65.8	15.24	63.6	14.53	61.7	14.03	57.5	13.22		
	5.0	4.1	74.1	14.20	68.5	13.38	64.5	12.93	62.3	12.32	60.5	11.91	56.4	11.22		
	7.0	6.0	74.2	13.45	66.8	12.28	62.9	11.88	60.7	11.34	59.0	11.00	55.0	10.34		
	9.0	7.9	71.5	11.34	64.4	10.36	60.5	10.02	58.5	9.56	56.8	9.27	53.0	8.72		
	11.0	9.8	67.6	9.75	60.9	8.91	57.3	8.62	55.3	8.23	53.7	7.98	50.0	7.49		
	13.0	11.8	63.5	8.23	57.2	7.53	53.8	7.27	52.0	6.95	50.4	6.74	47.0	6.33		
15.0	13.7	60.0	7.02	54.1	6.41	50.9	6.20	49.2	5.91	47.7	5.74	44.5	5.39			
60	-24.8	-25	56.8	25.21	56.8	25.66	56.5	26.32	54.5	24.91	52.7	23.59	49.3	22.36		
	-21.8	-22	60.8	25.87	60.2	26.32	56.5	24.91	54.5	23.59	52.7	22.36	49.3	21.17		
	-19.8	-20	63.6	26.32	60.2	25.32	56.5	23.97	54.5	22.71	52.7	21.53	49.3	20.38		
	-18.8	-19	63.6	25.82	60.2	24.82	56.5	23.50	54.5	22.27	52.7	21.12	49.3	19.98		
	-16.7	-17	63.6	24.75	60.2	23.77	56.5	22.52	54.5	21.36	52.7	20.26	49.3	19.15		
	-13.7	-15	63.6	23.23	60.2	22.27	56.5	21.11	54.5	20.04	52.7	19.03	49.3	17.96		
	-11.8	-13	63.6	22.27	60.2	21.33	56.5	20.21	54.5	19.20	52.7	18.25	49.3	17.22		
	-9.8	-11	63.6	21.26	60.2	20.33	56.5	19.28	54.5	18.33	52.7	17.42	49.3	16.42		
	-9.5	-10	63.6	21.10	60.2	20.19	56.5	19.14	54.5	18.19	52.7	17.30	49.3	16.30		
	-8.5	-9.1	63.6	20.60	60.2	19.69	56.5	18.67	54.5	17.76	52.7	16.88	49.3	15.91		
	-7.0	-7.6	63.6	19.84	60.2	18.94	56.5	17.96	54.5	17.10	52.7	16.26	49.3	15.32		
	-5.0	-5.6	63.6	18.83	60.2	17.94	56.5	17.03	54.5	16.22	52.7	15.45	49.3	14.52		
	-3.0	-3.7	63.6	17.82	60.2	16.94	56.5	16.09	54.5	15.34	52.7	14.62	49.3	13.73		
	0.0	-0.7	63.6	16.30	60.2	15.44	56.5	14.68	54.5	14.02	52.7	13.39	49.3	12.54		
	3.0	2.2	63.6	14.79	60.2	13.95	56.5	13.27	54.5	12.71	52.7	12.15	49.3	11.35		
	5.0	4.1	62.3	12.48	59.0	11.73	55.3	11.16	53.5	10.70	51.6	10.25	48.3	9.56		
	7.0	6.0	60.7	11.35	57.5	10.64	53.9	10.14	52.1	9.75	50.3	9.35	47.0	8.70		
	9.0	7.9	58.5	9.48	55.4	8.87	52.0	8.46	50.2	8.13	48.5	7.80	45.3	7.25		
	11.0	9.8	55.3	8.15	52.3	7.63	49.1	7.27	47.5	6.99	45.8	6.71	42.9	6.24		
	13.0	11.8	52.0	6.88	49.2	6.45	46.1	6.14	44.5	5.91	43.0	5.66	40.3	5.27		
15.0	13.7	49.2	5.91	46.5	5.54	43.7	5.22	42.2	5.02	40.7	4.82	38.1	4.53			
50	-24.8	-25	53.0	22.40	50.0	23.06	47.0	21.80	45.5	20.61	44.0	19.50	41.0	18.47		
	-21.8	-22	53.0	23.06	50.0	21.80	47.0	20.61	45.5	19.50	44.0	18.47	41.0	17.48		
	-19.8	-20	53.0	22.17	50.0	20.95	47.0	19.83	45.5	18.75	44.0	17.78	41.0	16.81		
	-18.8	-19	53.0	21.73	50.0	20.52	47.0	19.44	45.5	18.39	44.0	17.44	41.0	16.49		
	-16.7	-17	53.0	20.80	50.0	19.65	47.0	18.61	45.5	17.61	44.0	16.71	41.0	15.79		
	-13.7	-15	53.0	19.47	50.0	18.37	47.0	17.43	45.5	16.50	44.0	15.67	41.0	14.80		
	-11.8	-13	53.0	18.63	50.0	17.57	47.0	16.67	45.5	15.79	44.0	15.02	41.0	14.18		
	-9.8	-11	53.0	17.74	50.0	16.73	47.0	15.89	45.5	15.05	44.0	14.33	41.0	13.51		
	-9.5	-10	53.0	17.61	50.0	16.61	47.0	15.77	45.5	14.94	44.0	14.23	41.0	13.42		
	-8.5	-9.1	53.0	17.16	50.0	16.18	47.0	15.38	45.5	14.57	44.0	13.89	41.0	13.09		
	-7.0	-7.6	53.0	16.50	50.0	15.55	47.0	14.79	45.5	14.01	44.0	13.37	41.0	12.59		
	-5.0	-5.6	53.0	15.61	50.0	14.71	47.0	14.01	45.5	13.27	44.0	12.68	41.0	11.94		
	-3.0	-3.7	53.0	14.72	50.0	13.86	47.0	13.21	45.5	12.53	44.0	11.99	41.0	11.27		
	0.0	-0.7	53.0	13.40	50.0	12.59	47.0	12.04	45.5	11.42	44.0	10.95	41.0	10.28		
	3.0	2.2	53.0	12.07	50.0	11.33	47.0	10.85	45.5	10.30	44.0	9.92	41.0	9.29		
	5.0	4.1	52.0	10.13	49.0	9.48	46.1	9.11	44.6	8.65	43.2	8.35	40.2	7.81		
	7.0	6.0	50.7	9.17	47.8	8.58	44.9	8.26	43.5	7.85	42.0	7.61	39.2	7.09		
	9.0	7.9	48.8	7.72	46.0	7.23	43.3	6.96	41.9	6.62	40.5	6.42	37.7	5.98		
	11.0	9.8	46.4	6.72	43.8	6.29	41.1	6.06	39.6	5.75	38.3	5.58	35.7	5.20		
	13.0	11.8	43.3	5.61	40.9	5.25	38.5	5.06	37.2	4.83	36.0	4.66	33.5	4.38		
15.0	13.7	41.0	4.84	38.7	4.53	36.3	4.36	35.2	4.15	34.0	4.01	31.7	3.74			

**Note**

1. TC: Total Capacity(kW), PI : Power Input(kW, Comp. + Outdoor fan motor)
2. Capacity tables show the average value of conditions which may occur.
3. The heating capacity table is based on the values expressed as Max. in the specification of the outdoor unit. (When measuring the Max. heating capacity, the setting status of the indoor unit is the same as that for measuring the heating capacity of the indoor unit.)



# 7. Capacity Tables

## ◆ ARUM320LTE5

Heating Capacity (32HP)

Combination (%)	Outdoor air temp.		Indoor air temp. °C DB											
			16		18		20		21		22		24	
	°C DB	°C WB	TC	PI	TC	PI	TC	PI	TC	PI	TC	PI	TC	PI
130	-24.8	-25	63.4	32.7	63.4	32.93	63.0	33.18	63.0	33.55	63.0	33.92	62.2	34.48
	-21.8	-22	76.4	33.22	76.4	33.50	75.9	33.75	75.9	34.12	75.9	34.48	74.9	35.04
	-19.8	-20	80.3	33.59	80.3	33.88	79.7	34.12	79.7	34.50	79.7	34.85	78.7	35.42
	-18.8	-19	82.0	33.78	82.0	34.06	81.5	34.31	81.5	34.68	81.5	35.04	80.4	35.60
	-16.7	-17	85.8	34.18	85.8	34.46	85.3	34.71	85.3	35.08	85.3	35.43	84.1	36.00
	-13.7	-15	91.2	34.75	91.2	35.02	90.7	35.27	90.7	35.64	90.7	36.00	89.4	34.55
	-11.8	-13	94.2	35.10	94.2	35.38	93.6	35.63	93.6	36.00	93.6	36.00	92.7	33.63
	-9.8	-11	97.3	35.47	97.3	35.76	96.7	36.00	96.7	36.00	96.7	36.00	95.9	32.67
	-9.5	-10	97.9	35.54	97.9	35.81	97.3	35.84	97.3	36.00	97.3	36.00	96.4	32.52
	-8.5	-9.1	100.0	35.72	100.0	36.00	99.4	35.29	99.4	36.00	99.4	36.00	98.7	32.03
	-7.0	-7.6	103.2	36.00	103.2	35.19	102.5	34.48	102.5	33.46	102.5	32.54	101.2	31.31
	-5.0	-5.6	107.3	34.94	107.3	34.12	106.6	33.39	106.6	32.41	106.6	31.51	104.6	30.34
	-3.0	-3.7	111.5	33.88	111.5	33.04	110.8	32.30	110.8	31.35	110.8	30.47	108.1	29.37
	0.0	-0.7	117.6	32.29	117.6	31.43	117.0	30.66	117.0	29.77	117.0	28.92	113.1	27.92
	3.0	2.2	123.9	30.70	123.9	29.81	123.1	29.03	123.1	28.18	121.6	27.36	113.8	26.47
	5.0	4.1	125.2	26.94	125.0	26.08	124.3	25.34	123.1	24.56	119.8	23.82	111.5	23.04
	7.0	6.0	124.3	25.43	124.1	24.61	123.4	23.90	121.0	23.20	116.8	22.51	108.7	21.84
	9.0	7.9	120.1	23.54	119.8	22.78	119.5	22.12	116.5	21.47	112.5	20.84	104.7	20.22
	11.0	9.8	113.6	21.94	113.3	21.24	113.0	20.61	110.2	20.01	106.4	19.42	99.0	18.84
	13.0	11.8	106.7	20.04	106.4	19.39	106.1	18.83	103.5	18.28	99.9	17.74	93.0	17.20
15.0	13.7	100.9	18.43	100.7	17.83	100.3	17.32	97.9	16.81	94.5	16.32	88.0	15.82	
120	-24.8	-25	63.0	32.93	63.0	33.18	62.5	33.55	62.5	33.92	62.5	34.48	61.7	34.88
	-21.8	-22	75.9	33.50	75.9	33.75	75.4	34.12	75.4	34.48	75.4	35.04	74.4	35.43
	-19.8	-20	79.7	33.88	79.7	34.12	79.2	34.50	79.2	34.85	79.2	35.42	78.1	35.81
	-18.8	-19	81.5	34.06	81.5	34.31	81.0	34.68	81.0	35.04	81.0	35.60	79.9	36.00
	-16.7	-17	85.3	34.46	85.3	34.71	84.7	35.08	84.7	35.43	84.7	36.00	83.5	35.07
	-13.7	-15	90.5	35.02	90.5	35.27	90.0	35.64	90.0	36.00	90.0	36.00	88.8	33.74
	-11.8	-13	93.5	35.38	93.5	35.63	92.9	36.00	92.9	35.01	92.9	33.72	92.0	32.89
	-9.8	-11	96.6	35.76	96.6	36.00	96.0	34.91	96.0	33.97	96.0	32.79	95.3	32.00
	-9.5	-10	97.3	35.81	97.3	35.83	96.7	34.75	96.7	33.81	96.7	32.65	95.9	31.87
	-8.5	-9.1	99.3	36.00	99.3	35.24	98.7	34.19	98.7	33.29	98.7	32.19	97.8	31.42
	-7.0	-7.6	102.4	35.13	102.4	34.37	101.8	33.38	101.8	32.51	101.6	31.49	100.4	30.75
	-5.0	-5.6	106.6	33.96	106.6	33.21	105.8	32.28	105.8	31.46	105.8	30.56	104.0	29.86
	-3.0	-3.7	110.7	32.79	110.7	32.05	110.0	31.18	110.0	30.42	110.0	29.63	106.9	28.97
	0.0	-0.7	116.8	31.04	116.8	30.30	116.1	29.54	116.1	28.86	114.9	28.23	106.9	27.64
	3.0	2.2	123.1	29.28	123.1	28.55	121.4	27.90	118.7	27.30	115.0	26.84	106.9	26.31
	5.0	4.1	124.4	25.53	123.5	24.84	120.3	24.27	116.3	23.75	112.8	23.39	104.8	22.93
	7.0	6.0	123.5	23.98	122.1	23.34	117.3	22.87	113.4	22.44	109.9	22.23	102.1	21.83
	9.0	7.9	119.2	22.15	117.6	21.55	113.0	21.13	109.3	20.72	105.9	20.52	98.3	20.15
	11.0	9.8	112.8	20.59	111.2	20.02	106.9	19.63	103.3	19.25	100.1	19.08	93.0	18.73
	13.0	11.8	105.9	18.74	104.5	18.23	100.3	17.87	97.0	17.53	94.1	17.37	87.3	17.06
15.0	13.7	100.2	17.17	98.9	16.70	94.9	16.38	91.8	16.07	89.0	15.92	82.6	15.63	
110	-24.8	-25	62.6	33.18	62.6	33.55	62.2	33.92	62.2	34.48	62.2	34.88	61.4	35.06
	-21.8	-22	75.5	33.75	75.5	34.12	75.0	34.48	75.0	35.04	75.0	35.43	74.0	35.63
	-19.8	-20	79.2	34.12	79.2	34.50	78.8	34.85	78.8	35.42	78.8	35.81	77.6	36.00
	-18.8	-19	81.0	34.31	81.0	34.68	80.5	35.04	80.5	35.60	80.5	36.00	79.4	35.51
	-16.7	-17	84.8	34.71	84.8	35.08	84.2	35.43	84.2	36.00	84.2	36.00	83.0	34.49
	-13.7	-15	90.1	35.27	90.1	35.64	89.4	36.00	89.4	34.48	89.4	33.56	89.4	33.02
	-11.8	-13	93.0	35.63	93.0	36.00	92.4	34.92	92.4	33.52	92.4	32.65	92.4	32.10
	-9.8	-11	96.1	36.00	96.1	34.79	95.5	33.79	95.5	32.50	95.5	31.70	95.1	31.12
	-9.5	-10	96.7	35.80	96.7	34.59	96.2	33.62	96.2	32.35	96.2	31.56	95.9	30.97
	-8.5	-9.1	98.8	35.15	98.8	33.99	98.1	33.06	98.1	31.83	98.1	31.07	96.2	30.49
	-7.0	-7.6	101.9	34.15	101.9	33.07	101.3	32.20	101.3	31.07	101.3	30.36	96.2	29.76
	-5.0	-5.6	106.0	32.83	106.0	31.85	105.3	31.07	105.3	30.06	103.0	29.40	96.2	28.78
	-3.0	-3.7	110.0	31.52	110.0	30.64	109.2	29.93	106.6	29.04	103.0	28.44	96.2	27.81
	0.0	-0.7	116.2	29.53	115.8	28.81	110.2	28.23	106.6	27.51	103.0	27.01	96.2	26.34
	3.0	2.2	121.9	27.55	117.4	26.97	110.2	26.52	106.6	26.00	103.0	25.57	96.2	24.88
	5.0	4.1	121.8	23.81	115.1	23.34	108.0	22.98	104.5	22.57	101.0	22.21	94.3	21.57
	7.0	6.0	118.7	22.17	112.2	21.84	105.3	21.59	101.8	21.33	98.4	21.06	91.9	20.40
	9.0	7.9	114.3	20.37	108.0	20.06	101.4	19.83	98.1	19.60	94.7	19.35	88.5	18.75
	11.0	9.8	108.1	18.82	102.2	18.54	95.9	18.33	92.8	18.11	89.6	17.88	83.7	17.32
	13.0	11.8	101.5	17.03	96.0	16.77	90.1	16.57	87.1	16.37	84.2	16.16	78.6	15.67
15.0	13.7	96.0	15.47	90.7	15.24	85.3	15.07	82.4	14.89	79.7	14.69	74.4	14.24	

# 7. Capacity Tables

Heating Capacity (32HP)

Combination (%)	Outdoor air temp.		Indoor air temp. °C DB											
			16		18		20		21		22		24	
	°C DB	°C WB	TC	PI	TC	PI	TC	PI	TC	PI	TC	PI	TC	PI
100	-24.8	-25	62.3	36.69	62.3	36.60	62.0	34.28	62.0	36.37	62.0	36.28	61.1	36.23
	-21.8	-22	75.1	36.56	75.1	36.46	74.7	35.36	74.7	36.24	74.7	36.63	73.6	36.10
	-19.8	-20	78.9	36.46	78.9	36.36	78.4	36.04	78.4	36.14	78.4	36.21	77.3	36.00
	-18.8	-19	80.7	36.41	80.2	36.33	80.2	36.24	80.2	36.09	80.2	36.00	79.1	35.41
	-16.7	-17	83.9	36.32	83.9	36.23	83.9	36.63	83.4	36.00	83.4	34.78	82.2	34.18
	-13.7	-15	89.6	36.18	89.6	36.09	89.1	36.00	89.1	34.23	89.1	33.04	87.9	32.41
	-11.8	-13	92.5	36.10	92.0	36.00	92.0	34.81	92.0	33.10	92.0	31.93	87.9	31.28
	-9.8	-11	95.6	36.00	95.6	34.66	95.2	33.55	95.2	31.92	94.4	30.77	87.9	30.10
	-9.5	-10	96.2	35.79	96.2	34.45	95.7	33.35	95.7	31.74	94.4	30.60	87.9	29.93
	-8.5	-9.1	98.3	35.08	98.3	33.79	97.8	32.73	97.6	31.14	94.4	30.01	87.9	29.34
	-7.0	-7.6	103.0	34.02	102.6	32.77	100.8	31.77	97.6	30.25	94.4	29.14	87.9	28.45
	-5.0	-5.6	107.5	32.60	106.4	31.43	100.8	30.51	97.6	29.07	94.4	27.98	87.9	27.28
	-3.0	-3.7	110.6	31.19	107.2	30.09	100.8	29.26	97.6	27.88	94.4	26.82	87.9	26.10
	0.0	-0.7	113.7	29.07	107.2	28.07	100.8	27.36	97.6	26.11	94.4	25.07	87.9	24.33
	3.0	2.2	113.7	26.94	107.2	26.05	100.8	25.47	97.6	24.33	94.4	23.34	87.9	22.56
	5.0	4.1	111.4	23.19	105.1	22.40	98.7	21.93	95.7	20.93	92.5	20.04	86.1	19.32
	7.0	6.0	108.6	21.46	102.4	20.79	96.3	20.42	93.1	19.54	90.1	18.70	84.0	17.98
	9.0	7.9	104.6	19.58	98.7	18.96	92.8	18.63	89.8	17.82	86.9	17.05	80.8	16.39
	11.0	9.8	98.9	17.93	93.3	17.36	87.7	17.07	84.9	16.32	82.1	15.62	76.5	15.02
	13.0	11.8	92.9	16.05	87.7	15.55	82.4	15.28	79.7	14.62	77.1	13.98	71.8	13.44
15.0	13.7	87.9	14.42	82.9	13.96	77.9	13.72	75.4	13.13	72.9	12.56	68.0	12.08	
90	-24.8	-25	62.1	32.64	62.1	33.20	61.7	33.60	61.7	33.78	61.7	34.17	60.9	34.73
	-21.8	-22	74.8	33.20	74.8	33.77	74.4	34.17	74.4	34.35	74.4	34.73	73.3	33.18
	-19.8	-20	78.6	33.59	78.6	34.14	78.1	34.54	78.1	34.73	78.1	33.67	77.1	32.16
	-18.8	-19	80.7	33.77	80.2	34.34	79.9	34.73	79.9	34.18	79.9	33.14	78.8	31.64
	-16.7	-17	83.9	34.17	83.9	34.73	83.5	33.59	83.5	33.03	83.5	32.03	80.3	30.56
	-13.7	-15	89.6	34.73	89.6	33.03	88.8	31.97	88.8	31.40	86.5	30.44	80.3	29.02
	-11.8	-13	92.5	33.56	92.0	31.96	91.7	30.94	89.4	30.36	86.5	29.43	80.3	28.04
	-9.8	-11	95.6	32.34	95.6	30.84	92.2	29.87	89.4	29.26	86.5	28.38	80.3	27.01
	-9.5	-10	96.2	32.15	96.2	30.66	92.2	29.70	89.4	29.09	86.5	28.22	80.3	26.86
	-8.5	-9.1	98.3	31.54	97.5	30.11	92.2	29.16	89.4	28.55	86.5	27.69	80.3	26.34
	-7.0	-7.6	103.0	30.62	97.9	29.26	92.2	28.35	89.4	27.73	86.5	26.89	80.3	25.57
	-5.0	-5.6	104.1	29.39	97.9	28.13	92.2	27.27	89.4	26.64	86.5	25.83	80.3	24.55
	-3.0	-3.7	104.1	28.17	97.9	27.00	92.2	26.19	89.4	25.54	86.5	24.77	80.3	23.51
	0.0	-0.7	104.1	26.33	97.9	25.30	92.2	24.57	89.4	23.90	86.5	23.19	80.3	21.97
	3.0	2.2	104.1	24.49	97.9	23.62	92.2	22.95	89.4	22.27	86.5	21.60	80.3	20.43
	5.0	4.1	102.1	21.07	96.0	20.34	90.4	19.75	87.5	19.13	84.8	18.54	78.7	17.50
	7.0	6.0	99.4	19.61	93.6	19.01	88.0	18.50	85.3	17.87	82.6	17.34	76.8	16.34
	9.0	7.9	95.8	17.89	90.1	17.34	84.8	16.87	82.2	16.30	79.5	15.81	73.9	14.91
	11.0	9.8	90.6	16.23	85.3	15.72	80.2	15.30	77.8	14.78	75.2	14.34	69.9	13.52
	13.0	11.8	85.1	14.23	80.0	13.79	75.4	13.43	73.0	12.96	70.7	12.58	65.6	11.86
15.0	13.7	80.5	12.64	75.7	12.26	71.3	11.93	69.1	11.52	66.9	11.18	62.1	10.54	
80	-24.8	-25	61.8	28.70	61.8	29.27	61.5	29.67	61.5	29.85	61.5	30.80	60.6	29.44
	-21.8	-22	74.0	29.27	74.0	29.84	74.0	30.23	74.0	30.80	74.0	29.44	71.8	28.14
	-19.8	-20	77.8	29.65	77.8	30.21	77.8	30.80	77.8	29.83	76.9	28.53	71.8	27.27
	-18.8	-19	79.6	29.84	79.6	30.80	79.6	30.30	79.4	29.35	77.1	28.08	71.8	26.84
	-16.7	-17	82.5	30.80	82.5	29.77	82.5	29.28	80.0	28.35	77.1	27.13	71.8	25.93
	-13.7	-15	86.2	29.28	84.6	28.31	82.5	27.81	80.0	26.90	77.1	25.77	71.8	24.63
	-11.8	-13	88.5	28.31	85.9	27.38	82.5	26.88	80.0	25.99	77.1	24.91	71.8	23.80
	-9.8	-11	90.9	27.29	87.1	26.41	82.5	25.90	80.0	25.03	77.1	24.01	71.8	22.94
	-9.5	-10	91.5	27.14	87.5	26.26	82.5	25.75	80.0	24.89	77.1	23.87	71.8	22.80
	-8.5	-9.1	92.4	26.64	87.9	25.78	82.5	25.27	80.0	24.40	77.1	23.41	71.8	22.38
	-7.0	-7.6	93.3	25.88	87.9	25.04	82.5	24.53	80.0	23.68	77.1	22.74	71.8	21.72
	-5.0	-5.6	93.3	24.86	87.9	24.08	82.5	23.56	80.0	22.72	77.1	21.82	71.8	20.86
	-3.0	-3.7	93.3	23.84	87.9	23.10	82.5	22.58	80.0	21.76	77.1	20.92	71.8	19.98
	0.0	-0.7	93.3	22.32	87.9	21.64	82.5	21.11	80.0	20.32	77.1	19.56	71.8	18.68
	3.0	2.2	93.3	20.80	87.9	20.17	82.5	19.64	80.0	18.87	77.1	18.20	71.8	17.39
	5.0	4.1	91.4	17.89	86.1	17.35	80.8	16.86	78.4	16.17	75.5	15.61	70.4	14.91
	7.0	6.0	89.0	16.70	83.9	16.22	78.7	15.75	76.5	15.09	73.6	14.59	68.5	13.93
	9.0	7.9	85.8	14.80	80.8	14.38	75.9	14.03	73.6	13.50	71.0	13.02	66.1	12.40
	11.0	9.8	81.1	13.00	76.5	12.64	71.8	12.34	69.6	11.86	67.1	11.44	62.4	10.89
	13.0	11.8	76.2	11.15	71.8	10.84	67.4	10.58	65.4	10.17	63.0	9.81	58.7	9.34
15.0	13.7	72.0	9.90	68.0	9.63	63.8	9.39	61.9	9.03	59.7	8.70	55.5	8.29	

# 7. Capacity Tables

Heating Capacity (32HP)

Combination (%)	Outdoor air temp.		Indoor air temp. °C DB											
			16		18		20		21		22		24	
	°C DB	°C WB	TC	PI	TC	PI	TC	PI	TC	PI	TC	PI	TC	PI
70	-24.8	-25	61.8	28.79	61.8	28.98	61.5	29.36	61.5	29.92	61.5	28.47	60.5	27.10
	-21.8	-22	70.7	29.36	70.7	29.54	70.2	29.92	67.8	28.47	65.8	27.10	61.4	25.79
	-19.8	-20	76.6	29.74	74.7	29.92	70.2	28.90	67.8	27.50	65.8	26.20	61.4	24.92
	-18.8	-19	78.8	29.92	74.7	29.39	70.2	28.38	67.8	27.00	65.8	25.74	61.4	24.48
	-16.7	-17	79.0	28.82	74.7	28.27	70.2	27.31	67.8	25.99	65.8	24.79	61.4	23.56
	-13.7	-15	79.0	27.24	74.7	26.68	70.2	25.77	67.8	24.53	65.8	23.43	61.4	22.25
	-11.8	-13	79.0	26.23	74.7	25.67	70.2	24.80	67.8	23.60	65.8	22.56	61.4	21.42
	-9.8	-11	79.0	25.19	74.7	24.61	70.2	23.77	67.8	22.63	65.8	21.66	61.4	20.54
	-9.5	-10	79.0	25.02	74.7	24.45	70.2	23.62	67.8	22.49	65.8	21.53	61.4	20.41
	-8.5	-9.1	79.0	24.50	74.7	23.92	70.2	23.11	67.8	22.00	65.8	21.07	61.4	19.98
	-7.0	-7.6	79.0	23.71	74.7	23.13	70.2	22.34	67.8	21.28	65.8	20.39	61.4	19.32
	-5.0	-5.6	79.0	22.66	74.7	22.06	70.2	21.31	67.8	20.30	65.8	19.48	61.4	18.45
	-3.0	-3.7	79.0	21.61	74.7	21.00	70.2	20.29	67.8	19.33	65.8	18.57	61.4	17.57
	0.0	-0.7	79.0	20.03	74.7	19.41	70.2	18.75	67.8	17.88	65.8	17.21	61.4	16.26
	3.0	2.2	79.0	18.45	74.7	17.81	70.2	17.21	67.8	16.42	65.8	15.86	61.4	14.94
	5.0	4.1	79.0	16.08	73.1	15.15	68.8	14.63	66.4	13.95	64.5	13.50	60.2	12.72
	7.0	6.0	79.2	15.28	71.3	13.96	67.1	13.50	64.8	12.89	62.9	12.50	58.7	11.75
	9.0	7.9	76.3	13.10	68.7	11.97	64.6	11.57	62.4	11.04	60.5	10.71	56.5	10.07
	11.0	9.8	72.1	11.49	65.0	10.50	61.1	10.15	59.0	9.69	57.3	9.40	53.4	8.83
	13.0	11.8	67.7	9.94	61.0	9.09	57.4	8.78	55.4	8.38	53.8	8.14	50.2	7.64
15.0	13.7	64.0	8.72	57.7	7.97	54.3	7.71	52.5	7.35	50.9	7.13	47.5	6.71	
60	-24.8	-25	60.6	28.34	60.6	28.72	60.2	29.29	58.2	27.75	56.2	26.30	52.6	24.95
	-21.8	-22	64.9	28.91	64.2	29.29	60.2	27.75	58.2	26.30	56.2	24.95	52.6	23.64
	-19.8	-20	67.8	29.29	64.2	28.20	60.2	26.72	58.2	25.34	56.2	24.04	52.6	22.77
	-18.8	-19	67.8	28.74	64.2	27.66	60.2	26.21	58.2	24.86	56.2	23.59	52.6	22.33
	-16.7	-17	67.8	27.58	64.2	26.50	60.2	25.13	58.2	23.85	56.2	22.65	52.6	21.42
	-13.7	-15	67.8	25.92	64.2	24.87	60.2	23.58	58.2	22.41	56.2	21.29	52.6	20.11
	-11.8	-13	67.8	24.88	64.2	23.83	60.2	22.60	58.2	21.49	56.2	20.43	52.6	19.29
	-9.8	-11	67.8	23.77	64.2	22.74	60.2	21.58	58.2	20.53	56.2	19.53	52.6	18.41
	-9.5	-10	67.8	23.60	64.2	22.58	60.2	21.43	58.2	20.38	56.2	19.39	52.6	18.28
	-8.5	-9.1	67.8	23.05	64.2	22.04	60.2	20.91	58.2	19.91	56.2	18.94	52.6	17.85
	-7.0	-7.6	67.8	22.23	64.2	21.22	60.2	20.14	58.2	19.18	56.2	18.26	52.6	17.20
	-5.0	-5.6	67.8	21.12	64.2	20.13	60.2	19.12	58.2	18.22	56.2	17.36	52.6	16.32
	-3.0	-3.7	67.8	20.02	64.2	19.04	60.2	18.09	58.2	17.26	56.2	16.45	52.6	15.45
	0.0	-0.7	67.8	18.36	64.2	17.39	60.2	16.55	58.2	15.81	56.2	15.10	52.6	14.15
	3.0	2.2	67.8	16.71	64.2	15.76	60.2	15.00	58.2	14.37	56.2	13.74	52.6	12.84
	5.0	4.1	66.4	14.13	62.9	13.28	59.0	12.64	57.0	12.13	55.0	11.61	51.5	10.83
	7.0	6.0	64.8	12.90	61.3	12.09	57.5	11.53	55.5	11.08	53.6	10.62	50.2	9.88
	9.0	7.9	62.4	10.95	59.1	10.25	55.4	9.77	53.6	9.39	51.7	9.01	48.3	8.38
	11.0	9.8	59.0	9.60	55.8	8.99	52.3	8.57	50.6	8.24	48.9	7.90	45.8	7.35
	13.0	11.8	55.4	8.30	52.5	7.78	49.1	7.41	47.5	7.13	45.9	6.83	42.9	6.36
15.0	13.7	52.5	7.35	49.6	6.89	46.6	6.50	45.0	6.25	43.4	5.99	40.6	5.63	
50	-24.8	-25	56.6	25.00	53.4	25.56	50.2	24.19	48.6	22.90	46.9	21.69	43.7	20.56
	-21.8	-22	56.6	25.56	53.4	24.19	50.2	22.90	48.6	21.69	46.9	20.56	43.7	19.47
	-19.8	-20	56.6	24.60	53.4	23.27	50.2	22.04	48.6	20.87	46.9	19.80	43.7	18.74
	-18.8	-19	56.6	24.12	53.4	22.80	50.2	21.62	48.6	20.47	46.9	19.43	43.7	18.39
	-16.7	-17	56.6	23.11	53.4	21.85	50.2	20.72	48.6	19.61	46.9	18.63	43.7	17.63
	-13.7	-15	56.6	21.67	53.4	20.46	50.2	19.42	48.6	18.40	46.9	17.50	43.7	16.54
	-11.8	-13	56.6	20.75	53.4	19.59	50.2	18.61	48.6	17.63	46.9	16.79	43.7	15.86
	-9.8	-11	56.6	19.79	53.4	18.67	50.2	17.75	48.6	16.82	46.9	16.03	43.7	15.13
	-9.5	-10	56.6	19.64	53.4	18.54	50.2	17.62	48.6	16.70	46.9	15.93	43.7	15.02
	-8.5	-9.1	56.6	19.16	53.4	18.07	50.2	17.20	48.6	16.30	46.9	15.55	43.7	14.66
	-7.0	-7.6	56.6	18.43	53.4	17.39	50.2	16.55	48.6	15.69	46.9	14.98	43.7	14.12
	-5.0	-5.6	56.6	17.47	53.4	16.47	50.2	15.70	48.6	14.88	46.9	14.23	43.7	13.40
	-3.0	-3.7	56.6	16.51	53.4	15.55	50.2	14.83	48.6	14.07	46.9	13.47	43.7	12.67
	0.0	-0.7	56.6	15.07	53.4	14.16	50.2	13.55	48.6	12.86	46.9	12.34	43.7	11.59
	3.0	2.2	56.6	13.62	53.4	12.79	50.2	12.26	48.6	11.64	46.9	11.21	43.7	10.50
	5.0	4.1	55.5	11.46	52.3	10.74	49.1	10.32	47.5	9.80	46.1	9.46	42.9	8.85
	7.0	6.0	54.1	10.41	51.0	9.75	47.9	9.39	46.4	8.92	44.8	8.64	41.8	8.06
	9.0	7.9	52.0	8.92	49.1	8.35	46.1	8.04	44.7	7.64	43.2	7.41	40.3	6.91
	11.0	9.8	49.5	7.92	46.7	7.41	43.8	7.14	42.2	6.78	40.8	6.57	38.1	6.13
	13.0	11.8	46.2	6.77	43.7	6.34	41.0	6.10	39.7	5.83	38.4	5.62	35.7	5.28
15.0	13.7	43.7	6.02	41.3	5.63	38.7	5.42	37.6	5.16	36.3	4.99	33.8	4.65	

**Note**

1. TC: Total Capacity(kW), PI : Power Input(kW, Comp. + Outdoor fan motor)
2. Capacity tables show the average value of conditions which may occur.
3. The heating capacity table is based on the values expressed as Max. in the specification of the outdoor unit. (When measuring the Max. heating capacity, the setting status of the indoor unit is the same as that for measuring the heating capacity of the indoor unit.)

# 7. Capacity Tables

## ◆ ARUM340LTE5

Heating Capacity (34HP)

Combination (%)	Outdoor air temp.		Indoor air temp. °C DB											
			16		18		20		21		22		24	
	°C DB	°C WB	TC	PI	TC	PI	TC	PI	TC	PI	TC	PI	TC	PI
130	-24.8	-25	67.3	35.6	67.3	35.90	67.0	36.16	67.0	36.55	67.0	36.93	66.0	37.52
	-21.8	-22	81.2	36.20	81.2	36.49	80.7	36.75	80.7	37.14	80.7	37.52	79.6	38.10
	-19.8	-20	85.3	36.59	85.3	36.89	84.7	37.14	84.7	37.53	84.7	37.91	83.6	38.50
	-18.8	-19	87.2	36.79	87.2	37.08	86.6	37.34	86.6	37.73	86.6	38.10	85.5	38.69
	-16.7	-17	91.2	37.20	91.2	37.49	90.6	37.75	90.6	38.14	90.6	38.51	89.3	39.10
	-13.7	-15	96.9	37.79	96.9	38.08	96.3	38.34	96.3	38.73	96.3	39.10	94.9	37.54
	-11.8	-13	100.1	38.17	100.1	38.46	99.5	38.72	99.5	39.10	99.5	38.05	98.5	36.55
	-9.8	-11	103.5	38.55	103.5	38.85	102.7	39.10	102.7	37.98	102.7	36.94	101.9	35.51
	-9.5	-10	104.1	38.62	104.1	38.91	103.4	38.93	103.4	37.80	103.3	36.77	102.5	35.35
	-8.5	-9.1	106.3	38.81	106.3	39.10	105.6	38.35	105.6	37.23	105.0	36.21	104.2	34.83
	-7.0	-7.6	109.6	39.10	109.6	38.24	108.9	37.47	108.9	36.38	108.9	35.38	107.5	34.05
	-5.0	-5.6	114.0	37.97	114.0	37.09	113.2	36.30	113.2	35.24	113.2	34.26	111.2	33.00
	-3.0	-3.7	118.4	36.84	118.4	35.93	117.6	35.13	117.6	34.10	117.6	33.15	114.9	31.96
	0.0	-0.7	124.9	35.13	124.9	34.20	124.2	33.37	124.2	32.40	124.2	31.47	120.2	30.40
	3.0	2.2	131.5	33.43	131.5	32.46	130.7	31.61	130.7	30.70	129.2	29.80	120.9	28.84
	5.0	4.1	132.9	29.35	132.7	28.42	131.9	27.61	130.7	26.77	127.3	25.95	118.5	25.10
	7.0	6.0	132.1	27.72	131.8	26.83	131.1	26.05	128.6	25.29	124.1	24.54	115.5	23.81
9.0	7.9	127.6	25.69	127.3	24.86	126.9	24.13	123.8	23.43	119.5	22.74	111.3	22.05	
11.0	9.8	120.7	23.95	120.4	23.18	120.1	22.51	117.1	21.85	113.0	21.21	105.2	20.56	
13.0	11.8	113.3	21.90	113.1	21.19	112.8	20.58	109.9	19.98	106.2	19.39	98.8	18.80	
15.0	13.7	107.2	20.16	107.0	19.51	106.6	18.94	104.0	18.39	100.4	17.85	93.5	17.31	
120	-24.8	-25	66.9	35.90	66.9	36.16	66.5	36.55	66.5	36.93	66.5	37.52	65.5	37.93
	-21.8	-22	80.6	36.49	80.6	36.75	80.1	37.14	80.1	37.52	80.1	38.10	79.0	38.51
	-19.8	-20	84.7	36.89	84.7	37.14	84.1	37.53	84.1	37.91	84.1	38.50	83.0	38.91
	-18.8	-19	86.6	37.08	86.6	37.34	86.0	37.73	86.0	38.10	86.0	38.69	84.9	39.10
	-16.7	-17	90.6	37.49	90.6	37.75	90.0	38.14	90.0	38.51	90.0	39.10	88.7	38.11
	-13.7	-15	96.2	38.08	96.2	38.34	95.6	38.73	95.6	39.10	95.6	37.60	94.3	36.67
	-11.8	-13	99.3	38.46	99.3	38.72	98.7	39.10	98.7	38.04	98.7	36.65	97.7	35.75
	-9.8	-11	102.7	38.85	102.7	39.10	102.1	37.93	102.1	36.92	102.1	35.65	101.3	34.79
	-9.5	-10	103.4	38.91	103.4	38.92	102.8	37.76	102.8	36.75	102.8	35.50	101.9	34.65
	-8.5	-9.1	105.6	39.10	105.6	38.29	104.8	37.16	104.8	36.19	104.8	35.00	103.9	33.17
	-7.0	-7.6	108.8	38.17	108.8	37.36	108.2	36.28	108.2	35.35	108.0	34.24	106.7	33.45
	-5.0	-5.6	113.2	36.91	113.2	36.10	112.4	35.10	112.4	34.22	112.4	33.24	110.4	32.49
	-3.0	-3.7	117.6	35.66	117.6	34.85	116.8	33.92	116.8	33.10	116.8	32.24	113.6	31.53
	0.0	-0.7	124.0	33.77	124.0	32.97	123.2	32.15	123.2	31.42	122.0	30.73	113.6	30.09
	3.0	2.2	130.6	31.89	130.6	31.09	128.9	30.38	126.1	29.73	122.2	29.23	113.6	28.66
	5.0	4.1	132.0	27.82	131.2	27.07	127.9	26.44	123.6	25.88	119.8	25.48	111.3	24.98
	7.0	6.0	131.1	26.15	129.8	25.44	124.7	24.94	120.5	24.47	116.7	24.23	108.5	23.80
9.0	7.9	126.7	24.16	125.0	23.51	120.1	23.05	116.1	22.60	112.5	22.39	104.5	21.99	
11.0	9.8	119.8	22.48	118.2	21.86	113.6	21.43	109.7	21.02	106.3	20.82	98.8	20.45	
13.0	11.8	112.5	20.48	111.0	19.92	106.6	19.53	103.1	19.15	99.9	18.98	92.7	18.64	
15.0	13.7	106.5	18.78	105.1	18.27	100.9	17.91	97.5	17.57	94.5	17.41	87.8	17.09	
110	-24.8	-25	66.5	36.16	66.5	36.55	66.1	36.93	66.1	37.52	66.1	37.93	65.2	38.13
	-21.8	-22	80.2	36.75	80.2	37.14	79.7	37.52	79.7	38.10	79.7	38.51	78.6	38.72
	-19.8	-20	84.2	37.14	84.2	37.53	83.8	37.91	83.8	38.50	83.8	38.91	82.5	39.10
	-18.8	-19	86.1	37.34	86.1	37.73	85.5	38.10	85.5	38.69	85.5	39.10	84.4	38.58
	-16.7	-17	90.1	37.75	90.1	38.14	89.5	38.51	89.5	39.10	89.5	38.02	88.2	37.47
	-13.7	-15	95.7	38.34	95.7	38.73	95.1	39.10	95.1	37.47	95.1	36.47	95.1	35.89
	-11.8	-13	98.9	38.72	98.9	39.10	98.2	37.94	98.2	36.43	98.2	35.49	98.2	34.90
	-9.8	-11	102.1	39.10	102.1	37.80	101.5	36.73	101.5	35.33	101.5	34.46	101.0	33.84
	-9.5	-10	102.8	38.89	102.8	37.59	102.2	36.54	102.2	35.16	102.2	34.31	101.9	33.68
	-8.5	-9.1	105.0	38.19	105.0	36.94	104.3	35.93	104.3	34.61	104.3	33.79	102.2	33.16
	-7.0	-7.6	108.2	37.12	108.2	35.95	107.6	35.01	107.6	33.79	107.6	33.02	102.2	32.37
	-5.0	-5.6	112.6	35.69	112.6	34.63	111.8	33.79	111.8	32.70	109.4	31.98	102.2	31.31
	-3.0	-3.7	116.9	34.27	116.9	33.33	116.0	32.56	113.3	31.60	109.4	30.95	102.2	30.26
	0.0	-0.7	123.4	32.13	123.0	31.35	117.1	30.72	113.3	29.95	109.4	29.41	102.2	28.68
	3.0	2.2	129.5	30.00	124.7	29.37	117.1	28.89	113.3	28.32	109.4	27.85	102.2	27.10
	5.0	4.1	129.4	25.94	122.3	25.43	114.8	25.04	111.0	24.59	107.3	24.20	100.2	23.50
	7.0	6.0	126.1	24.17	119.2	23.81	111.9	23.54	108.2	23.25	104.5	22.96	97.7	22.24
9.0	7.9	121.5	22.22	114.8	21.88	107.7	21.64	104.2	21.38	100.7	21.10	94.0	20.45	
11.0	9.8	114.8	20.55	108.5	20.24	101.9	20.01	98.6	19.77	95.2	19.52	88.9	18.91	
13.0	11.8	107.9	18.60	102.0	18.32	95.7	18.11	92.6	17.89	89.5	17.66	83.5	17.12	
15.0	13.7	102.0	16.92	96.4	16.67	90.6	16.48	87.6	16.28	84.6	16.07	79.0	15.57	

# 7. Capacity Tables

Heating Capacity (34HP)

Combination (%)	Outdoor air temp.		Indoor air temp. °C DB											
			16		18		20		21		22		24	
	°C DB	°C WB	TC	PI	TC	PI	TC	PI	TC	PI	TC	PI	TC	PI
100	-24.8	-25	66.2	39.96	66.2	39.84	65.8	37.28	65.8	39.57	65.8	39.45	64.9	39.39
	-21.8	-22	79.8	39.80	79.8	39.68	79.4	38.46	79.4	39.40	79.4	39.81	78.2	39.22
	-19.8	-20	83.9	39.68	83.9	39.56	83.3	39.20	83.3	39.28	83.3	39.34	82.2	39.10
	-18.8	-19	85.7	39.62	85.2	39.51	85.2	39.40	85.2	39.22	85.2	39.10	84.0	38.47
	-16.7	-17	89.2	39.50	89.2	39.39	89.2	39.81	88.6	39.10	88.6	37.79	87.3	37.13
	-13.7	-15	95.2	39.33	95.2	39.21	94.7	39.10	94.7	37.19	94.7	35.91	93.4	35.22
	-11.8	-13	98.3	39.22	97.8	39.10	97.8	37.82	97.8	35.97	97.8	34.71	93.4	34.01
	-9.8	-11	101.6	39.10	101.6	37.65	101.1	36.46	101.1	34.69	100.3	33.46	93.4	32.73
	-9.5	-10	102.2	38.88	102.2	37.44	101.7	36.24	101.7	34.50	100.3	33.26	93.4	32.54
	-8.5	-9.1	104.4	38.11	104.4	36.72	103.9	35.57	103.7	33.86	100.3	32.63	93.4	31.91
	-7.0	-7.6	109.4	36.97	109.0	35.62	107.1	34.54	103.7	32.90	100.3	31.69	93.4	30.95
	-5.0	-5.6	114.2	35.44	113.1	34.17	107.1	33.18	103.7	31.62	100.3	30.44	93.4	29.67
	-3.0	-3.7	117.5	33.92	113.9	32.72	107.1	31.83	103.7	30.33	100.3	29.19	93.4	28.40
	0.0	-0.7	120.8	31.63	113.9	30.54	107.1	29.78	103.7	28.42	100.3	27.30	93.4	26.49
	3.0	2.2	120.8	29.34	113.9	28.37	107.1	27.74	103.7	26.50	100.3	25.42	93.4	24.57
	5.0	4.1	118.4	25.27	111.7	24.41	104.9	23.89	101.6	22.81	98.3	21.83	91.5	21.06
	7.0	6.0	115.4	23.39	108.8	22.66	102.3	22.27	99.0	21.30	95.7	20.38	89.2	19.60
	9.0	7.9	111.1	21.36	104.8	20.69	98.6	20.32	95.4	19.45	92.3	18.60	85.9	17.89
	11.0	9.8	105.1	19.59	99.1	18.97	93.2	18.64	90.2	17.83	87.2	17.06	81.3	16.41
	13.0	11.8	98.7	17.55	93.1	17.00	87.5	16.71	84.7	15.99	81.9	15.29	76.3	14.70
15.0	13.7	93.4	15.79	88.1	15.29	82.8	15.02	80.2	14.37	77.4	13.76	72.2	13.23	
90	-24.8	-25	65.9	35.56	65.9	36.15	65.6	36.56	65.6	36.76	65.6	37.15	64.7	37.75
	-21.8	-22	79.5	36.15	79.5	36.74	79.1	37.15	79.1	37.35	79.1	37.75	77.9	36.07
	-19.8	-20	83.5	36.55	83.5	37.13	83.0	37.54	83.0	37.75	83.0	36.60	81.9	34.96
	-18.8	-19	85.7	36.74	85.2	37.33	84.9	37.75	84.9	37.15	84.9	36.02	83.7	34.40
	-16.7	-17	89.2	37.15	89.2	37.75	88.7	36.51	88.7	35.91	88.7	34.82	85.3	33.23
	-13.7	-15	95.2	37.75	95.2	35.91	94.3	34.76	94.3	34.14	91.9	33.10	85.3	31.56
	-11.8	-13	98.3	36.48	97.8	34.75	97.5	33.65	94.9	33.01	91.9	32.01	85.3	30.50
	-9.8	-11	101.6	35.16	101.6	33.54	98.0	32.48	94.9	31.83	91.9	30.87	85.3	29.39
	-9.5	-10	102.2	34.96	102.2	33.35	98.0	32.31	94.9	31.65	91.9	30.69	85.3	29.22
	-8.5	-9.1	104.4	34.29	103.7	32.74	98.0	31.72	94.9	31.05	91.9	30.12	85.3	28.66
	-7.0	-7.6	109.4	33.30	104.1	31.83	98.0	30.84	94.9	30.17	91.9	29.26	85.3	27.83
	-5.0	-5.6	110.6	31.98	104.1	30.60	98.0	29.67	94.9	28.99	91.9	28.11	85.3	26.72
	-3.0	-3.7	110.6	30.65	104.1	29.39	98.0	28.51	94.9	27.80	91.9	26.96	85.3	25.59
	0.0	-0.7	110.6	28.67	104.1	27.55	98.0	26.75	94.9	26.03	91.9	25.25	85.3	23.93
	3.0	2.2	110.6	26.67	104.1	25.73	98.0	25.00	94.9	24.26	91.9	23.53	85.3	22.26
	5.0	4.1	108.4	22.96	102.0	22.16	96.0	21.52	93.0	20.85	90.1	20.21	83.6	19.07
	7.0	6.0	105.7	21.38	99.4	20.72	93.6	20.17	90.7	19.48	87.8	18.90	81.5	17.82
	9.0	7.9	101.8	19.52	95.8	18.92	90.1	18.41	87.3	17.78	84.5	17.25	78.5	16.27
	11.0	9.8	96.3	17.72	90.6	17.17	85.3	16.71	82.6	16.14	79.9	15.67	74.3	14.77
	13.0	11.8	90.4	15.56	85.0	15.08	80.1	14.68	77.6	14.17	75.1	13.75	69.7	12.97
15.0	13.7	85.5	13.85	80.5	13.43	75.7	13.06	73.4	12.62	71.1	12.25	66.0	11.55	
80	-24.8	-25	65.7	31.28	65.7	31.88	65.3	32.29	65.3	32.48	65.3	33.47	64.4	32.00
	-21.8	-22	78.7	31.88	78.7	32.47	78.7	32.88	78.7	33.47	78.7	32.00	76.2	30.59
	-19.8	-20	82.7	32.27	82.7	32.85	82.7	33.47	82.7	32.43	81.7	31.02	76.2	29.65
	-18.8	-19	84.5	32.47	84.5	33.47	84.5	32.93	84.4	31.90	81.9	30.52	76.2	29.18
	-16.7	-17	87.6	33.47	87.6	32.36	87.6	31.83	85.0	30.82	81.9	29.49	76.2	28.20
	-13.7	-15	91.6	31.82	89.8	30.78	87.6	30.24	85.0	29.25	81.9	28.02	76.2	26.79
	-11.8	-13	94.0	30.78	91.2	29.78	87.6	29.23	85.0	28.26	81.9	27.09	76.2	25.89
	-9.8	-11	96.6	29.68	92.6	28.72	87.6	28.17	85.0	27.23	81.9	26.11	76.2	24.96
	-9.5	-10	97.2	29.52	93.0	28.56	87.6	28.01	85.0	27.07	81.9	25.96	76.2	24.81
	-8.5	-9.1	98.2	28.97	93.4	28.04	87.6	27.49	85.0	26.55	81.9	25.47	76.2	24.35
	-7.0	-7.6	99.1	28.15	93.4	27.24	87.6	26.69	85.0	25.77	81.9	24.74	76.2	23.64
	-5.0	-5.6	99.1	27.05	93.4	26.20	87.6	25.64	85.0	24.72	81.9	23.75	76.2	22.70
	-3.0	-3.7	99.1	25.95	93.4	25.14	87.6	24.57	85.0	23.69	81.9	22.78	76.2	21.76
	0.0	-0.7	99.1	24.30	93.4	23.56	87.6	22.99	85.0	22.12	81.9	21.30	76.2	20.35
	3.0	2.2	99.1	22.66	93.4	21.97	87.6	21.40	85.0	20.56	81.9	19.83	76.2	18.94
	5.0	4.1	97.1	19.50	91.5	18.90	85.9	18.37	83.3	17.63	80.3	17.01	74.8	16.25
	7.0	6.0	94.6	18.21	89.2	17.68	83.7	17.17	81.2	16.45	78.2	15.90	72.8	15.18
	9.0	7.9	91.2	16.15	85.9	15.70	80.7	15.32	78.2	14.73	75.4	14.21	70.2	13.53
	11.0	9.8	86.2	14.21	81.3	13.81	76.2	13.48	74.0	12.96	71.3	12.49	66.3	11.90
	13.0	11.8	81.0	12.19	76.3	11.85	71.6	11.57	69.5	11.12	66.9	10.72	62.3	10.21
15.0	13.7	76.5	10.84	72.2	10.55	67.7	10.28	65.7	9.89	63.4	9.53	58.9	9.08	

## 7. Capacity Tables

## Heating Capacity (34HP)

Combination (%)	Outdoor air temp.		Indoor air temp. °C DB											
			16		18		20		21		22		24	
	°C DB	°C WB	TC	PI	TC	PI	TC	PI	TC	PI	TC	PI	TC	PI
70	-24.8	-25	65.7	31.35	65.7	31.54	65.3	31.94	65.3	32.53	65.3	30.96	64.3	29.47
	-21.8	-22	75.1	31.94	75.1	32.14	74.6	32.53	72.0	30.96	70.0	29.47	65.2	28.05
	-19.8	-20	81.3	32.34	79.3	32.53	74.6	31.42	72.0	29.90	70.0	28.49	65.2	27.11
	-18.8	-19	83.8	32.53	79.3	31.95	74.6	30.86	72.0	29.37	70.0	28.00	65.2	26.63
	-16.7	-17	84.0	31.33	79.3	30.74	74.6	29.70	72.0	28.27	70.0	26.97	65.2	25.63
	-13.7	-15	84.0	29.62	79.3	29.02	74.6	28.03	72.0	26.68	70.0	25.49	65.2	24.21
	-11.8	-13	84.0	28.53	79.3	27.92	74.6	26.98	72.0	25.68	70.0	24.55	65.2	23.31
	-9.8	-11	84.0	27.40	79.3	26.78	74.6	25.87	72.0	24.63	70.0	23.57	65.2	22.36
	-9.5	-10	84.0	27.22	79.3	26.60	74.6	25.70	72.0	24.48	70.0	23.43	65.2	22.22
	-8.5	-9.1	84.0	26.66	79.3	26.03	74.6	25.14	72.0	23.94	70.0	22.93	65.2	21.75
	-7.0	-7.6	84.0	25.80	79.3	25.17	74.6	24.31	72.0	23.16	70.0	22.20	65.2	21.03
	-5.0	-5.6	84.0	24.66	79.3	24.01	74.6	23.20	72.0	22.10	70.0	21.21	65.2	20.08
	-3.0	-3.7	84.0	23.52	79.3	22.86	74.6	22.09	72.0	21.05	70.0	20.22	65.2	19.13
	0.0	-0.7	84.0	21.81	79.3	21.14	74.6	20.42	72.0	19.47	70.0	18.75	65.2	17.71
	3.0	2.2	84.0	20.10	79.3	19.40	74.6	18.75	72.0	17.89	70.0	17.28	65.2	16.28
	5.0	4.1	84.0	17.52	77.7	16.51	73.1	15.95	70.6	15.21	68.5	14.71	64.0	13.86
	7.0	6.0	84.1	16.65	75.7	15.22	71.3	14.71	68.8	14.05	66.8	13.62	62.3	12.81
	9.0	7.9	81.0	14.29	73.0	13.06	68.6	12.62	66.3	12.05	64.3	11.68	60.0	10.99
	11.0	9.8	76.6	12.54	69.0	11.47	64.9	11.09	62.7	10.58	60.9	10.26	56.7	9.64
	13.0	11.8	72.0	10.86	64.8	9.94	60.9	9.60	58.9	9.17	57.2	8.90	53.3	8.36
15.0	13.7	68.1	9.55	61.3	8.73	57.7	8.44	55.7	8.05	54.1	7.81	50.4	7.34	
60	-24.8	-25	64.3	30.88	64.3	31.28	64.0	31.87	61.8	30.20	59.7	28.63	55.8	27.15
	-21.8	-22	68.9	31.47	68.2	31.87	64.0	30.20	61.8	28.63	59.7	27.15	55.8	25.73
	-19.8	-20	72.0	31.87	68.2	30.69	64.0	29.08	61.8	27.58	59.7	26.17	55.8	24.79
	-18.8	-19	72.0	31.28	68.2	30.10	64.0	28.52	61.8	27.05	59.7	25.68	55.8	24.31
	-16.7	-17	72.0	30.02	68.2	28.84	64.0	27.35	61.8	25.96	59.7	24.65	55.8	23.32
	-13.7	-15	72.0	28.21	68.2	27.07	64.0	25.67	61.8	24.39	59.7	23.18	55.8	21.90
	-11.8	-13	72.0	27.08	68.2	25.94	64.0	24.61	61.8	23.40	59.7	22.25	55.8	21.00
	-9.8	-11	72.0	25.88	68.2	24.76	64.0	23.50	61.8	22.35	59.7	21.26	55.8	20.05
	-9.5	-10	72.0	25.69	68.2	24.59	64.0	23.33	61.8	22.19	59.7	21.12	55.8	19.91
	-8.5	-9.1	72.0	25.10	68.2	23.99	64.0	22.77	61.8	21.67	59.7	20.62	55.8	19.44
	-7.0	-7.6	72.0	24.20	68.2	23.10	64.0	21.93	61.8	20.89	59.7	19.88	55.8	18.73
	-5.0	-5.6	72.0	23.00	68.2	21.92	64.0	20.82	61.8	19.84	59.7	18.91	55.8	17.78
	-3.0	-3.7	72.0	21.80	68.2	20.73	64.0	19.70	61.8	18.80	59.7	17.92	55.8	16.83
	0.0	-0.7	72.0	20.00	68.2	18.95	64.0	18.03	61.8	17.22	59.7	16.45	55.8	15.41
	3.0	2.2	72.0	18.21	68.2	17.17	64.0	16.35	61.8	15.66	59.7	14.98	55.8	13.99
	5.0	4.1	70.6	15.40	66.9	14.48	62.7	13.78	60.6	13.22	58.5	12.65	54.7	11.80
	7.0	6.0	68.8	14.06	65.2	13.18	61.1	12.56	59.0	12.08	57.0	11.58	53.3	10.77
	9.0	7.9	66.3	11.94	62.8	11.18	58.9	10.66	56.9	10.25	54.9	9.83	51.4	9.14
	11.0	9.8	62.7	10.48	59.3	9.82	55.6	9.36	53.8	9.00	51.9	8.63	48.6	8.02
	13.0	11.8	58.9	9.07	55.8	8.51	52.2	8.10	50.5	7.79	48.8	7.47	45.6	6.95
15.0	13.7	55.7	8.05	52.7	7.54	49.5	7.12	47.8	6.84	46.2	6.56	43.1	6.16	
50	-24.8	-25	60.1	27.19	56.7	27.78	53.3	26.29	51.6	24.89	49.9	23.58	46.5	22.35
	-21.8	-22	60.1	27.78	56.7	26.29	53.3	24.89	51.6	23.58	49.9	22.35	46.5	21.17
	-19.8	-20	60.1	26.74	56.7	25.29	53.3	23.96	51.6	22.69	49.9	21.53	46.5	20.39
	-18.8	-19	60.1	26.22	56.7	24.79	53.3	23.50	51.6	22.25	49.9	21.13	46.5	20.00
	-16.7	-17	60.1	25.12	56.7	23.75	53.3	22.53	51.6	21.33	49.9	20.26	46.5	19.17
	-13.7	-15	60.1	23.56	56.7	22.25	53.3	21.12	51.6	20.02	49.9	19.04	46.5	17.99
	-11.8	-13	60.1	22.57	56.7	21.30	53.3	20.24	51.6	19.18	49.9	18.26	46.5	17.25
	-9.8	-11	60.1	21.52	56.7	20.31	53.3	19.31	51.6	18.30	49.9	17.45	46.5	16.46
	-9.5	-10	60.1	21.36	56.7	20.16	53.3	19.17	51.6	18.17	49.9	17.33	46.5	16.35
	-8.5	-9.1	60.1	20.84	56.7	19.66	53.3	18.71	51.6	17.73	49.9	16.92	46.5	15.96
	-7.0	-7.6	60.1	20.06	56.7	18.92	53.3	18.01	51.6	17.08	49.9	16.30	46.5	15.36
	-5.0	-5.6	60.1	19.01	56.7	17.92	53.3	17.08	51.6	16.19	49.9	15.49	46.5	14.59
	-3.0	-3.7	60.1	17.97	56.7	16.92	53.3	16.15	51.6	15.32	49.9	14.67	46.5	13.80
	0.0	-0.7	60.1	16.40	56.7	15.42	53.3	14.76	51.6	14.00	49.9	13.44	46.5	12.62
	3.0	2.2	60.1	14.84	56.7	13.93	53.3	13.36	51.6	12.68	49.9	12.22	46.5	11.44
	5.0	4.1	58.9	12.49	55.6	11.70	52.2	11.25	50.5	10.68	48.9	10.31	45.6	9.64
	7.0	6.0	57.5	11.35	54.1	10.63	50.9	10.24	49.3	9.72	47.6	9.42	44.4	8.79
	9.0	7.9	55.3	9.73	52.2	9.11	49.0	8.78	47.5	8.34	45.9	8.09	42.8	7.54
	11.0	9.8	52.6	8.65	49.6	8.09	46.6	7.80	44.8	7.40	43.4	7.18	40.5	6.70
	13.0	11.8	49.1	7.41	46.4	6.93	43.6	6.67	42.2	6.38	40.8	6.15	38.0	5.77
15.0	13.7	46.5	6.59	43.9	6.16	41.2	5.93	39.9	5.65	38.6	5.46	35.9	5.10	

## Note

1. TC: Total Capacity(kW), PI : Power Input(kW, Comp. + Outdoor fan motor)
2. Capacity tables show the average value of conditions which may occur.
3. The heating capacity table is based on the values expressed as Max. in the specification of the outdoor unit. (When measuring the Max. heating capacity, the setting status of the indoor unit is the same as that for measuring the heating capacity of the indoor unit.)

# 7. Capacity Tables

## ◆ ARUM360LTE5

Heating Capacity (36HP)

Combination (%)	Outdoor air temp.		Indoor air temp. °C DB											
			16		18		20		21		22		24	
	°C DB	°C WB	TC	PI	TC	PI	TC	PI	TC	PI	TC	PI	TC	PI
130	-24.8	-25	69.3	37.2	69.3	37.57	68.9	37.94	68.9	38.49	68.9	39.04	68.0	39.89
	-21.8	-22	84.4	37.99	84.4	38.41	83.8	38.78	83.8	39.34	83.8	39.89	82.6	40.72
	-19.8	-20	89.0	38.55	89.0	38.98	88.4	39.34	88.4	39.91	88.4	40.44	87.2	41.29
	-18.8	-19	91.1	38.84	91.1	39.26	90.5	39.63	90.5	40.19	90.5	40.72	89.2	41.57
	-16.7	-17	95.4	39.43	95.4	39.85	94.8	40.22	94.8	40.78	94.8	41.32	93.4	42.16
	-13.7	-15	101.5	40.28	101.5	40.70	100.9	41.07	100.9	41.63	100.9	42.16	99.4	40.49
	-11.8	-13	104.8	40.82	104.8	41.23	104.2	41.60	104.2	42.16	104.2	41.04	103.2	39.43
	-9.8	-11	108.3	41.37	108.3	41.80	107.6	42.16	107.6	40.96	107.6	39.85	106.9	38.32
	-9.5	-10	108.9	41.47	108.9	41.88	108.3	41.98	108.3	40.77	108.1	39.67	107.5	38.14
	-8.5	-9.1	111.2	41.74	111.2	42.16	110.6	41.35	110.6	40.16	109.9	39.07	109.4	37.58
	-7.0	-7.6	114.7	42.16	114.7	41.24	113.9	40.42	113.9	39.25	113.9	38.17	112.8	36.75
	-5.0	-5.6	119.3	40.96	119.3	40.01	118.5	39.16	118.5	38.03	118.5	36.98	116.7	35.63
	-3.0	-3.7	123.9	39.75	123.9	38.78	123.1	37.91	123.1	36.81	123.1	35.79	120.7	34.51
	0.0	-0.7	130.7	37.93	130.7	36.93	129.9	36.04	129.9	34.99	129.9	34.00	126.5	32.84
	3.0	2.2	137.6	36.12	137.6	35.07	136.7	34.16	136.7	33.17	135.2	32.20	126.6	31.17
	5.0	4.1	139.1	31.73	138.8	30.72	138.0	29.84	136.8	28.93	133.2	28.05	124.0	27.14
	7.0	6.0	138.2	29.98	137.9	29.02	137.2	28.18	134.6	27.36	129.8	26.54	120.9	25.75
9.0	7.9	133.5	27.80	133.2	26.90	132.9	26.11	129.6	25.35	125.1	24.60	116.5	23.87	
11.0	9.8	126.3	25.94	126.0	25.11	125.7	24.37	122.5	23.66	118.3	22.97	110.1	22.27	
13.0	11.8	118.6	23.73	118.4	22.97	118.0	22.30	115.1	21.65	111.1	21.01	103.4	20.37	
15.0	13.7	112.2	21.87	112.0	21.16	111.6	20.55	108.9	19.95	105.1	19.36	97.8	18.77	
120	-24.8	-25	68.9	37.57	68.9	37.94	68.4	38.49	68.4	39.04	68.4	39.89	67.5	40.48
	-21.8	-22	83.8	38.41	83.8	38.78	83.2	39.34	83.2	39.89	83.2	40.72	82.1	41.32
	-19.8	-20	88.4	38.98	88.4	39.34	87.8	39.91	87.8	40.44	87.8	41.29	86.6	41.88
	-18.8	-19	90.4	39.26	90.4	39.63	89.8	40.19	89.8	40.72	89.8	41.57	88.6	42.16
	-16.7	-17	94.7	39.85	94.7	40.22	94.1	40.78	94.1	41.32	94.1	42.16	92.7	41.09
	-13.7	-15	100.7	40.70	100.7	41.07	100.1	41.63	100.1	42.16	100.1	40.55	98.7	39.55
	-11.8	-13	104.0	41.23	104.0	41.60	103.4	42.16	103.4	41.02	103.4	39.53	102.4	38.58
	-9.8	-11	107.5	41.80	107.5	42.16	106.9	40.90	106.9	39.82	106.9	38.46	106.2	37.55
	-9.5	-10	108.2	41.88	108.2	41.96	107.6	40.72	107.6	39.64	107.6	38.30	106.9	37.39
	-8.5	-9.1	110.5	42.16	110.5	41.29	109.7	40.08	109.7	39.04	109.7	37.77	108.9	36.88
	-7.0	-7.6	113.9	41.16	113.9	40.29	113.2	39.14	113.2	38.14	113.0	36.96	112.0	36.11
	-5.0	-5.6	118.5	39.82	118.5	38.95	117.7	37.88	117.7	36.93	117.7	35.88	116.0	35.08
	-3.0	-3.7	123.0	38.48	123.0	37.62	122.2	36.61	122.2	35.74	122.2	34.81	118.9	34.05
	0.0	-0.7	129.8	36.47	129.8	35.61	128.9	34.72	128.9	33.93	127.7	33.20	118.9	32.51
	3.0	2.2	136.6	34.46	136.6	33.60	134.9	32.83	132.0	32.13	127.9	31.59	118.9	30.98
	5.0	4.1	138.1	30.07	137.2	29.26	133.8	28.59	129.4	27.98	125.4	27.55	116.5	27.01
	7.0	6.0	137.3	28.28	135.8	27.52	130.5	26.97	126.1	26.46	122.2	26.21	113.5	25.74
9.0	7.9	132.6	26.15	130.8	25.44	125.7	24.94	121.5	24.46	117.7	24.22	109.4	23.79	
11.0	9.8	125.4	24.34	123.7	23.67	118.9	23.20	114.8	22.76	111.3	22.55	103.4	22.15	
13.0	11.8	117.8	22.19	116.2	21.58	111.6	21.16	107.9	20.75	104.6	20.56	97.1	20.19	
15.0	13.7	111.5	20.37	110.0	19.81	105.6	19.42	102.1	19.06	99.0	18.88	91.9	18.54	
110	-24.8	-25	68.5	37.94	68.5	38.49	68.1	39.04	68.1	39.89	68.1	40.48	67.1	40.76
	-21.8	-22	83.4	38.78	83.4	39.34	82.8	39.89	82.8	40.72	82.8	41.32	81.7	41.60
	-19.8	-20	87.9	39.34	87.9	39.91	87.4	40.44	87.4	41.29	87.4	41.88	86.1	42.16
	-18.8	-19	89.9	39.63	89.9	40.19	89.3	40.72	89.3	41.57	89.3	42.16	88.1	41.60
	-16.7	-17	94.2	40.22	94.2	40.78	93.6	41.32	93.6	42.16	93.6	41.01	92.2	40.41
	-13.7	-15	100.2	41.07	100.2	41.63	99.5	42.16	99.5	40.41	99.5	39.34	99.5	38.72
	-11.8	-13	103.5	41.60	103.5	42.16	102.8	40.92	102.8	39.29	102.8	38.29	102.8	37.65
	-9.8	-11	106.9	42.16	106.9	40.76	106.3	39.62	106.3	38.12	106.3	37.19	106.0	36.52
	-9.5	-10	107.6	41.93	107.6	40.54	107.0	39.41	107.0	37.94	107.0	37.03	106.7	36.35
	-8.5	-9.1	109.9	41.18	109.9	39.84	109.2	38.76	109.2	37.35	109.2	36.46	107.0	35.78
	-7.0	-7.6	113.3	40.03	113.3	38.79	112.6	37.78	112.6	36.47	112.6	35.64	107.0	34.94
	-5.0	-5.6	117.8	38.51	117.8	37.37	117.0	36.47	117.0	35.30	114.5	34.53	107.0	33.80
	-3.0	-3.7	122.3	36.99	122.3	35.97	121.4	35.15	118.6	34.12	114.5	33.42	107.0	32.68
	0.0	-0.7	129.1	34.70	128.7	33.86	122.5	33.19	118.6	32.36	114.5	31.77	107.0	30.99
	3.0	2.2	135.4	32.42	130.6	31.74	122.5	31.22	118.6	30.61	114.5	30.10	107.0	29.29
	5.0	4.1	135.5	28.04	128.0	27.49	120.1	27.07	116.2	26.59	112.3	26.17	104.9	25.41
	7.0	6.0	132.0	26.14	124.8	25.75	117.1	25.46	113.3	25.15	109.4	24.83	102.2	24.05
9.0	7.9	127.2	24.04	120.1	23.68	112.7	23.41	109.1	23.13	105.4	22.84	98.4	22.13	
11.0	9.8	120.2	22.25	113.6	21.91	106.7	21.66	103.2	21.41	99.7	21.13	93.1	20.47	
13.0	11.8	112.9	20.16	106.7	19.85	100.2	19.62	96.9	19.38	93.6	19.14	87.4	18.55	
15.0	13.7	106.8	18.35	100.9	18.08	94.8	17.87	91.6	17.66	88.6	17.43	82.7	16.89	

# 7. Capacity Tables

Heating Capacity (36HP)

Combination (%)	Outdoor air temp.		Indoor air temp. °C DB											
			16		18		20		21		22		24	
	°C DB	°C WB	TC	PI	TC	PI	TC	PI	TC	PI	TC	PI	TC	PI
100	-24.8	-25	68.2	42.32	68.2	42.30	67.8	39.87	67.8	42.25	67.8	42.23	66.8	42.22
	-21.8	-22	82.9	42.29	82.9	42.27	82.5	41.13	82.5	42.22	82.5	42.81	81.2	42.19
	-19.8	-20	87.5	42.27	87.5	42.24	87.0	41.93	87.0	42.20	87.0	42.38	85.8	42.16
	-18.8	-19	89.5	42.26	89.0	42.24	89.0	42.22	89.0	42.18	89.0	42.16	87.7	41.48
	-16.7	-17	93.2	42.24	93.2	42.22	93.2	42.81	92.7	42.16	92.7	40.75	91.3	40.05
	-13.7	-15	99.7	42.21	99.7	42.18	99.1	42.16	99.1	40.11	99.1	38.73	97.8	37.99
	-11.8	-13	103.0	42.19	102.4	42.16	102.4	40.78	102.4	38.80	102.4	37.44	97.8	36.69
	-9.8	-11	106.3	42.16	106.3	40.61	105.9	39.32	105.9	37.43	104.9	36.10	97.8	35.32
	-9.5	-10	107.0	41.92	107.0	40.37	106.5	39.10	106.5	37.22	104.9	35.89	97.8	35.12
	-8.5	-9.1	109.3	41.10	109.3	39.60	108.8	38.37	108.5	36.53	104.9	35.22	97.8	34.43
	-7.0	-7.6	114.5	39.88	114.1	38.43	112.1	37.27	108.5	35.51	104.9	34.21	97.8	33.40
	-5.0	-5.6	119.5	38.24	118.3	36.88	112.1	35.82	108.5	34.13	104.9	32.86	97.8	32.03
	-3.0	-3.7	123.0	36.61	119.3	35.32	112.1	34.36	108.5	32.75	104.9	31.52	97.8	30.66
	0.0	-0.7	126.4	34.16	119.3	32.99	112.1	32.17	108.5	30.70	104.9	29.49	97.8	28.61
	3.0	2.2	126.4	31.70	119.3	30.65	112.1	29.98	108.5	28.64	104.9	27.47	97.8	26.56
	5.0	4.1	123.9	27.31	116.9	26.39	109.8	25.83	106.4	24.66	102.9	23.60	95.8	22.76
	7.0	6.0	120.7	25.30	113.9	24.51	107.1	24.08	103.6	23.04	100.2	22.05	93.4	21.20
	9.0	7.9	116.3	23.12	109.7	22.39	103.2	22.00	99.9	21.05	96.6	20.13	89.9	19.36
	11.0	9.8	110.0	21.22	103.8	20.54	97.5	20.19	94.4	19.31	91.3	18.48	85.1	17.77
	13.0	11.8	103.3	19.03	97.5	18.43	91.6	18.11	88.7	17.33	85.7	16.58	79.8	15.94
15.0	13.7	97.8	17.14	92.2	16.60	86.6	16.31	83.9	15.60	81.1	14.93	75.6	14.36	
90	-24.8	-25	67.9	37.46	67.9	38.30	67.5	38.90	67.5	39.17	67.5	39.74	66.6	40.59
	-21.8	-22	82.6	38.30	82.6	39.15	82.2	39.74	82.2	40.02	82.2	40.59	80.9	38.80
	-19.8	-20	87.2	38.87	87.2	39.71	86.6	40.30	86.6	40.59	86.6	39.36	85.4	37.61
	-18.8	-19	89.5	39.15	89.0	40.00	88.6	40.59	88.6	39.96	88.6	38.75	87.4	37.02
	-16.7	-17	93.2	39.74	93.2	40.59	92.8	39.28	92.8	38.63	92.8	37.47	89.3	35.77
	-13.7	-15	99.7	40.59	99.7	38.63	98.8	37.41	98.8	36.74	96.2	35.63	89.3	33.98
	-11.8	-13	103.0	39.24	102.4	37.40	102.0	36.22	99.4	35.54	96.2	34.47	89.3	32.85
	-9.8	-11	106.3	37.84	106.3	36.11	102.6	34.98	99.4	34.27	96.2	33.25	89.3	31.66
	-9.5	-10	107.0	37.62	107.0	35.90	102.6	34.79	99.4	34.08	96.2	33.06	89.3	31.48
	-8.5	-9.1	109.3	36.92	108.5	35.26	102.6	34.16	99.4	33.45	96.2	32.45	89.3	30.88
	-7.0	-7.6	114.5	35.86	108.9	34.28	102.6	33.23	99.4	32.50	96.2	31.53	89.3	29.99
	-5.0	-5.6	115.7	34.45	108.9	32.98	102.6	31.99	99.4	31.25	96.2	30.31	89.3	28.81
	-3.0	-3.7	115.7	33.04	108.9	31.69	102.6	30.74	99.4	29.98	96.2	29.08	89.3	27.61
	0.0	-0.7	115.7	30.93	108.9	29.73	102.6	28.87	99.4	28.09	96.2	27.25	89.3	25.83
	3.0	2.2	115.7	28.80	108.9	27.78	102.6	27.00	99.4	26.20	96.2	25.42	89.3	24.04
	5.0	4.1	113.5	24.81	106.8	23.95	100.5	23.26	97.4	22.53	94.3	21.84	87.5	20.61
	7.0	6.0	110.6	23.13	104.1	22.41	97.9	21.81	94.9	21.07	91.9	20.44	85.4	19.27
	9.0	7.9	106.5	21.12	100.2	20.48	94.3	19.92	91.4	19.24	88.5	18.67	82.2	17.61
	11.0	9.8	100.8	19.20	94.8	18.60	89.2	18.10	86.5	17.49	83.7	16.97	77.7	15.99
	13.0	11.8	94.6	16.87	89.0	16.35	83.8	15.92	81.2	15.37	78.6	14.91	73.0	14.06
15.0	13.7	89.5	15.03	84.2	14.57	79.3	14.18	76.8	13.70	74.4	13.29	69.1	12.53	
80	-24.8	-25	67.6	32.86	67.6	33.71	67.2	34.30	67.2	34.58	67.2	35.99	66.3	34.42
	-21.8	-22	81.7	33.71	81.7	34.55	81.7	35.14	81.7	35.99	81.7	34.42	79.8	32.91
	-19.8	-20	86.3	34.27	86.3	35.11	86.3	35.99	86.3	34.88	85.6	33.37	79.8	31.91
	-18.8	-19	88.3	34.55	88.3	35.99	88.3	35.42	88.3	34.32	85.8	32.84	79.8	31.41
	-16.7	-17	91.7	35.99	91.7	34.81	91.7	34.24	89.0	33.16	85.8	31.75	79.8	30.36
	-13.7	-15	95.9	34.24	94.0	33.12	91.7	32.55	89.0	31.49	85.8	30.17	79.8	28.85
	-11.8	-13	98.3	33.12	95.4	32.05	91.7	31.47	89.0	30.43	85.8	29.18	79.8	27.89
	-9.8	-11	100.9	31.95	96.8	30.93	91.7	30.34	89.0	29.33	85.8	28.13	79.8	26.89
	-9.5	-10	101.6	31.78	97.3	30.76	91.7	30.17	89.0	29.16	85.8	27.97	79.8	26.74
	-8.5	-9.1	102.7	31.20	97.8	30.20	91.7	29.61	89.0	28.60	85.8	27.45	79.8	26.24
	-7.0	-7.6	103.7	30.32	97.8	29.35	91.7	28.76	89.0	27.77	85.8	26.67	79.8	25.48
	-5.0	-5.6	103.7	29.15	97.8	28.24	91.7	27.63	89.0	26.65	85.8	25.61	79.8	24.48
	-3.0	-3.7	103.7	27.98	97.8	27.11	91.7	26.50	89.0	25.55	85.8	24.57	79.8	23.47
	0.0	-0.7	103.7	26.22	97.8	25.43	91.7	24.81	89.0	23.88	85.8	22.99	79.8	21.97
	3.0	2.2	103.7	24.47	97.8	23.73	91.7	23.11	89.0	22.20	85.8	21.42	79.8	20.46
	5.0	4.1	101.6	21.07	95.8	20.43	89.9	19.86	87.2	19.05	84.0	18.38	78.3	17.56
	7.0	6.0	99.0	19.69	93.4	19.13	87.6	18.56	85.0	17.79	81.9	17.20	76.2	16.42
	9.0	7.9	95.4	17.47	89.9	16.99	84.4	16.57	81.9	15.94	78.9	15.37	73.5	14.64
	11.0	9.8	90.2	15.38	85.0	14.96	79.8	14.59	77.4	14.03	74.7	13.53	69.4	12.88
	13.0	11.8	84.7	13.22	79.8	12.85	75.0	12.54	72.7	12.05	70.1	11.62	65.2	11.07
15.0	13.7	80.1	11.77	75.6	11.44	70.9	11.16	68.8	10.73	66.4	10.35	61.7	9.86	



## 7. Capacity Tables

Heating Capacity (36HP)

Combination (%)	Outdoor air temp.		Indoor air temp. °C DB											
			16		18		20		21		22		24	
	°C DB	°C WB	TC	PI	TC	PI	TC	PI	TC	PI	TC	PI	TC	PI
70	-24.8	-25	67.6	33.30	67.6	33.58	67.2	34.15	67.2	35.00	67.2	33.31	66.2	31.72
	-21.8	-22	78.6	34.15	78.6	34.43	78.1	35.00	75.4	33.31	73.2	33.72	68.3	30.20
	-19.8	-20	85.9	34.72	83.0	35.00	78.1	33.81	75.4	32.18	73.2	30.67	68.3	29.19
	-18.8	-19	87.7	35.00	83.0	34.38	78.1	33.21	75.4	31.61	73.2	30.14	68.3	28.67
	-16.7	-17	87.9	33.71	83.0	33.08	78.1	31.97	75.4	30.43	73.2	29.04	68.3	27.61
	-13.7	-15	87.9	31.89	83.0	31.24	78.1	30.18	75.4	28.74	73.2	27.46	68.3	26.08
	-11.8	-13	87.9	30.72	83.0	30.07	78.1	29.05	75.4	27.66	73.2	26.45	68.3	25.12
	-9.8	-11	87.9	29.51	83.0	28.84	78.1	27.87	75.4	26.53	73.2	25.40	68.3	24.10
	-9.5	-10	87.9	29.32	83.0	28.65	78.1	27.69	75.4	26.37	73.2	25.25	68.3	23.95
	-8.5	-9.1	87.9	28.72	83.0	28.04	78.1	27.09	75.4	25.80	73.2	24.72	68.3	23.44
	-7.0	-7.6	87.9	27.80	83.0	27.12	78.1	26.20	75.4	24.96	73.2	23.93	68.3	22.68
	-5.0	-5.6	87.9	26.58	83.0	25.89	78.1	25.01	75.4	23.83	73.2	22.87	68.3	21.66
	-3.0	-3.7	87.9	25.37	83.0	24.65	78.1	23.82	75.4	22.70	73.2	21.82	68.3	20.64
	0.0	-0.7	87.9	23.54	83.0	22.81	78.1	22.04	75.4	21.01	73.2	20.24	68.3	19.12
	3.0	2.2	87.9	21.71	83.0	20.96	78.1	20.25	75.4	19.33	73.2	18.66	68.3	17.59
	5.0	4.1	87.9	18.93	81.3	17.84	76.5	17.24	73.9	16.43	71.7	15.90	67.0	14.98
	7.0	6.0	88.0	18.01	79.2	16.46	74.6	15.91	72.0	15.19	69.9	14.73	65.2	13.85
	9.0	7.9	84.8	15.47	76.4	14.13	71.8	13.66	69.4	13.04	67.3	12.64	62.8	11.89
	11.0	9.8	80.2	13.59	72.3	12.42	67.9	12.01	65.6	11.46	63.7	11.12	59.4	10.45
	13.0	11.8	75.3	11.78	67.9	10.78	63.8	10.41	61.6	9.94	59.8	9.64	55.8	9.06
15.0	13.7	71.2	10.37	64.1	9.47	60.4	9.16	58.3	8.74	56.6	8.48	52.8	7.97	
60	-24.8	-25	67.0	32.73	67.0	33.30	66.6	34.15	64.7	32.37	62.5	30.70	58.5	29.13
	-21.8	-22	72.0	33.58	71.4	34.15	67.0	32.37	64.7	30.70	62.5	29.13	58.5	27.62
	-19.8	-20	75.4	34.15	71.4	32.89	67.0	31.18	64.7	29.59	62.5	28.08	58.5	26.61
	-18.8	-19	75.4	33.52	71.4	32.26	67.0	30.58	64.7	29.02	62.5	27.56	58.5	26.10
	-16.7	-17	75.4	32.18	71.4	30.93	67.0	29.34	64.7	27.86	62.5	26.47	58.5	25.04
	-13.7	-15	75.4	30.26	71.4	29.05	67.0	27.56	64.7	26.19	62.5	24.90	58.5	23.53
	-11.8	-13	75.4	29.06	71.4	27.85	67.0	26.42	64.7	25.13	62.5	23.91	58.5	22.58
	-9.8	-11	75.4	27.79	71.4	26.59	67.0	25.24	64.7	24.02	62.5	22.86	58.5	21.56
	-9.5	-10	75.4	27.59	71.4	26.41	67.0	25.06	64.7	23.85	62.5	22.70	58.5	21.41
	-8.5	-9.1	75.4	26.96	71.4	25.78	67.0	24.47	64.7	23.30	62.5	22.17	58.5	20.91
	-7.0	-7.6	75.4	26.01	71.4	24.83	67.0	23.58	64.7	22.46	62.5	21.39	58.5	20.15
	-5.0	-5.6	75.4	24.73	71.4	23.57	67.0	22.39	64.7	21.35	62.5	20.35	58.5	19.14
	-3.0	-3.7	75.4	23.46	71.4	22.31	67.0	21.20	64.7	20.24	62.5	19.30	58.5	18.13
	0.0	-0.7	75.4	21.55	71.4	20.42	67.0	19.43	64.7	18.56	62.5	17.73	58.5	16.62
	3.0	2.2	75.4	19.64	71.4	18.53	67.0	17.64	64.7	16.90	62.5	16.17	58.5	15.10
	5.0	4.1	73.9	16.63	70.0	15.63	65.6	14.88	63.4	14.27	61.2	13.67	57.3	12.75
	7.0	6.0	72.0	15.21	68.2	14.25	64.0	13.59	61.8	13.06	59.7	12.52	55.8	11.65
	9.0	7.9	69.4	12.93	65.7	12.10	61.6	11.54	59.6	11.09	57.5	10.64	53.8	9.89
	11.0	9.8	65.6	11.36	62.1	10.64	58.2	10.14	56.3	9.75	54.3	9.35	50.9	8.69
	13.0	11.8	61.6	9.84	58.4	9.22	54.7	8.78	52.8	8.45	51.0	8.10	47.8	7.54
15.0	13.7	58.3	8.74	55.2	8.18	51.8	7.72	50.1	7.43	48.3	7.13	45.2	6.69	
50	-24.8	-25	62.9	29.03	59.3	29.88	55.8	28.28	54.0	26.78	52.2	25.37	48.6	24.06
	-21.8	-22	62.9	29.88	59.3	28.28	55.8	26.78	54.0	25.37	52.2	24.06	48.6	22.80
	-19.8	-20	62.9	28.76	59.3	27.21	55.8	25.79	54.0	24.42	52.2	23.18	48.6	21.95
	-18.8	-19	62.9	28.20	59.3	26.67	55.8	25.29	54.0	23.96	52.2	22.74	48.6	21.53
	-16.7	-17	62.9	27.03	59.3	25.56	55.8	24.25	54.0	22.97	52.2	21.82	48.6	20.65
	-13.7	-15	62.9	25.36	59.3	23.95	55.8	22.75	54.0	21.56	52.2	20.51	48.6	19.39
	-11.8	-13	62.9	24.30	59.3	22.94	55.8	21.80	54.0	20.66	52.2	19.68	48.6	18.59
	-9.8	-11	62.9	23.18	59.3	21.87	55.8	20.80	54.0	19.72	52.2	18.80	48.6	17.74
	-9.5	-10	62.9	23.01	59.3	21.72	55.8	20.66	54.0	19.58	52.2	18.68	48.6	17.62
	-8.5	-9.1	62.9	22.44	59.3	21.18	55.8	20.16	54.0	19.11	52.2	18.24	48.6	17.20
	-7.0	-7.6	62.9	21.61	59.3	20.39	55.8	19.41	54.0	18.41	52.2	17.58	48.6	16.57
	-5.0	-5.6	62.9	20.49	59.3	19.32	55.8	18.42	54.0	17.46	52.2	16.70	48.6	15.73
	-3.0	-3.7	62.9	19.37	59.3	18.25	55.8	17.41	54.0	16.52	52.2	15.82	48.6	14.89
	0.0	-0.7	62.9	17.70	59.3	16.64	55.8	15.92	54.0	15.11	52.2	14.51	48.6	13.62
	3.0	2.2	62.9	16.03	59.3	15.05	55.8	14.43	54.0	13.69	52.2	13.20	48.6	12.36
	5.0	4.1	61.7	13.50	58.2	12.64	54.6	12.15	52.9	11.54	51.2	11.14	47.7	10.42
	7.0	6.0	60.1	12.28	56.7	11.49	53.3	11.07	51.6	10.51	49.9	10.19	46.5	9.50
	9.0	7.9	57.9	10.53	54.6	9.86	51.3	9.50	49.7	9.03	48.0	8.75	44.8	8.16
	11.0	9.8	55.1	9.37	51.9	8.77	48.7	8.45	46.9	8.02	45.4	7.77	42.4	7.25
	13.0	11.8	51.4	8.03	48.5	7.52	45.6	7.24	44.1	6.92	42.7	6.67	39.7	6.26
15.0	13.7	48.6	7.15	45.9	6.69	43.1	6.44	41.8	6.13	40.4	5.93	37.6	5.53	

## Note

1. TC: Total Capacity(kW), PI : Power Input(kW, Comp. + Outdoor fan motor)
2. Capacity tables show the average value of conditions which may occur.
3. The heating capacity table is based on the values expressed as Max. in the specification of the outdoor unit. (When measuring the Max. heating capacity, the setting status of the indoor unit is the same as that for measuring the heating capacity of the indoor unit.)

# 7. Capacity Tables

## ◆ ARUM380LTE5

Heating Capacity (38HP)

Combination (%)	Outdoor air temp.		Indoor air temp. °C DB											
			16		18		20		21		22		24	
	°C DB	°C WB	TC	PI	TC	PI	TC	PI	TC	PI	TC	PI	TC	PI
130	-24.8	-25	72.7	38.8	72.7	39.13	72.3	39.43	72.3	39.88	72.3	40.32	70.9	41.01
	-21.8	-22	89.3	39.47	89.3	39.81	88.6	40.11	88.6	40.57	88.6	41.01	86.9	41.69
	-19.8	-20	94.5	39.93	94.5	40.27	93.9	40.57	93.9	41.03	93.9	41.46	92.1	42.15
	-18.8	-19	96.7	40.16	96.7	40.50	96.1	40.80	96.1	41.26	96.1	41.69	94.2	42.38
	-16.7	-17	101.3	40.64	101.3	40.98	100.6	41.28	100.6	41.74	100.6	42.18	98.7	42.86
	-13.7	-15	107.7	41.33	107.7	41.67	107.1	41.97	107.1	42.43	107.1	42.86	105.0	41.30
	-11.8	-13	111.2	41.77	111.2	42.10	110.6	42.40	110.6	42.86	110.6	41.82	109.0	40.31
	-9.8	-11	114.9	42.22	114.9	42.56	114.2	42.86	114.2	41.76	114.2	40.72	113.2	39.27
	-9.5	-10	115.6	42.30	115.6	42.63	114.9	42.69	114.9	41.59	114.8	40.55	113.9	39.10
	-8.5	-9.1	117.8	42.52	117.8	42.86	117.1	42.13	117.1	41.02	116.6	40.00	116.0	38.58
	-7.0	-7.6	121.1	42.86	121.1	42.05	120.3	41.28	120.3	40.19	120.3	39.16	119.1	37.80
	-5.0	-5.6	125.6	41.81	125.6	40.94	124.8	40.15	124.8	39.08	124.8	38.06	123.3	36.76
	-3.0	-3.7	130.0	40.77	130.0	39.85	129.2	39.02	129.2	37.96	129.2	36.96	127.5	35.71
	0.0	-0.7	136.7	39.19	136.7	38.21	135.8	37.33	135.8	36.29	135.8	35.30	133.6	34.15
	3.0	2.2	143.4	37.62	143.4	36.56	142.4	35.63	142.4	34.62	142.4	33.64	133.7	32.58
	5.0	4.1	145.1	33.22	144.8	32.17	143.9	31.26	143.9	30.32	140.7	29.41	131.0	28.47
	7.0	6.0	145.6	31.60	145.3	30.58	144.5	29.70	142.1	28.84	137.1	27.97	127.6	27.14
9.0	7.9	141.0	29.49	140.7	28.54	140.4	27.71	136.9	26.90	132.1	26.10	123.0	25.32	
11.0	9.8	133.4	27.74	133.1	26.84	132.7	26.06	129.4	25.30	124.9	24.55	116.3	23.81	
13.0	11.8	125.3	25.59	125.1	24.77	124.6	24.04	121.6	23.35	117.3	22.65	109.2	21.97	
15.0	13.7	118.5	23.81	118.3	23.04	117.9	22.38	115.0	21.73	111.0	21.08	103.3	20.44	
120	-24.8	-25	72.2	39.13	72.2	39.43	71.8	39.88	71.8	40.32	71.8	41.01	70.4	41.49
	-21.8	-22	88.6	39.81	88.6	40.11	88.0	40.57	88.0	41.01	88.0	41.69	86.4	42.18
	-19.8	-20	93.8	40.27	93.8	40.57	93.2	41.03	93.2	41.46	93.2	42.15	91.4	42.63
	-18.8	-19	96.0	40.50	96.0	40.80	95.3	41.26	95.3	41.69	95.3	42.38	93.5	42.86
	-16.7	-17	100.5	40.98	100.5	41.28	99.9	41.74	99.9	42.18	99.9	42.86	97.9	41.85
	-13.7	-15	106.9	41.67	106.9	41.97	106.3	42.43	106.3	42.86	106.3	41.36	104.2	40.41
	-11.8	-13	110.4	42.10	110.4	42.40	109.8	42.86	109.8	41.80	109.8	40.41	108.2	39.51
	-9.8	-11	114.1	42.56	114.1	42.86	113.4	41.70	113.4	40.69	113.4	39.42	112.4	38.55
	-9.5	-10	114.8	42.63	114.8	42.68	114.1	41.53	114.1	40.52	114.1	39.27	113.1	38.40
	-8.5	-9.1	117.0	42.86	117.0	42.07	116.2	40.95	116.2	39.97	116.2	38.77	115.1	37.92
	-7.0	-7.6	120.3	41.96	120.3	41.15	119.5	40.08	119.5	39.13	119.5	38.03	118.3	37.20
	-5.0	-5.6	124.7	40.75	124.7	39.92	123.9	38.91	123.9	38.01	123.9	37.02	122.5	36.24
	-3.0	-3.7	129.1	39.54	129.1	38.71	128.3	37.75	128.3	36.91	128.3	36.02	125.6	35.28
	0.0	-0.7	135.7	37.73	135.7	36.87	134.8	36.01	134.8	35.23	134.8	34.53	125.6	33.84
	3.0	2.2	142.3	35.91	142.3	35.03	141.4	34.26	139.5	33.56	135.1	33.03	125.6	32.40
	5.0	4.1	144.2	31.49	143.7	30.65	141.4	29.97	136.7	29.33	132.4	28.91	123.0	28.35
	7.0	6.0	144.8	29.81	143.4	29.00	137.8	28.43	133.2	27.88	129.1	27.62	119.9	27.13
9.0	7.9	140.1	27.73	138.2	26.98	132.7	26.45	128.3	25.94	124.3	25.69	115.5	25.23	
11.0	9.8	132.4	25.99	130.7	25.28	125.6	24.79	121.3	24.31	117.6	24.09	109.2	23.66	
13.0	11.8	124.4	23.89	122.7	23.24	117.9	22.79	113.9	22.35	110.4	22.14	102.6	21.74	
15.0	13.7	117.7	22.14	116.1	21.53	111.5	21.11	107.9	20.71	104.5	20.52	97.0	20.15	
110	-24.8	-25	71.9	39.43	71.9	39.88	71.4	40.32	71.4	41.01	71.4	41.49	70.0	41.72
	-21.8	-22	88.1	40.11	88.1	40.57	87.5	41.01	87.5	41.69	87.5	42.18	85.9	42.40
	-19.8	-20	93.4	40.57	93.4	41.03	92.7	41.46	92.7	42.15	92.7	42.63	91.0	42.86
	-18.8	-19	95.5	40.80	95.5	41.26	94.8	41.69	94.8	42.38	94.8	42.86	93.1	42.33
	-16.7	-17	100.0	41.28	100.0	41.74	99.4	42.18	99.4	42.86	99.4	41.77	97.4	41.20
	-13.7	-15	106.3	41.97	106.3	42.43	105.7	42.86	105.7	41.21	105.7	40.20	105.7	39.59
	-11.8	-13	109.8	42.40	109.8	42.86	109.2	41.70	109.2	40.16	109.2	39.21	109.2	38.57
	-9.8	-11	113.5	42.86	113.5	41.55	112.8	40.47	112.8	39.05	112.8	38.17	112.5	37.50
	-9.5	-10	114.1	42.65	114.1	41.35	113.5	40.28	113.5	38.89	113.5	38.01	113.0	37.34
	-8.5	-9.1	116.3	41.94	116.3	40.69	115.7	39.67	115.7	38.34	115.7	37.48	113.0	36.80
	-7.0	-7.6	119.7	40.87	119.7	39.71	118.9	38.75	118.9	37.51	118.9	36.70	113.0	36.00
	-5.0	-5.6	124.0	39.46	124.0	38.38	123.2	37.52	123.2	36.41	121.0	35.66	113.0	34.92
	-3.0	-3.7	128.4	38.04	128.4	37.07	127.6	36.29	125.2	35.30	121.0	34.61	113.0	33.85
	0.0	-0.7	135.0	35.92	135.0	35.09	129.4	34.45	125.2	33.64	121.0	33.05	113.0	32.25
	3.0	2.2	141.5	33.79	138.0	33.12	129.4	32.60	125.2	31.99	121.0	31.48	113.0	30.63
	5.0	4.1	143.0	29.37	135.2	28.80	126.9	28.38	122.7	27.89	118.6	27.46	110.7	26.66
	7.0	6.0	139.4	27.55	131.8	27.14	123.7	26.83	119.6	26.50	115.5	26.17	107.9	25.35
9.0	7.9	134.3	25.49	126.9	25.11	119.1	24.83	115.2	24.52	111.4	24.22	103.9	23.46	
11.0	9.8	127.0	23.75	120.0	23.39	112.7	23.13	109.0	22.86	105.3	22.56	98.3	21.86	
13.0	11.8	119.2	21.69	112.7	21.36	105.8	21.12	102.3	20.86	98.8	20.60	92.3	19.97	
15.0	13.7	112.8	19.94	106.6	19.64	100.1	19.42	96.8	19.19	93.5	18.94	87.3	18.35	

# 7. Capacity Tables

Heating Capacity (38HP)

Combination (%)	Outdoor air temp.		Indoor air temp. °C DB											
			16		18		20		21		22		24	
	°C DB	°C WB	TC	PI	TC	PI	TC	PI	TC	PI	TC	PI	TC	PI
100	-24.8	-25	71.6	43.65	71.6	43.55	71.1	40.81	71.1	43.29	71.1	43.18	69.7	43.13
	-21.8	-22	87.7	43.49	87.7	43.39	87.2	42.09	87.2	43.13	87.2	43.61	85.5	42.97
	-19.8	-20	92.9	43.39	92.9	43.28	92.4	42.90	92.4	43.03	92.4	43.11	90.6	42.86
	-18.8	-19	95.0	43.34	94.5	43.23	94.5	43.13	94.5	42.97	94.5	42.86	92.6	42.20
	-16.7	-17	98.9	43.23	98.9	43.12	98.9	43.61	98.4	42.86	98.4	41.50	96.5	40.81
	-13.7	-15	105.8	43.07	105.8	42.96	105.2	42.86	105.2	40.89	105.2	39.55	103.3	38.82
	-11.8	-13	109.3	42.97	108.7	42.86	108.7	41.55	108.7	39.64	108.7	38.31	103.3	37.57
	-9.8	-11	112.9	42.86	112.9	41.39	112.3	40.16	112.3	38.33	110.8	37.02	103.3	36.24
	-9.5	-10	113.5	42.63	113.5	41.17	113.0	39.96	113.0	38.13	110.8	36.82	103.3	36.04
	-8.5	-9.1	115.7	41.87	115.7	40.43	115.2	39.26	114.6	37.47	110.8	36.18	103.3	35.37
	-7.0	-7.6	121.0	40.72	120.5	39.33	118.4	38.22	114.6	36.49	110.8	35.20	103.3	34.38
	-5.0	-5.6	126.2	39.18	125.0	37.86	118.4	36.84	114.6	35.17	110.8	33.90	103.3	33.05
	-3.0	-3.7	129.9	37.65	126.0	36.38	118.4	35.45	114.6	33.86	110.8	32.61	103.3	31.73
	0.0	-0.7	133.5	35.34	126.0	34.18	118.4	33.37	114.6	31.89	110.8	30.65	103.3	29.74
	3.0	2.2	133.5	33.03	126.0	31.97	118.4	31.30	114.6	29.92	110.8	28.70	103.3	27.76
	5.0	4.1	130.8	28.59	123.5	27.65	116.0	27.07	112.3	25.86	108.7	24.75	101.2	23.87
	7.0	6.0	127.5	26.67	120.3	25.83	113.1	25.38	109.5	24.29	105.8	23.24	98.6	22.35
	9.0	7.9	122.9	24.54	115.9	23.77	109.0	23.36	105.5	22.34	102.0	21.37	95.0	20.56
11.0	9.8	116.2	22.71	109.6	21.99	103.0	21.61	99.7	20.68	96.4	19.78	89.9	19.03	
13.0	11.8	109.1	20.57	102.9	19.93	96.7	19.58	93.7	18.73	90.5	17.93	84.3	17.24	
15.0	13.7	103.3	18.75	97.4	18.16	91.5	17.85	88.6	17.07	85.7	16.33	79.8	15.71	
90	-24.8	-25	71.3	38.81	71.3	39.49	70.8	39.98	70.8	40.20	70.8	40.66	69.5	41.35
	-21.8	-22	87.4	39.49	87.4	40.18	86.9	40.66	86.9	40.89	86.9	41.35	85.1	39.60
	-19.8	-20	92.6	39.95	92.6	40.64	92.0	41.12	92.0	41.35	92.0	40.15	90.2	38.44
	-18.8	-19	95.0	40.18	94.5	40.87	94.1	41.35	94.1	40.74	94.1	39.56	92.3	37.86
	-16.7	-17	98.9	40.66	98.9	41.35	98.5	40.09	98.5	39.45	98.5	38.32	94.3	36.63
	-13.7	-15	105.8	41.35	105.8	39.47	104.9	38.28	104.9	37.62	101.6	36.53	94.3	34.89
	-11.8	-13	109.3	40.06	108.7	38.29	108.2	37.14	105.0	36.45	101.6	35.40	94.3	33.78
	-9.8	-11	112.9	38.72	112.9	37.04	108.4	35.94	105.0	35.23	101.6	34.21	94.3	32.61
	-9.5	-10	113.5	38.51	113.5	36.85	108.4	35.75	105.0	35.04	101.6	34.03	94.3	32.43
	-8.5	-9.1	115.7	37.85	114.9	36.22	108.4	35.15	105.0	34.43	101.6	33.43	94.3	31.86
	-7.0	-7.6	121.0	36.83	115.1	35.29	108.4	34.25	105.0	33.51	101.6	32.54	94.3	30.98
	-5.0	-5.6	122.3	35.48	115.1	34.04	108.4	33.05	105.0	32.29	101.6	31.35	94.3	29.82
	-3.0	-3.7	122.3	34.13	115.1	32.79	108.4	31.84	105.0	31.07	101.6	30.16	94.3	28.65
	0.0	-0.7	122.3	32.11	115.1	30.92	108.4	30.04	105.0	29.23	101.6	28.37	94.3	26.91
	3.0	2.2	122.3	30.08	115.1	29.04	108.4	28.23	105.0	27.40	101.6	26.59	94.3	25.15
	5.0	4.1	119.8	26.02	112.8	25.12	106.1	24.41	102.9	23.63	99.6	22.92	92.4	21.63
	7.0	6.0	116.8	24.38	109.9	23.62	103.4	22.98	100.2	22.21	97.0	21.54	90.2	20.31
	9.0	7.9	112.5	22.42	105.8	21.74	99.6	21.15	96.6	20.42	93.5	19.82	86.8	18.69
11.0	9.8	106.4	20.55	100.1	19.92	94.2	19.38	91.3	18.72	88.4	18.16	82.1	17.12	
13.0	11.8	99.9	18.24	94.0	17.68	88.5	17.21	85.7	16.62	83.0	16.12	77.1	15.20	
15.0	13.7	94.5	16.45	88.9	15.94	83.8	15.51	81.1	14.98	78.6	14.53	73.0	13.71	
80	-24.8	-25	71.0	34.12	71.0	34.81	70.5	35.29	70.5	35.52	70.5	36.66	69.2	35.13
	-21.8	-22	86.4	34.81	86.4	35.49	86.4	35.97	86.4	36.66	86.4	35.13	84.3	33.65
	-19.8	-20	91.6	35.26	91.6	35.95	91.6	36.66	91.6	35.58	90.6	34.10	84.3	32.66
	-18.8	-19	93.7	35.49	93.7	36.66	93.7	36.12	93.7	35.04	90.6	33.59	84.3	32.17
	-16.7	-17	96.9	36.66	96.9	35.53	96.9	34.97	94.0	33.90	90.6	32.52	84.3	31.14
	-13.7	-15	101.3	34.98	99.3	33.89	96.9	33.33	94.0	32.28	90.6	30.98	84.3	29.66
	-11.8	-13	103.8	33.90	100.7	32.86	96.9	32.28	94.0	31.25	90.6	30.00	84.3	28.72
	-9.8	-11	106.5	32.78	102.2	31.78	96.9	31.19	94.0	30.17	90.6	28.98	84.3	27.73
	-9.5	-10	107.3	32.61	102.8	31.61	96.9	31.02	94.0	30.00	90.6	28.82	84.3	27.59
	-8.5	-9.1	108.4	32.05	103.2	31.07	96.9	30.47	94.0	29.46	90.6	28.32	84.3	27.09
	-7.0	-7.6	109.5	31.20	103.2	30.25	96.9	29.65	94.0	28.65	90.6	27.55	84.3	26.35
	-5.0	-5.6	109.5	30.08	103.2	29.17	96.9	28.55	94.0	27.56	90.6	26.52	84.3	25.36
	-3.0	-3.7	109.5	28.96	103.2	28.08	96.9	27.46	94.0	26.48	90.6	25.50	84.3	24.38
	0.0	-0.7	109.5	27.26	103.2	26.45	96.9	25.82	94.0	24.86	90.6	23.95	84.3	22.91
	3.0	2.2	109.5	25.58	103.2	24.82	96.9	24.17	94.0	23.23	90.6	22.42	84.3	21.42
	5.0	4.1	107.3	22.10	101.2	21.44	95.0	20.84	92.1	19.99	88.8	19.30	82.7	18.43
	7.0	6.0	104.6	20.75	98.6	20.16	92.6	19.56	89.7	18.75	86.5	18.13	80.5	17.31
	9.0	7.9	100.7	18.58	95.0	18.06	89.1	17.61	86.5	16.93	83.3	16.33	77.6	15.55
11.0	9.8	95.3	16.49	89.7	16.04	84.3	15.63	81.8	15.03	78.9	14.50	73.3	13.81	
13.0	11.8	89.4	14.32	84.3	13.91	79.2	13.57	76.8	13.04	74.1	12.57	68.9	11.98	
15.0	13.7	84.6	12.90	79.8	12.53	74.9	12.22	72.7	11.75	70.1	11.33	65.2	10.79	

# 7. Capacity Tables

Heating Capacity (38HP)

Combination (%)	Outdoor air temp.		Indoor air temp. °C DB											
			16		18		20		21		22		24	
	°C DB	°C WB	TC	PI	TC	PI	TC	PI	TC	PI	TC	PI	TC	PI
70	-24.8	-25	71.0	34.43	71.0	34.66	70.5	35.12	70.5	35.81	70.5	34.13	69.2	32.55
	-21.8	-22	83.0	35.12	83.0	35.35	82.5	35.81	79.7	34.13	77.3	32.55	72.2	31.03
	-19.8	-20	91.1	35.58	87.7	35.81	82.5	34.63	79.7	33.01	77.3	31.51	72.2	30.02
	-18.8	-19	92.9	35.81	87.7	35.20	82.5	34.04	79.7	32.45	77.3	30.98	72.2	29.50
	-16.7	-17	92.9	34.54	87.7	33.92	82.5	32.81	79.7	31.27	77.3	29.88	72.2	28.44
	-13.7	-15	92.9	32.75	87.7	32.10	82.5	31.04	79.7	29.59	77.3	28.31	72.2	26.91
	-11.8	-13	92.9	31.60	87.7	30.94	82.5	29.91	79.7	28.52	77.3	27.31	72.2	25.95
	-9.8	-11	92.9	30.40	87.7	29.72	82.5	28.74	79.7	27.40	77.3	26.26	72.2	24.94
	-9.5	-10	92.9	30.22	87.7	29.54	82.5	28.56	79.7	27.23	77.3	26.10	72.2	24.79
	-8.5	-9.1	92.9	29.62	87.7	28.93	82.5	27.97	79.7	26.67	77.3	25.58	72.2	24.27
	-7.0	-7.6	92.9	28.72	87.7	28.02	82.5	27.09	79.7	25.83	77.3	24.79	72.2	23.51
	-5.0	-5.6	92.9	27.52	87.7	26.80	82.5	25.91	79.7	24.71	77.3	23.74	72.2	22.50
	-3.0	-3.7	92.9	26.32	87.7	25.58	82.5	24.73	79.7	23.59	77.3	22.69	72.2	21.48
	0.0	-0.7	92.9	24.51	87.7	23.76	82.5	22.97	79.7	21.91	77.3	21.12	72.2	19.96
	3.0	2.2	92.9	22.71	87.7	21.93	82.5	21.19	79.7	20.23	77.3	19.54	72.2	18.43
	5.0	4.1	92.9	19.87	85.9	18.72	80.8	18.10	78.1	17.25	75.7	16.70	70.7	15.73
	7.0	6.0	92.9	18.98	83.7	17.35	78.7	16.77	76.0	16.01	73.8	15.52	68.9	14.60
	9.0	7.9	89.6	16.42	80.6	15.00	75.9	14.50	73.3	13.85	71.1	13.42	66.3	12.62
	11.0	9.8	84.7	14.55	76.3	13.29	71.7	12.85	69.3	12.27	67.3	11.90	62.8	11.19
	13.0	11.8	79.5	12.74	71.7	11.65	67.4	11.26	65.0	10.75	63.1	10.42	58.9	9.80
15.0	13.7	75.2	11.34	67.7	10.36	63.8	10.02	61.5	9.56	59.8	9.28	55.8	8.72	
60	-24.8	-25	70.8	33.97	70.8	34.43	70.3	35.12	68.4	33.32	66.0	31.64	61.8	30.05
	-21.8	-22	76.1	34.66	75.4	35.12	70.7	33.32	68.4	31.64	66.0	30.05	61.8	28.52
	-19.8	-20	79.7	35.12	75.4	33.85	70.7	32.13	68.4	30.52	66.0	29.00	61.8	27.50
	-18.8	-19	79.7	34.49	75.4	33.22	70.7	31.52	68.4	29.95	66.0	28.47	61.8	26.98
	-16.7	-17	79.7	33.14	75.4	31.89	70.7	30.27	68.4	28.77	66.0	27.36	61.8	25.91
	-13.7	-15	79.7	31.22	75.4	29.99	70.7	28.48	68.4	27.09	66.0	25.77	61.8	24.38
	-11.8	-13	79.7	30.01	75.4	28.79	70.7	27.34	68.4	26.02	66.0	24.77	61.8	23.41
	-9.8	-11	79.7	28.74	75.4	27.52	70.7	26.14	68.4	24.90	66.0	23.71	61.8	22.38
	-9.5	-10	79.7	28.55	75.4	27.33	70.7	25.96	68.4	24.73	66.0	23.55	61.8	22.23
	-8.5	-9.1	79.7	27.91	75.4	26.70	70.7	25.37	68.4	24.17	66.0	23.02	61.8	21.72
	-7.0	-7.6	79.7	26.96	75.4	25.75	70.7	24.47	68.4	23.32	66.0	22.23	61.8	20.95
	-5.0	-5.6	79.7	25.67	75.4	24.48	70.7	23.27	68.4	22.20	66.0	21.18	61.8	19.93
	-3.0	-3.7	79.7	24.40	75.4	23.21	70.7	22.07	68.4	21.08	66.0	20.12	61.8	18.90
	0.0	-0.7	79.7	22.48	75.4	21.31	70.7	20.28	68.4	19.39	66.0	18.53	61.8	17.37
	3.0	2.2	79.7	20.56	75.4	19.41	70.7	18.48	68.4	17.71	66.0	16.95	61.8	15.83
	5.0	4.1	78.1	17.46	73.9	16.41	69.3	15.62	67.0	14.99	64.7	14.36	60.5	13.39
	7.0	6.0	76.0	16.03	72.0	15.02	67.6	14.32	65.3	13.76	63.1	13.20	59.0	12.27
	9.0	7.9	73.3	13.72	69.3	12.85	65.0	12.25	62.9	11.77	60.7	11.30	56.9	10.50
	11.0	9.8	69.3	12.16	65.6	11.39	61.5	10.86	59.4	10.43	57.4	10.01	53.7	9.30
	13.0	11.8	65.0	10.64	61.7	9.96	57.8	9.50	55.8	9.13	53.9	8.76	50.5	8.15
15.0	13.7	61.5	9.56	58.3	8.95	54.7	8.45	52.9	8.13	51.0	7.80	47.8	7.32	
50	-24.8	-25	66.5	29.75	62.7	30.44	58.9	28.85	57.0	27.36	55.1	25.96	51.3	24.65
	-21.8	-22	66.5	30.44	62.7	28.85	58.9	27.36	57.0	25.96	55.1	24.65	51.3	23.39
	-19.8	-20	66.5	29.34	62.7	27.79	58.9	26.38	57.0	25.02	55.1	23.77	51.3	22.54
	-18.8	-19	66.5	28.78	62.7	27.26	58.9	25.88	57.0	24.56	55.1	23.33	51.3	22.12
	-16.7	-17	66.5	27.62	62.7	26.15	58.9	24.84	57.0	23.57	55.1	22.42	51.3	21.24
	-13.7	-15	66.5	25.97	62.7	24.56	58.9	23.36	57.0	22.16	55.1	21.11	51.3	19.98
	-11.8	-13	66.5	24.92	62.7	23.56	58.9	22.42	57.0	21.27	55.1	20.28	51.3	19.17
	-9.8	-11	66.5	23.81	62.7	22.50	58.9	21.42	57.0	20.33	55.1	19.40	51.3	18.33
	-9.5	-10	66.5	23.65	62.7	22.34	58.9	21.28	57.0	20.19	55.1	19.28	51.3	18.20
	-8.5	-9.1	66.5	23.09	62.7	21.81	58.9	20.78	57.0	19.72	55.1	18.84	51.3	17.78
	-7.0	-7.6	66.5	22.27	62.7	21.02	58.9	20.04	57.0	19.02	55.1	18.19	51.3	17.16
	-5.0	-5.6	66.5	21.16	62.7	19.96	58.9	19.05	57.0	18.08	55.1	17.31	51.3	16.31
	-3.0	-3.7	66.5	20.05	62.7	18.90	58.9	18.05	57.0	17.14	55.1	16.43	51.3	15.47
	0.0	-0.7	66.5	18.40	62.7	17.31	58.9	16.57	57.0	15.73	55.1	15.12	51.3	14.20
	3.0	2.2	66.5	16.75	62.7	15.73	58.9	15.09	57.0	14.32	55.1	13.82	51.3	12.94
	5.0	4.1	65.2	14.15	61.5	13.26	57.7	12.74	55.9	12.11	54.0	11.70	50.4	10.94
	7.0	6.0	63.4	12.94	59.9	12.11	56.3	11.67	54.5	11.08	52.7	10.74	49.1	10.01
	9.0	7.9	61.2	11.18	57.7	10.47	54.2	10.09	52.4	9.59	50.7	9.29	47.3	8.66
	11.0	9.8	58.1	10.03	54.8	9.39	51.5	9.04	49.6	8.59	48.0	8.32	44.8	7.76
	13.0	11.8	54.3	8.68	51.2	8.13	48.1	7.83	46.6	7.49	45.1	7.21	41.9	6.76
15.0	13.7	51.3	7.82	48.5	7.32	45.6	7.05	44.1	6.70	42.7	6.49	39.7	6.05	

**Note**

1. TC: Total Capacity(kW), PI : Power Input(kW, Comp. + Outdoor fan motor)
2. Capacity tables show the average value of conditions which may occur.
3. The heating capacity table is based on the values expressed as Max. in the specification of the outdoor unit. (When measuring the Max. heating capacity, the setting status of the indoor unit is the same as that for measuring the heating capacity of the indoor unit.)

# 7. Capacity Tables

## ◆ ARUM400LTE5

Heating Capacity (40HP)

Combination (%)	Outdoor air temp.		Indoor air temp. °C DB											
			16		18		20		21		22		24	
	°C DB	°C WB	TC	PI	TC	PI	TC	PI	TC	PI	TC	PI	TC	PI
130	-24.8	-25	74.1	40.5	74.1	41.01	73.6	41.43	73.6	42.07	73.6	42.68	72.8	43.66
	-21.8	-22	91.2	41.49	91.2	41.97	90.6	42.39	90.6	43.04	90.6	43.66	89.5	44.62
	-19.8	-20	96.7	42.13	96.7	42.62	96.1	43.04	96.1	43.68	96.1	44.29	95.0	45.26
	-18.8	-19	99.1	42.46	99.1	42.94	98.5	43.36	98.5	44.01	98.5	44.62	97.3	45.59
	-16.7	-17	103.9	43.13	103.9	43.62	103.3	44.04	103.3	44.68	103.3	45.30	102.1	46.26
	-13.7	-15	110.8	44.10	110.8	44.59	110.1	45.01	110.1	45.65	110.1	46.26	108.8	46.63
	-11.8	-13	114.5	44.72	114.5	45.20	113.8	45.62	113.8	46.26	113.8	46.86	112.8	47.63
	-9.8	-11	118.4	45.36	118.4	45.84	117.7	46.26	117.7	46.90	117.7	47.54	116.7	48.63
	-9.5	-10	119.3	45.46	119.3	45.94	118.6	46.09	118.6	46.74	118.6	47.38	117.6	48.94
	-8.5	-9.1	122.6	45.78	122.6	46.26	121.9	46.51	121.9	47.16	121.9	47.80	120.7	49.24
	-7.0	-7.6	127.6	46.26	127.6	46.74	126.9	47.00	126.9	47.64	126.9	48.28	125.7	49.94
	-5.0	-5.6	134.2	47.10	134.2	47.58	133.5	47.90	133.5	48.54	133.5	49.22	132.3	50.64
	-3.0	-3.7	140.8	48.00	140.8	48.48	140.1	48.80	140.1	49.44	140.1	50.16	138.9	51.34
	0.0	-0.7	150.7	49.00	150.7	49.48	149.9	49.80	149.9	50.44	149.9	51.20	148.5	52.04
	3.0	2.2	155.1	49.96	155.1	50.42	154.3	50.74	154.3	51.30	154.3	52.06	152.9	52.74
	5.0	4.1	155.1	36.24	154.7	35.11	153.9	34.12	152.4	33.10	148.2	32.11	138.0	31.08
	7.0	6.0	153.7	34.56	153.4	33.45	152.7	32.48	149.7	31.54	144.4	30.59	134.4	29.68
9.0	7.9	148.5	32.33	148.2	31.28	147.8	30.37	144.2	29.49	139.1	28.61	129.5	27.76	
11.0	9.8	140.5	30.48	140.2	29.50	139.8	28.64	136.3	27.81	131.6	26.98	122.5	26.17	
13.0	11.8	131.9	28.21	131.7	27.30	131.3	26.50	128.0	25.73	123.5	24.97	115.0	24.22	
15.0	13.7	124.9	26.34	124.6	25.49	124.2	24.75	121.2	24.03	116.9	23.31	108.8	22.61	
120	-24.8	-25	73.6	41.01	73.6	41.43	73.1	42.07	73.1	42.68	73.1	43.29	72.3	44.33
	-21.8	-22	90.6	41.97	90.6	42.39	90.0	43.04	90.0	43.66	90.0	44.29	89.0	45.30
	-19.8	-20	96.1	42.62	96.1	43.04	95.4	43.68	95.4	44.29	95.4	44.90	94.3	45.94
	-18.8	-19	98.3	42.94	98.3	43.36	97.7	44.01	97.7	44.62	97.7	45.26	96.6	46.26
	-16.7	-17	103.1	43.62	103.1	44.04	102.5	44.68	102.5	45.30	102.5	46.26	101.3	46.90
	-13.7	-15	110.0	44.59	110.0	45.01	109.3	45.65	109.3	46.26	109.3	46.90	108.0	47.54
	-11.8	-13	113.7	45.20	113.7	45.62	113.0	46.26	113.0	46.90	113.0	47.54	112.0	48.28
	-9.8	-11	117.5	45.84	117.5	46.26	116.8	46.90	116.8	47.54	116.8	48.28	115.7	49.24
	-9.5	-10	118.5	45.94	118.5	46.07	117.8	46.74	117.8	47.38	117.8	48.06	116.7	49.56
	-8.5	-9.1	121.8	46.26	121.8	46.74	121.0	47.22	121.0	47.86	121.0	48.50	120.0	49.24
	-7.0	-7.6	126.7	46.74	126.7	47.22	125.9	47.70	125.9	48.34	125.9	49.02	124.7	50.30
	-5.0	-5.6	133.3	47.58	133.3	48.06	132.4	48.54	132.4	49.18	132.4	50.00	131.2	50.64
	-3.0	-3.7	139.7	48.48	139.7	48.96	138.9	49.28	138.9	50.00	138.9	50.82	137.7	51.34
	0.0	-0.7	149.6	49.48	149.1	49.96	148.0	50.44	147.0	51.06	146.0	51.70	144.8	52.44
	3.0	2.2	153.9	39.12	153.2	38.17	150.2	37.34	146.9	36.58	142.3	36.02	132.2	35.34
	5.0	4.1	154.0	34.36	152.9	33.45	148.9	32.71	144.0	32.02	139.5	31.56	129.6	30.95
	7.0	6.0	152.8	32.60	151.1	31.72	145.2	31.09	140.3	30.49	135.9	30.21	126.2	29.67
9.0	7.9	147.5	30.40	145.5	29.57	139.8	28.99	135.1	28.44	130.9	28.16	121.7	27.66	
11.0	9.8	139.5	28.56	137.6	27.78	132.2	27.23	127.8	26.72	123.9	26.46	115.0	26.00	
13.0	11.8	131.0	26.33	129.2	25.61	124.2	25.11	120.0	24.63	116.3	24.39	108.1	23.96	
15.0	13.7	124.0	24.47	122.3	23.80	117.5	23.33	113.6	22.90	110.1	22.68	102.2	22.28	
110	-24.8	-25	73.2	41.43	73.2	42.07	72.8	42.68	72.8	43.29	72.8	43.90	71.9	44.66
	-21.8	-22	90.1	42.39	90.1	43.04	89.5	43.66	89.5	44.29	89.5	44.90	88.5	45.62
	-19.8	-20	95.6	43.04	95.6	43.68	94.9	44.29	94.9	44.90	94.9	45.51	93.8	46.26
	-18.8	-19	97.8	43.36	97.8	44.01	97.2	44.62	97.2	45.26	97.2	45.90	96.1	46.90
	-16.7	-17	102.6	44.04	102.6	44.68	102.0	45.30	102.0	46.26	102.0	46.90	100.8	47.54
	-13.7	-15	109.4	45.01	109.4	45.65	108.7	46.26	108.7	46.90	108.7	47.54	107.5	48.28
	-11.8	-13	113.0	45.62	113.0	46.26	112.4	46.90	112.4	47.54	112.4	48.28	111.2	49.24
	-9.8	-11	116.9	46.26	116.9	46.90	116.2	47.54	116.2	48.28	116.2	49.24	115.0	50.30
	-9.5	-10	117.8	46.04	117.8	46.74	117.2	47.38	117.2	48.06	117.2	48.70	116.0	49.56
	-8.5	-9.1	121.1	45.31	121.1	46.00	120.4	46.74	120.4	47.38	120.4	48.06	119.2	49.24
	-7.0	-7.6	126.0	44.19	126.0	44.97	125.2	45.74	125.2	46.50	125.2	47.22	124.0	48.28
	-5.0	-5.6	132.5	44.72	132.5	45.50	131.6	46.26	131.6	47.00	131.6	47.74	130.4	48.90
	-3.0	-3.7	139.0	45.62	139.0	46.30	138.1	46.90	138.1	47.64	138.1	48.38	136.9	49.56
	0.0	-0.7	146.8	46.52	146.3	47.20	145.3	47.86	144.0	48.50	143.0	49.24	141.8	50.30
	3.0	2.2	150.9	36.81	145.3	36.09	136.3	35.54	131.9	34.88	127.4	34.33	119.0	33.41
	5.0	4.1	150.7	32.04	142.3	31.44	133.6	30.98	129.2	30.45	124.9	29.99	116.6	29.11
	7.0	6.0	146.8	30.13	138.8	29.68	130.2	29.35	126.0	28.98	121.7	28.62	113.6	27.73
9.0	7.9	141.5	27.94	133.6	27.52	125.4	27.21	121.3	26.88	117.3	26.54	109.5	25.71	
11.0	9.8	133.8	26.10	126.4	25.70	118.6	25.41	114.8	25.11	110.9	24.78	103.5	24.02	
13.0	11.8	125.6	23.90	118.7	23.54	111.4	23.27	107.8	22.99	104.1	22.70	97.2	22.00	
15.0	13.7	118.8	22.04	112.3	21.71	105.4	21.46	101.9	21.20	98.5	20.93	92.0	20.28	

# 7. Capacity Tables

Heating Capacity (40HP)

Combination (%)	Outdoor air temp.		Indoor air temp. °C DB											
			16		18		20		21		22		24	
	°C DB	°C WB	TC	PI	TC	PI	TC	PI	TC	PI	TC	PI	TC	PI
100	-24.8	-25	72.9	45.87	72.9	45.92	72.4	43.55	72.4	46.05	72.4	46.11	71.5	46.14
	-21.8	-22	89.6	45.94	89.6	46.00	89.1	44.93	89.1	46.13	89.1	46.81	88.0	46.22
	-19.8	-20	95.1	46.00	95.1	46.05	94.6	45.81	94.6	46.19	94.6	46.45	93.5	46.26
	-18.8	-19	97.4	46.03	96.8	46.08	96.8	46.13	96.8	46.21	96.8	46.26	95.6	45.57
	-16.7	-17	101.5	46.09	101.5	46.14	101.5	46.81	101.0	46.26	101.0	44.83	99.8	44.09
	-13.7	-15	108.9	46.16	108.9	46.21	108.2	46.26	108.2	44.19	108.2	42.76	107.0	41.98
	-11.8	-13	112.5	46.22	111.9	46.26	111.9	44.88	111.9	42.87	111.9	41.46	108.5	40.65
	-9.8	-11	116.2	46.26	116.2	44.72	115.7	43.42	115.7	41.48	114.7	40.09	108.7	39.25
	-9.5	-10	117.2	46.02	117.2	44.49	116.7	43.21	116.7	41.27	115.3	39.88	108.7	39.04
	-8.5	-9.1	120.4	45.22	120.4	43.71	119.9	42.48	120.7	40.58	116.7	39.20	108.7	38.33
	-7.0	-7.6	127.4	44.02	126.9	42.56	124.7	41.38	120.7	39.55	116.7	38.16	108.7	37.28
	-5.0	-5.6	133.0	42.41	131.6	41.02	124.7	39.93	120.7	38.15	116.7	36.79	108.7	35.88
	-3.0	-3.7	136.8	40.81	132.7	39.47	124.7	38.48	120.7	36.77	116.7	35.42	108.7	34.47
	0.0	-0.7	140.7	38.39	132.7	37.15	124.7	36.29	120.7	34.69	116.7	33.36	108.7	32.37
	3.0	2.2	140.7	35.98	132.7	34.83	124.7	34.11	120.7	32.61	116.7	31.29	108.7	30.27
	5.0	4.1	137.8	31.20	130.1	30.17	122.2	29.55	118.3	28.22	114.4	27.02	106.6	26.06
	7.0	6.0	134.3	29.17	126.7	28.25	119.1	27.76	115.3	26.56	111.5	25.41	103.9	24.44
	9.0	7.9	129.4	26.86	122.0	26.01	114.8	25.56	111.1	24.45	107.4	23.39	100.0	22.50
	11.0	9.8	122.4	24.88	115.5	24.09	108.4	23.67	105.0	22.65	101.5	21.67	94.6	20.84
	13.0	11.8	114.9	22.56	108.4	21.85	101.9	21.47	98.7	20.54	95.3	19.66	88.8	18.90
15.0	13.7	108.7	20.58	102.6	19.94	96.4	19.59	93.3	18.73	90.3	17.92	84.1	17.24	
90	-24.8	-25	72.6	40.80	72.6	41.76	72.1	42.45	72.1	42.76	72.1	43.41	71.3	44.38
	-21.8	-22	89.3	41.76	89.3	42.73	88.8	43.41	88.8	43.73	88.8	44.38	87.7	42.55
	-19.8	-20	94.8	42.41	94.8	43.38	94.1	44.05	94.1	44.38	94.1	43.13	93.0	41.33
	-18.8	-19	97.4	42.73	96.8	43.70	96.4	44.38	96.4	43.74	96.4	42.51	95.3	40.72
	-16.7	-17	101.5	43.41	101.5	44.38	101.1	43.07	101.1	42.40	101.1	41.21	98.4	39.43
	-13.7	-15	108.9	44.38	108.9	42.43	107.9	41.19	107.9	40.49	105.9	39.34	99.4	37.60
	-11.8	-13	112.5	43.05	111.9	41.20	111.4	40.00	109.4	39.27	107.0	38.17	99.4	36.44
	-9.8	-11	116.2	41.66	116.2	39.91	113.0	38.75	110.6	37.99	107.0	36.92	99.4	35.22
	-9.5	-10	117.2	41.45	117.2	39.71	113.6	38.56	110.6	37.80	107.0	36.73	99.4	35.03
	-8.5	-9.1	120.4	40.76	119.6	39.06	114.1	37.93	110.6	37.17	107.0	36.11	99.4	34.43
	-7.0	-7.6	127.4	39.71	121.2	38.09	114.1	37.00	110.6	36.21	107.0	35.18	99.4	33.51
	-5.0	-5.6	128.8	38.31	121.2	36.80	114.1	35.75	110.6	34.94	107.0	33.94	99.4	32.29
	-3.0	-3.7	128.8	36.92	121.2	35.51	114.1	34.50	110.6	33.66	107.0	32.69	99.4	31.07
	0.0	-0.7	128.8	34.83	121.2	33.56	114.1	32.62	110.6	31.75	107.0	30.82	99.4	29.24
	3.0	2.2	128.8	32.74	121.2	31.61	114.1	30.75	110.6	29.84	107.0	28.96	99.4	27.40
	5.0	4.1	126.2	28.37	118.8	27.40	111.8	26.63	108.4	25.78	104.9	25.01	97.4	23.61
	7.0	6.0	123.0	26.66	115.8	25.83	108.9	25.14	105.6	24.29	102.2	23.56	95.0	22.22
	9.0	7.9	118.5	24.54	111.5	23.79	104.9	23.15	101.7	22.35	98.5	21.69	91.5	20.46
	11.0	9.8	112.1	22.51	105.4	21.82	99.2	21.22	96.2	20.51	93.1	19.90	86.4	18.76
	13.0	11.8	105.2	20.00	99.0	19.38	93.2	18.87	90.3	18.22	87.4	17.68	81.2	16.67
15.0	13.7	99.5	18.05	93.7	17.50	88.2	17.03	85.4	16.45	82.7	15.96	76.9	15.05	
80	-24.8	-25	72.3	35.77	72.3	36.74	71.8	37.42	71.8	37.74	71.8	39.35	71.0	37.74
	-21.8	-22	88.3	36.74	88.3	37.70	88.3	38.38	88.3	39.35	88.3	37.74	87.0	36.18
	-19.8	-20	93.8	37.38	93.8	38.35	93.8	39.35	93.8	38.22	93.1	36.66	88.8	35.15
	-18.8	-19	96.0	37.70	96.0	39.35	96.0	38.78	96.0	37.65	94.0	36.12	88.8	34.63
	-16.7	-17	100.0	39.35	100.0	38.16	100.0	37.58	98.2	36.46	95.5	35.01	88.8	33.55
	-13.7	-15	106.7	37.60	104.6	36.46	102.1	35.87	99.0	34.76	95.5	33.39	88.8	31.99
	-11.8	-13	109.3	36.49	106.1	35.39	102.1	34.78	99.0	33.69	95.5	32.37	88.8	31.01
	-9.8	-11	111.8	35.32	107.4	34.27	102.1	33.64	99.0	32.56	95.5	31.29	88.8	29.97
	-9.5	-10	112.6	35.15	108.1	34.09	102.1	33.46	99.0	32.38	95.5	31.13	88.8	29.82
	-8.5	-9.1	113.9	34.56	108.7	33.53	102.1	32.89	99.0	31.82	95.5	30.60	88.8	29.30
	-7.0	-7.6	115.3	33.68	108.7	32.68	102.1	32.04	99.0	30.97	95.5	29.80	88.8	28.52
	-5.0	-5.6	115.3	32.52	108.7	31.55	102.1	30.89	99.0	29.83	95.5	28.72	88.8	27.48
	-3.0	-3.7	115.3	31.35	108.7	30.42	102.1	29.75	99.0	28.70	95.5	27.65	88.8	26.45
	0.0	-0.7	115.3	29.59	108.7	28.73	102.1	28.04	99.0	27.01	95.5	26.03	88.8	24.90
	3.0	2.2	115.3	27.84	108.7	27.03	102.1	26.32	99.0	25.30	95.5	24.43	88.8	23.34
	5.0	4.1	113.0	24.11	106.6	23.38	100.0	22.74	97.0	21.81	93.5	21.06	87.1	20.11
	7.0	6.0	110.1	22.70	103.9	22.05	97.5	21.39	94.5	20.50	91.1	19.83	84.8	18.93
	9.0	7.9	106.1	20.33	100.0	19.76	93.9	19.27	91.1	18.52	87.8	17.86	81.7	17.02
	11.0	9.8	100.4	18.06	94.5	17.56	88.8	17.12	86.1	16.45	83.1	15.87	77.2	15.12
	13.0	11.8	94.2	15.69	88.8	15.25	83.4	14.87	80.9	14.29	78.0	13.78	72.5	13.13
15.0	13.7	89.1	14.16	84.1	13.75	78.9	13.41	76.5	12.89	73.8	12.44	68.6	11.85	

# 7. Capacity Tables

Heating Capacity (40HP)

Combination (%)	Outdoor air temp.		Indoor air temp. °C DB											
			16		18		20		21		22		24	
	°C DB	°C WB	TC	PI	TC	PI	TC	PI	TC	PI	TC	PI	TC	PI
70	-24.8	-25	72.3	36.30	72.3	36.62	71.8	37.27	71.8	38.24	71.8	36.48	71.0	34.84
	-21.8	-22	86.2	37.27	86.5	37.59	85.9	38.24	83.9	36.48	81.4	34.84	76.0	33.25
	-19.8	-20	93.5	37.91	91.2	38.24	86.9	37.01	83.9	35.32	81.4	33.75	76.0	32.19
	-18.8	-19	95.4	38.24	92.1	37.61	86.9	36.40	83.9	34.73	81.4	33.20	76.0	31.65
	-16.7	-17	97.5	36.93	92.3	36.28	86.9	35.12	83.9	33.50	81.4	32.05	76.0	30.54
	-13.7	-15	97.8	35.07	92.3	34.39	86.9	33.28	83.9	31.76	81.4	30.41	76.0	28.94
	-11.8	-13	97.8	33.88	92.3	33.19	86.9	32.11	83.9	30.64	81.4	29.37	76.0	27.93
	-9.8	-11	97.8	32.64	92.3	31.92	86.9	30.89	83.9	29.47	81.4	28.27	76.0	26.87
	-9.5	-10	97.8	32.46	92.3	31.73	86.9	30.71	83.9	29.30	81.4	28.11	76.0	26.71
	-8.5	-9.1	97.8	31.84	92.3	31.10	86.9	30.09	83.9	28.72	81.4	27.56	76.0	26.17
	-7.0	-7.6	97.8	30.90	92.3	30.16	86.9	29.18	83.9	27.84	81.4	26.74	76.0	25.38
	-5.0	-5.6	97.8	29.66	92.3	28.90	86.9	27.95	83.9	26.68	81.4	25.65	76.0	24.32
	-3.0	-3.7	97.8	28.42	92.3	27.63	86.9	26.72	83.9	25.51	81.4	24.55	76.0	23.25
	0.0	-0.7	97.8	26.56	92.3	25.74	86.9	24.89	83.9	23.75	81.4	22.91	76.0	21.66
	3.0	2.2	97.8	24.69	92.3	23.85	86.9	23.05	83.9	22.01	81.4	21.26	76.0	20.06
	5.0	4.1	97.8	21.67	90.5	20.41	85.1	19.72	82.2	18.81	79.8	18.21	74.5	17.15
	7.0	6.0	97.9	20.76	88.1	18.98	82.9	18.33	80.1	17.51	77.7	16.98	72.5	15.96
	9.0	7.9	94.3	17.97	84.9	16.42	79.9	15.87	77.2	15.15	74.9	14.69	69.8	13.81
	11.0	9.8	89.3	15.94	80.4	14.56	75.6	14.08	73.0	13.44	70.8	13.04	66.1	12.26
	13.0	11.8	83.8	13.97	75.5	12.77	71.0	12.35	68.5	11.78	66.5	11.42	62.1	10.74
15.0	13.7	79.2	12.45	71.4	11.38	67.1	11.00	64.8	10.50	62.9	10.18	58.7	9.57	
60	-24.8	-25	72.3	35.65	72.3	36.30	71.8	37.27	70.7	35.41	69.2	33.67	65.1	32.02
	-21.8	-22	79.2	36.62	79.4	37.27	74.5	35.41	72.0	33.67	69.5	32.02	65.1	30.43
	-19.8	-20	83.9	37.27	79.4	35.96	74.5	34.17	72.0	32.51	69.5	30.92	65.1	29.36
	-18.8	-19	83.9	36.61	79.4	35.30	74.5	33.55	72.0	31.92	69.5	30.37	65.1	28.82
	-16.7	-17	83.9	35.23	79.4	33.93	74.5	32.25	72.0	30.69	69.5	29.22	65.1	27.70
	-13.7	-15	83.9	33.26	79.4	31.98	74.5	30.40	72.0	28.95	69.5	27.58	65.1	26.11
	-11.8	-13	83.9	32.02	79.4	30.73	74.5	29.22	72.0	27.84	69.5	26.54	65.1	25.10
	-9.8	-11	83.9	30.71	79.4	29.43	74.5	27.98	72.0	26.68	69.5	25.44	65.1	24.03
	-9.5	-10	83.9	30.51	79.4	29.24	74.5	27.80	72.0	26.51	69.5	25.27	65.1	23.87
	-8.5	-9.1	83.9	29.86	79.4	28.58	74.5	27.18	72.0	25.93	69.5	24.72	65.1	23.34
	-7.0	-7.6	83.9	28.88	79.4	27.60	74.5	26.26	72.0	25.05	69.5	23.90	65.1	22.54
	-5.0	-5.6	83.9	27.57	79.4	26.29	74.5	25.01	72.0	23.89	69.5	22.80	65.1	21.48
	-3.0	-3.7	83.9	26.26	79.4	24.98	74.5	23.78	72.0	22.73	69.5	21.71	65.1	20.41
	0.0	-0.7	83.9	24.29	79.4	23.03	74.5	21.93	72.0	20.98	69.5	20.06	65.1	18.81
	3.0	2.2	83.9	22.32	79.4	21.07	74.5	20.07	72.0	19.24	69.5	18.42	65.1	17.21
	5.0	4.1	82.2	19.01	77.9	17.87	73.0	17.01	70.5	16.33	68.1	15.65	63.8	14.59
	7.0	6.0	80.1	17.54	75.9	16.43	71.1	15.66	68.8	15.05	66.4	14.44	62.1	13.42
	9.0	7.9	77.2	15.02	73.0	14.06	68.5	13.41	66.3	12.88	63.9	12.37	59.9	11.49
	11.0	9.8	73.0	13.32	69.1	12.47	64.8	11.89	62.6	11.43	60.4	10.96	56.6	10.19
	13.0	11.8	68.5	11.67	64.9	10.93	60.9	10.41	58.8	10.01	56.8	9.60	53.2	8.94
15.0	13.7	64.8	10.50	61.4	9.82	57.6	9.28	55.7	8.93	53.7	8.56	50.3	8.03	
50	-24.8	-25	70.0	31.70	66.0	32.67	62.1	30.99	60.1	29.42	58.1	27.92	54.1	26.54
	-21.8	-22	70.0	32.67	66.0	30.99	62.1	29.42	60.1	27.92	58.1	26.54	54.1	25.20
	-19.8	-20	70.0	31.50	66.0	29.87	62.1	28.37	60.1	26.93	58.1	25.61	54.1	24.30
	-18.8	-19	70.0	30.92	66.0	29.31	62.1	27.85	60.1	26.44	58.1	25.14	54.1	23.85
	-16.7	-17	70.0	29.70	66.0	28.14	62.1	26.75	60.1	25.40	58.1	24.18	54.1	22.91
	-13.7	-15	70.0	27.95	66.0	26.46	62.1	25.18	60.1	23.90	58.1	22.79	54.1	21.57
	-11.8	-13	70.0	26.85	66.0	25.40	62.1	24.18	60.1	22.96	58.1	21.91	54.1	20.72
	-9.8	-11	70.0	25.68	66.0	24.28	62.1	23.13	60.1	21.96	58.1	20.98	54.1	19.82
	-9.5	-10	70.0	25.51	66.0	24.11	62.1	22.98	60.1	21.82	58.1	20.84	54.1	19.69
	-8.5	-9.1	70.0	24.92	66.0	23.55	62.1	22.45	60.1	21.32	58.1	20.38	54.1	19.24
	-7.0	-7.6	70.0	24.05	66.0	22.72	62.1	21.67	60.1	20.58	58.1	19.69	54.1	18.58
	-5.0	-5.6	70.0	22.88	66.0	21.60	62.1	20.62	60.1	19.58	58.1	18.75	54.1	17.68
	-3.0	-3.7	70.0	21.72	66.0	20.48	62.1	19.57	60.1	18.59	58.1	17.82	54.1	16.79
	0.0	-0.7	70.0	19.97	66.0	18.79	62.1	18.00	60.1	17.09	58.1	16.44	54.1	15.44
	3.0	2.2	70.0	18.23	66.0	17.12	62.1	16.43	60.1	15.60	58.1	15.05	54.1	14.10
	5.0	4.1	68.6	15.43	64.8	14.46	60.8	13.90	58.9	13.21	56.9	12.76	53.0	11.94
	7.0	6.0	66.8	14.15	63.1	13.24	59.3	12.76	57.4	12.11	55.5	11.75	51.7	10.95
	9.0	7.9	64.4	12.24	60.8	11.46	57.1	11.04	55.2	10.49	53.4	10.16	49.8	9.48
	11.0	9.8	61.2	10.98	57.7	10.28	54.2	9.90	52.2	9.41	50.5	9.11	47.1	8.50
	13.0	11.8	57.2	9.52	53.9	8.92	50.7	8.59	49.0	8.21	47.5	7.91	44.2	7.42
15.0	13.7	54.1	8.58	51.0	8.04	48.0	7.74	46.5	7.36	44.9	7.13	41.8	6.65	

**Note**

1. TC: Total Capacity(kW), PI : Power Input(kW, Comp. + Outdoor fan motor)
2. Capacity tables show the average value of conditions which may occur.
3. The heating capacity table is based on the values expressed as Max. in the specification of the outdoor unit. (When measuring the Max. heating capacity, the setting status of the indoor unit is the same as that for measuring the heating capacity of the indoor unit.)

# 7. Capacity Tables

## ◆ ARUM420LTE5

Heating Capacity (42HP)

Combination (%)	Outdoor air temp.		Indoor air temp. °C DB											
			16		18		20		21		22		24	
	°C DB	°C WB	TC	PI	TC	PI	TC	PI	TC	PI	TC	PI	TC	PI
130	-24.8	-25	82.7	43.3	82.7	43.66	82.1	43.94	82.1	44.36	82.1	44.78	80.6	45.43
	-21.8	-22	100.2	43.98	100.2	44.30	99.5	44.58	99.5	45.01	99.5	45.43	97.6	46.07
	-19.8	-20	105.5	44.41	105.5	44.73	104.8	45.01	104.8	45.45	104.8	45.85	102.8	46.50
	-18.8	-19	107.8	44.62	107.8	44.95	107.1	45.23	107.1	45.66	107.1	46.07	105.0	46.72
	-16.7	-17	112.5	45.08	112.5	45.40	111.7	45.68	111.7	46.11	111.7	46.53	109.6	47.17
	-13.7	-15	119.2	45.72	119.2	46.05	118.4	46.33	118.4	46.76	118.4	47.17	116.2	45.36
	-11.8	-13	123.0	46.14	123.0	46.45	122.3	46.73	122.3	47.17	122.3	45.95	120.3	44.21
	-9.8	-11	127.1	46.56	127.1	46.89	126.4	47.17	126.4	45.87	126.4	44.67	124.7	43.01
	-9.5	-10	127.8	46.64	127.8	46.95	127.1	46.97	127.1	45.67	126.9	44.48	125.4	42.82
	-8.5	-9.1	130.3	46.84	130.3	47.17	129.6	46.30	129.6	45.02	129.0	43.84	127.5	42.22
	-7.0	-7.6	134.0	47.17	134.0	46.19	133.2	45.30	133.2	44.04	133.2	42.86	130.8	41.31
	-5.0	-5.6	139.0	45.90	139.0	44.88	138.1	43.97	138.1	42.74	138.1	41.58	135.1	40.11
	-3.0	-3.7	143.9	44.63	143.9	43.58	143.0	42.63	143.0	41.43	143.0	40.30	139.5	38.90
	0.0	-0.7	151.3	42.72	151.3	41.62	150.3	40.64	150.3	39.48	150.3	38.38	146.1	37.09
	3.0	2.2	158.8	40.82	158.8	39.65	157.7	38.63	157.7	37.52	157.7	36.44	147.9	35.28
	5.0	4.1	160.7	35.94	160.4	34.80	159.4	33.81	159.4	32.79	155.7	31.79	144.9	30.76
	7.0	6.0	161.3	34.06	161.0	32.97	160.0	32.01	157.2	31.08	151.7	30.15	141.2	29.25
9.0	7.9	156.1	31.67	155.7	30.64	155.3	29.75	151.4	28.89	146.2	28.02	136.1	27.19	
11.0	9.8	147.6	29.65	147.3	28.70	146.9	27.86	143.2	27.05	138.2	26.25	128.7	25.46	
13.0	11.8	138.6	27.23	138.4	26.35	137.9	25.58	134.5	24.84	129.8	24.10	120.8	23.37	
15.0	13.7	131.2	25.20	130.8	24.38	130.5	23.68	127.3	22.99	122.9	22.30	114.3	21.63	
120	-24.8	-25	82.1	43.66	82.1	43.94	81.6	44.36	81.6	44.78	81.6	45.43	80.1	45.88
	-21.8	-22	99.5	44.30	99.5	44.58	98.8	45.01	98.8	45.43	98.8	46.07	97.0	46.53
	-19.8	-20	104.7	44.73	104.7	45.01	104.0	45.45	104.0	45.85	104.0	46.50	102.1	46.95
	-18.8	-19	106.9	44.95	106.9	45.23	106.2	45.66	106.2	46.07	106.2	46.72	104.3	47.17
	-16.7	-17	111.6	45.40	111.6	45.68	110.9	46.11	110.9	46.53	110.9	47.17	108.8	46.00
	-13.7	-15	118.3	46.05	118.3	46.33	117.6	46.76	117.6	47.17	117.6	45.43	115.3	44.34
	-11.8	-13	122.2	46.45	122.2	46.73	121.4	47.17	121.4	45.94	121.4	44.33	119.5	43.29
	-9.8	-11	126.2	46.89	126.2	47.17	125.5	45.81	125.5	44.64	125.5	43.17	123.8	42.18
	-9.5	-10	126.9	46.95	126.9	46.95	126.2	45.61	126.2	44.45	126.2	43.00	124.5	42.01
	-8.5	-9.1	129.4	47.17	129.4	46.23	128.6	44.93	128.6	43.80	128.4	42.43	126.6	41.46
	-7.0	-7.6	133.1	46.10	133.1	45.16	132.2	43.92	132.2	42.83	131.8	41.56	129.9	40.62
	-5.0	-5.6	138.0	44.67	138.0	43.72	137.2	42.56	137.2	41.53	137.2	40.39	134.2	39.51
	-3.0	-3.7	142.9	43.24	142.9	42.30	142.0	41.20	142.0	40.25	142.0	39.24	138.1	38.40
	0.0	-0.7	150.3	41.10	150.3	40.14	149.3	39.17	149.3	38.30	149.3	37.50	138.9	36.74
	3.0	2.2	157.6	38.96	157.6	37.99	156.6	37.14	154.3	36.36	149.5	35.76	138.9	35.07
	5.0	4.1	159.7	34.07	159.2	33.15	156.4	32.40	151.3	31.71	146.5	31.24	136.1	30.63
	7.0	6.0	160.4	32.13	158.7	31.26	152.5	30.64	147.4	30.05	142.8	29.77	132.6	29.24
9.0	7.9	155.0	29.79	152.9	28.97	146.9	28.40	141.9	27.86	137.5	27.59	127.8	27.10	
11.0	9.8	146.5	27.81	144.6	27.05	138.9	26.51	134.2	26.01	130.1	25.76	120.8	25.31	
13.0	11.8	137.7	25.44	135.8	24.75	130.5	24.26	126.1	23.80	122.2	23.57	113.5	23.15	
15.0	13.7	130.3	23.45	128.5	22.81	123.4	22.36	119.3	21.94	115.6	21.73	107.4	21.34	
110	-24.8	-25	81.7	43.94	81.7	44.36	81.2	44.78	81.2	45.43	81.2	45.88	79.6	46.09
	-21.8	-22	99.0	44.58	99.0	45.01	98.3	45.43	98.3	46.07	98.3	46.53	96.5	46.73
	-19.8	-20	104.2	45.01	104.2	45.45	103.5	45.85	103.5	46.50	103.5	46.95	101.5	47.17
	-18.8	-19	106.4	45.23	106.4	45.66	105.7	46.07	105.7	46.72	105.7	47.17	103.7	46.55
	-16.7	-17	111.0	45.68	111.0	46.11	110.3	46.53	110.3	47.17	110.3	45.91	108.2	45.26
	-13.7	-15	117.6	46.33	117.6	46.76	116.9	47.17	116.9	45.26	116.9	44.11	116.9	43.42
	-11.8	-13	121.5	46.73	121.5	47.17	120.7	45.82	120.7	44.05	120.7	42.97	120.7	42.25
	-9.8	-11	125.5	47.17	125.5	45.65	124.8	44.41	124.8	42.78	124.8	41.77	123.8	41.03
	-9.5	-10	126.2	46.92	126.2	45.42	125.5	44.19	125.5	42.59	125.5	41.59	125.0	40.85
	-8.5	-9.1	128.7	46.10	128.7	44.66	128.0	43.48	128.0	41.95	128.0	40.98	125.0	40.22
	-7.0	-7.6	132.4	44.86	132.4	43.52	131.5	42.42	131.5	41.00	131.5	40.09	125.0	39.31
	-5.0	-5.6	137.2	43.23	137.2	41.99	136.3	41.01	136.3	39.73	133.8	38.89	125.0	38.07
	-3.0	-3.7	142.1	41.58	142.1	40.47	141.3	39.58	138.6	38.45	133.8	37.68	125.0	36.85
	0.0	-0.7	149.4	39.12	149.4	38.19	143.2	37.46	138.6	36.55	133.8	35.89	125.0	35.01
	3.0	2.2	156.7	36.65	152.7	35.91	143.2	35.33	138.6	34.65	133.8	34.08	125.0	33.16
	5.0	4.1	158.3	31.77	149.5	31.15	140.4	30.68	135.8	30.14	131.2	29.68	122.5	28.81
	7.0	6.0	154.2	29.69	145.8	29.25	136.8	28.92	132.4	28.57	127.8	28.20	119.4	27.33
9.0	7.9	148.6	27.38	140.4	26.97	131.7	26.67	127.5	26.34	123.2	26.01	115.0	25.20	
11.0	9.8	140.5	25.41	132.8	25.03	124.6	24.75	120.6	24.45	116.5	24.13	108.8	23.39	
13.0	11.8	131.9	23.11	124.7	22.75	117.1	22.50	113.2	22.22	109.3	21.94	102.1	21.27	
15.0	13.7	124.8	21.13	118.0	20.81	110.7	20.57	107.1	20.33	103.5	20.07	96.6	19.44	



# 7. Capacity Tables

Heating Capacity (42HP)

Combination (%)	Outdoor air temp.		Indoor air temp. °C DB											
			16		18		20		21		22		24	
	°C DB	°C WB	TC	PI	TC	PI	TC	PI	TC	PI	TC	PI	TC	PI
100	-24.8	-25	81.3	47.51	81.3	47.47	80.8	44.77	80.8	47.35	80.8	47.31	79.2	47.29
	-21.8	-22	98.5	47.44	98.5	47.40	97.9	46.19	97.9	47.28	97.9	47.73	96.0	47.22
	-19.8	-20	103.7	47.40	103.7	47.35	103.1	47.07	103.1	47.24	103.1	47.36	101.2	47.17
	-18.8	-19	105.9	47.38	105.3	47.33	105.3	47.28	105.3	47.21	105.3	47.17	103.2	46.42
	-16.7	-17	109.8	47.33	109.8	47.28	109.8	47.73	109.3	47.17	109.3	45.62	107.2	44.85
	-13.7	-15	117.1	47.26	117.1	47.21	116.4	47.17	116.4	44.92	116.4	43.41	114.2	42.59
	-11.8	-13	120.9	47.22	120.2	47.17	120.2	45.66	120.2	43.49	120.2	42.00	114.2	41.17
	-9.8	-11	124.8	47.17	124.8	45.48	124.3	44.07	124.3	42.00	122.6	40.53	114.2	39.67
	-9.5	-10	125.5	46.90	125.5	45.22	125.0	43.84	125.0	41.77	122.6	40.31	114.2	39.44
	-8.5	-9.1	128.0	46.02	128.0	44.38	127.4	43.04	126.8	41.02	122.6	39.57	114.2	38.69
	-7.0	-7.6	133.8	44.69	133.3	43.11	131.0	41.85	126.8	39.91	122.6	38.47	114.2	37.56
	-5.0	-5.6	139.7	42.92	138.3	41.43	131.0	40.27	126.8	38.40	122.6	36.99	114.2	36.06
	-3.0	-3.7	143.7	41.15	139.4	39.73	131.0	38.68	126.8	36.90	122.6	35.52	114.2	34.56
	0.0	-0.7	147.8	38.50	139.4	37.20	131.0	36.30	126.8	34.65	122.6	33.30	114.2	32.31
	3.0	2.2	147.8	35.84	139.4	34.66	131.0	33.92	126.8	32.41	122.6	31.09	114.2	30.06
	5.0	4.1	144.8	30.94	136.6	29.90	128.4	29.27	124.3	27.95	120.2	26.75	112.0	25.80
	7.0	6.0	141.1	28.75	133.1	27.84	125.1	27.36	121.1	26.18	117.1	25.05	109.1	24.09
	9.0	7.9	135.9	26.23	128.2	25.40	120.6	24.97	116.7	23.88	112.8	22.85	105.1	21.97
	11.0	9.8	128.5	24.04	121.3	23.28	113.9	22.88	110.4	21.89	106.7	20.94	99.4	20.14
	13.0	11.8	120.8	21.53	113.9	20.85	107.0	20.49	103.6	19.61	100.2	18.76	93.3	18.04
15.0	13.7	114.2	19.36	107.7	18.75	101.2	18.42	98.0	17.62	94.8	16.86	88.3	16.22	
90	-24.8	-25	81.0	42.87	81.0	43.51	80.5	43.97	80.5	44.18	80.5	44.61	79.0	45.26
	-21.8	-22	98.1	43.51	98.1	44.16	97.5	44.61	97.5	44.83	97.5	45.26	95.6	43.31
	-19.8	-20	103.3	43.94	103.3	44.59	102.6	45.04	102.6	45.26	102.6	43.92	100.7	42.01
	-18.8	-19	105.9	44.16	105.3	44.81	104.8	45.26	104.8	44.58	104.8	43.26	102.8	41.37
	-16.7	-17	109.8	44.61	109.8	45.26	109.4	43.84	109.4	43.13	109.4	41.87	104.4	40.00
	-13.7	-15	117.1	45.26	117.1	43.15	116.0	41.82	116.0	41.08	112.5	39.87	104.4	38.05
	-11.8	-13	120.9	43.81	120.2	41.81	119.7	40.53	116.2	39.77	112.5	38.61	104.4	36.82
	-9.8	-11	124.8	42.30	124.8	40.41	119.9	39.18	116.2	38.40	112.5	37.27	104.4	35.52
	-9.5	-10	125.5	42.06	125.5	40.20	119.9	38.98	116.2	38.20	112.5	37.07	104.4	35.32
	-8.5	-9.1	128.0	41.31	127.1	39.50	119.9	38.30	116.2	37.51	112.5	36.41	104.4	34.67
	-7.0	-7.6	133.8	40.16	127.3	38.44	119.9	37.29	116.2	36.48	112.5	35.41	104.4	33.69
	-5.0	-5.6	135.3	38.64	127.3	37.04	119.9	35.95	116.2	35.12	112.5	34.08	104.4	32.40
	-3.0	-3.7	135.3	37.12	127.3	35.64	119.9	34.59	116.2	33.74	112.5	32.74	104.4	31.10
	0.0	-0.7	135.3	34.84	127.3	33.53	119.9	32.56	116.2	31.69	112.5	30.75	104.4	29.15
	3.0	2.2	135.3	32.56	127.3	31.41	119.9	30.54	116.2	29.63	112.5	28.76	104.4	27.20
	5.0	4.1	132.6	28.11	124.8	27.13	117.4	26.36	113.9	25.53	110.2	24.75	102.3	23.36
	7.0	6.0	129.2	26.27	121.6	25.46	114.4	24.77	110.9	23.94	107.4	23.22	99.8	21.90
	9.0	7.9	124.5	23.97	117.1	23.23	110.2	22.60	106.8	21.83	103.5	21.18	96.1	19.98
	11.0	9.8	117.8	21.75	110.7	21.08	104.2	20.51	101.0	19.82	97.8	19.23	90.8	18.12
	13.0	11.8	110.5	19.08	104.0	18.50	97.9	18.01	94.9	17.39	91.8	16.87	85.3	15.91
15.0	13.7	104.6	16.98	98.4	16.45	92.7	16.01	89.8	15.47	86.9	15.00	80.7	14.15	
80	-24.8	-25	80.6	37.74	80.6	38.39	80.1	38.84	80.1	39.06	80.1	40.13	78.6	38.42
	-21.8	-22	97.1	38.39	97.1	39.03	97.1	39.48	97.1	40.13	97.1	38.42	93.3	36.77
	-19.8	-20	102.2	38.81	102.2	39.46	102.2	40.13	102.2	38.92	100.3	37.27	93.3	35.67
	-18.8	-19	104.4	39.03	104.4	40.13	104.4	39.52	103.9	38.32	100.3	36.70	93.3	35.13
	-16.7	-17	107.2	40.13	107.2	38.85	107.2	38.23	104.0	37.05	100.3	35.51	93.3	33.98
	-13.7	-15	112.1	38.24	109.9	37.02	107.2	36.39	104.0	35.23	100.3	33.79	93.3	32.33
	-11.8	-13	115.2	37.03	111.8	35.86	107.2	35.22	104.0	34.08	100.3	32.70	93.3	31.28
	-9.8	-11	118.2	35.77	113.2	34.65	107.2	34.00	104.0	32.87	100.3	31.55	93.3	30.18
	-9.5	-10	119.0	35.58	113.9	34.46	107.2	33.81	104.0	32.69	100.3	31.38	93.3	30.03
	-8.5	-9.1	120.1	34.95	114.2	33.85	107.2	33.20	104.0	32.08	100.3	30.82	93.3	29.47
	-7.0	-7.6	121.1	33.99	114.2	32.94	107.2	32.28	104.0	31.18	100.3	29.96	93.3	28.65
	-5.0	-5.6	121.1	32.73	114.2	31.72	107.2	31.05	104.0	29.96	100.3	28.81	93.3	27.55
	-3.0	-3.7	121.1	31.47	114.2	30.50	107.2	29.82	104.0	28.76	100.3	27.68	93.3	26.45
	0.0	-0.7	121.1	29.56	114.2	28.68	107.2	27.99	104.0	26.94	100.3	25.95	93.3	24.81
	3.0	2.2	121.1	27.67	114.2	26.85	107.2	26.14	104.0	25.12	100.3	24.24	93.3	23.16
	5.0	4.1	118.7	23.87	111.9	23.15	105.1	22.51	101.9	21.59	98.2	20.84	91.5	19.90
	7.0	6.0	115.7	22.37	109.1	21.73	102.4	21.08	99.3	20.21	95.7	19.54	89.1	18.66
	9.0	7.9	111.4	19.83	105.1	19.28	98.6	18.80	95.7	18.08	92.2	17.43	85.8	16.61
	11.0	9.8	105.4	17.43	99.3	16.95	93.3	16.53	90.5	15.89	87.3	15.33	81.1	14.60
	13.0	11.8	98.9	14.96	93.3	14.54	87.6	14.18	85.0	13.63	82.0	13.15	76.2	12.53
15.0	13.7	93.6	13.30	88.3	12.92	82.9	12.61	80.4	12.11	77.5	11.69	72.1	11.13	

# 7. Capacity Tables

Heating Capacity (42HP)

Combination (%)	Outdoor air temp.		Indoor air temp. °C DB											
			16		18		20		21		22		24	
	°C DB	°C WB	TC	PI	TC	PI	TC	PI	TC	PI	TC	PI	TC	PI
70	-24.8	-25	80.6	37.90	80.6	38.11	80.1	38.55	80.1	39.20	80.1	37.33	77.7	35.58
	-21.8	-22	91.9	38.55	91.9	38.76	91.3	39.20	88.2	37.33	85.5	35.58	79.8	33.89
	-19.8	-20	99.3	38.98	97.0	39.20	91.3	37.88	88.2	36.08	85.5	34.41	79.8	32.77
	-18.8	-19	101.5	39.20	97.0	38.52	91.3	37.22	88.2	35.46	85.5	33.83	79.8	32.20
	-16.7	-17	102.8	37.78	97.0	37.09	91.3	35.85	88.2	34.14	85.5	32.61	79.8	31.02
	-13.7	-15	102.8	35.78	97.0	35.06	91.3	33.88	88.2	32.28	85.5	30.86	79.8	29.33
	-11.8	-13	102.8	34.49	97.0	33.77	91.3	32.63	88.2	31.09	85.5	29.75	79.8	28.26
	-9.8	-11	102.8	33.16	97.0	32.41	91.3	31.33	88.2	29.85	85.5	28.59	79.8	27.14
	-9.5	-10	102.8	32.95	97.0	32.20	91.3	31.13	88.2	29.66	85.5	28.42	79.8	26.97
	-8.5	-9.1	102.8	32.29	97.0	31.53	91.3	30.47	88.2	29.04	85.5	27.83	79.8	26.40
	-7.0	-7.6	102.8	31.28	97.0	30.51	91.3	29.49	88.2	28.11	85.5	26.96	79.8	25.56
	-5.0	-5.6	102.8	29.94	97.0	29.16	91.3	28.18	88.2	26.86	85.5	25.79	79.8	24.43
	-3.0	-3.7	102.8	28.60	97.0	27.79	91.3	26.86	88.2	25.61	85.5	24.63	79.8	23.31
	0.0	-0.7	102.8	26.58	97.0	25.76	91.3	24.90	88.2	23.74	85.5	22.88	79.8	21.62
	3.0	2.2	102.8	24.57	97.0	23.73	91.3	22.93	88.2	21.88	85.5	21.13	79.8	19.93
	5.0	4.1	102.8	21.47	95.0	20.22	89.4	19.55	86.4	18.63	83.8	18.03	78.2	16.98
	7.0	6.0	102.8	20.46	92.6	18.70	87.1	18.07	84.1	17.25	81.7	16.73	76.2	15.73
	9.0	7.9	99.1	17.55	89.2	16.03	83.9	15.50	81.1	14.80	78.7	14.35	73.4	13.49
	11.0	9.8	93.8	15.40	84.4	14.07	79.4	13.61	76.7	12.99	74.4	12.60	69.4	11.84
	13.0	11.8	88.0	13.33	79.3	12.19	74.6	11.78	72.0	11.25	69.8	10.90	65.2	10.25
15.0	13.7	83.2	11.71	75.0	10.70	70.5	10.34	68.1	9.87	66.1	9.58	61.7	9.00	
60	-24.8	-25	78.4	37.46	78.4	37.90	77.9	38.55	75.6	36.54	73.0	34.67	68.4	32.91
	-21.8	-22	84.2	38.11	83.4	38.55	78.3	36.54	75.6	34.67	73.0	32.91	68.4	31.21
	-19.8	-20	88.2	38.55	83.4	37.13	78.3	35.21	75.6	33.42	73.0	31.73	68.4	30.07
	-18.8	-19	88.2	37.84	83.4	36.42	78.3	34.54	75.6	32.79	73.0	31.14	68.4	29.50
	-16.7	-17	88.2	36.33	83.4	34.94	78.3	33.14	75.6	31.48	73.0	29.91	68.4	28.31
	-13.7	-15	88.2	34.19	83.4	32.82	78.3	31.15	75.6	29.61	73.0	28.15	68.4	26.61
	-11.8	-13	88.2	32.83	83.4	31.48	78.3	29.87	75.6	28.41	73.0	27.04	68.4	25.54
	-9.8	-11	88.2	31.41	83.4	30.06	78.3	28.54	75.6	27.17	73.0	25.86	68.4	24.40
	-9.5	-10	88.2	31.19	83.4	29.86	78.3	28.34	75.6	26.98	73.0	25.68	68.4	24.23
	-8.5	-9.1	88.2	30.48	83.4	29.15	78.3	27.68	75.6	26.36	73.0	25.09	68.4	23.66
	-7.0	-7.6	88.2	29.41	83.4	28.09	78.3	26.68	75.6	25.42	73.0	24.21	68.4	22.81
	-5.0	-5.6	88.2	27.98	83.4	26.67	78.3	25.34	75.6	24.17	73.0	23.04	68.4	21.68
	-3.0	-3.7	88.2	26.56	83.4	25.25	78.3	24.01	75.6	22.92	73.0	21.86	68.4	20.54
	0.0	-0.7	88.2	24.41	83.4	23.14	78.3	22.01	75.6	21.04	73.0	20.10	68.4	18.84
	3.0	2.2	88.2	22.27	83.4	21.02	78.3	20.01	75.6	19.17	73.0	18.34	68.4	17.13
	5.0	4.1	86.4	18.87	81.8	17.74	76.7	16.88	74.1	16.19	71.6	15.52	67.0	14.47
	7.0	6.0	84.1	17.28	79.7	16.19	74.7	15.43	72.3	14.83	69.8	14.23	65.2	13.23
	9.0	7.9	81.1	14.67	76.7	13.73	72.0	13.10	69.6	12.58	67.2	12.08	62.9	11.22
	11.0	9.8	76.7	12.87	72.6	12.05	68.1	11.49	65.8	11.04	63.5	10.60	59.4	9.85
	13.0	11.8	72.0	11.14	68.2	10.43	64.0	9.94	61.7	9.56	59.6	9.16	55.9	8.53
15.0	13.7	68.1	9.87	64.5	9.24	60.5	8.72	58.5	8.39	56.4	8.05	52.9	7.56	
50	-24.8	-25	73.5	32.67	69.3	33.32	65.2	31.56	63.1	29.91	61.0	28.35	56.8	26.91
	-21.8	-22	73.5	33.32	69.3	31.56	65.2	29.91	63.1	28.35	61.0	26.91	56.8	25.52
	-19.8	-20	73.5	32.09	69.3	30.38	65.2	28.82	63.1	27.31	61.0	25.94	56.8	24.58
	-18.8	-19	73.5	31.47	69.3	29.79	65.2	28.27	63.1	26.81	61.0	25.46	56.8	24.12
	-16.7	-17	73.5	30.19	69.3	28.57	65.2	27.12	63.1	25.72	61.0	24.45	56.8	23.14
	-13.7	-15	73.5	28.35	69.3	26.80	65.2	25.48	63.1	24.16	61.0	23.00	56.8	21.75
	-11.8	-13	73.5	27.19	69.3	25.69	65.2	24.43	63.1	23.17	61.0	22.08	56.8	20.87
	-9.8	-11	73.5	25.96	69.3	24.52	65.2	23.33	63.1	22.13	61.0	21.11	56.8	19.93
	-9.5	-10	73.5	25.78	69.3	24.35	65.2	23.17	63.1	21.98	61.0	20.97	56.8	19.80
	-8.5	-9.1	73.5	25.16	69.3	23.76	65.2	22.62	63.1	21.46	61.0	20.49	56.8	19.33
	-7.0	-7.6	73.5	24.25	69.3	22.88	65.2	21.80	63.1	20.68	61.0	19.77	56.8	18.64
	-5.0	-5.6	73.5	23.02	69.3	21.71	65.2	20.71	63.1	19.65	61.0	18.80	56.8	17.71
	-3.0	-3.7	73.5	21.79	69.3	20.53	65.2	19.60	63.1	18.61	61.0	17.83	56.8	16.78
	0.0	-0.7	73.5	19.96	69.3	18.77	65.2	17.96	63.1	17.05	61.0	16.38	56.8	15.38
	3.0	2.2	73.5	18.12	69.3	17.02	65.2	16.32	63.1	15.49	61.0	14.94	56.8	13.99
	5.0	4.1	72.1	15.29	68.0	14.32	63.9	13.76	61.9	13.07	59.8	12.63	55.7	11.81
	7.0	6.0	70.2	13.95	66.3	13.05	62.2	12.57	60.3	11.94	58.3	11.58	54.3	10.79
	9.0	7.9	67.7	11.95	63.8	11.19	60.0	10.78	58.0	10.25	56.1	9.93	52.3	9.26
	11.0	9.8	64.3	10.61	60.7	9.94	57.0	9.57	54.9	9.09	53.1	8.81	49.5	8.21
	13.0	11.8	60.1	9.08	56.6	8.51	53.3	8.20	51.5	7.83	49.9	7.55	46.4	7.08
15.0	13.7	56.8	8.07	53.6	7.56	50.4	7.28	48.8	6.92	47.2	6.70	43.9	6.25	

**Note**

1. TC: Total Capacity(kW), PI : Power Input(kW, Comp. + Outdoor fan motor)
2. Capacity tables show the average value of conditions which may occur.
3. The heating capacity table is based on the values expressed as Max. in the specification of the outdoor unit. (When measuring the Max. heating capacity, the setting status of the indoor unit is the same as that for measuring the heating capacity of the indoor unit.)

# 7. Capacity Tables

## ◆ ARUM440LTE5

Heating Capacity (44HP)

Combination (%)	Outdoor air temp.		Indoor air temp. °C DB											
			16		18		20		21		22		24	
	°C DB	°C WB	TC	PI	TC	PI	TC	PI	TC	PI	TC	PI	TC	PI
130	-24.8	-25	84.9	46.9	84.9	47.22	84.3	47.46	84.3	47.82	84.3	48.18	82.8	48.73
	-21.8	-22	104.0	47.49	104.0	47.77	103.3	48.01	103.3	48.38	103.3	48.73	101.3	49.28
	-19.8	-20	110.1	47.86	110.1	48.14	109.3	48.38	109.3	48.75	109.3	49.09	107.3	49.65
	-18.8	-19	112.5	48.04	112.5	48.32	111.8	48.56	111.8	48.93	111.8	49.28	109.6	49.83
	-16.7	-17	117.6	48.43	117.6	48.71	116.9	48.95	116.9	49.32	116.9	49.67	114.7	50.22
	-13.7	-15	124.9	48.99	124.9	49.26	124.2	49.50	124.2	49.87	124.2	50.22	121.8	48.40
	-11.8	-13	129.0	49.34	129.0	49.61	128.2	49.85	128.2	50.22	128.2	49.00	126.3	47.24
	-9.8	-11	133.2	49.70	133.2	49.98	132.5	50.22	132.5	48.93	132.5	47.72	131.0	46.03
	-9.5	-10	134.0	49.77	134.0	50.03	133.2	50.02	133.2	48.74	133.1	47.52	131.7	45.84
	-8.5	-9.1	136.6	49.94	136.6	50.22	135.8	49.36	135.8	48.08	135.2	46.88	134.1	45.23
	-7.0	-7.6	140.5	50.22	140.5	49.27	139.6	48.38	139.6	47.11	139.6	45.91	137.6	44.32
	-5.0	-5.6	145.6	49.00	145.6	47.99	144.7	47.07	144.7	45.82	144.7	44.63	142.3	43.11
	-3.0	-3.7	150.8	47.79	150.8	46.72	149.9	45.75	149.9	44.52	149.9	43.34	147.0	41.88
	0.0	-0.7	158.5	45.96	158.5	44.82	157.5	43.78	157.5	42.58	157.5	41.42	154.2	40.06
	3.0	2.2	166.3	44.14	166.3	42.90	165.2	41.81	165.2	40.63	165.2	39.48	155.0	38.24
	5.0	4.1	168.3	38.99	168.0	37.76	166.9	36.70	166.9	35.59	163.2	34.53	151.9	33.42
	7.0	6.0	168.9	37.11	168.6	35.91	167.6	34.88	164.8	33.86	159.0	32.85	148.0	31.87
9.0	7.9	163.6	34.64	163.2	33.52	162.8	32.55	158.7	31.60	153.2	30.66	142.6	29.75	
11.0	9.8	154.7	32.60	154.3	31.55	153.9	30.62	150.1	29.73	144.9	28.85	134.9	27.99	
13.0	11.8	145.3	30.09	145.0	29.12	144.5	28.27	141.0	27.45	136.0	26.63	126.6	25.83	
15.0	13.7	137.5	28.02	137.1	27.11	136.7	26.33	133.4	25.56	128.8	24.80	119.8	24.05	
120	-24.8	-25	84.3	47.22	84.3	47.46	83.7	47.82	83.7	48.18	83.7	48.73	82.2	49.12
	-21.8	-22	103.3	47.77	103.3	48.01	102.6	48.38	102.6	48.73	102.6	49.28	100.7	49.67
	-19.8	-20	109.3	48.14	109.3	48.38	108.6	48.75	108.6	49.09	108.6	49.65	106.5	50.03
	-18.8	-19	111.7	48.32	111.7	48.56	111.0	48.93	111.0	49.28	111.0	49.83	108.9	50.22
	-16.7	-17	116.8	48.71	116.8	48.95	116.0	49.32	116.0	49.67	116.0	50.22	113.8	49.04
	-13.7	-15	124.0	49.26	124.0	49.50	123.3	49.87	123.3	50.22	123.3	48.47	120.9	47.37
	-11.8	-13	128.1	49.61	128.1	49.85	127.3	50.22	127.3	48.99	127.3	47.37	125.4	46.31
	-9.8	-11	132.3	49.98	132.3	50.22	131.5	48.87	131.5	47.69	131.5	46.21	130.1	45.19
	-9.5	-10	133.1	50.03	133.1	50.01	132.3	48.67	132.3	47.49	132.3	46.03	130.8	45.02
	-8.5	-9.1	135.6	50.22	135.6	49.29	134.8	47.99	134.8	46.85	134.8	45.46	133.1	44.46
	-7.0	-7.6	139.5	49.17	139.5	48.22	138.6	46.98	138.6	45.87	138.6	44.59	136.6	43.62
	-5.0	-5.6	144.7	47.76	144.7	46.80	143.7	45.62	143.7	44.57	143.7	43.42	141.4	42.50
	-3.0	-3.7	149.7	46.35	149.7	45.39	148.8	44.27	148.8	43.28	148.8	42.26	145.6	41.38
	0.0	-0.7	157.4	44.25	157.4	43.25	156.4	42.24	156.4	41.33	156.4	40.51	145.6	39.71
	3.0	2.2	165.1	42.14	165.1	41.11	164.1	40.21	161.7	39.39	156.7	38.77	145.6	38.03
	5.0	4.1	167.3	36.96	166.7	35.98	163.9	35.18	158.5	34.43	153.6	33.94	142.7	33.28
	7.0	6.0	168.0	35.00	166.3	34.06	159.8	33.38	154.5	32.74	149.7	32.44	139.0	31.85
9.0	7.9	162.4	32.58	160.2	31.69	153.9	31.07	148.8	30.48	144.2	30.18	133.9	29.64	
11.0	9.8	153.6	30.55	151.5	29.71	145.6	29.13	140.7	28.57	136.4	28.31	126.6	27.80	
13.0	11.8	144.3	28.09	142.3	27.33	136.7	26.79	132.1	26.28	128.1	26.03	119.0	25.57	
15.0	13.7	136.5	26.04	134.7	25.33	129.3	24.84	125.1	24.37	121.2	24.14	112.5	23.71	
110	-24.8	-25	83.9	47.46	83.9	47.82	83.3	48.18	83.3	48.73	83.3	49.12	81.7	49.30
	-21.8	-22	102.7	48.01	102.7	48.38	102.0	48.73	102.0	49.28	102.0	49.67	100.1	49.85
	-19.8	-20	108.7	48.38	108.7	48.75	108.0	49.09	108.0	49.65	108.0	50.03	105.9	50.22
	-18.8	-19	111.1	48.56	111.1	48.93	110.4	49.28	110.4	49.83	110.4	50.22	108.3	49.59
	-16.7	-17	116.2	48.95	116.2	49.32	115.4	49.67	115.4	50.22	115.4	48.95	113.2	48.28
	-13.7	-15	123.3	49.50	123.3	49.87	122.5	50.22	122.5	48.29	122.5	47.12	122.5	46.40
	-11.8	-13	127.3	49.85	127.3	50.22	126.6	48.86	126.6	47.07	126.6	45.96	126.6	45.21
	-9.8	-11	131.6	50.22	131.6	48.69	130.8	47.43	130.8	45.78	130.8	44.75	130.1	43.96
	-9.5	-10	132.3	49.97	132.3	48.45	131.6	47.21	131.6	45.59	131.6	44.57	131.0	43.78
	-8.5	-9.1	134.9	49.15	134.9	47.69	134.1	46.50	134.1	44.94	134.1	43.95	131.0	43.15
	-7.0	-7.6	138.8	47.90	138.8	46.54	137.9	45.42	137.9	43.98	137.9	43.04	131.0	42.22
	-5.0	-5.6	143.8	46.26	143.8	45.00	142.9	44.00	142.9	42.70	140.3	41.83	131.0	40.96
	-3.0	-3.7	148.9	44.61	148.9	43.47	148.0	42.56	145.2	41.40	140.3	40.60	131.0	39.71
	0.0	-0.7	156.5	42.13	156.5	41.17	150.1	40.42	145.2	39.47	140.3	38.78	131.0	37.83
	3.0	2.2	164.1	39.65	160.0	38.87	150.1	38.26	145.2	37.55	140.3	36.95	131.0	35.95
	5.0	4.1	165.9	34.47	156.7	33.81	147.1	33.31	142.3	32.74	137.5	32.24	128.4	31.30
	7.0	6.0	161.7	32.35	152.8	31.87	143.4	31.51	138.7	31.12	134.0	30.73	125.1	29.77
9.0	7.9	155.7	29.95	147.1	29.50	138.1	29.16	133.6	28.81	129.1	28.45	120.5	27.56	
11.0	9.8	147.3	27.91	139.2	27.49	130.6	27.19	126.4	26.86	122.1	26.51	114.0	25.69	
13.0	11.8	138.2	25.51	130.7	25.12	122.7	24.83	118.6	24.53	114.6	24.22	107.0	23.48	
15.0	13.7	130.8	23.46	123.6	23.10	116.1	22.84	112.2	22.57	108.5	22.28	101.3	21.59	

# 7. Capacity Tables

Heating Capacity (44HP)

Combination (%)	Outdoor air temp.		Indoor air temp. °C DB											
			16		18		20		21		22		24	
	°C DB	°C WB	TC	PI	TC	PI	TC	PI	TC	PI	TC	PI	TC	PI
100	-24.8	-25	83.5	52.33	83.5	52.06	83.0	48.29	83.0	51.36	83.0	51.07	81.3	50.93
	-21.8	-22	102.2	51.91	102.2	51.63	101.6	49.81	101.6	50.94	101.6	51.32	99.6	50.51
	-19.8	-20	108.2	51.63	108.2	51.34	107.6	50.75	107.6	50.66	107.6	50.59	105.5	50.22
	-18.8	-19	110.6	51.49	110.0	51.21	110.0	50.94	110.0	50.51	110.0	50.22	107.8	49.45
	-16.7	-17	114.9	51.20	114.9	50.91	114.9	51.32	114.3	50.22	114.3	48.63	112.1	47.83
	-13.7	-15	122.7	50.77	122.7	50.49	122.0	50.22	122.0	47.92	122.0	46.35	119.7	45.50
	-11.8	-13	126.7	50.51	126.0	50.22	126.0	48.69	126.0	46.46	126.0	44.91	119.7	44.03
	-9.8	-11	130.9	50.22	130.9	48.51	130.3	47.07	130.3	44.93	128.5	43.39	119.7	42.48
	-9.5	-10	131.6	49.95	131.6	48.24	131.0	46.83	131.0	44.70	128.5	43.17	119.7	42.25
	-8.5	-9.1	134.2	49.06	134.2	47.39	133.6	46.02	132.9	43.93	128.5	42.41	119.7	41.47
	-7.0	-7.6	140.3	47.72	139.7	46.10	137.3	44.80	132.9	42.78	128.5	41.27	119.7	40.31
	-5.0	-5.6	146.4	45.92	144.9	44.39	137.3	43.19	132.9	41.24	128.5	39.76	119.7	38.77
	-3.0	-3.7	150.6	44.14	146.1	42.67	137.3	41.58	132.9	39.71	128.5	38.24	119.7	37.22
	0.0	-0.7	154.9	41.45	146.1	40.10	137.3	39.15	132.9	37.41	128.5	35.96	119.7	34.90
	3.0	2.2	154.9	38.76	146.1	37.52	137.3	36.73	132.9	35.11	128.5	33.69	119.7	32.58
	5.0	4.1	151.7	33.56	143.2	32.45	134.5	31.78	130.3	30.35	126.0	29.06	117.3	28.02
	7.0	6.0	147.9	31.32	139.5	30.34	131.2	29.80	126.9	28.52	122.7	27.29	114.4	26.24
	9.0	7.9	142.5	28.86	134.4	27.95	126.4	27.47	122.3	26.27	118.3	25.14	110.1	24.17
	11.0	9.8	134.7	26.75	127.1	25.90	119.4	25.46	115.7	24.35	111.8	23.30	104.2	22.41
	13.0	11.8	126.6	24.28	119.4	23.52	112.2	23.11	108.6	22.11	105.0	21.16	97.8	20.34
15.0	13.7	119.7	22.18	112.9	21.48	106.1	21.11	102.7	20.19	99.4	19.31	92.6	18.58	
90	-24.8	-25	83.2	46.62	83.2	47.16	82.6	47.56	82.6	47.73	82.6	48.11	81.1	48.66
	-21.8	-22	101.8	47.16	101.8	47.72	101.2	48.11	101.2	48.29	101.2	48.66	99.2	46.60
	-19.8	-20	107.8	47.54	107.8	48.09	107.1	48.48	107.1	48.66	107.1	47.25	105.1	45.23
	-18.8	-19	110.6	47.72	110.0	48.28	109.5	48.66	109.5	47.94	109.5	46.55	107.4	44.54
	-16.7	-17	114.9	48.11	114.9	48.66	114.5	47.17	114.5	46.42	114.5	45.08	109.4	43.09
	-13.7	-15	122.7	48.66	122.7	46.44	121.6	45.04	121.6	44.26	117.9	42.97	109.4	41.04
	-11.8	-13	126.7	47.14	126.0	45.04	125.5	43.68	121.8	42.88	117.9	41.64	109.4	39.73
	-9.8	-11	130.9	45.56	130.9	43.57	125.6	42.27	121.8	41.43	117.9	40.23	109.4	38.35
	-9.5	-10	131.6	45.31	131.6	43.34	125.6	42.05	121.8	41.21	117.9	40.02	109.4	38.14
	-8.5	-9.1	134.2	44.52	133.2	42.61	125.6	41.34	121.8	40.50	117.9	39.32	109.4	37.46
	-7.0	-7.6	140.3	43.32	133.4	41.50	125.6	40.28	121.8	39.41	117.9	38.26	109.4	36.42
	-5.0	-5.6	141.8	41.72	133.4	40.03	125.6	38.86	121.8	37.97	117.9	36.86	109.4	35.06
	-3.0	-3.7	141.8	40.13	133.4	38.55	125.6	37.43	121.8	36.52	117.9	35.45	109.4	33.68
	0.0	-0.7	141.8	37.74	133.4	36.33	125.6	35.30	121.8	34.35	117.9	33.34	109.4	31.62
	3.0	2.2	141.8	35.35	133.4	34.12	125.6	33.17	121.8	32.19	117.9	31.24	109.4	29.55
	5.0	4.1	139.0	30.56	130.8	29.51	123.1	28.67	119.3	27.76	115.5	26.92	107.2	25.41
	7.0	6.0	135.4	28.62	127.5	27.74	119.9	26.99	116.2	26.08	112.5	25.30	104.6	23.85
	9.0	7.9	130.5	26.37	122.7	25.56	115.5	24.87	112.0	24.02	108.4	23.30	100.7	21.98
	11.0	9.8	123.4	24.21	116.1	23.46	109.2	22.82	105.9	22.05	102.5	21.39	95.2	20.17
	13.0	11.8	115.9	21.52	109.0	20.86	102.6	20.31	99.4	19.61	96.3	19.03	89.4	17.94
15.0	13.7	109.6	19.45	103.1	18.85	97.2	18.35	94.1	17.72	91.1	17.19	84.6	16.21	
80	-24.8	-25	82.8	41.10	82.8	41.66	82.3	42.05	82.3	42.23	82.3	43.15	80.7	41.34
	-21.8	-22	100.7	41.66	100.7	42.21	100.7	42.59	100.7	43.15	100.7	41.34	97.8	39.59
	-19.8	-20	106.7	42.02	106.7	42.58	106.7	43.15	106.7	41.87	105.1	40.12	97.8	38.42
	-18.8	-19	109.1	42.21	109.1	43.15	109.1	42.50	108.9	41.23	105.1	39.52	97.8	37.85
	-16.7	-17	112.4	43.15	112.4	41.80	112.4	41.14	109.0	39.89	105.1	38.26	97.8	36.63
	-13.7	-15	117.5	41.16	115.2	39.87	112.4	39.20	109.0	37.97	105.1	36.44	97.8	34.88
	-11.8	-13	120.4	39.89	116.9	38.65	112.4	37.97	109.0	36.76	105.1	35.29	97.8	33.77
	-9.8	-11	123.6	38.56	118.5	37.38	112.4	36.68	109.0	35.48	105.1	34.08	97.8	32.61
	-9.5	-10	124.5	38.36	119.2	37.18	112.4	36.48	109.0	35.29	105.1	33.90	97.8	32.44
	-8.5	-9.1	125.7	37.70	119.7	36.54	112.4	35.84	109.0	34.64	105.1	33.30	97.8	31.86
	-7.0	-7.6	127.0	36.70	119.7	35.57	112.4	34.87	109.0	33.69	105.1	32.39	97.8	30.98
	-5.0	-5.6	127.0	35.37	119.7	34.30	112.4	33.57	109.0	32.41	105.1	31.17	97.8	29.82
	-3.0	-3.7	127.0	34.04	119.7	33.01	112.4	32.28	109.0	31.13	105.1	29.97	97.8	28.65
	0.0	-0.7	127.0	32.04	119.7	31.09	112.4	30.34	109.0	29.22	105.1	28.15	97.8	26.91
	3.0	2.2	127.0	30.05	119.7	29.16	112.4	28.39	109.0	27.29	105.1	26.34	97.8	25.17
	5.0	4.1	124.4	25.96	117.3	25.18	110.1	24.48	106.8	23.48	102.9	22.67	95.9	21.65
	7.0	6.0	121.2	24.37	114.3	23.67	107.3	22.97	104.1	22.02	100.3	21.29	93.3	20.33
	9.0	7.9	116.8	21.87	110.1	21.25	103.3	20.72	100.3	19.92	96.7	19.21	90.0	18.30
	11.0	9.8	110.5	19.44	104.1	18.90	97.8	18.43	94.8	17.71	91.4	17.09	85.0	16.27
	13.0	11.8	103.7	16.91	97.8	16.43	91.8	16.02	89.1	15.40	85.9	14.85	79.9	14.15
15.0	13.7	98.1	15.27	92.6	14.83	86.9	14.47	84.3	13.90	81.3	13.41	75.6	12.77	

## 7. Capacity Tables

## Heating Capacity (44HP)

Combination (%)	Outdoor air temp.		Indoor air temp. °C DB											
			16		18		20		21		22		24	
	°C DB	°C WB	TC	PI	TC	PI	TC	PI	TC	PI	TC	PI	TC	PI
70	-24.8	-25	82.8	41.03	82.8	41.22	82.3	41.59	82.3	42.14	82.3	40.16	80.7	38.30
	-21.8	-22	96.3	41.59	96.3	41.77	95.7	42.14	92.4	40.16	89.6	38.30	83.7	36.51
	-19.8	-20	105.3	41.96	101.7	42.14	95.7	40.75	92.4	38.84	89.6	37.07	83.7	35.31
	-18.8	-19	107.7	42.14	101.7	41.43	95.7	40.05	92.4	38.17	89.6	36.44	83.7	34.71
	-16.7	-17	107.7	40.65	101.7	39.91	95.7	38.60	92.4	36.78	89.6	35.15	83.7	33.45
	-13.7	-15	107.7	38.53	101.7	37.76	95.7	36.51	92.4	34.81	89.6	33.29	83.7	31.65
	-11.8	-13	107.7	37.17	101.7	36.40	95.7	35.19	92.4	33.54	89.6	32.11	83.7	30.52
	-9.8	-11	107.7	35.76	101.7	34.95	95.7	33.80	92.4	32.22	89.6	30.88	83.7	29.32
	-9.5	-10	107.7	35.54	101.7	34.74	95.7	33.59	92.4	32.02	89.6	30.70	83.7	29.14
	-8.5	-9.1	107.7	34.84	101.7	34.02	95.7	32.90	92.4	31.36	89.6	30.07	83.7	28.54
	-7.0	-7.6	107.7	33.77	101.7	32.95	95.7	31.86	92.4	30.38	89.6	29.14	83.7	27.64
	-5.0	-5.6	107.7	32.36	101.7	31.51	95.7	30.46	92.4	29.05	89.6	27.91	83.7	26.45
	-3.0	-3.7	107.7	30.94	101.7	30.07	95.7	29.07	92.4	27.73	89.6	26.67	83.7	25.25
	0.0	-0.7	107.7	28.81	101.7	27.92	95.7	26.99	92.4	25.75	89.6	24.81	83.7	23.46
	3.0	2.2	107.7	26.68	101.7	25.77	95.7	24.90	92.4	23.77	89.6	22.96	83.7	21.65
	5.0	4.1	107.7	23.35	99.6	21.99	93.7	21.25	90.5	20.26	87.8	19.62	82.0	18.48
	7.0	6.0	107.8	22.29	97.1	20.38	91.3	19.69	88.2	18.80	85.6	18.23	79.9	17.14
	9.0	7.9	103.9	19.31	93.5	17.64	88.0	17.05	85.0	16.28	82.4	15.79	76.9	14.84
	11.0	9.8	98.3	17.14	88.5	15.66	83.2	15.14	80.4	14.45	78.0	14.02	72.8	13.18
	13.0	11.8	92.2	15.04	83.1	13.75	78.2	13.29	75.4	12.68	73.2	12.30	68.4	11.56
15.0	13.7	87.2	13.41	78.6	12.26	73.9	11.85	71.4	11.31	69.3	10.97	64.7	10.32	
60	-24.8	-25	82.2	40.59	82.2	40.96	81.6	41.52	79.3	39.38	76.5	37.38	71.7	35.50
	-21.8	-22	88.3	41.15	87.4	41.52	82.0	39.38	79.3	37.38	76.5	35.50	71.7	33.68
	-19.8	-20	92.4	41.52	87.4	40.01	82.0	37.96	79.3	36.05	76.5	34.24	71.7	32.46
	-18.8	-19	92.4	40.76	87.4	39.26	82.0	37.25	79.3	35.38	76.5	33.61	71.7	31.85
	-16.7	-17	92.4	39.16	87.4	37.67	82.0	35.75	79.3	33.97	76.5	32.30	71.7	30.58
	-13.7	-15	92.4	36.88	87.4	35.42	82.0	33.62	79.3	31.98	76.5	30.41	71.7	28.76
	-11.8	-13	92.4	35.44	87.4	33.98	82.0	32.26	79.3	30.70	76.5	29.22	71.7	27.61
	-9.8	-11	92.4	33.92	87.4	32.47	82.0	30.84	79.3	29.37	76.5	27.97	71.7	26.39
	-9.5	-10	92.4	33.69	87.4	32.25	82.0	30.63	79.3	29.17	76.5	27.77	71.7	26.21
	-8.5	-9.1	92.4	32.93	87.4	31.50	82.0	29.92	79.3	28.51	76.5	27.15	71.7	25.60
	-7.0	-7.6	92.4	31.80	87.4	30.37	82.0	28.86	79.3	27.50	76.5	26.21	71.7	24.69
	-5.0	-5.6	92.4	30.27	87.4	28.86	82.0	27.43	79.3	26.17	76.5	24.95	71.7	23.48
	-3.0	-3.7	92.4	28.76	87.4	27.35	82.0	26.01	79.3	24.84	76.5	23.69	71.7	22.26
	0.0	-0.7	92.4	26.47	87.4	25.09	82.0	23.88	79.3	22.83	76.5	21.81	71.7	20.45
	3.0	2.2	92.4	24.19	87.4	22.83	82.0	21.74	79.3	20.83	76.5	19.93	71.7	18.62
	5.0	4.1	90.5	20.52	85.7	19.29	80.4	18.36	77.6	17.62	75.0	16.88	70.2	15.74
	7.0	6.0	88.2	18.83	83.5	17.64	78.3	16.82	75.7	16.16	73.1	15.50	68.4	14.41
	9.0	7.9	85.0	16.14	80.4	15.11	75.4	14.41	73.0	13.84	70.4	13.29	65.9	12.35
	11.0	9.8	80.4	14.32	76.1	13.41	71.3	12.79	68.9	12.29	66.6	11.79	62.3	10.96
	13.0	11.8	75.4	12.56	71.5	11.76	67.0	11.21	64.7	10.78	62.5	10.33	58.5	9.62
15.0	13.7	71.4	11.31	67.6	10.59	63.4	10.00	61.3	9.62	59.1	9.22	55.4	8.66	
50	-24.8	-25	77.1	35.27	72.7	35.82	68.4	33.95	66.2	32.20	63.9	30.54	59.5	29.00
	-21.8	-22	77.1	35.82	72.7	33.95	68.4	32.20	66.2	30.54	63.9	29.00	59.5	27.51
	-19.8	-20	77.1	34.52	72.7	32.70	68.4	31.03	66.2	29.43	63.9	27.96	59.5	26.51
	-18.8	-19	77.1	33.86	72.7	32.07	68.4	30.45	66.2	28.89	63.9	27.45	59.5	26.02
	-16.7	-17	77.1	32.50	72.7	30.77	68.4	29.23	66.2	27.72	63.9	26.37	59.5	24.98
	-13.7	-15	77.1	30.55	72.7	28.89	68.4	27.47	66.2	26.06	63.9	24.83	59.5	23.49
	-11.8	-13	77.1	29.31	72.7	27.71	68.4	26.37	66.2	25.01	63.9	23.85	59.5	22.55
	-9.8	-11	77.1	28.01	72.7	26.46	68.4	25.19	66.2	23.90	63.9	22.81	59.5	21.55
	-9.5	-10	77.1	27.81	72.7	26.28	68.4	25.02	66.2	23.74	63.9	22.67	59.5	21.40
	-8.5	-9.1	77.1	27.16	72.7	25.65	68.4	24.44	66.2	23.19	63.9	22.15	59.5	20.90
	-7.0	-7.6	77.1	26.18	72.7	24.72	68.4	23.56	66.2	22.36	63.9	21.38	59.5	20.17
	-5.0	-5.6	77.1	24.88	72.7	23.47	68.4	22.40	66.2	21.26	63.9	20.35	59.5	19.17
	-3.0	-3.7	77.1	23.58	72.7	22.22	68.4	21.22	66.2	20.15	63.9	19.31	59.5	18.18
	0.0	-0.7	77.1	21.63	72.7	20.34	68.4	19.47	66.2	18.49	63.9	17.77	59.5	16.69
	3.0	2.2	77.1	19.67	72.7	18.48	68.4	17.73	66.2	16.83	63.9	16.23	59.5	15.20
	5.0	4.1	75.6	16.62	71.3	15.58	66.9	14.97	64.8	14.22	62.7	13.74	58.4	12.85
	7.0	6.0	73.6	15.19	69.5	14.22	65.2	13.70	63.2	13.01	61.1	12.61	56.9	11.76
	9.0	7.9	70.9	13.15	66.9	12.31	62.8	11.86	60.8	11.27	58.8	10.92	54.9	10.19
	11.0	9.8	67.4	11.81	63.6	11.06	59.7	10.65	57.5	10.12	55.6	9.80	51.9	9.14
	13.0	11.8	63.0	10.24	59.4	9.60	55.8	9.24	54.0	8.83	52.3	8.51	48.6	7.98
15.0	13.7	59.5	9.25	56.2	8.66	52.8	8.34	51.2	7.93	49.5	7.68	46.0	7.16	

## Note

1. TC: Total Capacity(kW), PI: Power Input(kW, Comp. + Outdoor fan motor)
2. Capacity tables show the average value of conditions which may occur.
3. The heating capacity table is based on the values expressed as Max. in the specification of the outdoor unit. (When measuring the Max. heating capacity, the setting status of the indoor unit is the same as that for measuring the heating capacity of the indoor unit.)

# 7. Capacity Tables

## ◆ ARUM460LTE5

Heating Capacity (46HP)

Combination (%)	Outdoor air temp.		Indoor air temp. °C DB											
			16		18		20		21		22		24	
	°C DB	°C WB	TC	PI	TC	PI	TC	PI	TC	PI	TC	PI	TC	PI
130	-24.8	-25	88.8	49.9	88.8	50.19	88.3	50.44	88.3	50.82	88.3	51.19	86.6	51.77
	-21.8	-22	108.8	50.47	108.8	50.76	108.1	51.01	108.1	51.40	108.1	51.77	106.0	52.34
	-19.8	-20	115.1	50.86	115.1	51.15	114.3	51.40	114.3	51.78	114.3	52.15	112.2	52.73
	-18.8	-19	117.7	51.05	117.7	51.34	116.9	51.59	116.9	51.98	116.9	52.34	114.7	52.92
	-16.7	-17	123.0	51.45	123.0	51.74	122.2	51.99	122.2	52.38	122.2	52.75	119.9	53.32
	-13.7	-15	130.6	52.03	130.6	52.32	129.8	52.57	129.8	52.96	129.8	53.32	127.3	51.39
	-11.8	-13	134.9	52.41	134.9	52.69	134.1	52.94	134.1	53.32	134.1	53.32	132.1	50.16
	-9.8	-11	139.4	52.78	139.4	53.07	138.5	53.32	138.5	53.69	138.5	54.06	137.0	48.87
	-9.5	-10	140.2	52.85	140.2	53.13	139.3	53.11	139.3	53.48	139.2	53.83	137.8	48.67
	-8.5	-9.1	142.9	53.03	142.9	53.32	142.0	53.42	142.0	53.77	141.5	53.92	140.2	48.03
	-7.0	-7.6	146.9	53.32	146.9	53.32	146.0	53.37	146.0	53.72	146.0	54.07	143.9	47.06
	-5.0	-5.6	152.3	52.03	152.3	50.96	151.3	49.98	151.3	48.65	151.3	47.38	148.9	45.77
	-3.0	-3.7	157.7	50.75	157.7	49.61	156.7	48.58	156.7	47.27	156.7	46.02	153.8	44.47
	0.0	-0.7	165.8	48.80	165.8	47.59	164.7	46.49	164.7	45.21	164.7	43.97	161.3	42.54
	3.0	2.2	173.9	46.87	173.9	45.55	172.8	44.39	172.8	43.15	172.8	41.92	162.1	40.61
	5.0	4.1	176.0	41.40	175.7	40.10	174.5	38.97	174.5	37.80	174.5	36.66	158.9	35.48
	7.0	6.0	176.7	39.40	176.3	38.13	175.3	37.03	172.4	35.95	166.3	34.88	154.8	33.84
9.0	7.9	171.1	36.79	170.7	35.60	170.2	34.56	166.0	33.56	160.2	32.56	149.2	31.58	
11.0	9.8	161.8	34.61	161.4	33.49	161.0	32.52	157.0	31.57	151.5	30.64	141.1	29.71	
13.0	11.8	151.9	31.95	151.7	30.92	151.2	30.02	147.4	29.15	142.3	28.28	132.4	27.43	
15.0	13.7	143.8	29.75	143.4	28.79	143.0	27.95	139.5	27.14	134.7	26.33	125.3	25.54	
120	-24.8	-25	88.2	50.19	88.2	50.44	87.7	50.82	87.7	51.19	87.7	51.77	86.0	52.17
	-21.8	-22	108.0	50.76	108.0	51.01	107.3	51.40	107.3	51.77	107.3	52.34	105.3	52.75
	-19.8	-20	114.3	51.15	114.3	51.40	113.5	51.78	113.5	52.15	113.5	52.73	111.4	53.13
	-18.8	-19	116.8	51.34	116.8	51.59	116.0	51.98	116.0	52.34	116.0	52.92	113.9	53.32
	-16.7	-17	122.1	51.74	122.1	51.99	121.3	52.38	121.3	52.75	121.3	53.32	119.0	52.08
	-13.7	-15	129.7	52.32	129.7	52.57	128.9	52.96	128.9	53.32	128.9	53.69	126.4	50.30
	-11.8	-13	133.9	52.69	133.9	52.94	133.1	53.32	133.1	53.69	133.1	54.06	131.1	49.17
	-9.8	-11	138.4	53.07	138.4	53.32	137.6	53.69	137.6	54.06	137.6	54.41	136.1	47.98
	-9.5	-10	139.2	53.13	139.2	53.10	138.4	51.68	138.4	50.43	138.4	48.88	136.8	47.80
	-8.5	-9.1	141.9	53.32	141.9	53.32	140.9	50.96	140.9	49.75	140.9	48.27	139.2	47.21
	-7.0	-7.6	145.9	52.21	145.9	51.21	145.0	49.88	145.0	48.71	145.0	47.34	142.9	46.32
	-5.0	-5.6	151.3	50.71	151.3	49.69	150.3	48.44	150.3	47.33	150.3	46.10	147.8	45.13
	-3.0	-3.7	156.6	49.22	156.6	48.19	155.6	47.01	155.6	45.96	155.6	44.87	152.3	43.94
	0.0	-0.7	164.6	46.98	164.6	45.92	163.5	44.85	163.5	43.89	163.5	43.01	152.3	42.16
	3.0	2.2	172.6	44.75	172.6	43.65	171.6	42.69	169.1	41.82	163.9	41.16	152.3	40.38
	5.0	4.1	174.9	39.25	174.4	38.21	171.5	37.35	165.8	36.56	160.6	36.03	149.2	35.33
	7.0	6.0	175.6	37.17	174.0	36.16	167.2	35.45	161.6	34.77	156.5	34.44	145.4	33.82
9.0	7.9	169.9	34.59	167.6	33.65	161.0	32.99	155.6	32.36	150.8	32.05	140.1	31.48	
11.0	9.8	160.6	32.44	158.5	31.55	152.3	30.93	147.1	30.34	142.6	30.05	132.4	29.52	
13.0	11.8	150.9	29.83	148.8	29.02	143.0	28.45	138.2	27.90	133.9	27.64	124.4	27.15	
15.0	13.7	142.8	27.65	140.9	26.90	135.3	26.37	130.8	25.87	126.7	25.63	117.7	25.17	
110	-24.8	-25	87.8	50.44	87.8	50.82	87.2	51.19	87.2	51.77	87.2	52.17	85.5	52.37
	-21.8	-22	107.4	51.01	107.4	51.40	106.7	51.77	106.7	52.34	106.7	52.75	104.7	52.94
	-19.8	-20	113.7	51.40	113.7	51.78	113.0	52.15	113.0	52.73	113.0	53.13	110.8	53.32
	-18.8	-19	116.2	51.59	116.2	51.98	115.4	52.34	115.4	52.92	115.4	53.32	113.3	52.66
	-16.7	-17	121.5	51.99	121.5	52.38	120.7	52.75	120.7	53.32	120.7	53.69	118.4	51.26
	-13.7	-15	128.9	52.57	128.9	52.96	128.2	53.32	128.2	53.69	128.2	54.06	126.4	49.27
	-11.8	-13	133.2	52.94	133.2	53.32	132.4	53.69	132.4	54.06	132.4	54.41	130.4	48.01
	-9.8	-11	137.6	53.32	137.6	53.69	136.8	54.06	136.8	54.41	136.8	54.76	134.8	46.68
	-9.5	-10	138.4	53.06	138.4	51.45	137.6	50.13	137.6	48.40	137.6	47.32	137.0	46.49
	-8.5	-9.1	141.1	52.19	141.1	50.64	140.3	49.37	140.3	47.72	140.3	46.67	137.0	45.82
	-7.0	-7.6	145.1	50.87	145.1	49.42	144.2	48.23	144.2	46.70	144.2	45.70	137.0	44.83
	-5.0	-5.6	150.4	49.12	150.4	47.78	149.4	46.72	149.4	45.34	146.7	44.41	137.0	43.49
	-3.0	-3.7	155.8	47.36	155.8	46.16	154.8	45.19	151.9	43.96	146.7	43.11	137.0	42.16
	0.0	-0.7	163.7	44.73	163.7	43.71	157.0	42.91	151.9	41.91	146.7	41.18	137.0	40.17
	3.0	2.2	171.7	42.10	167.3	41.27	157.0	40.63	151.9	39.87	146.7	39.23	137.0	38.17
	5.0	4.1	173.5	36.60	163.9	35.90	153.9	35.37	148.8	34.76	143.8	34.23	134.3	33.23
	7.0	6.0	169.1	34.35	159.8	33.84	150.0	33.46	145.1	33.04	140.1	32.63	130.9	31.61
9.0	7.9	162.9	31.80	153.9	31.32	144.4	30.97	139.7	30.59	135.1	30.20	126.0	29.26	
11.0	9.8	154.0	29.64	145.5	29.19	136.6	28.87	132.2	28.52	127.7	28.15	119.2	27.28	
13.0	11.8	144.6	27.08	136.7	26.67	128.3	26.37	124.1	26.05	119.9	25.72	111.9	24.93	
15.0	13.7	136.8	24.91	129.3	24.53	121.4	24.25	117.4	23.96	113.4	23.66	105.9	22.92	

# 7. Capacity Tables

Heating Capacity (46HP)

Combination (%)	Outdoor air temp.		Indoor air temp. °C DB											
			16		18		20		21		22		24	
	°C DB	°C WB	TC	PI	TC	PI	TC	PI	TC	PI	TC	PI	TC	PI
100	-24.8	-25	87.4	55.60	87.4	55.30	86.8	51.29	86.8	54.56	86.8	54.24	85.1	54.09
	-21.8	-22	106.9	55.15	106.9	54.85	106.3	52.91	106.3	54.10	106.3	54.50	104.2	53.63
	-19.8	-20	113.2	54.85	113.2	54.54	112.5	53.91	112.5	53.80	112.5	53.72	110.4	53.32
	-18.8	-19	115.6	54.70	115.0	54.39	115.0	54.10	115.0	53.64	115.0	53.32	112.7	52.51
	-16.7	-17	120.2	54.38	120.2	54.07	120.2	54.50	119.5	53.32	119.5	51.64	117.2	50.78
	-13.7	-15	128.3	53.92	128.3	53.61	127.6	53.32	127.6	50.88	127.6	49.22	125.2	48.31
	-11.8	-13	132.5	53.63	131.8	53.32	131.8	51.70	131.8	49.33	131.8	47.69	125.2	46.76
	-9.8	-11	136.9	53.32	136.9	51.50	136.2	49.98	136.2	47.70	134.4	46.08	125.2	45.11
	-9.5	-10	137.6	53.04	137.6	51.23	137.0	49.72	137.0	47.46	134.4	45.83	125.2	44.86
	-8.5	-9.1	140.3	52.09	140.3	50.32	139.7	48.86	139.0	46.65	134.4	45.03	125.2	44.04
	-7.0	-7.6	146.7	50.67	146.1	48.95	143.6	47.57	139.0	45.43	134.4	43.82	125.2	42.81
	-5.0	-5.6	153.1	48.76	151.6	47.13	143.6	45.86	139.0	43.79	134.4	42.22	125.2	41.16
	-3.0	-3.7	157.5	46.87	152.8	45.30	143.6	44.15	139.0	42.16	134.4	40.61	125.2	39.52
	0.0	-0.7	162.0	44.01	152.8	42.57	143.6	41.57	139.0	39.72	134.4	38.19	125.2	37.06
	3.0	2.2	162.0	41.16	152.8	39.84	143.6	39.00	139.0	37.28	134.4	35.77	125.2	34.59
	5.0	4.1	158.7	35.64	149.8	34.46	140.7	33.74	136.2	32.23	131.8	30.85	122.7	29.76
	7.0	6.0	154.7	33.25	145.9	32.21	137.2	31.65	132.8	30.28	128.3	28.97	119.6	27.86
	9.0	7.9	149.0	30.64	140.5	29.68	132.2	29.16	127.9	27.90	123.7	26.69	115.2	25.67
	11.0	9.8	140.9	28.41	132.9	27.51	124.9	27.03	121.0	25.86	116.9	24.74	109.0	23.80
	13.0	11.8	132.4	25.78	124.8	24.97	117.3	24.54	113.6	23.48	109.8	22.47	102.3	21.60
15.0	13.7	125.2	23.55	118.1	22.81	111.0	22.41	107.5	21.43	103.9	20.51	96.8	19.73	
90	-24.8	-25	87.0	49.54	87.0	50.11	86.5	50.52	86.5	50.71	86.5	51.09	84.9	51.68
	-21.8	-22	106.5	50.11	106.5	50.69	105.9	51.09	105.9	51.29	105.9	51.68	103.8	49.49
	-19.8	-20	112.7	50.50	112.7	51.08	112.0	51.48	112.0	51.68	112.0	51.18	109.9	48.03
	-18.8	-19	115.6	50.69	115.0	51.27	114.5	51.68	114.5	50.91	114.5	49.43	112.3	47.30
	-16.7	-17	120.2	51.09	120.2	51.68	119.7	50.09	119.7	49.30	119.7	47.87	114.4	45.76
	-13.7	-15	128.3	51.68	128.3	49.32	127.1	47.83	127.1	47.00	123.3	45.63	114.4	43.58
	-11.8	-13	132.5	50.06	131.8	47.83	131.3	46.39	127.3	45.53	123.3	44.22	114.4	42.19
	-9.8	-11	136.9	48.38	136.9	46.27	131.4	44.88	127.3	44.00	123.3	42.72	114.4	40.73
	-9.5	-10	137.6	48.12	137.6	46.03	131.4	44.66	127.3	43.77	123.3	42.49	114.4	40.50
	-8.5	-9.1	140.3	47.27	139.4	45.24	131.4	43.90	127.3	43.00	123.3	41.75	114.4	39.78
	-7.0	-7.6	146.7	46.00	139.6	44.07	131.4	42.77	127.3	41.85	123.3	40.63	114.4	38.68
	-5.0	-5.6	148.3	44.31	139.6	42.50	131.4	41.26	127.3	40.32	123.3	39.14	114.4	37.23
	-3.0	-3.7	148.3	42.61	139.6	40.94	131.4	39.75	127.3	38.78	123.3	37.64	114.4	35.76
	0.0	-0.7	148.3	40.08	139.6	38.58	131.4	37.48	127.3	36.48	123.3	35.40	114.4	33.58
	3.0	2.2	148.3	37.53	139.6	36.23	131.4	35.22	127.3	34.18	123.3	33.17	114.4	31.38
	5.0	4.1	145.3	32.45	136.8	31.33	128.7	30.44	124.8	29.48	120.8	28.59	112.1	26.98
	7.0	6.0	141.7	30.39	133.3	29.45	125.5	28.66	121.6	27.69	117.7	26.86	109.3	25.33
	9.0	7.9	136.5	28.00	128.4	27.14	120.8	26.41	117.1	25.50	113.4	24.74	105.3	23.34
	11.0	9.8	129.1	25.70	121.4	24.91	114.3	24.23	110.7	23.41	107.2	22.72	99.6	21.42
	13.0	11.8	121.2	22.85	114.0	22.15	107.3	21.56	104.0	20.82	100.7	20.20	93.5	19.05
15.0	13.7	114.6	20.66	107.9	20.02	101.6	19.48	98.4	18.82	95.3	18.26	88.5	17.22	
80	-24.8	-25	86.7	43.68	86.7	44.27	86.1	44.67	86.1	44.86	86.1	45.82	84.5	43.90
	-21.8	-22	105.4	44.27	105.4	44.84	105.4	45.24	105.4	45.82	105.4	43.90	102.2	42.04
	-19.8	-20	111.6	44.64	111.6	45.22	111.6	45.82	111.6	44.47	109.9	42.61	102.2	40.80
	-18.8	-19	114.0	44.84	114.0	45.82	114.0	45.13	113.9	43.78	109.9	41.96	102.2	40.19
	-16.7	-17	117.5	45.82	117.5	44.39	117.5	43.69	114.0	42.36	109.9	40.62	102.2	38.90
	-13.7	-15	122.9	43.70	120.4	42.34	117.5	41.63	114.0	40.32	109.9	38.69	102.2	37.04
	-11.8	-13	125.9	42.36	122.2	41.05	117.5	40.32	114.0	39.03	109.9	37.47	102.2	35.86
	-9.8	-11	129.3	40.95	124.0	39.69	117.5	38.95	114.0	37.68	109.9	36.18	102.2	34.63
	-9.5	-10	130.2	40.74	124.7	39.48	117.5	38.74	114.0	37.47	109.9	35.99	102.2	34.45
	-8.5	-9.1	131.5	40.03	125.2	38.80	117.5	38.06	114.0	36.79	109.9	35.36	102.2	33.83
	-7.0	-7.6	132.8	38.97	125.2	37.77	117.5	37.03	114.0	35.78	109.9	34.39	102.2	32.90
	-5.0	-5.6	132.8	37.56	125.2	36.42	117.5	35.65	114.0	34.41	109.9	33.10	102.2	31.66
	-3.0	-3.7	132.8	36.15	125.2	35.05	117.5	34.27	114.0	33.06	109.9	31.83	102.2	30.43
	0.0	-0.7	132.8	34.02	125.2	33.01	117.5	32.22	114.0	31.02	109.9	29.89	102.2	28.58
	3.0	2.2	132.8	31.91	125.2	30.96	117.5	30.15	114.0	28.98	109.9	27.97	102.2	26.72
	5.0	4.1	130.1	27.57	122.7	26.73	115.2	25.99	111.7	24.94	107.7	24.07	100.3	22.99
	7.0	6.0	126.8	25.88	119.6	25.13	112.3	24.39	108.8	23.38	104.9	22.60	97.6	21.58
	9.0	7.9	122.2	23.22	115.2	22.57	108.1	22.01	104.9	21.15	101.1	20.40	94.1	19.43
	11.0	9.8	115.6	20.65	108.9	20.07	102.2	19.57	99.2	18.81	95.6	18.14	88.9	17.28
	13.0	11.8	108.5	17.95	102.3	17.44	96.0	17.01	93.2	16.35	89.8	15.76	83.5	15.02
15.0	13.7	102.6	16.21	96.8	15.75	90.8	15.36	88.1	14.76	85.0	14.24	79.0	13.56	

# 7. Capacity Tables

Heating Capacity (46HP)

Combination (%)	Outdoor air temp.		Indoor air temp. °C DB													
			16		18		20		21		22		24			
	°C DB	°C WB	TC	PI	TC	PI	TC	PI	TC	PI	TC	PI	TC	PI		
70	-24.8	-25	86.7	43.59	86.7	43.78	86.1	44.17	86.1	44.75	86.1	44.75	86.1	42.65	84.5	40.67
	-21.8	-22	100.7	44.17	100.7	44.37	100.1	44.75	96.6	42.65	93.8	40.67	87.5	38.77		
	-19.8	-20	110.0	44.56	106.3	44.75	100.1	43.27	96.6	41.24	93.8	39.36	87.5	37.50		
	-18.8	-19	112.7	44.75	106.3	43.99	100.1	42.53	96.6	40.54	93.8	38.70	87.5	36.86		
	-16.7	-17	112.7	43.16	106.3	42.38	100.1	40.99	96.6	39.06	93.8	37.33	87.5	35.52		
	-13.7	-15	112.7	40.91	106.3	40.10	100.1	38.77	96.6	36.96	93.8	35.35	87.5	33.61		
	-11.8	-13	112.7	39.47	106.3	38.65	100.1	37.37	96.6	35.62	93.8	34.10	87.5	32.41		
	-9.8	-11	112.7	37.97	106.3	37.12	100.1	35.90	96.6	34.22	93.8	32.79	87.5	31.14		
	-9.5	-10	112.7	37.74	106.3	36.89	100.1	35.67	96.6	34.01	93.8	32.60	87.5	30.95		
	-8.5	-9.1	112.7	37.00	106.3	36.13	100.1	34.93	96.6	33.30	93.8	31.93	87.5	30.31		
	-7.0	-7.6	112.7	35.86	106.3	34.99	100.1	33.83	96.6	32.26	93.8	30.95	87.5	29.35		
	-5.0	-5.6	112.7	34.36	106.3	33.46	100.1	32.35	96.6	30.85	93.8	29.64	87.5	28.08		
	-3.0	-3.7	112.7	32.85	106.3	31.93	100.1	30.87	96.6	29.45	93.8	28.32	87.5	26.81		
	0.0	-0.7	112.7	30.59	106.3	29.65	100.1	28.66	96.6	27.34	93.8	26.35	87.5	24.91		
	3.0	2.2	112.7	28.33	106.3	27.36	100.1	26.44	96.6	25.24	93.8	24.38	87.5	22.99		
	5.0	4.1	112.7	24.79	104.2	23.35	98.0	22.57	94.7	21.52	91.8	20.83	85.8	19.62		
	7.0	6.0	112.7	23.66	101.5	21.64	95.5	20.90	92.2	19.96	89.5	19.35	83.5	18.20		
	9.0	7.9	108.6	20.50	97.8	18.73	92.0	18.10	88.9	17.29	86.2	16.76	80.4	15.76		
	11.0	9.8	102.8	18.19	92.5	16.63	87.0	16.08	84.1	15.34	81.6	14.88	76.1	13.99		
	13.0	11.8	96.5	15.96	86.9	14.60	81.7	14.11	78.9	13.47	76.6	13.06	71.5	12.28		
15.0	13.7	91.3	14.24	82.2	13.02	77.3	12.58	74.6	12.01	72.5	11.65	67.6	10.95			
60	-24.8	-25	85.9	43.13	85.9	43.52	85.4	44.10	82.9	41.83	80.0	39.71	74.9	37.70		
	-21.8	-22	92.3	43.71	91.4	44.10	85.8	41.83	82.9	39.71	80.0	37.70	74.9	35.77		
	-19.8	-20	96.6	44.10	91.4	42.50	85.8	40.32	82.9	38.29	80.0	36.37	74.9	34.48		
	-18.8	-19	96.6	43.30	91.4	41.70	85.8	39.56	82.9	37.57	80.0	35.70	74.9	33.83		
	-16.7	-17	96.6	41.60	91.4	40.01	85.8	37.97	82.9	36.08	80.0	34.30	74.9	32.48		
	-13.7	-15	96.6	39.17	91.4	37.62	85.8	35.71	82.9	33.96	80.0	32.30	74.9	30.55		
	-11.8	-13	96.6	37.64	91.4	36.09	85.8	34.27	82.9	32.61	80.0	31.04	74.9	29.32		
	-9.8	-11	96.6	36.03	91.4	34.49	85.8	32.76	82.9	31.19	80.0	29.70	74.9	28.03		
	-9.5	-10	96.6	35.78	91.4	34.26	85.8	32.53	82.9	30.98	80.0	29.50	74.9	27.84		
	-8.5	-9.1	96.6	34.98	91.4	33.45	85.8	31.78	82.9	30.27	80.0	28.83	74.9	27.19		
	-7.0	-7.6	96.6	33.77	91.4	32.25	85.8	30.65	82.9	29.21	80.0	27.83	74.9	26.22		
	-5.0	-5.6	96.6	32.15	91.4	30.65	85.8	29.13	82.9	27.79	80.0	26.50	74.9	24.94		
	-3.0	-3.7	96.6	30.54	91.4	29.04	85.8	27.62	82.9	26.38	80.0	25.16	74.9	23.64		
	0.0	-0.7	96.6	28.11	91.4	26.65	85.8	25.36	82.9	24.24	80.0	23.16	74.9	21.71		
	3.0	2.2	96.6	25.69	91.4	24.24	85.8	23.09	82.9	22.12	80.0	21.17	74.9	19.77		
	5.0	4.1	94.7	21.79	89.7	20.49	84.1	19.50	81.2	18.71	78.5	17.92	73.4	16.71		
	7.0	6.0	92.2	19.99	87.4	18.73	81.9	17.85	79.2	17.16	76.5	16.46	71.5	15.30		
	9.0	7.9	88.9	17.13	84.1	16.04	78.9	15.30	76.3	14.70	73.6	14.11	69.0	13.11		
	11.0	9.8	84.1	15.20	79.6	14.24	74.6	13.58	72.1	13.05	69.6	12.52	65.1	11.63		
	13.0	11.8	78.9	13.33	74.8	12.49	70.1	11.90	67.7	11.44	65.4	10.97	61.2	10.21		
15.0	13.7	74.6	12.01	70.7	11.24	66.3	10.62	64.1	10.21	61.9	9.79	57.9	9.19			
50	-24.8	-25	80.6	37.46	76.0	38.04	71.5	36.05	69.2	34.19	66.9	32.43	62.3	30.79		
	-21.8	-22	80.6	38.04	76.0	36.05	71.5	34.19	69.2	32.43	66.9	30.79	62.3	29.21		
	-19.8	-20	80.6	36.66	76.0	34.72	71.5	32.95	69.2	31.25	66.9	29.69	62.3	28.16		
	-18.8	-19	80.6	35.96	76.0	34.06	71.5	32.33	69.2	30.67	66.9	29.15	62.3	27.63		
	-16.7	-17	80.6	34.51	76.0	32.67	71.5	31.04	69.2	29.44	66.9	28.00	62.3	26.52		
	-13.7	-15	80.6	32.44	76.0	30.68	71.5	29.17	69.2	27.68	66.9	26.37	62.3	24.94		
	-11.8	-13	80.6	31.13	76.0	29.42	71.5	28.00	69.2	26.56	66.9	25.32	62.3	23.94		
	-9.8	-11	80.6	29.74	76.0	28.10	71.5	26.75	69.2	25.38	66.9	24.23	62.3	22.88		
	-9.5	-10	80.6	29.53	76.0	27.90	71.5	26.57	69.2	25.21	66.9	24.07	62.3	22.73		
	-8.5	-9.1	80.6	28.84	76.0	27.24	71.5	25.95	69.2	24.62	66.9	23.52	62.3	22.20		
	-7.0	-7.6	80.6	27.81	76.0	26.25	71.5	25.02	69.2	23.75	66.9	22.70	62.3	21.41		
	-5.0	-5.6	80.6	26.42	76.0	24.92	71.5	23.78	69.2	22.57	66.9	21.61	62.3	20.36		
	-3.0	-3.7	80.6	25.04	76.0	23.59	71.5	22.54	69.2	21.40	66.9	20.51	62.3	19.31		
	0.0	-0.7	80.6	22.96	76.0	21.60	71.5	20.68	69.2	19.63	66.9	18.87	62.3	17.72		
	3.0	2.2	80.6	20.89	76.0	19.62	71.5	18.83	69.2	17.87	66.9	17.24	62.3	16.14		
	5.0	4.1	79.0	17.65	74.6	16.54	70.0	15.90	67.8	15.10	65.5	14.59	61.1	13.64		
	7.0	6.0	77.0	16.13	72.6	15.10	68.2	14.55	66.1	13.81	63.9	13.39	59.5	12.49		
	9.0	7.9	74.2	13.96	70.0	13.07	65.7	12.60	63.6	11.97	61.5	11.60	57.4	10.82		
	11.0	9.8	70.5	12.54	66.5	11.74	62.5	11.31	60.1	10.74	58.2	10.41	54.3	9.71		
	13.0	11.8	65.9	10.88	62.1	10.19	58.4	9.81	56.5	9.38	54.7	9.04	50.9	8.47		
15.0	13.7	62.3	9.82	58.8	9.19	55.3	8.85	53.5	8.42	51.8	8.15	48.1	7.61			

**Note**

1. TC: Total Capacity(kW), PI : Power Input(kW, Comp. + Outdoor fan motor)
2. Capacity tables show the average value of conditions which may occur.
3. The heating capacity table is based on the values expressed as Max. in the specification of the outdoor unit. (When measuring the Max. heating capacity, the setting status of the indoor unit is the same as that for measuring the heating capacity of the indoor unit.)



# 7. Capacity Tables

## ◆ ARUM480LTE5

Heating Capacity (48HP)

Combination (%)	Outdoor air temp.		Indoor air temp. °C DB											
			16		18		20		21		22		24	
	°C DB	°C WB	TC	PI	TC	PI	TC	PI	TC	PI	TC	PI	TC	PI
130	-24.8	-25	90.8	51.4	90.8	51.86	90.2	52.22	90.2	52.76	90.2	53.30	88.6	54.14
	-21.8	-22	112.0	52.26	112.0	52.68	111.2	53.04	111.2	53.60	111.2	54.14	109.0	54.96
	-19.8	-20	118.8	52.82	118.8	53.24	118.0	53.60	118.0	54.16	118.0	54.68	115.8	55.52
	-18.8	-19	121.6	53.10	121.6	53.52	120.8	53.88	120.8	54.44	120.8	54.96	118.4	55.80
	-16.7	-17	127.2	53.68	127.2	54.10	126.4	54.46	126.4	55.02	126.4	55.56	124.0	56.38
	-13.7	-15	135.2	54.52	135.2	54.94	134.4	55.30	134.4	55.86	134.4	56.38	131.8	54.34
	-11.8	-13	139.6	55.06	139.6	55.46	138.8	55.82	138.8	56.38	138.8	55.02	136.8	53.04
	-9.8	-11	144.2	55.60	144.2	56.02	143.4	56.38	143.4	54.94	143.4	53.58	142.0	51.68
	-9.5	-10	145.0	55.70	145.0	56.10	144.2	56.16	144.2	54.72	144.0	53.36	142.8	51.46
	-8.5	-9.1	147.8	55.96	147.8	56.38	147.0	55.42	147.0	53.98	146.4	52.64	145.4	50.78
	-7.0	-7.6	152.0	56.38	152.0	55.32	151.0	54.32	151.0	52.90	151.0	51.54	149.2	49.76
	-5.0	-5.6	157.6	55.02	157.6	53.88	156.6	52.84	156.6	51.44	156.6	50.10	154.4	48.40
	-3.0	-3.7	163.2	53.66	163.2	52.46	162.2	51.36	162.2	49.98	162.2	48.66	159.6	47.02
	0.0	-0.7	171.6	51.60	171.6	50.32	170.4	49.16	170.4	47.80	170.4	46.50	167.6	44.98
	3.0	2.2	180.0	49.56	180.0	48.16	178.8	46.94	178.8	45.62	178.8	44.32	167.8	42.94
	5.0	4.1	182.2	43.78	181.8	42.40	180.6	41.20	180.6	39.96	176.6	38.76	164.4	37.52
	7.0	6.0	182.8	41.66	182.4	40.32	181.4	39.16	178.4	38.02	172.0	36.88	160.2	35.78
	9.0	7.9	177.0	38.90	176.6	37.64	176.2	36.54	171.8	35.48	165.8	34.42	154.4	33.40
	11.0	9.8	167.4	36.60	167.0	35.42	166.6	34.38	162.4	33.38	156.8	32.40	146.0	31.42
	13.0	11.8	157.2	33.78	157.0	32.70	156.4	31.74	152.6	30.82	147.2	29.90	137.0	29.00
15.0	13.7	148.8	31.46	148.4	30.44	148.0	29.56	144.4	28.70	139.4	27.84	129.6	27.00	
120	-24.8	-25	90.2	51.86	90.2	52.22	89.6	52.76	89.6	53.30	89.6	54.14	88.0	54.72
	-21.8	-22	111.2	52.68	111.2	53.04	110.4	53.60	110.4	54.14	110.4	54.96	108.4	55.56
	-19.8	-20	118.0	53.24	118.0	53.60	117.2	54.16	117.2	54.68	117.2	55.52	115.0	56.10
	-18.8	-19	120.6	53.52	120.6	53.88	119.8	54.44	119.8	54.96	119.8	55.80	117.6	56.38
	-16.7	-17	126.2	54.10	126.2	54.46	125.4	55.02	125.4	55.56	125.4	56.38	123.0	55.06
	-13.7	-15	134.2	54.94	134.2	55.30	133.4	55.86	133.4	56.38	133.4	54.42	130.8	53.18
	-11.8	-13	138.6	55.46	138.6	55.82	137.8	56.38	137.8	55.00	137.8	53.18	135.8	52.00
	-9.8	-11	143.2	56.02	143.2	56.38	142.4	54.86	142.4	53.54	142.4	51.88	141.0	50.74
	-9.5	-10	144.0	56.10	144.0	56.14	143.2	54.64	143.2	53.32	143.2	51.68	141.8	50.54
	-8.5	-9.1	146.8	56.38	146.8	55.34	145.8	53.88	145.8	52.60	145.8	51.04	144.2	49.92
	-7.0	-7.6	151.0	55.20	151.0	54.14	150.0	52.74	150.0	51.50	150.0	50.06	148.2	48.98
	-5.0	-5.6	156.6	53.62	156.6	52.54	155.6	51.22	155.6	50.04	155.6	48.74	153.4	47.72
	-3.0	-3.7	162.0	52.04	162.0	50.96	161.0	49.70	161.0	48.60	161.0	47.44	157.6	46.46
	0.0	-0.7	170.4	49.68	170.4	48.56	169.2	47.42	169.2	46.40	169.2	45.48	157.6	44.58
	3.0	2.2	178.6	47.32	178.6	46.16	177.6	45.14	175.0	44.22	169.6	43.52	157.6	42.70
	5.0	4.1	181.0	41.50	180.4	40.40	177.4	39.50	171.6	38.66	166.2	38.10	154.4	37.36
	7.0	6.0	181.8	39.30	180.0	38.24	173.0	37.48	167.2	36.76	162.0	36.42	150.4	35.76
	9.0	7.9	175.8	36.58	173.4	35.58	166.6	34.88	161.0	34.22	156.0	33.88	145.0	33.28
	11.0	9.8	166.2	34.30	164.0	33.36	157.6	32.70	152.2	32.08	147.6	31.78	137.0	31.22
	13.0	11.8	156.2	31.54	154.0	30.68	148.0	30.08	143.0	29.50	138.6	29.22	128.8	28.70
15.0	13.7	147.8	29.24	145.8	28.44	140.0	27.88	135.4	27.36	131.2	27.10	121.8	26.62	
110	-24.8	-25	89.8	52.22	89.8	52.76	89.2	53.30	89.2	54.14	89.2	54.72	87.4	55.00
	-21.8	-22	110.6	53.04	110.6	53.60	109.8	54.14	109.8	54.96	109.8	55.56	107.8	55.82
	-19.8	-20	117.4	53.60	117.4	54.16	116.6	54.68	116.6	55.52	116.6	56.10	114.4	56.38
	-18.8	-19	120.0	53.88	120.0	54.44	119.2	54.96	119.2	55.80	119.2	56.38	117.0	55.68
	-16.7	-17	125.6	54.46	125.6	55.02	124.8	55.56	124.8	56.38	124.8	54.96	122.4	54.20
	-13.7	-15	133.4	55.30	133.4	55.86	132.6	56.38	132.6	54.22	132.6	52.90	132.6	52.10
	-11.8	-13	137.8	55.82	137.8	56.38	137.0	54.86	137.0	52.84	137.0	51.60	137.0	50.76
	-9.8	-11	142.4	56.38	142.4	54.66	141.6	53.26	141.6	51.40	141.6	50.24	141.0	49.36
	-9.5	-10	143.2	56.10	143.2	54.40	142.4	53.00	142.4	51.18	142.4	50.04	141.8	49.16
	-8.5	-9.1	146.0	55.18	146.0	53.54	145.2	52.20	145.2	50.46	145.2	49.34	141.8	48.44
	-7.0	-7.6	150.2	53.78	150.2	52.26	149.2	51.00	149.2	49.38	149.2	48.32	141.8	47.40
	-5.0	-5.6	155.6	51.94	155.6	50.52	154.6	49.40	154.6	47.94	151.8	46.96	141.8	45.98
	-3.0	-3.7	161.2	50.08	161.2	48.80	160.2	47.78	157.2	46.48	151.8	45.58	141.8	44.58
	0.0	-0.7	169.4	47.30	169.4	46.22	162.4	45.38	157.2	44.32	151.8	43.54	141.8	42.48
	3.0	2.2	177.6	44.52	173.2	43.64	162.4	42.96	157.2	42.16	151.8	41.48	141.8	40.36
	5.0	4.1	179.6	38.70	169.6	37.96	159.2	37.40	154.0	36.76	148.8	36.20	139.0	35.14
	7.0	6.0	175.0	36.32	165.4	35.78	155.2	35.38	150.2	34.94	145.0	34.50	135.4	33.42
	9.0	7.9	168.6	33.62	159.2	33.12	149.4	32.74	144.6	32.34	139.8	31.94	130.4	30.94
	11.0	9.8	159.4	31.34	150.6	30.86	141.4	30.52	136.8	30.16	132.2	29.76	123.4	28.84
	13.0	11.8	149.6	28.64	141.4	28.20	132.8	27.88	128.4	27.54	124.0	27.20	115.8	26.36
15.0	13.7	141.6	26.34	133.8	25.94	125.6	25.64	121.4	25.34	117.4	25.02	109.6	24.24	

# 7. Capacity Tables

Heating Capacity (48HP)

Combination (%)	Outdoor air temp.		Indoor air temp. °C DB											
			16		18		20		21		22		24	
	°C DB	°C WB	TC	PI	TC	PI	TC	PI	TC	PI	TC	PI	TC	PI
100	-24.8	-25	89.4	57.96	89.4	57.76	88.8	53.88	88.8	57.24	88.8	57.02	87.0	56.92
	-21.8	-22	110.0	57.64	110.0	57.44	109.4	55.58	109.4	56.92	109.4	57.50	107.2	56.60
	-19.8	-20	116.8	57.44	116.8	57.22	116.2	56.64	116.2	56.72	116.2	56.76	114.0	56.38
	-18.8	-19	119.4	57.34	118.8	57.12	118.8	56.92	118.8	56.60	118.8	56.38	116.4	55.52
	-16.7	-17	124.2	57.12	124.2	56.90	124.2	57.50	123.6	56.38	123.6	56.38	123.6	54.60
	-13.7	-15	132.8	56.80	132.8	56.58	132.0	56.38	132.0	53.80	132.0	52.04	129.6	51.08
	-11.8	-13	137.2	56.60	136.4	56.38	136.4	54.66	136.4	52.16	136.4	50.42	129.6	49.44
	-9.8	-11	141.6	56.38	141.6	54.46	141.0	52.84	141.0	50.44	139.0	48.72	129.6	47.70
	-9.5	-10	142.4	56.08	142.4	54.16	141.8	52.58	141.8	50.18	139.0	48.46	129.6	47.44
	-8.5	-9.1	145.2	55.08	145.2	53.20	144.6	51.66	143.8	49.32	139.0	47.62	129.6	46.56
	-7.0	-7.6	151.8	53.58	151.2	51.76	148.6	50.30	143.8	48.04	139.0	46.34	129.6	45.26
	-5.0	-5.6	158.4	51.56	156.8	49.84	148.6	48.50	143.8	46.30	139.0	44.64	129.6	43.52
	-3.0	-3.7	163.0	49.56	158.2	47.90	148.6	46.68	143.8	44.58	139.0	42.94	129.6	41.78
	0.0	-0.7	167.6	46.54	158.2	45.02	148.6	43.96	143.8	42.00	139.0	40.38	129.6	39.18
	3.0	2.2	167.6	43.52	158.2	42.12	148.6	41.24	143.8	39.42	139.0	37.82	129.6	36.58
	5.0	4.1	164.2	37.68	155.0	36.44	145.6	35.68	141.0	34.08	136.4	32.62	127.0	31.46
	7.0	6.0	160.0	35.16	151.0	34.06	142.0	33.46	137.4	32.02	132.8	30.64	123.8	29.46
	9.0	7.9	154.2	32.40	145.4	31.38	136.8	30.84	132.4	29.50	128.0	28.22	119.2	27.14
	11.0	9.8	145.8	30.04	137.6	29.08	129.2	28.58	125.2	27.34	121.0	26.16	112.8	25.16
	13.0	11.8	137.0	27.26	129.2	26.40	121.4	25.94	117.6	24.82	113.6	23.76	105.8	22.84
15.0	13.7	129.6	24.90	122.2	24.12	114.8	23.70	111.2	22.66	107.6	21.68	100.2	20.86	
90	-24.8	-25	89.0	51.44	89.0	52.26	88.4	52.86	88.4	53.12	88.4	53.68	86.8	54.52
	-21.8	-22	109.6	52.26	109.6	53.10	109.0	53.68	109.0	53.96	109.0	54.52	106.8	52.22
	-19.8	-20	116.4	52.82	116.4	53.66	115.6	54.24	115.6	54.52	115.6	54.94	113.4	50.68
	-18.8	-19	119.4	53.10	118.8	53.94	118.2	54.52	118.2	53.72	118.2	52.16	116.0	49.92
	-16.7	-17	124.2	53.68	124.2	54.52	123.8	52.86	123.8	52.02	123.8	50.52	118.4	48.30
	-13.7	-15	132.8	54.52	132.8	52.04	131.6	50.48	131.6	49.60	127.6	48.16	118.4	46.00
	-11.8	-13	137.2	52.82	136.4	50.48	135.8	48.96	131.8	48.06	127.6	46.68	118.4	44.54
	-9.8	-11	141.6	51.06	141.6	48.84	136.0	47.38	131.8	46.44	127.6	45.10	118.4	43.00
	-9.5	-10	142.4	50.78	142.4	48.58	136.0	47.14	131.8	46.20	127.6	44.86	118.4	42.76
	-8.5	-9.1	145.2	49.90	144.2	47.76	136.0	46.34	131.8	45.40	127.6	44.08	118.4	42.00
	-7.0	-7.6	151.8	48.56	144.4	46.52	136.0	45.16	131.8	44.18	127.6	42.90	118.4	40.84
	-5.0	-5.6	153.4	46.78	144.4	44.88	136.0	43.58	131.8	42.58	127.6	41.34	118.4	39.32
	-3.0	-3.7	153.4	45.00	144.4	43.24	136.0	41.98	131.8	40.96	127.6	39.76	118.4	37.78
	0.0	-0.7	153.4	42.34	144.4	40.76	136.0	39.60	131.8	38.54	127.6	37.40	118.4	35.48
	3.0	2.2	153.4	39.66	144.4	38.28	136.0	37.22	131.8	36.12	127.6	35.06	118.4	33.16
	5.0	4.1	150.4	34.30	141.6	33.12	133.2	32.18	129.2	31.16	125.0	30.22	116.0	28.52
	7.0	6.0	146.6	32.14	138.0	31.14	129.8	30.30	125.8	29.28	121.8	28.40	113.2	26.78
	9.0	7.9	141.2	29.60	132.8	28.70	125.0	27.92	121.2	26.96	117.4	26.16	109.0	24.68
	11.0	9.8	133.6	27.18	125.6	26.34	118.2	25.62	114.6	24.76	111.0	24.02	103.0	22.64
	13.0	11.8	125.4	24.16	118.0	23.42	111.0	22.80	107.6	22.02	104.2	21.36	96.8	20.14
15.0	13.7	118.6	21.84	111.6	21.16	105.2	20.60	101.8	19.90	98.6	19.30	91.6	18.20	
80	-24.8	-25	88.6	45.26	88.6	46.10	88.0	46.68	88.0	46.96	88.0	48.34	86.4	46.32
	-21.8	-22	108.4	46.10	108.4	46.92	108.4	47.50	108.4	48.34	108.4	46.32	105.8	44.36
	-19.8	-20	115.2	46.64	115.2	47.48	115.2	48.34	115.2	46.92	113.8	44.96	105.8	43.06
	-18.8	-19	117.8	46.92	117.8	48.34	117.8	47.62	117.8	46.20	113.8	44.28	105.8	42.42
	-16.7	-17	121.6	48.34	121.6	46.84	121.6	46.10	118.0	44.70	113.8	42.88	105.8	41.06
	-13.7	-15	127.2	46.12	124.6	44.68	121.6	43.94	118.0	42.56	113.8	40.84	105.8	39.10
	-11.8	-13	130.2	44.70	126.4	43.32	121.6	42.56	118.0	41.20	113.8	39.56	105.8	37.86
	-9.8	-11	133.6	43.22	128.2	41.90	121.6	41.12	118.0	39.78	113.8	38.20	105.8	36.56
	-9.5	-10	134.6	43.00	129.0	41.68	121.6	40.90	118.0	39.56	113.8	38.00	105.8	36.38
	-8.5	-9.1	136.0	42.26	129.6	40.96	121.6	40.18	118.0	38.84	113.8	37.34	105.8	35.72
	-7.0	-7.6	137.4	41.14	129.6	39.88	121.6	39.10	118.0	37.78	113.8	36.32	105.8	34.74
	-5.0	-5.6	137.4	39.66	129.6	38.46	121.6	37.64	118.0	36.34	113.8	34.96	105.8	33.44
	-3.0	-3.7	137.4	38.18	129.6	37.02	121.6	36.20	118.0	34.92	113.8	33.62	105.8	32.14
	0.0	-0.7	137.4	35.94	129.6	34.88	121.6	34.04	118.0	32.78	113.8	31.58	105.8	30.20
	3.0	2.2	137.4	33.72	129.6	32.72	121.6	31.86	118.0	30.62	113.8	29.56	105.8	28.24
	5.0	4.1	134.6	29.14	127.0	28.26	119.2	27.48	115.6	26.36	111.4	25.44	103.8	24.30
	7.0	6.0	131.2	27.36	123.8	26.58	116.2	25.78	112.6	24.72	108.6	23.90	101.0	22.82
	9.0	7.9	126.4	24.54	119.2	23.86	111.8	23.26	108.6	22.36	104.6	21.56	97.4	20.54
	11.0	9.8	119.6	21.82	112.6	21.22	105.8	20.68	102.6	19.88	99.0	19.18	92.0	18.26
	13.0	11.8	112.2	18.98	105.8	18.44	99.4	17.98	96.4	17.28	93.0	16.66	86.4	15.88
15.0	13.7	106.2	17.14	100.2	16.64	94.0	16.24	91.2	15.60	88.0	15.06	81.8	14.34	

# 7. Capacity Tables

Heating Capacity (48HP)

Combination (%)	Outdoor air temp.		Indoor air temp. °C DB											
			16		18		20		21		22		24	
	°C DB	°C WB	TC	PI	TC	PI	TC	PI	TC	PI	TC	PI	TC	PI
70	-24.8	-25	88.6	45.54	88.6	45.82	88.0	46.38	88.0	47.22	88.0	45.00	88.4	42.92
	-21.8	-22	104.2	46.38	104.2	46.66	103.6	47.22	100.0	45.00	97.0	42.92	90.6	40.92
	-19.8	-20	114.6	46.94	110.0	47.22	103.6	45.66	100.0	43.52	97.0	41.54	90.6	39.58
	-18.8	-19	116.6	47.22	110.0	46.42	103.6	44.88	100.0	42.78	97.0	40.84	90.6	38.90
	-16.7	-17	116.6	45.54	110.0	44.72	103.6	43.26	100.0	41.22	97.0	39.40	90.6	37.50
	-13.7	-15	116.6	43.18	110.0	42.32	103.6	40.92	100.0	39.02	97.0	37.32	90.6	35.48
	-11.8	-13	116.6	41.66	110.0	40.80	103.6	39.44	100.0	37.60	97.0	36.00	90.6	34.22
	-9.8	-11	116.6	40.08	110.0	39.18	103.6	37.90	100.0	36.12	97.0	34.62	90.6	32.88
	-9.5	-10	116.6	39.84	110.0	38.94	103.6	37.66	100.0	35.90	97.0	34.42	90.6	32.68
	-8.5	-9.1	116.6	39.06	110.0	38.14	103.6	36.88	100.0	35.16	97.0	33.72	90.6	32.00
	-7.0	-7.6	116.6	37.86	110.0	36.94	103.6	35.72	100.0	34.06	97.0	32.68	90.6	31.00
	-5.0	-5.6	116.6	36.28	110.0	35.34	103.6	34.16	100.0	32.58	97.0	31.30	90.6	29.66
	-3.0	-3.7	116.6	34.70	110.0	33.72	103.6	32.60	100.0	31.10	97.0	29.92	90.6	28.32
	0.0	-0.7	116.6	32.32	110.0	31.32	103.6	30.28	100.0	28.88	97.0	27.84	90.6	26.32
	3.0	2.2	116.6	29.94	110.0	28.92	103.6	27.94	100.0	26.68	97.0	25.76	90.6	24.30
	5.0	4.1	116.6	26.20	107.8	24.68	101.4	23.86	98.0	22.74	95.0	22.02	88.8	20.74
	7.0	6.0	116.6	25.02	105.0	22.88	98.8	22.10	95.4	21.10	92.6	20.46	86.4	19.24
	9.0	7.9	112.4	21.68	101.2	19.80	95.2	19.14	92.0	18.28	89.2	17.72	83.2	16.66
	11.0	9.8	106.4	19.24	95.8	17.58	90.0	17.00	87.0	16.22	84.4	15.74	78.8	14.80
	13.0	11.8	99.8	16.88	90.0	15.44	84.6	14.92	81.6	14.24	79.2	13.80	74.0	12.98
15.0	13.7	94.4	15.06	85.0	13.76	80.0	13.30	77.2	12.70	75.0	12.32	70.0	11.58	
60	-24.8	-25	88.6	44.98	88.6	45.54	88.0	46.38	85.8	44.00	82.8	41.78	77.6	39.68
	-21.8	-22	95.4	45.82	94.6	46.38	88.8	44.00	85.8	41.78	82.8	39.68	77.6	37.66
	-19.8	-20	100.0	46.38	94.6	44.70	88.8	42.42	85.8	40.30	82.8	38.28	77.6	36.30
	-18.8	-19	100.0	45.54	94.6	43.86	88.8	41.62	85.8	39.54	82.8	37.58	77.6	35.62
	-16.7	-17	100.0	43.76	94.6	42.10	88.8	39.96	85.8	37.98	82.8	36.12	77.6	34.20
	-13.7	-15	100.0	41.22	94.6	39.60	88.8	37.60	85.8	35.76	82.8	34.02	77.6	32.18
	-11.8	-13	100.0	39.62	94.6	38.00	88.8	36.08	85.8	34.34	82.8	32.70	77.6	30.90
	-9.8	-11	100.0	37.94	94.6	36.32	88.8	34.50	85.8	32.86	82.8	31.30	77.6	29.54
	-9.5	-10	100.0	37.68	94.6	36.08	88.8	34.26	85.8	32.64	82.8	31.08	77.6	29.34
	-8.5	-9.1	100.0	36.84	94.6	35.24	88.8	33.48	85.8	31.90	82.8	30.38	77.6	28.66
	-7.0	-7.6	100.0	35.58	94.6	33.98	88.8	32.30	85.8	30.78	82.8	29.34	77.6	27.64
	-5.0	-5.6	100.0	33.88	94.6	32.30	88.8	30.70	85.8	29.30	82.8	27.94	77.6	26.30
	-3.0	-3.7	100.0	32.20	94.6	30.62	88.8	29.12	85.8	27.82	82.8	26.54	77.6	24.94
	0.0	-0.7	100.0	29.66	94.6	28.12	88.8	26.76	85.8	25.58	82.8	24.44	77.6	22.92
	3.0	2.2	100.0	27.12	94.6	25.60	88.8	24.38	85.8	23.36	82.8	22.36	77.6	20.88
	5.0	4.1	98.0	23.02	92.8	21.64	87.0	20.60	84.0	19.76	81.2	18.94	76.0	17.66
	7.0	6.0	95.4	21.14	90.4	19.80	84.8	18.88	82.0	18.14	79.2	17.40	74.0	16.18
	9.0	7.9	92.0	18.12	87.0	16.96	81.6	16.18	79.0	15.54	76.2	14.92	71.4	13.86
	11.0	9.8	87.0	16.08	82.4	15.06	77.2	14.36	74.6	13.80	72.0	13.24	67.4	12.30
	13.0	11.8	81.6	14.10	77.4	13.20	72.6	12.58	70.0	12.10	67.6	11.60	63.4	10.80
15.0	13.7	77.2	12.70	73.2	11.88	68.6	11.22	66.4	10.80	64.0	10.36	60.0	9.72	
50	-24.8	-25	83.4	39.30	78.6	40.14	74.0	38.04	71.6	36.08	69.2	34.22	64.4	32.50
	-21.8	-22	83.4	40.14	78.6	38.04	74.0	36.08	71.6	34.22	69.2	32.50	64.4	30.84
	-19.8	-20	83.4	38.68	78.6	36.64	74.0	34.78	71.6	32.98	69.2	31.34	64.4	29.72
	-18.8	-19	83.4	37.94	78.6	35.94	74.0	34.12	71.6	32.38	69.2	30.76	64.4	29.16
	-16.7	-17	83.4	36.42	78.6	34.48	74.0	32.76	71.6	31.08	69.2	29.56	64.4	28.00
	-13.7	-15	83.4	34.24	78.6	32.38	74.0	30.80	71.6	29.22	69.2	27.84	64.4	26.34
	-11.8	-13	83.4	32.86	78.6	31.06	74.0	29.56	71.6	28.04	69.2	26.74	64.4	25.28
	-9.8	-11	83.4	31.40	78.6	29.66	74.0	28.24	71.6	26.80	69.2	25.58	64.4	24.16
	-9.5	-10	83.4	31.18	78.6	29.46	74.0	28.06	71.6	26.62	69.2	25.42	64.4	24.00
	-8.5	-9.1	83.4	30.44	78.6	28.76	74.0	27.40	71.6	26.00	69.2	24.84	64.4	23.44
	-7.0	-7.6	83.4	29.36	78.6	27.72	74.0	26.42	71.6	25.08	69.2	23.98	64.4	22.62
	-5.0	-5.6	83.4	27.90	78.6	26.32	74.0	25.12	71.6	23.84	69.2	22.82	64.4	21.50
	-3.0	-3.7	83.4	26.44	78.6	24.92	74.0	23.80	71.6	22.60	69.2	21.66	64.4	20.40
	0.0	-0.7	83.4	24.26	78.6	22.82	74.0	21.84	71.6	20.74	69.2	19.94	64.4	18.72
	3.0	2.2	83.4	22.08	78.6	20.74	74.0	19.90	71.6	18.88	69.2	18.22	64.4	17.06
	5.0	4.1	81.8	18.66	77.2	17.48	72.4	16.80	70.2	15.96	67.8	15.42	63.2	14.42
	7.0	6.0	79.6	17.06	75.2	15.96	70.6	15.38	68.4	14.60	66.2	14.16	61.6	13.20
	9.0	7.9	76.8	14.76	72.4	13.82	68.0	13.32	65.8	12.66	63.6	12.26	59.4	11.44
	11.0	9.8	73.0	13.26	68.8	12.42	64.6	11.96	62.2	11.36	60.2	11.00	56.2	10.26
	13.0	11.8	68.2	11.50	64.2	10.78	60.4	10.38	58.4	9.92	56.6	9.56	52.6	8.96
15.0	13.7	64.4	10.38	60.8	9.72	57.2	9.36	55.4	8.90	53.6	8.62	49.8	8.04	

**Note**

1. TC: Total Capacity(kW), PI : Power Input(kW, Comp. + Outdoor fan motor)
2. Capacity tables show the average value of conditions which may occur.
3. The heating capacity table is based on the values expressed as Max. in the specification of the outdoor unit. (When measuring the Max. heating capacity, the setting status of the indoor unit is the same as that for measuring the heating capacity of the indoor unit.)

# 7. Capacity Tables



## ◆ ARUM500LTE5

Heating Capacity (50HP)

Combination (%)	Outdoor air temp.		Indoor air temp. °C DB											
			16		18		20		21		22		24	
	°C DB	°C WB	TC	PI	TC	PI	TC	PI	TC	PI	TC	PI	TC	PI
130	-24.8	-25	96.6	50.2	96.6	50.77	96.1	51.26	96.1	51.99	96.1	52.71	94.6	53.83
	-21.8	-22	117.7	51.33	117.7	51.88	116.8	52.37	116.8	53.11	116.8	53.83	115.0	54.93
	-19.8	-20	124.1	52.07	124.1	52.63	123.3	53.11	123.3	53.86	123.3	54.56	121.4	55.68
	-18.8	-19	127.0	52.45	127.0	53.00	126.2	53.49	126.2	54.23	126.2	54.93	124.2	56.05
	-16.7	-17	133.1	53.23	133.1	53.78	132.2	54.27	132.2	55.01	132.2	55.72	130.1	56.83
	-13.7	-15	141.6	54.35	141.6	54.90	140.8	55.39	140.8	56.13	140.8	56.83	138.5	54.62
	-11.8	-13	146.2	55.06	146.2	55.60	145.4	56.09	145.4	56.83	145.4	57.56	143.8	53.22
	-9.8	-11	151.1	55.79	151.1	56.35	150.1	56.83	150.1	57.56	150.1	58.29	149.1	51.75
	-9.5	-10	152.0	55.92	152.0	56.46	151.1	56.59	151.1	57.32	150.9	57.56	150.0	51.51
	-8.5	-9.1	155.1	56.28	155.1	56.83	154.2	57.56	154.2	58.29	153.3	58.29	152.7	50.77
	-7.0	-7.6	159.8	56.83	159.8	57.56	158.7	58.29	158.7	59.02	158.7	59.75	157.3	49.67
	-5.0	-5.6	166.1	57.56	166.1	58.29	165.0	59.02	165.0	59.75	165.0	60.48	162.8	48.19
	-3.0	-3.7	172.3	58.29	172.3	59.02	171.2	59.75	171.2	60.48	171.2	61.21	168.4	46.71
	0.0	-0.7	181.6	59.02	181.6	59.75	180.5	60.48	180.5	61.21	180.5	61.94	176.3	44.50
	3.0	2.2	191.0	60.48	191.0	61.21	189.7	61.94	189.7	62.67	188.2	63.40	176.4	42.28
	5.0	4.1	193.1	61.21	192.7	62.67	191.6	63.40	191.6	64.13	190.4	64.86	172.8	36.85
	7.0	6.0	192.4	62.67	192.0	63.40	191.0	64.13	187.5	64.86	180.9	65.59	168.4	35.00
9.0	7.9	186.0	64.13	185.6	64.86	185.2	65.59	180.6	66.32	174.3	67.31	162.3	32.49	
11.0	9.8	176.0	65.59	175.6	66.32	175.1	67.05	170.7	68.04	164.8	68.77	153.4	30.37	
13.0	11.8	165.3	67.05	165.0	67.78	164.4	68.51	160.4	69.24	154.8	70.00	144.1	27.84	
15.0	13.7	156.3	68.51	156.1	69.24	155.5	69.97	151.7	70.71	146.4	71.51	136.3	25.71	
120	-24.8	-25	96.0	50.77	96.0	51.26	95.4	51.99	95.4	52.71	95.4	53.46	93.9	54.61
	-21.8	-22	116.8	51.88	116.8	52.37	116.0	53.11	116.0	53.83	116.0	54.56	114.3	55.72
	-19.8	-20	123.2	52.63	123.2	53.11	122.4	53.86	122.4	54.56	122.4	55.31	120.5	56.46
	-18.8	-19	126.1	53.00	126.1	53.49	125.2	54.23	125.2	54.93	125.2	55.67	123.3	56.83
	-16.7	-17	132.1	53.78	132.1	54.27	131.3	55.01	131.3	55.72	131.3	56.46	129.1	55.41
	-13.7	-15	140.5	54.90	140.5	55.39	139.7	56.13	139.7	56.83	139.7	57.56	137.5	53.37
	-11.8	-13	145.1	55.60	145.1	56.09	144.3	56.83	144.3	57.56	144.3	58.29	142.7	52.09
	-9.8	-11	150.0	56.35	150.0	56.83	149.1	57.56	149.1	58.29	149.1	59.02	148.1	50.73
	-9.5	-10	151.0	56.46	151.0	56.57	150.1	56.83	150.1	57.56	150.1	58.29	149.1	50.52
	-8.5	-9.1	154.1	56.83	154.1	57.56	153.0	58.29	153.0	59.02	152.1	59.75	151.9	49.84
	-7.0	-7.6	158.7	57.56	158.7	58.29	157.7	59.02	157.7	59.75	157.7	60.48	156.2	48.82
	-5.0	-5.6	164.9	58.29	164.9	59.02	163.8	59.75	163.8	60.48	163.8	61.21	161.8	47.46
	-3.0	-3.7	171.1	59.02	171.1	59.75	170.0	60.48	170.0	61.21	170.0	61.94	165.7	46.10
	0.0	-0.7	180.3	59.75	180.3	60.48	179.1	61.21	179.1	61.94	179.1	62.67	165.7	44.06
	3.0	2.2	189.6	60.48	189.6	61.21	188.5	61.94	188.5	62.67	188.5	63.40	165.7	42.03
	5.0	4.1	191.8	61.21	191.8	61.94	190.7	62.67	190.7	63.40	190.7	64.13	162.3	36.68
	7.0	6.0	191.2	62.67	189.2	63.40	188.8	64.13	187.7	64.86	186.6	65.59	158.2	34.99
9.0	7.9	184.8	64.13	182.3	64.86	181.9	65.59	180.8	66.32	179.7	67.05	152.4	32.38	
11.0	9.8	174.7	65.59	172.4	66.32	171.5	67.05	170.4	67.78	169.3	68.51	144.1	30.20	
13.0	11.8	164.1	67.05	161.9	67.78	161.0	68.51	160.0	69.24	158.9	70.00	135.3	27.58	
15.0	13.7	155.3	68.51	153.2	69.24	152.1	69.97	151.0	70.71	149.9	71.51	128.0	25.38	
110	-24.8	-25	95.5	51.26	95.5	51.99	94.9	52.71	94.9	53.46	94.9	54.21	93.4	54.98
	-21.8	-22	116.2	52.37	116.2	53.11	115.4	53.83	115.4	54.56	115.4	55.31	113.7	56.09
	-19.8	-20	122.6	53.11	122.6	53.86	121.8	54.56	121.8	55.31	121.8	56.05	119.9	56.83
	-18.8	-19	125.4	53.49	125.4	54.23	124.5	54.93	124.5	55.67	124.5	56.41	122.7	56.09
	-16.7	-17	131.4	54.27	131.4	55.01	130.6	55.72	130.6	56.46	130.6	57.19	128.4	54.51
	-13.7	-15	139.8	55.39	139.8	56.13	138.9	56.83	138.9	57.56	138.9	58.29	138.9	52.26
	-11.8	-13	144.4	56.09	144.4	56.83	143.5	57.56	143.5	58.29	143.5	59.02	143.5	50.84
	-9.8	-11	149.2	56.83	149.2	57.56	148.3	58.29	148.3	59.02	148.3	59.75	148.0	49.34
	-9.5	-10	150.1	56.93	150.1	57.04	149.3	57.31	149.3	58.04	149.3	58.77	148.8	49.11
	-8.5	-9.1	153.2	57.56	153.2	58.29	152.3	59.02	152.3	59.75	152.3	60.48	149.1	48.36
	-7.0	-7.6	157.9	58.29	157.9	59.02	156.9	59.75	156.9	60.48	156.9	61.21	149.1	47.24
	-5.0	-5.6	164.0	59.02	164.0	59.75	162.9	60.48	162.9	61.21	162.9	61.94	149.1	45.73
	-3.0	-3.7	170.1	59.75	170.1	60.48	169.0	61.21	169.0	61.94	169.0	62.67	149.1	44.24
	0.0	-0.7	179.4	60.48	179.0	61.21	177.9	61.94	177.9	62.67	177.9	63.40	149.1	42.00
	3.0	2.2	188.1	61.21	187.0	61.94	186.0	62.67	185.0	63.40	184.0	64.13	149.1	39.74
	5.0	4.1	188.7	62.67	187.4	63.40	186.3	64.13	185.2	64.86	184.1	65.59	146.1	34.50
	7.0	6.0	183.9	64.13	182.9	64.86	181.8	65.59	180.7	66.32	179.6	67.05	142.4	32.69
9.0	7.9	177.2	65.59	176.4	66.32	175.3	67.05	174.2	67.78	173.1	68.51	137.1	30.12	
11.0	9.8	167.5	67.05	166.3	67.78	165.2	68.51	164.1	69.24	163.0	70.00	129.7	27.91	
13.0	11.8	157.3	68.51	156.1	69.24	155.0	69.97	153.9	70.71	152.8	71.51	121.8	25.34	
15.0	13.7	148.8	69.97	147.7	70.71	146.6	71.51	145.5	72.24	144.4	73.00	115.2	23.12	

# 7. Capacity Tables

Heating Capacity (50HP)

Combination (%)	Outdoor air temp.		Indoor air temp. °C DB											
			16		18		20		21		22		24	
	°C DB	°C WB	TC	PI	TC	PI	TC	PI	TC	PI	TC	PI	TC	PI
100	-24.8	-25	95.1	56.99	95.1	56.97	94.5	53.74	94.5	56.92	94.5	56.90	93.0	56.89
	-21.8	-22	115.6	56.96	115.6	56.94	115.0	55.43	115.0	56.89	115.0	57.67	113.1	56.86
	-19.8	-20	122.0	56.94	122.0	56.91	121.3	56.51	121.3	56.87	121.3	57.11	119.4	56.83
	-18.8	-19	124.8	56.93	124.1	56.91	124.1	56.89	124.1	56.85	124.1	56.83	122.1	55.92
	-16.7	-17	130.0	56.91	130.0	56.89	130.0	57.67	129.3	56.83	129.3	54.95	127.2	54.01
	-13.7	-15	139.1	56.88	139.1	56.85	138.3	56.83	138.3	54.10	138.3	52.26	136.3	51.27
	-11.8	-13	143.7	56.86	142.9	56.83	142.9	55.00	142.9	52.36	142.9	50.54	136.3	49.54
	-9.8	-11	148.4	56.83	148.4	54.77	147.7	53.06	147.7	50.54	146.2	48.76	136.3	47.71
	-9.5	-10	149.3	56.51	149.3	54.46	148.6	52.77	148.6	50.26	146.2	48.48	136.3	47.44
	-8.5	-9.1	152.4	55.43	152.4	53.43	151.7	51.80	151.2	49.34	146.2	47.59	136.3	46.52
	-7.0	-7.6	159.6	53.81	159.0	51.88	156.2	50.34	151.2	47.98	146.2	46.24	136.3	45.15
	-5.0	-5.6	166.5	51.64	164.9	49.82	156.2	48.41	151.2	46.15	146.2	44.44	136.3	43.32
	-3.0	-3.7	171.4	49.48	166.2	47.75	156.2	46.47	151.2	44.32	146.2	42.66	136.3	41.50
	0.0	-0.7	176.1	46.23	166.2	44.66	156.2	43.56	151.2	41.59	146.2	39.95	136.3	38.76
	3.0	2.2	176.1	42.97	166.2	41.56	156.2	40.66	151.2	38.85	146.2	37.26	136.3	36.03
	5.0	4.1	172.6	37.06	162.9	35.82	153.0	35.06	148.2	33.48	143.4	32.04	133.5	30.90
	7.0	6.0	168.2	34.39	158.7	33.31	149.2	32.73	144.4	31.32	139.6	29.97	130.1	28.82
	9.0	7.9	162.1	31.46	152.9	30.47	143.8	29.94	139.2	28.64	134.6	27.39	125.3	26.35
	11.0	9.8	153.3	28.91	144.6	27.99	135.9	27.51	131.5	26.32	127.2	25.18	118.6	24.22
	13.0	11.8	143.9	25.97	135.8	25.16	127.6	24.72	123.6	23.65	119.4	22.63	111.2	21.76
15.0	13.7	136.3	23.44	128.5	22.70	120.7	22.31	116.9	21.34	113.0	20.42	105.3	19.64	
90	-24.8	-25	94.7	50.55	94.7	51.66	94.1	52.45	94.1	52.81	94.1	53.56	92.7	54.68
	-21.8	-22	115.2	51.66	115.2	52.78	114.6	53.56	114.6	53.93	114.6	54.68	112.6	52.29
	-19.8	-20	121.6	52.41	121.6	53.52	120.8	54.30	120.8	54.68	120.8	55.04	118.9	50.71
	-18.8	-19	124.8	52.78	124.1	53.90	123.6	54.68	123.6	53.84	123.6	52.23	121.7	49.92
	-16.7	-17	130.0	53.56	130.0	54.68	129.4	52.94	129.4	52.07	129.4	50.53	124.4	48.25
	-13.7	-15	139.1	54.68	139.1	52.08	137.9	50.45	137.9	49.56	134.0	48.08	124.4	45.87
	-11.8	-13	143.7	52.89	142.9	50.45	142.3	48.88	138.5	47.96	134.0	46.53	124.4	44.36
	-9.8	-11	148.4	51.03	148.4	48.73	143.0	47.23	138.5	46.28	134.0	44.91	124.4	42.77
	-9.5	-10	149.3	50.74	149.3	48.46	143.0	46.97	138.5	46.02	134.0	44.66	124.4	42.53
	-8.5	-9.1	152.4	49.82	151.3	47.60	143.0	46.14	138.5	45.18	134.0	43.84	124.4	41.74
	-7.0	-7.6	159.6	48.41	151.8	46.31	143.0	44.90	138.5	43.92	134.0	42.62	124.4	40.55
	-5.0	-5.6	161.3	46.54	151.8	44.58	143.0	43.25	138.5	42.25	134.0	40.99	124.4	38.97
	-3.0	-3.7	161.3	44.67	151.8	42.86	143.0	41.59	138.5	40.57	134.0	39.36	124.4	37.37
	0.0	-0.7	161.3	41.87	151.8	40.27	143.0	39.11	138.5	38.05	134.0	36.92	124.4	35.00
	3.0	2.2	161.3	39.05	151.8	37.68	143.0	36.62	138.5	35.54	134.0	34.48	124.4	32.61
	5.0	4.1	158.1	33.68	148.8	32.51	140.0	31.58	135.7	30.58	131.4	29.65	121.9	27.98
	7.0	6.0	154.1	31.44	145.0	30.46	136.4	29.64	132.2	28.64	128.0	27.78	119.0	26.19
	9.0	7.9	148.4	28.74	139.6	27.87	131.4	27.11	127.4	26.18	123.3	25.41	114.5	23.96
	11.0	9.8	140.4	26.16	132.1	25.35	124.3	24.67	120.5	23.83	116.6	23.12	108.3	21.79
	13.0	11.8	131.8	23.03	124.0	22.32	116.8	21.73	113.1	20.98	109.5	20.35	101.7	19.19
15.0	13.7	124.7	20.56	117.3	19.93	110.5	19.39	107.0	18.73	103.7	18.17	96.3	17.14	
80	-24.8	-25	94.3	44.35	94.3	45.47	93.7	46.25	93.7	46.62	93.7	48.48	92.3	46.39
	-21.8	-22	113.9	45.47	113.9	46.58	113.9	47.36	113.9	48.48	113.9	46.39	111.2	44.38
	-19.8	-20	120.3	46.21	120.3	47.32	120.3	48.48	120.3	47.00	119.3	44.99	111.2	43.04
	-18.8	-19	123.1	46.58	123.1	48.48	123.1	47.73	123.1	46.26	119.5	44.29	111.2	42.37
	-16.7	-17	127.8	48.48	127.8	46.92	127.8	46.16	124.0	44.71	119.5	42.83	111.2	40.97
	-13.7	-15	133.6	46.16	131.0	44.67	127.8	43.91	124.0	42.49	119.5	40.73	111.2	38.96
	-11.8	-13	137.0	44.67	132.9	43.25	127.8	42.47	124.0	41.08	119.5	39.40	111.2	37.68
	-9.8	-11	140.6	43.12	134.9	41.76	127.8	40.97	124.0	39.61	119.5	38.01	111.2	36.34
	-9.5	-10	141.6	42.89	135.6	41.53	127.8	40.74	124.0	39.38	119.5	37.79	111.2	36.14
	-8.5	-9.1	143.1	42.12	136.2	40.79	127.8	39.99	124.0	38.64	119.5	37.10	111.2	35.47
	-7.0	-7.6	144.5	40.95	136.2	39.66	127.8	38.86	124.0	37.53	119.5	36.06	111.2	34.46
	-5.0	-5.6	144.5	39.40	136.2	38.18	127.8	37.36	124.0	36.04	119.5	34.65	111.2	33.12
	-3.0	-3.7	144.5	37.85	136.2	36.68	127.8	35.86	124.0	34.57	119.5	33.26	111.2	31.78
	0.0	-0.7	144.5	35.51	136.2	34.44	127.8	33.61	124.0	32.35	119.5	31.15	111.2	29.78
	3.0	2.2	144.5	33.19	136.2	32.19	127.8	31.35	124.0	30.12	119.5	29.06	111.2	27.76
	5.0	4.1	141.6	28.60	133.5	27.74	125.3	26.96	121.5	25.86	117.1	24.96	109.1	23.84
	7.0	6.0	138.0	26.76	130.1	26.00	122.1	25.23	118.4	24.18	114.1	23.38	106.2	22.32
	9.0	7.9	132.9	23.78	125.3	23.12	117.6	22.55	114.1	21.69	109.9	20.92	102.4	19.92
	11.0	9.8	125.7	20.96	118.4	20.39	111.2	19.88	107.9	19.12	104.1	18.44	96.7	17.56
	13.0	11.8	118.0	18.05	111.2	17.54	104.5	17.12	101.3	16.45	97.7	15.86	90.9	15.11
15.0	13.7	111.6	16.10	105.3	15.65	98.8	15.26	95.9	14.68	92.5	14.15	86.0	13.48	

# 7. Capacity Tables

Heating Capacity (50HP)

Combination (%)	Outdoor air temp.		Indoor air temp. °C DB											
			16		18		20		21		22		24	
	°C DB	°C WB	TC	PI	TC	PI	TC	PI	TC	PI	TC	PI	TC	PI
70	-24.8	-25	94.3	44.96	94.3	45.33	93.7	46.08	93.7	47.20	93.7	44.94	92.2	42.81
	-21.8	-22	109.5	46.08	109.5	46.45	108.8	47.20	105.1	44.94	102.0	42.81	95.2	40.77
	-19.8	-20	119.7	46.83	115.7	47.20	108.8	45.61	105.1	43.43	102.0	41.41	95.2	39.42
	-18.8	-19	122.3	47.20	115.7	46.37	108.8	44.81	105.1	42.67	102.0	40.70	95.2	38.72
	-16.7	-17	122.5	45.48	115.7	44.64	108.8	43.15	105.1	41.09	102.0	39.22	95.2	37.30
	-13.7	-15	122.5	43.05	115.7	42.18	108.8	40.76	105.1	38.82	102.0	37.11	95.2	35.25
	-11.8	-13	122.5	41.49	115.7	40.61	108.8	39.24	105.1	37.38	102.0	35.76	95.2	33.96
	-9.8	-11	122.5	39.87	115.7	38.97	108.8	37.66	105.1	35.87	102.0	34.35	95.2	32.60
	-9.5	-10	122.5	39.62	115.7	38.72	108.8	37.42	105.1	35.65	102.0	34.14	95.2	32.40
	-8.5	-9.1	122.5	38.81	115.7	37.90	108.8	36.62	105.1	34.89	102.0	33.44	95.2	31.71
	-7.0	-7.6	122.5	37.59	115.7	36.67	108.8	35.43	105.1	33.76	102.0	32.38	95.2	30.69
	-5.0	-5.6	122.5	35.96	115.7	35.02	108.8	33.84	105.1	32.25	102.0	30.96	95.2	29.33
	-3.0	-3.7	122.5	34.34	115.7	33.37	108.8	32.25	105.1	30.74	102.0	29.55	95.2	27.96
	0.0	-0.7	122.5	31.89	115.7	30.91	108.8	29.87	105.1	28.48	102.0	27.44	95.2	25.92
	3.0	2.2	122.5	29.45	115.7	28.43	108.8	27.47	105.1	26.22	102.0	25.32	95.2	23.87
	5.0	4.1	122.5	25.70	113.3	24.22	106.6	23.41	103.0	22.31	99.9	21.59	93.3	20.34
	7.0	6.0	122.6	24.48	110.4	22.37	103.9	21.63	100.3	20.65	97.4	20.02	90.9	18.83
	9.0	7.9	118.2	21.05	106.4	19.23	100.1	18.59	96.7	17.75	93.8	17.20	87.5	16.18
	11.0	9.8	111.7	18.52	100.7	16.92	94.6	16.36	91.4	15.62	88.8	15.15	82.8	14.24
	13.0	11.8	104.9	16.08	94.6	14.71	88.9	14.21	85.8	13.57	83.3	13.16	77.7	12.37
15.0	13.7	99.2	14.18	89.3	12.95	84.2	12.53	81.2	11.95	78.9	11.60	73.6	10.90	
60	-24.8	-25	93.5	44.21	93.5	44.96	92.9	46.08	90.2	43.69	87.1	41.45	81.5	39.34
	-21.8	-22	100.4	45.33	99.5	46.08	93.3	43.69	90.2	41.45	87.1	39.34	81.5	37.31
	-19.8	-20	105.1	46.08	99.5	44.39	93.3	42.10	90.2	39.96	87.1	37.94	81.5	35.96
	-18.8	-19	105.1	45.24	99.5	43.55	93.3	41.29	90.2	39.20	87.1	37.24	81.5	35.27
	-16.7	-17	105.1	43.44	99.5	41.77	93.3	39.63	90.2	37.64	87.1	35.77	81.5	33.85
	-13.7	-15	105.1	40.87	99.5	39.24	93.3	37.24	90.2	35.40	87.1	33.66	81.5	31.82
	-11.8	-13	105.1	39.26	99.5	37.64	93.3	35.72	90.2	33.98	87.1	32.33	81.5	30.54
	-9.8	-11	105.1	37.56	99.5	35.95	93.3	34.13	90.2	32.49	87.1	30.92	81.5	29.17
	-9.5	-10	105.1	37.30	99.5	35.70	93.3	33.89	90.2	32.26	87.1	30.71	81.5	28.97
	-8.5	-9.1	105.1	36.45	99.5	34.86	93.3	33.10	90.2	31.52	87.1	30.00	81.5	28.30
	-7.0	-7.6	105.1	35.18	99.5	33.59	93.3	31.90	90.2	30.39	87.1	28.95	81.5	27.28
	-5.0	-5.6	105.1	33.46	99.5	31.90	93.3	30.31	90.2	28.90	87.1	27.56	81.5	25.92
	-3.0	-3.7	105.1	31.76	99.5	30.21	93.3	28.71	90.2	27.41	87.1	26.15	81.5	24.56
	0.0	-0.7	105.1	29.20	99.5	27.67	93.3	26.33	90.2	25.16	87.1	24.04	81.5	22.53
	3.0	2.2	105.1	26.64	99.5	25.14	93.3	23.93	90.2	22.93	87.1	21.94	81.5	20.49
	5.0	4.1	103.0	22.58	97.5	21.22	91.4	20.20	88.4	19.38	85.3	18.56	79.8	17.31
	7.0	6.0	100.3	20.67	95.0	19.37	89.2	18.47	86.1	17.75	83.2	17.02	77.8	15.83
	9.0	7.9	96.7	17.59	91.5	16.47	85.8	15.70	83.0	15.09	80.1	14.48	75.0	13.46
	11.0	9.8	91.4	15.48	86.5	14.50	81.1	13.82	78.4	13.28	75.7	12.74	70.9	11.84
	13.0	11.8	85.8	13.43	81.4	12.58	76.2	11.99	73.6	11.53	71.1	11.06	66.6	10.29
15.0	13.7	81.2	11.95	76.9	11.19	72.2	10.56	69.8	10.16	67.3	9.75	63.0	9.15	
50	-24.8	-25	87.7	39.13	82.7	40.25	77.7	38.11	75.2	36.10	72.7	34.22	67.7	32.46
	-21.8	-22	87.7	40.25	82.7	38.11	77.7	36.10	75.2	34.22	72.7	32.46	67.7	30.77
	-19.8	-20	87.7	38.76	82.7	36.68	77.7	34.78	75.2	32.95	72.7	31.28	67.7	29.63
	-18.8	-19	87.7	38.01	82.7	35.96	77.7	34.11	75.2	32.33	72.7	30.69	67.7	29.07
	-16.7	-17	87.7	36.44	82.7	34.47	77.7	32.71	75.2	31.00	72.7	29.46	67.7	27.89
	-13.7	-15	87.7	34.21	82.7	32.32	77.7	30.71	75.2	29.11	72.7	27.70	67.7	26.20
	-11.8	-13	87.7	32.79	82.7	30.97	77.7	29.44	75.2	27.91	72.7	26.59	67.7	25.12
	-9.8	-11	87.7	31.29	82.7	29.54	77.7	28.10	75.2	26.65	72.7	25.41	67.7	23.99
	-9.5	-10	87.7	31.07	82.7	29.33	77.7	27.91	75.2	26.46	72.7	25.25	67.7	23.82
	-8.5	-9.1	87.7	30.31	82.7	28.61	77.7	27.24	75.2	25.83	72.7	24.66	67.7	23.26
	-7.0	-7.6	87.7	29.20	82.7	27.55	77.7	26.24	75.2	24.89	72.7	23.78	67.7	22.42
	-5.0	-5.6	87.7	27.70	82.7	26.12	77.7	24.91	75.2	23.62	72.7	22.60	67.7	21.29
	-3.0	-3.7	87.7	26.20	82.7	24.69	77.7	23.56	75.2	22.36	72.7	21.42	67.7	20.16
	0.0	-0.7	87.7	23.97	82.7	22.54	77.7	21.57	75.2	20.47	72.7	19.66	67.7	18.46
	3.0	2.2	87.7	21.74	82.7	20.41	77.7	19.57	75.2	18.57	72.7	17.91	67.7	16.77
	5.0	4.1	86.0	18.32	81.1	17.16	76.1	16.49	73.7	15.67	71.3	15.13	66.5	14.15
	7.0	6.0	83.7	16.69	79.0	15.62	74.3	15.05	71.9	14.29	69.5	13.85	64.8	12.91
	9.0	7.9	80.7	14.33	76.1	13.42	71.5	12.93	69.2	12.29	66.9	11.91	62.4	11.10
	11.0	9.8	76.7	12.77	72.3	11.95	67.9	11.51	65.4	10.93	63.3	10.59	59.1	9.88
	13.0	11.8	71.6	10.96	67.6	10.26	63.5	9.88	61.5	9.45	59.5	9.10	55.3	8.54
15.0	13.7	67.7	9.78	64.0	9.15	60.1	8.81	58.2	8.38	56.3	8.11	52.4	7.56	

**Note**

1. TC: Total Capacity(kW), PI : Power Input(kW, Comp. + Outdoor fan motor)
2. Capacity tables show the average value of conditions which may occur.
3. The heating capacity table is based on the values expressed as Max. in the specification of the outdoor unit. (When measuring the Max. heating capacity, the setting status of the indoor unit is the same as that for measuring the heating capacity of the indoor unit.)

# 7. Capacity Tables

## ◆ ARUM520LTE5

Heating Capacity (52HP)

Combination (%)	Outdoor air temp.		Indoor air temp. °C DB											
			16		18		20		21		22		24	
	°C DB	°C WB	TC	PI	TC	PI	TC	PI	TC	PI	TC	PI	TC	PI
130	-24.8	-25	98.0	52.0	98.0	52.65	97.4	53.26	97.4	54.18	97.4	55.07	96.5	56.48
	-21.8	-22	119.6	53.35	119.6	54.04	118.8	54.65	118.8	55.58	118.8	56.48	117.6	57.86
	-19.8	-20	126.3	54.27	126.3	54.98	125.5	55.58	125.5	56.51	125.5	57.39	124.3	58.79
	-18.8	-19	129.4	54.75	129.4	55.44	128.6	56.05	128.6	56.98	128.6	57.86	127.3	59.26
	-16.7	-17	135.7	55.72	135.7	56.42	134.9	57.03	134.9	57.95	134.9	58.84	133.5	60.23
	-13.7	-15	144.7	57.12	144.7	57.82	143.8	58.43	143.8	59.35	143.8	60.23	142.3	57.95
	-11.8	-13	149.5	58.01	149.5	58.70	148.6	59.31	148.6	60.23	148.6	58.71	147.6	56.51
	-9.8	-11	154.6	58.93	154.6	59.63	153.6	60.23	153.6	58.61	153.6	57.09	152.9	54.99
	-9.5	-10	155.7	59.08	155.7	59.77	154.8	59.99	154.8	58.35	154.3	56.85	153.7	54.75
	-8.5	-9.1	159.9	59.54	159.9	60.23	159.0	59.15	159.0	57.53	156.9	56.03	156.4	53.98
	-7.0	-7.6	166.3	60.23	166.3	59.01	165.1	57.90	165.1	56.30	165.1	54.81	162.2	52.85
	-5.0	-5.6	174.7	58.66	174.7	57.37	173.5	56.21	173.5	54.66	173.5	53.20	168.0	51.32
	-3.0	-3.7	183.1	57.07	183.1	55.74	181.9	54.54	181.9	53.01	181.9	51.58	173.9	49.79
	0.0	-0.7	195.6	54.68	195.6	53.28	194.3	52.03	193.2	50.55	191.0	49.15	182.6	47.51
	3.0	2.2	202.7	52.30	202.7	50.81	201.6	49.51	200.0	48.10	196.3	46.71	183.5	45.23
	5.0	4.1	203.1	46.08	202.6	44.63	201.6	43.36	198.9	42.05	193.1	40.78	179.8	39.46
	7.0	6.0	200.5	43.71	200.1	42.31	199.2	41.08	195.1	39.89	188.2	38.69	175.2	37.54
	9.0	7.9	193.5	40.68	193.1	39.36	192.6	38.21	187.9	37.10	181.3	36.00	168.8	34.93
	11.0	9.8	183.1	38.12	182.7	36.90	182.2	35.82	177.6	34.78	171.5	33.75	159.6	32.73
13.0	11.8	171.9	35.05	171.6	33.92	171.1	32.93	166.8	31.97	161.0	31.03	149.9	30.09	
15.0	13.7	162.7	32.48	162.4	31.43	161.8	30.52	157.9	29.63	152.3	28.75	141.8	27.88	
120	-24.8	-25	97.4	52.65	97.4	53.26	96.7	54.18	96.7	55.07	96.7	56.48	95.8	57.45
	-21.8	-22	118.8	54.04	118.8	54.65	118.0	55.58	118.0	56.48	118.0	57.86	116.9	58.84
	-19.8	-20	125.5	54.98	125.5	55.58	124.6	56.51	124.6	57.39	124.6	58.79	123.4	59.77
	-18.8	-19	128.4	55.44	128.4	56.05	127.6	56.98	127.6	57.86	127.6	58.79	126.4	60.23
	-16.7	-17	134.7	56.42	134.7	57.03	133.9	57.95	133.9	58.84	133.9	60.23	132.5	58.77
	-13.7	-15	143.6	57.82	143.6	58.43	142.7	59.35	142.7	60.23	142.7	58.04	141.3	56.67
	-11.8	-13	148.4	58.70	148.4	59.31	147.5	60.23	147.5	58.68	147.5	56.65	146.5	55.34
	-9.8	-11	153.4	59.63	153.4	60.23	152.5	58.53	152.5	57.05	152.5	55.20	151.8	53.94
	-9.5	-10	154.7	59.77	154.7	59.96	153.8	58.28	153.8	56.81	153.8	54.98	153.1	53.72
	-8.5	-9.1	158.9	60.23	158.9	59.06	157.8	57.42	157.8	55.99	157.3	54.26	156.5	53.02
	-7.0	-7.6	165.1	58.89	165.1	57.71	164.1	56.14	164.1	54.77	162.0	53.15	161.0	51.97
	-5.0	-5.6	173.5	57.10	173.5	55.90	172.3	54.44	172.3	53.13	172.3	51.69	166.9	50.57
	-3.0	-3.7	181.7	55.30	181.7	54.11	180.6	52.72	180.6	51.51	179.7	50.23	171.7	49.16
	0.0	-0.7	194.2	52.61	193.7	51.40	190.3	50.16	188.3	49.05	185.2	48.04	172.3	47.06
	3.0	2.2	201.2	49.92	200.5	48.69	196.3	47.60	191.4	46.60	185.4	45.85	172.3	44.97
	5.0	4.1	201.6	43.68	199.9	42.51	194.0	41.55	187.6	40.67	181.8	40.06	168.9	39.28
	7.0	6.0	199.2	41.23	196.9	40.12	189.2	39.32	182.8	38.57	177.1	38.21	164.5	37.53
	9.0	7.9	192.2	38.26	189.6	37.22	182.2	36.49	176.1	35.79	170.6	35.44	158.6	34.81
	11.0	9.8	181.8	35.75	179.3	34.77	172.3	34.08	166.5	33.44	161.4	33.12	149.9	32.54
13.0	11.8	170.7	32.75	168.4	31.85	161.8	31.23	156.4	30.63	151.6	30.34	140.8	29.80	
15.0	13.7	161.6	30.22	159.4	29.39	153.1	28.81	148.0	28.28	143.5	28.01	133.2	27.51	
110	-24.8	-25	96.8	53.26	96.8	54.18	96.3	55.07	96.3	56.48	96.3	57.45	95.3	57.92
	-21.8	-22	118.2	54.65	118.2	55.58	117.4	56.48	117.4	57.86	117.4	58.84	116.3	59.31
	-19.8	-20	124.8	55.58	124.8	56.51	124.0	57.39	124.0	58.79	124.0	59.77	122.7	60.23
	-18.8	-19	127.7	56.05	127.7	56.98	126.9	57.86	126.9	59.26	126.9	60.23	125.7	59.46
	-16.7	-17	134.0	57.03	134.0	57.95	133.2	58.84	133.2	60.23	133.2	58.65	131.8	57.82
	-13.7	-15	142.9	58.43	142.9	59.35	141.9	60.23	141.9	57.83	141.9	56.37	141.9	55.50
	-11.8	-13	147.6	59.31	147.6	60.23	146.7	58.54	146.7	56.30	146.7	54.92	146.7	54.02
	-9.8	-11	152.6	60.23	152.6	58.32	151.7	56.76	151.7	54.70	151.7	53.41	151.4	52.47
	-9.5	-10	153.8	59.92	153.8	58.02	153.0	56.47	153.0	54.45	153.0	53.19	152.7	52.23
	-8.5	-9.1	158.0	58.90	158.0	57.07	157.0	55.58	157.0	53.65	156.7	52.42	154.5	51.45
	-7.0	-7.6	164.2	57.33	164.2	55.63	163.2	54.24	163.2	52.44	161.7	51.29	155.1	50.29
	-5.0	-5.6	172.5	55.26	172.5	53.70	171.3	52.45	170.3	50.84	165.1	49.77	155.1	48.73
	-3.0	-3.7	180.7	53.19	180.7	51.78	176.5	50.65	171.9	49.22	166.0	48.25	155.1	47.18
	0.0	-0.7	191.2	50.07	187.4	48.90	177.6	47.97	171.9	46.81	166.0	45.98	155.1	44.85
	3.0	2.2	197.5	46.97	189.3	46.01	177.6	45.28	171.9	44.41	166.0	43.69	155.1	42.52
	5.0	4.1	196.4	40.73	185.5	39.95	174.1	39.35	168.4	38.66	162.8	38.06	152.0	36.95
	7.0	6.0	191.3	38.11	180.9	37.54	169.7	37.12	164.2	36.66	158.6	36.20	148.1	35.07
	9.0	7.9	184.4	35.17	174.1	34.64	163.4	34.25	158.1	33.84	152.8	33.41	142.7	32.37
	11.0	9.8	174.3	32.68	164.7	32.18	154.6	31.81	149.6	31.44	144.5	31.03	134.9	30.07
13.0	11.8	163.7	29.74	154.7	29.29	145.2	28.95	140.5	28.60	135.7	28.24	126.7	27.37	
15.0	13.7	154.8	27.22	146.3	26.82	137.4	26.51	132.8	26.19	128.4	25.85	119.9	25.05	

# 7. Capacity Tables

Heating Capacity (52HP)

Combination (%)	Outdoor air temp.		Indoor air temp. °C DB											
			16		18		20		21		22		24	
	°C DB	°C WB	TC	PI	TC	PI	TC	PI	TC	PI	TC	PI	TC	PI
100	-24.8	-25	96.4	59.21	96.4	59.34	95.8	56.48	95.8	59.68	95.8	59.83	94.8	59.90
	-21.8	-22	117.5	59.41	117.5	59.55	116.9	58.27	116.9	59.89	116.9	60.87	115.6	60.11
	-19.8	-20	124.2	59.55	124.2	59.68	123.5	59.42	123.5	60.03	123.5	60.45	122.3	60.23
	-18.8	-19	127.2	59.62	126.4	59.76	126.4	59.89	126.4	60.09	126.4	60.23	125.1	59.29
	-16.7	-17	132.6	59.77	132.6	59.91	132.6	60.87	131.9	60.23	131.9	58.28	130.5	57.29
	-13.7	-15	142.2	59.97	142.2	60.10	141.3	60.23	141.3	57.40	141.3	55.47	140.0	54.43
	-11.8	-13	146.9	60.11	146.1	60.23	146.1	58.33	146.1	55.59	146.1	53.69	141.5	52.62
	-9.8	-11	151.7	60.23	151.7	58.10	151.1	56.32	151.1	53.69	150.1	51.83	141.7	50.72
	-9.5	-10	153.0	59.90	153.0	57.78	152.3	56.02	152.3	53.40	150.7	51.54	141.7	50.44
	-8.5	-9.1	157.1	58.78	157.1	56.71	156.4	55.02	157.3	52.45	152.1	50.61	141.7	49.48
	-7.0	-7.6	166.0	57.11	165.4	55.11	162.5	53.50	157.3	51.04	152.1	49.20	141.7	48.05
	-5.0	-5.6	173.3	54.87	171.5	52.98	162.5	51.50	157.3	49.13	152.1	47.33	141.7	46.15
	-3.0	-3.7	178.3	52.64	172.9	50.84	162.5	49.50	157.3	47.23	152.1	45.47	141.7	44.24
	0.0	-0.7	183.3	49.28	172.9	47.63	162.5	46.48	157.3	44.39	152.1	42.66	141.7	41.39
	3.0	2.2	183.3	45.92	172.9	44.42	162.5	43.47	157.3	41.54	152.1	39.85	141.7	38.54
	5.0	4.1	179.6	39.67	169.5	38.34	159.2	37.54	154.2	35.84	149.1	34.31	138.9	33.09
	7.0	6.0	175.0	36.89	165.1	35.73	155.2	35.11	150.2	33.59	145.3	32.14	135.4	30.91
	9.0	7.9	168.6	33.78	159.0	32.71	149.6	32.14	144.8	30.75	140.0	29.41	130.3	28.29
	11.0	9.8	159.5	31.08	150.5	30.09	141.3	29.57	136.8	28.29	132.3	27.07	123.3	26.03
	13.0	11.8	149.7	27.96	141.3	27.08	132.8	26.61	128.6	25.46	124.2	24.36	115.7	23.42
15.0	13.7	141.7	25.27	133.7	24.48	125.6	24.05	121.6	23.00	117.6	22.01	109.6	21.17	
90	-24.8	-25	96.0	52.54	96.0	53.93	95.4	54.92	95.4	55.37	95.4	56.31	94.5	57.71
	-21.8	-22	117.1	53.93	117.1	55.33	116.5	56.31	116.5	56.77	116.5	57.71	115.2	55.24
	-19.8	-20	123.8	54.87	123.8	56.26	122.9	57.23	122.9	57.71	122.9	56.02	121.7	53.60
	-18.8	-19	127.2	55.33	126.4	56.73	125.9	57.71	125.9	56.84	125.9	55.18	124.7	52.78
	-16.7	-17	132.6	56.31	132.6	57.71	132.0	55.92	132.0	55.02	132.0	53.42	128.5	51.05
	-13.7	-15	142.2	57.71	142.2	55.04	140.9	53.36	140.9	52.43	138.3	50.89	129.5	48.58
	-11.8	-13	146.9	55.88	146.1	53.36	145.5	51.74	142.9	50.78	139.4	49.30	129.5	47.02
	-9.8	-11	151.7	53.97	151.7	51.60	147.6	50.04	144.1	49.04	139.4	47.62	129.5	45.38
	-9.5	-10	153.0	53.68	153.0	51.32	148.2	49.78	144.1	48.78	139.4	47.36	129.5	45.13
	-8.5	-9.1	157.1	52.73	156.0	50.44	148.7	48.92	144.1	47.92	139.4	46.52	129.5	44.31
	-7.0	-7.6	166.0	51.29	157.9	49.11	148.7	47.65	144.1	46.62	139.4	45.26	129.5	43.08
	-5.0	-5.6	167.8	49.37	157.9	47.34	148.7	45.95	144.1	44.90	139.4	43.58	129.5	41.44
	-3.0	-3.7	167.8	47.46	157.9	45.58	148.7	44.25	144.1	43.16	139.4	41.89	129.5	39.79
	0.0	-0.7	167.8	44.59	157.9	42.91	148.7	41.69	144.1	40.57	139.4	39.37	129.5	37.33
	3.0	2.2	167.8	41.71	157.9	40.25	148.7	39.14	144.1	37.98	139.4	36.85	129.5	34.86
	5.0	4.1	164.5	36.03	154.8	34.79	145.7	33.80	141.2	32.73	136.7	31.74	126.9	29.96
	7.0	6.0	160.3	33.72	150.9	32.67	141.9	31.80	137.6	30.72	133.2	29.80	123.8	28.10
	9.0	7.9	154.4	30.86	145.3	29.92	136.7	29.11	132.5	28.11	128.3	27.28	119.2	25.73
	11.0	9.8	146.1	28.12	137.4	27.25	129.3	26.51	125.4	25.62	121.3	24.86	112.6	23.43
	13.0	11.8	137.1	24.79	129.0	24.02	121.5	23.39	117.7	22.58	113.9	21.91	105.8	20.66
15.0	13.7	129.7	22.16	122.1	21.49	114.9	20.91	111.3	20.20	107.8	19.60	100.2	18.48	
80	-24.8	-25	95.6	46.00	95.6	47.40	95.0	48.38	95.0	48.84	95.0	51.17	94.1	49.00
	-21.8	-22	115.8	47.40	115.8	48.79	115.8	49.77	115.8	51.17	115.8	49.00	113.9	46.91
	-19.8	-20	122.5	48.33	122.5	49.72	122.5	51.17	122.5	49.64	121.8	47.55	115.7	45.53
	-18.8	-19	125.4	48.79	125.4	51.17	125.4	50.39	125.4	48.87	122.9	46.82	115.7	44.83
	-16.7	-17	130.9	51.17	130.9	49.55	130.9	48.77	128.2	47.27	124.4	45.32	115.7	43.38
	-13.7	-15	139.0	48.78	136.3	47.24	133.0	46.45	129.0	44.97	124.4	43.14	115.7	41.29
	-11.8	-13	142.5	47.26	138.3	45.78	133.0	44.97	129.0	43.52	124.4	41.77	115.7	39.97
	-9.8	-11	145.9	45.66	140.1	44.25	133.0	43.42	129.0	42.00	124.4	40.32	115.7	38.58
	-9.5	-10	146.9	45.43	140.9	44.01	133.0	43.18	129.0	41.76	124.4	40.10	115.7	38.37
	-8.5	-9.1	148.6	44.63	141.7	43.25	133.0	42.41	129.0	41.00	124.4	39.38	115.7	37.68
	-7.0	-7.6	150.3	43.43	141.7	42.09	133.0	41.25	129.0	39.85	124.4	38.31	115.7	36.63
	-5.0	-5.6	150.3	41.84	141.7	40.56	133.0	39.70	129.0	38.31	124.4	36.85	115.7	35.24
	-3.0	-3.7	150.3	40.24	141.7	39.02	133.0	38.15	129.0	36.79	124.4	35.41	115.7	33.85
	0.0	-0.7	150.3	37.84	141.7	36.72	133.0	35.83	129.0	34.50	124.4	33.23	115.7	31.77
	3.0	2.2	150.3	35.45	141.7	34.40	133.0	33.50	129.0	32.19	124.4	31.07	115.7	29.68
	5.0	4.1	147.3	30.61	138.9	29.68	130.3	28.86	126.4	27.68	121.8	26.72	113.5	25.52
	7.0	6.0	143.5	28.71	135.4	27.89	127.0	27.06	123.2	25.93	118.7	25.08	110.5	23.94
	9.0	7.9	138.3	25.53	130.3	24.82	122.4	24.21	118.7	23.28	114.4	22.45	106.5	21.39
	11.0	9.8	130.8	22.53	123.2	21.91	115.7	21.37	112.2	20.54	108.3	19.81	100.6	18.87
	13.0	11.8	122.8	19.42	115.7	18.88	108.7	18.42	105.4	17.70	101.6	17.07	94.5	16.26
15.0	13.7	116.1	17.36	109.6	16.87	102.8	16.45	99.7	15.82	96.2	15.26	89.4	14.54	



# 7. Capacity Tables

Heating Capacity (52HP)

Combination (%)	Outdoor air temp.		Indoor air temp. °C DB													
			16		18		20		21		22		24			
	°C DB	°C WB	TC	PI	TC	PI	TC	PI	TC	PI	TC	PI	TC	PI		
70	-24.8	-25	95.6	46.83	95.6	47.29	95.0	48.23	95.0	49.63	95.0	47.29	95.0	47.29	94.0	45.10
	-21.8	-22	112.7	48.23	113.0	48.69	112.2	49.63	109.3	47.29	106.1	45.10	99.0	42.99		
	-19.8	-20	122.1	49.16	119.2	49.63	113.2	47.99	109.3	45.74	106.1	43.65	99.0	41.59		
	-18.8	-19	124.8	49.63	120.1	48.78	113.2	47.17	109.3	44.95	106.1	42.92	99.0	40.87		
	-16.7	-17	127.1	47.87	120.3	47.00	113.2	45.46	109.3	43.32	106.1	41.39	99.0	39.40		
	-13.7	-15	127.4	45.37	120.3	44.47	113.2	43.00	109.3	40.99	106.1	39.21	99.0	37.28		
	-11.8	-13	127.4	43.77	120.3	42.86	113.2	41.44	109.3	39.50	106.1	37.82	99.0	35.94		
	-9.8	-11	127.4	42.11	120.3	41.17	113.2	39.81	109.3	37.94	106.1	36.36	99.0	34.53		
	-9.5	-10	127.4	41.86	120.3	40.91	113.2	39.57	109.3	37.72	106.1	36.15	99.0	34.32		
	-8.5	-9.1	127.4	41.03	120.3	40.07	113.2	38.74	109.3	36.94	106.1	35.42	99.0	33.61		
	-7.0	-7.6	127.4	39.77	120.3	38.81	113.2	37.52	109.3	35.77	106.1	34.33	99.0	32.56		
	-5.0	-5.6	127.4	38.10	120.3	37.12	113.2	35.88	109.3	34.22	106.1	32.87	99.0	31.15		
	-3.0	-3.7	127.4	36.44	120.3	35.42	113.2	34.24	109.3	32.66	106.1	31.41	99.0	29.73		
	0.0	-0.7	127.4	33.94	120.3	32.89	113.2	31.79	109.3	30.32	106.1	29.23	99.0	27.62		
	3.0	2.2	127.4	31.43	120.3	30.35	113.2	29.33	109.3	28.00	106.1	27.04	99.0	25.50		
	5.0	4.1	127.4	27.50	117.9	25.91	110.9	25.03	107.1	23.87	104.0	23.10	97.1	21.76		
	7.0	6.0	127.6	26.26	114.8	24.00	108.1	23.19	104.4	22.15	101.3	21.48	94.5	20.19		
	9.0	7.9	122.9	22.60	110.7	20.65	104.1	19.96	100.6	19.05	97.6	18.47	91.0	17.37		
11.0	9.8	116.3	19.91	104.8	18.19	98.5	17.59	95.1	16.79	92.3	16.29	86.1	15.31			
13.0	11.8	109.2	17.31	98.4	15.83	92.5	15.30	89.3	14.60	86.7	14.16	80.9	13.31			
15.0	13.7	103.2	15.29	93.0	13.97	87.5	13.51	84.5	12.89	82.0	12.50	76.5	11.75			
60	-24.8	-25	95.0	45.89	95.0	46.83	94.4	48.23	92.5	45.78	90.3	43.48	84.8	41.31		
	-21.8	-22	103.5	47.29	103.5	48.23	97.1	45.78	93.8	43.48	90.6	41.31	84.8	39.22		
	-19.8	-20	109.3	48.23	103.5	46.50	97.1	44.14	93.8	41.95	90.6	39.86	84.8	37.82		
	-18.8	-19	109.3	47.36	103.5	45.63	97.1	43.32	93.8	41.17	90.6	39.14	84.8	37.11		
	-16.7	-17	109.3	45.53	103.5	43.81	97.1	41.61	93.8	39.56	90.6	37.63	84.8	35.64		
	-13.7	-15	109.3	42.91	103.5	41.23	97.1	39.16	93.8	37.26	90.6	35.47	84.8	33.55		
	-11.8	-13	109.3	41.27	103.5	39.58	97.1	37.60	93.8	35.80	90.6	34.10	84.8	32.23		
	-9.8	-11	109.3	39.53	103.5	37.86	97.1	35.97	93.8	34.27	90.6	32.65	84.8	30.82		
	-9.5	-10	109.3	39.26	103.5	37.61	97.1	35.73	93.8	34.04	90.6	32.43	84.8	30.61		
	-8.5	-9.1	109.3	38.40	103.5	36.74	97.1	34.91	93.8	33.28	90.6	31.70	84.8	29.92		
	-7.0	-7.6	109.3	37.10	103.5	35.44	97.1	33.69	93.8	32.12	90.6	30.62	84.8	28.87		
	-5.0	-5.6	109.3	35.36	103.5	33.71	97.1	32.05	93.8	30.59	90.6	29.18	84.8	27.47		
	-3.0	-3.7	109.3	33.62	103.5	31.98	97.1	30.42	93.8	29.06	90.6	27.74	84.8	26.07		
	0.0	-0.7	109.3	31.01	103.5	29.39	97.1	27.98	93.8	26.75	90.6	25.57	84.8	23.97		
	3.0	2.2	109.3	28.40	103.5	26.80	97.1	25.52	93.8	24.46	90.6	23.41	84.8	21.87		
	5.0	4.1	107.1	24.13	101.5	22.68	95.1	21.59	91.9	20.72	88.7	19.85	83.1	18.51		
	7.0	6.0	104.4	22.18	98.9	20.78	92.7	19.81	89.6	19.04	86.5	18.26	80.9	16.98		
	9.0	7.9	100.6	18.89	95.2	17.68	89.3	16.86	86.4	16.20	83.3	15.55	78.0	14.45		
11.0	9.8	95.1	16.64	90.0	15.58	84.4	14.85	81.6	14.28	78.7	13.69	73.8	12.73			
13.0	11.8	89.3	14.46	84.6	13.55	79.3	12.90	76.6	12.41	74.0	11.90	69.3	11.08			
15.0	13.7	84.5	12.89	80.0	12.06	75.1	11.39	72.6	10.96	70.0	10.51	65.5	9.86			
50	-24.8	-25	91.2	41.08	86.0	42.48	80.9	40.25	78.3	38.16	75.7	36.18	70.5	34.35		
	-21.8	-22	91.2	42.48	86.0	40.25	80.9	38.16	78.3	36.18	75.7	34.35	70.5	32.58		
	-19.8	-20	91.2	40.92	86.0	38.76	80.9	36.77	78.3	34.86	75.7	33.12	70.5	31.39		
	-18.8	-19	91.2	40.15	86.0	38.01	80.9	36.08	78.3	34.21	75.7	32.50	70.5	30.80		
	-16.7	-17	91.2	38.52	86.0	36.46	80.9	34.62	78.3	32.83	75.7	31.22	70.5	29.56		
	-13.7	-15	91.2	36.19	86.0	34.22	80.9	32.53	78.3	30.85	75.7	29.38	70.5	27.79		
	-11.8	-13	91.2	34.72	86.0	32.81	80.9	31.20	78.3	29.60	75.7	28.22	70.5	26.67		
	-9.8	-11	91.2	33.16	86.0	31.32	80.9	29.81	78.3	28.28	75.7	26.99	70.5	25.48		
	-9.5	-10	91.2	32.93	86.0	31.10	80.9	29.61	78.3	28.09	75.7	26.81	70.5	25.31		
	-8.5	-9.1	91.2	32.14	86.0	30.35	80.9	28.91	78.3	27.43	75.7	26.20	70.5	24.72		
	-7.0	-7.6	91.2	30.98	86.0	29.25	80.9	27.87	78.3	26.45	75.7	25.28	70.5	23.84		
	-5.0	-5.6	91.2	29.42	86.0	27.76	80.9	26.48	78.3	25.12	75.7	24.04	70.5	22.66		
	-3.0	-3.7	91.2	27.87	86.0	26.27	80.9	25.08	78.3	23.81	75.7	22.81	70.5	21.48		
	0.0	-0.7	91.2	25.54	86.0	24.02	80.9	23.00	78.3	21.83	75.7	20.98	70.5	19.70		
	3.0	2.2	91.2	23.22	86.0	21.80	80.9	20.91	78.3	19.85	75.7	19.14	70.5	17.93		
	5.0	4.1	89.4	19.60	84.4	18.36	79.2	17.65	76.7	16.77	74.2	16.19	69.1	15.15		
	7.0	6.0	87.1	17.90	82.2	16.75	77.3	16.14	74.8	15.32	72.3	14.86	67.4	13.85		
	9.0	7.9	83.9	15.39	79.2	14.41	74.4	13.88	72.0	13.19	69.6	12.78	64.9	11.92		
11.0	9.8	79.8	13.72	75.2	12.84	70.6	12.37	68.0	11.75	65.8	11.38	61.4	10.62			
13.0	11.8	74.5	11.80	70.3	11.05	66.1	10.64	63.9	10.17	61.9	9.80	57.6	9.20			
15.0	13.7	70.5	10.54	66.5	9.87	62.5	9.50	60.6	9.04	58.5	8.75	54.5	8.16			

**Note**

1. TC: Total Capacity(kW), PI : Power Input(kW, Comp. + Outdoor fan motor)
2. Capacity tables show the average value of conditions which may occur.
3. The heating capacity table is based on the values expressed as Max. in the specification of the outdoor unit. (When measuring the Max. heating capacity, the setting status of the indoor unit is the same as that for measuring the heating capacity of the indoor unit.)

# 7. Capacity Tables

## ◆ ARUM540LTE5

Heating Capacity (54HP)

Combination (%)	Outdoor air temp.		Indoor air temp. °C DB											
			16		18		20		21		22		24	
	°C DB	°C WB	TC	PI	TC	PI	TC	PI	TC	PI	TC	PI	TC	PI
130	-24.8	-25	106.6	54.8	106.6	55.30	105.9	55.77	105.9	56.47	105.9	57.17	104.3	58.25
	-21.8	-22	128.6	55.84	128.6	56.37	127.7	56.84	127.7	57.55	127.7	58.25	125.7	59.31
	-19.8	-20	135.1	56.55	135.1	57.09	134.2	57.55	134.2	58.28	134.2	58.95	132.1	60.03
	-18.8	-19	138.1	56.91	138.1	57.45	137.2	57.92	137.2	58.63	137.2	59.31	135.0	60.39
	-16.7	-17	144.3	57.67	144.3	58.20	143.3	58.67	143.3	59.38	143.3	60.07	141.0	61.14
	-13.7	-15	153.1	58.74	153.1	59.28	152.1	59.75	152.1	60.46	152.1	61.14	149.7	58.68
	-11.8	-13	158.0	59.43	158.0	59.95	157.1	60.42	157.1	61.14	157.1	59.48	155.1	57.12
	-9.8	-11	163.3	60.13	163.3	60.68	162.3	61.14	162.3	59.36	162.3	57.73	160.6	55.49
	-9.5	-10	164.2	60.26	164.2	60.78	163.3	60.87	163.3	59.08	163.0	57.47	161.5	55.23
	-8.5	-9.1	167.6	60.60	167.6	61.14	166.7	59.94	166.7	58.19	165.7	56.59	164.2	54.41
	-7.0	-7.6	172.7	61.14	172.7	59.77	171.6	58.56	171.6	56.84	171.6	55.26	169.0	53.18
	-5.0	-5.6	179.5	59.35	179.5	57.95	178.3	56.71	178.3	55.05	178.3	53.51	174.6	51.54
	-3.0	-3.7	186.2	57.55	186.2	56.13	185.0	54.86	185.0	53.25	185.0	51.76	180.4	49.90
	0.0	-0.7	196.2	54.85	196.2	53.39	195.0	52.10	195.0	50.57	195.0	49.13	188.8	47.44
	3.0	2.2	206.4	52.16	206.4	50.64	205.0	49.32	205.0	47.88	203.5	46.48	190.6	44.98
	5.0	4.1	208.7	45.78	208.3	44.32	207.1	43.05	205.9	41.74	200.6	40.46	186.7	39.14
	7.0	6.0	208.1	43.21	207.7	41.83	206.5	40.61	202.6	39.43	195.5	38.25	182.0	37.11
	9.0	7.9	201.1	40.02	200.6	38.72	200.1	37.59	195.1	36.50	188.4	35.41	175.4	34.36
11.0	9.8	190.2	37.29	189.8	36.10	189.3	35.04	184.5	34.02	178.1	33.02	165.8	32.02	
13.0	11.8	178.6	34.07	178.3	32.97	177.7	32.01	173.3	31.08	167.3	30.16	155.7	29.24	
15.0	13.7	169.0	31.34	168.6	30.32	168.1	29.45	164.0	28.59	158.3	27.74	147.3	26.90	
120	-24.8	-25	105.9	55.30	105.9	55.77	105.2	56.47	105.2	57.17	105.2	58.25	103.6	59.00
	-21.8	-22	127.7	56.37	127.7	56.84	126.8	57.55	126.8	58.25	126.8	59.31	124.9	60.07
	-19.8	-20	134.1	57.09	134.1	57.55	133.2	58.28	133.2	58.95	133.2	60.03	131.2	60.78
	-18.8	-19	137.0	57.45	137.0	57.92	136.1	58.63	136.1	59.31	136.1	60.39	134.1	61.14
	-16.7	-17	143.2	58.20	143.2	58.67	142.3	59.38	142.3	60.07	142.3	61.14	140.0	59.56
	-13.7	-15	151.9	59.28	151.9	59.75	151.0	60.46	151.0	61.14	151.0	58.77	148.6	57.30
	-11.8	-13	156.9	59.95	156.9	60.42	155.9	61.14	155.9	59.46	155.9	57.27	154.0	55.87
	-9.8	-11	162.1	60.68	162.1	61.14	161.2	59.28	161.2	57.69	161.2	55.69	159.5	54.36
	-9.5	-10	163.1	60.78	163.1	60.84	162.2	59.01	162.2	57.43	162.2	55.46	160.5	54.13
	-8.5	-9.1	166.5	61.14	166.5	59.85	165.4	58.07	165.4	56.54	165.2	54.68	163.4	53.38
	-7.0	-7.6	171.5	59.66	171.5	58.38	170.4	56.69	170.4	55.22	169.8	53.49	167.8	52.24
	-5.0	-5.6	178.2	57.68	178.2	56.40	177.1	54.83	177.1	53.44	177.1	51.90	173.5	50.73
	-3.0	-3.7	184.9	55.70	184.9	54.44	183.7	52.96	183.7	51.69	183.7	50.33	178.2	49.22
	0.0	-0.7	194.9	52.73	194.9	51.47	193.6	50.18	193.6	49.03	192.4	47.96	179.0	46.96
	3.0	2.2	204.9	49.76	204.9	48.51	202.7	47.40	198.8	46.38	192.6	45.59	179.0	44.70
	5.0	4.1	207.3	43.39	206.2	42.21	201.5	41.24	194.9	40.36	188.8	39.74	175.4	38.96
	7.0	6.0	206.8	40.76	204.5	39.66	196.5	38.87	189.9	38.13	184.0	37.77	170.9	37.10
	9.0	7.9	199.7	37.65	197.0	36.62	189.3	35.90	182.9	35.21	177.2	34.87	164.7	34.25
11.0	9.8	188.8	35.00	186.3	34.04	179.0	33.36	172.9	32.73	167.6	32.42	155.7	31.85	
13.0	11.8	177.4	31.86	175.0	30.99	168.1	30.38	162.5	29.80	157.5	29.52	146.2	28.99	
15.0	13.7	167.9	29.20	165.6	28.40	159.0	27.84	153.7	27.32	149.0	27.06	138.4	26.57	
110	-24.8	-25	105.3	55.77	105.3	56.47	104.7	57.17	104.7	58.25	104.7	59.00	103.0	59.35
	-21.8	-22	127.1	56.84	127.1	57.55	126.2	58.25	126.2	59.31	126.2	60.07	124.3	60.42
	-19.8	-20	133.4	57.55	133.4	58.28	132.6	58.95	132.6	60.03	132.6	60.78	130.4	61.14
	-18.8	-19	136.3	57.92	136.3	58.63	135.4	59.31	135.4	60.39	135.4	61.14	133.3	60.31
	-16.7	-17	142.4	58.67	142.4	59.38	141.5	60.07	141.5	61.14	141.5	59.44	139.2	58.57
	-13.7	-15	151.1	59.75	151.1	60.46	150.1	61.14	150.1	58.56	150.1	57.00	150.1	56.09
	-11.8	-13	156.1	60.42	156.1	61.14	155.0	59.31	155.0	56.92	155.0	55.46	155.0	54.52
	-9.8	-11	161.2	61.14	161.2	59.08	160.3	57.40	160.3	55.20	160.3	53.84	159.3	52.87
	-9.5	-10	162.2	60.80	162.2	58.76	161.3	57.10	161.3	54.94	161.3	53.60	160.8	52.62
	-8.5	-9.1	165.6	59.69	165.6	57.73	164.6	56.14	164.6	54.07	164.6	52.77	161.1	51.78
	-7.0	-7.6	170.6	58.00	170.6	56.18	169.5	54.70	169.5	52.78	169.5	51.57	161.1	50.55
	-5.0	-5.6	177.2	55.77	177.2	54.10	176.0	52.78	176.0	51.06	172.4	49.94	161.1	48.88
	-3.0	-3.7	183.8	53.53	183.8	52.04	182.6	50.84	178.6	49.33	172.4	48.31	161.1	47.24
	0.0	-0.7	193.8	50.17	193.4	48.94	184.5	47.96	178.6	46.75	172.4	45.89	161.1	44.76
	3.0	2.2	203.3	46.81	196.7	45.83	184.5	45.07	178.6	44.18	172.4	43.44	161.1	42.27
	5.0	4.1	204.0	40.46	192.7	39.66	180.9	39.05	175.0	38.35	169.1	37.75	157.9	36.65
	7.0	6.0	198.7	37.67	187.9	37.11	176.3	36.69	170.6	36.25	164.7	35.78	153.9	34.67
	9.0	7.9	191.5	34.61	180.9	34.09	169.7	33.71	164.3	33.30	158.7	32.88	148.2	31.86
11.0	9.8	181.0	31.99	171.1	31.51	160.6	31.15	155.4	30.78	151.0	30.38	140.2	29.44	
13.0	11.8	170.0	28.95	160.7	28.50	150.9	28.18	145.9	27.83	140.9	27.48	131.6	26.64	
15.0	13.7	160.8	26.31	152.0	25.92	142.7	25.62	138.0	25.32	133.4	24.99	124.5	24.21	

# 7. Capacity Tables

## Heating Capacity (54HP)

Combination (%)	Outdoor air temp.		Indoor air temp. °C DB											
			16		18		20		21		22		24	
	°C DB	°C WB	TC	PI	TC	PI	TC	PI	TC	PI	TC	PI	TC	PI
100	-24.8	-25	104.8	60.85	104.8	60.89	104.2	57.70	104.2	60.98	104.2	61.03	102.5	61.05
	-21.8	-22	126.4	60.91	126.4	60.95	125.7	59.53	125.7	61.04	125.7	61.79	123.6	61.11
	-19.8	-20	132.8	60.95	132.8	60.98	132.0	60.68	132.0	61.08	132.0	61.36	130.0	61.14
	-18.8	-19	135.7	60.97	134.9	61.01	134.9	61.04	134.9	61.09	134.9	61.14	132.7	60.14
	-16.7	-17	140.9	61.01	140.9	61.05	140.9	61.79	140.2	61.14	140.2	59.07	137.9	58.05
	-13.7	-15	150.4	61.07	150.4	61.10	149.5	61.14	149.5	58.13	149.5	56.12	147.2	55.04
	-11.8	-13	155.3	61.11	154.4	61.14	154.4	59.11	154.4	56.21	154.4	54.23	147.2	53.14
	-9.8	-11	160.3	61.14	160.3	58.86	159.7	56.97	159.7	54.21	158.0	52.27	147.2	51.14
	-9.5	-10	161.3	60.78	161.3	58.51	160.6	56.65	160.6	53.90	158.0	51.97	147.2	50.84
	-8.5	-9.1	164.7	59.58	164.7	57.38	163.9	55.58	163.4	52.89	158.0	50.98	147.2	49.84
	-7.0	-7.6	172.4	57.78	171.8	55.66	168.8	53.97	163.4	51.40	158.0	49.51	147.2	48.33
	-5.0	-5.6	180.0	55.38	178.2	53.39	168.8	51.84	163.4	49.38	158.0	47.53	147.2	46.33
	-3.0	-3.7	185.2	52.98	179.6	51.10	168.8	49.70	163.4	47.36	158.0	45.57	147.2	44.33
	0.0	-0.7	190.4	49.39	179.6	47.68	168.8	46.49	163.4	44.35	158.0	42.60	147.2	41.33
	3.0	2.2	190.4	45.78	179.6	44.25	168.8	43.28	163.4	41.34	158.0	39.65	147.2	38.33
	5.0	4.1	186.6	39.41	176.0	38.07	165.4	37.26	160.2	35.57	154.9	34.04	144.3	32.83
	7.0	6.0	181.8	36.47	171.5	35.32	161.2	34.71	156.0	33.21	150.9	31.78	140.6	30.56
	9.0	7.9	175.1	33.15	165.2	32.10	155.4	31.55	150.4	30.18	145.4	28.87	135.4	27.76
	11.0	9.8	165.6	30.24	156.3	29.28	146.8	28.78	142.2	27.53	137.5	26.34	128.1	25.33
	13.0	11.8	155.6	26.93	146.8	26.08	137.9	25.63	133.5	24.53	129.1	23.46	120.2	22.56
15.0	13.7	147.2	24.05	138.8	23.29	130.4	22.88	126.3	21.89	122.1	20.95	113.8	20.15	
90	-24.8	-25	104.4	54.61	104.4	55.68	103.8	56.44	103.8	56.79	103.8	57.51	102.2	58.59
	-21.8	-22	125.9	55.68	125.9	56.76	125.2	57.51	125.2	57.87	125.2	58.59	123.1	56.00
	-19.8	-20	132.3	56.40	132.3	57.47	131.4	58.22	131.4	58.59	131.4	56.81	129.4	54.28
	-18.8	-19	135.7	56.76	134.9	57.84	134.3	58.59	134.3	57.68	134.3	55.93	132.2	53.43
	-16.7	-17	140.9	57.51	140.9	58.59	140.3	56.69	140.3	55.75	140.3	54.08	134.5	51.62
	-13.7	-15	150.4	58.59	150.4	55.76	149.0	53.99	149.0	53.02	144.9	51.42	134.5	49.03
	-11.8	-13	155.3	56.64	154.4	53.97	153.8	52.27	149.7	51.28	144.9	49.74	134.5	47.40
	-9.8	-11	160.3	54.61	160.3	52.10	154.5	50.47	149.7	49.45	144.9	47.97	134.5	45.68
	-9.5	-10	161.3	54.29	161.3	51.81	154.5	50.20	149.7	49.18	144.9	47.70	134.5	45.42
	-8.5	-9.1	164.7	53.28	163.5	50.88	154.5	49.29	149.7	48.26	144.9	46.82	134.5	44.55
	-7.0	-7.6	172.4	51.74	164.0	49.46	154.5	47.94	149.7	46.89	144.9	45.49	134.5	43.26
	-5.0	-5.6	174.3	49.70	164.0	47.58	154.5	46.15	149.7	45.08	144.9	43.72	134.5	41.55
	-3.0	-3.7	174.3	47.66	164.0	45.71	154.5	44.34	149.7	43.24	144.9	41.94	134.5	39.82
	0.0	-0.7	174.3	44.60	164.0	42.88	154.5	41.63	149.7	40.51	144.9	39.30	134.5	37.24
	3.0	2.2	174.3	41.53	164.0	40.05	154.5	38.93	149.7	37.77	144.9	36.65	134.5	34.66
	5.0	4.1	170.9	35.77	160.8	34.52	151.3	33.53	146.7	32.48	142.0	31.48	131.8	29.71
	7.0	6.0	166.5	33.33	156.7	32.30	147.4	31.43	142.9	30.37	138.4	29.46	128.6	27.78
	9.0	7.9	160.4	30.29	150.9	29.36	142.0	28.56	137.6	27.59	133.3	26.77	123.8	25.25
	11.0	9.8	151.8	27.36	142.7	26.51	134.3	25.80	130.2	24.93	126.0	24.19	117.0	22.79
	13.0	11.8	142.4	23.87	134.0	23.14	126.2	22.53	122.3	21.75	118.3	21.10	109.9	19.90
15.0	13.7	134.8	21.09	126.8	20.44	119.4	19.89	115.7	19.22	112.0	18.64	104.0	17.58	
80	-24.8	-25	103.9	47.97	103.9	49.05	103.3	49.80	103.3	50.16	103.3	51.95	101.7	49.68
	-21.8	-22	124.6	49.05	124.6	50.12	124.6	50.87	124.6	51.95	124.6	49.68	120.2	47.50
	-19.8	-20	130.9	49.76	130.9	50.83	130.9	51.95	130.9	50.34	129.0	48.16	120.2	46.05
	-18.8	-19	133.8	50.12	133.8	51.95	133.8	51.13	133.3	49.54	129.2	47.40	120.2	45.33
	-16.7	-17	138.1	51.95	138.1	50.24	138.1	49.42	134.0	47.86	129.2	45.82	120.2	43.81
	-13.7	-15	144.4	49.42	141.6	47.80	138.1	46.97	134.0	45.44	129.2	43.54	120.2	41.63
	-11.8	-13	148.4	47.80	144.0	46.25	138.1	45.41	134.0	43.91	129.2	42.10	120.2	40.24
	-9.8	-11	152.3	46.11	145.9	44.63	138.1	43.78	134.0	42.31	129.2	40.58	120.2	38.79
	-9.5	-10	153.3	45.86	146.7	44.38	138.1	43.53	134.0	42.07	129.2	40.35	120.2	38.58
	-8.5	-9.1	154.8	45.02	147.2	43.57	138.1	42.72	134.0	41.26	129.2	39.60	120.2	37.85
	-7.0	-7.6	156.1	43.74	147.2	42.35	138.1	41.49	134.0	40.06	129.2	38.47	120.2	36.76
	-5.0	-5.6	156.1	42.05	147.2	40.73	138.1	39.86	134.0	38.44	129.2	36.94	120.2	35.31
	-3.0	-3.7	156.1	40.36	147.2	39.10	138.1	38.22	134.0	36.85	129.2	35.44	120.2	33.85
	0.0	-0.7	156.1	37.81	147.2	36.67	138.1	35.78	134.0	34.43	129.2	33.15	120.2	31.68
	3.0	2.2	156.1	35.28	147.2	34.22	138.1	33.32	134.0	32.01	129.2	30.88	120.2	29.50
	5.0	4.1	153.0	30.37	144.2	29.45	135.4	28.63	131.3	27.46	126.5	26.50	117.9	25.31
	7.0	6.0	149.1	28.38	140.6	27.57	131.9	26.75	128.0	25.64	123.3	24.79	114.8	23.67
	9.0	7.9	143.6	25.03	135.4	24.34	127.1	23.74	123.3	22.84	118.8	22.02	110.6	20.98
	11.0	9.8	135.8	21.90	128.0	21.30	120.2	20.78	116.6	19.98	112.5	19.27	104.5	18.35
	13.0	11.8	127.5	18.69	120.2	18.17	112.9	17.73	109.5	17.04	105.6	16.44	98.2	15.66
15.0	13.7	120.6	16.50	113.8	16.04	106.8	15.65	103.6	15.04	99.9	14.51	92.9	13.82	

# 7. Capacity Tables

Heating Capacity (54HP)

Combination (%)	Outdoor air temp.		Indoor air temp. °C DB											
			16		18		20		21		22		24	
	°C DB	°C WB	TC	PI	TC	PI	TC	PI	TC	PI	TC	PI	TC	PI
70	-24.8	-25	103.9	48.43	103.9	48.78	103.3	49.51	103.3	50.59	103.3	48.14	100.7	45.84
	-21.8	-22	118.4	49.51	118.4	49.86	117.6	50.59	113.6	48.14	110.2	45.84	102.8	43.63
	-19.8	-20	127.9	50.23	125.0	50.59	117.6	48.86	113.6	46.50	110.2	44.31	102.8	42.17
	-18.8	-19	130.9	50.59	125.0	49.69	117.6	47.99	113.6	45.68	110.2	43.55	102.8	41.42
	-16.7	-17	132.4	48.72	125.0	47.81	117.6	46.19	113.6	43.96	110.2	41.95	102.8	39.88
	-13.7	-15	132.4	46.08	125.0	45.14	117.6	43.60	113.6	41.51	110.2	39.66	102.8	37.67
	-11.8	-13	132.4	44.38	125.0	43.44	117.6	41.96	113.6	39.95	110.2	38.20	102.8	36.27
	-9.8	-11	132.4	42.63	125.0	41.66	117.6	40.25	113.6	38.32	110.2	36.68	102.8	34.80
	-9.5	-10	132.4	42.35	125.0	41.38	117.6	39.99	113.6	38.08	110.2	36.46	102.8	34.58
	-8.5	-9.1	132.4	41.48	125.0	40.50	117.6	39.12	113.6	37.26	110.2	35.69	102.8	33.84
	-7.0	-7.6	132.4	40.15	125.0	39.16	117.6	37.83	113.6	36.04	110.2	34.55	102.8	32.74
	-5.0	-5.6	132.4	38.38	125.0	37.38	117.6	36.11	113.6	34.40	110.2	33.01	102.8	31.26
	-3.0	-3.7	132.4	36.62	125.0	35.58	117.6	34.38	113.6	32.76	110.2	31.49	102.8	29.79
	0.0	-0.7	132.4	33.96	125.0	32.91	117.6	31.80	113.6	30.31	110.2	29.20	102.8	27.58
	3.0	2.2	132.4	31.31	125.0	30.23	117.6	29.21	113.6	27.87	110.2	26.91	102.8	25.37
	5.0	4.1	132.4	27.30	122.4	25.72	115.2	24.86	111.3	23.69	108.0	22.92	100.8	21.59
	7.0	6.0	132.5	25.96	119.3	23.72	112.3	22.93	108.4	21.89	105.3	21.23	98.2	19.96
	9.0	7.9	127.7	22.18	115.0	20.26	108.1	19.59	104.5	18.70	101.4	18.13	94.6	17.05
	11.0	9.8	120.8	19.37	108.8	17.70	102.3	17.12	98.8	16.34	95.9	15.85	89.4	14.89
	13.0	11.8	113.4	16.67	102.2	15.25	96.1	14.73	92.8	14.07	90.0	13.64	84.0	12.82
15.0	13.7	107.2	14.55	96.6	13.29	90.9	12.85	87.8	12.26	85.2	11.90	79.5	11.18	
60	-24.8	-25	101.1	47.70	101.1	48.43	100.5	49.51	97.4	46.91	94.1	44.48	88.1	42.20
	-21.8	-22	108.5	48.78	107.5	49.51	100.9	46.91	97.4	44.48	94.1	42.20	88.1	40.00
	-19.8	-20	113.6	49.51	107.5	47.67	100.9	45.18	97.4	42.86	94.1	40.67	88.1	38.53
	-18.8	-19	113.6	48.59	107.5	46.75	100.9	44.31	97.4	42.04	94.1	39.91	88.1	37.79
	-16.7	-17	113.6	46.63	107.5	44.82	100.9	42.50	97.4	40.35	94.1	38.32	88.1	36.25
	-13.7	-15	113.6	43.84	107.5	42.07	100.9	39.91	97.4	37.92	94.1	36.04	88.1	34.05
	-11.8	-13	113.6	42.08	107.5	40.33	100.9	38.25	97.4	36.37	94.1	34.60	88.1	32.67
	-9.8	-11	113.6	40.23	107.5	38.49	100.9	36.53	97.4	34.76	94.1	33.07	88.1	31.19
	-9.5	-10	113.6	39.94	107.5	38.23	100.9	36.27	97.4	34.51	94.1	32.84	88.1	30.97
	-8.5	-9.1	113.6	39.02	107.5	37.31	100.9	35.41	97.4	33.71	94.1	32.07	88.1	30.24
	-7.0	-7.6	113.6	37.63	107.5	35.93	100.9	34.11	97.4	32.49	94.1	30.93	88.1	29.14
	-5.0	-5.6	113.6	35.77	107.5	34.09	100.9	32.38	97.4	30.87	94.1	29.42	88.1	27.67
	-3.0	-3.7	113.6	33.92	107.5	32.25	100.9	30.65	97.4	29.25	94.1	27.89	88.1	26.20
	0.0	-0.7	113.6	31.13	107.5	29.50	100.9	28.06	97.4	26.81	94.1	25.61	88.1	24.00
	3.0	2.2	113.6	28.35	107.5	26.75	100.9	25.46	97.4	24.39	94.1	23.33	88.1	21.79
	5.0	4.1	111.3	23.99	105.4	22.55	98.8	21.46	95.5	20.58	92.2	19.72	86.3	18.39
	7.0	6.0	108.4	21.92	102.7	20.54	96.3	19.58	93.1	18.82	89.9	18.05	84.0	16.79
	9.0	7.9	104.5	18.54	98.9	17.35	92.8	16.55	89.7	15.90	86.6	15.26	81.0	14.18
	11.0	9.8	98.8	16.19	93.5	15.16	87.7	14.45	84.8	13.89	81.8	13.33	76.6	12.39
	13.0	11.8	92.8	13.93	87.9	13.05	82.4	12.43	79.5	11.96	76.8	11.46	72.0	10.67
15.0	13.7	87.8	12.26	83.1	11.48	78.0	10.83	75.4	10.42	72.7	10.00	68.1	9.39	
50	-24.8	-25	94.7	42.05	89.3	43.13	84.0	40.82	81.3	38.65	78.6	36.61	73.2	34.72
	-21.8	-22	94.7	43.13	89.3	40.82	84.0	38.65	81.3	36.61	78.6	34.72	73.2	32.90
	-19.8	-20	94.7	41.51	89.3	39.27	84.0	37.22	81.3	35.24	78.6	33.45	73.2	31.67
	-18.8	-19	94.7	40.70	89.3	38.49	84.0	36.50	81.3	34.58	78.6	32.82	73.2	31.07
	-16.7	-17	94.7	39.01	89.3	36.89	84.0	34.99	81.3	33.15	78.6	31.49	73.2	29.79
	-13.7	-15	94.7	36.59	89.3	34.56	84.0	32.83	81.3	31.11	78.6	29.59	73.2	27.97
	-11.8	-13	94.7	35.06	89.3	33.10	84.0	31.45	81.3	29.81	78.6	28.39	73.2	26.82
	-9.8	-11	94.7	33.44	89.3	31.56	84.0	30.01	81.3	28.45	78.6	27.12	73.2	25.59
	-9.5	-10	94.7	33.20	89.3	31.34	84.0	29.80	81.3	28.25	78.6	26.94	73.2	25.42
	-8.5	-9.1	94.7	32.38	89.3	30.56	84.0	29.08	81.3	27.57	78.6	26.31	73.2	24.81
	-7.0	-7.6	94.7	31.18	89.3	29.41	84.0	28.00	81.3	26.55	78.6	25.36	73.2	23.90
	-5.0	-5.6	94.7	29.56	89.3	27.87	84.0	26.57	81.3	25.19	78.6	24.09	73.2	22.69
	-3.0	-3.7	94.7	27.94	89.3	26.32	84.0	25.11	81.3	23.83	78.6	22.82	73.2	21.47
	0.0	-0.7	94.7	25.53	89.3	24.00	84.0	22.96	81.3	21.79	78.6	20.92	73.2	19.64
	3.0	2.2	94.7	23.11	89.3	21.70	84.0	20.80	81.3	19.74	78.6	19.03	73.2	17.82
	5.0	4.1	92.9	19.46	87.6	18.22	82.3	17.51	79.7	16.63	77.1	16.06	71.8	15.02
	7.0	6.0	90.5	17.70	85.4	16.56	80.2	15.95	77.7	15.15	75.1	14.69	70.0	13.69
	9.0	7.9	87.2	15.10	82.2	14.14	77.3	13.62	74.8	12.95	72.3	12.55	67.4	11.70
	11.0	9.8	82.9	13.35	78.2	12.50	73.4	12.04	70.7	11.43	68.4	11.08	63.8	10.33
	13.0	11.8	77.4	11.36	73.0	10.64	68.7	10.25	66.4	9.79	64.3	9.44	59.8	8.86
15.0	13.7	73.2	10.03	69.1	9.39	64.9	9.04	62.9	8.60	60.8	8.32	56.6	7.76	

**Note**

1. TC: Total Capacity(kW), PI : Power Input(kW, Comp. + Outdoor fan motor)
2. Capacity tables show the average value of conditions which may occur.
3. The heating capacity table is based on the values expressed as Max. in the specification of the outdoor unit. (When measuring the Max. heating capacity, the setting status of the indoor unit is the same as that for measuring the heating capacity of the indoor unit.)

# 7. Capacity Tables

## ◆ ARUM560LTE5

Heating Capacity (56HP)

Combination (%)	Outdoor air temp.		Indoor air temp. °C DB											
			16		18		20		21		22		24	
	°C DB	°C WB	TC	PI	TC	PI	TC	PI	TC	PI	TC	PI	TC	PI
130	-24.8	-25	108.8	58.4	108.8	58.86	108.1	59.29	108.1	59.93	108.1	60.57	106.5	61.55
	-21.8	-22	132.4	59.35	132.4	59.84	131.5	60.27	131.5	60.92	131.5	61.55	129.4	62.52
	-19.8	-20	139.7	60.00	139.7	60.50	138.7	60.92	138.7	61.58	138.7	62.19	136.6	63.18
	-18.8	-19	142.8	60.33	142.8	60.82	141.9	61.25	141.9	61.90	141.9	62.52	139.6	63.50
	-16.7	-17	149.4	61.02	149.4	61.51	148.5	61.94	148.5	62.59	148.5	63.21	146.1	64.19
	-13.7	-15	158.8	62.01	158.8	62.49	157.9	62.92	157.9	63.57	157.9	64.19	155.3	61.72
	-11.8	-13	164.0	62.63	164.0	63.11	163.0	63.54	163.0	64.19	163.0	62.53	161.1	60.15
	-9.8	-11	169.4	63.27	169.4	63.77	168.4	64.19	168.4	62.42	168.4	60.78	166.9	58.51
	-9.5	-10	170.4	63.39	170.4	63.86	169.4	63.92	169.4	62.15	169.2	60.51	167.8	58.25
	-8.5	-9.1	173.9	63.70	173.9	64.19	172.9	63.00	172.9	61.25	171.9	59.63	170.8	57.42
	-7.0	-7.6	179.2	64.19	179.2	62.85	178.0	61.64	178.0	59.91	178.0	58.31	175.8	56.19
	-5.0	-5.6	186.1	62.45	186.1	61.06	184.9	59.81	184.9	58.13	184.9	56.56	181.8	54.54
	-3.0	-3.7	193.1	60.71	193.1	59.27	191.9	57.98	191.9	56.34	191.9	54.80	187.9	52.88
	0.0	-0.7	203.4	58.09	203.4	56.59	202.2	55.24	202.2	53.67	202.2	52.17	196.9	50.41
	3.0	2.2	213.9	55.48	213.9	53.89	212.5	52.50	212.5	50.99	211.0	49.52	197.7	47.94
	5.0	4.1	216.3	48.83	215.9	47.28	214.6	45.94	213.4	44.54	208.1	43.20	193.7	41.80
	7.0	6.0	215.7	46.26	215.3	44.77	214.1	43.48	210.2	42.21	202.8	40.95	188.8	39.73
9.0	7.9	208.6	42.99	208.1	41.60	207.6	40.39	202.4	39.21	195.4	38.05	181.9	36.92	
11.0	9.8	197.3	40.24	196.8	38.95	196.3	37.80	191.4	36.70	184.8	35.62	172.0	34.55	
13.0	11.8	185.3	36.93	184.9	35.74	184.3	34.70	179.8	33.69	173.5	32.69	161.5	31.70	
15.0	13.7	175.3	34.16	174.9	33.05	174.3	32.10	170.1	31.16	164.2	30.24	152.8	29.32	
120	-24.8	-25	108.1	58.86	108.1	59.29	107.3	59.93	107.3	60.57	107.3	61.55	105.7	62.24
	-21.8	-22	131.5	59.84	131.5	60.27	130.6	60.92	130.6	61.55	130.6	62.52	128.6	63.21
	-19.8	-20	138.7	60.50	138.7	60.92	137.8	61.58	137.8	62.19	137.8	63.18	135.6	63.86
	-18.8	-19	141.8	60.82	141.8	61.25	140.9	61.90	140.9	62.52	140.9	63.50	138.7	64.19
	-16.7	-17	148.4	61.51	148.4	61.94	147.4	62.59	147.4	63.21	147.4	64.19	145.0	62.60
	-13.7	-15	157.6	62.49	157.6	62.92	156.7	63.57	156.7	64.19	156.7	61.81	154.2	60.33
	-11.8	-13	162.8	63.11	162.8	63.54	161.8	64.19	161.8	62.51	161.8	60.31	159.9	58.89
	-9.8	-11	168.2	63.77	168.2	64.19	167.2	62.34	167.2	60.74	167.2	58.73	165.8	57.37
	-9.5	-10	169.3	63.86	169.3	63.90	168.3	62.07	168.3	60.47	168.3	58.49	166.8	57.14
	-8.5	-9.1	172.7	64.19	172.7	62.91	171.6	61.13	171.6	59.59	171.6	57.71	169.9	56.38
	-7.0	-7.6	177.9	62.73	177.9	61.44	176.8	59.75	176.8	58.26	176.6	56.52	174.5	55.24
	-5.0	-5.6	184.9	60.77	184.9	59.48	183.6	57.89	183.6	56.48	183.6	54.93	180.7	53.72
	-3.0	-3.7	191.7	58.81	191.7	57.53	190.5	56.03	190.5	54.72	190.5	53.35	185.7	52.20
	0.0	-0.7	202.0	55.88	202.0	54.58	200.7	53.25	200.7	52.06	199.5	50.97	185.7	49.93
	3.0	2.2	212.4	52.94	212.4	51.63	210.2	50.47	206.2	49.41	199.8	48.60	185.7	47.66
	5.0	4.1	214.9	46.28	213.7	45.04	209.0	44.02	202.1	43.08	195.9	42.44	182.0	41.61
	7.0	6.0	214.4	43.63	212.1	42.46	203.8	41.61	197.0	40.82	190.9	40.44	177.3	39.71
9.0	7.9	207.1	40.44	204.3	39.34	196.3	38.57	189.8	37.83	183.9	37.46	170.8	36.79	
11.0	9.8	195.9	37.74	193.2	36.70	185.7	35.98	179.4	35.29	173.9	34.97	161.5	34.34	
13.0	11.8	184.0	34.51	181.5	33.57	174.3	32.91	168.5	32.28	163.4	31.98	151.7	31.41	
15.0	13.7	174.1	31.79	171.8	30.92	164.9	30.32	159.5	29.75	154.6	29.47	143.5	28.94	
110	-24.8	-25	107.5	59.29	107.5	59.93	106.8	60.57	106.8	61.55	106.8	62.24	105.1	62.56
	-21.8	-22	130.8	60.27	130.8	60.92	129.9	61.55	129.9	62.52	129.9	63.21	127.9	63.54
	-19.8	-20	137.9	60.92	137.9	61.58	137.1	62.19	137.1	63.18	137.1	63.86	134.8	64.19
	-18.8	-19	141.0	61.25	141.0	61.90	140.1	62.52	140.1	63.50	140.1	64.19	137.9	63.35
	-16.7	-17	147.6	61.94	147.6	62.59	146.6	63.21	146.6	64.19	146.6	62.48	144.2	61.59
	-13.7	-15	156.8	62.92	156.8	63.57	155.7	64.19	155.7	61.59	155.7	60.01	155.7	59.07
	-11.8	-13	161.9	63.54	161.9	64.19	160.9	62.35	160.9	59.94	160.9	58.45	160.9	57.48
	-9.8	-11	167.3	64.19	167.3	62.12	166.3	60.42	166.3	58.20	166.3	56.82	165.6	55.80
	-9.5	-10	168.3	63.85	168.3	61.79	167.4	60.12	167.4	57.94	167.4	56.58	166.8	55.55
	-8.5	-9.1	171.8	62.74	171.8	60.76	170.7	59.16	170.7	57.06	170.7	55.74	167.1	54.71
	-7.0	-7.6	177.0	61.04	177.0	59.20	175.9	57.70	175.9	55.76	175.9	54.52	167.1	53.46
	-5.0	-5.6	183.8	58.80	183.8	57.11	182.6	55.77	182.6	54.03	178.9	52.88	167.1	51.77
	-3.0	-3.7	190.6	56.56	190.6	55.04	189.3	53.82	185.2	52.28	178.9	51.23	167.1	50.10
	0.0	-0.7	200.9	53.18	200.5	51.92	191.4	50.92	185.2	49.67	178.9	48.78	167.1	47.58
	3.0	2.2	210.7	49.81	204.0	48.79	191.4	48.00	185.2	47.08	178.9	46.31	167.1	45.06
	5.0	4.1	211.6	43.16	199.9	42.32	187.6	41.68	181.5	40.95	175.4	40.31	163.8	39.14
	7.0	6.0	206.2	40.33	194.9	39.73	182.9	39.28	176.9	38.80	170.9	38.31	159.6	37.11
9.0	7.9	198.6	37.18	187.6	36.62	176.1	36.20	170.4	35.77	164.6	35.32	153.7	34.22	
11.0	9.8	187.8	34.49	177.5	33.97	166.6	33.59	161.2	33.19	155.7	32.76	145.4	31.74	
13.0	11.8	176.3	31.35	166.7	30.87	156.5	30.51	151.3	30.14	146.2	29.76	136.5	28.85	
15.0	13.7	166.8	28.64	157.6	28.21	148.1	27.89	143.1	27.56	138.4	27.20	129.2	26.36	

# 7. Capacity Tables

Heating Capacity (56HP)

Combination (%)	Outdoor air temp.		Indoor air temp. °C DB											
			16		18		20		21		22		24	
	°C DB	°C WB	TC	PI	TC	PI	TC	PI	TC	PI	TC	PI	TC	PI
100	-24.8	-25	107.0	65.67	107.0	65.48	106.4	61.22	106.4	64.99	106.4	64.79	104.6	64.69
	-21.8	-22	130.1	65.38	130.1	65.18	129.4	63.15	129.4	64.70	129.4	65.38	127.2	64.40
	-19.8	-20	137.3	65.18	137.3	64.97	136.5	64.36	136.5	64.50	136.5	64.59	134.3	64.19
	-18.8	-19	140.4	65.08	139.6	64.89	139.6	64.70	139.6	64.39	139.6	64.19	137.3	63.17
	-16.7	-17	146.0	64.88	146.0	64.68	146.0	65.38	145.2	64.19	145.2	62.08	142.8	61.03
	-13.7	-15	156.0	64.58	156.0	64.38	155.1	64.19	155.1	61.13	155.1	59.06	152.7	57.95
	-11.8	-13	161.1	64.40	160.2	64.19	160.2	62.14	160.2	59.18	160.2	57.14	152.7	56.00
	-9.8	-11	166.4	64.19	166.4	61.89	165.7	59.97	165.7	57.14	163.9	55.13	152.7	53.95
	-9.5	-10	167.4	63.83	167.4	61.53	166.6	59.64	166.6	56.83	163.9	54.83	152.7	53.65
	-8.5	-9.1	170.9	62.62	170.9	60.39	170.1	58.56	169.5	55.80	163.9	53.82	152.7	52.62
	-7.0	-7.6	178.9	60.81	178.2	58.65	175.1	56.92	169.5	54.27	163.9	52.31	152.7	51.08
	-5.0	-5.6	186.7	58.38	184.8	56.35	175.1	54.76	169.5	52.22	163.9	50.30	152.7	49.04
	-3.0	-3.7	192.1	55.97	186.3	54.04	175.1	52.60	169.5	50.17	163.9	48.29	152.7	46.99
	0.0	-0.7	197.5	52.34	186.3	50.58	175.1	49.34	169.5	47.11	163.9	45.26	152.7	43.92
	3.0	2.2	197.5	48.70	186.3	47.11	175.1	46.09	169.5	44.04	163.9	42.25	152.7	40.85
	5.0	4.1	193.5	42.03	182.6	40.62	171.5	39.77	166.2	37.97	160.7	36.35	149.6	35.05
	7.0	6.0	188.6	39.04	177.9	37.82	167.3	37.15	161.8	35.55	156.5	34.02	145.9	32.71
	9.0	7.9	181.7	35.78	171.4	34.65	161.2	34.05	156.0	32.57	150.9	31.16	140.4	29.96
	11.0	9.8	171.8	32.95	162.1	31.90	152.3	31.36	147.5	29.99	142.6	28.70	132.9	27.60
	13.0	11.8	161.4	29.68	152.3	28.75	143.1	28.25	138.5	27.03	133.9	25.86	124.7	24.86
15.0	13.7	152.7	26.87	144.0	26.02	135.3	25.57	131.0	24.46	126.7	23.40	118.1	22.51	
90	-24.8	-25	106.6	58.36	106.6	59.33	105.9	60.03	105.9	60.34	105.9	61.01	104.3	61.99
	-21.8	-22	129.6	59.33	129.6	60.32	128.9	61.01	128.9	61.33	128.9	61.99	126.7	59.29
	-19.8	-20	136.8	60.00	136.8	60.97	135.9	61.66	135.9	61.99	135.9	60.14	133.8	57.50
	-18.8	-19	140.4	60.32	139.6	61.31	139.0	61.99	139.0	61.04	139.0	59.22	136.8	56.60
	-16.7	-17	146.0	61.01	146.0	61.99	145.4	60.02	145.4	59.04	145.4	57.29	139.5	54.71
	-13.7	-15	156.0	61.99	156.0	59.05	154.6	57.21	154.6	56.20	150.3	54.52	139.5	52.02
	-11.8	-13	161.1	59.97	160.2	57.20	159.6	55.42	155.3	54.39	150.3	52.77	139.5	50.31
	-9.8	-11	166.4	57.87	166.4	55.26	160.2	53.56	155.3	52.48	150.3	50.93	139.5	48.51
	-9.5	-10	167.4	57.54	167.4	54.95	160.2	53.27	155.3	52.19	150.3	50.65	139.5	48.24
	-8.5	-9.1	170.9	56.49	169.6	53.99	160.2	52.33	155.3	51.25	150.3	49.73	139.5	47.34
	-7.0	-7.6	178.9	54.90	170.1	52.52	160.2	50.93	155.3	49.82	150.3	48.34	139.5	45.99
	-5.0	-5.6	180.8	52.78	170.1	50.57	160.2	49.06	155.3	47.93	150.3	46.50	139.5	44.21
	-3.0	-3.7	180.8	50.67	170.1	48.62	160.2	47.18	155.3	46.02	150.3	44.65	139.5	42.40
	0.0	-0.7	180.8	47.50	170.1	45.68	160.2	44.37	155.3	43.17	150.3	41.89	139.5	39.71
	3.0	2.2	180.8	44.32	170.1	42.76	160.2	41.56	155.3	40.33	150.3	39.13	139.5	37.01
	5.0	4.1	177.3	38.22	166.8	36.90	157.0	35.84	152.1	34.71	147.3	33.65	136.7	31.76
	7.0	6.0	172.7	35.68	162.6	34.58	152.9	33.65	148.2	32.51	143.5	31.54	133.4	29.73
	9.0	7.9	166.4	32.69	156.5	31.69	147.3	30.83	142.8	29.78	138.2	28.89	128.4	27.25
	11.0	9.8	157.4	29.82	148.1	28.89	139.3	28.11	135.1	27.16	130.7	26.35	121.4	24.84
	13.0	11.8	147.8	26.31	139.0	25.50	130.9	24.83	126.8	23.97	122.8	23.26	114.0	21.93
15.0	13.7	139.8	23.56	131.5	22.84	123.9	22.23	120.0	21.47	116.2	20.83	107.9	19.64	
80	-24.8	-25	106.1	51.33	106.1	52.32	105.5	53.01	105.5	53.33	105.5	54.97	103.8	52.60
	-21.8	-22	128.2	52.32	128.2	53.30	128.2	53.98	128.2	54.97	128.2	52.60	124.7	50.32
	-19.8	-20	135.4	52.97	135.4	53.95	135.4	54.97	135.4	53.29	133.8	51.01	124.7	48.80
	-18.8	-19	138.5	53.30	138.5	54.97	138.5	54.11	138.3	52.45	134.0	50.22	124.7	48.05
	-16.7	-17	143.3	54.97	143.3	53.19	143.3	52.33	139.0	50.70	134.0	48.57	124.7	46.46
	-13.7	-15	149.8	52.34	146.9	50.65	143.3	49.78	139.0	48.18	134.0	46.19	124.7	44.18
	-11.8	-13	153.6	50.66	149.1	49.04	143.3	48.16	139.0	46.59	134.0	44.69	124.7	42.73
	-9.8	-11	157.7	48.90	151.2	47.36	143.3	46.46	139.0	44.92	134.0	43.11	124.7	41.22
	-9.5	-10	158.8	48.64	152.0	47.10	143.3	46.20	139.0	44.67	134.0	42.87	124.7	40.99
	-8.5	-9.1	160.4	47.77	152.7	46.26	143.3	45.36	139.0	43.82	134.0	42.08	124.7	40.24
	-7.0	-7.6	162.0	46.45	152.7	44.98	143.3	44.08	139.0	42.57	134.0	40.90	124.7	39.09
	-5.0	-5.6	162.0	44.69	152.7	43.31	143.3	42.38	139.0	40.89	134.0	39.30	124.7	37.58
	-3.0	-3.7	162.0	42.93	152.7	41.61	143.3	40.68	139.0	39.22	134.0	37.73	124.7	36.05
	0.0	-0.7	162.0	40.29	152.7	39.08	143.3	38.13	139.0	36.71	134.0	35.35	124.7	33.78
	3.0	2.2	162.0	37.66	152.7	36.53	143.3	35.57	139.0	34.18	134.0	32.98	124.7	31.51
	5.0	4.1	158.7	32.46	149.6	31.48	140.4	30.60	136.2	29.35	131.2	28.33	122.3	27.06
	7.0	6.0	154.6	30.38	145.8	29.51	136.8	28.64	132.8	27.45	127.9	26.54	119.0	25.34
	9.0	7.9	149.0	27.07	140.4	26.31	131.8	25.66	127.9	24.68	123.3	23.80	114.8	22.67
	11.0	9.8	140.9	23.91	132.8	23.25	124.7	22.68	120.9	21.80	116.6	21.03	108.4	20.02
	13.0	11.8	132.3	20.64	124.7	20.06	117.1	19.57	113.6	18.81	109.5	18.14	101.9	17.28
15.0	13.7	125.1	18.47	118.1	17.95	110.8	17.51	107.5	16.83	103.7	16.23	96.4	15.46	

# 7. Capacity Tables

Heating Capacity (56HP)

Combination (%)	Outdoor air temp.		Indoor air temp. °C DB											
			16		18		20		21		22		24	
	°C DB	°C WB	TC	PI	TC	PI	TC	PI	TC	PI	TC	PI	TC	PI
70	-24.8	-25	106.1	51.56	106.1	51.89	105.5	52.55	105.5	53.53	105.5	50.97	103.7	48.56
	-21.8	-22	122.8	52.55	122.8	52.87	122.0	53.53	117.8	50.97	114.3	48.56	106.7	46.25
	-19.8	-20	133.9	53.21	129.7	53.53	122.0	51.73	117.8	49.26	114.3	46.97	106.7	44.71
	-18.8	-19	137.1	53.53	129.7	52.60	122.0	50.82	117.8	48.39	114.3	46.16	106.7	43.93
	-16.7	-17	137.3	51.59	129.7	50.63	122.0	48.94	117.8	46.60	114.3	44.49	106.7	42.31
	-13.7	-15	137.3	48.83	129.7	47.84	122.0	46.23	117.8	44.04	114.3	42.09	106.7	39.99
	-11.8	-13	137.3	47.06	129.7	46.07	122.0	44.52	117.8	42.40	114.3	40.56	106.7	38.53
	-9.8	-11	137.3	45.23	129.7	44.20	122.0	42.72	117.8	40.69	114.3	38.97	106.7	36.98
	-9.5	-10	137.3	44.94	129.7	43.92	122.0	42.45	117.8	40.44	114.3	38.74	106.7	36.75
	-8.5	-9.1	137.3	44.03	129.7	42.99	122.0	41.55	117.8	39.58	114.3	37.93	106.7	35.98
	-7.0	-7.6	137.3	42.64	129.7	41.60	122.0	40.20	117.8	38.31	114.3	36.73	106.7	34.82
	-5.0	-5.6	137.3	40.80	129.7	39.73	122.0	38.39	117.8	36.59	114.3	35.13	106.7	33.28
	-3.0	-3.7	137.3	38.96	129.7	37.86	122.0	36.59	117.8	34.88	114.3	33.53	106.7	31.73
	0.0	-0.7	137.3	36.19	129.7	35.07	122.0	33.89	117.8	32.32	114.3	31.13	106.7	29.42
	3.0	2.2	137.3	33.42	129.7	32.27	122.0	31.18	117.8	29.76	114.3	28.74	106.7	27.09
	5.0	4.1	137.3	29.18	127.0	27.49	119.5	26.56	115.4	25.32	112.0	24.51	104.6	23.09
	7.0	6.0	137.5	27.79	123.8	25.40	116.5	24.55	112.5	23.44	109.2	22.73	101.9	21.37
	9.0	7.9	132.5	23.94	119.3	21.87	112.2	21.14	108.4	20.18	105.1	19.57	98.1	18.40
	11.0	9.8	125.3	21.11	112.9	19.29	106.1	18.65	102.5	17.80	99.5	17.27	92.8	16.23
	13.0	11.8	117.6	18.38	106.0	16.81	99.7	16.24	96.2	15.50	93.4	15.04	87.2	14.13
15.0	13.7	111.2	16.25	100.2	14.85	94.3	14.36	91.1	13.70	88.4	13.29	82.5	12.50	
60	-24.8	-25	104.9	50.83	104.9	51.49	104.2	52.48	101.1	49.75	97.6	47.19	91.4	44.79
	-21.8	-22	112.6	51.82	111.5	52.48	104.6	49.75	101.1	47.19	97.6	44.79	91.4	42.47
	-19.8	-20	117.8	52.48	111.5	50.55	104.6	47.93	101.1	45.49	97.6	43.18	91.4	40.92
	-18.8	-19	117.8	51.51	111.5	49.59	104.6	47.02	101.1	44.63	97.6	42.38	91.4	40.14
	-16.7	-17	117.8	49.46	111.5	47.55	104.6	45.11	101.1	42.84	97.6	40.71	91.4	38.52
	-13.7	-15	117.8	46.53	111.5	44.67	104.6	42.38	101.1	40.29	97.6	38.30	91.4	36.20
	-11.8	-13	117.8	44.69	111.5	42.83	104.6	40.64	101.1	38.66	97.6	36.78	91.4	34.74
	-9.8	-11	117.8	42.74	111.5	40.90	104.6	38.83	101.1	36.96	97.6	35.18	91.4	33.18
	-9.5	-10	117.8	42.44	111.5	40.62	104.6	38.56	101.1	36.70	97.6	34.93	91.4	32.95
	-8.5	-9.1	117.8	41.47	111.5	39.66	104.6	37.65	101.1	35.86	97.6	34.13	91.4	32.18
	-7.0	-7.6	117.8	40.02	111.5	38.21	104.6	36.29	101.1	34.57	97.6	32.93	91.4	31.02
	-5.0	-5.6	117.8	38.06	111.5	36.28	104.6	34.47	101.1	32.87	97.6	31.33	91.4	29.47
	-3.0	-3.7	117.8	36.12	111.5	34.35	104.6	32.65	101.1	31.17	97.6	29.72	91.4	27.92
	0.0	-0.7	117.8	33.19	111.5	31.45	104.6	29.93	101.1	28.60	97.6	27.32	91.4	25.61
	3.0	2.2	117.8	30.27	111.5	28.56	104.6	27.19	101.1	26.05	97.6	24.92	91.4	23.28
	5.0	4.1	115.4	25.64	109.3	24.10	102.5	22.94	99.0	22.01	95.6	21.08	89.5	19.66
	7.0	6.0	112.5	23.47	106.5	21.99	99.9	20.97	96.5	20.15	93.2	19.32	87.2	17.97
	9.0	7.9	108.4	20.01	102.6	18.73	96.2	17.86	93.1	17.16	89.8	16.47	84.0	15.31
	11.0	9.8	102.5	17.64	97.0	16.52	90.9	15.75	87.9	15.14	84.9	14.52	79.5	13.50
	13.0	11.8	96.2	15.35	91.2	14.38	85.4	13.70	82.5	13.18	79.7	12.63	74.6	11.76
15.0	13.7	91.1	13.70	86.2	12.83	80.9	12.11	78.2	11.65	75.4	11.17	70.6	10.49	
50	-24.8	-25	98.3	44.65	92.7	45.63	87.2	43.21	84.4	40.94	81.5	38.80	75.9	36.81
	-21.8	-22	98.3	45.63	92.7	43.21	87.2	40.94	84.4	38.80	81.5	36.81	75.9	34.89
	-19.8	-20	98.3	43.94	92.7	41.59	87.2	39.43	84.4	37.36	81.5	35.47	75.9	33.60
	-18.8	-19	98.3	43.09	92.7	40.77	87.2	38.68	84.4	36.66	81.5	34.81	75.9	32.97
	-16.7	-17	98.3	41.32	92.7	39.09	87.2	37.10	84.4	35.15	81.5	33.41	75.9	31.63
	-13.7	-15	98.3	38.79	92.7	36.65	87.2	34.82	84.4	33.01	81.5	31.42	75.9	29.71
	-11.8	-13	98.3	37.18	92.7	35.12	87.2	33.39	84.4	31.65	81.5	30.16	75.9	28.50
	-9.8	-11	98.3	35.49	92.7	33.50	87.2	31.87	84.4	30.22	81.5	28.82	75.9	27.21
	-9.5	-10	98.3	35.23	92.7	33.27	87.2	31.65	84.4	30.01	81.5	28.64	75.9	27.02
	-8.5	-9.1	98.3	34.38	92.7	32.45	87.2	30.90	84.4	29.30	81.5	27.97	75.9	26.38
	-7.0	-7.6	98.3	33.11	92.7	31.25	87.2	29.76	84.4	28.23	81.5	26.97	75.9	25.43
	-5.0	-5.6	98.3	31.42	92.7	29.63	87.2	28.26	84.4	26.80	81.5	25.64	75.9	24.15
	-3.0	-3.7	98.3	29.73	92.7	28.01	87.2	26.73	84.4	25.37	81.5	24.30	75.9	22.87
	0.0	-0.7	98.3	27.20	92.7	25.57	87.2	24.47	84.4	23.23	81.5	22.31	75.9	20.95
	3.0	2.2	98.3	24.66	92.7	23.16	87.2	22.21	84.4	21.08	81.5	20.32	75.9	19.03
	5.0	4.1	96.4	20.79	90.9	19.48	85.3	18.72	82.6	17.78	80.0	17.17	74.5	16.06
	7.0	6.0	93.9	18.94	88.6	17.73	83.2	17.08	80.6	16.22	77.9	15.72	72.6	14.66
	9.0	7.9	90.4	16.30	85.3	15.26	80.1	14.70	77.6	13.97	75.0	13.54	70.0	12.63
	11.0	9.8	86.0	14.55	81.1	13.62	76.1	13.12	73.3	12.46	70.9	12.07	66.2	11.26
	13.0	11.8	80.3	12.52	75.8	11.73	71.2	11.29	68.9	10.79	66.7	10.40	62.0	9.76
15.0	13.7	75.9	11.21	71.7	10.49	67.3	10.10	65.3	9.61	63.1	9.30	58.7	8.67	

**Note**

1. TC: Total Capacity(kW), PI : Power Input(kW, Comp. + Outdoor fan motor)
2. Capacity tables show the average value of conditions which may occur.
3. The heating capacity table is based on the values expressed as Max. in the specification of the outdoor unit. (When measuring the Max. heating capacity, the setting status of the indoor unit is the same as that for measuring the heating capacity of the indoor unit.)

# 7. Capacity Tables

## ◆ ARUM580LTE5

Heating Capacity (58HP)

Combination (%)	Outdoor air temp.		Indoor air temp. °C DB											
			16		18		20		21		22		24	
	°C DB	°C WB	TC	PI	TC	PI	TC	PI	TC	PI	TC	PI	TC	PI
130	-24.8	-25	112.7	61.3	112.7	61.83	112.1	62.27	112.1	62.93	112.1	63.58	110.3	64.59
	-21.8	-22	137.2	62.33	137.2	62.83	136.3	63.27	136.3	63.94	136.3	64.59	134.1	65.58
	-19.8	-20	144.7	63.00	144.7	63.51	143.7	63.94	143.7	64.61	143.7	65.25	141.5	66.26
	-18.8	-19	148.0	63.34	148.0	63.84	147.0	64.28	147.0	64.95	147.0	65.58	144.7	66.59
	-16.7	-17	154.8	64.04	154.8	64.54	153.8	64.98	153.8	65.65	153.8	66.29	151.3	67.29
	-13.7	-15	164.5	65.05	164.5	65.55	163.5	65.99	163.5	66.66	163.5	67.29	160.8	64.71
	-11.8	-13	169.9	65.70	169.9	66.19	168.9	66.63	168.9	67.29	168.9	67.95	166.9	65.56
	-9.8	-11	175.6	66.35	175.6	66.86	174.4	67.29	174.4	67.95	174.4	68.66	172.9	66.35
	-9.5	-10	176.6	66.47	176.6	66.96	175.5	67.01	175.5	67.68	175.5	68.38	173.9	67.08
	-8.5	-9.1	180.2	66.79	180.2	67.29	179.1	67.66	179.1	68.34	179.1	69.01	176.9	67.87
	-7.0	-7.6	185.6	67.29	185.6	67.95	184.4	68.34	184.4	69.01	184.4	69.68	182.1	68.66
	-5.0	-5.6	192.8	68.48	192.8	69.14	191.5	69.68	191.5	70.34	191.5	71.00	188.4	69.68
	-3.0	-3.7	200.0	69.67	200.0	70.34	198.7	70.88	198.7	71.54	198.7	72.20	194.7	70.67
	0.0	-0.7	210.7	70.93	210.7	71.59	209.4	72.10	209.4	72.76	209.4	73.42	204.0	71.66
	3.0	2.2	221.5	72.21	221.5	72.86	220.1	73.42	220.1	74.08	220.1	74.74	218.6	72.65
	5.0	4.1	224.0	72.86	224.0	73.51	222.2	74.08	222.2	74.74	222.2	75.40	215.6	73.42
	7.0	6.0	223.5	73.51	223.5	74.16	221.8	74.74	221.8	75.40	221.8	76.08	210.1	74.16
9.0	7.9	216.1	74.16	216.1	74.80	215.0	75.40	215.0	76.08	215.0	76.74	202.4	74.80	
11.0	9.8	204.4	74.80	204.4	75.45	203.4	76.08	203.4	76.74	203.4	77.48	191.4	75.45	
13.0	11.8	191.9	75.45	191.9	76.10	191.0	76.74	191.0	77.48	191.0	78.22	179.8	76.10	
15.0	13.7	181.6	76.10	181.6	76.74	180.6	77.48	180.6	78.22	180.6	79.06	170.1	76.74	
120	-24.8	-25	112.0	61.83	112.0	62.27	111.3	62.93	111.3	63.58	111.3	64.19	109.5	65.29
	-21.8	-22	136.2	62.83	136.2	63.27	135.3	63.94	135.3	64.59	135.3	65.58	133.2	66.29
	-19.8	-20	143.7	63.51	143.7	63.94	142.7	64.61	142.7	65.25	142.7	66.26	140.5	66.96
	-18.8	-19	146.9	63.84	146.9	64.28	145.9	64.95	145.9	65.58	145.9	66.59	143.7	67.29
	-16.7	-17	153.7	64.54	153.7	64.98	152.7	65.65	152.7	66.29	152.7	67.29	150.2	68.01
	-13.7	-15	163.3	65.55	163.3	65.99	162.3	66.66	162.3	67.29	162.3	68.01	159.7	68.71
	-11.8	-13	168.6	66.19	168.6	66.63	167.6	67.29	167.6	67.95	167.6	68.66	165.6	69.41
	-9.8	-11	174.3	66.86	174.3	67.29	173.3	67.95	173.3	68.66	173.3	69.41	171.8	70.11
	-9.5	-10	175.4	66.96	175.4	67.29	174.4	67.95	174.4	68.66	174.4	69.41	172.8	70.81
	-8.5	-9.1	179.0	67.29	179.0	67.95	177.7	68.66	177.7	69.41	177.7	70.11	176.0	71.51
	-7.0	-7.6	184.3	67.95	184.3	68.66	183.2	69.41	183.2	70.11	183.2	70.81	180.8	72.21
	-5.0	-5.6	191.5	68.72	191.5	69.41	190.2	70.11	190.2	70.81	190.2	71.51	187.1	72.91
	-3.0	-3.7	198.6	69.41	198.6	70.11	197.3	70.81	197.3	71.51	197.3	72.21	192.4	73.61
	0.0	-0.7	209.2	70.11	209.2	70.81	207.9	71.51	207.9	72.21	207.9	72.91	202.4	74.31
	3.0	2.2	219.9	70.81	219.9	71.51	218.6	72.21	218.6	72.91	218.6	73.61	213.1	75.01
	5.0	4.1	222.5	71.51	222.5	72.21	221.2	72.91	221.2	73.61	221.2	74.31	215.6	75.71
	7.0	6.0	222.0	72.21	222.0	72.91	220.7	73.61	220.7	74.31	220.7	75.01	210.1	76.41
9.0	7.9	214.6	72.91	214.6	73.61	213.3	74.31	213.3	75.01	213.3	75.71	202.4	77.11	
11.0	9.8	202.9	73.61	202.9	74.31	201.6	75.01	201.6	75.71	201.6	76.41	191.4	77.81	
13.0	11.8	190.6	74.31	190.6	75.01	189.3	75.71	189.3	76.41	189.3	77.11	179.8	78.51	
15.0	13.7	180.4	75.01	180.4	75.71	179.1	76.41	179.1	77.11	179.1	77.81	170.1	79.21	
110	-24.8	-25	111.4	62.27	111.4	62.93	110.7	63.58	110.7	64.19	110.7	64.80	108.9	65.63
	-21.8	-22	135.5	63.27	135.5	63.94	134.6	64.59	134.6	65.25	134.6	65.90	132.5	66.63
	-19.8	-20	142.9	63.94	142.9	64.61	142.1	65.25	142.1	65.90	142.1	66.61	139.7	67.29
	-18.8	-19	146.1	64.28	146.1	64.95	145.1	65.58	145.1	66.29	145.1	67.00	142.9	68.01
	-16.7	-17	152.9	64.98	152.9	65.65	151.9	66.29	151.9	67.00	151.9	67.71	149.4	68.71
	-13.7	-15	162.4	65.99	162.4	66.66	161.4	67.29	161.4	68.01	161.4	68.71	161.4	69.41
	-11.8	-13	167.8	66.63	167.8	67.29	166.7	67.95	166.7	68.66	166.7	69.37	166.7	70.11
	-9.8	-11	173.3	67.29	173.3	67.95	172.3	68.66	172.3	69.37	172.3	70.08	171.5	70.81
	-9.5	-10	174.4	67.39	174.4	68.01	173.4	68.71	173.4	69.41	173.4	70.11	172.8	71.51
	-8.5	-9.1	178.0	67.78	178.0	68.41	176.9	69.01	176.9	69.71	176.9	70.41	173.1	72.21
	-7.0	-7.6	183.3	68.41	183.3	69.01	182.2	69.71	182.2	70.41	182.2	71.11	173.1	72.91
	-5.0	-5.6	190.4	69.14	190.4	69.74	189.1	70.41	189.1	71.11	189.1	71.81	185.3	73.61
	-3.0	-3.7	197.5	69.74	197.5	70.34	196.1	71.00	196.1	71.71	196.1	72.41	191.4	74.31
	0.0	-0.7	208.1	70.41	208.1	71.00	206.8	71.71	206.8	72.41	206.8	73.11	202.4	75.01
	3.0	2.2	218.3	71.00	218.3	71.59	217.0	72.21	217.0	72.91	217.0	73.61	212.5	75.71
	5.0	4.1	219.2	71.59	219.2	72.18	217.9	72.81	217.9	73.41	217.9	74.01	213.4	76.41
	7.0	6.0	213.6	72.18	213.6	72.77	212.3	73.41	212.3	74.01	212.3	74.61	207.9	77.11
9.0	7.9	205.8	72.77	205.8	73.26	204.5	73.91	204.5	74.51	204.5	75.11	199.4	77.81	
11.0	9.8	194.5	73.26	194.5	73.85	193.2	74.51	193.2	75.11	193.2	75.71	187.9	78.51	
13.0	11.8	182.7	73.85	182.7	74.44	181.4	75.11	181.4	75.71	181.4	76.31	172.4	79.21	
15.0	13.7	172.8	74.44	172.8	75.03	171.5	75.71	171.5	76.31	171.5	76.91	162.9	79.91	



# 7. Capacity Tables

Heating Capacity (58HP)

Combination (%)	Outdoor air temp.		Indoor air temp. °C DB											
			16		18		20		21		22		24	
	°C DB	°C WB	TC	PI	TC	PI	TC	PI	TC	PI	TC	PI	TC	PI
100	-24.8	-25	110.9	68.94	110.9	68.72	110.2	64.22	110.2	68.19	110.2	67.96	108.4	67.85
	-21.8	-22	134.8	68.62	134.8	68.40	134.1	66.25	134.1	67.86	134.1	68.56	131.8	67.52
	-19.8	-20	142.3	68.40	142.3	68.17	141.4	67.52	141.4	67.64	141.4	67.72	139.2	67.29
	-18.8	-19	145.4	68.29	144.6	68.07	144.6	67.86	144.6	67.52	144.6	67.29	142.2	66.23
	-16.7	-17	151.3	68.06	151.3	67.84	151.3	68.56	150.4	67.29	150.4	65.09	147.9	63.98
	-13.7	-15	161.6	67.73	161.6	67.50	160.7	67.29	160.7	64.09	160.7	61.93	158.2	60.76
	-11.8	-13	166.9	67.52	166.0	67.29	166.0	65.15	166.0	62.05	166.0	59.92	158.2	58.73
	-9.8	-11	172.4	67.29	172.4	64.88	171.6	62.88	171.6	59.91	169.8	57.82	158.2	56.58
	-9.5	-10	173.4	66.92	173.4	64.52	172.6	62.53	172.6	59.59	169.8	57.49	158.2	56.26
	-8.5	-9.1	177.0	65.65	177.0	63.32	176.2	61.40	175.6	58.52	169.8	56.44	158.2	55.19
	-7.0	-7.6	185.3	63.76	184.6	61.50	181.4	59.69	175.6	56.92	169.8	54.86	158.2	53.58
	-5.0	-5.6	193.4	61.22	191.5	59.09	181.4	57.43	175.6	54.77	169.8	52.76	158.2	51.43
	-3.0	-3.7	199.0	58.70	193.0	56.67	181.4	55.17	175.6	52.62	169.8	50.66	158.2	49.29
	0.0	-0.7	204.6	54.90	193.0	53.05	181.4	51.76	175.6	49.42	169.8	47.49	158.2	46.08
	3.0	2.2	204.6	51.10	193.0	49.43	181.4	48.36	175.6	46.21	169.8	44.33	158.2	42.86
	5.0	4.1	200.5	44.11	189.2	42.63	177.7	41.73	172.1	39.85	166.5	38.14	155.0	36.79
	7.0	6.0	195.4	40.97	184.3	39.69	173.3	39.00	167.7	37.31	162.1	35.70	151.1	34.33
	9.0	7.9	188.2	37.56	177.5	36.38	167.0	35.74	161.6	34.20	156.3	32.71	145.5	31.46
	11.0	9.8	178.0	34.61	167.9	33.51	157.8	32.93	152.8	31.50	147.7	30.14	137.7	28.99
	13.0	11.8	167.2	31.18	157.7	30.20	148.2	29.68	143.5	28.40	138.7	27.17	129.2	26.12
15.0	13.7	158.2	28.24	149.2	27.35	140.2	26.87	135.8	25.70	131.2	24.60	122.3	23.66	
90	-24.8	-25	110.4	61.28	110.4	62.28	109.8	62.99	109.8	63.32	109.8	63.99	108.1	65.01
	-21.8	-22	134.3	62.28	134.3	63.29	133.6	63.99	133.6	64.33	133.6	65.01	131.3	62.18
	-19.8	-20	141.7	62.96	141.7	63.96	140.8	64.66	140.8	65.01	140.8	65.07	138.6	60.30
	-18.8	-19	145.4	63.29	144.6	64.30	144.0	65.01	144.0	64.01	144.0	62.10	141.7	59.36
	-16.7	-17	151.3	63.99	151.3	65.01	150.6	62.94	150.6	61.92	150.6	60.08	144.5	57.38
	-13.7	-15	161.6	65.01	161.6	61.93	160.1	60.00	160.1	58.94	155.7	57.18	144.5	54.56
	-11.8	-13	166.9	62.89	166.0	59.99	165.4	58.13	160.8	57.04	155.7	55.35	144.5	52.77
	-9.8	-11	172.4	60.69	172.4	57.96	166.0	56.17	160.8	55.05	155.7	53.42	144.5	50.89
	-9.5	-10	173.4	60.35	173.4	57.64	166.0	55.88	160.8	54.75	155.7	53.12	144.5	50.60
	-8.5	-9.1	177.0	59.24	175.8	56.62	166.0	54.89	160.8	53.75	155.7	52.16	144.5	49.66
	-7.0	-7.6	185.3	57.58	176.3	55.09	166.0	53.42	160.8	52.26	155.7	50.71	144.5	48.25
	-5.0	-5.6	187.3	55.37	176.3	53.04	166.0	51.46	160.8	50.28	155.7	48.78	144.5	46.38
	-3.0	-3.7	187.3	53.15	176.3	51.01	166.0	49.50	160.8	48.28	155.7	46.84	144.5	44.48
	0.0	-0.7	187.3	49.84	176.3	47.93	166.0	46.55	160.8	45.30	155.7	43.95	144.5	41.67
	3.0	2.2	187.3	46.50	176.3	44.87	166.0	43.61	160.8	42.32	155.7	41.06	144.5	38.84
	5.0	4.1	183.6	40.11	172.8	38.72	162.6	37.61	157.6	36.43	152.6	35.32	141.6	33.33
	7.0	6.0	179.0	37.45	168.4	36.29	158.5	35.32	153.6	34.12	148.7	33.10	138.1	31.21
	9.0	7.9	172.4	34.32	162.2	33.27	152.6	32.37	147.9	31.26	143.2	30.33	133.0	28.61
	11.0	9.8	163.1	31.31	153.4	30.34	144.4	29.52	139.9	28.52	135.4	27.68	125.8	26.09
	13.0	11.8	153.1	27.64	144.0	26.79	135.6	26.08	131.4	25.18	127.2	24.43	118.1	23.04
15.0	13.7	144.8	24.77	136.3	24.01	128.3	23.36	124.3	22.57	120.4	21.90	111.8	20.65	
80	-24.8	-25	110.0	53.91	110.0	54.93	109.3	55.63	109.3	55.96	109.3	57.64	107.6	55.16
	-21.8	-22	132.9	54.93	132.9	55.93	132.9	56.63	132.9	57.64	132.9	55.16	129.1	52.77
	-19.8	-20	140.3	55.59	140.3	56.59	140.3	57.64	140.3	55.89	138.6	53.50	129.1	51.18
	-18.8	-19	143.4	55.93	143.4	57.64	143.4	56.74	143.3	55.00	138.8	52.66	129.1	50.39
	-16.7	-17	148.4	57.64	148.4	55.78	148.4	54.88	144.0	53.17	138.8	50.93	129.1	48.73
	-13.7	-15	155.2	54.88	152.1	53.12	148.4	52.21	144.0	50.53	138.8	48.44	129.1	46.34
	-11.8	-13	159.1	53.13	154.4	51.44	148.4	50.51	144.0	48.86	138.8	46.87	129.1	44.82
	-9.8	-11	163.4	51.29	156.7	49.67	148.4	48.73	144.0	47.12	138.8	45.21	129.1	43.24
	-9.5	-10	164.5	51.02	157.5	49.40	148.4	48.46	144.0	46.85	138.8	44.96	129.1	43.00
	-8.5	-9.1	166.2	50.10	158.2	48.52	148.4	47.58	144.0	45.97	138.8	44.14	129.1	42.21
	-7.0	-7.6	167.8	48.72	158.2	47.18	148.4	46.24	144.0	44.66	138.8	42.90	129.1	41.01
	-5.0	-5.6	167.8	46.88	158.2	45.43	148.4	44.46	144.0	42.89	138.8	41.23	129.1	39.42
	-3.0	-3.7	167.8	45.04	158.2	43.65	148.4	42.67	144.0	41.15	138.8	39.59	129.1	37.83
	0.0	-0.7	167.8	42.27	158.2	41.00	148.4	40.01	144.0	38.51	138.8	37.09	129.1	35.45
	3.0	2.2	167.8	39.52	158.2	38.33	148.4	37.33	144.0	35.87	138.8	34.61	129.1	33.06
	5.0	4.1	164.4	34.07	155.0	33.03	145.5	32.11	141.1	30.81	136.0	29.73	126.7	28.40
	7.0	6.0	160.2	31.89	151.1	30.97	141.8	30.06	137.5	28.81	132.5	27.85	123.3	26.59
	9.0	7.9	154.4	28.42	145.5	27.63	136.6	26.95	132.5	25.91	127.7	24.99	118.9	23.80
	11.0	9.8	146.0	25.12	137.6	24.42	129.1	23.82	125.3	22.90	120.8	22.08	112.3	21.03
	13.0	11.8	137.1	21.68	129.2	21.07	121.3	20.56	117.7	19.76	113.4	19.05	105.5	18.15
15.0	13.7	129.6	19.41	122.3	18.87	114.7	18.40	111.3	17.69	107.4	17.06	99.8	16.25	

# 7. Capacity Tables

Heating Capacity (58HP)

Combination (%)	Outdoor air temp.		Indoor air temp. °C DB													
			16		18		20		21		22		24			
	°C DB	°C WB	TC	PI	TC	PI	TC	PI	TC	PI	TC	PI	TC	PI		
70	-24.8	-25	110.0	54.12	110.0	54.45	109.3	55.13	109.3	56.14	109.3	53.46	109.3	53.46	107.5	50.93
	-21.8	-22	127.2	55.13	127.2	55.47	126.4	56.14	122.0	53.46	118.5	50.93	110.5	48.51		
	-19.8	-20	138.6	55.81	134.3	56.14	126.4	54.25	122.0	51.66	118.5	49.26	110.5	46.90		
	-18.8	-19	142.1	56.14	134.3	55.16	126.4	53.30	122.0	50.76	118.5	48.42	110.5	46.08		
	-16.7	-17	142.3	54.10	134.3	53.10	126.4	51.33	122.0	48.88	118.5	46.67	110.5	44.38		
	-13.7	-15	142.3	51.21	134.3	50.18	126.4	48.49	122.0	46.19	118.5	44.15	110.5	41.95		
	-11.8	-13	142.3	49.36	134.3	48.32	126.4	46.70	122.0	44.48	118.5	42.55	110.5	40.42		
	-9.8	-11	142.3	47.44	134.3	46.37	126.4	44.82	122.0	42.69	118.5	40.88	110.5	38.80		
	-9.5	-10	142.3	47.14	134.3	46.07	126.4	44.53	122.0	42.43	118.5	40.64	110.5	38.56		
	-8.5	-9.1	142.3	46.19	134.3	45.10	126.4	43.58	122.0	41.52	118.5	39.79	110.5	37.75		
	-7.0	-7.6	142.3	44.73	134.3	43.64	126.4	42.17	122.0	40.19	118.5	38.54	110.5	36.53		
	-5.0	-5.6	142.3	42.80	134.3	41.68	126.4	40.28	122.0	38.39	118.5	36.86	110.5	34.91		
	-3.0	-3.7	142.3	40.87	134.3	39.72	126.4	38.39	122.0	36.60	118.5	35.18	110.5	33.29		
	0.0	-0.7	142.3	37.97	134.3	36.80	126.4	35.56	122.0	33.91	118.5	32.67	110.5	30.87		
	3.0	2.2	142.3	35.07	134.3	33.86	126.4	32.72	122.0	31.23	118.5	30.16	110.5	28.43		
	5.0	4.1	142.3	30.62	131.6	28.85	123.8	27.88	119.6	26.58	116.0	25.72	108.4	24.23		
	7.0	6.0	142.4	29.16	128.2	26.66	120.7	25.76	116.5	24.60	113.1	23.85	105.5	22.43		
	9.0	7.9	137.2	25.13	123.6	22.96	116.2	22.19	112.3	21.19	108.9	20.54	101.6	19.32		
	11.0	9.8	129.8	22.16	116.9	20.26	109.9	19.59	106.2	18.69	103.1	18.13	96.1	17.04		
	13.0	11.8	121.9	19.30	109.8	17.66	103.2	17.06	99.7	16.29	96.8	15.80	90.3	14.85		
15.0	13.7	115.3	17.08	103.8	15.61	97.7	15.09	94.3	14.40	91.6	13.97	85.4	13.13			
60	-24.8	-25	108.6	53.37	108.6	54.05	108.0	55.06	104.7	52.20	101.1	49.52	94.6	46.99		
	-21.8	-22	116.6	54.38	115.5	55.06	108.4	52.20	104.7	49.52	101.1	46.99	94.6	44.56		
	-19.8	-20	122.0	55.06	115.5	53.04	108.4	50.29	104.7	47.73	101.1	45.31	94.6	42.94		
	-18.8	-19	122.0	54.05	115.5	52.03	108.4	49.33	104.7	46.82	101.1	44.47	94.6	42.12		
	-16.7	-17	122.0	51.90	115.5	49.89	108.4	47.33	104.7	44.95	101.1	42.71	94.6	40.42		
	-13.7	-15	122.0	48.82	115.5	46.87	108.4	44.47	104.7	42.27	101.1	40.19	94.6	37.99		
	-11.8	-13	122.0	46.89	115.5	44.94	108.4	42.65	104.7	40.57	101.1	38.60	94.6	36.45		
	-9.8	-11	122.0	44.85	115.5	42.92	108.4	40.75	104.7	38.78	101.1	36.91	94.6	34.82		
	-9.5	-10	122.0	44.53	115.5	42.63	108.4	40.46	104.7	38.51	101.1	36.66	94.6	34.58		
	-8.5	-9.1	122.0	43.52	115.5	41.61	108.4	39.51	104.7	37.62	101.1	35.81	94.6	33.77		
	-7.0	-7.6	122.0	41.99	115.5	40.09	108.4	38.08	104.7	36.28	101.1	34.55	94.6	32.55		
	-5.0	-5.6	122.0	39.94	115.5	38.07	108.4	36.17	104.7	34.49	101.1	32.88	94.6	30.93		
	-3.0	-3.7	122.0	37.90	115.5	36.04	108.4	34.26	104.7	32.71	101.1	31.19	94.6	29.30		
	0.0	-0.7	122.0	34.83	115.5	33.01	108.4	31.41	104.7	30.01	101.1	28.67	94.6	26.87		
	3.0	2.2	122.0	31.77	115.5	29.97	108.4	28.54	104.7	27.34	101.1	26.16	94.6	24.43		
	5.0	4.1	119.6	26.91	113.3	25.30	106.2	24.08	102.6	23.10	99.1	22.12	92.7	20.63		
	7.0	6.0	116.5	24.63	110.4	23.08	103.5	22.00	100.0	21.15	96.6	20.28	90.3	18.86		
	9.0	7.9	112.3	21.00	106.3	19.66	99.7	18.75	96.4	18.02	93.0	17.29	87.1	16.07		
	11.0	9.8	106.2	18.52	100.5	17.35	94.2	16.54	91.1	15.90	87.9	15.25	82.3	14.17		
	13.0	11.8	99.7	16.12	94.5	15.11	88.5	14.39	85.5	13.84	82.6	13.27	77.3	12.35		
15.0	13.7	94.3	14.40	89.3	13.48	83.8	12.73	81.0	12.24	78.2	11.74	73.1	11.02			
50	-24.8	-25	101.8	46.84	96.0	47.85	90.3	45.31	87.4	42.93	84.5	40.69	78.7	38.60		
	-21.8	-22	101.8	47.85	96.0	45.31	90.3	42.93	87.4	40.69	84.5	38.60	78.7	36.59		
	-19.8	-20	101.8	46.08	96.0	43.61	90.3	41.35	87.4	39.18	84.5	37.20	78.7	35.25		
	-18.8	-19	101.8	45.19	96.0	42.76	90.3	40.56	87.4	38.44	84.5	36.51	78.7	34.58		
	-16.7	-17	101.8	43.33	96.0	40.99	90.3	38.91	87.4	36.87	84.5	35.04	78.7	33.17		
	-13.7	-15	101.8	40.68	96.0	38.44	90.3	36.52	87.4	34.63	84.5	32.96	78.7	31.16		
	-11.8	-13	101.8	39.00	96.0	36.83	90.3	35.02	87.4	33.20	84.5	31.63	78.7	29.89		
	-9.8	-11	101.8	37.22	96.0	35.14	90.3	33.43	87.4	31.70	84.5	30.24	78.7	28.54		
	-9.5	-10	101.8	36.95	96.0	34.89	90.3	33.20	87.4	31.48	84.5	30.04	78.7	28.35		
	-8.5	-9.1	101.8	36.06	96.0	34.04	90.3	32.41	87.4	30.73	84.5	29.34	78.7	27.68		
	-7.0	-7.6	101.8	34.74	96.0	32.78	90.3	31.22	87.4	29.62	84.5	28.29	78.7	26.67		
	-5.0	-5.6	101.8	32.96	96.0	31.08	90.3	29.64	87.4	28.11	84.5	26.90	78.7	25.34		
	-3.0	-3.7	101.8	31.19	96.0	29.38	90.3	28.05	87.4	26.62	84.5	25.50	78.7	24.00		
	0.0	-0.7	101.8	28.53	96.0	26.83	90.3	25.68	87.4	24.37	84.5	23.41	78.7	21.98		
	3.0	2.2	101.8	25.88	96.0	24.30	90.3	23.31	87.4	22.12	84.5	21.33	78.7	19.97		
	5.0	4.1	99.8	21.82	94.2	20.44	88.4	19.65	85.6	18.66	82.8	18.02	77.2	16.85		
	7.0	6.0	97.3	19.88	91.7	18.61	86.2	17.93	83.5	17.02	80.7	16.50	75.2	15.39		
	9.0	7.9	93.7	17.11	88.4	16.02	83.0	15.44	80.4	14.67	77.7	14.22	72.5	13.26		
	11.0	9.8	89.1	15.28	84.0	14.30	78.9	13.78	75.9	13.08	73.5	12.68	68.6	11.83		
	13.0	11.8	83.2	13.16	78.5	12.32	73.8	11.86	71.4	11.34	69.1	10.93	64.3	10.25		
15.0	13.7	78.7	11.78	74.3	11.02	69.8	10.61	67.6	10.10	65.4	9.77	60.8	9.12			

**Note**

1. TC: Total Capacity(kW), PI : Power Input(kW, Comp. + Outdoor fan motor)
2. Capacity tables show the average value of conditions which may occur.
3. The heating capacity table is based on the values expressed as Max. in the specification of the outdoor unit. (When measuring the Max. heating capacity, the setting status of the indoor unit is the same as that for measuring the heating capacity of the indoor unit.)

# 7. Capacity Tables

## ◆ ARUM600LTE5

Heating Capacity (60HP)

Combination (%)	Outdoor air temp.		Indoor air temp. °C DB											
			16		18		20		21		22		24	
	°C DB	°C WB	TC	PI	TC	PI	TC	PI	TC	PI	TC	PI	TC	PI
130	-24.8	-25	114.7	62.9	114.7	63.50	114.0	64.05	114.0	64.87	114.0	65.69	112.3	66.96
	-21.8	-22	140.4	64.12	140.4	64.75	139.4	65.30	139.4	66.14	139.4	66.96	137.1	68.20
	-19.8	-20	148.4	64.96	148.4	65.60	147.4	66.14	147.4	66.99	147.4	67.78	145.1	69.05
	-18.8	-19	151.9	65.39	151.9	66.02	150.9	66.57	150.9	67.41	150.9	68.20	148.4	69.47
	-16.7	-17	159.0	66.27	159.0	66.90	158.0	67.45	158.0	68.29	158.0	69.10	155.4	70.35
	-13.7	-15	169.1	67.54	169.1	68.17	168.1	68.72	168.1	69.56	168.1	70.35	165.3	67.66
	-11.8	-13	174.6	68.35	174.6	68.96	173.6	69.51	173.6	70.35	173.6	68.55	171.6	65.95
	-9.8	-11	180.4	69.17	180.4	69.81	179.3	70.35	179.3	68.43	179.3	66.64	177.9	64.16
	-9.5	-10	181.4	69.32	181.4	69.93	180.4	70.06	180.4	68.13	180.1	66.35	178.9	63.87
	-8.5	-9.1	185.1	69.72	185.1	70.35	184.1	69.06	184.1	67.15	183.1	65.39	182.1	62.97
	-7.0	-7.6	190.7	70.35	190.7	68.90	189.4	67.58	189.4	65.70	189.4	63.94	187.4	61.63
	-5.0	-5.6	198.1	68.47	198.1	66.95	196.8	65.58	196.8	63.75	196.8	62.03	193.9	59.83
	-3.0	-3.7	205.5	66.58	205.5	65.01	204.2	63.59	204.2	61.80	204.2	60.12	200.5	58.02
	0.0	-0.7	216.5	63.73	216.5	62.09	215.1	60.62	215.1	58.89	215.1	57.25	210.3	55.33
	3.0	2.2	227.6	60.90	227.6	59.15	226.1	57.63	226.1	55.98	224.6	54.36	210.5	52.64
	5.0	4.1	230.2	53.62	229.7	51.92	228.3	50.44	227.1	48.91	221.5	47.43	206.2	45.90
	7.0	6.0	229.6	50.81	229.1	49.18	227.9	47.76	223.8	46.37	215.8	44.98	201.0	43.64
	9.0	7.9	222.0	47.25	221.5	45.72	221.0	44.38	215.5	43.09	208.0	41.81	193.7	40.57
	11.0	9.8	210.0	44.24	209.5	42.82	209.0	41.56	203.7	40.35	196.7	39.17	183.1	37.98
	13.0	11.8	197.2	40.62	196.9	39.32	196.2	38.17	191.4	37.06	184.7	35.96	171.9	34.87
15.0	13.7	186.6	37.60	186.2	36.38	185.6	35.33	181.1	34.30	174.8	33.28	162.6	32.27	
120	-24.8	-25	114.0	63.50	114.0	64.05	113.2	64.87	113.2	65.69	113.2	66.96	111.5	67.84
	-21.8	-22	139.4	64.75	139.4	65.30	138.4	66.14	138.4	66.96	138.4	68.20	136.3	69.10
	-19.8	-20	147.4	65.60	147.4	66.14	146.4	66.99	146.4	67.78	146.4	69.05	144.1	69.93
	-18.8	-19	150.7	66.02	150.7	66.57	149.7	67.41	149.7	68.20	149.7	69.47	147.4	70.35
	-16.7	-17	157.8	66.90	157.8	67.45	156.8	68.29	156.8	69.10	156.8	70.35	154.2	68.62
	-13.7	-15	167.8	68.17	167.8	68.72	166.8	69.56	166.8	70.35	166.8	67.76	164.1	66.14
	-11.8	-13	173.3	68.96	173.3	69.51	172.3	70.35	172.3	68.52	172.3	66.12	170.3	64.58
	-9.8	-11	179.1	69.81	179.1	70.35	178.1	68.33	178.1	66.59	178.1	64.40	176.7	62.92
	-9.5	-10	180.2	69.93	180.2	70.03	179.2	68.04	179.2	66.30	179.2	64.14	177.8	62.66
	-8.5	-9.1	183.9	70.35	183.9	68.96	182.6	67.02	182.6	65.34	182.6	63.29	181.0	61.84
	-7.0	-7.6	189.4	68.76	189.4	67.36	188.2	65.51	188.2	63.89	188.0	61.99	186.1	60.60
	-5.0	-5.6	196.8	66.63	196.8	65.22	195.5	63.49	195.5	61.95	195.5	60.25	192.7	58.94
	-3.0	-3.7	204.0	64.50	204.0	63.10	202.7	61.46	202.7	60.04	202.7	58.53	197.7	57.28
	0.0	-0.7	215.0	61.31	215.0	59.89	213.5	58.43	213.5	57.13	212.3	55.94	197.7	54.80
	3.0	2.2	225.9	58.12	225.9	56.68	223.7	55.40	219.5	54.24	212.7	53.35	197.7	52.33
	5.0	4.1	228.6	50.82	227.4	49.46	222.5	48.34	215.2	47.31	208.5	46.60	193.7	45.69
	7.0	6.0	228.2	47.93	225.8	46.64	217.0	45.71	209.7	44.84	203.2	44.42	188.7	43.62
	9.0	7.9	220.5	44.44	217.5	43.23	209.0	42.38	202.0	41.57	195.7	41.16	181.9	40.43
	11.0	9.8	208.5	41.49	205.7	40.35	197.7	39.55	190.9	38.80	185.1	38.44	171.9	37.76
	13.0	11.8	195.9	37.96	193.2	36.92	185.6	36.20	179.4	35.50	173.9	35.17	161.5	34.54
15.0	13.7	185.4	34.99	182.9	34.03	175.6	33.36	169.8	32.74	164.6	32.43	152.8	31.85	
110	-24.8	-25	113.4	64.05	113.4	64.87	112.7	65.69	112.7	66.96	112.7	67.84	110.8	68.26
	-21.8	-22	138.7	65.30	138.7	66.14	137.7	66.96	137.7	68.20	137.7	69.10	135.6	69.51
	-19.8	-20	146.6	66.14	146.6	66.99	145.7	67.78	145.7	69.05	145.7	69.93	143.3	70.35
	-18.8	-19	149.9	66.57	149.9	67.41	148.9	68.20	148.9	69.47	148.9	70.35	146.6	69.44
	-16.7	-17	157.0	67.45	157.0	68.29	156.0	69.10	156.0	70.35	156.0	68.49	153.4	67.51
	-13.7	-15	166.9	68.72	166.9	69.56	165.8	70.35	165.8	67.52	165.8	65.79	165.8	64.77
	-11.8	-13	172.4	69.51	172.4	70.35	171.3	68.35	171.3	65.71	171.3	64.09	171.3	63.03
	-9.8	-11	178.1	70.35	178.1	68.09	177.1	66.25	177.1	63.82	177.1	62.31	176.5	61.20
	-9.5	-10	179.2	69.98	179.2	67.74	178.2	65.91	178.2	63.53	178.2	62.05	177.6	60.93
	-8.5	-9.1	182.9	68.77	182.9	66.61	181.8	64.86	181.8	62.58	181.8	61.13	177.9	60.00
	-7.0	-7.6	188.4	66.92	188.4	64.92	187.2	63.28	187.2	61.16	187.2	59.80	177.9	58.64
	-5.0	-5.6	195.6	64.48	195.6	62.63	194.3	61.17	194.3	59.27	190.4	58.01	177.9	56.79
	-3.0	-3.7	202.9	62.03	202.9	60.37	201.5	59.04	197.2	57.36	190.4	56.21	177.9	54.97
	0.0	-0.7	213.8	58.35	213.4	56.97	203.7	55.88	197.2	54.52	190.4	53.54	177.9	52.23
	3.0	2.2	224.2	54.68	217.2	53.56	203.7	52.70	197.2	51.69	190.4	50.84	177.9	49.47
	5.0	4.1	225.3	47.39	212.8	46.47	199.7	45.77	193.2	44.97	186.7	44.27	174.4	42.98
	7.0	6.0	219.5	44.30	207.5	43.64	194.7	43.15	188.4	42.62	181.9	42.08	169.9	40.76
	9.0	7.9	211.5	40.85	199.7	40.24	187.4	39.78	181.4	39.30	175.3	38.81	163.6	37.60
	11.0	9.8	199.9	37.92	188.9	37.34	177.4	36.92	171.6	36.49	165.8	36.01	154.8	34.89
	13.0	11.8	187.7	34.48	177.4	33.95	166.6	33.56	161.1	33.15	155.6	32.74	145.3	31.73
15.0	13.7	177.6	31.52	167.8	31.05	157.6	30.69	152.3	30.33	147.3	29.94	137.5	29.01	

# 7. Capacity Tables

Heating Capacity (60HP)

Combination (%)	Outdoor air temp.		Indoor air temp. °C DB											
			16		18		20		21		22		24	
	°C DB	°C WB	TC	PI	TC	PI	TC	PI	TC	PI	TC	PI	TC	PI
100	-24.8	-25	112.9	71.30	112.9	71.18	112.2	66.81	112.2	70.87	112.2	70.74	110.3	70.68
	-21.8	-22	137.9	71.11	137.9	70.99	137.2	68.92	137.2	70.68	137.2	71.56	134.8	70.49
	-19.8	-20	145.9	70.99	145.9	70.85	145.1	70.25	145.1	70.56	145.1	70.76	142.8	70.35
	-18.8	-19	149.2	70.93	148.4	70.80	148.4	70.68	148.4	70.48	148.4	70.35	145.9	69.24
	-16.7	-17	155.3	70.80	155.3	70.67	155.3	71.56	154.5	70.35	154.5	68.05	151.9	66.90
	-13.7	-15	166.1	70.61	166.1	70.47	165.1	70.35	165.1	67.01	165.1	64.75	162.6	63.53
	-11.8	-13	171.6	70.49	170.6	70.35	170.6	68.11	170.6	64.88	170.6	62.65	162.6	61.41
	-9.8	-11	177.1	70.35	177.1	67.84	176.4	65.74	176.4	62.65	174.4	60.46	162.6	59.17
	-9.5	-10	178.2	69.96	178.2	67.45	177.4	65.39	177.4	62.31	174.4	60.12	162.6	58.84
	-8.5	-9.1	181.9	68.64	181.9	66.20	181.1	64.20	180.4	61.19	174.4	59.03	162.6	57.71
	-7.0	-7.6	190.4	66.67	189.7	64.31	186.4	62.42	180.4	59.53	174.4	57.38	162.6	56.03
	-5.0	-5.6	198.7	64.02	196.7	61.80	186.4	60.07	180.4	57.28	174.4	55.18	162.6	53.79
	-3.0	-3.7	204.5	61.39	198.4	59.27	186.4	57.70	180.4	55.04	174.4	52.99	162.6	51.55
	0.0	-0.7	210.2	57.43	198.4	55.50	186.4	54.15	180.4	51.70	174.4	49.68	162.6	48.20
	3.0	2.2	210.2	53.46	198.4	51.71	186.4	50.60	180.4	48.35	174.4	46.38	162.6	44.85
	5.0	4.1	206.0	46.15	194.4	44.61	182.6	43.67	176.9	41.70	171.1	39.91	159.3	38.49
	7.0	6.0	200.7	42.88	189.4	41.54	178.1	40.81	172.3	39.05	166.6	37.37	155.3	35.93
	9.0	7.9	193.4	39.32	182.4	38.08	171.6	37.42	166.1	35.80	160.6	34.24	149.5	32.93
	11.0	9.8	182.9	36.24	172.6	35.08	162.1	34.48	157.0	32.98	151.8	31.56	141.5	30.35
	13.0	11.8	171.8	32.66	162.1	31.63	152.3	31.08	147.5	29.74	142.5	28.46	132.7	27.36
15.0	13.7	162.6	29.59	153.3	28.66	144.0	28.16	139.5	26.93	134.9	25.77	125.7	24.79	
90	-24.8	-25	112.4	63.18	112.4	64.43	111.7	65.33	111.7	65.73	111.7	66.58	110.0	67.85
	-21.8	-22	137.4	64.43	137.4	65.70	136.7	66.58	136.7	67.00	136.7	67.85	134.3	64.91
	-19.8	-20	145.4	65.28	145.4	66.54	144.4	67.42	144.4	67.85	144.4	68.83	142.1	62.95
	-18.8	-19	149.2	65.70	148.4	66.97	147.7	67.85	147.7	66.82	147.7	64.83	145.4	61.98
	-16.7	-17	155.3	66.58	155.3	67.85	154.7	65.71	154.7	64.64	154.7	62.73	148.5	59.92
	-13.7	-15	166.1	67.85	166.1	64.65	164.6	62.65	164.6	61.54	160.0	59.71	148.5	56.98
	-11.8	-13	171.6	65.65	170.6	62.64	169.9	60.70	165.3	59.57	160.0	57.81	148.5	55.12
	-9.8	-11	177.1	63.37	177.1	60.53	170.6	58.67	165.3	57.49	160.0	55.80	148.5	53.16
	-9.5	-10	178.2	63.01	178.2	60.19	170.6	58.36	165.3	57.18	160.0	55.49	148.5	52.86
	-8.5	-9.1	181.9	61.87	180.6	59.14	170.6	57.33	165.3	56.15	160.0	54.49	148.5	51.88
	-7.0	-7.6	190.4	60.14	181.1	57.54	170.6	55.81	165.3	54.59	160.0	52.98	148.5	50.41
	-5.0	-5.6	192.4	57.84	181.1	55.42	170.6	53.78	165.3	52.54	160.0	50.98	148.5	48.47
	-3.0	-3.7	192.4	55.54	181.1	53.31	170.6	51.73	165.3	50.46	160.0	48.96	148.5	46.50
	0.0	-0.7	192.4	52.10	181.1	50.11	170.6	48.67	165.3	47.36	160.0	45.95	148.5	43.57
	3.0	2.2	192.4	48.63	181.1	46.92	170.6	45.61	165.3	44.26	160.0	42.95	148.5	40.62
	5.0	4.1	188.7	41.96	177.6	40.51	167.1	39.35	162.0	38.11	156.8	36.95	145.5	34.87
	7.0	6.0	183.9	39.20	173.1	37.98	162.8	36.96	157.8	35.71	152.8	34.64	142.0	32.66
	9.0	7.9	177.1	35.92	166.6	34.83	156.8	33.88	152.0	32.72	147.2	31.75	136.7	29.95
	11.0	9.8	167.6	32.79	157.6	31.77	148.3	30.91	143.8	29.87	139.2	28.98	129.2	27.31
	13.0	11.8	157.3	28.95	148.0	28.06	139.3	27.32	135.0	26.38	130.7	25.59	121.4	24.13
15.0	13.7	148.8	25.95	140.0	25.15	131.9	24.48	127.7	23.65	123.7	22.94	114.9	21.63	
80	-24.8	-25	111.9	55.49	111.9	56.76	111.2	57.64	111.2	58.06	111.2	60.16	109.5	57.58
	-21.8	-22	135.9	56.76	135.9	58.01	135.9	58.89	135.9	60.16	135.9	57.58	132.7	55.09
	-19.8	-20	143.9	57.59	143.9	58.85	143.9	60.16	143.9	58.34	142.5	55.85	132.7	53.44
	-18.8	-19	147.2	58.01	147.2	60.16	147.2	59.23	147.2	57.42	142.7	54.98	132.7	52.62
	-16.7	-17	152.5	60.16	152.5	58.23	152.5	57.29	148.0	55.51	142.7	53.19	132.7	50.89
	-13.7	-15	159.5	57.30	156.3	55.46	152.5	54.52	148.0	52.77	142.7	50.59	132.7	48.40
	-11.8	-13	163.4	55.47	158.6	53.71	152.5	52.75	148.0	51.03	142.7	48.96	132.7	46.82
	-9.8	-11	167.7	53.56	160.9	51.88	152.5	50.90	148.0	49.22	142.7	47.23	132.7	45.17
	-9.5	-10	168.9	53.28	161.8	51.60	152.5	50.62	148.0	48.94	142.7	46.97	132.7	44.93
	-8.5	-9.1	170.7	52.33	162.6	50.68	152.5	49.70	148.0	48.02	142.7	46.12	132.7	44.10
	-7.0	-7.6	172.4	50.89	162.6	49.29	152.5	48.31	148.0	46.66	142.7	44.83	132.7	42.85
	-5.0	-5.6	172.4	48.98	162.6	47.47	152.5	46.45	148.0	44.82	142.7	43.09	132.7	41.20
	-3.0	-3.7	172.4	47.07	162.6	45.62	152.5	44.60	148.0	43.01	142.7	41.38	132.7	39.54
	0.0	-0.7	172.4	44.19	162.6	42.87	152.5	41.83	148.0	40.27	142.7	38.78	132.7	37.07
	3.0	2.2	172.4	41.33	162.6	40.09	152.5	39.04	148.0	37.51	142.7	36.20	132.7	34.58
	5.0	4.1	168.9	35.64	159.3	34.56	149.5	33.60	145.0	32.23	139.7	31.10	130.2	29.71
	7.0	6.0	164.6	33.37	155.3	32.42	145.7	31.45	141.3	30.15	136.2	29.15	126.7	27.83
	9.0	7.9	158.6	29.74	149.5	28.92	140.3	28.20	136.2	27.12	131.2	26.15	122.2	24.91
	11.0	9.8	150.0	26.29	141.3	25.57	132.7	24.93	128.7	23.97	124.2	23.12	115.4	22.01
	13.0	11.8	140.8	22.71	132.7	22.07	124.7	21.53	120.9	20.69	116.6	19.95	108.4	19.01
15.0	13.7	133.2	20.34	125.7	19.76	117.9	19.28	114.4	18.53	110.4	17.88	102.6	17.03	

# 7. Capacity Tables

Heating Capacity (60HP)

Combination (%)	Outdoor air temp.		Indoor air temp. °C DB													
			16		18		20		21		22		24			
	°C DB	°C WB	TC	PI	TC	PI	TC	PI	TC	PI	TC	PI	TC	PI		
70	-24.8	-25	111.9	56.07	111.9	56.49	111.2	57.34	111.2	58.61	111.2	58.61	111.2	55.81	109.4	53.18
	-21.8	-22	130.7	57.34	130.7	57.76	129.9	58.61	125.4	55.81	121.7	53.18	113.6	50.66		
	-19.8	-20	143.2	58.19	138.0	58.61	129.9	56.64	125.4	53.94	121.7	51.44	113.6	48.98		
	-18.8	-19	146.0	58.61	138.0	57.59	129.9	55.65	125.4	53.00	121.7	50.56	113.6	48.12		
	-16.7	-17	146.2	56.48	138.0	55.44	129.9	53.60	125.4	51.04	121.7	48.74	113.6	46.36		
	-13.7	-15	146.2	53.48	138.0	52.40	129.9	50.64	125.4	48.25	121.7	46.12	113.6	43.82		
	-11.8	-13	146.2	51.55	138.0	50.47	129.9	48.77	125.4	46.46	121.7	44.45	113.6	42.23		
	-9.8	-11	146.2	49.55	138.0	48.43	129.9	46.82	125.4	44.59	121.7	42.71	113.6	40.54		
	-9.5	-10	146.2	49.24	138.0	48.12	129.9	46.52	125.4	44.32	121.7	42.46	113.6	40.29		
	-8.5	-9.1	146.2	48.25	138.0	47.11	129.9	45.53	125.4	43.38	121.7	41.58	113.6	39.44		
	-7.0	-7.6	146.2	46.73	138.0	45.59	129.9	44.06	125.4	41.99	121.7	40.27	113.6	38.18		
	-5.0	-5.6	146.2	44.72	138.0	43.56	129.9	42.09	125.4	40.12	121.7	38.52	113.6	36.49		
	-3.0	-3.7	146.2	42.72	138.0	41.51	129.9	40.12	125.4	38.25	121.7	36.78	113.6	34.80		
	0.0	-0.7	146.2	39.70	138.0	38.47	129.9	37.18	125.4	35.45	121.7	34.16	113.6	32.28		
	3.0	2.2	146.2	36.68	138.0	35.42	129.9	34.22	125.4	32.67	121.7	31.54	113.6	29.74		
	5.0	4.1	146.2	32.03	135.2	30.18	127.2	29.17	122.9	27.80	119.2	26.91	111.4	25.35		
	7.0	6.0	146.3	30.52	131.7	27.90	124.0	26.96	119.7	25.74	116.2	24.96	108.4	23.47		
	9.0	7.9	141.0	26.31	127.0	24.03	119.4	23.23	115.4	22.18	111.9	21.50	104.4	20.22		
	11.0	9.8	133.4	23.21	120.2	21.21	112.9	20.51	109.1	19.57	105.9	18.99	98.8	17.85		
	13.0	11.8	125.2	20.22	112.9	18.50	106.1	17.87	102.4	17.06	99.4	16.54	92.8	15.55		
15.0	13.7	118.4	17.90	106.6	16.35	100.4	15.81	96.9	15.09	94.1	14.64	87.8	13.76			
60	-24.8	-25	111.3	55.22	111.3	56.07	110.6	57.34	107.6	54.37	103.9	51.59	97.3	48.97		
	-21.8	-22	119.7	56.49	118.7	57.34	111.4	54.37	107.6	51.59	103.9	48.97	97.3	46.45		
	-19.8	-20	125.4	57.34	118.7	55.24	111.4	52.39	107.6	49.74	103.9	47.22	97.3	44.76		
	-18.8	-19	125.4	56.29	118.7	54.19	111.4	51.39	107.6	48.79	103.9	46.35	97.3	43.91		
	-16.7	-17	125.4	54.06	118.7	51.98	111.4	49.32	107.6	46.85	103.9	44.53	97.3	42.14		
	-13.7	-15	125.4	50.87	118.7	48.85	111.4	46.36	107.6	44.07	103.9	41.91	97.3	39.62		
	-11.8	-13	125.4	48.87	118.7	46.85	111.4	44.46	107.6	42.30	103.9	40.26	97.3	38.03		
	-9.8	-11	125.4	46.76	118.7	44.75	111.4	42.49	107.6	40.45	103.9	38.51	97.3	36.33		
	-9.5	-10	125.4	46.43	118.7	44.45	111.4	42.19	107.6	40.17	103.9	38.24	97.3	36.08		
	-8.5	-9.1	125.4	45.38	118.7	43.40	111.4	41.21	107.6	39.25	103.9	37.36	97.3	35.24		
	-7.0	-7.6	125.4	43.80	118.7	41.82	111.4	39.73	107.6	37.85	103.9	36.06	97.3	33.97		
	-5.0	-5.6	125.4	41.67	118.7	39.72	111.4	37.74	107.6	36.00	103.9	34.32	97.3	32.29		
	-3.0	-3.7	125.4	39.56	118.7	37.62	111.4	35.76	107.6	34.15	103.9	32.57	97.3	30.60		
	0.0	-0.7	125.4	36.38	118.7	34.48	111.4	32.81	107.6	31.35	103.9	29.95	97.3	28.08		
	3.0	2.2	125.4	33.20	118.7	31.33	111.4	29.83	107.6	28.58	103.9	27.35	97.3	25.54		
	5.0	4.1	122.9	28.14	116.4	26.45	109.1	25.18	105.4	24.15	101.8	23.14	95.3	21.58		
	7.0	6.0	119.7	25.78	113.4	24.15	106.4	23.03	102.8	22.13	99.3	21.22	92.8	19.74		
	9.0	7.9	115.4	21.99	109.2	20.58	102.4	19.63	99.1	18.86	95.6	18.10	89.5	16.82		
	11.0	9.8	109.1	19.40	103.3	18.17	96.8	17.32	93.6	16.65	90.3	15.97	84.6	14.84		
	13.0	11.8	102.4	16.89	97.1	15.82	91.0	15.07	87.8	14.50	84.8	13.90	79.5	12.94		
15.0	13.7	96.9	15.09	91.8	14.12	86.1	13.33	83.3	12.83	80.3	12.31	75.2	11.55			
50	-24.8	-25	104.6	48.68	98.6	49.95	92.8	47.30	89.8	44.82	86.8	42.48	80.8	40.31		
	-21.8	-22	104.6	49.95	98.6	47.30	92.8	44.82	89.8	42.48	86.8	40.31	80.8	38.22		
	-19.8	-20	104.6	48.10	98.6	45.53	92.8	43.18	89.8	40.91	86.8	38.85	80.8	36.81		
	-18.8	-19	104.6	47.17	98.6	44.64	92.8	42.35	89.8	40.15	86.8	38.12	80.8	36.11		
	-16.7	-17	104.6	45.24	98.6	42.80	92.8	40.63	89.8	38.51	86.8	36.60	80.8	34.65		
	-13.7	-15	104.6	42.48	98.6	40.14	92.8	38.15	89.8	36.17	86.8	34.43	80.8	32.56		
	-11.8	-13	104.6	40.73	98.6	38.47	92.8	36.58	89.8	34.68	86.8	33.05	80.8	31.23		
	-9.8	-11	104.6	38.88	98.6	36.70	92.8	34.92	89.8	33.12	86.8	31.59	80.8	29.82		
	-9.5	-10	104.6	38.60	98.6	36.45	92.8	34.69	89.8	32.89	86.8	31.39	80.8	29.62		
	-8.5	-9.1	104.6	37.66	98.6	35.56	92.8	33.86	89.8	32.11	86.8	30.66	80.8	28.92		
	-7.0	-7.6	104.6	36.29	98.6	34.25	92.8	32.62	89.8	30.95	86.8	29.57	80.8	27.88		
	-5.0	-5.6	104.6	34.44	98.6	32.48	92.8	30.98	89.8	29.38	86.8	28.11	80.8	26.48		
	-3.0	-3.7	104.6	32.59	98.6	30.71	92.8	29.31	89.8	27.82	86.8	26.65	80.8	25.09		
	0.0	-0.7	104.6	29.83	98.6	28.05	92.8	26.84	89.8	25.48	86.8	24.48	80.8	22.98		
	3.0	2.2	104.6	27.07	98.6	25.42	92.8	24.38	89.8	23.13	86.8	22.31	80.8	20.89		
	5.0	4.1	102.6	22.83	96.8	21.38	90.8	20.55	88.0	19.52	85.1	18.85	79.3	17.63		
	7.0	6.0	99.9	20.81	94.3	19.47	88.6	18.76	85.8	17.81	83.0	17.27	77.3	16.10		
	9.0	7.9	96.3	17.91	90.8	16.77	85.3	16.16	82.6	15.36	79.8	14.88	74.5	13.88		
	11.0	9.8	91.6	16.00	86.3	14.98	81.0	14.43	78.0	13.70	75.5	13.27	70.5	12.38		
	13.0	11.8	85.5	13.78	80.6	12.91	75.8	12.43	73.3	11.88	71.0	11.45	66.0	10.74		
15.0	13.7	80.8	12.34	76.3	11.55	71.7	11.12	69.5	10.58	67.2	10.24	62.5	9.55			

**Note**

1. TC: Total Capacity(kW), PI : Power Input(kW, Comp. + Outdoor fan motor)
2. Capacity tables show the average value of conditions which may occur.
3. The heating capacity table is based on the values expressed as Max. in the specification of the outdoor unit. (When measuring the Max. heating capacity, the setting status of the indoor unit is the same as that for measuring the heating capacity of the indoor unit.)

# 7. Capacity Tables

## ◆ ARUM620LTE5

Heating Capacity (62HP)

Combination (%)	Outdoor air temp.		Indoor air temp. °C DB											
			16		18		20		21		22		24	
	°C DB	°C WB	TC	PI	TC	PI	TC	PI	TC	PI	TC	PI	TC	PI
130	-24.8	-25	118.1	64.5	118.1	65.06	117.4	65.54	117.4	66.26	117.4	66.97	115.2	68.08
	-21.8	-22	145.3	65.60	145.3	66.15	144.2	66.63	144.2	67.37	144.2	68.08	141.4	69.17
	-19.8	-20	153.9	66.34	153.9	66.89	152.9	67.37	152.9	68.11	152.9	68.80	150.0	69.91
	-18.8	-19	157.5	66.71	157.5	67.26	156.5	67.74	156.5	68.48	156.5	69.17	153.4	70.28
	-16.7	-17	164.9	67.48	164.9	68.03	163.8	68.51	163.8	69.25	163.8	69.96	160.7	71.05
	-13.7	-15	175.3	68.59	175.3	69.14	174.3	69.62	174.3	70.36	174.3	71.05	170.9	68.47
	-11.8	-13	181.0	69.30	181.0	69.83	180.0	70.31	180.0	71.05	180.0	69.33	177.4	66.83
	-9.8	-11	187.0	70.02	187.0	70.57	185.9	71.05	185.9	69.23	185.9	67.51	184.2	65.11
	-9.5	-10	188.1	70.15	188.1	70.68	187.0	70.77	187.0	68.95	186.8	67.23	185.3	64.83
	-8.5	-9.1	191.7	70.50	191.7	71.05	190.6	69.84	190.6	68.01	189.8	66.32	188.7	63.97
	-7.0	-7.6	197.1	71.05	197.1	69.71	195.8	68.44	195.8	66.64	195.8	64.93	193.7	62.68
	-5.0	-5.6	204.4	69.32	204.4	67.88	203.1	66.57	203.1	64.80	203.1	63.11	200.5	60.96
	-3.0	-3.7	211.6	67.60	211.6	66.08	210.3	64.70	210.3	62.95	210.3	61.29	207.3	59.22
	0.0	-0.7	222.5	64.99	222.5	63.37	221.0	61.91	221.0	60.19	221.0	58.55	217.4	56.64
	3.0	2.2	233.4	62.40	233.4	60.64	231.8	59.10	231.8	57.43	231.8	55.80	217.6	54.05
	5.0	4.1	236.2	55.11	235.7	53.37	234.2	51.86	234.2	50.30	229.0	48.79	213.2	47.23
	7.0	6.0	237.0	52.43	236.5	50.74	235.2	49.28	231.3	47.85	223.1	46.41	207.7	45.03
	9.0	7.9	229.5	48.94	229.0	47.36	228.5	45.98	222.8	44.64	215.0	43.31	200.2	42.02
	11.0	9.8	217.1	46.04	216.6	44.55	216.0	43.25	210.6	41.99	203.3	40.75	189.3	39.52
	13.0	11.8	203.9	42.48	203.6	41.12	202.8	39.91	197.9	38.76	190.9	37.60	177.7	36.47
15.0	13.7	192.9	39.54	192.5	38.26	191.9	37.16	187.2	36.08	180.7	35.00	168.1	33.94	
120	-24.8	-25	117.3	65.06	117.3	65.54	116.6	66.26	116.6	66.97	116.6	68.08	114.4	68.85
	-21.8	-22	144.2	66.15	144.2	66.63	143.2	67.37	143.2	68.08	143.2	69.17	140.6	69.96
	-19.8	-20	152.8	66.89	152.8	67.37	151.8	68.11	151.8	68.80	151.8	69.91	148.9	70.68
	-18.8	-19	156.3	67.26	156.3	67.74	155.2	68.48	155.2	69.17	155.2	70.28	152.3	71.05
	-16.7	-17	163.6	68.03	163.6	68.51	162.6	69.25	162.6	69.96	162.6	71.05	159.4	69.38
	-13.7	-15	174.0	69.14	174.0	69.62	173.0	70.36	173.0	71.05	173.0	68.57	169.6	67.00
	-11.8	-13	179.7	69.83	179.7	70.31	178.7	71.05	178.7	69.30	178.7	67.00	176.1	65.51
	-9.8	-11	185.7	70.57	185.7	71.05	184.6	69.13	184.6	67.46	184.6	65.36	182.9	63.92
	-9.5	-10	186.8	70.68	186.8	70.75	185.7	68.85	185.7	67.18	185.7	65.11	184.0	63.67
	-8.5	-9.1	190.4	71.05	190.4	69.74	189.1	67.89	189.1	66.27	189.1	64.29	187.2	62.88
	-7.0	-7.6	195.8	69.56	195.8	68.22	194.5	66.45	194.5	64.88	194.5	63.06	192.4	61.69
	-5.0	-5.6	203.0	67.56	203.0	66.19	201.7	64.52	201.7	63.03	201.7	61.39	199.2	60.10
	-3.0	-3.7	210.1	65.56	210.1	64.19	208.8	62.60	208.8	61.21	208.8	59.74	204.4	58.51
	0.0	-0.7	220.9	62.57	220.9	61.15	219.4	59.72	219.4	58.43	219.4	57.27	204.4	56.13
	3.0	2.2	231.6	59.57	231.6	58.11	230.2	56.83	227.0	55.67	219.9	54.79	204.4	53.75
	5.0	4.1	234.7	52.24	233.9	50.85	230.1	49.72	222.5	48.66	215.5	47.96	200.2	47.03
	7.0	6.0	235.7	49.46	233.4	48.12	224.3	47.17	216.8	46.26	210.1	45.83	195.1	45.01
	9.0	7.9	228.0	46.02	224.9	44.77	216.0	43.89	208.8	43.05	202.3	42.63	188.0	41.87
	11.0	9.8	215.5	43.14	212.7	41.96	204.4	41.14	197.4	40.35	191.4	39.98	177.7	39.27
	13.0	11.8	202.5	39.66	199.7	38.58	191.9	37.83	185.4	37.10	179.7	36.75	167.0	36.09
15.0	13.7	191.6	36.76	189.0	35.75	181.5	35.05	175.6	34.39	170.1	34.07	157.9	33.46	
110	-24.8	-25	116.8	65.54	116.8	66.26	116.0	66.97	116.0	68.08	116.0	68.85	113.7	69.22
	-21.8	-22	143.4	66.63	143.4	67.37	142.4	68.08	142.4	69.17	142.4	69.96	139.8	70.31
	-19.8	-20	152.1	67.37	152.1	68.11	151.0	68.80	151.0	69.91	151.0	70.68	148.2	71.05
	-18.8	-19	155.5	67.74	155.5	68.48	154.4	69.17	154.4	70.28	154.4	71.05	151.6	70.17
	-16.7	-17	162.8	68.51	162.8	69.25	161.8	69.96	161.8	71.05	161.8	69.25	158.6	68.30
	-13.7	-15	173.0	69.62	173.0	70.36	172.0	71.05	172.0	68.32	172.0	66.65	172.0	65.64
	-11.8	-13	178.7	70.31	178.7	71.05	177.7	69.13	177.7	66.58	177.7	65.01	177.7	63.95
	-9.8	-11	184.7	71.05	184.7	68.88	183.6	67.10	183.6	64.75	183.6	63.29	183.0	62.18
	-9.5	-10	185.7	70.70	185.7	68.55	184.7	66.78	184.7	64.48	184.7	63.03	183.9	61.92
	-8.5	-9.1	189.3	69.53	189.3	67.46	188.3	65.77	188.3	63.57	188.3	62.15	183.9	61.02
	-7.0	-7.6	194.8	67.76	194.8	65.84	193.5	64.25	193.5	62.20	193.5	60.86	183.9	59.70
	-5.0	-5.6	201.8	65.43	201.8	63.64	200.5	62.22	200.5	60.38	196.9	59.14	183.9	57.91
	-3.0	-3.7	209.0	63.08	209.0	61.47	207.7	60.18	203.8	58.54	196.9	57.40	183.9	56.14
	0.0	-0.7	219.7	59.57	219.7	58.20	210.6	57.14	203.8	55.80	196.9	54.82	183.9	53.49
	3.0	2.2	230.3	56.05	224.6	54.94	210.6	54.08	203.8	53.07	196.9	52.22	183.9	50.81
	5.0	4.1	232.8	48.72	220.0	47.78	206.5	47.08	199.7	46.27	193.0	45.56	180.2	44.23
	7.0	6.0	226.9	45.71	214.5	45.03	201.3	44.52	194.7	43.97	188.0	43.42	175.6	42.06
	9.0	7.9	218.6	42.30	206.5	41.67	193.8	41.20	187.5	40.69	181.3	40.19	169.1	38.93
	11.0	9.8	206.7	39.42	195.3	38.82	183.4	38.39	177.4	37.94	171.4	37.44	160.0	36.28
	13.0	11.8	194.0	36.01	183.4	35.46	172.2	35.06	166.5	34.63	160.8	34.20	150.2	33.15
15.0	13.7	183.6	33.11	173.5	32.61	162.9	32.24	157.5	31.86	152.2	31.45	142.1	30.47	

# 7. Capacity Tables

Heating Capacity (62HP)

Combination (%)	Outdoor air temp.		Indoor air temp. °C DB											
			16		18		20		21		22		24	
	°C DB	°C WB	TC	PI	TC	PI	TC	PI	TC	PI	TC	PI	TC	PI
100	-24.8	-25	116.3	72.63	116.3	72.43	115.5	67.75	115.5	71.91	115.5	71.69	113.2	71.59
	-21.8	-22	142.7	72.31	142.7	72.11	141.9	69.88	141.9	71.59	141.9	72.36	139.1	71.27
	-19.8	-20	151.3	72.11	151.3	71.89	150.5	71.22	150.5	71.39	150.5	71.49	147.6	71.05
	-18.8	-19	154.7	72.01	153.9	71.79	153.9	71.59	153.9	71.27	153.9	71.05	150.8	69.96
	-16.7	-17	161.0	71.79	161.0	71.57	161.0	72.36	160.2	71.05	160.2	68.80	157.1	67.66
	-13.7	-15	172.2	71.47	172.2	71.25	171.2	71.05	171.2	67.79	171.2	65.57	168.1	64.36
	-11.8	-13	177.9	71.27	176.9	71.05	176.9	68.88	176.9	65.72	176.9	63.52	168.1	62.29
	-9.8	-11	183.7	71.05	183.7	68.62	182.8	66.58	182.8	63.55	180.3	61.38	168.1	60.09
	-9.5	-10	184.7	70.67	184.7	68.25	183.9	66.25	183.9	63.22	180.3	61.05	168.1	59.76
	-8.5	-9.1	188.3	69.41	188.3	67.03	187.5	65.09	186.5	62.13	180.3	59.99	168.1	58.65
	-7.0	-7.6	196.9	67.51	196.1	65.21	192.7	63.37	186.5	60.51	180.3	58.37	168.1	57.01
	-5.0	-5.6	205.4	64.96	203.4	62.78	192.7	61.09	186.5	58.32	180.3	56.22	168.1	54.81
	-3.0	-3.7	211.4	62.43	205.1	60.33	192.7	58.79	186.5	56.15	180.3	54.08	168.1	52.62
	0.0	-0.7	217.3	58.61	205.1	56.69	192.7	55.35	186.5	52.89	180.3	50.84	168.1	49.33
	3.0	2.2	217.3	54.79	205.1	53.03	192.7	51.92	186.5	49.63	180.3	47.61	168.1	46.05
	5.0	4.1	212.9	47.43	201.0	45.87	188.8	44.91	182.8	42.90	176.9	41.06	164.7	39.60
	7.0	6.0	207.5	44.25	195.8	42.86	184.1	42.11	178.2	40.30	172.2	38.56	160.5	37.08
	9.0	7.9	200.0	40.74	188.6	39.46	177.4	38.78	171.7	37.09	166.0	35.48	154.6	34.13
	11.0	9.8	189.1	37.73	178.4	36.53	167.6	35.90	162.3	34.35	156.9	32.86	146.3	31.61
	13.0	11.8	177.6	34.20	167.5	33.13	157.4	32.55	152.5	31.14	147.3	29.81	137.2	28.66
15.0	13.7	168.1	31.20	158.5	30.22	148.9	29.70	144.2	28.40	139.5	27.17	129.9	26.14	
90	-24.8	-25	115.8	64.53	115.8	65.62	115.0	66.41	115.0	66.76	115.0	67.50	112.9	68.61
	-21.8	-22	142.2	65.62	142.2	66.73	141.4	67.50	141.4	67.87	141.4	68.61	138.5	65.71
	-19.8	-20	150.8	66.36	150.8	67.47	149.8	68.24	149.8	68.61	149.8	66.62	146.9	63.78
	-18.8	-19	154.7	66.73	153.9	67.84	153.2	68.61	153.2	67.60	153.2	65.64	150.3	62.82
	-16.7	-17	161.0	67.50	161.0	68.61	160.4	66.52	160.4	65.46	160.4	63.58	153.5	60.78
	-13.7	-15	172.2	68.61	172.2	65.49	170.7	63.52	170.7	62.42	165.4	60.61	153.5	57.89
	-11.8	-13	177.9	66.47	176.9	63.53	176.1	61.62	170.9	60.48	165.4	58.74	153.5	56.05
	-9.8	-11	183.7	64.25	183.7	61.46	176.4	59.63	170.9	58.45	165.4	56.76	153.5	54.11
	-9.5	-10	184.7	63.90	184.7	61.14	176.4	59.32	170.9	58.14	165.4	56.46	153.5	53.81
	-8.5	-9.1	188.3	62.80	187.0	60.10	176.4	58.32	170.9	57.13	165.4	55.47	153.5	52.86
	-7.0	-7.6	196.9	61.11	187.3	58.55	176.4	56.83	170.9	55.60	165.4	53.99	153.5	51.40
	-5.0	-5.6	199.0	58.87	187.3	56.48	176.4	54.84	170.9	53.58	165.4	52.02	153.5	49.48
	-3.0	-3.7	199.0	56.63	187.3	54.41	176.4	52.83	170.9	51.55	165.4	50.04	153.5	47.54
	0.0	-0.7	199.0	53.28	187.3	51.30	176.4	49.84	170.9	48.50	165.4	47.07	153.5	44.65
	3.0	2.2	199.0	49.91	187.3	48.18	176.4	46.84	170.9	45.46	165.4	44.12	153.5	41.73
	5.0	4.1	195.0	43.17	183.6	41.68	172.7	40.50	167.5	39.21	162.1	38.03	150.4	35.89
	7.0	6.0	190.1	40.45	178.9	39.19	168.3	38.13	163.1	36.85	157.9	35.74	146.8	33.70
	9.0	7.9	183.1	37.22	172.2	36.09	162.1	35.11	157.2	33.90	152.2	32.90	141.3	31.03
	11.0	9.8	173.2	34.14	162.9	33.09	153.3	32.19	148.6	31.10	143.9	30.17	133.6	28.44
	13.0	11.8	162.6	30.32	153.0	29.39	144.0	28.61	139.5	27.63	135.1	26.80	125.5	25.27
15.0	13.7	153.8	27.37	144.7	26.52	136.4	25.81	132.0	24.93	127.9	24.18	118.8	22.81	
80	-24.8	-25	115.3	56.75	115.3	57.86	114.5	58.63	114.5	59.00	114.5	60.83	112.4	58.29
	-21.8	-22	140.6	57.86	140.6	58.95	140.6	59.72	140.6	60.83	140.6	58.29	137.2	55.83
	-19.8	-20	149.2	58.58	149.2	59.69	149.2	60.83	149.2	59.04	147.5	56.58	137.2	54.19
	-18.8	-19	152.6	58.95	152.6	60.83	152.6	59.93	152.6	58.14	147.5	55.73	137.2	53.38
	-16.7	-17	157.7	60.83	157.7	58.95	157.7	58.02	153.0	56.25	147.5	53.96	137.2	51.67
	-13.7	-15	164.9	58.04	161.6	56.23	157.7	55.30	153.0	53.56	147.5	51.40	137.2	49.21
	-11.8	-13	168.9	56.25	163.9	54.52	157.7	53.56	153.0	51.85	147.5	49.78	137.2	47.65
	-9.8	-11	173.3	54.39	166.3	52.73	157.7	51.75	153.0	50.06	147.5	48.08	137.2	46.01
	-9.5	-10	174.6	54.11	167.3	52.45	157.7	51.47	153.0	49.78	147.5	47.82	137.2	45.78
	-8.5	-9.1	176.4	53.18	168.0	51.55	157.7	50.56	153.0	48.88	147.5	46.99	137.2	44.95
	-7.0	-7.6	178.2	51.77	168.0	50.19	157.7	49.20	153.0	47.54	147.5	45.71	137.2	43.72
	-5.0	-5.6	178.2	49.91	168.0	48.40	157.7	47.37	153.0	45.73	147.5	44.00	137.2	42.08
	-3.0	-3.7	178.2	48.05	168.0	46.59	157.7	45.56	153.0	43.94	147.5	42.31	137.2	40.45
	0.0	-0.7	178.2	45.23	168.0	43.89	157.7	42.84	153.0	41.25	147.5	39.74	137.2	38.01
	3.0	2.2	178.2	42.44	168.0	41.18	157.7	40.10	153.0	38.54	147.5	37.20	137.2	35.54
	5.0	4.1	174.6	36.67	164.7	35.57	154.6	34.58	149.9	33.17	144.5	32.02	134.6	30.58
	7.0	6.0	170.2	34.43	160.5	33.45	150.7	32.45	146.0	31.11	140.8	30.08	131.0	28.72
	9.0	7.9	163.9	30.85	154.6	29.99	145.0	29.24	140.8	28.11	135.6	27.11	126.3	25.82
	11.0	9.8	155.1	27.40	146.0	26.65	137.2	25.97	133.1	24.97	128.4	24.09	119.3	22.94
	13.0	11.8	145.5	23.81	137.2	23.13	128.9	22.56	125.0	21.68	120.6	20.90	112.1	19.92
15.0	13.7	137.7	21.47	129.9	20.85	121.9	20.34	118.3	19.55	114.1	18.86	106.1	17.96	

# 7. Capacity Tables

Heating Capacity (62HP)

Combination (%)	Outdoor air temp.		Indoor air temp. °C DB											
			16		18		20		21		22		24	
	°C DB	°C WB	TC	PI	TC	PI	TC	PI	TC	PI	TC	PI	TC	PI
70	-24.8	-25	115.3	57.20	115.3	57.57	114.5	58.31	114.5	59.42	114.5	56.63	112.4	54.01
	-21.8	-22	135.1	58.31	135.1	58.68	134.3	59.42	129.7	56.63	125.8	54.01	117.5	51.49
	-19.8	-20	148.4	59.05	142.7	59.42	134.3	57.46	129.7	54.77	125.8	52.28	117.5	49.81
	-18.8	-19	151.2	59.42	142.7	58.41	134.3	56.48	129.7	53.84	125.8	51.40	117.5	48.95
	-16.7	-17	151.2	57.31	142.7	56.28	134.3	54.44	129.7	51.88	125.8	49.58	117.5	47.19
	-13.7	-15	151.2	54.34	142.7	53.26	134.3	51.50	129.7	49.10	125.8	46.97	117.5	44.65
	-11.8	-13	151.2	52.43	142.7	51.34	134.3	49.63	129.7	47.32	125.8	45.31	117.5	43.06
	-9.8	-11	151.2	50.44	142.7	49.31	134.3	47.69	129.7	45.46	125.8	43.57	117.5	41.38
	-9.5	-10	151.2	50.14	142.7	49.01	134.3	47.39	129.7	45.18	125.8	43.31	117.5	41.13
	-8.5	-9.1	151.2	49.15	142.7	48.00	134.3	46.41	129.7	44.25	125.8	42.44	117.5	40.27
	-7.0	-7.6	151.2	47.65	142.7	46.49	134.3	44.95	129.7	42.86	125.8	41.13	117.5	39.01
	-5.0	-5.6	151.2	45.66	142.7	44.47	134.3	42.99	129.7	41.00	125.8	39.39	117.5	37.33
	-3.0	-3.7	151.2	43.67	142.7	42.44	134.3	41.03	129.7	39.14	125.8	37.65	117.5	35.64
	0.0	-0.7	151.2	40.67	142.7	39.42	134.3	38.11	129.7	36.35	125.8	35.04	117.5	33.12
	3.0	2.2	151.2	37.68	142.7	36.39	134.3	35.16	129.7	33.57	125.8	32.42	117.5	30.58
	5.0	4.1	151.2	32.97	139.8	31.06	131.5	30.03	127.1	28.62	123.2	27.71	115.1	26.10
	7.0	6.0	151.2	31.49	136.2	28.79	128.1	27.82	123.7	26.56	120.1	25.75	112.1	24.22
	9.0	7.9	145.8	27.26	131.2	24.90	123.5	24.07	119.3	22.99	115.7	22.28	107.9	20.95
	11.0	9.8	137.9	24.17	124.2	22.08	116.7	21.35	112.8	20.38	109.5	19.77	102.2	18.59
	13.0	11.8	129.4	21.18	116.7	19.37	109.7	18.72	105.8	17.87	102.7	17.32	95.9	16.29
15.0	13.7	122.4	18.87	110.2	17.24	103.8	16.67	100.1	15.91	97.3	15.44	90.8	14.51	
60	-24.8	-25	115.1	56.46	115.1	57.20	114.3	58.31	111.3	55.32	107.4	52.53	100.6	49.89
	-21.8	-22	123.8	57.57	122.7	58.31	115.1	55.32	111.3	52.53	107.4	49.89	100.6	47.35
	-19.8	-20	129.7	58.31	122.7	56.20	115.1	53.34	111.3	50.67	107.4	48.14	100.6	45.65
	-18.8	-19	129.7	57.26	122.7	55.15	115.1	52.33	111.3	49.72	107.4	47.26	100.6	44.79
	-16.7	-17	129.7	55.02	122.7	52.94	115.1	50.25	111.3	47.76	107.4	45.42	100.6	43.01
	-13.7	-15	129.7	51.83	122.7	49.79	115.1	47.28	111.3	44.97	107.4	42.78	100.6	40.47
	-11.8	-13	129.7	49.82	122.7	47.79	115.1	45.38	111.3	43.19	107.4	41.12	100.6	38.86
	-9.8	-11	129.7	47.71	122.7	45.68	115.1	43.39	111.3	41.33	107.4	39.36	100.6	37.15
	-9.5	-10	129.7	47.39	122.7	45.37	115.1	43.09	111.3	41.05	107.4	39.09	100.6	36.90
	-8.5	-9.1	129.7	46.33	122.7	44.32	115.1	42.11	111.3	40.12	107.4	38.21	100.6	36.05
	-7.0	-7.6	129.7	44.75	122.7	42.74	115.1	40.62	111.3	38.71	107.4	36.90	100.6	34.77
	-5.0	-5.6	129.7	42.61	122.7	40.63	115.1	38.62	111.3	36.85	107.4	35.15	100.6	33.08
	-3.0	-3.7	129.7	40.50	122.7	38.52	115.1	36.63	111.3	34.99	107.4	33.39	100.6	31.37
	0.0	-0.7	129.7	37.31	122.7	35.37	115.1	33.66	111.3	32.18	107.4	30.75	100.6	28.83
	3.0	2.2	129.7	34.12	122.7	32.21	115.1	30.67	111.3	29.39	107.4	28.13	100.6	26.27
	5.0	4.1	127.1	28.97	120.3	27.23	112.8	25.92	109.0	24.87	105.3	23.83	98.5	22.22
	7.0	6.0	123.7	26.60	117.2	24.92	110.0	23.76	106.3	22.83	102.7	21.90	96.0	20.36
	9.0	7.9	119.3	22.78	112.8	21.33	105.8	20.34	102.4	19.54	98.8	18.76	92.6	17.43
	11.0	9.8	112.8	20.20	106.8	18.92	100.1	18.04	96.7	17.33	93.4	16.63	87.4	15.45
	13.0	11.8	105.8	17.69	100.4	16.56	94.1	15.79	90.8	15.18	87.7	14.56	82.2	13.55
15.0	13.7	100.1	15.91	94.9	14.89	89.0	14.06	86.1	13.53	83.0	12.98	77.8	12.18	
50	-24.8	-25	108.2	49.40	102.0	50.51	95.9	47.87	92.8	45.40	89.7	43.07	83.5	40.90
	-21.8	-22	108.2	50.51	102.0	47.87	95.9	45.40	92.8	43.07	89.7	40.90	83.5	38.81
	-19.8	-20	108.2	48.68	102.0	46.11	95.9	43.77	92.8	41.51	89.7	39.44	83.5	37.40
	-18.8	-19	108.2	47.75	102.0	45.23	95.9	42.94	92.8	40.75	89.7	38.71	83.5	36.70
	-16.7	-17	108.2	45.83	102.0	43.39	95.9	41.22	92.8	39.11	89.7	37.20	83.5	35.24
	-13.7	-15	108.2	43.09	102.0	40.75	95.9	38.76	92.8	36.77	89.7	35.03	83.5	33.15
	-11.8	-13	108.2	41.35	102.0	39.09	95.9	37.20	92.8	35.29	89.7	33.65	83.5	31.81
	-9.8	-11	108.2	39.51	102.0	37.33	95.9	35.54	92.8	33.73	89.7	32.19	83.5	30.41
	-9.5	-10	108.2	39.24	102.0	37.07	95.9	35.31	92.8	33.50	89.7	31.99	83.5	30.20
	-8.5	-9.1	108.2	38.31	102.0	36.19	95.9	34.48	92.8	32.72	89.7	31.26	83.5	29.50
	-7.0	-7.6	108.2	36.95	102.0	34.88	95.9	33.25	92.8	31.56	89.7	30.18	83.5	28.47
	-5.0	-5.6	108.2	35.11	102.0	33.12	95.9	31.61	92.8	30.00	89.7	28.72	83.5	27.06
	-3.0	-3.7	108.2	33.27	102.0	31.36	95.9	29.95	92.8	28.44	89.7	27.26	83.5	25.67
	0.0	-0.7	108.2	30.53	102.0	28.72	95.9	27.49	92.8	26.10	89.7	25.09	83.5	23.56
	3.0	2.2	108.2	27.79	102.0	26.10	95.9	25.04	92.8	23.76	89.7	22.93	83.5	21.47
	5.0	4.1	106.1	23.48	100.1	22.00	93.9	21.14	91.0	20.09	87.9	19.41	82.0	18.15
	7.0	6.0	103.2	21.47	97.5	20.09	91.6	19.36	88.7	18.38	85.8	17.82	79.9	16.61
	9.0	7.9	99.6	18.56	93.9	17.38	88.2	16.75	85.3	15.92	82.5	15.42	77.0	14.38
	11.0	9.8	94.6	16.66	89.2	15.60	83.8	15.02	80.7	14.27	78.1	13.82	72.9	12.89
	13.0	11.8	88.4	14.43	83.3	13.52	78.3	13.02	75.8	12.45	73.4	11.99	68.2	11.24
15.0	13.7	83.5	13.01	78.9	12.18	74.2	11.73	71.8	11.15	69.5	10.80	64.6	10.07	

**Note**

1. TC: Total Capacity(kW), PI : Power Input(kW, Comp. + Outdoor fan motor)
2. Capacity tables show the average value of conditions which may occur.
3. The heating capacity table is based on the values expressed as Max. in the specification of the outdoor unit. (When measuring the Max. heating capacity, the setting status of the indoor unit is the same as that for measuring the heating capacity of the indoor unit.)



# 7. Capacity Tables

## ◆ ARUM640LTE5

Heating Capacity (64HP)

Combination (%)	Outdoor air temp.		Indoor air temp. °C DB											
			16		18		20		21		22		24	
	°C DB	°C WB	TC	PI	TC	PI	TC	PI	TC	PI	TC	PI	TC	PI
130	-24.8	-25	119.5	66.2	119.5	66.94	118.7	67.54	118.7	68.45	118.7	69.33	117.1	70.73
	-21.8	-22	147.2	67.62	147.2	68.31	146.2	68.91	146.2	69.84	146.2	70.73	144.0	72.10
	-19.8	-20	156.1	68.54	156.1	69.24	155.1	69.84	155.1	70.76	155.1	71.63	152.9	73.02
	-18.8	-19	159.9	69.01	159.9	69.70	158.9	70.30	158.9	71.23	158.9	72.10	156.5	73.49
	-16.7	-17	167.5	69.97	167.5	70.67	166.5	71.27	166.5	72.19	166.5	73.08	164.1	74.45
	-13.7	-15	178.4	71.36	178.4	72.06	177.3	72.66	177.3	73.58	177.3	74.45	174.7	71.80
	-11.8	-13	184.3	72.25	184.3	72.93	183.2	73.53	183.2	74.45	183.2	75.32	181.2	70.12
	-9.8	-11	190.5	73.16	190.5	73.85	189.4	74.45	189.4	75.34	189.4	76.23	187.0	68.35
	-9.5	-10	191.8	73.31	191.8	73.99	190.7	74.17	190.7	75.06	190.7	76.15	188.0	68.07
	-8.5	-9.1	196.5	73.76	196.5	74.45	195.4	75.22	195.4	76.11	195.4	77.00	192.4	67.18
	-7.0	-7.6	203.6	74.45	203.6	75.09	202.2	75.80	202.2	76.51	202.2	77.22	198.6	65.86
	-5.0	-5.6	213.0	75.72	213.0	76.42	211.6	77.13	211.6	77.84	211.6	78.55	205.7	64.09
	-3.0	-3.7	222.4	76.98	222.4	77.42	221.0	78.17	221.0	78.88	221.0	79.59	216.8	62.30
	0.0	-0.7	236.5	78.35	236.5	79.06	234.8	79.77	233.7	80.48	233.7	81.19	227.7	59.65
	3.0	2.2	245.1	79.74	245.1	80.47	243.7	81.18	242.1	81.89	242.1	82.60	238.7	57.00
	5.0	4.1	246.2	80.13	246.2	80.86	244.2	81.55	242.7	82.24	242.7	82.93	240.2	56.31
	7.0	6.0	245.1	80.52	244.6	81.21	243.4	81.90	241.9	82.59	241.9	83.28	237.7	55.62
	9.0	7.9	237.0	81.91	236.5	82.60	235.9	83.29	234.4	83.98	234.4	84.67	232.2	54.93
11.0	9.8	224.2	83.30	223.7	84.11	223.1	84.80	221.6	85.49	221.6	86.18	220.0	54.24	
13.0	11.8	210.5	84.69	210.2	85.42	209.5	86.11	208.3	86.80	208.3	87.49	210.5	53.55	
15.0	13.7	199.3	86.08	198.8	86.71	198.2	87.40	197.4	88.09	197.4	88.78	200.0	52.86	
120	-24.8	-25	118.7	66.94	118.7	67.54	117.9	68.45	117.9	69.33	117.9	70.73	116.3	71.69
	-21.8	-22	146.2	68.31	146.2	68.91	145.2	69.84	145.2	70.73	145.2	72.10	143.2	73.08
	-19.8	-20	155.1	69.24	155.1	69.84	154.0	70.76	154.0	71.63	154.0	73.02	151.8	73.99
	-18.8	-19	158.6	69.70	158.6	70.30	157.6	71.23	157.6	72.10	157.6	73.49	155.4	74.45
	-16.7	-17	166.2	70.67	166.2	71.27	165.2	72.19	165.2	73.08	165.2	74.45	162.8	72.74
	-13.7	-15	177.1	72.06	177.1	72.66	176.0	73.58	176.0	74.45	176.0	75.34	173.4	70.30
	-11.8	-13	183.0	72.93	183.0	73.53	181.9	74.45	181.9	75.34	181.9	76.23	179.9	68.76
	-9.8	-11	189.1	73.85	189.1	74.45	188.0	75.22	188.0	76.11	188.0	77.00	185.6	67.13
	-9.5	-10	190.5	73.99	190.5	74.14	189.4	74.29	189.4	75.18	189.4	76.07	187.0	66.87
	-8.5	-9.1	195.2	74.45	195.2	75.11	193.9	75.80	193.9	76.69	193.9	77.58	191.4	66.06
	-7.0	-7.6	202.2	75.72	202.2	76.42	200.9	77.13	200.9	77.84	200.9	78.55	198.6	64.84
	-5.0	-5.6	211.6	77.00	211.6	77.71	210.2	78.42	210.2	79.13	210.2	80.02	207.7	63.21
	-3.0	-3.7	220.7	78.26	220.7	78.97	219.4	79.68	219.4	80.39	219.4	81.28	216.8	61.57
	0.0	-0.7	234.8	79.65	234.3	80.36	233.0	81.07	231.9	81.78	231.9	82.67	229.0	59.13
	3.0	2.2	243.2	80.05	242.5	80.76	241.2	81.47	240.1	82.18	240.1	83.07	237.2	57.49
	5.0	4.1	244.5	80.44	243.1	81.16	241.6	81.87	240.5	82.58	240.5	83.47	237.5	56.80
	7.0	6.0	243.7	80.83	241.1	82.55	237.7	83.24	235.9	83.93	235.9	84.62	234.7	56.11
	9.0	7.9	235.4	82.22	232.2	84.14	228.3	84.83	226.5	85.52	226.5	86.21	223.5	55.42
11.0	9.8	222.6	83.61	219.6	85.04	217.0	85.73	215.2	86.42	215.2	87.11	212.2	54.73	
13.0	11.8	209.1	85.00	206.2	86.14	204.0	86.83	202.2	87.52	202.2	88.21	200.0	54.04	
15.0	13.7	197.9	86.39	195.2	87.25	193.7	87.94	192.4	88.63	192.4	89.32	190.0	53.35	
110	-24.8	-25	118.1	67.54	118.1	68.45	117.4	69.33	117.4	70.73	117.4	71.69	115.6	72.16
	-21.8	-22	145.4	68.91	145.4	69.84	144.4	70.73	144.4	72.10	144.4	73.08	142.4	73.53
	-19.8	-20	154.3	69.84	154.3	70.76	153.2	71.63	153.2	73.02	153.2	73.99	151.0	74.45
	-18.8	-19	157.8	70.30	157.8	71.23	156.8	72.10	156.8	73.49	156.8	74.45	154.6	73.54
	-16.7	-17	165.4	71.27	165.4	72.19	164.4	73.08	164.4	74.45	164.4	75.34	162.0	71.61
	-13.7	-15	176.1	72.66	176.1	73.58	175.0	74.45	175.0	75.34	175.0	76.23	172.6	68.88
	-11.8	-13	181.9	73.53	181.9	74.45	180.9	75.34	180.9	76.23	180.9	77.12	178.9	67.13
	-9.8	-11	188.1	74.45	188.1	75.34	187.0	76.23	187.0	77.12	187.0	78.01	185.0	65.31
	-9.5	-10	189.4	74.59	189.4	75.48	188.4	76.37	188.4	77.26	188.4	78.15	186.4	64.04
	-8.5	-9.1	194.1	75.04	194.1	75.93	193.0	76.82	193.0	77.71	193.0	78.60	191.0	62.77
	-7.0	-7.6	201.1	76.43	201.1	77.32	199.8	78.21	199.8	79.10	199.8	80.00	197.8	61.50
	-5.0	-5.6	210.3	77.82	210.3	78.71	208.9	79.60	208.9	80.49	208.9	81.38	206.9	60.23
	-3.0	-3.7	219.6	79.21	219.6	80.10	218.3	80.49	218.3	81.38	218.3	82.27	216.3	58.96
	0.0	-0.7	231.5	80.60	231.5	81.49	230.3	82.38	229.1	83.27	229.1	84.16	227.1	57.69
	3.0	2.2	239.7	81.99	239.7	82.88	238.5	83.77	237.3	84.66	237.3	85.55	235.3	56.42
	5.0	4.1	240.5	82.38	240.5	83.27	239.2	84.16	238.0	85.05	238.0	85.94	236.0	55.15
	7.0	6.0	234.3	83.77	234.3	84.66	233.1	85.54	232.0	86.43	232.0	87.32	230.0	53.88
	9.0	7.9	225.8	85.16	225.8	86.05	224.6	86.94	223.4	87.83	223.4	88.72	221.4	52.61
11.0	9.8	213.5	86.55	213.5	87.44	212.3	88.32	211.1	89.21	211.1	90.10	209.1	51.34	
13.0	11.8	200.4	87.94	200.4	88.93	199.2	89.71	198.0	90.60	198.0	91.49	196.0	50.07	
15.0	13.7	189.6	89.33	189.6	90.42	188.4	91.31	187.2	92.20	187.2	93.09	185.2	48.80	

# 7. Capacity Tables

Heating Capacity (64HP)

Combination (%)	Outdoor air temp.		Indoor air temp. °C DB											
			16		18		20		21		22		24	
	°C DB	°C WB	TC	PI	TC	PI	TC	PI	TC	PI	TC	PI	TC	PI
100	-24.8	-25	117.6	74.85	117.6	74.80	116.8	70.49	116.8	74.67	116.8	74.62	115.0	74.60
	-21.8	-22	144.6	74.76	144.6	74.72	143.8	72.72	143.8	74.59	143.8	75.56	141.6	74.52
	-19.8	-20	153.5	74.72	153.5	74.66	152.7	74.13	152.7	74.55	152.7	74.83	150.5	74.45
	-18.8	-19	157.1	74.70	156.2	74.64	156.2	74.59	156.2	74.51	156.2	74.45	153.8	73.33
	-16.7	-17	163.6	74.65	163.6	74.59	163.6	75.56	162.8	74.45	162.8	72.13	160.4	70.94
	-13.7	-15	175.3	74.56	175.3	74.50	174.2	74.45	174.2	71.09	174.2	68.78	171.8	67.52
	-11.8	-13	181.1	74.52	180.1	74.45	180.1	72.21	180.1	68.95	180.1	66.67	173.3	65.37
	-9.8	-11	187.0	74.45	187.0	71.95	186.2	69.84	186.2	66.70	184.2	64.45	173.5	63.10
	-9.5	-10	188.4	74.06	188.4	71.57	187.6	69.50	187.6	66.36	184.8	64.11	173.5	62.76
	-8.5	-9.1	193.0	72.76	193.0	70.31	192.2	68.31	192.6	65.24	186.2	63.01	173.5	61.61
	-7.0	-7.6	203.3	70.81	202.5	68.44	199.0	66.53	192.6	63.57	186.2	61.33	173.5	59.91
	-5.0	-5.6	212.2	68.19	210.0	65.94	199.0	64.18	192.6	61.30	186.2	59.11	173.5	57.64
	-3.0	-3.7	218.3	65.59	211.8	63.42	199.0	61.82	192.6	59.06	186.2	56.89	173.5	55.36
	0.0	-0.7	224.5	61.66	211.8	59.66	199.0	58.27	192.6	55.69	186.2	53.55	173.5	51.96
	3.0	2.2	224.5	57.74	211.8	55.89	199.0	54.73	192.6	52.32	186.2	50.20	173.5	48.56
	5.0	4.1	219.9	50.04	207.6	48.39	195.0	47.39	188.8	45.26	182.6	43.33	170.1	41.79
	7.0	6.0	214.3	46.75	202.2	45.28	190.1	44.49	184.0	42.57	177.9	40.73	165.8	39.17
	9.0	7.9	206.5	43.06	194.7	41.70	183.2	40.98	177.3	39.20	171.4	37.50	159.6	36.07
11.0	9.8	195.3	39.90	184.3	38.63	173.0	37.96	167.6	36.32	162.0	34.75	151.0	33.42	
13.0	11.8	183.4	36.19	173.0	35.05	162.6	34.44	157.5	32.95	152.1	31.54	141.7	30.32	
15.0	13.7	173.5	33.03	163.7	32.00	153.8	31.44	148.9	30.06	144.1	28.76	134.2	27.67	
90	-24.8	-25	117.1	66.52	117.1	67.89	116.3	68.88	116.3	69.32	116.3	70.25	114.7	71.64
	-21.8	-22	144.1	67.89	144.1	69.28	143.3	70.25	143.3	70.71	143.3	71.64	141.1	68.66
	-19.8	-20	153.0	68.82	153.0	70.21	151.9	71.17	151.9	71.64	151.9	71.64	149.7	66.67
	-18.8	-19	157.1	69.28	156.2	70.67	155.5	71.64	155.5	70.60	155.5	68.59	153.3	65.68
	-16.7	-17	163.6	70.25	163.6	71.64	163.0	69.50	163.0	68.41	163.0	66.47	157.6	63.58
	-13.7	-15	175.3	71.64	175.3	68.45	173.7	66.43	173.7	65.29	169.7	63.42	158.6	60.60
	-11.8	-13	181.1	69.46	180.1	66.44	179.3	64.48	175.3	63.30	170.8	61.51	158.6	58.71
	-9.8	-11	187.0	67.19	187.0	64.33	181.0	62.44	176.5	61.21	170.8	59.47	158.6	56.72
	-9.5	-10	188.4	66.84	188.4	64.00	181.6	62.13	176.5	60.90	170.8	59.16	158.6	56.41
	-8.5	-9.1	193.0	65.71	191.7	62.94	182.1	61.10	176.5	59.87	170.8	58.15	158.6	55.43
	-7.0	-7.6	203.3	63.99	193.4	61.35	182.1	59.58	176.5	58.30	170.8	56.63	158.6	53.93
	-5.0	-5.6	205.5	61.70	193.4	59.24	182.1	57.54	176.5	56.23	170.8	54.61	158.6	51.95
	-3.0	-3.7	205.5	59.42	193.4	57.13	182.1	55.49	176.5	54.14	170.8	52.57	158.6	49.96
	0.0	-0.7	205.5	56.00	193.4	53.94	182.1	52.42	176.5	51.02	170.8	49.52	158.6	46.98
	3.0	2.2	205.5	52.57	193.4	50.75	182.1	49.36	176.5	47.90	170.8	46.49	158.6	43.98
	5.0	4.1	201.4	45.52	189.6	43.96	178.4	42.72	173.0	41.36	167.4	40.12	155.4	37.87
	7.0	6.0	196.3	42.73	184.8	41.40	173.8	40.29	168.5	38.93	163.1	37.76	151.6	35.61
	9.0	7.9	189.1	39.34	177.9	38.14	167.4	37.11	162.3	35.83	157.2	34.77	146.0	32.80
11.0	9.8	178.9	36.10	168.2	34.99	158.3	34.03	153.5	32.89	148.6	31.91	137.9	30.08	
13.0	11.8	167.9	32.08	158.0	31.09	148.7	30.27	144.1	29.23	139.5	28.36	129.6	26.74	
15.0	13.7	158.8	28.97	149.5	28.08	140.8	27.33	136.3	26.40	132.0	25.61	122.7	24.15	
80	-24.8	-25	116.6	58.40	116.6	59.79	115.8	60.76	115.8	61.22	115.8	63.52	114.2	60.90
	-21.8	-22	142.5	59.79	142.5	61.16	142.5	62.13	142.5	63.52	142.5	60.90	139.9	58.36
	-19.8	-20	151.4	60.70	151.4	62.09	151.4	63.52	151.4	61.68	150.0	59.14	141.7	56.68
	-18.8	-19	154.9	61.16	154.9	63.52	154.9	62.59	154.9	60.75	150.9	58.26	141.7	55.84
	-16.7	-17	160.8	63.52	160.8	61.58	160.8	60.63	157.2	58.81	152.4	56.45	141.7	54.08
	-13.7	-15	170.3	60.66	166.9	58.80	162.9	57.84	158.0	56.04	152.4	53.81	141.7	51.54
	-11.8	-13	174.4	58.84	169.3	57.05	162.9	56.06	158.0	54.29	152.4	52.15	141.7	49.94
	-9.8	-11	178.6	56.93	171.5	55.22	162.9	54.20	158.0	52.45	152.4	50.39	141.7	48.25
	-9.5	-10	179.9	56.65	172.6	54.93	162.9	53.91	158.0	52.16	152.4	50.13	141.7	48.01
	-8.5	-9.1	181.9	55.69	173.5	54.01	162.9	52.98	158.0	51.24	152.4	49.27	141.7	47.16
	-7.0	-7.6	184.0	54.25	173.5	52.62	162.9	51.59	158.0	49.86	152.4	47.96	141.7	45.89
	-5.0	-5.6	184.0	52.35	173.5	50.78	162.9	49.71	158.0	48.00	152.4	46.20	141.7	44.20
	-3.0	-3.7	184.0	50.44	173.5	48.93	162.9	47.85	158.0	46.16	152.4	44.46	141.7	42.52
	0.0	-0.7	184.0	47.56	173.5	46.17	162.9	45.06	158.0	43.40	152.4	41.82	141.7	40.00
	3.0	2.2	184.0	44.70	173.5	43.39	162.9	42.25	158.0	40.61	152.4	39.21	141.7	37.46
	5.0	4.1	180.3	38.68	170.1	37.51	159.6	36.48	154.8	34.99	149.2	33.78	139.0	32.26
	7.0	6.0	175.7	36.38	165.8	35.34	155.6	34.28	150.8	32.86	145.4	31.78	135.3	30.34
	9.0	7.9	169.3	32.60	159.6	31.69	149.8	30.90	145.4	29.70	140.1	28.64	130.4	27.29
11.0	9.8	160.2	28.97	150.8	28.17	141.7	27.46	137.4	26.39	132.6	25.46	123.2	24.25	
13.0	11.8	150.3	25.18	141.7	24.47	133.1	23.86	129.1	22.93	124.5	22.11	115.7	21.07	
15.0	13.7	142.2	22.73	134.2	22.07	125.9	21.53	122.1	20.69	117.8	19.97	109.5	19.02	

# 7. Capacity Tables

Heating Capacity (64HP)

Combination (%)	Outdoor air temp.		Indoor air temp. °C DB											
			16		18		20		21		22		24	
	°C DB	°C WB	TC	PI	TC	PI	TC	PI	TC	PI	TC	PI	TC	PI
70	-24.8	-25	116.6	59.07	116.6	59.53	115.8	60.46	115.8	61.85	115.8	58.98	114.2	56.30
	-21.8	-22	138.3	60.46	138.6	60.92	137.7	61.85	133.9	58.98	129.9	56.30	121.3	53.71
	-19.8	-20	150.8	61.38	146.2	61.85	138.7	59.84	133.9	57.08	129.9	54.52	121.3	51.98
	-18.8	-19	153.7	61.85	147.1	60.82	138.7	58.84	133.9	56.12	129.9	53.62	121.3	51.10
	-16.7	-17	155.8	59.70	147.3	58.64	138.7	56.75	133.9	54.11	129.9	51.75	121.3	49.29
	-13.7	-15	156.1	56.66	147.3	55.55	138.7	53.74	133.9	51.27	129.9	49.07	121.3	46.68
	-11.8	-13	156.1	54.71	147.3	53.59	138.7	51.83	133.9	49.44	129.9	47.37	121.3	45.04
	-9.8	-11	156.1	52.68	147.3	51.51	138.7	49.84	133.9	47.53	129.9	45.58	121.3	43.31
	-9.5	-10	156.1	52.38	147.3	51.20	138.7	49.54	133.9	47.25	129.9	45.32	121.3	43.05
	-8.5	-9.1	156.1	51.37	147.3	50.17	138.7	48.53	133.9	46.30	129.9	44.42	121.3	42.17
	-7.0	-7.6	156.1	49.83	147.3	48.63	138.7	47.04	133.9	44.87	129.9	43.08	121.3	40.88
	-5.0	-5.6	156.1	47.80	147.3	46.57	138.7	45.03	133.9	42.97	129.9	41.30	121.3	39.15
	-3.0	-3.7	156.1	45.77	147.3	44.49	138.7	43.02	133.9	41.06	129.9	39.51	121.3	37.41
	0.0	-0.7	156.1	42.72	147.3	41.40	138.7	40.03	133.9	38.19	129.9	36.83	121.3	34.82
	3.0	2.2	156.1	39.66	147.3	38.31	138.7	37.02	133.9	35.35	129.9	34.14	121.3	32.21
	5.0	4.1	156.1	34.77	144.4	32.75	135.8	31.65	131.2	30.18	127.3	29.22	118.9	27.52
	7.0	6.0	156.2	33.27	140.6	30.42	132.3	29.38	127.8	28.06	124.0	27.21	115.7	25.58
	9.0	7.9	150.5	28.81	135.5	26.32	127.5	25.44	123.2	24.29	119.5	23.55	111.4	22.14
	11.0	9.8	142.5	25.56	128.3	23.35	120.6	22.58	116.5	21.55	113.0	20.91	105.5	19.66
	13.0	11.8	133.7	22.41	120.5	20.49	113.3	19.81	109.3	18.90	106.1	18.32	99.1	17.23
15.0	13.7	126.4	19.98	113.9	18.26	107.1	17.65	103.4	16.85	100.4	16.34	93.7	15.36	
60	-24.8	-25	116.6	58.14	116.6	59.07	115.8	60.46	113.6	57.41	110.6	54.56	103.9	51.86
	-21.8	-22	126.9	59.53	126.7	60.46	118.9	57.41	114.9	54.56	110.9	51.86	103.9	49.26
	-19.8	-20	133.9	60.46	126.7	58.31	118.9	55.38	114.9	52.66	110.9	50.06	103.9	47.51
	-18.8	-19	133.9	59.38	126.7	57.23	118.9	54.36	114.9	51.69	110.9	49.16	103.9	46.63
	-16.7	-17	133.9	57.11	126.7	54.98	118.9	52.23	114.9	49.68	110.9	47.28	103.9	44.80
	-13.7	-15	133.9	53.87	126.7	51.78	118.9	49.20	114.9	46.83	110.9	44.59	103.9	42.20
	-11.8	-13	133.9	51.83	126.7	49.73	118.9	47.26	114.9	45.01	110.9	42.89	103.9	40.55
	-9.8	-11	133.9	49.68	126.7	47.59	118.9	45.23	114.9	43.11	110.9	41.09	103.9	38.80
	-9.5	-10	133.9	49.35	126.7	47.28	118.9	44.93	114.9	42.83	110.9	40.81	103.9	38.54
	-8.5	-9.1	133.9	48.28	126.7	46.20	118.9	43.92	114.9	41.88	110.9	39.91	103.9	37.67
	-7.0	-7.6	133.9	46.67	126.7	44.59	118.9	42.41	114.9	40.44	110.9	38.57	103.9	36.36
	-5.0	-5.6	133.9	44.51	126.7	42.44	118.9	40.36	114.9	38.54	110.9	36.77	103.9	34.63
	-3.0	-3.7	133.9	42.36	126.7	40.29	118.9	38.34	114.9	36.64	110.9	34.98	103.9	32.88
	0.0	-0.7	133.9	39.12	126.7	37.09	118.9	35.31	114.9	33.77	110.9	32.28	103.9	30.27
	3.0	2.2	133.9	35.88	126.7	33.87	118.9	32.26	114.9	30.92	110.9	29.60	103.9	27.65
	5.0	4.1	131.2	30.52	124.3	28.69	116.5	27.31	112.5	26.21	108.7	25.12	101.8	23.42
	7.0	6.0	127.8	28.11	121.1	26.33	113.5	25.10	109.8	24.12	106.0	23.14	99.1	21.51
	9.0	7.9	123.2	24.08	116.5	22.54	109.3	21.50	105.8	20.65	102.0	19.83	95.6	18.42
	11.0	9.8	116.5	21.36	110.3	20.00	103.4	19.07	99.9	18.33	96.4	17.58	90.3	16.34
	13.0	11.8	109.3	18.72	103.6	17.53	97.2	16.70	93.8	16.06	90.6	15.40	84.9	14.34
15.0	13.7	103.4	16.85	98.0	15.76	91.9	14.89	88.9	14.33	85.7	13.74	80.3	12.89	
50	-24.8	-25	111.7	51.35	105.3	52.74	99.1	50.01	95.9	47.46	92.7	45.03	86.3	42.79
	-21.8	-22	111.7	52.74	105.3	50.01	99.1	47.46	95.9	45.03	92.7	42.79	86.3	40.62
	-19.8	-20	111.7	50.84	105.3	48.19	99.1	45.76	95.9	43.42	92.7	41.28	86.3	39.16
	-18.8	-19	111.7	49.89	105.3	47.28	99.1	44.91	95.9	42.63	92.7	40.52	86.3	38.43
	-16.7	-17	111.7	47.91	105.3	45.38	99.1	43.13	95.9	40.94	92.7	38.96	86.3	36.91
	-13.7	-15	111.7	45.07	105.3	42.65	99.1	40.58	95.9	38.51	92.7	36.71	86.3	34.74
	-11.8	-13	111.7	43.28	105.3	40.93	99.1	38.96	95.9	36.98	92.7	35.28	86.3	33.36
	-9.8	-11	111.7	41.38	105.3	39.11	99.1	37.25	95.9	35.36	92.7	33.77	86.3	31.90
	-9.5	-10	111.7	41.10	105.3	38.84	99.1	37.01	95.9	35.13	92.7	33.55	86.3	31.69
	-8.5	-9.1	111.7	40.14	105.3	37.93	99.1	36.15	95.9	34.32	92.7	32.80	86.3	30.96
	-7.0	-7.6	111.7	38.73	105.3	36.58	99.1	34.88	95.9	33.12	92.7	31.68	86.3	29.89
	-5.0	-5.6	111.7	36.83	105.3	34.76	99.1	33.18	95.9	31.50	92.7	30.16	86.3	28.43
	-3.0	-3.7	111.7	34.94	105.3	32.94	99.1	31.47	95.9	29.89	92.7	28.65	86.3	26.99
	0.0	-0.7	111.7	32.10	105.3	30.20	99.1	28.92	95.9	27.46	92.7	26.41	86.3	24.80
	3.0	2.2	111.7	29.27	105.3	27.49	99.1	26.38	95.9	25.04	92.7	24.16	86.3	22.63
	5.0	4.1	109.5	24.76	103.4	23.20	97.0	22.30	94.0	21.19	90.8	20.47	84.6	19.15
	7.0	6.0	106.6	22.68	100.7	21.22	94.6	20.45	91.6	19.41	88.6	18.83	82.5	17.55
	9.0	7.9	102.8	19.62	97.0	18.37	91.1	17.70	88.1	16.82	85.2	16.29	79.5	15.20
	11.0	9.8	97.7	17.61	92.1	16.49	86.5	15.88	83.3	15.09	80.6	14.61	75.2	13.63
	13.0	11.8	91.3	15.27	86.0	14.31	80.9	13.78	78.2	13.17	75.8	12.69	70.5	11.90
15.0	13.7	86.3	13.77	81.4	12.90	76.6	12.42	74.2	11.81	71.7	11.44	66.7	10.67	

**Note**

1. TC: Total Capacity(kW), PI : Power Input(kW, Comp. + Outdoor fan motor)
2. Capacity tables show the average value of conditions which may occur.
3. The heating capacity table is based on the values expressed as Max. in the specification of the outdoor unit. (When measuring the Max. heating capacity, the setting status of the indoor unit is the same as that for measuring the heating capacity of the indoor unit.)

# 7. Capacity Tables

## ◆ ARUM660LTE5

Heating Capacity (66HP)

Combination (%)	Outdoor air temp.		Indoor air temp. °C DB											
			16		18		20		21		22		24	
	°C DB	°C WB	TC	PI	TC	PI	TC	PI	TC	PI	TC	PI	TC	PI
130	-24.8	-25	128.1	69.1	128.1	69.59	127.2	70.05	127.2	70.74	127.2	71.43	124.9	72.50
	-21.8	-22	156.2	70.11	156.2	70.64	155.1	71.10	155.1	71.81	155.1	72.50	152.1	73.55
	-19.8	-20	164.9	70.82	164.9	71.35	163.8	71.81	163.8	72.53	163.8	73.19	160.7	74.26
	-18.8	-19	168.6	71.17	168.6	71.71	167.5	72.17	167.5	72.88	167.5	73.55	164.2	74.62
	-16.7	-17	176.1	71.92	176.1	72.45	174.9	72.91	174.9	73.62	174.9	74.31	171.6	75.36
	-13.7	-15	186.8	72.98	186.8	73.52	185.6	73.98	185.6	74.69	185.6	75.36	182.1	72.53
	-11.8	-13	192.8	73.67	192.8	74.18	191.7	74.64	191.7	75.36	191.7	73.46	188.7	70.73
	-9.8	-11	199.2	74.36	199.2	74.90	198.1	75.36	198.1	73.34	198.1	71.46	195.7	68.85
	-9.5	-10	200.3	74.49	200.3	75.00	199.2	75.05	199.2	73.03	198.9	71.16	196.8	68.55
	-8.5	-9.1	204.2	74.82	204.2	75.36	203.1	74.01	203.1	72.01	202.2	70.16	200.2	67.61
	-7.0	-7.6	210.0	75.36	210.0	73.85	208.7	72.46	208.7	70.49	208.7	68.63	205.4	66.19
	-5.0	-5.6	217.8	73.41	217.8	71.82	216.4	70.39	216.4	68.46	216.4	66.63	212.3	64.31
	-3.0	-3.7	225.5	71.46	225.5	69.81	224.1	68.31	224.1	66.42	224.1	64.63	219.3	62.41
	0.0	-0.7	237.1	68.52	237.1	66.78	235.5	65.22	235.5	63.38	235.5	61.63	229.9	59.58
	3.0	2.2	248.8	65.60	248.8	63.73	247.1	62.10	247.1	60.33	247.1	58.60	231.3	56.75
	5.0	4.1	251.8	57.83	251.3	56.00	249.7	54.41	249.7	52.77	244.0	51.17	227.1	49.52
	7.0	6.0	252.7	54.89	252.2	53.13	250.7	51.59	246.4	50.09	237.7	48.59	221.3	47.14
	9.0	7.9	244.6	51.12	244.0	49.46	243.4	48.02	237.3	46.63	229.1	45.23	213.3	43.89
	11.0	9.8	231.3	47.95	230.8	46.41	230.2	45.05	224.4	43.74	216.6	42.45	201.7	41.17
	13.0	11.8	217.2	44.12	216.9	42.70	216.1	41.45	210.8	40.25	203.4	39.05	189.3	37.87
15.0	13.7	205.6	40.93	205.0	39.60	204.5	38.46	199.5	37.34	192.6	36.22	179.1	35.13	
120	-24.8	-25	127.2	69.59	127.2	70.05	126.4	70.74	126.4	71.43	126.4	72.50	124.1	73.24
	-21.8	-22	155.1	70.64	155.1	71.10	154.0	71.81	154.0	72.50	154.0	73.55	151.2	74.31
	-19.8	-20	163.7	71.35	163.7	71.81	162.6	72.53	162.6	73.19	162.6	74.26	159.6	75.00
	-18.8	-19	167.2	71.71	167.2	72.17	166.1	72.88	166.1	73.55	166.1	74.62	163.1	75.36
	-16.7	-17	174.7	72.45	174.7	72.91	173.6	73.62	173.6	74.31	173.6	75.36	170.3	73.53
	-13.7	-15	185.4	73.52	185.4	73.98	184.3	74.69	184.3	75.36	184.3	72.64	180.7	70.93
	-11.8	-13	191.5	74.18	191.5	74.64	190.3	75.36	190.3	73.44	190.3	70.92	187.4	69.29
	-9.8	-11	197.8	74.90	197.8	75.36	196.7	73.24	196.7	71.41	196.7	69.11	194.3	67.55
	-9.5	-10	198.9	75.00	198.9	75.02	197.8	72.93	197.8	71.11	197.8	68.84	195.4	67.28
	-8.5	-9.1	202.8	75.36	202.8	73.90	201.5	71.87	201.5	70.10	201.3	67.95	198.7	66.42
	-7.0	-7.6	208.6	73.70	208.6	72.23	207.2	70.29	207.2	68.58	206.8	66.59	204.0	65.11
	-5.0	-5.6	216.3	71.48	216.3	69.99	215.0	68.17	215.0	66.55	215.0	64.76	210.9	63.37
	-3.0	-3.7	223.9	69.26	223.9	67.78	222.5	66.05	222.5	64.55	222.5	62.96	216.9	61.63
	0.0	-0.7	235.5	65.94	235.5	64.42	233.9	62.88	233.9	61.50	233.9	60.24	217.7	59.03
	3.0	2.2	246.9	62.62	246.9	61.07	245.4	59.71	241.8	58.47	234.3	57.52	217.7	56.42
	5.0	4.1	250.2	54.82	249.4	53.35	245.1	52.15	237.1	51.04	229.6	50.29	213.3	49.31
	7.0	6.0	251.3	51.78	248.7	50.38	239.0	49.38	231.0	48.43	223.8	47.98	207.8	47.12
	9.0	7.9	242.9	48.08	239.6	46.76	230.2	45.84	222.4	44.97	215.5	44.53	200.3	43.74
	11.0	9.8	229.6	44.96	226.6	43.73	217.7	42.86	210.3	42.05	203.9	41.65	189.3	40.92
	13.0	11.8	215.8	41.21	212.8	40.09	204.5	39.30	197.6	38.55	191.5	38.18	177.9	37.50
15.0	13.7	204.2	38.07	201.4	37.03	193.4	36.30	187.0	35.62	181.2	35.28	168.3	34.65	
110	-24.8	-25	126.6	70.05	126.6	70.74	125.8	71.43	125.8	72.50	125.8	73.24	123.3	73.59
	-21.8	-22	154.3	71.10	154.3	71.81	153.2	72.50	153.2	73.55	153.2	74.31	150.4	74.64
	-19.8	-20	162.9	71.81	162.9	72.53	161.8	73.19	161.8	74.26	161.8	75.00	158.7	75.36
	-18.8	-19	166.4	72.17	166.4	72.88	165.3	73.55	165.3	74.62	165.3	75.36	162.2	74.39
	-16.7	-17	173.8	72.91	173.8	73.62	172.7	74.31	172.7	75.36	172.7	73.39	169.4	72.36
	-13.7	-15	184.3	73.98	184.3	74.69	183.2	75.36	183.2	72.37	183.2	70.56	183.2	69.47
	-11.8	-13	190.4	74.64	190.4	75.36	189.2	73.25	189.2	70.47	189.2	68.77	189.2	67.63
	-9.8	-11	196.7	75.36	196.7	72.98	195.6	71.04	195.6	68.48	195.6	66.89	194.3	65.71
	-9.5	-10	197.8	74.97	197.8	72.62	196.7	70.69	196.7	68.18	196.7	66.61	195.9	65.43
	-8.5	-9.1	201.7	73.69	201.7	71.43	200.6	69.58	200.6	67.18	200.6	65.65	195.9	64.44
	-7.0	-7.6	207.5	71.75	207.5	69.65	206.1	67.92	206.1	65.69	206.1	64.25	195.9	63.01
	-5.0	-5.6	215.0	69.20	215.0	67.25	213.6	65.71	213.6	63.70	209.7	62.37	195.9	61.06
	-3.0	-3.7	222.7	66.62	222.7	64.87	221.4	63.47	217.2	61.69	209.7	60.47	195.9	59.14
	0.0	-0.7	234.1	62.77	234.1	61.30	224.4	60.15	217.2	58.71	209.7	57.66	195.9	56.25
	3.0	2.2	245.5	58.91	239.3	57.73	224.4	56.81	217.2	55.73	209.7	54.82	195.9	53.34
	5.0	4.1	248.1	51.12	234.3	50.13	220.0	49.38	212.8	48.52	205.6	47.78	192.0	46.38
	7.0	6.0	241.7	47.85	228.5	47.14	214.4	46.61	207.5	46.04	200.3	45.45	187.1	44.04
	9.0	7.9	232.9	44.19	220.0	43.53	206.4	43.04	199.8	42.51	193.1	41.98	180.2	40.67
	11.0	9.8	220.2	41.08	208.1	40.46	195.3	40.01	189.0	39.53	182.6	39.01	170.5	37.81
	13.0	11.8	206.7	37.43	195.4	36.85	183.5	36.44	177.4	35.99	171.3	35.54	160.0	34.45
15.0	13.7	195.6	34.30	184.9	33.78	173.5	33.39	167.8	33.00	162.2	32.58	151.4	31.56	

# 7. Capacity Tables

Heating Capacity (66HP)

Combination (%)	Outdoor air temp.		Indoor air temp. °C DB											
			16		18		20		21		22		24	
	°C DB	°C WB	TC	PI	TC	PI	TC	PI	TC	PI	TC	PI	TC	PI
100	-24.8	-25	126.0	76.49	126.0	76.35	125.2	71.71	125.2	75.97	125.2	75.82	122.7	75.75
	-21.8	-22	153.5	76.26	153.5	76.12	152.6	73.98	152.6	75.74	152.6	76.48	149.6	75.52
	-19.8	-20	162.1	76.12	162.1	75.96	161.2	75.39	161.2	75.60	161.2	75.74	158.2	75.36
	-18.8	-19	165.6	76.05	164.7	75.89	164.7	75.74	164.7	75.51	164.7	75.36	161.4	74.18
	-16.7	-17	171.9	75.89	171.9	75.73	171.9	76.48	171.1	75.36	171.1	72.92	167.8	71.70
	-13.7	-15	183.5	75.66	183.5	75.50	182.4	75.36	182.4	71.82	182.4	69.43	179.0	68.13
	-11.8	-13	189.5	75.52	188.4	75.36	188.4	72.99	188.4	69.57	188.4	67.21	179.0	65.89
	-9.8	-11	195.6	75.36	195.6	72.71	194.8	70.49	194.8	67.22	192.1	64.89	179.0	63.52
	-9.5	-10	196.7	74.94	196.7	72.30	195.9	70.13	195.9	66.86	192.1	64.54	179.0	63.16
	-8.5	-9.1	200.6	73.56	200.6	70.98	199.7	68.87	198.7	65.68	192.1	63.38	179.0	61.97
	-7.0	-7.6	209.7	71.48	208.9	68.99	205.3	67.00	198.7	63.93	192.1	61.64	179.0	60.19
	-5.0	-5.6	218.9	68.70	216.7	66.35	205.3	64.52	198.7	61.55	192.1	59.31	179.0	57.82
	-3.0	-3.7	225.2	65.93	218.5	63.68	205.3	62.02	198.7	59.19	192.1	56.99	179.0	55.45
	0.0	-0.7	231.6	61.77	218.5	59.71	205.3	58.28	198.7	55.65	192.1	53.49	179.0	51.90
	3.0	2.2	231.6	57.60	218.5	55.72	205.3	54.54	198.7	52.12	192.1	50.00	179.0	48.35
	5.0	4.1	226.9	49.78	214.1	48.12	201.2	47.11	194.8	44.99	188.4	43.06	175.5	41.53
	7.0	6.0	221.1	46.33	208.6	44.87	196.1	44.09	189.8	42.19	183.5	40.37	171.0	38.82
	9.0	7.9	213.0	42.43	200.9	41.09	189.0	40.39	182.9	38.63	176.8	36.96	164.7	35.54
	11.0	9.8	201.4	39.06	190.1	37.82	178.5	37.17	173.0	35.56	167.2	34.02	155.8	32.72
	13.0	11.8	189.3	35.16	178.5	34.05	167.7	33.46	162.4	32.02	157.0	30.64	146.2	29.46
15.0	13.7	179.0	31.81	168.8	30.81	158.6	30.27	153.6	28.95	148.6	27.70	138.4	26.65	
90	-24.8	-25	125.5	68.59	125.5	69.64	124.7	70.40	124.7	70.74	124.7	71.45	122.4	72.52
	-21.8	-22	152.9	69.64	152.9	70.71	152.0	71.45	152.0	71.81	152.0	72.52	149.0	69.42
	-19.8	-20	161.5	70.35	161.5	71.42	160.4	72.16	160.4	72.52	160.4	70.39	157.4	67.35
	-18.8	-19	165.6	70.71	164.7	71.78	163.9	72.52	163.9	71.44	163.9	69.34	160.8	66.33
	-16.7	-17	171.9	71.45	171.9	72.52	171.3	70.27	171.3	69.14	171.3	67.13	163.6	64.15
	-13.7	-15	183.5	72.52	183.5	69.17	181.8	67.06	181.8	65.88	176.3	63.95	163.6	61.05
	-11.8	-13	189.5	70.22	188.4	67.05	187.6	65.01	182.1	63.80	176.3	61.95	163.6	59.09
	-9.8	-11	195.6	67.83	195.6	64.83	187.9	62.87	182.1	61.62	176.3	59.82	163.6	57.02
	-9.5	-10	196.7	67.45	196.7	64.49	187.9	62.55	182.1	61.30	176.3	59.50	163.6	56.70
	-8.5	-9.1	200.6	66.26	199.2	63.38	187.9	61.47	182.1	60.21	176.3	58.45	163.6	55.67
	-7.0	-7.6	209.7	64.44	199.5	61.70	187.9	59.87	182.1	58.57	176.3	56.86	163.6	54.11
	-5.0	-5.6	212.0	62.03	199.5	59.48	187.9	57.74	182.1	56.41	176.3	54.75	163.6	52.06
	-3.0	-3.7	212.0	59.62	199.5	57.26	187.9	55.58	182.1	54.22	176.3	52.62	163.6	49.99
	0.0	-0.7	212.0	56.01	199.5	53.91	187.9	52.36	182.1	50.96	176.3	49.45	163.6	46.89
	3.0	2.2	212.0	52.39	199.5	50.55	187.9	49.15	182.1	47.69	176.3	46.29	163.6	43.78
	5.0	4.1	207.8	45.26	195.6	43.69	184.0	42.45	178.5	41.11	172.7	39.86	160.3	37.62
	7.0	6.0	202.5	42.34	190.6	41.03	179.3	39.92	173.8	38.58	168.3	37.42	156.4	35.29
	9.0	7.9	195.1	38.77	183.5	37.58	172.7	36.56	167.4	35.31	162.2	34.26	150.6	32.32
	11.0	9.8	184.6	35.34	173.5	34.25	163.3	33.32	158.3	32.20	153.3	31.24	142.3	29.44
	13.0	11.8	173.2	31.16	163.0	30.21	153.4	29.41	148.7	28.40	143.9	27.55	133.7	25.98
15.0	13.7	163.9	27.90	154.2	27.03	145.3	26.31	140.7	25.42	136.2	24.65	126.5	23.25	
80	-24.8	-25	124.9	60.37	124.9	61.44	124.1	62.18	124.1	62.54	124.1	64.30	121.8	61.58
	-21.8	-22	151.3	61.44	151.3	62.49	151.3	63.23	151.3	64.30	151.3	61.58	146.2	58.95
	-19.8	-20	159.8	62.13	159.8	63.20	159.8	64.30	159.8	62.38	157.2	59.75	146.2	57.20
	-18.8	-19	163.3	62.49	163.3	64.30	163.3	63.33	162.8	61.42	157.2	58.84	146.2	56.34
	-16.7	-17	168.0	64.30	168.0	62.27	168.0	61.28	163.0	59.40	157.2	56.95	146.2	54.51
	-13.7	-15	175.7	61.30	172.2	59.36	168.0	58.36	163.0	56.51	157.2	54.21	146.2	51.88
	-11.8	-13	180.3	59.38	175.0	57.52	168.0	56.50	163.0	54.68	157.2	52.48	146.2	50.21
	-9.8	-11	185.0	57.38	177.3	55.60	168.0	54.56	163.0	52.76	157.2	50.65	146.2	48.46
	-9.5	-10	186.3	57.08	178.4	55.30	168.0	54.26	163.0	52.47	157.2	50.38	146.2	48.22
	-8.5	-9.1	188.1	56.08	179.0	54.33	168.0	53.29	163.0	51.50	157.2	49.49	146.2	47.33
	-7.0	-7.6	189.8	54.56	179.0	52.88	168.0	51.83	163.0	50.07	157.2	48.12	146.2	46.02
	-5.0	-5.6	189.8	52.56	179.0	50.95	168.0	49.87	163.0	48.13	157.2	46.29	146.2	44.27
	-3.0	-3.7	189.8	50.56	179.0	49.01	168.0	47.92	163.0	46.22	157.2	44.49	146.2	42.52
	0.0	-0.7	189.8	47.53	179.0	46.12	168.0	45.01	163.0	43.33	157.2	41.74	146.2	39.91
	3.0	2.2	189.8	44.53	179.0	43.21	168.0	42.07	163.0	40.43	157.2	39.02	146.2	37.28
	5.0	4.1	186.0	38.44	175.4	37.28	164.7	36.25	159.7	34.77	153.9	33.56	143.4	32.05
	7.0	6.0	181.3	36.05	171.0	35.02	160.5	33.97	155.6	32.57	150.0	31.49	139.6	30.07
	9.0	7.9	174.6	32.10	164.7	31.21	154.5	30.43	150.0	29.26	144.5	28.21	134.5	26.88
	11.0	9.8	165.2	28.34	155.6	27.56	146.2	26.87	141.8	25.83	136.8	24.92	127.1	23.73
	13.0	11.8	155.0	24.45	146.2	23.76	137.3	23.17	133.2	22.27	128.5	21.48	119.4	20.47
15.0	13.7	146.7	21.87	138.4	21.24	129.9	20.73	126.0	19.91	121.5	19.22	113.0	18.30	

# 7. Capacity Tables

Heating Capacity (66HP)

Combination (%)	Outdoor air temp.		Indoor air temp. °C DB											
			16		18		20		21		22		24	
	°C DB	°C WB	TC	PI	TC	PI	TC	PI	TC	PI	TC	PI	TC	PI
70	-24.8	-25	124.9	60.67	124.9	61.02	124.1	61.74	124.1	62.81	124.1	59.83	120.9	57.04
	-21.8	-22	144.0	61.74	144.0	62.09	143.1	62.81	138.2	59.83	134.0	57.04	125.1	54.35
	-19.8	-20	156.6	62.45	152.0	62.81	143.1	60.71	138.2	57.84	134.0	55.18	125.1	52.56
	-18.8	-19	159.8	62.81	152.0	61.73	143.1	59.66	138.2	56.85	134.0	54.25	125.1	51.65
	-16.7	-17	161.1	60.55	152.0	59.45	143.1	57.48	138.2	54.75	134.0	52.31	125.1	49.77
	-13.7	-15	161.1	57.37	152.0	56.22	143.1	54.34	138.2	51.79	134.0	49.52	125.1	47.07
	-11.8	-13	161.1	55.32	152.0	54.17	143.1	52.35	138.2	49.89	134.0	47.75	125.1	45.37
	-9.8	-11	161.1	53.20	152.0	52.00	143.1	50.28	138.2	47.91	134.0	45.90	125.1	43.58
	-9.5	-10	161.1	52.87	152.0	51.67	143.1	49.96	138.2	47.61	134.0	45.63	125.1	43.31
	-8.5	-9.1	161.1	51.82	152.0	50.60	143.1	48.91	138.2	46.62	134.0	44.69	125.1	42.40
	-7.0	-7.6	161.1	50.21	152.0	48.98	143.1	47.35	138.2	45.14	134.0	43.30	125.1	41.06
	-5.0	-5.6	161.1	48.08	152.0	46.83	143.1	45.26	138.2	43.15	134.0	41.44	125.1	39.26
	-3.0	-3.7	161.1	45.95	152.0	44.65	143.1	43.16	138.2	41.16	134.0	39.59	125.1	37.47
	0.0	-0.7	161.1	42.74	152.0	41.42	143.1	40.04	138.2	38.18	134.0	36.80	125.1	34.78
	3.0	2.2	161.1	39.54	152.0	38.19	143.1	36.90	138.2	35.22	134.0	34.01	125.1	32.08
	5.0	4.1	161.1	34.57	148.9	32.56	140.1	31.48	135.4	30.00	131.3	29.04	122.6	27.35
	7.0	6.0	161.1	32.97	145.1	30.14	136.5	29.12	131.8	27.80	128.0	26.96	119.4	25.35
	9.0	7.9	155.3	28.39	139.8	25.93	131.5	25.07	127.1	23.94	123.3	23.21	115.0	21.82
	11.0	9.8	147.0	25.02	132.3	22.86	124.4	22.11	120.2	21.10	116.6	20.47	108.8	19.24
	13.0	11.8	137.9	21.77	124.3	19.91	116.9	19.24	112.8	18.37	109.4	17.80	102.2	16.74
15.0	13.7	130.4	19.24	117.5	17.58	110.5	16.99	106.7	16.22	103.6	15.74	96.7	14.79	
60	-24.8	-25	122.7	59.95	122.7	60.67	121.9	61.74	118.5	58.54	114.4	55.56	107.2	52.75
	-21.8	-22	131.9	61.02	130.7	61.74	122.7	58.54	118.5	55.56	114.4	52.75	107.2	50.04
	-19.8	-20	138.2	61.74	130.7	59.48	122.7	56.42	118.5	53.57	114.4	50.87	107.2	48.22
	-18.8	-19	138.2	60.61	130.7	58.35	122.7	55.35	118.5	52.56	114.4	49.93	107.2	47.31
	-16.7	-17	138.2	58.21	130.7	55.99	122.7	53.12	118.5	50.47	114.4	47.97	107.2	45.41
	-13.7	-15	138.2	54.80	130.7	52.62	122.7	49.95	118.5	47.49	114.4	45.16	107.2	42.70
	-11.8	-13	138.2	52.64	130.7	50.48	122.7	47.91	118.5	45.58	114.4	43.39	107.2	40.99
	-9.8	-11	138.2	50.38	130.7	48.22	122.7	45.79	118.5	43.60	114.4	41.51	107.2	39.17
	-9.5	-10	138.2	50.03	130.7	47.90	122.7	45.47	118.5	43.30	114.4	41.22	107.2	38.90
	-8.5	-9.1	138.2	48.90	130.7	46.77	122.7	44.42	118.5	42.31	114.4	40.28	107.2	37.99
	-7.0	-7.6	138.2	47.20	130.7	45.08	122.7	42.83	118.5	40.81	114.4	38.88	107.2	36.63
	-5.0	-5.6	138.2	44.92	130.7	42.82	122.7	40.69	118.5	38.82	114.4	37.01	107.2	34.83
	-3.0	-3.7	138.2	42.66	130.7	40.56	122.7	38.57	118.5	36.83	114.4	35.13	107.2	33.01
	0.0	-0.7	138.2	39.24	130.7	37.20	122.7	35.39	118.5	33.83	114.4	32.32	107.2	30.30
	3.0	2.2	138.2	35.83	130.7	33.82	122.7	32.20	118.5	30.85	114.4	29.52	107.2	27.57
	5.0	4.1	135.4	30.38	128.2	28.56	120.2	27.18	116.1	26.07	112.2	24.99	105.0	23.30
	7.0	6.0	131.8	27.85	124.9	26.09	117.1	24.87	113.3	23.90	109.4	22.93	102.2	21.32
	9.0	7.9	127.1	23.73	120.2	22.21	112.8	21.19	109.1	20.35	105.3	19.54	98.6	18.15
	11.0	9.8	120.2	20.91	113.8	19.58	106.7	18.67	103.1	17.94	99.5	17.22	93.1	16.00
	13.0	11.8	112.8	18.19	106.9	17.03	100.3	16.23	96.7	15.61	93.4	14.96	87.6	13.93
15.0	13.7	106.7	16.22	101.1	15.18	94.8	14.33	91.7	13.79	88.4	13.23	82.9	12.42	
50	-24.8	-25	115.2	52.32	108.6	53.39	102.2	50.58	98.9	47.95	95.6	45.46	89.0	43.16
	-21.8	-22	115.2	53.39	108.6	50.58	102.2	47.95	98.9	45.46	95.6	43.16	89.0	40.94
	-19.8	-20	115.2	51.43	108.6	48.70	102.2	46.21	98.9	43.80	95.6	41.61	89.0	39.44
	-18.8	-19	115.2	50.44	108.6	47.76	102.2	45.33	98.9	43.00	95.6	40.84	89.0	38.70
	-16.7	-17	115.2	48.40	108.6	45.81	102.2	43.50	98.9	41.26	95.6	39.23	89.0	37.14
	-13.7	-15	115.2	45.47	108.6	42.99	102.2	40.88	98.9	38.77	95.6	36.92	89.0	34.92
	-11.8	-13	115.2	43.62	108.6	41.22	102.2	39.21	98.9	37.19	95.6	35.45	89.0	33.51
	-9.8	-11	115.2	41.66	108.6	39.35	102.2	37.45	98.9	35.53	95.6	33.90	89.0	32.01
	-9.5	-10	115.2	41.37	108.6	39.08	102.2	37.20	98.9	35.29	95.6	33.68	89.0	31.80
	-8.5	-9.1	115.2	40.38	108.6	38.14	102.2	36.32	98.9	34.46	95.6	32.91	89.0	31.05
	-7.0	-7.6	115.2	38.93	108.6	36.74	102.2	35.01	98.9	33.22	95.6	31.76	89.0	29.95
	-5.0	-5.6	115.2	36.97	108.6	34.87	102.2	33.27	98.9	31.57	95.6	30.21	89.0	28.46
	-3.0	-3.7	115.2	35.01	108.6	32.99	102.2	31.50	98.9	29.91	95.6	28.66	89.0	26.98
	0.0	-0.7	115.2	32.09	108.6	30.18	102.2	28.88	98.9	27.42	95.6	26.35	89.0	24.74
	3.0	2.2	115.2	29.16	108.6	27.39	102.2	26.27	98.9	24.93	95.6	24.05	89.0	22.52
	5.0	4.1	113.0	24.62	106.6	23.06	100.1	22.16	97.0	21.05	93.7	20.34	87.3	19.02
	7.0	6.0	110.0	22.48	103.9	21.03	97.5	20.26	94.5	19.24	91.4	18.66	85.1	17.39
	9.0	7.9	106.1	19.33	100.0	18.10	94.0	17.44	90.9	16.58	87.9	16.06	82.0	14.98
	11.0	9.8	100.8	17.24	95.1	16.15	89.3	15.55	86.0	14.77	83.2	14.31	77.6	13.34
	13.0	11.8	94.2	14.83	88.7	13.90	83.5	13.39	80.7	12.79	78.2	12.33	72.7	11.56
15.0	13.7	89.0	13.26	84.0	12.42	79.0	11.96	76.5	11.37	74.0	11.01	68.8	10.27	

**Note**

1. TC: Total Capacity(kW), PI : Power Input(kW, Comp. + Outdoor fan motor)
2. Capacity tables show the average value of conditions which may occur.
3. The heating capacity table is based on the values expressed as Max. in the specification of the outdoor unit. (When measuring the Max. heating capacity, the setting status of the indoor unit is the same as that for measuring the heating capacity of the indoor unit.)

# 7. Capacity Tables

## ◆ ARUM680LTE5

Heating Capacity (68HP)

Combination (%)	Outdoor air temp.		Indoor air temp. °C DB											
			16		18		20		21		22		24	
	°C DB	°C WB	TC	PI	TC	PI	TC	PI	TC	PI	TC	PI	TC	PI
130	-24.8	-25	130.3	72.7	130.3	73.15	129.4	73.57	129.4	74.20	129.4	74.83	127.1	75.80
	-21.8	-22	160.0	73.62	160.0	74.11	158.9	74.53	158.9	75.18	158.9	75.80	155.8	76.76
	-19.8	-20	169.5	74.27	169.5	74.76	168.3	75.18	168.3	75.83	168.3	76.43	165.2	77.41
	-18.8	-19	173.3	74.59	173.3	75.08	172.2	75.50	172.2	76.15	172.2	76.76	168.8	77.73
	-16.7	-17	181.2	75.27	181.2	75.76	180.1	76.18	180.1	76.83	180.1	77.45	176.7	78.41
	-13.7	-15	192.5	76.25	192.5	76.73	191.4	77.15	191.4	77.80	191.4	78.41	187.7	75.57
	-11.8	-13	198.8	76.87	198.8	77.34	197.6	77.76	197.6	78.41	197.6	79.07	194.7	73.76
	-9.8	-11	205.3	77.50	205.3	77.99	204.2	78.41	204.2	79.07	204.2	79.72	202.0	71.87
	-9.5	-10	206.5	77.62	206.5	78.08	205.3	78.10	205.3	78.70	205.1	79.20	203.1	71.57
	-8.5	-9.1	210.5	77.92	210.5	78.41	209.3	77.07	209.3	77.67	208.4	78.20	206.8	70.62
	-7.0	-7.6	216.5	78.41	216.5	78.93	215.1	78.54	215.1	79.15	215.1	79.76	212.2	69.20
	-5.0	-5.6	224.4	78.51	224.4	79.03	223.0	78.54	223.0	79.15	223.0	79.76	219.5	67.31
	-3.0	-3.7	232.4	78.62	232.4	79.15	231.0	78.66	231.0	79.27	231.0	79.89	226.8	65.39
	0.0	-0.7	244.3	78.76	244.3	79.27	242.7	78.78	242.7	79.39	242.7	80.01	238.0	62.55
	3.0	2.2	256.3	78.92	256.3	79.39	254.6	78.90	254.6	79.01	254.6	80.63	251.4	59.71
	5.0	4.1	259.4	79.08	259.4	79.51	257.2	79.02	257.2	79.13	257.2	81.25	264.1	56.18
	7.0	6.0	263.3	79.24	263.3	79.63	258.3	79.14	258.3	79.25	258.3	81.87	277.1	52.76
9.0	7.9	252.1	79.09	252.1	79.21	250.9	78.72	250.9	78.83	250.9	79.45	219.8	46.45	
11.0	9.8	238.4	79.24	238.4	79.36	237.2	78.87	237.2	78.98	237.2	79.60	209.9	43.70	
13.0	11.8	223.9	79.39	223.9	79.47	222.7	78.98	222.7	79.09	222.7	79.71	195.1	40.33	
15.0	13.7	211.9	79.54	211.9	79.55	210.7	79.06	210.7	79.17	210.7	79.79	184.6	37.55	
120	-24.8	-25	129.4	73.15	129.4	73.57	128.5	74.20	128.5	74.83	128.5	75.80	126.2	76.48
	-21.8	-22	158.9	74.11	158.9	74.53	157.8	75.18	157.8	75.80	157.8	76.76	154.9	77.45
	-19.8	-20	168.3	74.76	168.3	75.18	167.2	75.83	167.2	76.43	167.2	77.41	164.0	78.08
	-18.8	-19	172.0	75.08	172.0	75.50	170.9	76.15	170.9	76.76	170.9	77.33	167.7	78.41
	-16.7	-17	179.9	75.76	179.9	76.18	178.7	76.83	178.7	77.45	178.7	78.02	175.3	76.57
	-13.7	-15	191.1	76.73	191.1	77.15	190.0	77.80	190.0	78.41	190.0	79.00	186.3	73.96
	-11.8	-13	197.4	77.34	197.4	77.76	196.2	78.41	196.2	79.02	196.2	79.62	193.3	72.31
	-9.8	-11	203.9	77.99	203.9	78.41	202.7	79.02	202.7	79.62	202.7	80.22	200.6	70.56
	-9.5	-10	205.1	78.08	205.1	78.08	203.9	78.08	203.9	78.69	203.9	79.29	201.7	70.29
	-8.5	-9.1	209.0	78.41	209.0	78.92	207.7	77.93	207.7	78.54	207.7	79.14	205.2	68.42
	-7.0	-7.6	215.0	78.77	215.0	79.29	213.6	78.80	213.6	79.41	213.6	80.02	210.7	66.11
	-5.0	-5.6	223.0	78.87	223.0	79.40	221.5	78.91	221.5	79.52	221.5	80.13	218.1	63.36
	-3.0	-3.7	230.7	79.02	230.7	79.52	229.3	79.03	229.3	79.64	229.3	80.25	224.4	60.61
	0.0	-0.7	242.6	79.17	242.6	79.63	241.0	79.14	241.0	79.75	241.0	80.36	236.6	57.86
	3.0	2.2	254.4	79.32	254.4	79.74	252.9	79.25	252.9	79.86	252.9	80.97	251.4	55.11
	5.0	4.1	257.8	79.48	257.8	80.16	256.6	79.67	256.6	80.28	256.6	81.58	264.1	51.96
	7.0	6.0	258.9	79.63	258.9	80.27	257.3	79.78	257.3	80.39	257.3	81.79	277.1	48.71
9.0	7.9	250.3	79.48	250.3	79.59	249.2	79.10	249.2	79.71	249.2	80.32	206.4	46.28	
11.0	9.8	236.7	79.63	236.7	79.74	235.5	79.25	235.5	79.86	235.5	80.43	195.1	43.41	
13.0	11.8	222.4	79.78	222.4	79.85	221.2	79.36	221.2	79.47	221.2	80.64	183.4	40.66	
15.0	13.7	210.4	79.93	210.4	79.96	209.3	79.47	209.3	79.58	209.3	80.85	173.4	37.92	
110	-24.8	-25	128.8	73.57	128.8	74.20	127.9	74.83	127.9	75.80	127.9	76.48	125.4	76.80
	-21.8	-22	158.0	74.53	158.0	75.18	156.9	75.80	156.9	76.43	156.9	77.02	154.0	77.76
	-19.8	-20	167.4	75.18	167.4	75.83	166.3	76.43	166.3	77.02	166.3	77.63	163.1	78.41
	-18.8	-19	171.1	75.50	171.1	76.15	170.0	76.76	170.0	77.33	170.0	77.94	166.8	77.43
	-16.7	-17	179.0	76.18	179.0	76.83	177.8	77.45	177.8	78.02	177.8	78.63	174.4	75.38
	-13.7	-15	190.0	77.15	190.0	77.80	188.8	78.41	188.8	79.02	188.8	79.63	188.8	72.45
	-11.8	-13	196.2	77.76	196.2	78.41	195.1	79.02	195.1	79.63	195.1	80.24	195.1	70.59
	-9.8	-11	202.8	78.41	202.8	79.02	201.6	79.63	201.6	80.24	201.6	80.85	200.6	68.64
	-9.5	-10	203.9	78.50	203.9	78.50	202.8	78.50	202.8	79.11	202.8	79.72	201.9	68.36
	-8.5	-9.1	207.9	78.83	207.9	79.34	206.7	78.85	206.7	79.45	206.7	80.06	201.9	67.37
	-7.0	-7.6	213.9	79.39	213.9	79.91	212.5	79.42	212.5	80.03	212.5	80.64	201.9	65.92
	-5.0	-5.6	221.6	79.49	221.6	80.02	220.2	79.53	220.2	80.14	220.2	80.75	201.9	63.95
	-3.0	-3.7	229.5	79.64	229.5	80.13	228.1	79.64	228.1	80.25	228.1	80.86	201.9	62.00
	0.0	-0.7	241.2	79.79	241.2	80.24	239.3	79.75	239.3	80.36	239.3	80.97	201.9	59.07
	3.0	2.2	252.9	79.94	252.9	80.35	251.3	79.86	251.3	80.47	251.3	81.58	201.9	56.13
	5.0	4.1	255.7	80.10	255.7	80.46	254.2	79.97	254.2	80.58	254.2	81.79	197.9	48.87
	7.0	6.0	249.2	80.25	249.2	80.57	248.0	80.08	248.0	80.69	248.0	81.30	192.8	46.48
9.0	7.9	240.0	80.40	240.0	80.68	238.8	80.19	238.8	80.80	238.8	81.41	185.7	43.03	
11.0	9.8	227.0	80.55	227.0	80.79	226.1	80.30	226.1	80.91	226.1	81.52	175.7	40.11	
13.0	11.8	213.0	80.70	213.0	80.89	212.1	80.41	212.1	80.52	212.1	81.63	164.9	36.66	
15.0	13.7	201.6	80.85	201.6	81.00	199.9	80.52	199.9	80.63	199.9	81.74	156.1	33.71	

# 7. Capacity Tables

Heating Capacity (68HP)

Combination (%)	Outdoor air temp.		Indoor air temp. °C DB											
			16		18		20		21		22		24	
	°C DB	°C WB	TC	PI	TC	PI	TC	PI	TC	PI	TC	PI	TC	PI
100	-24.8	-25	128.2	81.31	128.2	80.94	127.4	75.23	127.4	79.98	127.4	79.58	124.8	79.39
	-21.8	-22	157.2	80.73	157.2	80.35	156.3	77.60	156.3	79.40	156.3	80.07	153.2	78.81
	-19.8	-20	166.6	80.35	166.6	79.95	165.7	79.07	165.7	79.02	165.7	78.97	162.5	78.41
	-18.8	-19	170.3	80.16	169.4	79.77	169.4	79.40	169.4	78.81	169.4	78.41	166.0	77.21
	-16.7	-17	177.0	79.76	177.0	79.36	177.0	80.07	176.1	78.41	176.1	75.93	172.7	74.68
	-13.7	-15	189.1	79.17	189.1	78.78	188.0	78.41	188.0	74.82	188.0	72.37	184.5	71.04
	-11.8	-13	195.3	78.81	194.2	78.41	194.2	76.02	194.2	72.54	194.2	70.12	184.5	68.75
	-9.8	-11	201.7	78.41	201.7	75.74	200.8	73.49	200.8	70.15	198.0	67.75	184.5	66.33
	-9.5	-10	202.8	77.99	202.8	75.32	201.9	73.12	201.9	69.79	198.0	67.40	184.5	65.97
	-8.5	-9.1	206.8	76.60	206.8	73.99	205.9	71.85	204.8	68.59	198.0	66.22	184.5	64.75
	-7.0	-7.6	216.2	74.51	215.3	71.98	211.6	69.95	204.8	66.80	198.0	64.44	184.5	62.94
	-5.0	-5.6	225.6	71.70	223.3	69.31	211.6	67.44	204.8	64.39	198.0	62.08	184.5	60.53
	-3.0	-3.7	232.1	68.92	225.2	66.62	211.6	64.92	204.8	62.00	198.0	59.71	184.5	58.11
	0.0	-0.7	238.7	64.72	225.2	62.61	211.6	61.13	204.8	58.41	198.0	56.15	184.5	54.49
	3.0	2.2	238.7	60.52	225.2	58.58	211.6	57.35	204.8	54.82	198.0	52.60	184.5	50.87
	5.0	4.1	233.8	52.40	220.7	50.67	207.3	49.62	200.8	47.39	194.2	45.37	180.8	43.75
	7.0	6.0	227.9	48.90	215.0	47.37	202.2	46.53	195.6	44.53	189.1	42.61	176.3	40.97
	9.0	7.9	219.6	45.06	207.1	43.64	194.8	42.89	188.5	41.02	182.3	39.25	169.7	37.74
	11.0	9.8	207.6	41.77	195.9	40.44	184.0	39.75	178.3	38.02	172.3	36.38	160.6	34.99
	13.0	11.8	195.1	37.91	184.0	36.72	172.9	36.08	167.4	34.52	161.8	33.04	150.7	31.76
15.0	13.7	184.5	34.63	174.0	33.54	163.5	32.96	158.3	31.52	153.2	30.15	142.7	29.01	
90	-24.8	-25	127.7	72.34	127.7	73.29	126.8	73.99	126.8	74.29	126.8	74.95	124.5	75.92
	-21.8	-22	156.6	73.29	156.6	74.27	155.7	74.95	155.7	75.27	155.7	75.92	152.6	72.71
	-19.8	-20	166.0	73.95	166.0	74.92	164.9	75.60	164.9	75.92	164.9	73.72	161.8	70.57
	-18.8	-19	170.3	74.27	169.4	75.25	168.6	75.92	168.6	74.80	168.6	72.63	165.4	69.50
	-16.7	-17	177.0	74.95	177.0	75.92	176.4	73.60	176.4	72.43	176.4	70.34	168.6	67.24
	-13.7	-15	189.1	75.92	189.1	72.46	187.4	70.28	187.4	69.06	181.7	67.05	168.6	64.04
	-11.8	-13	195.3	73.55	194.2	70.28	193.4	68.16	187.7	66.91	181.7	64.98	168.6	62.00
	-9.8	-11	201.7	71.09	201.7	67.99	193.6	65.96	187.7	64.65	181.7	62.78	168.6	59.85
	-9.5	-10	202.8	70.70	202.8	67.63	193.6	65.62	187.7	64.31	181.7	62.45	168.6	59.52
	-8.5	-9.1	206.8	69.47	205.3	66.49	193.6	64.51	187.7	63.20	181.7	61.36	168.6	58.46
	-7.0	-7.6	216.2	67.60	205.6	64.76	193.6	62.86	187.7	61.50	181.7	59.71	168.6	56.84
	-5.0	-5.6	218.5	65.11	205.6	62.47	193.6	60.65	187.7	59.26	181.7	57.53	168.6	54.72
	-3.0	-3.7	218.5	62.63	205.6	60.17	193.6	58.42	187.7	57.00	181.7	55.33	168.6	52.57
	0.0	-0.7	218.5	58.91	205.6	56.71	193.6	55.10	187.7	53.62	181.7	52.04	168.6	49.36
	3.0	2.2	218.5	55.18	205.6	53.26	193.6	51.78	187.7	50.25	181.7	48.77	168.6	46.13
	5.0	4.1	214.2	47.71	201.6	46.07	189.7	44.76	183.9	43.34	178.0	42.03	165.2	39.67
	7.0	6.0	208.7	44.69	196.5	43.31	184.8	42.14	179.1	40.72	173.4	39.50	161.2	37.24
	9.0	7.9	201.1	41.17	189.1	39.91	178.0	38.83	172.6	37.50	167.1	36.38	155.2	34.32
	11.0	9.8	190.2	37.80	178.9	36.63	168.3	35.63	163.2	34.43	158.0	33.40	146.7	31.49
	13.0	11.8	178.6	33.60	168.0	32.57	158.1	31.71	153.2	30.62	148.4	29.71	137.8	28.01
15.0	13.7	168.9	30.37	158.9	29.43	149.8	28.65	145.0	27.67	140.4	26.84	130.4	25.31	
80	-24.8	-25	127.1	63.73	127.1	64.71	126.3	65.39	126.3	65.71	126.3	67.32	123.9	64.50
	-21.8	-22	154.9	64.71	154.9	65.67	154.9	66.34	154.9	67.32	154.9	64.50	150.7	61.77
	-19.8	-20	164.3	65.34	164.3	66.32	164.3	67.32	164.3	65.33	162.0	62.60	150.7	59.95
	-18.8	-19	168.0	65.67	168.0	67.32	168.0	66.31	167.8	64.33	162.0	61.66	150.7	59.06
	-16.7	-17	173.2	67.32	173.2	65.22	173.2	64.19	168.0	62.24	162.0	59.70	150.7	57.16
	-13.7	-15	181.1	64.22	177.5	62.21	173.2	61.17	168.0	59.25	162.0	56.86	150.7	54.43
	-11.8	-13	185.5	62.24	180.1	60.31	173.2	59.25	168.0	57.36	162.0	55.07	150.7	52.70
	-9.8	-11	190.4	60.17	182.6	58.33	173.2	57.24	168.0	55.37	162.0	53.18	150.7	50.89
	-9.5	-10	191.8	59.86	183.7	58.02	173.2	56.93	168.0	55.07	162.0	52.90	150.7	50.63
	-8.5	-9.1	193.7	58.83	184.5	57.02	173.2	55.93	168.0	54.06	162.0	51.97	150.7	49.72
	-7.0	-7.6	195.7	57.27	184.5	55.51	173.2	54.42	168.0	52.58	162.0	50.55	150.7	48.35
	-5.0	-5.6	195.7	55.20	184.5	53.53	173.2	52.39	168.0	50.58	162.0	48.65	150.7	46.54
	-3.0	-3.7	195.7	53.13	184.5	51.52	173.2	50.38	168.0	48.59	162.0	46.78	150.7	44.72
	0.0	-0.7	195.7	50.01	184.5	48.53	173.2	47.36	168.0	45.61	162.0	43.94	150.7	42.01
	3.0	2.2	195.7	46.91	184.5	45.52	173.2	44.32	168.0	42.60	162.0	41.12	150.7	39.29
	5.0	4.1	191.7	40.53	180.8	39.31	169.7	38.22	164.6	36.66	158.6	35.39	147.8	33.80
	7.0	6.0	186.8	38.05	176.2	36.96	165.4	35.86	160.4	34.38	154.6	33.24	143.8	31.74
	9.0	7.9	180.0	34.14	169.7	33.18	159.2	32.35	154.6	31.10	149.0	29.99	138.7	28.57
	11.0	9.8	170.3	30.35	160.4	29.51	150.7	28.77	146.1	27.65	140.9	26.68	131.0	25.40
	13.0	11.8	159.8	26.40	150.7	25.65	141.5	25.01	137.3	24.04	132.4	23.18	123.1	22.09
15.0	13.7	151.2	23.84	142.7	23.15	133.9	22.59	129.9	21.70	125.3	20.94	116.5	19.94	



# 7. Capacity Tables

Heating Capacity (68HP)

Combination (%)	Outdoor air temp.		Indoor air temp. °C DB											
			16		18		20		21		22		24	
	°C DB	°C WB	TC	PI	TC	PI	TC	PI	TC	PI	TC	PI	TC	PI
70	-24.8	-25	127.1	63.80	127.1	64.13	126.3	64.78	126.3	65.75	126.3	62.66	123.9	59.76
	-21.8	-22	148.4	64.78	148.4	65.10	147.5	65.75	142.4	62.66	138.1	59.76	129.0	56.97
	-19.8	-20	162.6	65.43	156.7	65.75	147.5	63.58	142.4	60.60	138.1	57.84	129.0	55.10
	-18.8	-19	166.0	65.75	156.7	64.64	147.5	62.49	142.4	59.56	138.1	56.86	129.0	54.16
	-16.7	-17	166.0	63.42	156.7	62.27	147.5	60.23	142.4	57.39	138.1	54.85	129.0	52.20
	-13.7	-15	166.0	60.12	156.7	58.92	147.5	56.97	142.4	54.32	138.1	51.95	129.0	49.39
	-11.8	-13	166.0	58.00	156.7	56.80	147.5	54.91	142.4	52.34	138.1	50.11	129.0	47.63
	-9.8	-11	166.0	55.80	156.7	54.54	147.5	52.75	142.4	50.28	138.1	48.19	129.0	45.76
	-9.5	-10	166.0	55.46	156.7	54.21	147.5	52.42	142.4	49.97	138.1	47.91	129.0	45.48
	-8.5	-9.1	166.0	54.37	156.7	53.09	147.5	51.34	142.4	48.94	138.1	46.93	129.0	44.54
	-7.0	-7.6	166.0	52.70	156.7	51.42	147.5	49.72	142.4	47.41	138.1	45.48	129.0	43.14
	-5.0	-5.6	166.0	50.50	156.7	49.18	147.5	47.54	142.4	45.34	138.1	43.56	129.0	41.28
	-3.0	-3.7	166.0	48.29	156.7	46.93	147.5	45.37	142.4	43.28	138.1	41.63	129.0	39.41
	0.0	-0.7	166.0	44.97	156.7	43.58	147.5	42.13	142.4	40.19	138.1	38.73	129.0	36.62
	3.0	2.2	166.0	41.65	156.7	40.23	147.5	38.87	142.4	37.11	138.1	35.84	129.0	33.80
	5.0	4.1	166.0	36.45	153.5	34.33	144.4	33.18	139.5	31.63	135.3	30.63	126.4	28.85
	7.0	6.0	166.1	34.80	149.6	31.82	140.7	30.74	135.9	29.35	131.9	28.46	123.1	26.76
	9.0	7.9	160.1	30.15	144.1	27.54	135.6	26.62	131.0	25.42	127.0	24.65	118.5	23.17
	11.0	9.8	151.5	26.76	136.4	24.45	128.2	23.64	123.9	22.56	120.2	21.89	112.2	20.58
	13.0	11.8	142.1	23.48	128.1	21.47	120.5	20.75	116.2	19.80	112.8	19.20	105.4	18.05
15.0	13.7	134.4	20.94	121.1	19.14	113.9	18.50	110.0	17.66	106.8	17.13	99.7	16.11	
60	-24.8	-25	126.5	63.08	126.5	63.73	125.6	64.71	122.2	61.38	117.9	58.27	110.5	55.34
	-21.8	-22	136.0	64.06	134.7	64.71	126.4	61.38	122.2	58.27	117.9	55.34	110.5	52.51
	-19.8	-20	142.4	64.71	134.7	62.36	126.4	59.17	122.2	56.20	117.9	53.38	110.5	50.61
	-18.8	-19	142.4	63.53	134.7	61.19	126.4	58.06	122.2	55.15	117.9	52.40	110.5	49.66
	-16.7	-17	142.4	61.04	134.7	58.72	126.4	55.73	122.2	52.96	117.9	50.36	110.5	47.68
	-13.7	-15	142.4	57.49	134.7	55.22	126.4	52.42	122.2	49.86	117.9	47.42	110.5	44.85
	-11.8	-13	142.4	55.25	134.7	52.98	126.4	50.30	122.2	47.87	117.9	45.57	110.5	43.06
	-9.8	-11	142.4	52.89	134.7	50.63	126.4	48.09	122.2	45.80	117.9	43.62	110.5	41.16
	-9.5	-10	142.4	52.53	134.7	50.29	126.4	47.76	122.2	45.49	117.9	43.31	110.5	40.88
	-8.5	-9.1	142.4	51.35	134.7	49.12	126.4	46.66	122.2	44.46	117.9	42.34	110.5	39.93
	-7.0	-7.6	142.4	49.59	134.7	47.36	126.4	45.01	122.2	42.89	117.9	40.88	110.5	38.51
	-5.0	-5.6	142.4	47.21	134.7	45.01	126.4	42.78	122.2	40.82	117.9	38.92	110.5	36.63
	-3.0	-3.7	142.4	44.86	134.7	42.66	126.4	40.57	122.2	38.75	117.9	36.96	110.5	34.73
	0.0	-0.7	142.4	41.30	134.7	39.15	126.4	37.26	122.2	35.62	117.9	34.03	110.5	31.91
	3.0	2.2	142.4	37.75	134.7	35.63	126.4	33.93	122.2	32.51	117.9	31.11	110.5	29.06
	5.0	4.1	139.5	32.03	132.1	30.11	123.9	28.66	119.6	27.50	115.6	26.35	108.2	24.57
	7.0	6.0	135.9	29.40	128.7	27.54	120.7	26.26	116.7	25.23	112.7	24.20	105.4	22.50
	9.0	7.9	131.0	25.20	123.9	23.59	116.2	22.50	112.5	21.61	108.5	20.75	101.6	19.28
	11.0	9.8	123.9	22.36	117.3	20.94	109.9	19.97	106.2	19.19	102.6	18.41	96.0	17.11
	13.0	11.8	116.2	19.61	110.2	18.36	103.3	17.50	99.7	16.83	96.3	16.13	90.2	15.02
15.0	13.7	110.0	17.66	104.2	16.53	97.7	15.61	94.5	15.02	91.1	14.40	85.4	13.52	
50	-24.8	-25	118.8	54.92	112.0	55.89	105.4	52.97	102.0	50.24	98.5	47.65	91.7	45.25
	-21.8	-22	118.8	55.89	112.0	52.97	105.4	50.24	102.0	47.65	98.5	45.25	91.7	42.93
	-19.8	-20	118.8	53.86	112.0	51.02	105.4	48.42	102.0	45.92	98.5	43.63	91.7	41.37
	-18.8	-19	118.8	52.83	112.0	50.04	105.4	47.51	102.0	45.08	98.5	42.83	91.7	40.60
	-16.7	-17	118.8	50.71	112.0	48.01	105.4	45.61	102.0	43.26	98.5	41.15	91.7	38.98
	-13.7	-15	118.8	47.67	112.0	45.08	105.4	42.87	102.0	40.67	98.5	38.75	91.7	36.66
	-11.8	-13	118.8	45.74	112.0	43.24	105.4	41.15	102.0	39.03	98.5	37.22	91.7	35.19
	-9.8	-11	118.8	43.71	112.0	41.29	105.4	39.31	102.0	37.30	98.5	35.60	91.7	33.63
	-9.5	-10	118.8	43.40	112.0	41.01	105.4	39.05	102.0	37.05	98.5	35.38	91.7	33.40
	-8.5	-9.1	118.8	42.38	112.0	40.03	105.4	38.14	102.0	36.19	98.5	34.57	91.7	32.62
	-7.0	-7.6	118.8	40.86	112.0	38.58	105.4	36.77	102.0	34.90	98.5	33.37	91.7	31.48
	-5.0	-5.6	118.8	38.83	112.0	36.63	105.4	34.96	102.0	33.18	98.5	31.76	91.7	29.92
	-3.0	-3.7	118.8	36.80	112.0	34.68	105.4	33.12	102.0	31.45	98.5	30.14	91.7	28.38
	0.0	-0.7	118.8	33.76	112.0	31.75	105.4	30.39	102.0	28.86	98.5	27.74	91.7	26.05
	3.0	2.2	118.8	30.71	112.0	28.85	105.4	27.68	102.0	26.27	98.5	25.34	91.7	23.73
	5.0	4.1	116.5	25.95	109.9	24.32	103.1	23.37	99.9	22.20	96.6	21.45	90.0	20.06
	7.0	6.0	113.4	23.72	107.1	22.20	100.5	21.39	97.4	20.31	94.2	19.69	87.7	18.36
	9.0	7.9	109.3	20.53	103.1	19.22	96.8	18.52	93.7	17.60	90.6	17.05	84.6	15.91
	11.0	9.8	103.9	18.44	98.0	17.27	92.0	16.63	88.6	15.80	85.7	15.30	80.0	14.27
	13.0	11.8	97.1	15.99	91.5	14.99	86.0	14.43	83.2	13.79	80.6	13.29	74.9	12.46
15.0	13.7	91.7	14.44	86.6	13.52	81.4	13.02	78.9	12.38	76.3	11.99	70.9	11.18	

**Note**

1. TC: Total Capacity(kW), PI : Power Input(kW, Comp. + Outdoor fan motor)
2. Capacity tables show the average value of conditions which may occur.
3. The heating capacity table is based on the values expressed as Max. in the specification of the outdoor unit. (When measuring the Max. heating capacity, the setting status of the indoor unit is the same as that for measuring the heating capacity of the indoor unit.)

# 7. Capacity Tables

## ◆ ARUM700LTE5

Heating Capacity (70HP)

Combination (%)	Outdoor air temp.		Indoor air temp. °C DB											
			16		18		20		21		22		24	
	°C DB	°C WB	TC	PI	TC	PI	TC	PI	TC	PI	TC	PI	TC	PI
130	-24.8	-25	134.2	75.6	134.2	76.12	133.4	76.55	133.4	77.20	133.4	77.84	130.9	78.84
	-21.8	-22	164.8	76.60	164.8	77.10	163.7	77.53	163.7	78.20	163.7	78.84	160.5	79.82
	-19.8	-20	174.5	77.27	174.5	77.77	173.3	78.20	173.3	78.86	173.3	79.49	170.1	80.49
	-18.8	-19	178.5	77.60	178.5	78.10	177.3	78.53	177.3	79.20	177.3	79.82	173.9	80.82
	-16.7	-17	186.6	78.29	186.6	78.79	185.4	79.22	185.4	79.89	185.4	80.53	181.9	81.51
	-13.7	-15	198.2	79.29	198.2	79.79	197.0	80.22	197.0	80.89	197.0	81.51	193.2	78.56
	-11.8	-13	204.7	79.94	204.7	80.42	203.5	80.85	203.5	81.51	203.5	79.54	200.5	76.68
	-9.8	-11	211.5	80.58	211.5	81.08	210.2	81.51	210.2	79.43	210.2	77.46	208.0	74.71
	-9.5	-10	212.7	80.70	212.7	81.18	211.4	81.19	211.4	79.11	211.2	77.14	209.2	74.40
	-8.5	-9.1	216.8	81.01	216.8	81.51	215.5	80.13	215.5	78.04	214.7	76.10	212.9	73.42
	-7.0	-7.6	222.9	81.51	222.9	79.98	221.5	78.53	221.5	76.48	221.5	74.52	218.5	71.94
	-5.0	-5.6	231.1	79.54	231.1	77.90	229.6	76.40	229.6	74.37	229.6	72.43	226.1	69.97
	-3.0	-3.7	239.3	77.58	239.3	75.84	237.8	74.26	237.8	72.26	237.8	70.35	233.6	67.98
	0.0	-0.7	251.6	74.60	251.6	72.75	249.9	71.07	249.9	69.11	249.9	67.22	245.1	65.03
	3.0	2.2	263.9	71.65	263.9	69.63	262.2	67.86	262.2	65.96	262.2	64.08	246.0	62.08
	5.0	4.1	267.1	63.29	266.6	61.30	264.8	59.57	264.8	57.78	259.0	56.04	241.1	54.24
	7.0	6.0	268.1	60.23	267.5	58.29	266.0	56.61	261.6	54.96	252.3	53.32	234.9	51.73
	9.0	7.9	259.6	56.24	259.0	54.42	258.3	52.83	251.9	51.30	243.1	49.77	226.4	48.28
	11.0	9.8	245.5	52.91	244.9	51.20	244.3	49.71	238.2	48.26	229.9	46.84	214.1	45.42
	13.0	11.8	230.5	48.84	230.2	47.27	229.4	45.89	223.7	44.56	215.9	43.23	200.9	41.93
15.0	13.7	218.2	45.48	217.6	44.01	217.0	42.73	211.7	41.49	204.4	40.25	190.1	39.04	
120	-24.8	-25	133.3	76.12	133.3	76.55	132.5	77.20	132.5	77.84	132.5	78.84	130.0	79.53
	-21.8	-22	163.6	77.10	163.6	77.53	162.5	78.20	162.5	78.84	162.5	79.82	159.5	80.53
	-19.8	-20	173.3	77.77	173.3	78.20	172.1	78.86	172.1	79.49	172.1	80.49	168.9	81.18
	-18.8	-19	177.1	78.10	177.1	78.53	175.9	79.20	175.9	79.82	175.9	80.82	172.7	81.51
	-16.7	-17	185.2	78.79	185.2	79.22	184.0	79.89	184.0	80.53	184.0	81.51	180.5	79.61
	-13.7	-15	196.8	79.79	196.8	80.22	195.6	80.89	195.6	81.51	195.6	78.68	191.8	76.89
	-11.8	-13	203.2	80.42	203.2	80.85	202.0	81.51	202.0	79.52	202.0	76.89	199.0	75.17
	-9.8	-11	210.0	81.08	210.0	81.51	208.8	79.32	208.8	77.41	208.8	75.01	206.6	73.35
	-9.5	-10	211.2	81.18	211.2	81.17	210.0	79.00	210.0	77.09	210.0	74.72	207.7	73.07
	-8.5	-9.1	215.3	81.51	215.3	80.01	213.8	77.90	213.8	76.05	213.8	73.79	211.3	72.17
	-7.0	-7.6	221.4	79.81	221.4	78.28	220.0	76.25	220.0	74.46	220.0	72.37	217.0	70.81
	-5.0	-5.6	229.6	77.52	229.6	75.96	228.1	74.05	228.1	72.35	228.1	70.47	224.5	68.99
	-3.0	-3.7	237.6	75.24	237.6	73.67	236.1	71.86	236.1	70.26	236.1	68.59	231.1	67.17
	0.0	-0.7	249.8	71.82	249.8	70.20	248.1	68.56	248.1	67.09	248.1	65.75	231.1	64.45
	3.0	2.2	261.9	68.41	261.9	66.73	260.4	65.26	256.6	63.93	248.7	62.92	231.1	61.73
	5.0	4.1	265.4	60.00	264.6	58.41	260.2	57.10	251.6	55.89	243.7	55.08	226.4	54.01
	7.0	6.0	266.5	56.82	264.0	55.28	253.7	54.19	245.2	53.15	237.5	52.65	220.6	51.70
	9.0	7.9	257.8	52.88	254.3	51.44	244.3	50.43	236.1	49.47	228.8	48.99	212.6	48.12
	11.0	9.8	243.7	49.59	240.5	48.23	231.1	47.28	223.2	46.38	216.4	45.94	200.9	45.13
	13.0	11.8	229.0	45.60	225.8	44.36	217.0	43.49	209.7	42.65	203.2	42.25	188.8	41.50
15.0	13.7	216.7	42.27	213.8	41.12	205.3	40.31	198.5	39.55	192.3	39.18	178.6	38.48	
110	-24.8	-25	132.7	76.55	132.7	77.20	131.8	77.84	131.8	78.84	131.8	79.53	129.2	79.87
	-21.8	-22	162.7	77.53	162.7	78.20	161.6	78.84	161.6	79.82	161.6	80.53	158.6	80.85
	-19.8	-20	172.4	78.20	172.4	78.86	171.3	79.49	171.3	80.49	171.3	81.18	168.0	81.51
	-18.8	-19	176.2	78.53	176.2	79.20	175.0	79.82	175.0	80.82	175.0	81.51	171.8	80.50
	-16.7	-17	184.3	79.22	184.3	79.89	183.1	80.53	183.1	81.51	183.1	79.45	179.6	78.36
	-13.7	-15	195.6	80.22	195.6	80.89	194.5	81.51	194.5	78.39	194.5	76.48	194.5	75.32
	-11.8	-13	202.1	80.85	202.1	81.51	200.9	79.31	200.9	76.40	200.9	74.60	200.9	73.39
	-9.8	-11	208.8	81.51	208.8	79.03	207.6	77.00	207.6	74.31	207.6	72.63	206.5	71.36
	-9.5	-10	210.0	81.11	210.0	78.65	208.8	76.63	208.8	73.99	208.8	72.34	207.9	71.07
	-8.5	-9.1	214.1	79.78	214.1	77.41	212.9	75.47	212.9	72.95	212.9	71.34	207.9	70.04
	-7.0	-7.6	220.2	77.76	220.2	75.55	218.8	73.73	218.8	71.39	218.8	69.86	207.9	68.53
	-5.0	-5.6	228.2	75.09	228.2	73.04	226.7	71.42	226.7	69.31	222.6	67.89	207.9	66.48
	-3.0	-3.7	236.4	72.40	236.4	70.56	234.9	69.08	230.5	67.20	222.6	65.90	207.9	64.45
	0.0	-0.7	248.4	68.38	248.4	66.82	238.2	65.60	230.5	64.07	222.6	62.95	207.9	61.41
	3.0	2.2	260.5	64.36	253.9	63.09	238.2	62.11	230.5	60.95	222.6	59.97	207.9	58.35
	5.0	4.1	263.3	55.95	248.7	54.88	233.5	54.07	225.8	53.14	218.2	52.33	203.8	50.80
	7.0	6.0	256.6	52.51	242.5	51.73	227.6	51.15	220.2	50.51	212.6	49.88	198.6	48.32
	9.0	7.9	247.2	48.61	233.5	47.88	219.1	47.34	212.0	46.76	205.0	46.17	191.2	44.73
	11.0	9.8	233.7	45.31	220.8	44.62	207.3	44.13	200.6	43.60	193.8	43.03	180.9	41.70
	13.0	11.8	219.4	41.40	207.4	40.77	194.7	40.31	188.3	39.82	181.9	39.32	169.8	38.11
15.0	13.7	207.6	38.08	196.2	37.50	184.2	37.07	178.1	36.63	172.1	36.17	160.7	35.04	

# 7. Capacity Tables

Heating Capacity (70HP)

Combination (%)	Outdoor air temp.		Indoor air temp. °C DB											
			16		18		20		21		22		24	
	°C DB	°C WB	TC	PI	TC	PI	TC	PI	TC	PI	TC	PI	TC	PI
100	-24.8	-25	132.1	84.58	132.1	84.18	131.2	78.23	131.2	83.18	131.2	82.75	128.6	82.55
	-21.8	-22	161.9	83.97	161.9	83.57	161.0	80.70	161.0	82.56	161.0	83.25	157.8	81.93
	-19.8	-20	171.6	83.57	171.6	83.15	170.6	82.23	170.6	82.16	170.6	82.10	167.4	81.51
	-18.8	-19	175.3	83.37	174.4	82.95	174.4	82.56	174.4	81.94	174.4	81.51	170.9	80.27
	-16.7	-17	182.3	82.94	182.3	82.52	182.3	83.25	181.3	81.51	181.3	78.94	177.8	77.63
	-13.7	-15	194.7	82.32	194.7	81.90	193.6	81.51	193.6	77.78	193.6	75.24	190.0	73.85
	-11.8	-13	201.1	81.93	200.0	81.51	200.0	79.03	200.0	75.41	200.0	72.90	190.0	71.48
	-9.8	-11	207.7	81.51	207.7	78.73	206.7	76.40	206.7	72.92	203.9	70.44	190.0	68.96
	-9.5	-10	208.8	81.08	208.8	78.31	207.9	76.01	207.9	72.55	203.9	70.06	190.0	68.58
	-8.5	-9.1	212.9	79.63	212.9	76.92	212.0	74.69	210.9	71.31	203.9	68.84	190.0	67.32
	-7.0	-7.6	222.6	77.46	221.7	74.83	217.9	72.72	210.9	69.45	203.9	66.99	190.0	65.44
	-5.0	-5.6	232.3	74.54	230.0	72.05	217.9	70.11	210.9	66.94	203.9	64.54	190.0	62.92
	-3.0	-3.7	239.0	71.65	231.9	69.25	217.9	67.49	210.9	64.45	203.9	62.08	190.0	60.41
	0.0	-0.7	245.8	67.28	231.9	65.08	217.9	63.55	210.9	60.72	203.9	58.38	190.0	56.65
	3.0	2.2	245.8	62.92	231.9	60.90	217.9	59.62	210.9	56.99	203.9	54.68	190.0	52.88
	5.0	4.1	240.8	54.48	227.3	52.68	213.5	51.58	206.7	49.27	200.0	47.16	186.2	45.49
	7.0	6.0	234.7	50.83	221.4	49.24	208.2	48.38	201.5	46.29	194.7	44.29	181.5	42.59
	9.0	7.9	226.1	46.84	213.2	45.37	200.6	44.58	194.1	42.65	187.7	40.80	174.8	39.24
	11.0	9.8	213.8	43.43	201.7	42.05	189.5	41.32	183.6	39.53	177.4	37.82	165.4	36.38
	13.0	11.8	200.9	39.41	189.4	38.17	178.0	37.51	172.4	35.89	166.6	34.35	155.2	33.02
15.0	13.7	190.0	36.00	179.2	34.87	168.4	34.26	163.1	32.76	157.7	31.35	146.9	30.16	
90	-24.8	-25	131.5	75.26	131.5	76.24	130.7	76.95	130.7	77.27	130.7	77.93	128.3	78.94
	-21.8	-22	161.3	76.24	161.3	77.24	160.4	77.93	160.4	78.27	160.4	78.94	157.2	75.60
	-19.8	-20	170.9	76.91	170.9	77.91	169.8	78.60	169.8	78.94	169.8	76.65	166.6	73.37
	-18.8	-19	175.3	77.24	174.4	78.24	173.6	78.94	173.6	77.77	173.6	75.51	170.3	72.26
	-16.7	-17	182.3	77.93	182.3	78.94	181.6	76.52	181.6	75.31	181.6	73.13	173.6	69.91
	-13.7	-15	194.7	78.94	194.7	75.34	192.9	73.07	192.9	71.80	187.1	69.71	173.6	66.58
	-11.8	-13	201.1	76.47	200.0	73.07	199.2	70.87	193.2	69.56	187.1	67.56	173.6	64.46
	-9.8	-11	207.7	73.91	207.7	70.69	199.4	68.57	193.2	67.22	187.1	65.27	173.6	62.23
	-9.5	-10	208.8	73.51	208.8	70.32	199.4	68.23	193.2	66.87	187.1	64.92	173.6	61.88
	-8.5	-9.1	212.9	72.22	211.5	69.12	199.4	67.07	193.2	65.70	187.1	63.79	173.6	60.78
	-7.0	-7.6	222.6	70.28	211.8	67.33	199.4	65.35	193.2	63.94	187.1	62.08	173.6	59.10
	-5.0	-5.6	225.0	67.70	211.8	64.94	199.4	63.05	193.2	61.61	187.1	59.81	173.6	56.89
	-3.0	-3.7	225.0	65.11	211.8	62.56	199.4	60.74	193.2	59.26	187.1	57.52	173.6	54.65
	0.0	-0.7	225.0	61.25	211.8	58.96	199.4	57.28	193.2	55.75	187.1	54.10	173.6	51.32
	3.0	2.2	225.0	57.36	211.8	55.37	199.4	53.83	193.2	52.24	187.1	50.70	173.6	47.96
	5.0	4.1	220.5	49.60	207.6	47.89	195.3	46.53	189.4	45.06	183.3	43.70	170.1	41.24
	7.0	6.0	215.0	46.46	202.3	45.02	190.4	43.81	184.5	42.33	178.6	41.06	165.9	38.72
	9.0	7.9	207.1	42.80	194.8	41.49	183.3	40.37	177.7	38.98	172.1	37.82	159.8	35.68
	11.0	9.8	195.9	39.29	184.2	38.08	173.4	37.04	168.0	35.79	162.7	34.73	151.1	32.74
	13.0	11.8	183.9	34.93	173.0	33.86	162.8	32.96	157.8	31.83	152.8	30.88	141.9	29.12
15.0	13.7	173.9	31.58	163.7	30.60	154.2	29.78	149.3	28.77	144.6	27.91	134.3	26.32	
80	-24.8	-25	131.0	66.31	131.0	67.32	130.1	68.01	130.1	68.34	130.1	69.99	127.7	67.06
	-21.8	-22	159.6	67.32	159.6	68.30	159.6	68.99	159.6	69.99	159.6	67.06	155.1	64.22
	-19.8	-20	169.2	67.96	169.2	68.96	169.2	69.99	169.2	67.93	166.8	65.09	155.1	62.33
	-18.8	-19	172.9	68.30	172.9	69.99	172.9	68.94	172.8	66.88	166.8	64.10	155.1	61.40
	-16.7	-17	178.3	69.99	178.3	67.81	178.3	66.74	173.0	64.71	166.8	62.06	155.1	59.43
	-13.7	-15	186.5	66.76	182.7	64.68	178.3	63.60	173.0	61.60	166.8	59.11	155.1	56.59
	-11.8	-13	191.0	64.71	185.4	62.71	178.3	61.60	173.0	59.63	166.8	57.25	155.1	54.79
	-9.8	-11	196.1	62.56	188.1	60.64	178.3	59.51	173.0	57.57	166.8	55.28	155.1	52.91
	-9.5	-10	197.5	62.24	189.2	60.32	178.3	59.19	173.0	57.25	166.8	54.99	155.1	52.64
	-8.5	-9.1	199.5	61.16	190.0	59.28	178.3	58.15	173.0	56.21	166.8	54.03	155.1	51.69
	-7.0	-7.6	201.5	59.54	190.0	57.71	178.3	56.58	173.0	54.67	166.8	52.55	155.1	50.27
	-5.0	-5.6	201.5	57.39	190.0	55.65	178.3	54.47	173.0	52.58	166.8	50.58	155.1	48.38
	-3.0	-3.7	201.5	55.24	190.0	53.56	178.3	52.37	173.0	50.52	166.8	48.64	155.1	46.50
	0.0	-0.7	201.5	51.99	190.0	50.45	178.3	49.24	173.0	47.41	166.8	45.68	155.1	43.68
	3.0	2.2	201.5	48.77	190.0	47.32	178.3	46.08	173.0	44.29	166.8	42.75	155.1	40.84
	5.0	4.1	197.4	42.14	186.2	40.86	174.8	39.73	169.5	38.12	163.4	36.79	152.2	35.14
	7.0	6.0	192.4	39.56	181.5	38.42	170.4	37.28	165.1	35.74	159.2	34.55	148.1	32.99
	9.0	7.9	185.4	35.49	174.8	34.50	164.0	33.64	159.2	32.33	153.4	31.18	142.8	29.70
	11.0	9.8	175.4	31.56	165.2	30.68	155.1	29.91	150.5	28.75	145.1	27.73	134.9	26.41
	13.0	11.8	164.6	27.44	155.2	26.66	145.7	26.00	141.4	24.99	136.3	24.09	126.7	22.96
15.0	13.7	155.7	24.78	146.9	24.07	137.8	23.48	133.7	22.56	129.0	21.77	119.9	20.73	

## 7. Capacity Tables

Heating Capacity (70HP)

Combination (%)	Outdoor air temp.		Indoor air temp. °C DB											
			16		18		20		21		22		24	
	°C DB	°C WB	TC	PI	TC	PI	TC	PI	TC	PI	TC	PI	TC	PI
70	-24.8	-25	131.0	66.36	131.0	66.69	130.1	67.36	130.1	68.36	130.1	65.15	127.7	62.13
	-21.8	-22	152.8	67.36	152.8	67.70	151.9	68.36	146.6	65.15	142.3	62.13	132.8	59.23
	-19.8	-20	167.3	68.03	161.3	68.36	151.9	66.10	146.6	63.00	142.3	60.13	132.8	57.29
	-18.8	-19	171.0	68.36	161.3	67.20	151.9	64.97	146.6	61.93	142.3	59.12	132.8	56.31
	-16.7	-17	171.0	65.93	161.3	64.74	151.9	62.62	146.6	59.67	142.3	57.03	132.8	54.27
	-13.7	-15	171.0	62.50	161.3	61.26	151.9	59.23	146.6	56.47	142.3	54.01	132.8	51.35
	-11.8	-13	171.0	60.30	161.3	59.05	151.9	57.09	146.6	54.42	142.3	52.10	132.8	49.52
	-9.8	-11	171.0	58.01	161.3	56.71	151.9	54.85	146.6	52.28	142.3	50.10	132.8	47.58
	-9.5	-10	171.0	57.66	161.3	56.36	151.9	54.50	146.6	51.96	142.3	49.81	132.8	47.29
	-8.5	-9.1	171.0	56.53	161.3	55.20	151.9	53.37	146.6	50.88	142.3	48.79	132.8	46.31
	-7.0	-7.6	171.0	54.79	161.3	53.46	151.9	51.69	146.6	49.29	142.3	47.29	132.8	44.85
	-5.0	-5.6	171.0	52.50	161.3	51.13	151.9	49.43	146.6	47.14	142.3	45.29	132.8	42.91
	-3.0	-3.7	171.0	50.20	161.3	48.79	151.9	47.17	146.6	45.00	142.3	43.28	132.8	40.97
	0.0	-0.7	171.0	46.75	161.3	45.31	151.9	43.80	146.6	41.78	142.3	40.27	132.8	38.07
	3.0	2.2	171.0	43.30	161.3	41.82	151.9	40.41	146.6	38.58	142.3	37.26	132.8	35.14
	5.0	4.1	171.0	37.89	158.1	35.69	148.7	34.50	143.7	32.89	139.3	31.84	130.2	29.99
	7.0	6.0	171.0	36.17	154.0	33.08	144.9	31.95	139.9	30.51	135.8	29.58	126.7	27.82
	9.0	7.9	164.8	31.34	148.4	28.63	139.6	27.67	134.9	26.43	130.8	25.62	122.0	24.09
	11.0	9.8	156.0	27.81	140.4	25.42	132.0	24.58	127.6	23.45	123.8	22.75	115.5	21.39
	13.0	11.8	146.4	24.40	131.9	22.32	124.0	21.57	119.7	20.59	116.2	19.96	108.5	18.77
15.0	13.7	138.5	21.77	124.7	19.90	117.3	19.23	113.2	18.36	110.0	17.81	102.6	16.74	
60	-24.8	-25	130.2	65.62	130.2	66.29	129.4	67.29	125.8	63.83	121.4	60.60	113.7	57.54
	-21.8	-22	140.0	66.62	138.7	67.29	130.2	63.83	125.8	60.60	121.4	57.54	113.7	54.60
	-19.8	-20	146.6	67.29	138.7	64.85	130.2	61.53	125.8	58.44	121.4	55.51	113.7	52.63
	-18.8	-19	146.6	66.07	138.7	63.63	130.2	60.37	125.8	57.34	121.4	54.49	113.7	51.64
	-16.7	-17	146.6	63.48	138.7	61.06	130.2	57.95	125.8	55.07	121.4	52.36	113.7	49.58
	-13.7	-15	146.6	59.78	138.7	57.42	130.2	54.51	125.8	51.84	121.4	49.31	113.7	46.64
	-11.8	-13	146.6	57.45	138.7	55.09	130.2	52.31	125.8	49.78	121.4	47.39	113.7	44.77
	-9.8	-11	146.6	55.00	138.7	52.65	130.2	50.01	125.8	47.62	121.4	45.35	113.7	42.80
	-9.5	-10	146.6	54.62	138.7	52.30	130.2	49.66	125.8	47.30	121.4	45.04	113.7	42.51
	-8.5	-9.1	146.6	53.40	138.7	51.07	130.2	48.52	125.8	46.22	121.4	44.02	113.7	41.52
	-7.0	-7.6	146.6	51.56	138.7	49.24	130.2	46.80	125.8	44.60	121.4	42.50	113.7	40.04
	-5.0	-5.6	146.6	49.09	138.7	46.80	130.2	44.48	125.8	42.44	121.4	40.47	113.7	38.09
	-3.0	-3.7	146.6	46.64	138.7	44.35	130.2	42.18	125.8	40.29	121.4	38.43	113.7	36.11
	0.0	-0.7	146.6	42.94	138.7	40.71	130.2	38.74	125.8	37.03	121.4	35.38	113.7	33.17
	3.0	2.2	146.6	39.25	138.7	37.04	130.2	35.28	125.8	33.80	121.4	32.35	113.7	30.21
	5.0	4.1	143.7	33.30	136.1	31.31	127.6	29.80	123.2	28.59	119.1	27.39	111.4	25.54
	7.0	6.0	139.9	30.56	132.6	28.63	124.3	27.29	120.2	26.23	116.1	25.16	108.5	23.39
	9.0	7.9	134.9	26.19	127.6	24.52	119.7	23.39	115.8	22.47	111.7	21.57	104.7	20.04
	11.0	9.8	127.6	23.24	120.8	21.77	113.2	20.76	109.4	19.95	105.6	19.14	98.8	17.78
	13.0	11.8	119.7	20.38	113.5	19.09	106.4	18.19	102.7	17.49	99.2	16.77	92.9	15.61
15.0	13.7	113.2	18.36	107.3	17.18	100.6	16.23	97.3	15.61	93.9	14.97	87.9	14.05	
50	-24.8	-25	122.3	57.11	115.3	58.11	108.5	55.07	105.0	52.23	101.5	49.54	94.5	47.04
	-21.8	-22	122.3	58.11	115.3	55.07	108.5	52.23	105.0	49.54	101.5	47.04	94.5	44.63
	-19.8	-20	122.3	56.00	115.3	53.04	108.5	50.34	105.0	47.74	101.5	45.36	94.5	43.02
	-18.8	-19	122.3	54.93	115.3	52.03	108.5	49.39	105.0	46.86	101.5	44.53	94.5	42.21
	-16.7	-17	122.3	52.72	115.3	49.91	108.5	47.42	105.0	44.98	101.5	42.78	94.5	40.52
	-13.7	-15	122.3	49.56	115.3	46.87	108.5	44.57	105.0	42.29	101.5	40.29	94.5	38.11
	-11.8	-13	122.3	47.56	115.3	44.95	108.5	42.78	105.0	40.58	101.5	38.69	94.5	36.58
	-9.8	-11	122.3	45.44	115.3	42.93	108.5	40.87	105.0	38.78	101.5	37.02	94.5	34.96
	-9.5	-10	122.3	45.12	115.3	42.63	108.5	40.60	105.0	38.52	101.5	36.78	94.5	34.73
	-8.5	-9.1	122.3	44.06	115.3	41.62	108.5	39.65	105.0	37.62	101.5	35.94	94.5	33.92
	-7.0	-7.6	122.3	42.49	115.3	40.11	108.5	38.23	105.0	36.29	101.5	34.69	94.5	32.72
	-5.0	-5.6	122.3	40.37	115.3	38.08	108.5	36.34	105.0	34.49	101.5	33.02	94.5	31.11
	-3.0	-3.7	122.3	38.26	115.3	36.05	108.5	34.44	105.0	32.70	101.5	31.34	94.5	29.51
	0.0	-0.7	122.3	35.09	115.3	33.01	108.5	31.60	105.0	30.00	101.5	28.84	94.5	27.08
	3.0	2.2	122.3	31.93	115.3	29.99	108.5	28.78	105.0	27.31	101.5	26.35	94.5	24.67
	5.0	4.1	119.9	26.98	113.2	25.28	106.2	24.30	102.9	23.08	99.4	22.30	92.7	20.85
	7.0	6.0	116.8	24.66	110.2	23.08	103.5	22.24	100.3	21.11	97.0	20.47	90.3	19.09
	9.0	7.9	112.6	21.34	106.2	19.98	99.7	19.26	96.5	18.30	93.3	17.73	87.1	16.54
	11.0	9.8	107.0	19.17	100.9	17.95	94.8	17.29	91.2	16.42	88.3	15.91	82.4	14.84
	13.0	11.8	100.0	16.63	94.2	15.58	88.6	15.00	85.7	14.34	83.0	13.82	77.2	12.95
15.0	13.7	94.5	15.01	89.2	14.05	83.9	13.53	81.2	12.87	78.6	12.46	73.0	11.63	

## Note

1. TC: Total Capacity(kW), PI: Power Input(kW, Comp. + Outdoor fan motor)
2. Capacity tables show the average value of conditions which may occur.
3. The heating capacity table is based on the values expressed as Max. in the specification of the outdoor unit. (When measuring the Max. heating capacity, the setting status of the indoor unit is the same as that for measuring the heating capacity of the indoor unit.)

# 7. Capacity Tables

## ◆ ARUM720LTE5

Heating Capacity (72HP)

Combination (%)	Outdoor air temp.		Indoor air temp. °C DB											
			16		18		20		21		22		24	
	°C DB	°C WB	TC	PI	TC	PI	TC	PI	TC	PI	TC	PI	TC	PI
130	-24.8	-25	136.2	77.2	136.2	77.79	135.3	78.33	135.3	79.14	135.3	79.95	132.9	81.21
	-21.8	-22	168.0	78.39	168.0	79.02	166.8	79.56	166.8	80.40	166.8	81.21	163.5	82.44
	-19.8	-20	178.2	79.23	178.2	79.86	177.0	80.40	177.0	81.24	177.0	82.02	173.7	83.28
	-18.8	-19	182.4	79.65	182.4	80.28	181.2	80.82	181.2	81.66	181.2	82.44	177.6	83.70
	-16.7	-17	190.8	80.52	190.8	81.15	189.6	81.69	189.6	82.53	189.6	83.34	186.0	84.57
	-13.7	-15	202.8	81.78	202.8	82.41	201.6	82.95	201.6	83.79	201.6	84.57	197.7	81.51
	-11.8	-13	209.4	82.59	209.4	83.19	208.2	83.73	208.2	84.57	208.2	85.23	205.2	79.56
	-9.8	-11	216.3	83.40	216.3	84.03	215.1	84.57	215.1	85.23	215.1	85.94	213.0	77.52
	-9.5	-10	217.5	83.55	217.5	84.15	216.3	84.74	216.3	85.40	216.3	86.06	214.2	77.19
	-8.5	-9.1	221.7	83.94	221.7	84.57	220.5	85.13	220.5	85.79	219.6	86.34	218.1	76.17
	-7.0	-7.6	228.0	84.57	228.0	85.23	226.5	85.89	226.5	86.55	226.5	87.21	223.8	74.64
	-5.0	-5.6	236.4	85.23	236.4	85.89	234.9	86.55	234.9	87.21	234.9	87.87	231.6	72.60
	-3.0	-3.7	244.8	85.89	244.8	86.55	243.3	87.21	243.3	87.87	243.3	88.53	239.4	70.53
	0.0	-0.7	257.4	87.40	257.4	88.06	255.6	88.72	255.6	89.38	255.6	90.04	251.4	67.47
	3.0	2.2	270.0	88.72	270.0	89.38	268.2	90.04	268.2	90.70	268.2	91.36	257.2	64.41
	5.0	4.1	273.3	89.38	273.3	90.04	271.5	90.70	271.5	91.36	271.5	92.02	264.6	56.28
	7.0	6.0	274.2	89.67	274.2	90.33	272.1	90.99	272.1	91.65	272.1	92.31	265.5	53.67
	9.0	7.9	265.5	88.72	265.5	89.38	264.3	90.04	264.3	90.70	264.3	91.36	261.6	50.10
11.0	9.8	251.1	86.55	251.1	87.21	249.9	87.87	249.9	88.53	249.9	89.19	248.0	47.13	
13.0	11.8	235.8	84.57	235.8	85.23	234.6	85.89	234.6	86.55	234.6	87.21	232.8	43.50	
15.0	13.7	223.2	82.59	223.2	83.25	222.0	83.91	222.0	84.57	222.0	85.23	220.2	40.50	
120	-24.8	-25	135.3	77.79	135.3	78.33	134.4	79.14	134.4	79.95	134.4	81.21	132.0	82.08
	-21.8	-22	166.8	79.02	166.8	79.56	165.6	80.40	165.6	81.21	165.6	82.44	162.6	83.34
	-19.8	-20	177.0	79.86	177.0	80.40	175.8	81.24	175.8	82.02	175.8	83.28	172.5	84.15
	-18.8	-19	180.9	80.28	180.9	80.82	179.7	81.66	179.7	82.44	179.7	83.70	176.4	84.57
	-16.7	-17	189.3	81.15	189.3	81.69	188.1	82.53	188.1	83.34	188.1	84.57	184.5	82.59
	-13.7	-15	201.3	82.41	201.3	82.95	200.1	83.79	200.1	84.57	200.1	85.40	196.2	79.77
	-11.8	-13	207.9	83.19	207.9	83.73	206.7	84.57	206.7	85.40	206.7	86.22	203.7	78.00
	-9.8	-11	214.8	84.03	214.8	84.57	213.6	85.23	213.6	85.94	213.6	86.76	211.5	76.11
	-9.5	-10	216.0	84.15	216.0	84.74	214.8	85.40	214.8	86.06	214.8	86.72	212.7	75.81
	-8.5	-9.1	220.2	84.57	220.2	85.23	218.7	85.89	218.7	86.55	218.7	87.21	216.3	74.88
	-7.0	-7.6	226.5	85.23	226.5	85.89	225.0	86.55	225.0	87.21	225.0	87.87	222.3	73.47
	-5.0	-5.6	234.9	85.89	234.9	86.55	233.4	87.21	233.4	87.87	233.4	88.53	230.1	71.58
	-3.0	-3.7	243.0	86.55	243.0	87.21	241.5	87.87	241.5	88.53	241.5	89.19	237.6	69.69
	0.0	-0.7	255.6	88.06	255.6	88.72	253.8	89.38	253.8	90.04	253.8	90.70	250.4	66.87
	3.0	2.2	267.9	89.38	267.9	90.04	266.4	90.70	266.4	91.36	266.4	92.02	263.4	64.05
	5.0	4.1	271.5	90.04	271.5	90.70	270.0	91.36	270.0	92.02	270.0	92.74	267.6	56.04
	7.0	6.0	272.7	90.33	272.7	91.00	271.5	91.65	271.5	92.31	271.5	93.03	268.7	53.64
	9.0	7.9	263.7	89.38	263.7	90.04	262.5	90.70	262.5	91.36	262.5	92.02	260.4	49.92
11.0	9.8	249.3	87.21	249.3	87.87	248.1	88.53	248.1	89.19	248.1	89.85	246.0	46.83	
13.0	11.8	234.3	85.23	234.3	85.89	233.1	86.55	233.1	87.21	233.1	87.87	231.0	43.05	
15.0	13.7	221.7	83.25	221.7	83.91	220.5	84.57	220.5	85.23	220.5	85.89	218.4	39.93	
110	-24.8	-25	134.7	78.33	134.7	79.14	133.8	79.95	133.8	81.21	133.8	82.08	131.1	82.50
	-21.8	-22	165.9	79.56	165.9	80.40	164.7	81.21	164.7	82.44	164.7	83.34	161.7	83.73
	-19.8	-20	176.1	80.40	176.1	81.24	174.9	82.02	174.9	83.28	174.9	84.15	171.6	84.57
	-18.8	-19	180.0	80.82	180.0	81.66	178.8	82.44	178.8	83.70	178.8	84.57	175.5	83.52
	-16.7	-17	188.4	81.69	188.4	82.53	187.2	83.34	187.2	84.57	187.2	85.40	183.6	81.30
	-13.7	-15	200.1	82.95	200.1	83.79	198.9	84.57	198.9	85.40	198.9	86.22	195.9	78.15
	-11.8	-13	206.7	83.73	206.7	84.57	205.5	85.40	205.5	86.22	205.5	87.04	202.5	76.14
	-9.8	-11	213.6	84.57	213.6	85.40	212.4	86.22	212.4	87.04	212.4	87.87	209.4	74.04
	-9.5	-10	214.8	84.74	214.8	85.40	213.6	86.06	213.6	86.72	213.6	87.44	210.6	73.74
	-8.5	-9.1	219.0	85.23	219.0	85.89	217.8	86.55	217.8	87.21	217.8	87.87	214.8	72.66
	-7.0	-7.6	225.3	85.89	225.3	86.55	223.8	87.21	223.8	87.87	223.8	88.53	220.8	71.10
	-5.0	-5.6	233.4	86.55	233.4	87.21	231.9	87.87	231.9	88.53	231.9	89.19	228.8	68.97
	-3.0	-3.7	241.8	87.21	241.8	87.87	240.3	88.53	240.3	89.19	240.3	90.04	237.6	66.87
	0.0	-0.7	254.1	88.72	254.1	89.38	252.6	90.04	252.6	90.70	252.6	91.36	249.4	63.72
	3.0	2.2	266.4	90.04	266.4	90.70	264.9	91.36	264.9	92.02	264.9	92.74	261.8	60.54
	5.0	4.1	269.4	90.70	269.4	91.36	267.9	92.02	267.9	92.74	267.9	93.46	264.8	52.71
	7.0	6.0	262.5	90.04	262.5	90.70	261.3	91.36	261.3	92.02	261.3	92.74	258.2	50.13
	9.0	7.9	252.9	89.38	252.9	90.04	251.7	90.70	251.7	91.36	251.7	92.02	248.6	46.41
11.0	9.8	239.1	87.21	239.1	87.87	237.9	88.53	237.9	89.19	237.9	89.85	234.8	43.26	
13.0	11.8	224.4	85.23	224.4	85.89	223.2	86.55	223.2	87.21	223.2	87.87	220.1	39.54	
15.0	13.7	212.4	83.25	212.4	83.91	211.2	84.57	211.2	85.23	211.2	85.89	208.1	36.36	

# 7. Capacity Tables

Heating Capacity (72HP)

Combination (%)	Outdoor air temp.		Indoor air temp. °C DB											
			16		18		20		21		22		24	
	°C DB	°C WB	TC	PI	TC	PI	TC	PI	TC	PI	TC	PI	TC	PI
100	-24.8	-25	134.1	86.94	134.1	86.64	133.2	80.82	133.2	85.86	133.2	85.53	130.5	85.38
	-21.8	-22	165.0	86.46	165.0	86.16	164.1	83.37	164.1	85.38	164.1	86.25	160.8	84.90
	-19.8	-20	175.2	86.16	175.2	85.83	174.3	84.96	174.3	85.08	174.3	85.14	171.0	84.57
	-18.8	-19	179.1	86.01	178.2	85.68	178.2	85.38	178.2	84.90	178.2	84.57	174.6	83.28
	-16.7	-17	186.3	85.68	186.3	85.35	186.3	86.25	185.4	84.57	185.4	81.90	181.8	80.55
	-13.7	-15	199.2	85.20	199.2	84.87	198.0	84.57	198.0	80.70	198.0	78.06	194.4	76.62
	-11.8	-13	205.8	84.90	204.6	84.57	204.6	81.99	204.6	78.24	204.6	75.63	194.4	74.16
	-9.8	-11	212.4	84.57	212.4	81.69	211.5	79.26	211.5	75.66	208.5	73.08	194.4	71.55
	-9.5	-10	213.6	84.12	213.6	81.24	212.7	78.87	212.7	75.27	208.5	72.69	194.4	71.16
	-8.5	-9.1	217.8	82.62	217.8	79.80	216.9	77.49	215.7	73.98	208.5	71.43	194.4	69.84
	-7.0	-7.6	227.7	80.37	226.8	77.64	222.9	75.45	215.7	72.06	208.5	69.51	194.4	67.89
	-5.0	-5.6	237.6	77.34	235.2	74.76	222.9	72.75	215.7	69.45	208.5	66.96	194.4	65.28
	-3.0	-3.7	244.5	74.34	237.3	71.85	222.9	70.02	215.7	66.87	208.5	64.41	194.4	62.67
	0.0	-0.7	251.4	69.81	237.3	67.53	222.9	65.94	215.7	63.00	208.5	60.57	194.4	58.77
	3.0	2.2	251.4	65.28	237.3	63.18	222.9	61.86	215.7	59.13	208.5	56.73	194.4	54.87
	5.0	4.1	246.3	56.52	232.5	54.66	218.4	53.52	211.5	51.12	204.6	48.93	190.5	47.19
	7.0	6.0	240.0	52.74	226.5	51.09	213.0	50.19	206.1	48.03	199.2	45.96	185.7	44.19
	9.0	7.9	231.3	48.60	218.1	47.07	205.2	46.26	198.6	44.25	192.0	42.33	178.8	40.71
	11.0	9.8	218.7	45.06	206.4	43.62	193.8	42.87	187.8	41.01	181.5	39.24	169.2	37.74
	13.0	11.8	205.5	40.89	193.8	39.60	182.1	38.91	176.4	37.23	170.4	35.64	158.7	34.26
15.0	13.7	194.4	37.35	183.3	36.18	172.2	35.55	166.8	33.99	161.4	32.52	150.3	31.29	
90	-24.8	-25	133.5	77.16	133.5	78.39	132.6	79.29	132.6	79.68	132.6	80.52	130.2	81.78
	-21.8	-22	164.4	78.39	164.4	79.65	163.5	80.52	163.5	80.94	163.5	81.78	160.2	78.33
	-19.8	-20	174.6	79.23	174.6	80.49	173.4	81.36	173.4	81.78	173.4	82.91	170.1	76.02
	-18.8	-19	179.1	79.65	178.2	80.91	177.3	81.78	177.3	80.58	177.3	78.24	174.0	74.88
	-16.7	-17	186.3	80.52	186.3	81.78	185.7	79.29	185.7	78.03	185.7	75.78	177.6	72.45
	-13.7	-15	199.2	81.78	199.2	78.06	197.4	75.72	197.4	74.40	191.4	72.24	177.6	69.00
	-11.8	-13	205.8	79.23	204.6	75.72	203.7	73.44	197.7	72.09	191.4	70.02	177.6	66.81
	-9.8	-11	212.4	76.59	212.4	73.26	204.0	71.07	197.7	69.66	191.4	67.65	177.6	64.50
	-9.5	-10	213.6	76.17	213.6	72.87	204.0	70.71	197.7	69.30	191.4	67.29	177.6	64.14
	-8.5	-9.1	217.8	74.85	216.3	71.64	204.0	69.51	197.7	68.10	191.4	66.12	177.6	63.00
	-7.0	-7.6	227.7	72.84	216.6	69.78	204.0	67.74	197.7	66.27	191.4	64.35	177.6	61.26
	-5.0	-5.6	230.1	70.17	216.6	67.32	204.0	65.37	197.7	63.87	191.4	62.01	177.6	58.98
	-3.0	-3.7	230.1	67.50	216.6	64.86	204.0	62.97	197.7	61.44	191.4	59.64	177.6	56.67
	0.0	-0.7	230.1	63.51	216.6	61.14	204.0	59.40	197.7	57.81	191.4	56.10	177.6	53.22
	3.0	2.2	230.1	59.49	216.6	57.42	204.0	55.83	197.7	54.18	191.4	52.59	177.6	49.74
	5.0	4.1	225.6	51.45	212.4	49.68	199.8	48.27	193.8	46.74	187.5	45.33	174.0	42.78
	7.0	6.0	219.9	48.21	207.0	46.71	194.7	45.45	188.7	43.92	182.7	42.60	169.8	40.17
	9.0	7.9	211.8	44.40	199.2	43.05	187.5	41.88	181.8	40.44	176.1	39.24	163.5	37.02
	11.0	9.8	200.4	40.77	188.4	39.51	177.3	38.43	171.9	37.14	166.5	36.03	154.5	33.96
	13.0	11.8	188.1	36.24	177.0	35.13	166.5	34.20	161.4	33.03	156.3	32.04	145.2	30.21
15.0	13.7	177.9	32.76	167.4	31.74	157.8	30.90	152.7	29.85	147.9	28.95	137.4	27.30	
80	-24.8	-25	132.9	67.89	132.9	69.15	132.0	70.02	132.0	70.44	132.0	72.51	129.6	69.48
	-21.8	-22	162.6	69.15	162.6	70.38	162.6	71.25	162.6	72.51	162.6	69.48	158.7	66.54
	-19.8	-20	172.8	69.96	172.8	71.22	172.8	72.51	172.8	70.38	170.7	67.44	158.7	64.59
	-18.8	-19	176.7	70.38	176.7	72.51	176.7	71.43	176.7	69.30	170.7	66.42	158.7	63.63
	-16.7	-17	182.4	72.51	182.4	70.26	182.4	69.15	177.0	67.05	170.7	64.32	158.7	61.59
	-13.7	-15	190.8	69.18	186.9	67.02	182.4	65.91	177.0	63.84	170.7	61.26	158.7	58.65
	-11.8	-13	195.3	67.05	189.6	64.98	182.4	63.84	177.0	61.80	170.7	59.34	158.7	56.79
	-9.8	-11	200.4	64.83	192.3	62.85	182.4	61.68	177.0	59.67	170.7	57.30	158.7	54.84
	-9.5	-10	201.9	64.50	193.5	62.52	182.4	61.35	177.0	59.34	170.7	57.00	158.7	54.57
	-8.5	-9.1	204.0	63.39	194.4	61.44	182.4	60.27	177.0	58.26	170.7	56.01	158.7	53.58
	-7.0	-7.6	206.1	61.71	194.4	59.82	182.4	58.65	177.0	56.67	170.7	54.48	158.7	52.11
	-5.0	-5.6	206.1	59.49	194.4	57.69	182.4	56.46	177.0	54.51	170.7	52.44	158.7	50.16
	-3.0	-3.7	206.1	57.27	194.4	55.53	182.4	54.30	177.0	52.38	170.7	50.43	158.7	48.21
	0.0	-0.7	206.1	53.91	194.4	52.32	182.4	51.06	177.0	49.17	170.7	47.37	158.7	45.30
	3.0	2.2	206.1	50.58	194.4	49.08	182.4	47.79	177.0	45.93	170.7	44.34	158.7	42.36
	5.0	4.1	201.9	43.71	190.5	42.39	178.8	41.22	173.4	39.54	167.1	38.16	155.7	36.45
	7.0	6.0	196.8	41.04	185.7	39.87	174.3	38.67	168.9	37.08	162.9	35.85	151.5	34.23
	9.0	7.9	189.6	36.81	178.8	35.79	167.7	34.89	162.9	33.54	156.9	32.34	146.1	30.81
	11.0	9.8	179.4	32.73	168.9	31.83	158.7	31.02	153.9	29.82	148.5	28.77	138.0	27.39
	13.0	11.8	168.3	28.47	158.7	27.66	149.1	26.97	144.6	25.92	139.5	24.99	129.6	23.82
15.0	13.7	159.3	25.71	150.3	24.96	141.0	24.36	136.8	23.40	132.0	22.59	122.7	21.51	

# 7. Capacity Tables

Heating Capacity (72HP)

Combination (%)	Outdoor air temp.		Indoor air temp. °C DB											
			16		18		20		21		22		24	
	°C DB	°C WB	TC	PI	TC	PI	TC	PI	TC	PI	TC	PI	TC	PI
70	-24.8	-25	132.9	68.31	132.9	68.73	132.0	69.57	132.0	70.83	132.0	67.50	129.6	64.38
	-21.8	-22	156.3	69.57	156.3	69.99	155.4	70.83	150.0	67.50	145.5	64.38	135.9	61.38
	-19.8	-20	171.9	70.41	165.0	70.83	155.4	68.49	150.0	65.28	145.5	62.31	135.9	59.37
	-18.8	-19	174.9	70.83	165.0	69.63	155.4	67.32	150.0	64.17	145.5	61.26	135.9	58.35
	-16.7	-17	174.9	68.31	165.0	67.08	155.4	64.89	150.0	61.83	145.5	59.10	135.9	56.25
	-13.7	-15	174.9	64.77	165.0	63.48	155.4	61.38	150.0	58.53	145.5	55.98	135.9	53.22
	-11.8	-13	174.9	62.49	165.0	61.20	155.4	59.16	150.0	56.40	145.5	54.00	135.9	51.33
	-9.8	-11	174.9	60.12	165.0	58.77	155.4	56.85	150.0	54.18	145.5	51.93	135.9	49.32
	-9.5	-10	174.9	59.76	165.0	58.41	155.4	56.49	150.0	53.85	145.5	51.63	135.9	49.02
	-8.5	-9.1	174.9	58.59	165.0	57.21	155.4	55.32	150.0	52.74	145.5	50.58	135.9	48.00
	-7.0	-7.6	174.9	56.79	165.0	55.41	155.4	53.58	150.0	51.09	145.5	49.02	135.9	46.50
	-5.0	-5.6	174.9	54.42	165.0	53.01	155.4	51.24	150.0	48.87	145.5	46.95	135.9	44.49
	-3.0	-3.7	174.9	52.05	165.0	50.58	155.4	48.90	150.0	46.65	145.5	44.88	135.9	42.48
	0.0	-0.7	174.9	48.48	165.0	46.98	155.4	45.42	150.0	43.32	145.5	41.76	135.9	39.48
	3.0	2.2	174.9	44.91	165.0	43.38	155.4	41.91	150.0	40.02	145.5	38.64	135.9	36.45
	5.0	4.1	174.9	39.30	161.7	37.02	152.1	35.79	147.0	34.11	142.5	33.03	133.2	31.11
	7.0	6.0	174.9	37.53	157.5	34.32	148.2	33.15	143.1	31.65	138.9	30.69	129.6	28.86
	9.0	7.9	168.6	32.52	151.8	29.70	142.8	28.71	138.0	27.42	133.8	26.58	124.8	24.99
	11.0	9.8	159.6	28.86	143.7	26.37	135.0	25.50	130.5	24.33	126.6	23.61	118.2	22.20
	13.0	11.8	149.7	25.32	135.0	23.16	126.9	22.38	122.4	21.36	118.8	20.70	111.0	19.47
15.0	13.7	141.6	22.59	127.5	20.64	120.0	19.95	115.8	19.05	112.5	18.48	105.0	17.37	
60	-24.8	-25	132.9	67.47	132.9	68.31	132.0	69.57	128.7	66.00	124.2	62.67	116.4	59.52
	-21.8	-22	143.1	68.73	141.9	69.57	133.2	66.00	128.7	62.67	124.2	59.52	116.4	56.49
	-19.8	-20	150.0	69.57	141.9	67.05	133.2	63.63	128.7	60.45	124.2	57.42	116.4	54.45
	-18.8	-19	150.0	68.31	141.9	65.79	133.2	62.43	128.7	59.31	124.2	56.37	116.4	53.43
	-16.7	-17	150.0	65.64	141.9	63.15	133.2	59.94	128.7	56.97	124.2	54.18	116.4	51.30
	-13.7	-15	150.0	61.83	141.9	59.40	133.2	56.40	128.7	53.64	124.2	51.03	116.4	48.27
	-11.8	-13	150.0	59.43	141.9	57.00	133.2	54.12	128.7	51.51	124.2	49.05	116.4	46.35
	-9.8	-11	150.0	56.91	141.9	54.48	133.2	51.75	128.7	49.29	124.2	46.95	116.4	44.31
	-9.5	-10	150.0	56.52	141.9	54.12	133.2	51.39	128.7	48.96	124.2	46.62	116.4	44.01
	-8.5	-9.1	150.0	55.26	141.9	52.86	133.2	50.22	128.7	47.85	124.2	45.57	116.4	42.99
	-7.0	-7.6	150.0	53.37	141.9	50.97	133.2	48.45	128.7	46.17	124.2	44.01	116.4	41.46
	-5.0	-5.6	150.0	50.82	141.9	48.45	133.2	46.05	128.7	43.95	124.2	41.91	116.4	39.45
	-3.0	-3.7	150.0	48.30	141.9	45.93	133.2	43.68	128.7	41.73	124.2	39.81	116.4	37.41
	0.0	-0.7	150.0	44.49	141.9	42.18	133.2	40.14	128.7	38.37	124.2	36.66	116.4	34.38
	3.0	2.2	150.0	40.68	141.9	38.40	133.2	36.57	128.7	35.04	124.2	33.54	116.4	31.32
	5.0	4.1	147.0	34.53	139.2	32.46	130.5	30.90	126.0	29.64	121.8	28.41	114.0	26.49
	7.0	6.0	143.1	31.71	135.6	29.70	127.2	28.32	123.0	27.21	118.8	26.10	111.0	24.27
	9.0	7.9	138.0	27.18	130.5	25.44	122.4	24.27	118.5	23.31	114.3	22.38	107.1	20.79
	11.0	9.8	130.5	24.12	123.6	22.59	115.8	21.54	111.9	20.70	108.0	19.86	101.1	18.45
	13.0	11.8	122.4	21.15	116.1	19.80	108.9	18.87	105.0	18.15	101.4	17.40	95.1	16.20
15.0	13.7	115.8	19.05	109.8	17.82	102.9	16.83	99.6	16.20	96.0	15.54	90.0	14.58	
50	-24.8	-25	125.1	58.95	117.9	60.21	111.0	57.06	107.4	54.12	103.8	51.33	96.6	48.75
	-21.8	-22	125.1	60.21	117.9	57.06	111.0	54.12	107.4	51.33	103.8	48.75	96.6	46.26
	-19.8	-20	125.1	58.02	117.9	54.96	111.0	52.17	107.4	49.47	103.8	47.01	96.6	44.58
	-18.8	-19	125.1	56.91	117.9	53.91	111.0	51.18	107.4	48.57	103.8	46.14	96.6	43.74
	-16.7	-17	125.1	54.63	117.9	51.72	111.0	49.14	107.4	46.62	103.8	44.34	96.6	42.00
	-13.7	-15	125.1	51.36	117.9	48.57	111.0	46.20	107.4	43.83	103.8	41.76	96.6	39.51
	-11.8	-13	125.1	49.29	117.9	46.59	111.0	44.34	107.4	42.06	103.8	40.11	96.6	37.92
	-9.8	-11	125.1	47.10	117.9	44.49	111.0	42.36	107.4	40.20	103.8	38.37	96.6	36.24
	-9.5	-10	125.1	46.77	117.9	44.19	111.0	42.09	107.4	39.93	103.8	38.13	96.6	36.00
	-8.5	-9.1	125.1	45.66	117.9	43.14	111.0	41.10	107.4	39.00	103.8	37.26	96.6	35.16
	-7.0	-7.6	125.1	44.04	117.9	41.58	111.0	39.63	107.4	37.62	103.8	35.97	96.6	33.93
	-5.0	-5.6	125.1	41.85	117.9	39.48	111.0	37.68	107.4	35.76	103.8	34.23	96.6	32.25
	-3.0	-3.7	125.1	39.66	117.9	37.38	111.0	35.70	107.4	33.90	103.8	32.49	96.6	30.60
	0.0	-0.7	125.1	36.39	117.9	34.23	111.0	32.76	107.4	31.11	103.8	29.91	96.6	28.08
	3.0	2.2	125.1	33.12	117.9	31.11	111.0	29.85	107.4	28.32	103.8	27.33	96.6	25.59
	5.0	4.1	122.7	27.99	115.8	26.22	108.6	25.20	105.3	23.94	101.7	23.13	94.8	21.63
	7.0	6.0	119.4	25.59	112.8	23.94	105.9	23.07	102.6	21.90	99.3	21.24	92.4	19.80
	9.0	7.9	115.2	22.14	108.6	20.73	102.0	19.98	98.7	18.99	95.4	18.39	89.1	17.16
	11.0	9.8	109.5	19.89	103.2	18.63	96.9	17.94	93.3	17.04	90.3	16.50	84.3	15.39
	13.0	11.8	102.3	17.25	96.3	16.17	90.6	15.57	87.6	14.88	84.9	14.34	78.9	13.44
15.0	13.7	96.6	15.57	91.2	14.58	85.8	14.04	83.1	13.35	80.4	12.93	74.7	12.06	

**Note**

1. TC: Total Capacity(kW), PI : Power Input(kW, Comp. + Outdoor fan motor)
2. Capacity tables show the average value of conditions which may occur.
3. The heating capacity table is based on the values expressed as Max. in the specification of the outdoor unit. (When measuring the Max. heating capacity, the setting status of the indoor unit is the same as that for measuring the heating capacity of the indoor unit.)

# 7. Capacity Tables



## ◆ ARUM740LTE5

Heating Capacity (74HP)

Combination (%)	Outdoor air temp.		Indoor air temp. °C DB											
			16		18		20		21		22		24	
	°C DB	°C WB	TC	PI	TC	PI	TC	PI	TC	PI	TC	PI	TC	PI
130	-24.8	-25	142.0	75.9	142.0	76.70	141.2	77.37	141.2	78.37	141.2	79.36	138.9	80.90
	-21.8	-22	173.7	77.46	173.7	78.22	172.4	78.89	172.4	79.91	172.4	80.90	169.5	82.41
	-19.8	-20	183.5	78.48	183.5	79.25	182.3	79.91	182.3	80.94	182.3	81.90	179.3	83.44
	-18.8	-19	187.8	79.00	187.8	79.76	186.6	80.43	186.6	81.45	186.6	82.41	183.4	83.95
	-16.7	-17	196.7	80.07	196.7	80.83	195.4	81.50	195.4	82.52	195.4	83.50	192.1	85.02
	-13.7	-15	209.2	81.61	209.2	82.37	208.0	83.04	208.0	84.06	208.0	85.02	204.4	81.79
	-11.8	-13	216.0	82.59	216.0	83.33	214.8	84.00	214.8	85.02	214.8	82.86	212.2	79.74
	-9.8	-11	223.2	83.59	223.2	84.36	221.8	85.02	221.8	82.72	221.8	80.57	220.1	77.59
	-9.5	-10	224.5	83.77	224.5	84.51	223.2	84.67	223.2	82.36	222.9	80.22	221.4	77.24
	-8.5	-9.1	229.0	84.26	229.0	85.02	227.7	83.48	227.7	81.18	226.5	79.07	225.4	76.16
	-7.0	-7.6	235.8	85.02	235.8	83.29	234.2	81.70	234.2	79.44	234.2	77.33	231.9	74.55
	-5.0	-5.6	244.9	82.77	244.9	80.95	243.3	79.31	243.3	77.11	243.3	75.04	240.0	72.39
	-3.0	-3.7	253.9	80.52	253.9	78.63	252.3	76.93	252.3	74.77	252.3	72.75	248.2	70.22
	0.0	-0.7	267.4	77.12	267.4	75.14	265.7	73.37	265.7	71.28	265.7	69.30	260.1	66.99
	3.0	2.2	281.0	73.74	281.0	71.63	279.1	69.79	279.1	67.79	277.6	65.84	260.3	63.75
	5.0	4.1	284.2	64.95	283.6	62.89	281.9	61.10	280.7	59.25	273.9	57.46	255.0	55.61
	7.0	6.0	283.8	61.58	283.2	59.60	281.7	57.88	276.7	56.20	266.9	54.51	248.5	52.89
	9.0	7.9	274.5	57.29	273.9	55.44	273.3	53.82	266.5	52.25	257.2	50.70	239.5	49.19
11.0	9.8	259.7	53.68	259.1	51.95	258.4	50.43	251.9	48.96	243.2	47.52	226.4	46.08	
13.0	11.8	243.9	49.32	243.5	47.74	242.6	46.34	236.7	45.00	228.4	43.66	212.6	42.34	
15.0	13.7	230.7	45.68	230.3	44.20	229.5	42.93	223.9	41.68	216.1	40.44	201.1	39.21	
120	-24.8	-25	141.1	76.70	141.1	77.37	140.2	78.37	140.2	79.36	140.2	80.90	137.9	81.97
	-21.8	-22	172.4	78.22	172.4	78.89	171.2	79.91	171.2	80.90	171.2	82.41	168.5	83.50
	-19.8	-20	182.2	79.25	182.2	79.91	181.0	80.94	181.0	81.90	181.0	83.44	178.0	84.51
	-18.8	-19	186.4	79.76	186.4	80.43	185.1	81.45	185.1	82.41	185.1	83.95	182.1	85.02
	-16.7	-17	195.2	80.83	195.2	81.50	194.0	82.52	194.0	83.50	194.0	85.02	190.6	82.94
	-13.7	-15	207.6	82.37	207.6	83.04	206.4	84.06	206.4	85.02	206.4	81.91	202.9	79.96
	-11.8	-13	214.4	83.33	214.4	84.00	213.2	85.02	213.2	82.82	213.2	79.94	210.6	78.09
	-9.8	-11	221.6	84.36	221.6	85.02	220.3	82.60	220.3	80.51	220.3	77.88	218.6	76.10
	-9.5	-10	223.0	84.51	223.0	84.64	221.7	82.25	221.7	80.16	221.7	77.57	220.0	75.79
	-8.5	-9.1	227.5	85.02	227.5	83.36	225.9	81.03	225.9	79.01	225.9	76.54	224.0	74.80
	-7.0	-7.6	234.2	83.12	234.2	81.44	232.7	79.22	232.7	77.27	232.5	74.99	230.3	73.31
	-5.0	-5.6	243.2	80.57	243.2	78.87	241.6	76.79	241.6	74.94	241.6	72.90	238.5	71.32
	-3.0	-3.7	252.1	78.02	252.1	76.33	250.5	74.36	250.5	72.65	250.5	70.83	244.5	69.33
	0.0	-0.7	265.5	74.20	265.5	72.48	263.7	70.73	263.7	69.16	262.5	67.73	244.5	66.35
	3.0	2.2	278.9	70.37	278.9	68.63	276.3	67.09	271.5	65.69	263.0	64.62	244.5	63.38
	5.0	4.1	282.3	61.56	280.9	59.91	275.2	58.56	266.1	57.31	257.8	56.46	239.5	55.36
	7.0	6.0	282.1	58.09	279.2	56.52	268.3	55.40	259.3	54.34	251.3	53.83	233.4	52.87
	9.0	7.9	272.7	53.88	269.0	52.42	258.4	51.39	249.8	50.40	242.0	49.91	224.9	49.02
11.0	9.8	257.8	50.33	254.4	48.95	244.5	47.99	236.1	47.07	228.9	46.64	212.6	45.81	
13.0	11.8	242.2	46.08	238.9	44.82	229.5	43.95	221.8	43.10	215.0	42.70	199.7	41.93	
15.0	13.7	229.2	42.51	226.1	41.34	217.1	40.53	210.0	39.77	203.5	39.40	188.9	38.69	
110	-24.8	-25	140.4	77.37	140.4	78.37	139.5	79.36	139.5	80.90	139.5	81.97	137.1	82.48
	-21.8	-22	171.5	78.89	171.5	79.91	170.3	80.90	170.3	82.41	170.3	83.50	167.6	84.00
	-19.8	-20	181.3	79.91	181.3	80.94	180.1	81.90	180.1	83.44	180.1	84.51	177.1	85.02
	-18.8	-19	185.4	80.43	185.4	81.45	184.1	82.41	184.1	83.95	184.1	85.02	181.2	83.93
	-16.7	-17	194.2	81.50	194.2	82.52	193.0	83.50	193.0	85.02	193.0	82.78	189.6	81.61
	-13.7	-15	206.5	83.04	206.5	84.06	205.2	85.02	205.2	81.62	205.2	79.54	205.2	78.31
	-11.8	-13	213.3	84.00	213.3	85.02	212.0	82.62	212.0	79.45	212.0	77.50	212.0	76.22
	-9.8	-11	220.4	85.02	220.4	82.31	219.1	80.09	219.1	77.17	219.1	75.36	218.5	74.02
	-9.5	-10	221.7	84.58	221.7	81.89	220.5	79.69	220.5	76.83	220.5	75.04	219.7	73.69
	-8.5	-9.1	226.2	83.12	226.2	80.53	224.9	78.43	224.9	75.69	224.9	73.94	220.0	72.58
	-7.0	-7.6	233.0	80.90	233.0	78.50	231.5	76.53	231.5	73.98	231.5	72.34	220.0	70.94
	-5.0	-5.6	241.8	77.97	241.8	75.75	240.2	73.99	240.2	71.71	235.5	70.19	220.0	68.72
	-3.0	-3.7	250.7	75.03	250.7	73.04	249.0	71.44	243.8	69.42	235.5	68.03	220.0	66.53
	0.0	-0.7	264.1	70.62	263.7	68.95	251.9	67.64	243.8	66.00	235.5	64.82	220.0	63.24
	3.0	2.2	276.9	66.21	268.6	64.86	251.9	63.82	243.8	62.60	235.5	61.58	220.0	59.92
	5.0	4.1	278.5	57.41	263.2	56.29	247.0	55.45	238.9	54.48	230.9	53.63	215.6	52.07
	7.0	6.0	271.4	53.69	256.6	52.89	240.8	52.29	232.9	51.65	224.9	51.00	210.1	49.40
	9.0	7.9	261.5	49.53	247.0	48.79	231.8	48.24	224.3	47.65	216.8	47.06	202.3	45.59
11.0	9.8	247.2	46.00	233.6	45.30	219.4	44.79	212.2	44.27	205.0	43.69	191.4	42.33	
13.0	11.8	232.1	41.85	219.4	41.21	206.0	40.74	199.2	40.24	192.4	39.74	179.7	38.52	
15.0	13.7	219.6	38.29	207.5	37.72	194.9	37.29	188.4	36.85	182.1	36.37	170.0	35.24	



# 7. Capacity Tables

Heating Capacity (74HP)

Combination (%)	Outdoor air temp.		Indoor air temp. °C DB											
			16		18		20		21		22		24	
	°C DB	°C WB	TC	PI	TC	PI	TC	PI	TC	PI	TC	PI	TC	PI
100	-24.8	-25	139.8	85.97	139.8	85.85	138.9	80.68	138.9	85.54	138.9	85.41	136.5	85.35
	-21.8	-22	170.6	85.78	170.6	85.66	169.7	83.22	169.7	85.35	169.7	86.42	166.7	85.16
	-19.8	-20	180.4	85.66	180.4	85.52	179.4	84.83	179.4	85.23	179.4	85.49	176.4	85.02
	-18.8	-19	184.5	85.60	183.5	85.47	183.5	85.35	183.5	85.15	183.5	85.02	180.3	83.68
	-16.7	-17	192.1	85.47	192.1	85.34	192.1	86.42	191.1	85.02	191.1	82.25	187.8	80.86
	-13.7	-15	205.5	85.28	205.5	85.14	204.3	85.02	204.3	81.00	204.3	78.28	201.1	76.81
	-11.8	-13	212.3	85.16	211.1	85.02	211.1	82.33	211.1	78.44	211.1	75.75	201.1	74.26
	-9.8	-11	219.2	85.02	219.2	82.00	218.2	79.48	218.2	75.76	215.7	73.12	201.1	71.56
	-9.5	-10	220.5	84.55	220.5	81.54	219.5	79.06	219.5	75.35	215.7	72.71	201.1	71.16
	-8.5	-9.1	225.0	82.97	225.0	80.03	224.0	77.63	223.1	74.00	215.7	71.40	201.1	69.80
	-7.0	-7.6	235.5	80.60	234.6	77.76	230.5	75.49	223.1	72.00	215.7	69.41	201.1	67.78
	-5.0	-5.6	245.7	77.42	243.3	74.74	230.5	72.66	223.1	69.30	215.7	66.76	201.1	65.08
	-3.0	-3.7	252.9	74.26	245.3	71.70	230.5	69.81	223.1	66.61	215.7	64.13	201.1	62.39
	0.0	-0.7	259.9	69.50	245.3	67.17	230.5	65.54	223.1	62.59	215.7	60.14	201.1	58.35
	3.0	2.2	259.9	64.73	245.3	62.62	230.5	61.28	223.1	58.56	215.7	56.17	201.1	54.32
	5.0	4.1	254.7	55.90	240.4	54.04	225.8	52.90	218.7	50.52	211.6	48.35	197.0	46.63
	7.0	6.0	248.2	51.97	234.2	50.34	220.2	49.46	213.1	47.33	206.0	45.29	192.0	43.55
	9.0	7.9	239.2	47.66	225.6	46.16	212.2	45.36	205.4	43.39	198.6	41.50	184.9	39.92
	11.0	9.8	226.2	43.93	213.4	42.53	200.5	41.80	194.1	39.99	187.7	38.26	175.0	36.80
	13.0	11.8	212.4	39.60	200.4	38.36	188.3	37.69	182.4	36.06	176.2	34.51	164.1	33.18
15.0	13.7	201.1	35.89	189.6	34.76	178.1	34.16	172.5	32.67	166.8	31.26	155.4	30.07	
90	-24.8	-25	139.2	76.27	139.2	77.79	138.3	78.88	138.3	79.37	138.3	80.40	136.1	81.94
	-21.8	-22	170.0	77.79	170.0	79.33	169.1	80.40	169.1	80.91	169.1	81.94	166.0	78.40
	-19.8	-20	179.8	78.82	179.8	80.35	178.6	81.42	178.6	81.94	178.6	79.51	175.6	76.05
	-18.8	-19	184.5	79.33	183.5	80.87	182.7	81.94	182.7	80.70	182.7	78.31	179.7	74.88
	-16.7	-17	192.1	80.40	192.1	81.94	191.3	79.37	191.3	78.08	191.3	75.79	183.6	72.40
	-13.7	-15	205.5	81.94	205.5	78.10	203.7	75.69	203.7	74.36	197.8	72.16	183.6	68.87
	-11.8	-13	212.3	79.30	211.1	75.69	210.2	73.36	204.4	71.99	197.8	69.87	183.6	66.63
	-9.8	-11	219.2	76.56	219.2	73.15	211.0	70.92	204.4	69.50	197.8	67.46	183.6	64.27
	-9.5	-10	220.5	76.13	220.5	72.75	211.0	70.54	204.4	69.12	197.8	67.09	183.6	63.91
	-8.5	-9.1	225.0	74.77	223.4	71.48	211.0	69.31	204.4	67.88	197.8	65.88	183.6	62.74
	-7.0	-7.6	235.5	72.69	224.0	69.57	211.0	67.48	204.4	66.01	197.8	64.07	183.6	60.97
	-5.0	-5.6	238.0	69.93	224.0	67.02	211.0	65.04	204.4	63.54	197.8	61.66	183.6	58.63
	-3.0	-3.7	238.0	67.17	224.0	64.48	211.0	62.58	204.4	61.05	197.8	59.24	183.6	56.26
	0.0	-0.7	238.0	63.04	224.0	60.65	211.0	58.91	204.4	57.32	197.8	55.62	183.6	52.74
	3.0	2.2	238.0	58.88	224.0	56.82	211.0	55.23	204.4	53.60	197.8	52.01	183.6	49.19
	5.0	4.1	233.3	50.83	219.6	49.07	206.6	47.67	200.3	46.16	193.9	44.76	179.9	42.24
	7.0	6.0	227.4	47.51	214.0	46.03	201.3	44.79	195.1	43.28	188.9	41.98	175.6	39.58
	9.0	7.9	219.0	43.54	206.0	42.22	193.9	41.07	188.0	39.66	182.0	38.49	169.0	36.30
	11.0	9.8	207.2	39.75	194.9	38.52	183.4	37.48	177.8	36.21	172.1	35.13	159.8	33.11
	13.0	11.8	194.5	35.11	183.0	34.03	172.3	33.13	166.9	31.99	161.6	31.03	150.1	29.26
15.0	13.7	184.0	31.48	173.1	30.51	163.1	29.69	157.9	28.68	153.0	27.82	142.1	26.24	
80	-24.8	-25	138.6	66.98	138.6	68.52	137.7	69.59	137.7	70.10	137.7	72.65	135.5	69.55
	-21.8	-22	168.1	68.52	168.1	70.04	168.1	71.11	168.1	72.65	168.1	69.55	164.1	66.56
	-19.8	-20	177.9	69.53	177.9	71.06	177.9	72.65	177.9	70.46	176.2	67.47	164.1	64.57
	-18.8	-19	182.0	70.04	182.0	72.65	182.0	71.54	182.0	69.36	176.4	66.43	164.1	63.58
	-16.7	-17	188.6	72.65	188.6	70.34	188.6	69.21	183.0	67.06	176.4	64.27	164.1	61.50
	-13.7	-15	197.2	69.22	193.3	67.01	188.6	65.88	183.0	63.77	176.4	61.15	164.1	58.51
	-11.8	-13	202.1	67.02	196.1	64.91	188.6	63.75	183.0	61.68	176.4	59.18	164.1	56.61
	-9.8	-11	207.4	64.73	199.0	62.71	188.6	61.53	183.0	59.50	176.4	57.11	164.1	54.62
	-9.5	-10	208.9	64.39	200.1	62.37	188.6	61.19	183.0	59.16	176.4	56.79	164.1	54.33
	-8.5	-9.1	211.1	63.25	201.0	61.27	188.6	60.08	183.0	58.06	176.4	55.77	164.1	53.33
	-7.0	-7.6	213.2	61.52	201.0	59.60	188.6	58.41	183.0	56.42	176.4	54.22	164.1	51.83
	-5.0	-5.6	213.2	59.23	201.0	57.41	188.6	56.18	183.0	54.21	176.4	52.13	164.1	49.84
	-3.0	-3.7	213.2	56.94	201.0	55.19	188.6	53.96	183.0	52.03	176.4	50.07	164.1	47.85
	0.0	-0.7	213.2	53.48	201.0	51.88	188.6	50.63	183.0	48.74	176.4	46.94	164.1	44.88
	3.0	2.2	213.2	50.05	201.0	48.55	188.6	47.28	183.0	45.43	176.4	43.84	164.1	41.88
	5.0	4.1	208.9	43.17	197.0	41.87	184.9	40.70	179.3	39.04	172.8	37.68	161.0	35.99
	7.0	6.0	203.6	40.44	192.0	39.29	180.2	38.12	174.7	36.54	168.4	35.33	156.7	33.73
	9.0	7.9	196.1	36.05	184.9	35.05	173.5	34.18	168.4	32.87	162.2	31.70	151.1	30.19
	11.0	9.8	185.5	31.87	174.7	31.00	164.1	30.22	159.2	29.06	153.6	28.03	142.7	26.69
	13.0	11.8	174.1	27.54	164.1	26.76	154.2	26.11	149.5	25.09	144.2	24.19	134.1	23.05
15.0	13.7	164.7	24.67	155.4	23.97	145.8	23.38	141.5	22.48	136.5	21.68	126.9	20.65	

# 7. Capacity Tables

Heating Capacity (74HP)

Combination (%)	Outdoor air temp.		Indoor air temp. °C DB													
			16		18		20		21		22		24			
	°C DB	°C WB	TC	PI	TC	PI	TC	PI	TC	PI	TC	PI	TC	PI		
70	-24.8	-25	138.6	67.73	138.6	68.24	137.7	69.27	137.7	70.81	137.7	70.81	137.7	67.44	135.4	64.27
	-21.8	-22	161.6	69.27	161.6	69.78	160.6	70.81	155.1	67.44	150.5	62.18	140.5	61.23		
	-19.8	-20	177.0	70.30	170.7	70.81	160.6	68.44	155.1	65.19	150.5	62.18	140.5	59.21		
	-18.8	-19	180.6	70.81	170.7	69.58	160.6	67.25	155.1	64.06	150.5	61.12	140.5	58.17		
	-16.7	-17	180.8	68.25	170.7	67.00	160.6	64.78	155.1	61.70	150.5	58.92	140.5	56.05		
	-13.7	-15	180.8	64.64	170.7	63.34	160.6	61.22	155.1	58.33	150.5	55.77	140.5	52.99		
	-11.8	-13	180.8	62.32	170.7	61.01	160.6	58.96	155.1	56.18	150.5	53.76	140.5	51.07		
	-9.8	-11	180.8	59.91	170.7	58.56	160.6	56.61	155.1	53.93	150.5	51.66	140.5	49.04		
	-9.5	-10	180.8	59.54	170.7	58.19	160.6	56.25	155.1	53.60	150.5	51.35	140.5	48.74		
	-8.5	-9.1	180.8	58.34	170.7	56.97	160.6	55.06	155.1	52.47	150.5	50.30	140.5	47.71		
	-7.0	-7.6	180.8	56.52	170.7	55.14	160.6	53.29	155.1	50.79	150.5	48.72	140.5	46.19		
	-5.0	-5.6	180.8	54.10	170.7	52.69	160.6	50.92	155.1	48.54	150.5	46.61	140.5	44.16		
	-3.0	-3.7	180.8	51.69	170.7	50.23	160.6	48.55	155.1	46.29	150.5	44.51	140.5	42.12		
	0.0	-0.7	180.8	48.05	170.7	46.57	160.6	45.01	155.1	42.92	150.5	41.36	140.5	39.08		
	3.0	2.2	180.8	44.42	170.7	42.89	160.6	41.44	155.1	39.56	150.5	38.20	140.5	36.02		
	5.0	4.1	180.8	38.80	167.2	36.56	157.3	35.34	152.0	33.68	147.4	32.60	137.7	30.71		
	7.0	6.0	180.9	36.99	162.9	33.81	153.3	32.68	148.0	31.20	143.7	30.25	134.1	28.45		
	9.0	7.9	174.4	31.89	157.0	29.13	147.7	28.16	142.7	26.89	138.4	26.06	129.1	24.51		
	11.0	9.8	164.9	28.14	148.6	25.71	139.6	24.86	134.9	23.73	131.0	23.02	122.2	21.64		
	13.0	11.8	154.8	24.52	139.6	22.43	131.2	21.67	126.6	20.69	122.9	20.06	114.7	18.86		
15.0	13.7	146.4	21.71	131.8	19.83	124.2	19.18	119.8	18.30	116.4	17.76	108.6	16.69			
60	-24.8	-25	137.8	66.70	137.8	67.73	136.9	69.27	133.1	65.69	128.5	62.34	120.3	59.18		
	-21.8	-22	148.1	68.24	146.8	69.27	137.7	65.69	133.1	62.34	128.5	59.18	120.3	56.14		
	-19.8	-20	155.1	69.27	146.8	66.74	137.7	63.31	133.1	60.11	128.5	57.08	120.3	54.11		
	-18.8	-19	155.1	68.01	146.8	65.48	137.7	62.10	133.1	58.97	128.5	56.03	120.3	53.08		
	-16.7	-17	155.1	65.32	146.8	62.82	137.7	59.61	133.1	56.63	128.5	53.83	120.3	50.95		
	-13.7	-15	155.1	61.48	146.8	59.04	137.7	56.04	133.1	53.28	128.5	50.67	120.3	47.91		
	-11.8	-13	155.1	59.07	146.8	56.64	137.7	53.76	133.1	51.15	128.5	48.68	120.3	45.99		
	-9.8	-11	155.1	56.53	146.8	54.11	137.7	51.38	133.1	48.92	128.5	46.57	120.3	43.94		
	-9.5	-10	155.1	56.14	146.8	53.74	137.7	51.02	133.1	48.58	128.5	46.25	120.3	43.64		
	-8.5	-9.1	155.1	54.87	146.8	52.48	137.7	49.84	133.1	47.47	128.5	45.19	120.3	42.63		
	-7.0	-7.6	155.1	52.97	146.8	50.58	137.7	48.05	133.1	45.78	128.5	43.62	120.3	41.10		
	-5.0	-5.6	155.1	50.40	146.8	48.05	137.7	45.66	133.1	43.55	128.5	41.53	120.3	39.07		
	-3.0	-3.7	155.1	47.86	146.8	45.52	137.7	43.27	133.1	41.32	128.5	39.42	120.3	37.03		
	0.0	-0.7	155.1	44.03	146.8	41.73	137.7	39.71	133.1	37.95	128.5	36.26	120.3	33.99		
	3.0	2.2	155.1	40.20	146.8	37.94	137.7	36.12	133.1	34.61	128.5	33.12	120.3	30.93		
	5.0	4.1	152.0	34.09	143.9	32.04	134.9	30.50	130.4	29.26	125.9	28.03	117.8	26.14		
	7.0	6.0	148.0	31.24	140.2	29.27	131.6	27.91	127.1	26.82	122.8	25.72	114.8	23.92		
	9.0	7.9	142.7	26.65	135.0	24.95	126.6	23.79	122.5	22.86	118.2	21.94	110.7	20.39		
	11.0	9.8	134.9	23.52	127.7	22.03	119.7	21.00	115.7	20.18	111.7	19.36	104.6	17.99		
	13.0	11.8	126.6	20.48	120.1	19.18	112.5	18.28	108.6	17.58	104.9	16.86	98.3	15.69		
15.0	13.7	119.8	18.30	113.5	17.13	106.5	16.17	103.0	15.56	99.3	14.93	93.0	14.01			
50	-24.8	-25	129.4	58.78	122.0	60.32	114.7	57.13	111.0	54.14	107.3	51.33	99.9	48.71		
	-21.8	-22	129.4	60.32	122.0	57.13	114.7	54.14	111.0	51.33	107.3	48.71	99.9	46.19		
	-19.8	-20	129.4	58.10	122.0	55.00	114.7	52.17	111.0	49.44	107.3	46.95	99.9	44.49		
	-18.8	-19	129.4	56.98	122.0	53.93	114.7	51.17	111.0	48.52	107.3	46.07	99.9	43.65		
	-16.7	-17	129.4	54.65	122.0	51.71	114.7	49.09	111.0	46.54	107.3	44.24	99.9	41.89		
	-13.7	-15	129.4	51.33	122.0	48.51	114.7	46.11	111.0	43.72	107.3	41.62	99.9	39.37		
	-11.8	-13	129.4	49.22	122.0	46.50	114.7	44.22	111.0	41.93	107.3	39.96	99.9	37.76		
	-9.8	-11	129.4	46.99	122.0	44.37	114.7	42.22	111.0	40.05	107.3	38.20	99.9	36.07		
	-9.5	-10	129.4	46.66	122.0	44.06	114.7	41.94	111.0	39.77	107.3	37.96	99.9	35.82		
	-8.5	-9.1	129.4	45.53	122.0	42.99	114.7	40.94	111.0	38.83	107.3	37.08	99.9	34.98		
	-7.0	-7.6	129.4	43.88	122.0	41.41	114.7	39.45	111.0	37.43	107.3	35.77	99.9	33.73		
	-5.0	-5.6	129.4	41.65	122.0	39.28	114.7	37.47	111.0	35.54	107.3	34.01	99.9	32.04		
	-3.0	-3.7	129.4	39.42	122.0	37.15	114.7	35.46	111.0	33.66	107.3	32.25	99.9	30.36		
	0.0	-0.7	129.4	36.10	122.0	33.95	114.7	32.49	111.0	30.84	107.3	29.63	99.9	27.82		
	3.0	2.2	129.4	32.78	122.0	30.78	114.7	29.52	111.0	28.01	107.3	27.02	99.9	25.30		
	5.0	4.1	126.9	27.65	119.7	25.90	112.3	24.89	108.8	23.65	105.2	22.84	98.1	21.36		
	7.0	6.0	123.5	25.22	116.6	23.60	109.6	22.74	106.1	21.59	102.6	20.93	95.6	19.51		
	9.0	7.9	119.1	21.71	112.3	20.33	105.5	19.59	102.1	18.62	98.7	18.04	92.1	16.82		
	11.0	9.8	113.2	19.40	106.7	18.16	100.2	17.49	96.5	16.61	93.4	16.09	87.2	15.01		
	13.0	11.8	105.7	16.71	99.7	15.65	93.7	15.07	90.7	14.41	87.8	13.88	81.6	13.02		
15.0	13.7	99.9	14.97	94.4	14.01	88.7	13.49	85.9	12.83	83.1	12.42	77.3	11.58			

**Note**

1. TC: Total Capacity(kW), PI : Power Input(kW, Comp. + Outdoor fan motor)
2. Capacity tables show the average value of conditions which may occur.
3. The heating capacity table is based on the values expressed as Max. in the specification of the outdoor unit. (When measuring the Max. heating capacity, the setting status of the indoor unit is the same as that for measuring the heating capacity of the indoor unit.)

# 7. Capacity Tables

## ◆ ARUM760LTE5

Heating Capacity (76HP)

Combination (%)	Outdoor air temp.		Indoor air temp. °C DB											
			16		18		20		21		22		24	
	°C DB	°C WB	TC	PI	TC	PI	TC	PI	TC	PI	TC	PI	TC	PI
130	-24.8	-25	143.4	77.7	143.4	78.58	142.5	79.37	142.5	80.56	142.5	81.72	140.8	83.55
	-21.8	-22	175.6	79.48	175.6	80.38	174.4	81.17	174.4	82.38	174.4	83.55	172.1	85.34
	-19.8	-20	185.7	80.68	185.7	81.60	184.5	82.38	184.5	83.59	184.5	84.73	182.2	86.55
	-18.8	-19	190.2	81.30	190.2	82.20	189.0	82.99	189.0	84.20	189.0	85.34	186.5	87.16
	-16.7	-17	199.3	82.56	199.3	83.47	198.1	84.26	198.1	85.46	198.1	86.62	195.5	88.42
	-13.7	-15	212.3	84.38	212.3	85.29	211.0	86.08	211.0	87.28	211.0	88.42	208.2	85.12
	-11.8	-13	219.3	85.54	219.3	86.43	218.0	87.22	218.0	88.42	218.0	86.22	216.0	83.03
	-9.8	-11	226.7	86.73	226.7	87.64	225.3	88.42	225.3	86.08	225.3	83.88	223.9	80.83
	-9.5	-10	228.2	86.93	228.2	87.82	226.9	88.07	226.9	85.71	226.3	83.53	225.1	80.48
	-8.5	-9.1	233.8	87.52	233.8	88.42	232.5	86.86	232.5	84.52	230.1	82.35	229.1	79.37
	-7.0	-7.6	242.3	88.42	242.3	86.67	240.6	85.06	240.6	82.75	240.6	80.58	236.8	77.73
	-5.0	-5.6	253.5	86.17	253.5	84.31	251.8	82.63	251.8	80.38	251.8	78.25	245.2	75.52
	-3.0	-3.7	264.7	83.90	264.7	81.97	263.0	80.22	263.0	78.00	263.0	75.91	253.7	73.30
	0.0	-0.7	281.4	80.48	281.4	78.44	279.5	76.61	278.4	74.45	276.2	72.40	266.4	70.00
	3.0	2.2	292.7	77.08	292.7	74.89	291.0	72.98	289.4	70.91	285.7	68.87	267.4	66.70
	5.0	4.1	294.2	67.97	293.5	65.83	291.9	63.96	289.2	62.03	281.4	60.16	262.0	58.22
	7.0	6.0	291.9	64.54	291.3	62.47	289.9	60.66	284.3	58.90	274.2	57.13	255.3	55.43
	9.0	7.9	282.0	60.13	281.4	58.18	280.7	56.48	273.8	54.84	264.2	53.21	246.0	51.63
	11.0	9.8	266.8	56.42	266.2	54.61	265.5	53.01	258.8	51.47	249.9	49.95	232.6	48.44
	13.0	11.8	250.5	51.94	250.1	50.27	249.3	48.80	243.1	47.38	234.6	45.98	218.4	44.59
15.0	13.7	237.1	48.21	236.6	46.65	235.8	45.30	230.1	43.98	222.0	42.67	206.6	41.38	
120	-24.8	-25	142.5	78.58	142.5	79.37	141.5	80.56	141.5	81.72	141.5	83.55	139.8	84.81
	-21.8	-22	174.4	80.38	174.4	81.17	173.2	82.38	173.2	83.55	173.2	85.34	171.1	86.62
	-19.8	-20	184.5	81.60	184.5	82.38	183.2	83.59	183.2	84.73	183.2	86.55	180.9	87.82
	-18.8	-19	188.7	82.20	188.7	82.99	187.5	84.20	187.5	85.34	187.5	87.16	185.2	88.42
	-16.7	-17	197.8	83.47	197.8	84.26	196.6	85.46	196.6	86.62	196.6	88.42	194.0	86.30
	-13.7	-15	210.7	85.29	210.7	86.08	209.4	87.28	209.4	88.42	209.4	85.25	206.7	83.26
	-11.8	-13	217.7	86.43	217.7	87.22	216.4	88.42	216.4	86.18	216.4	83.24	214.4	81.34
	-9.8	-11	225.0	87.64	225.0	88.42	223.7	85.96	223.7	83.82	223.7	81.14	222.3	79.31
	-9.5	-10	226.7	87.82	226.7	88.03	225.4	85.60	225.4	83.47	225.4	80.82	224.0	78.99
	-8.5	-9.1	232.3	88.42	232.3	86.73	230.7	84.36	230.7	82.29	230.2	79.78	228.6	77.98
	-7.0	-7.6	240.6	86.49	240.6	84.78	239.1	82.51	239.1	80.52	237.0	78.18	235.1	76.46
	-5.0	-5.6	251.8	83.91	251.8	82.17	250.1	80.05	250.1	78.15	250.1	76.06	243.6	74.43
	-3.0	-3.7	262.7	81.32	262.7	79.59	261.1	77.57	261.1	75.81	260.2	73.95	250.5	72.39
	0.0	-0.7	279.4	77.45	278.9	75.68	274.9	73.87	272.9	72.25	269.8	70.78	251.1	69.35
	3.0	2.2	290.5	73.58	289.8	71.77	285.1	70.17	278.9	68.71	270.2	67.61	251.1	66.32
	5.0	4.1	292.1	64.43	290.1	62.71	282.7	61.30	273.4	60.00	264.9	59.11	246.1	57.96
	7.0	6.0	290.1	60.88	286.9	59.24	275.7	58.06	266.4	56.95	258.1	56.42	239.7	55.41
	9.0	7.9	280.1	56.55	276.3	55.01	265.5	53.93	256.6	52.90	248.6	52.38	231.1	51.45
	11.0	9.8	264.9	52.90	261.3	51.45	251.1	50.43	242.6	49.48	235.2	49.01	218.4	48.15
	13.0	11.8	248.8	48.52	245.4	47.19	235.8	46.27	227.9	45.38	220.9	44.95	205.2	44.15
15.0	13.7	235.5	44.84	232.3	43.61	223.1	42.75	215.7	41.96	209.1	41.56	194.1	40.82	
110	-24.8	-25	141.7	79.37	141.7	80.56	140.9	81.72	140.9	83.55	140.9	84.81	139.0	85.42
	-21.8	-22	173.5	81.17	173.5	82.38	172.3	83.55	172.3	85.34	172.3	86.62	170.2	87.22
	-19.8	-20	183.5	82.38	183.5	83.59	182.3	84.73	182.3	86.55	182.3	87.82	179.9	88.42
	-18.8	-19	187.7	82.99	187.7	84.20	186.5	85.34	186.5	87.16	186.5	88.42	184.2	87.30
	-16.7	-17	196.8	84.26	196.8	85.46	195.6	86.62	195.6	88.42	195.6	86.13	193.0	84.92
	-13.7	-15	209.6	86.08	209.6	87.28	208.2	88.42	208.2	84.94	208.2	82.82	208.2	81.55
	-11.8	-13	216.5	87.22	216.5	88.42	215.2	85.97	215.2	82.72	215.2	80.72	215.2	79.40
	-9.8	-11	223.8	88.42	223.8	85.65	222.5	83.39	222.5	80.40	222.5	78.53	221.9	77.15
	-9.5	-10	225.4	87.97	225.4	85.22	224.2	82.97	224.2	80.04	224.2	78.21	223.6	76.81
	-8.5	-9.1	231.0	86.49	231.0	83.84	229.6	81.68	229.6	78.88	229.3	77.09	225.4	75.67
	-7.0	-7.6	239.3	84.22	239.3	81.76	237.8	79.74	237.8	77.13	236.3	75.45	226.0	73.99
	-5.0	-5.6	250.3	81.23	250.3	78.96	248.6	77.15	247.6	74.81	241.0	73.25	226.0	71.72
	-3.0	-3.7	261.3	78.23	261.3	76.18	256.6	74.54	250.5	72.46	241.9	71.04	226.0	69.47
	0.0	-0.7	275.9	73.72	272.1	72.01	258.8	70.66	250.5	68.97	241.9	67.75	226.0	66.09
	3.0	2.2	286.3	69.23	275.9	67.83	258.8	66.76	250.5	65.49	241.9	64.43	226.0	62.70
	5.0	4.1	286.2	60.08	270.3	58.93	253.7	58.05	245.4	57.04	237.2	56.16	221.5	54.52
	7.0	6.0	278.8	56.27	263.6	55.43	247.3	54.81	239.3	54.13	231.1	53.45	215.8	51.78
	9.0	7.9	268.7	51.98	253.7	51.20	238.1	50.62	230.4	50.01	222.7	49.38	207.9	47.84
	11.0	9.8	254.0	48.35	240.0	47.61	225.3	47.07	218.0	46.52	210.6	45.91	196.6	44.49
	13.0	11.8	238.5	44.06	225.4	43.39	211.6	42.89	204.7	42.37	197.7	41.84	184.6	40.55
15.0	13.7	225.6	40.39	213.2	39.79	200.2	39.33	193.5	38.86	187.1	38.36	174.7	37.17	

# 7. Capacity Tables

Heating Capacity (76HP)

Combination (%)	Outdoor air temp.		Indoor air temp. °C DB											
			16		18		20		21		22		24	
	°C DB	°C WB	TC	PI	TC	PI	TC	PI	TC	PI	TC	PI	TC	PI
100	-24.8	-25	141.1	88.19	141.1	88.22	140.2	83.42	140.2	88.30	140.2	88.34	138.3	88.36
	-21.8	-22	172.5	88.23	172.5	88.27	171.6	86.06	171.6	88.35	171.6	89.62	169.2	88.41
	-19.8	-20	182.6	88.27	182.6	88.29	181.6	87.74	181.6	88.39	181.6	88.83	179.3	88.42
	-18.8	-19	186.9	88.29	185.8	88.32	185.8	88.35	185.8	88.39	185.8	88.42	183.3	87.05
	-16.7	-17	194.7	88.33	194.7	88.36	194.7	89.62	193.7	88.42	193.7	85.58	191.1	84.14
	-13.7	-15	208.6	88.37	208.6	88.39	207.3	88.42	207.3	84.30	207.3	81.49	204.8	79.97
	-11.8	-13	215.5	88.41	214.3	88.42	214.3	85.66	214.3	81.67	214.3	78.90	206.3	77.34
	-9.8	-11	222.5	88.42	222.5	85.33	221.6	82.74	221.6	78.91	219.6	76.19	206.5	74.57
	-9.5	-10	224.2	87.94	224.2	84.86	223.2	82.31	223.2	78.49	220.2	75.77	206.5	74.16
	-8.5	-9.1	229.7	86.32	229.7	83.31	228.7	80.85	229.2	77.11	221.6	74.42	206.5	72.76
	-7.0	-7.6	241.9	83.90	241.0	80.99	236.8	78.65	229.2	75.06	221.6	72.37	206.5	70.68
	-5.0	-5.6	252.5	80.65	249.9	77.90	236.8	75.75	229.2	72.28	221.6	69.65	206.5	67.91
	-3.0	-3.7	259.8	77.42	252.0	74.79	236.8	72.84	229.2	69.52	221.6	66.94	206.5	65.13
	0.0	-0.7	267.1	72.55	252.0	70.14	236.8	68.46	229.2	65.39	221.6	62.85	206.5	60.98
	3.0	2.2	267.1	67.68	252.0	65.48	236.8	64.09	229.2	61.25	221.6	58.76	206.5	56.83
	5.0	4.1	261.7	58.51	247.0	56.56	232.0	55.38	224.7	52.88	217.3	50.62	202.4	48.82
	7.0	6.0	255.0	54.47	240.6	52.76	226.2	51.84	218.9	49.60	211.7	47.46	197.3	45.64
	9.0	7.9	245.7	49.98	231.7	48.40	218.0	47.56	211.0	45.50	204.0	43.52	189.9	41.86
	11.0	9.8	232.4	46.10	219.3	44.63	205.9	43.86	199.4	41.96	192.8	40.15	179.7	38.61
	13.0	11.8	218.2	41.59	205.9	40.28	193.5	39.58	187.4	37.87	181.0	36.24	168.6	34.84
15.0	13.7	206.5	37.72	194.8	36.54	183.0	35.90	177.2	34.33	171.4	32.85	159.7	31.60	
90	-24.8	-25	140.5	78.26	140.5	80.06	139.6	81.35	139.6	81.93	139.6	83.15	137.9	84.97
	-21.8	-22	171.9	80.06	171.9	81.88	171.0	83.15	171.0	83.75	171.0	84.97	168.6	81.35
	-19.8	-20	182.0	81.28	182.0	83.09	180.7	84.35	180.7	84.97	180.7	82.49	178.4	78.94
	-18.8	-19	186.9	81.88	185.8	83.70	185.0	84.97	185.0	83.70	185.0	81.26	182.7	77.74
	-16.7	-17	194.7	83.15	194.7	84.97	193.9	82.35	193.9	81.03	193.9	78.68	187.7	75.20
	-13.7	-15	208.6	84.97	208.6	81.06	206.7	78.60	206.7	77.23	202.1	74.97	188.7	71.58
	-11.8	-13	215.5	82.29	214.3	78.60	213.4	76.22	208.8	74.81	203.2	72.64	188.7	69.29
	-9.8	-11	222.5	79.50	222.5	76.02	215.6	73.73	210.0	72.26	203.2	70.17	188.7	66.88
	-9.5	-10	224.2	79.07	224.2	75.61	216.2	73.35	210.0	71.88	203.2	69.79	188.7	66.51
	-8.5	-9.1	229.7	77.68	228.1	74.32	216.7	72.09	210.0	70.62	203.2	68.56	188.7	65.31
	-7.0	-7.6	241.9	75.57	230.1	72.37	216.7	70.23	210.0	68.71	203.2	66.71	188.7	63.50
	-5.0	-5.6	244.5	72.76	230.1	69.78	216.7	67.74	210.0	66.19	203.2	64.25	188.7	61.10
	-3.0	-3.7	244.5	69.96	230.1	67.20	216.7	65.24	210.0	63.64	203.2	61.77	188.7	58.68
	0.0	-0.7	244.5	65.76	230.1	63.29	216.7	61.49	210.0	59.84	203.2	58.07	188.7	55.07
	3.0	2.2	244.5	61.54	230.1	59.39	216.7	57.75	210.0	56.04	203.2	54.38	188.7	51.44
	5.0	4.1	239.7	53.18	225.6	51.35	212.3	49.89	205.8	48.31	199.2	46.85	184.9	44.22
	7.0	6.0	233.6	49.79	219.9	48.24	206.8	46.95	200.5	45.36	194.1	44.00	180.4	41.49
	9.0	7.9	225.0	45.66	211.7	44.27	199.2	43.07	193.1	41.59	187.0	40.36	173.7	38.07
	11.0	9.8	212.9	41.71	200.2	40.42	188.4	39.32	182.7	38.00	176.8	36.87	164.1	34.75
	13.0	11.8	199.8	36.87	188.0	35.73	177.0	34.79	171.5	33.59	166.0	32.59	154.2	30.73
15.0	13.7	189.0	33.08	177.9	32.07	167.5	31.21	162.2	30.15	157.1	29.25	146.0	27.58	
80	-24.8	-25	139.9	68.63	139.9	70.45	139.0	71.72	139.0	72.32	139.0	75.34	137.3	72.16
	-21.8	-22	170.0	70.45	170.0	72.25	170.0	73.52	170.0	75.34	170.0	72.16	166.8	69.09
	-19.8	-20	180.1	71.65	180.1	73.46	180.1	75.34	180.1	73.10	178.7	70.03	168.6	67.06
	-18.8	-19	184.3	72.25	184.3	75.34	184.3	74.20	184.3	71.97	179.8	68.96	168.6	66.04
	-16.7	-17	191.7	75.34	191.7	72.97	191.7	71.82	187.2	69.62	181.3	66.76	168.6	63.91
	-13.7	-15	202.6	71.84	198.6	69.58	193.8	68.42	188.0	66.25	181.3	63.56	168.6	60.84
	-11.8	-13	207.6	69.61	201.5	67.44	193.8	66.25	188.0	64.12	181.3	61.55	168.6	58.90
	-9.8	-11	212.7	67.27	204.2	65.20	193.8	63.98	188.0	61.89	181.3	59.42	168.6	56.86
	-9.5	-10	214.2	66.93	205.4	64.85	193.8	63.63	188.0	61.54	181.3	59.10	168.6	56.56
	-8.5	-9.1	216.6	65.76	206.5	63.73	193.8	62.50	188.0	60.42	181.3	58.05	168.6	55.54
	-7.0	-7.6	219.0	64.00	206.5	62.03	193.8	60.80	188.0	58.74	181.3	56.47	168.6	54.00
	-5.0	-5.6	219.0	61.67	206.5	59.79	193.8	58.52	188.0	56.48	181.3	54.33	168.6	51.96
	-3.0	-3.7	219.0	59.33	206.5	57.53	193.8	56.25	188.0	54.25	181.3	52.22	168.6	49.92
	0.0	-0.7	219.0	55.81	206.5	54.16	193.8	52.85	188.0	50.89	181.3	49.02	168.6	46.87
	3.0	2.2	219.0	52.31	206.5	50.76	193.8	49.43	188.0	47.50	181.3	45.85	168.6	43.80
	5.0	4.1	214.6	45.18	202.4	43.81	189.9	42.60	184.2	40.86	177.5	39.44	165.4	37.67
	7.0	6.0	209.1	42.39	197.3	41.18	185.1	39.95	179.5	38.29	173.0	37.03	161.0	35.35
	9.0	7.9	201.5	37.80	189.9	36.75	178.3	35.84	173.0	34.46	166.7	33.23	155.2	31.66
	11.0	9.8	190.6	33.44	179.5	32.52	168.6	31.71	163.5	30.48	157.8	29.40	146.6	28.00
	13.0	11.8	178.9	28.91	168.6	28.10	158.4	27.41	153.6	26.34	148.1	25.40	137.7	24.20
15.0	13.7	169.2	25.93	159.7	25.19	149.8	24.57	145.3	23.62	140.2	22.79	130.3	21.71	

# 7. Capacity Tables

Heating Capacity (76HP)

Combination (%)	Outdoor air temp.		Indoor air temp. °C DB											
			16		18		20		21		22		24	
	°C DB	°C WB	TC	PI	TC	PI	TC	PI	TC	PI	TC	PI	TC	PI
70	-24.8	-25	139.9	69.60	139.9	70.20	139.0	71.42	139.0	73.24	139.0	69.79	137.2	66.56
	-21.8	-22	164.8	71.42	165.1	72.02	164.0	73.24	159.3	69.79	154.6	66.56	144.3	63.45
	-19.8	-20	179.4	72.63	174.2	73.24	165.0	70.82	159.3	67.50	154.6	64.42	144.3	61.38
	-18.8	-19	183.1	73.24	175.1	71.99	165.0	69.61	159.3	66.34	154.6	63.34	144.3	60.32
	-16.7	-17	185.4	70.64	175.3	69.36	165.0	67.09	159.3	63.93	154.6	61.09	144.3	58.15
	-13.7	-15	185.7	66.96	175.3	65.63	165.0	63.46	159.3	60.50	154.6	57.87	144.3	55.02
	-11.8	-13	185.7	64.60	175.3	63.26	165.0	61.16	159.3	58.30	154.6	55.82	144.3	53.05
	-9.8	-11	185.7	62.15	175.3	60.76	165.0	58.76	159.3	56.00	154.6	53.67	144.3	50.97
	-9.5	-10	185.7	61.78	175.3	60.38	165.0	58.40	159.3	55.67	154.6	53.36	144.3	50.66
	-8.5	-9.1	185.7	60.56	175.3	59.14	165.0	57.18	159.3	54.52	154.6	52.28	144.3	49.61
	-7.0	-7.6	185.7	58.70	175.3	57.28	165.0	55.38	159.3	52.80	154.6	50.67	144.3	48.06
	-5.0	-5.6	185.7	56.24	175.3	54.79	165.0	52.96	159.3	50.51	154.6	48.52	144.3	45.98
	-3.0	-3.7	185.7	53.79	175.3	52.28	165.0	50.54	159.3	48.21	154.6	46.37	144.3	43.89
	0.0	-0.7	185.7	50.10	175.3	48.55	165.0	46.93	159.3	44.76	154.6	43.15	144.3	40.78
	3.0	2.2	185.7	46.40	175.3	44.81	165.0	43.30	159.3	41.34	154.6	39.92	144.3	37.65
	5.0	4.1	185.7	40.60	171.8	38.25	161.6	36.96	156.1	35.24	151.5	34.11	141.5	32.13
	7.0	6.0	185.9	38.77	167.3	35.44	157.5	34.24	152.1	32.70	147.6	31.71	137.7	29.81
	9.0	7.9	179.1	33.44	161.3	30.55	151.7	29.53	146.6	28.19	142.2	27.33	132.6	25.70
	11.0	9.8	169.5	29.53	152.7	26.98	143.5	26.09	138.6	24.90	134.5	24.16	125.5	22.71
	13.0	11.8	159.1	25.75	143.4	23.55	134.8	22.76	130.1	21.72	126.3	21.06	117.9	19.80
15.0	13.7	150.4	22.82	135.5	20.85	127.5	20.16	123.1	19.24	119.5	18.66	111.5	17.54	
60	-24.8	-25	139.3	68.38	139.3	69.60	138.4	71.42	135.4	67.78	131.7	64.37	123.6	61.15
	-21.8	-22	151.2	70.20	150.8	71.42	141.5	67.78	136.7	64.37	132.0	61.15	123.6	58.05
	-19.8	-20	159.3	71.42	150.8	68.85	141.5	65.35	136.7	62.10	132.0	59.00	123.6	55.97
	-18.8	-19	159.3	70.13	150.8	67.56	141.5	64.13	136.7	60.94	132.0	57.93	123.6	54.92
	-16.7	-17	159.3	67.41	150.8	64.86	141.5	61.59	136.7	58.55	132.0	55.69	123.6	52.74
	-13.7	-15	159.3	63.52	150.8	61.03	141.5	57.96	136.7	55.14	132.0	52.48	123.6	49.64
	-11.8	-13	159.3	61.08	150.8	58.58	141.5	55.64	136.7	52.97	132.0	50.45	123.6	47.68
	-9.8	-11	159.3	58.50	150.8	56.02	141.5	53.22	136.7	50.70	132.0	48.30	123.6	45.59
	-9.5	-10	159.3	58.10	150.8	55.65	141.5	52.86	136.7	50.36	132.0	47.97	123.6	45.28
	-8.5	-9.1	159.3	56.82	150.8	54.36	141.5	51.65	136.7	49.23	132.0	46.89	123.6	44.25
	-7.0	-7.6	159.3	54.89	150.8	52.43	141.5	49.84	136.7	47.51	132.0	45.29	123.6	42.69
	-5.0	-5.6	159.3	52.30	150.8	49.86	141.5	47.40	136.7	45.24	132.0	43.15	123.6	40.62
	-3.0	-3.7	159.3	49.72	150.8	47.29	141.5	44.98	136.7	42.97	132.0	41.01	123.6	38.54
	0.0	-0.7	159.3	45.84	150.8	43.45	141.5	41.36	136.7	39.54	132.0	37.79	123.6	35.43
	3.0	2.2	159.3	41.96	150.8	39.60	141.5	37.71	136.7	36.14	132.0	34.59	123.6	32.31
	5.0	4.1	156.1	35.64	147.9	33.50	138.6	31.89	133.9	30.60	129.3	29.32	121.1	27.34
	7.0	6.0	152.1	32.75	144.1	30.68	135.1	29.25	130.6	28.11	126.1	26.96	117.9	25.07
	9.0	7.9	146.6	27.95	138.7	26.16	130.1	24.95	125.9	23.97	121.4	23.01	113.7	21.38
	11.0	9.8	138.6	24.68	131.2	23.11	123.0	22.03	118.9	21.18	114.7	20.31	107.5	18.88
	13.0	11.8	130.1	21.51	123.3	20.15	115.6	19.19	111.6	18.46	107.8	17.70	101.0	16.48
15.0	13.7	123.1	19.24	116.6	18.00	109.4	17.00	105.8	16.36	102.0	15.69	95.5	14.72	
50	-24.8	-25	132.9	60.73	125.3	62.55	117.9	59.27	114.1	56.20	110.3	53.29	102.7	50.60
	-21.8	-22	132.9	62.55	125.3	59.27	117.9	56.20	114.1	53.29	110.3	50.60	102.7	48.00
	-19.8	-20	132.9	60.26	125.3	57.08	117.9	54.16	114.1	51.35	110.3	48.79	102.7	46.25
	-18.8	-19	132.9	59.12	125.3	55.98	117.9	53.14	114.1	50.40	110.3	47.88	102.7	45.38
	-16.7	-17	132.9	56.73	125.3	53.70	117.9	51.00	114.1	48.37	110.3	46.00	102.7	43.56
	-13.7	-15	132.9	53.31	125.3	50.41	117.9	47.93	114.1	45.46	110.3	43.30	102.7	40.96
	-11.8	-13	132.9	51.15	125.3	48.34	117.9	45.98	114.1	43.62	110.3	41.59	102.7	39.31
	-9.8	-11	132.9	48.86	125.3	46.15	117.9	43.93	114.1	41.68	110.3	39.78	102.7	37.56
	-9.5	-10	132.9	48.52	125.3	45.83	117.9	43.64	114.1	41.40	110.3	39.52	102.7	37.31
	-8.5	-9.1	132.9	47.36	125.3	44.73	117.9	42.61	114.1	40.43	110.3	38.62	102.7	36.44
	-7.0	-7.6	132.9	45.66	125.3	43.11	117.9	41.08	114.1	38.99	110.3	37.27	102.7	35.15
	-5.0	-5.6	132.9	43.37	125.3	40.92	117.9	39.04	114.1	37.04	110.3	35.45	102.7	33.41
	-3.0	-3.7	132.9	41.09	125.3	38.73	117.9	36.98	114.1	35.11	110.3	33.64	102.7	31.68
	0.0	-0.7	132.9	37.67	125.3	35.43	117.9	33.92	114.1	32.20	110.3	30.95	102.7	29.06
	3.0	2.2	132.9	34.26	125.3	32.17	117.9	30.86	114.1	29.29	110.3	28.25	102.7	26.46
	5.0	4.1	130.3	28.93	123.0	27.10	115.4	26.05	111.8	24.75	108.1	23.90	100.7	22.36
	7.0	6.0	126.9	26.43	119.8	24.73	112.6	23.83	109.0	22.62	105.4	21.94	98.2	20.45
	9.0	7.9	122.3	22.77	115.4	21.32	108.4	20.54	104.9	19.52	101.4	18.91	94.6	17.64
	11.0	9.8	116.3	20.35	109.6	19.05	102.9	18.35	99.1	17.43	95.9	16.88	89.5	15.75
	13.0	11.8	108.6	17.55	102.4	16.44	96.3	15.83	93.1	15.13	90.2	14.58	83.9	13.68
15.0	13.7	102.7	15.73	96.9	14.73	91.1	14.18	88.3	13.49	85.3	13.06	79.4	12.18	

**Note**

1. TC: Total Capacity(kW), PI : Power Input(kW, Comp. + Outdoor fan motor)
2. Capacity tables show the average value of conditions which may occur.
3. The heating capacity table is based on the values expressed as Max. in the specification of the outdoor unit. (When measuring the Max. heating capacity, the setting status of the indoor unit is the same as that for measuring the heating capacity of the indoor unit.)

# 7. Capacity Tables

## ◆ ARUM780LTE5

Heating Capacity (78HP)

Combination (%)	Outdoor air temp.		Indoor air temp. °C DB											
			16		18		20		21		22		24	
	°C DB	°C WB	TC	PI	TC	PI	TC	PI	TC	PI	TC	PI	TC	PI
130	-24.8	-25	152.0	80.5	152.0	81.23	151.0	81.88	151.0	82.85	151.0	83.82	148.6	85.32
	-21.8	-22	184.6	81.97	184.6	82.71	183.3	83.36	183.3	84.35	183.3	85.32	180.2	86.79
	-19.8	-20	194.5	82.96	194.5	83.71	193.2	84.35	193.2	85.36	193.2	86.29	190.0	87.79
	-18.8	-19	198.9	83.46	198.9	84.21	197.6	84.86	197.6	85.85	197.6	86.79	194.2	88.29
	-16.7	-17	207.9	84.51	207.9	85.25	206.5	85.90	206.5	86.89	206.5	87.85	203.0	89.33
	-13.7	-15	220.7	86.00	220.7	86.75	219.3	87.40	219.3	88.39	219.3	89.33	215.6	85.85
	-11.8	-13	227.8	86.96	227.8	87.68	226.5	88.33	226.5	89.33	226.5	86.99	223.5	83.64
	-9.8	-11	235.4	87.93	235.4	88.69	234.0	89.33	234.0	86.83	234.0	84.52	231.6	81.33
	-9.5	-10	236.7	88.11	236.7	88.83	235.4	88.95	235.4	86.44	235.0	84.15	232.9	80.96
	-8.5	-9.1	241.5	88.58	241.5	89.33	240.2	87.65	240.2	85.18	238.9	82.91	236.9	79.80
	-7.0	-7.6	248.7	89.33	248.7	87.43	247.1	85.72	247.1	83.29	247.1	81.03	243.6	78.06
	-5.0	-5.6	258.3	86.86	258.3	84.89	256.6	83.13	256.6	80.77	256.6	78.56	251.8	75.74
	-3.0	-3.7	267.8	84.38	267.8	82.36	266.1	80.54	266.1	78.24	266.1	76.09	260.2	73.41
	0.0	-0.7	282.0	80.65	282.0	78.55	280.2	76.68	280.2	74.47	280.2	72.38	272.6	69.93
	3.0	2.2	296.4	76.94	296.4	74.72	294.4	72.79	294.4	70.69	292.9	68.64	274.5	66.45
	5.0	4.1	299.8	67.67	299.2	65.52	297.4	63.65	296.2	61.72	288.9	59.84	268.9	57.90
	7.0	6.0	299.5	64.04	298.9	61.99	297.2	60.19	291.8	58.44	281.5	56.69	262.1	55.00
9.0	7.9	289.6	59.47	288.9	57.54	288.2	55.86	281.0	54.24	271.3	52.62	252.6	51.06	
11.0	9.8	273.9	55.59	273.3	53.81	272.6	52.23	265.7	50.71	256.5	49.22	238.8	47.73	
13.0	11.8	257.2	50.96	256.8	49.32	255.9	47.88	249.6	46.49	240.9	45.11	224.2	43.74	
15.0	13.7	243.4	47.07	242.8	45.54	242.1	44.23	236.2	42.94	228.0	41.66	212.1	40.40	
120	-24.8	-25	151.0	81.23	151.0	81.88	150.0	82.85	150.0	83.82	150.0	85.32	147.6	86.36
	-21.8	-22	183.3	82.71	183.3	83.36	182.0	84.35	182.0	85.32	182.0	86.79	179.1	87.85
	-19.8	-20	193.1	83.71	193.1	84.35	191.8	85.36	191.8	86.29	191.8	87.79	188.7	88.83
	-18.8	-19	197.3	84.21	197.3	84.86	196.0	85.85	196.0	86.79	196.0	88.29	192.9	89.33
	-16.7	-17	206.3	85.25	206.3	85.90	205.0	86.89	205.0	87.85	205.0	89.33	201.5	87.09
	-13.7	-15	219.0	86.75	219.0	87.40	217.7	88.39	217.7	89.33	217.7	85.98	214.0	83.89
	-11.8	-13	226.2	87.68	226.2	88.33	224.8	89.33	224.8	86.96	224.8	83.86	221.9	81.87
	-9.8	-11	233.7	88.69	233.7	89.33	232.4	86.71	232.4	84.46	232.4	81.63	230.0	79.73
	-9.5	-10	235.1	88.83	235.1	88.91	233.8	86.33	233.8	84.09	233.8	81.30	231.4	79.40
	-8.5	-9.1	239.9	89.33	239.9	87.52	238.3	85.01	238.3	82.84	238.1	80.20	235.5	78.34
	-7.0	-7.6	247.0	87.26	247.0	85.45	245.4	83.06	245.4	80.97	244.8	78.52	241.9	76.73
	-5.0	-5.6	256.5	84.49	256.5	82.67	254.9	80.44	254.9	78.46	254.9	76.27	250.2	74.59
	-3.0	-3.7	265.9	81.72	265.9	79.92	264.2	77.81	264.2	75.99	264.2	74.05	257.0	72.45
	0.0	-0.7	280.1	77.57	280.1	75.75	278.2	73.89	278.2	72.23	277.0	70.70	257.8	69.25
	3.0	2.2	294.2	73.42	294.2	71.59	291.5	69.97	286.3	68.49	277.4	67.35	257.8	66.05
	5.0	4.1	297.8	64.14	296.4	62.41	290.2	60.99	280.7	59.69	271.9	58.79	252.6	57.64
	7.0	6.0	297.7	60.41	294.5	58.78	283.0	57.61	273.5	56.51	265.0	55.98	246.1	54.98
9.0	7.9	287.6	55.94	283.7	54.41	272.6	53.34	263.4	52.32	255.2	51.81	237.2	50.89	
11.0	9.8	271.9	52.15	268.3	50.72	257.8	49.71	249.0	48.77	241.4	48.31	224.2	47.46	
13.0	11.8	255.5	47.63	252.0	46.33	242.1	45.42	234.0	44.55	226.8	44.13	210.6	43.34	
15.0	13.7	241.8	43.82	238.5	42.62	229.0	41.78	221.4	41.00	214.6	40.61	199.3	39.88	
110	-24.8	-25	150.2	81.88	150.2	82.85	149.3	83.82	149.3	85.32	149.3	86.36	146.7	86.85
	-21.8	-22	182.4	83.36	182.4	84.35	181.1	85.32	181.1	86.79	181.1	87.85	178.2	88.33
	-19.8	-20	192.1	84.35	192.1	85.36	190.9	86.29	190.9	87.79	190.9	88.83	187.6	89.33
	-18.8	-19	196.3	84.86	196.3	85.85	195.0	86.79	195.0	88.29	195.0	89.33	191.8	88.15
	-16.7	-17	205.2	85.90	205.2	86.89	203.9	87.85	203.9	89.33	203.9	86.92	200.4	85.67
	-13.7	-15	217.8	87.40	217.8	88.39	216.4	89.33	216.4	85.67	216.4	83.45	216.4	82.14
	-11.8	-13	225.0	88.33	225.0	89.33	223.5	86.74	223.5	83.34	223.5	81.26	223.5	79.90
	-9.8	-11	232.4	89.33	232.4	86.41	231.1	84.03	231.1	80.90	231.1	78.96	229.8	77.55
	-9.5	-10	233.8	88.85	233.8	85.96	232.5	83.60	232.5	80.53	232.5	78.62	231.7	77.20
	-8.5	-9.1	238.6	87.28	238.6	84.50	237.2	82.24	237.2	79.30	237.2	77.44	232.0	76.00
	-7.0	-7.6	245.7	84.89	245.7	82.31	244.1	80.20	244.1	77.47	244.1	75.73	232.0	74.25
	-5.0	-5.6	255.0	81.74	255.0	79.36	253.3	77.48	253.3	75.03	248.3	73.42	232.0	71.87
	-3.0	-3.7	264.4	78.57	264.4	76.44	262.7	74.73	257.2	72.57	248.3	71.10	232.0	69.53
	0.0	-0.7	278.5	73.82	278.1	72.05	265.7	70.65	257.2	68.91	248.3	67.66	232.0	66.00
	3.0	2.2	292.1	69.07	283.3	67.65	265.7	66.55	257.2	65.26	248.3	64.18	232.0	62.45
	5.0	4.1	293.8	59.81	277.5	58.64	260.5	57.75	252.0	56.73	243.5	55.85	227.4	54.22
	7.0	6.0	286.2	55.83	270.6	55.00	253.9	54.38	245.7	53.72	237.2	53.03	221.6	51.38
9.0	7.9	275.8	51.42	260.5	50.65	244.4	50.08	236.6	49.47	228.6	48.85	213.4	47.33	
11.0	9.8	260.7	47.66	246.4	46.94	231.3	46.41	223.8	45.86	216.2	45.26	201.9	43.86	
13.0	11.8	244.8	43.27	231.4	42.60	217.3	42.12	210.1	41.60	202.9	41.08	189.5	39.82	
15.0	13.7	231.6	39.48	218.9	38.89	205.5	38.44	198.7	37.99	192.1	37.50	179.3	36.33	

# 7. Capacity Tables

Heating Capacity (78HP)

Combination (%)	Outdoor air temp.		Indoor air temp. °C DB											
			16		18		20		21		22		24	
	°C DB	°C WB	TC	PI	TC	PI	TC	PI	TC	PI	TC	PI	TC	PI
100	-24.8	-25	149.5	89.83	149.5	89.77	148.6	84.64	148.6	89.60	148.6	89.54	146.0	89.51
	-21.8	-22	181.4	89.73	181.4	89.67	180.4	87.32	180.4	89.50	180.4	90.54	177.2	89.41
	-19.8	-20	191.2	89.67	191.2	89.59	190.1	89.00	190.1	89.44	190.1	89.74	187.0	89.33
	-18.8	-19	195.4	89.64	194.3	89.57	194.3	89.50	194.3	89.39	194.3	89.33	190.9	87.90
	-16.7	-17	203.0	89.57	203.0	89.50	203.0	90.54	202.0	89.33	202.0	86.37	198.5	84.90
	-13.7	-15	216.8	89.47	216.8	89.39	215.5	89.33	215.5	85.03	215.5	82.14	212.0	80.58
	-11.8	-13	223.9	89.41	222.6	89.33	222.6	86.44	222.6	82.29	222.6	79.44	212.0	77.86
	-9.8	-11	231.1	89.33	231.1	86.09	230.2	83.39	230.2	79.43	227.5	76.63	212.0	74.99
	-9.5	-10	232.5	88.82	232.5	85.59	231.5	82.94	231.5	78.99	227.5	76.20	212.0	74.56
	-8.5	-9.1	237.3	87.12	237.3	83.98	236.2	81.41	235.3	77.55	227.5	74.79	212.0	73.12
	-7.0	-7.6	248.3	84.57	247.4	81.54	243.1	79.12	235.3	75.42	227.5	72.68	212.0	70.96
	-5.0	-5.6	259.2	81.16	256.6	78.31	243.1	76.09	235.3	72.53	227.5	69.85	212.0	68.09
	-3.0	-3.7	266.7	77.76	258.7	75.05	243.1	73.04	235.3	69.65	227.5	67.04	212.0	65.22
	0.0	-0.7	274.2	72.66	258.7	70.19	243.1	68.47	235.3	65.35	227.5	62.79	212.0	60.92
	3.0	2.2	274.2	67.54	258.7	65.31	243.1	63.90	235.3	61.05	227.5	58.56	212.0	56.62
	5.0	4.1	268.7	58.25	253.5	56.29	238.2	55.10	230.7	52.61	223.1	50.35	207.8	48.56
	7.0	6.0	261.8	54.05	247.0	52.35	232.2	51.44	224.7	49.22	217.3	47.10	202.5	45.29
	9.0	7.9	252.2	49.35	237.9	47.79	223.8	46.97	216.6	44.93	209.4	42.98	195.0	41.33
	11.0	9.8	238.5	45.26	225.1	43.82	211.4	43.07	204.8	41.20	198.0	39.42	184.5	37.91
	13.0	11.8	224.1	40.56	211.4	39.28	198.6	38.60	192.3	36.94	185.9	35.34	173.1	33.98
15.0	13.7	212.0	36.50	199.9	35.35	187.8	34.73	181.9	33.22	175.9	31.79	163.9	30.58	
90	-24.8	-25	148.9	80.33	148.9	81.81	148.0	82.87	148.0	83.35	148.0	84.35	145.6	85.85
	-21.8	-22	180.7	81.81	180.7	83.31	179.7	84.35	179.7	84.85	179.7	85.85	176.5	82.11
	-19.8	-20	190.5	82.81	190.5	84.30	189.2	85.34	189.2	85.85	189.2	83.28	186.1	79.62
	-18.8	-19	195.4	83.31	194.3	84.81	193.4	85.85	193.4	84.54	193.4	82.01	190.2	78.39
	-16.7	-17	203.0	84.35	203.0	85.85	202.2	83.12	202.2	81.76	202.2	79.34	193.7	75.77
	-13.7	-15	216.8	85.85	216.8	81.78	214.8	79.23	214.8	77.82	208.7	75.50	193.7	72.03
	-11.8	-13	223.9	83.05	222.6	79.21	221.7	76.75	215.6	75.31	208.7	73.08	193.7	69.67
	-9.8	-11	231.1	80.14	231.1	76.52	222.5	74.16	215.6	72.67	208.7	70.52	193.7	67.18
	-9.5	-10	232.5	79.68	232.5	76.10	222.5	73.77	215.6	72.28	208.7	70.13	193.7	66.80
	-8.5	-9.1	237.3	78.23	235.6	74.76	222.5	72.46	215.6	70.96	208.7	68.86	193.7	65.55
	-7.0	-7.6	248.3	76.02	236.2	72.72	222.5	70.52	215.6	68.98	208.7	66.94	193.7	63.68
	-5.0	-5.6	251.0	73.09	236.2	70.02	222.5	67.94	215.6	66.37	208.7	64.39	193.7	61.21
	-3.0	-3.7	251.0	70.16	236.2	67.33	222.5	65.33	215.6	63.72	208.7	61.82	193.7	58.71
	0.0	-0.7	251.0	65.77	236.2	63.26	222.5	61.43	215.6	59.78	208.7	58.00	193.7	54.98
	3.0	2.2	251.0	61.36	236.2	59.19	222.5	57.54	215.6	55.83	208.7	54.18	193.7	51.24
	5.0	4.1	246.1	52.92	231.6	51.08	217.9	49.62	211.3	48.06	204.5	46.59	189.8	43.97
	7.0	6.0	239.8	49.40	225.7	47.87	212.3	46.58	205.8	45.01	199.3	43.66	185.2	41.17
	9.0	7.9	231.0	45.09	217.3	43.71	204.5	42.52	198.2	41.07	192.0	39.85	178.3	37.59
	11.0	9.8	218.6	40.95	205.5	39.68	193.4	38.61	187.5	37.31	181.5	36.20	168.5	34.11
	13.0	11.8	205.1	35.95	193.0	34.85	181.7	33.93	176.1	32.76	170.4	31.78	158.3	29.97
15.0	13.7	194.1	32.01	182.6	31.02	172.0	30.19	166.6	29.17	161.3	28.29	149.8	26.68	
80	-24.8	-25	148.2	70.60	148.2	72.10	147.3	73.14	147.3	73.64	147.3	76.12	144.9	72.84
	-21.8	-22	178.8	72.10	178.8	73.58	178.8	74.62	178.8	76.12	178.8	72.84	173.1	69.68
	-19.8	-20	188.5	73.08	188.5	74.57	188.5	76.12	188.5	73.80	185.9	70.64	173.1	67.58
	-18.8	-19	192.7	73.58	192.7	76.12	192.7	74.94	192.2	72.64	186.1	69.54	173.1	66.54
	-16.7	-17	198.9	76.12	198.9	73.66	198.9	72.47	193.0	70.21	186.1	67.26	173.1	64.34
	-13.7	-15	208.0	72.48	203.9	70.14	198.9	68.94	193.0	66.72	186.1	63.96	173.1	61.18
	-11.8	-13	213.5	70.15	207.2	67.91	198.9	66.69	193.0	64.51	186.1	61.88	173.1	59.17
	-9.8	-11	219.1	67.72	210.0	65.58	198.9	64.34	193.0	62.20	186.1	59.68	173.1	57.07
	-9.5	-10	220.6	67.36	211.2	65.22	198.9	63.98	193.0	61.85	186.1	59.35	173.1	56.77
	-8.5	-9.1	222.8	66.15	212.0	64.05	198.9	62.81	193.0	60.68	186.1	58.27	173.1	55.71
	-7.0	-7.6	224.8	64.31	212.0	62.29	198.9	61.04	193.0	58.95	186.1	56.63	173.1	54.13
	-5.0	-5.6	224.8	61.88	212.0	59.96	198.9	58.68	193.0	56.61	186.1	54.42	173.1	52.03
	-3.0	-3.7	224.8	59.45	212.0	57.61	198.9	56.32	193.0	54.31	186.1	52.25	173.1	49.92
	0.0	-0.7	224.8	55.78	212.0	54.11	198.9	52.80	193.0	50.82	186.1	48.94	173.1	46.78
	3.0	2.2	224.8	52.14	212.0	50.58	198.9	49.25	193.0	47.32	186.1	45.66	173.1	43.62
	5.0	4.1	220.3	44.94	207.7	43.58	195.0	42.37	189.1	40.64	182.2	39.22	169.8	37.46
	7.0	6.0	214.7	42.06	202.5	40.86	190.0	39.64	184.3	38.00	177.6	36.74	165.3	35.08
	9.0	7.9	206.8	37.30	195.0	36.27	183.0	35.37	177.6	34.02	171.1	32.80	159.3	31.25
	11.0	9.8	195.6	32.81	184.3	31.91	173.1	31.12	167.9	29.92	162.0	28.86	150.5	27.48
	13.0	11.8	183.6	28.18	173.1	27.39	162.6	26.72	157.7	25.68	152.1	24.77	141.4	23.60
15.0	13.7	173.7	25.07	163.9	24.36	153.8	23.77	149.2	22.84	143.9	22.04	133.8	20.99	

# 7. Capacity Tables

## Heating Capacity (78HP)

Combination (%)	Outdoor air temp.		Indoor air temp. °C DB											
			16		18		20		21		22		24	
	°C DB	°C WB	TC	PI	TC	PI	TC	PI	TC	PI	TC	PI	TC	PI
70	-24.8	-25	148.2	71.20	148.2	71.69	147.3	72.70	147.3	74.20	147.3	70.64	143.9	67.30
	-21.8	-22	170.5	72.70	170.5	73.19	169.4	74.20	163.6	70.64	158.7	67.30	148.1	64.09
	-19.8	-20	185.2	73.70	180.0	74.20	169.4	71.69	163.6	68.26	158.7	65.08	148.1	61.96
	-18.8	-19	189.2	74.20	180.0	72.90	169.4	70.43	163.6	67.07	158.7	63.97	148.1	60.87
	-16.7	-17	190.7	71.49	180.0	70.17	169.4	67.82	163.6	64.57	158.7	61.65	148.1	58.63
	-13.7	-15	190.7	67.67	180.0	66.30	169.4	64.06	163.6	61.02	158.7	58.32	148.1	55.41
	-11.8	-13	190.7	65.21	180.0	63.84	169.4	61.68	163.6	58.75	158.7	56.20	148.1	53.38
	-9.8	-11	190.7	62.67	180.0	61.25	169.4	59.20	163.6	56.38	158.7	53.99	148.1	51.24
	-9.5	-10	190.7	62.27	180.0	60.85	169.4	58.82	163.6	56.03	158.7	53.67	148.1	50.92
	-8.5	-9.1	190.7	61.01	180.0	59.57	169.4	57.56	163.6	54.84	158.7	52.55	148.1	49.84
	-7.0	-7.6	190.7	59.08	180.0	57.63	169.4	55.69	163.6	53.07	158.7	50.89	148.1	48.24
	-5.0	-5.6	190.7	56.52	180.0	55.05	169.4	53.19	163.6	50.69	158.7	48.66	148.1	46.09
	-3.0	-3.7	190.7	53.97	180.0	52.44	169.4	50.68	163.6	48.31	158.7	46.45	148.1	43.95
	0.0	-0.7	190.7	50.12	180.0	48.57	169.4	46.94	163.6	44.75	158.7	43.12	148.1	40.74
	3.0	2.2	190.7	46.28	180.0	44.69	169.4	43.18	163.6	41.21	158.7	39.79	148.1	37.52
	5.0	4.1	190.7	40.40	176.3	38.06	165.9	36.79	160.3	35.06	155.5	33.93	145.2	31.96
	7.0	6.0	190.8	38.47	171.8	35.16	161.7	33.98	156.1	32.44	151.6	31.46	141.4	29.58
	9.0	7.9	183.9	33.02	165.6	30.16	155.7	29.16	150.5	27.84	146.0	26.99	136.2	25.38
	11.0	9.8	174.0	28.99	156.7	26.49	147.3	25.62	142.3	24.45	138.1	23.72	128.8	22.29
	13.0	11.8	163.3	25.11	147.2	22.97	138.4	22.19	133.6	21.19	129.6	20.54	121.0	19.31
15.0	13.7	154.4	22.08	139.1	20.17	130.9	19.50	126.4	18.61	122.7	18.06	114.5	16.97	
60	-24.8	-25	145.4	70.19	145.4	71.20	144.5	72.70	140.3	68.91	135.5	65.37	126.9	62.04
	-21.8	-22	156.2	71.69	154.8	72.70	145.3	68.91	140.3	65.37	135.5	62.04	126.9	58.83
	-19.8	-20	163.6	72.70	154.8	70.02	145.3	66.39	140.3	63.01	135.5	59.81	126.9	56.68
	-18.8	-19	163.6	71.36	154.8	68.68	145.3	65.12	140.3	61.81	135.5	58.70	126.9	55.60
	-16.7	-17	163.6	68.51	154.8	65.87	145.3	62.48	140.3	59.34	135.5	56.38	126.9	53.35
	-13.7	-15	163.6	64.45	154.8	61.87	145.3	58.71	140.3	55.80	135.5	53.05	126.9	50.14
	-11.8	-13	163.6	61.89	154.8	59.33	145.3	56.29	140.3	53.54	135.5	50.95	126.9	48.12
	-9.8	-11	163.6	59.20	154.8	56.65	145.3	53.78	140.3	51.19	135.5	48.72	126.9	45.96
	-9.5	-10	163.6	58.78	154.8	56.27	145.3	53.40	140.3	50.83	135.5	48.38	126.9	45.64
	-8.5	-9.1	163.6	57.44	154.8	54.93	145.3	52.15	140.3	49.66	135.5	47.26	126.9	44.57
	-7.0	-7.6	163.6	55.42	154.8	52.92	145.3	50.26	140.3	47.88	135.5	45.60	126.9	42.96
	-5.0	-5.6	163.6	52.71	154.8	50.24	145.3	47.73	140.3	45.52	135.5	43.39	126.9	40.82
	-3.0	-3.7	163.6	50.02	154.8	47.56	145.3	45.21	140.3	43.16	135.5	41.16	126.9	38.67
	0.0	-0.7	163.6	45.96	154.8	43.56	145.3	41.44	140.3	39.60	135.5	37.83	126.9	35.46
	3.0	2.2	163.6	41.91	154.8	39.55	145.3	37.65	140.3	36.07	135.5	34.51	126.9	32.23
	5.0	4.1	160.3	35.50	151.8	33.37	142.3	31.76	137.5	30.46	132.8	29.19	124.3	27.22
	7.0	6.0	156.1	32.49	147.9	30.44	138.7	29.02	134.1	27.89	129.5	26.75	121.0	24.88
	9.0	7.9	150.5	27.60	142.4	25.83	133.6	24.64	129.2	23.67	124.7	22.72	116.7	21.11
	11.0	9.8	142.3	24.23	134.7	22.69	126.3	21.63	122.1	20.79	117.8	19.95	110.3	18.54
	13.0	11.8	133.6	20.98	126.6	19.65	118.7	18.72	114.5	18.01	110.6	17.26	103.7	16.07
15.0	13.7	126.4	18.61	119.7	17.42	112.3	16.44	108.6	15.82	104.7	15.18	98.1	14.25	
50	-24.8	-25	136.4	61.70	128.6	63.20	121.0	59.84	117.1	56.69	113.2	53.72	105.4	50.97
	-21.8	-22	136.4	63.20	128.6	59.84	121.0	56.69	117.1	53.72	113.2	50.97	105.4	48.32
	-19.8	-20	136.4	60.85	128.6	57.59	121.0	54.61	117.1	51.73	113.2	49.12	105.4	46.53
	-18.8	-19	136.4	59.67	128.6	56.46	121.0	53.56	117.1	50.77	113.2	48.20	105.4	45.65
	-16.7	-17	136.4	57.22	128.6	54.13	121.0	51.37	117.1	48.69	113.2	46.27	105.4	43.79
	-13.7	-15	136.4	53.71	128.6	50.75	121.0	48.23	117.1	45.72	113.2	43.51	105.4	41.14
	-11.8	-13	136.4	51.49	128.6	48.63	121.0	46.23	117.1	43.83	113.2	41.76	105.4	39.46
	-9.8	-11	136.4	49.14	128.6	46.39	121.0	44.13	117.1	41.85	113.2	39.91	105.4	37.67
	-9.5	-10	136.4	48.79	128.6	46.07	121.0	43.83	117.1	41.56	113.2	39.65	105.4	37.42
	-8.5	-9.1	136.4	47.60	128.6	44.94	121.0	42.78	117.1	40.57	113.2	38.73	105.4	36.53
	-7.0	-7.6	136.4	45.86	128.6	43.27	121.0	41.21	117.1	39.09	113.2	37.35	105.4	35.21
	-5.0	-5.6	136.4	43.51	128.6	41.03	121.0	39.13	117.1	37.11	113.2	35.50	105.4	33.44
	-3.0	-3.7	136.4	41.16	128.6	38.78	121.0	37.01	117.1	35.13	113.2	33.65	105.4	31.67
	0.0	-0.7	136.4	37.66	128.6	35.41	121.0	33.88	117.1	32.16	113.2	30.89	105.4	29.00
	3.0	2.2	136.4	34.15	128.6	32.07	121.0	30.75	117.1	29.18	113.2	28.14	105.4	26.35
	5.0	4.1	133.8	28.79	126.2	26.96	118.5	25.91	114.8	24.61	111.0	23.77	103.4	22.23
	7.0	6.0	130.3	26.23	123.0	24.54	115.5	23.64	111.9	22.45	108.2	21.77	100.8	20.29
	9.0	7.9	125.6	22.48	118.4	21.05	111.3	20.28	107.7	19.28	104.1	18.68	97.1	17.42
	11.0	9.8	119.4	19.98	112.6	18.71	105.7	18.02	101.8	17.11	98.5	16.58	91.9	15.46
	13.0	11.8	111.5	17.11	105.1	16.03	98.9	15.44	95.6	14.75	92.6	14.22	86.1	13.34
15.0	13.7	105.4	15.22	99.5	14.25	93.5	13.72	90.6	13.05	87.6	12.63	81.5	11.78	

**Note**

1. TC: Total Capacity(kW), PI: Power Input(kW, Comp. + Outdoor fan motor)
2. Capacity tables show the average value of conditions which may occur.
3. The heating capacity table is based on the values expressed as Max. in the specification of the outdoor unit. (When measuring the Max. heating capacity, the setting status of the indoor unit is the same as that for measuring the heating capacity of the indoor unit.)



# 7. Capacity Tables

## ◆ ARUM800LTE5

Heating Capacity (80HP)

Combination (%)	Outdoor air temp.		Indoor air temp. °C DB											
			16		18		20		21		22		24	
	°C DB	°C WB	TC	PI	TC	PI	TC	PI	TC	PI	TC	PI	TC	PI
130	-24.8	-25	154.2	84.1	154.2	84.79	153.2	85.40	153.2	86.31	153.2	87.22	150.8	88.62
	-21.8	-22	188.4	85.48	188.4	86.18	187.1	86.79	187.1	87.72	187.1	88.62	183.9	90.00
	-19.8	-20	199.1	86.41	199.1	87.12	197.7	87.72	197.7	88.66	197.7	89.53	194.5	90.94
	-18.8	-19	203.6	86.88	203.6	87.58	202.3	88.19	202.3	89.12	202.3	90.00	198.8	91.40
	-16.7	-17	213.0	87.86	213.0	88.56	211.7	89.17	211.7	90.10	211.7	90.99	208.1	92.38
	-13.7	-15	226.4	89.27	226.4	89.96	225.1	90.57	225.1	91.50	225.1	92.38	221.2	88.89
	-11.8	-13	233.8	90.16	233.8	90.84	232.4	91.45	232.4	92.38	232.4	93.04	229.5	86.67
	-9.8	-11	241.5	91.07	241.5	91.78	240.1	92.38	240.1	93.04	240.1	93.75	237.9	84.35
	-9.5	-10	242.9	91.24	242.9	91.91	241.5	92.00	241.5	92.69	241.5	93.38	239.2	83.98
	-8.5	-9.1	247.8	91.68	247.8	92.38	246.4	93.04	246.4	93.75	246.4	94.46	243.5	82.81
	-7.0	-7.6	255.2	92.38	255.2	93.04	253.8	93.75	253.8	94.46	253.8	95.18	250.4	81.07
	-5.0	-5.6	264.9	89.96	264.9	88.00	263.2	86.23	263.2	83.85	263.2	81.61	259.0	78.74
	-3.0	-3.7	274.7	87.54	274.7	85.50	273.0	83.66	273.0	81.33	273.0	79.13	267.7	76.39
	0.0	-0.7	289.2	83.89	289.2	81.75	287.4	79.82	287.4	77.57	287.4	75.42	280.7	72.90
	3.0	2.2	303.9	80.26	303.9	77.97	301.9	75.97	301.9	73.80	300.4	71.68	281.6	69.41
	5.0	4.1	307.4	70.72	306.8	68.48	304.9	66.54	303.7	64.52	296.4	62.58	275.9	60.56
	7.0	6.0	307.1	67.09	306.5	64.93	304.8	63.06	299.4	61.22	288.8	59.39	268.9	57.62
	9.0	7.9	297.1	62.44	296.4	60.42	295.7	58.66	288.3	56.95	278.3	55.26	259.1	53.62
	11.0	9.8	281.0	58.54	280.3	56.66	279.6	54.99	272.6	53.39	263.2	51.82	245.0	50.26
	13.0	11.8	263.9	53.82	263.4	52.09	262.5	50.57	256.1	49.10	247.1	47.64	230.0	46.20
15.0	13.7	249.7	49.89	249.1	48.27	248.3	46.88	242.3	45.51	233.9	44.16	217.6	42.82	
120	-24.8	-25	153.2	84.79	153.2	85.40	152.1	86.31	152.1	87.22	152.1	88.62	149.7	89.60
	-21.8	-22	187.1	86.18	187.1	86.79	185.8	87.72	185.8	88.62	185.8	90.00	182.8	90.99
	-19.8	-20	197.7	87.12	197.7	87.72	196.4	88.66	196.4	89.53	196.4	90.94	193.1	91.91
	-18.8	-19	202.1	87.58	202.1	88.19	200.8	89.12	200.8	90.00	200.8	91.40	197.5	92.38
	-16.7	-17	211.5	88.56	211.5	89.17	210.1	90.10	210.1	90.99	210.1	92.38	206.5	90.13
	-13.7	-15	224.7	89.96	224.7	90.57	223.4	91.50	223.4	92.38	223.4	93.04	219.6	86.92
	-11.8	-13	232.1	90.84	232.1	91.45	230.7	92.38	230.7	93.04	230.7	93.75	227.8	84.89
	-9.8	-11	239.8	91.78	239.8	92.38	238.4	89.77	238.4	87.51	238.4	84.67	236.3	82.74
	-9.5	-10	241.3	91.91	241.3	91.97	239.9	89.39	239.9	87.13	239.9	84.33	237.7	82.41
	-8.5	-9.1	246.1	92.38	246.1	90.58	244.5	88.07	244.5	85.89	244.5	83.23	242.0	81.34
	-7.0	-7.6	253.4	90.33	253.4	88.51	251.8	86.12	251.8	84.01	251.8	81.55	248.6	79.73
	-5.0	-5.6	263.2	87.58	263.2	85.75	261.4	83.50	261.4	81.50	261.4	79.30	257.4	77.58
	-3.0	-3.7	272.7	84.83	272.7	83.01	271.0	80.88	271.0	79.02	271.0	77.07	264.5	75.43
	0.0	-0.7	287.2	80.72	287.2	78.86	285.3	76.96	285.3	75.26	284.1	73.71	264.5	72.22
	3.0	2.2	301.7	76.60	301.7	74.71	299.0	73.04	293.7	71.52	284.6	70.36	264.5	69.01
	5.0	4.1	305.4	67.03	303.9	65.24	297.7	63.77	287.9	62.41	279.0	61.49	259.2	60.29
	7.0	6.0	305.3	63.28	302.1	61.58	290.3	60.35	280.6	59.20	271.9	58.65	252.5	57.59
	9.0	7.9	295.0	58.73	291.0	57.13	279.6	56.01	270.3	54.94	261.9	54.40	243.3	53.43
	11.0	9.8	279.0	54.89	275.2	53.38	264.5	52.33	255.5	51.33	247.7	50.86	230.0	49.95
	13.0	11.8	262.1	50.28	258.5	48.91	248.3	47.95	240.0	47.03	232.7	46.59	216.1	45.76
15.0	13.7	248.0	46.41	244.7	45.14	234.9	44.26	227.2	43.43	220.2	43.02	204.4	42.25	
110	-24.8	-25	152.4	85.40	152.4	86.31	151.4	87.22	151.4	88.62	151.4	89.60	148.8	90.06
	-21.8	-22	186.1	86.79	186.1	87.72	184.8	88.62	184.8	90.00	184.8	90.99	181.8	91.45
	-19.8	-20	196.6	87.72	196.6	88.66	195.4	89.53	195.4	90.94	195.4	91.91	192.0	92.38
	-18.8	-19	201.0	88.19	201.0	89.12	199.7	90.00	199.7	91.40	199.7	92.38	196.4	91.19
	-16.7	-17	210.4	89.17	210.4	90.10	209.0	90.99	209.0	92.38	209.0	93.75	205.4	88.69
	-13.7	-15	223.5	90.57	223.5	91.50	222.0	92.38	222.0	93.04	222.0	93.75	219.6	85.12
	-11.8	-13	230.8	91.45	230.8	92.38	229.4	89.78	229.4	86.36	229.4	84.25	229.4	82.86
	-9.8	-11	238.5	92.38	238.5	89.45	237.1	87.05	237.1	83.90	237.1	81.94	236.1	80.48
	-9.5	-10	239.9	91.90	239.9	88.99	238.6	86.62	238.6	83.53	238.6	81.60	237.7	80.13
	-8.5	-9.1	244.8	90.33	244.8	87.53	243.3	85.26	243.3	82.29	243.3	80.41	238.0	78.93
	-7.0	-7.6	252.1	87.93	252.1	85.33	250.5	83.20	250.5	80.45	250.5	78.68	238.0	77.16
	-5.0	-5.6	261.6	84.77	261.6	82.37	259.9	80.47	259.9	78.00	254.8	76.36	238.0	74.76
	-3.0	-3.7	271.2	81.60	271.2	79.44	269.4	77.71	263.8	75.52	254.8	74.02	238.0	72.39
	0.0	-0.7	285.6	76.83	285.2	75.03	272.6	73.61	263.8	71.83	254.8	70.55	238.0	68.82
	3.0	2.2	299.5	72.07	290.6	70.61	272.6	69.48	263.8	68.16	254.8	67.05	238.0	65.24
	5.0	4.1	301.4	62.51	284.7	61.30	267.2	60.38	258.5	59.33	249.8	58.41	233.3	56.71
	7.0	6.0	293.7	58.49	277.6	57.62	260.5	56.97	252.0	56.27	243.4	55.56	227.3	53.82
	9.0	7.9	282.9	53.99	267.2	53.18	250.8	52.57	242.7	51.94	234.5	51.29	218.9	49.69
	11.0	9.8	267.5	50.16	252.8	49.40	237.3	48.85	229.6	48.27	221.8	47.64	207.1	46.16
	13.0	11.8	251.1	45.67	237.4	44.97	222.9	44.45	215.5	43.91	208.2	43.36	194.4	42.03
15.0	13.7	237.6	41.81	224.5	41.18	210.9	40.71	203.8	40.23	197.1	39.71	184.0	38.48	

# 7. Capacity Tables

Heating Capacity (80HP)

Combination (%)	Outdoor air temp.		Indoor air temp. °C DB											
			16		18		20		21		22		24	
	°C DB	°C WB	TC	PI	TC	PI	TC	PI	TC	PI	TC	PI	TC	PI
100	-24.8	-25	151.7	94.65	151.7	94.36	150.8	88.16	150.8	93.61	150.8	93.30	148.1	93.15
	-21.8	-22	185.1	94.20	185.1	93.90	184.1	90.94	184.1	93.16	184.1	94.13	180.8	92.70
	-19.8	-20	195.7	93.90	195.7	93.58	194.6	92.68	194.6	92.86	194.6	92.97	191.3	92.38
	-18.8	-19	200.1	93.75	199.0	93.45	199.0	93.16	199.0	92.69	199.0	92.38	195.5	90.93
	-16.7	-17	208.1	93.44	208.1	93.13	208.1	94.13	207.0	92.38	207.0	89.38	203.4	87.88
	-13.7	-15	222.4	92.98	222.4	92.67	221.1	92.38	221.1	88.03	221.1	85.08	217.5	83.49
	-11.8	-13	229.7	92.70	228.4	92.38	228.4	89.47	228.4	85.26	228.4	82.35	217.5	80.72
	-9.8	-11	237.2	92.38	237.2	89.12	236.2	86.39	236.2	82.36	233.4	79.49	217.5	77.80
	-9.5	-10	238.6	91.87	238.6	88.61	237.5	85.93	237.5	81.92	233.4	79.06	217.5	77.37
	-8.5	-9.1	243.5	90.16	243.5	86.99	242.4	84.39	241.4	80.46	233.4	77.63	217.5	75.90
	-7.0	-7.6	254.8	87.60	253.8	84.53	249.4	82.07	241.4	78.29	233.4	75.48	217.5	73.71
	-5.0	-5.6	265.9	84.16	263.2	81.27	249.4	79.01	241.4	75.37	233.4	72.62	217.5	70.80
	-3.0	-3.7	273.6	80.75	265.4	77.99	249.4	75.94	241.4	72.46	233.4	69.76	217.5	67.88
	0.0	-0.7	281.3	75.61	265.4	73.09	249.4	71.32	241.4	68.11	233.4	65.45	217.5	63.51
	3.0	2.2	281.3	70.46	265.4	68.17	249.4	66.71	241.4	63.75	233.4	61.16	217.5	59.14
	5.0	4.1	275.6	60.87	260.1	58.84	244.3	57.61	236.7	55.01	228.9	52.66	213.1	50.78
	7.0	6.0	268.6	56.62	253.4	54.85	238.3	53.88	230.5	51.56	222.9	49.34	207.8	47.44
	9.0	7.9	258.8	51.98	244.1	50.34	229.6	49.47	222.2	47.32	214.9	45.27	200.0	43.53
	11.0	9.8	244.7	47.97	230.9	46.44	216.9	45.65	210.1	43.66	203.1	41.78	189.3	40.18
	13.0	11.8	229.9	43.31	216.9	41.95	203.8	41.22	197.3	39.44	190.7	37.74	177.6	36.28
15.0	13.7	217.5	39.32	205.1	38.08	192.7	37.42	186.6	35.79	180.5	34.24	168.2	32.94	
90	-24.8	-25	151.1	84.08	151.1	85.46	150.1	86.46	150.1	86.90	150.1	87.85	147.7	89.25
	-21.8	-22	184.4	85.46	184.4	86.87	183.4	87.85	183.4	88.31	183.4	89.25	180.1	85.40
	-19.8	-20	195.0	86.41	195.0	87.80	193.7	88.78	193.7	89.25	193.7	86.61	190.5	82.84
	-18.8	-19	200.1	86.87	199.0	88.28	198.1	89.25	198.1	87.90	198.1	85.30	194.8	81.56
	-16.7	-17	208.1	87.85	208.1	89.25	207.3	86.45	207.3	85.05	207.3	82.55	198.7	78.86
	-13.7	-15	222.4	89.25	222.4	85.07	220.4	82.45	220.4	81.00	214.1	78.60	198.7	75.02
	-11.8	-13	229.7	86.38	228.4	82.44	227.5	79.90	221.2	78.42	214.1	76.11	198.7	72.58
	-9.8	-11	237.2	83.40	237.2	79.68	228.2	77.25	221.2	75.70	214.1	73.48	198.7	70.01
	-9.5	-10	238.6	82.93	238.6	79.24	228.2	76.84	221.2	75.29	214.1	73.08	198.7	69.62
	-8.5	-9.1	243.5	81.44	241.7	77.87	228.2	75.50	221.2	73.95	214.1	71.77	198.7	68.34
	-7.0	-7.6	254.8	79.18	242.3	75.78	228.2	73.51	221.2	71.91	214.1	69.79	198.7	66.41
	-5.0	-5.6	257.5	76.17	242.3	73.01	228.2	70.85	221.2	69.22	214.1	67.17	198.7	63.87
	-3.0	-3.7	257.5	73.17	242.3	70.24	228.2	68.17	221.2	66.50	214.1	64.53	198.7	61.29
	0.0	-0.7	257.5	68.67	242.3	66.06	228.2	64.17	221.2	62.44	214.1	60.59	198.7	57.45
	3.0	2.2	257.5	64.15	242.3	61.90	228.2	60.17	221.2	58.39	214.1	56.66	198.7	53.59
	5.0	4.1	252.5	55.37	237.6	53.46	223.6	51.93	216.7	50.29	209.8	48.76	194.7	46.02
	7.0	6.0	246.0	51.75	231.6	50.15	217.8	48.80	211.1	47.15	204.4	45.74	190.0	43.12
	9.0	7.9	237.0	47.49	222.9	46.04	209.8	44.79	203.4	43.26	196.9	41.97	182.9	39.59
	11.0	9.8	224.2	43.41	210.9	42.06	198.4	40.92	192.4	39.54	186.2	38.36	172.9	36.16
	13.0	11.8	210.5	38.39	198.0	37.21	186.4	36.23	180.6	34.98	174.9	33.94	162.4	32.00
15.0	13.7	199.1	34.48	187.3	33.42	176.5	32.53	170.9	31.42	165.5	30.48	153.7	28.74	
80	-24.8	-25	150.4	73.96	150.4	75.37	149.5	76.35	149.5	76.81	149.5	79.14	147.0	75.76
	-21.8	-22	182.4	75.37	182.4	76.76	182.4	77.73	182.4	79.14	182.4	75.76	177.6	72.50
	-19.8	-20	193.0	76.29	193.0	77.69	193.0	79.14	193.0	76.75	190.7	73.49	177.6	70.33
	-18.8	-19	197.4	76.76	197.4	79.14	197.4	77.92	197.2	75.55	190.9	72.36	177.6	69.26
	-16.7	-17	204.1	79.14	204.1	76.61	204.1	75.38	198.0	73.05	190.9	70.01	177.6	66.99
	-13.7	-15	213.4	75.40	209.2	72.99	204.1	71.75	198.0	69.46	190.9	66.61	177.6	63.73
	-11.8	-13	218.7	73.01	212.3	70.70	204.1	69.44	198.0	67.19	190.9	64.47	177.6	61.66
	-9.8	-11	224.5	70.51	215.3	68.31	204.1	67.02	198.0	64.81	190.9	62.21	177.6	59.50
	-9.5	-10	226.1	70.14	216.5	67.94	204.1	66.65	198.0	64.45	190.9	61.87	177.6	59.18
	-8.5	-9.1	228.4	68.90	217.5	66.74	204.1	65.45	198.0	63.24	190.9	60.75	177.6	58.10
	-7.0	-7.6	230.7	67.02	217.5	64.92	204.1	63.63	198.0	61.46	190.9	59.06	177.6	56.46
	-5.0	-5.6	230.7	64.52	217.5	62.54	204.1	61.20	198.0	59.06	190.9	56.78	177.6	54.30
	-3.0	-3.7	230.7	62.02	217.5	60.12	204.1	58.78	198.0	56.68	190.9	54.54	177.6	52.12
	0.0	-0.7	230.7	58.26	217.5	56.52	204.1	55.15	198.0	53.10	190.9	51.14	177.6	48.88
	3.0	2.2	230.7	54.52	217.5	52.89	204.1	51.50	198.0	49.49	190.9	47.76	177.6	45.63
	5.0	4.1	226.0	47.03	213.1	45.61	200.0	44.34	194.0	42.53	186.9	41.05	174.2	39.21
	7.0	6.0	220.2	44.06	207.7	42.80	194.9	41.53	189.1	39.81	182.2	38.49	169.5	36.75
	9.0	7.9	212.2	39.34	200.0	38.24	187.7	37.29	182.2	35.86	175.6	34.58	163.5	32.94
	11.0	9.8	200.7	34.82	189.1	33.86	177.6	33.02	172.2	31.74	166.1	30.62	154.4	29.15
	13.0	11.8	188.4	30.13	177.6	29.28	166.8	28.56	161.8	27.45	156.0	26.47	145.1	25.22
15.0	13.7	178.2	27.04	168.2	26.27	157.8	25.63	153.1	24.63	147.7	23.76	137.3	22.63	

# 7. Capacity Tables

Heating Capacity (80HP)

Combination (%)	Outdoor air temp.		Indoor air temp. °C DB											
			16		18		20		21		22		24	
	°C DB	°C WB	TC	PI	TC	PI	TC	PI	TC	PI	TC	PI	TC	PI
70	-24.8	-25	150.4	74.33	150.4	74.80	149.5	75.74	149.5	77.14	149.5	73.47	146.9	70.02
	-21.8	-22	174.9	75.74	174.9	76.20	173.8	77.14	167.8	73.47	162.8	70.02	152.0	66.71
	-19.8	-20	191.2	76.68	184.7	77.14	173.8	74.56	167.8	71.02	162.8	67.74	152.0	64.50
	-18.8	-19	195.4	77.14	184.7	75.81	173.8	73.26	167.8	69.78	162.8	66.58	152.0	63.38
	-16.7	-17	195.6	74.36	184.7	72.99	173.8	70.57	167.8	67.21	162.8	64.19	152.0	61.06
	-13.7	-15	195.6	70.42	184.7	69.00	173.8	66.69	167.8	63.55	162.8	60.75	152.0	57.73
	-11.8	-13	195.6	67.89	184.7	66.47	173.8	64.24	167.8	61.20	162.8	58.56	152.0	55.64
	-9.8	-11	195.6	65.27	184.7	63.79	173.8	61.67	167.8	58.75	162.8	56.28	152.0	53.42
	-9.5	-10	195.6	64.86	184.7	63.39	173.8	61.28	167.8	58.39	162.8	55.95	152.0	53.09
	-8.5	-9.1	195.6	63.56	184.7	62.06	173.8	59.99	167.8	57.16	162.8	54.79	152.0	51.98
	-7.0	-7.6	195.6	61.57	184.7	60.07	173.8	58.06	167.8	55.34	162.8	53.07	152.0	50.32
	-5.0	-5.6	195.6	58.94	184.7	57.40	173.8	55.47	167.8	52.88	162.8	50.78	152.0	48.11
	-3.0	-3.7	195.6	56.31	184.7	54.72	173.8	52.89	167.8	50.43	162.8	48.49	152.0	45.89
	0.0	-0.7	195.6	52.35	184.7	50.73	173.8	49.03	167.8	46.76	162.8	45.05	152.0	42.58
	3.0	2.2	195.6	48.39	184.7	46.73	173.8	45.15	167.8	43.10	162.8	41.62	152.0	39.24
	5.0	4.1	195.6	42.28	180.9	39.83	170.2	38.49	164.4	36.69	159.5	35.52	149.0	33.46
	7.0	6.0	195.8	40.30	176.3	36.84	165.9	35.60	160.2	33.99	155.5	32.96	145.1	30.99
	9.0	7.9	188.7	34.78	169.9	31.77	159.8	30.71	154.4	29.32	149.7	28.43	139.7	26.73
	11.0	9.8	178.5	30.73	160.8	28.08	151.1	27.15	146.0	25.91	141.7	25.14	132.2	23.63
	13.0	11.8	167.5	26.82	151.0	24.53	142.0	23.70	137.0	22.62	133.0	21.94	124.2	20.62
15.0	13.7	158.4	23.78	142.7	21.73	134.3	21.01	129.7	20.05	125.9	19.45	117.5	18.29	
60	-24.8	-25	149.2	73.32	149.2	74.26	148.2	75.67	144.0	71.75	139.0	68.08	130.2	64.63
	-21.8	-22	160.3	74.73	158.8	75.67	149.0	71.75	144.0	68.08	139.0	64.63	130.2	61.30
	-19.8	-20	167.8	75.67	158.8	72.90	149.0	69.14	144.0	65.64	139.0	62.32	130.2	59.07
	-18.8	-19	167.8	74.28	158.8	71.52	149.0	67.83	144.0	64.40	139.0	61.17	130.2	57.95
	-16.7	-17	167.8	71.34	158.8	68.60	149.0	65.09	144.0	61.83	139.0	58.77	130.2	55.62
	-13.7	-15	167.8	67.14	158.8	64.47	149.0	61.18	144.0	58.17	139.0	55.31	130.2	52.29
	-11.8	-13	167.8	64.50	158.8	61.83	149.0	58.68	144.0	55.83	139.0	53.13	130.2	50.19
	-9.8	-11	167.8	61.71	158.8	59.06	149.0	56.08	144.0	53.39	139.0	50.83	130.2	47.95
	-9.5	-10	167.8	61.28	158.8	58.66	149.0	55.69	144.0	53.02	139.0	50.47	130.2	47.62
	-8.5	-9.1	167.8	59.89	158.8	57.28	149.0	54.39	144.0	51.81	139.0	49.32	130.2	46.51
	-7.0	-7.6	167.8	57.81	158.8	55.20	149.0	52.44	144.0	49.96	139.0	47.60	130.2	44.84
	-5.0	-5.6	167.8	55.00	158.8	52.43	149.0	49.82	144.0	47.52	139.0	45.30	130.2	42.62
	-3.0	-3.7	167.8	52.22	158.8	49.66	149.0	47.21	144.0	45.08	139.0	42.99	130.2	40.39
	0.0	-0.7	167.8	48.02	158.8	45.51	149.0	43.31	144.0	41.39	139.0	39.54	130.2	37.07
	3.0	2.2	167.8	43.83	158.8	41.36	149.0	39.38	144.0	37.73	139.0	36.10	130.2	33.72
	5.0	4.1	164.4	37.15	155.7	34.92	146.0	33.24	141.0	31.89	136.2	30.55	127.5	28.49
	7.0	6.0	160.2	34.04	151.7	31.89	142.3	30.41	137.5	29.22	132.8	28.02	124.2	26.06
	9.0	7.9	154.4	29.07	146.1	27.21	137.0	25.95	132.6	24.93	127.9	23.93	119.7	22.24
	11.0	9.8	146.0	25.68	138.2	24.05	129.5	22.93	125.2	22.04	120.9	21.14	113.2	19.65
	13.0	11.8	137.0	22.40	129.9	20.98	121.7	19.99	117.5	19.23	113.5	18.43	106.3	17.16
15.0	13.7	129.7	20.05	122.8	18.77	115.2	17.72	111.4	17.05	107.4	16.35	100.6	15.35	
50	-24.8	-25	140.0	64.30	132.0	65.70	124.2	62.23	120.2	58.98	116.1	55.91	108.1	53.06
	-21.8	-22	140.0	65.70	132.0	62.23	124.2	58.98	120.2	55.91	116.1	53.06	108.1	50.31
	-19.8	-20	140.0	63.28	132.0	59.91	124.2	56.82	120.2	53.85	116.1	51.14	108.1	48.46
	-18.8	-19	140.0	62.06	132.0	58.74	124.2	55.74	120.2	52.85	116.1	50.19	108.1	47.55
	-16.7	-17	140.0	59.53	132.0	56.33	124.2	53.48	120.2	50.69	116.1	48.19	108.1	45.63
	-13.7	-15	140.0	55.91	132.0	52.84	124.2	50.22	120.2	47.62	116.1	45.34	108.1	42.88
	-11.8	-13	140.0	53.61	132.0	50.65	124.2	48.17	120.2	45.67	116.1	43.53	108.1	41.14
	-9.8	-11	140.0	51.19	132.0	48.33	124.2	45.99	120.2	43.62	116.1	41.61	108.1	39.29
	-9.5	-10	140.0	50.82	132.0	48.00	124.2	45.68	120.2	43.32	116.1	41.35	108.1	39.02
	-8.5	-9.1	140.0	49.60	132.0	46.83	124.2	44.60	120.2	42.30	116.1	40.39	108.1	38.10
	-7.0	-7.6	140.0	47.79	132.0	45.11	124.2	42.97	120.2	40.77	116.1	38.96	108.1	36.74
	-5.0	-5.6	140.0	45.37	132.0	42.79	124.2	40.82	120.2	38.72	116.1	37.05	108.1	34.90
	-3.0	-3.7	140.0	42.95	132.0	40.47	124.2	38.63	120.2	36.67	116.1	35.13	108.1	33.07
	0.0	-0.7	140.0	39.33	132.0	36.98	124.2	35.39	120.2	33.60	116.1	32.28	108.1	30.31
	3.0	2.2	140.0	35.70	132.0	33.53	124.2	32.16	120.2	30.52	116.1	29.43	108.1	27.56
	5.0	4.1	137.3	30.12	129.5	28.22	121.5	27.12	117.7	25.76	113.9	24.88	106.1	23.27
	7.0	6.0	133.7	27.47	126.2	25.71	118.5	24.77	114.8	23.52	111.0	22.80	103.4	21.26
	9.0	7.9	128.8	23.68	121.5	22.17	114.1	21.36	110.5	20.30	106.8	19.67	99.7	18.35
	11.0	9.8	122.5	21.18	115.5	19.83	108.4	19.10	104.4	18.14	101.0	17.57	94.3	16.39
	13.0	11.8	114.4	18.27	107.9	17.12	101.4	16.48	98.1	15.75	95.0	15.18	88.3	14.24
15.0	13.7	108.1	16.40	102.1	15.35	95.9	14.78	93.0	14.06	89.9	13.61	83.6	12.69	

**Note**

1. TC: Total Capacity(kW), PI : Power Input(kW, Comp. + Outdoor fan motor)
2. Capacity tables show the average value of conditions which may occur.
3. The heating capacity table is based on the values expressed as Max. in the specification of the outdoor unit. (When measuring the Max. heating capacity, the setting status of the indoor unit is the same as that for measuring the heating capacity of the indoor unit.)

# 7. Capacity Tables

## ◆ ARUM820LTE5

Heating Capacity (82HP)

Combination (%)	Outdoor air temp.		Indoor air temp. °C DB											
			16		18		20		21		22		24	
	°C DB	°C WB	TC	PI	TC	PI	TC	PI	TC	PI	TC	PI	TC	PI
130	-24.8	-25	158.1	87.1	158.1	87.76	157.2	88.38	157.2	89.31	157.2	90.23	154.6	91.66
	-21.8	-22	193.2	88.46	193.2	89.17	191.9	89.79	191.9	90.74	191.9	91.66	188.6	93.06
	-19.8	-20	204.1	89.41	204.1	90.13	202.7	90.74	202.7	91.69	202.7	92.59	199.4	94.02
	-18.8	-19	208.8	89.89	208.8	90.60	207.4	91.22	207.4	92.17	207.4	93.06	203.9	94.49
	-16.7	-17	218.4	90.88	218.4	91.59	217.0	92.21	217.0	93.16	217.0	94.07	213.3	95.48
	-13.7	-15	232.1	92.31	232.1	93.02	230.7	93.64	230.7	94.59	230.7	95.48	226.7	91.88
	-11.8	-13	239.7	93.23	239.7	93.92	238.3	94.54	238.3	95.48	238.3	93.07	235.3	89.59
	-9.8	-11	247.7	94.15	247.7	94.87	246.1	95.48	246.1	92.92	246.1	90.52	243.9	87.19
	-9.5	-10	249.1	94.32	249.1	95.01	247.6	95.09	247.6	92.52	247.3	90.13	245.3	86.81
	-8.5	-9.1	254.1	94.77	254.1	95.48	252.6	93.77	252.6	91.21	251.4	88.85	249.6	85.61
	-7.0	-7.6	261.6	95.48	261.6	93.56	259.9	91.79	259.9	89.28	259.9	86.92	256.7	83.81
	-5.0	-5.6	271.6	92.99	271.6	90.97	269.8	89.14	269.8	86.68	269.8	84.36	265.6	81.40
	-3.0	-3.7	281.6	90.50	281.6	88.39	279.8	86.49	279.8	84.08	279.8	81.81	274.5	78.98
	0.0	-0.7	296.5	86.73	296.5	84.52	294.6	82.53	294.6	80.20	294.6	77.97	287.8	75.38
	3.0	2.2	311.5	82.99	311.5	80.62	309.5	78.55	309.5	76.32	308.0	74.12	288.7	71.78
	5.0	4.1	315.1	73.13	314.5	70.82	312.5	68.81	311.3	66.73	303.9	64.71	282.9	62.62
	7.0	6.0	314.9	69.38	314.2	67.15	312.5	65.21	307.0	63.31	296.1	61.42	275.7	59.59
9.0	7.9	304.6	64.59	303.9	62.50	303.1	60.67	295.6	58.91	285.3	57.16	265.7	55.45	
11.0	9.8	288.1	60.55	287.4	58.60	286.7	56.89	279.5	55.23	269.8	53.61	251.2	51.98	
13.0	11.8	270.5	55.68	270.1	53.89	269.2	52.32	262.5	50.80	253.4	49.29	235.8	47.80	
15.0	13.7	256.0	51.62	255.4	49.95	254.6	48.50	248.4	47.09	239.8	45.69	223.1	44.31	
120	-24.8	-25	157.1	87.76	157.1	88.38	156.1	89.31	156.1	90.23	156.1	91.66	153.5	92.65
	-21.8	-22	191.8	89.17	191.8	89.79	190.5	90.74	190.5	91.66	190.5	93.06	187.4	94.07
	-19.8	-20	202.7	90.13	202.7	90.74	201.3	91.69	201.3	92.59	201.3	94.02	198.0	95.01
	-18.8	-19	207.2	90.60	207.2	91.22	205.8	92.17	205.8	93.06	205.8	94.49	202.5	95.48
	-16.7	-17	216.8	91.59	216.8	92.21	215.4	93.16	215.4	94.07	215.4	95.48	211.7	93.17
	-13.7	-15	230.4	93.02	230.4	93.64	229.0	94.59	229.0	95.48	229.0	92.02	225.1	89.85
	-11.8	-13	237.9	93.92	237.9	94.54	236.5	95.48	236.5	93.04	236.5	89.83	233.5	87.75
	-9.8	-11	245.9	94.87	245.9	95.48	244.5	92.79	244.5	90.46	244.5	87.53	242.3	85.53
	-9.5	-10	247.4	95.01	247.4	95.06	246.0	92.40	246.0	90.07	246.0	87.18	243.7	85.19
	-8.5	-9.1	252.4	95.48	252.4	93.63	250.6	91.04	250.6	88.79	250.6	86.04	248.1	84.09
	-7.0	-7.6	259.8	93.37	259.8	91.50	258.2	89.02	258.2	86.85	258.0	84.30	254.9	82.43
	-5.0	-5.6	269.8	90.53	269.8	88.64	268.0	86.32	268.0	84.26	268.0	81.98	263.8	80.21
	-3.0	-3.7	279.6	87.70	279.6	85.81	277.8	83.62	277.8	81.70	277.8	79.68	271.2	77.99
	0.0	-0.7	294.4	83.45	294.4	81.53	292.4	79.57	292.4	77.82	291.2	76.21	271.2	74.67
	3.0	2.2	309.2	79.21	309.2	77.25	306.5	75.52	301.1	73.95	291.8	72.75	271.2	71.36
	5.0	4.1	313.0	69.32	311.6	67.47	305.3	65.94	295.2	64.54	286.0	63.58	265.7	62.34
	7.0	6.0	312.9	65.45	309.8	63.68	297.7	62.42	287.7	61.23	278.7	60.65	258.9	59.56
9.0	7.9	302.5	60.74	298.4	59.09	286.7	57.93	277.1	56.82	268.5	56.27	249.5	55.27	
11.0	9.8	286.0	56.78	282.2	55.22	271.2	54.13	261.9	53.10	253.9	52.60	235.8	51.67	
13.0	11.8	268.7	52.02	265.0	50.60	254.6	49.61	246.1	48.65	238.5	48.20	221.5	47.34	
15.0	13.7	254.3	48.02	250.9	46.71	240.9	45.79	232.9	44.93	225.7	44.51	209.6	43.71	
110	-24.8	-25	156.3	88.38	156.3	89.31	155.3	90.23	155.3	91.66	155.3	92.65	152.6	93.13
	-21.8	-22	190.8	89.79	190.8	90.74	189.5	91.66	189.5	93.06	189.5	94.07	186.4	94.54
	-19.8	-20	201.6	90.74	201.6	91.69	200.4	92.59	200.4	94.02	200.4	95.01	196.9	95.48
	-18.8	-19	206.1	91.22	206.1	92.17	204.7	93.06	204.7	94.49	204.7	95.48	201.4	94.26
	-16.7	-17	215.7	92.21	215.7	93.16	214.3	94.07	214.3	95.48	214.3	92.98	210.6	91.67
	-13.7	-15	229.1	93.64	229.1	94.59	227.7	95.48	227.7	91.69	227.7	89.37	227.7	87.99
	-11.8	-13	236.7	94.54	236.7	95.48	235.2	92.80	235.2	89.27	235.2	87.09	235.2	85.66
	-9.8	-11	244.5	95.48	244.5	92.46	243.1	89.99	243.1	86.73	243.1	84.70	242.0	83.20
	-9.5	-10	246.0	94.99	246.0	91.99	244.6	89.54	244.6	86.34	244.6	84.35	243.7	82.84
	-8.5	-9.1	251.0	93.37	251.0	90.48	249.5	88.13	249.5	85.07	249.5	83.13	244.0	81.60
	-7.0	-7.6	258.4	90.90	258.4	88.21	256.8	86.01	256.8	83.17	256.8	81.34	244.0	79.77
	-5.0	-5.6	268.2	87.63	268.2	85.15	266.4	83.19	266.4	80.64	261.2	78.94	244.0	77.29
	-3.0	-3.7	278.1	84.35	278.1	82.13	276.2	80.34	270.5	78.08	261.2	76.53	244.0	74.84
	0.0	-0.7	292.8	79.43	292.4	77.57	279.5	76.10	270.5	74.27	261.2	72.95	244.0	71.16
	3.0	2.2	307.1	74.52	297.9	73.01	279.5	71.85	270.5	70.48	261.2	69.33	244.0	67.46
	5.0	4.1	309.0	64.64	291.9	63.39	274.0	62.44	265.0	61.35	256.1	60.40	239.2	58.64
	7.0	6.0	301.1	60.49	284.6	59.59	267.1	58.92	258.4	58.19	249.5	57.46	233.1	55.66
9.0	7.9	290.1	55.84	274.0	55.00	257.1	54.38	248.8	53.72	240.5	53.04	224.4	51.39	
11.0	9.8	274.2	51.89	259.1	51.10	243.3	50.53	235.4	49.93	227.4	49.28	212.3	47.75	
13.0	11.8	257.5	47.24	243.4	46.52	228.5	45.99	221.0	45.43	213.5	44.86	199.3	43.48	
15.0	13.7	243.6	43.26	230.2	42.61	216.2	42.12	209.0	41.62	202.0	41.09	188.6	39.81	

# 7. Capacity Tables

Heating Capacity (82HP)

Combination (%)	Outdoor air temp.		Indoor air temp. °C DB											
			16		18		20		21		22		24	
	°C DB	°C WB	TC	PI	TC	PI	TC	PI	TC	PI	TC	PI	TC	PI
100	-24.8	-25	155.6	97.92	155.6	97.60	154.6	91.16	154.6	96.81	154.6	96.47	151.9	96.31
	-21.8	-22	189.8	97.44	189.8	97.12	188.8	94.04	188.8	96.32	188.8	97.31	185.4	95.82
	-19.8	-20	200.7	97.12	200.7	96.78	199.5	95.84	199.5	96.00	199.5	96.10	196.2	95.48
	-18.8	-19	205.1	96.96	204.0	96.63	204.0	96.32	204.0	95.82	204.0	95.48	200.4	93.99
	-16.7	-17	213.4	96.62	213.4	96.29	213.4	97.31	212.2	95.48	212.2	92.39	208.5	90.83
	-13.7	-15	228.0	96.13	228.0	95.79	226.7	95.48	226.7	90.99	226.7	87.95	223.0	86.30
	-11.8	-13	235.5	95.82	234.2	95.48	234.2	92.48	234.2	88.13	234.2	85.13	223.0	83.45
	-9.8	-11	243.2	95.48	243.2	92.11	242.1	89.30	242.1	85.13	239.3	82.18	223.0	80.43
	-9.5	-10	244.6	94.96	244.6	91.60	243.5	88.82	243.5	84.68	239.3	81.72	223.0	79.98
	-8.5	-9.1	249.6	93.19	249.6	89.92	248.5	87.23	247.5	83.18	239.3	80.25	223.0	78.47
	-7.0	-7.6	261.2	90.55	260.2	87.38	255.7	84.84	247.5	80.94	239.3	78.03	223.0	76.21
	-5.0	-5.6	272.6	87.00	269.9	84.01	255.7	81.68	247.5	77.92	239.3	75.08	223.0	73.19
	-3.0	-3.7	280.5	83.48	272.1	80.62	255.7	78.51	247.5	74.91	239.3	72.13	223.0	70.18
	0.0	-0.7	288.4	78.17	272.1	75.56	255.7	73.74	247.5	70.42	239.3	67.68	223.0	65.67
	3.0	2.2	288.4	72.86	272.1	70.49	255.7	68.98	247.5	65.92	239.3	63.24	223.0	61.15
	5.0	4.1	282.6	62.95	266.7	60.85	250.5	59.57	242.6	56.89	234.7	54.45	218.5	52.52
	7.0	6.0	275.4	58.55	259.8	56.72	244.3	55.73	236.4	53.32	228.5	51.02	213.0	49.06
	9.0	7.9	265.3	53.76	250.2	52.07	235.4	51.16	227.8	48.95	220.3	46.82	205.1	45.03
	11.0	9.8	250.9	49.63	236.7	48.05	222.4	47.22	215.4	45.17	208.2	43.22	194.1	41.57
	13.0	11.8	235.7	44.81	222.3	43.40	208.9	42.65	202.3	40.81	195.5	39.05	182.1	37.54
15.0	13.7	223.0	40.69	210.3	39.41	197.6	38.72	191.4	37.03	185.0	35.44	172.4	34.09	
90	-24.8	-25	154.9	87.00	154.9	88.41	154.0	89.42	154.0	89.88	154.0	90.83	151.5	92.27
	-21.8	-22	189.1	88.41	189.1	89.84	188.1	90.83	188.1	91.31	188.1	92.27	184.7	88.29
	-19.8	-20	199.9	89.37	199.9	90.79	198.6	91.78	198.6	92.27	198.6	89.54	195.3	85.64
	-18.8	-19	205.1	89.84	204.0	91.27	203.1	92.27	203.1	90.87	203.1	88.18	199.7	84.32
	-16.7	-17	213.4	90.83	213.4	92.27	212.5	89.37	212.5	87.93	212.5	85.34	203.7	81.53
	-13.7	-15	228.0	92.27	228.0	87.95	225.9	85.24	225.9	83.74	219.5	81.26	203.7	77.56
	-11.8	-13	235.5	89.30	234.2	85.23	233.3	82.61	226.7	81.07	219.5	78.69	203.7	75.04
	-9.8	-11	243.2	86.22	243.2	82.38	234.0	79.86	226.7	78.27	219.5	75.97	203.7	72.39
	-9.5	-10	244.6	85.74	244.6	81.93	234.0	79.45	226.7	77.85	219.5	75.55	203.7	71.98
	-8.5	-9.1	249.6	84.19	247.9	80.50	234.0	78.06	226.7	76.45	219.5	74.20	203.7	70.66
	-7.0	-7.6	261.2	81.86	248.5	78.35	234.0	76.00	226.7	74.35	219.5	72.16	203.7	68.67
	-5.0	-5.6	264.0	78.76	248.5	75.48	234.0	73.25	226.7	71.57	219.5	69.45	203.7	66.04
	-3.0	-3.7	264.0	75.65	248.5	72.63	234.0	70.49	226.7	68.76	219.5	66.72	203.7	63.37
	0.0	-0.7	264.0	71.01	248.5	68.31	234.0	66.35	226.7	64.57	219.5	62.65	203.7	59.41
	3.0	2.2	264.0	66.33	248.5	64.01	234.0	62.22	226.7	60.38	219.5	58.59	203.7	55.42
	5.0	4.1	258.8	57.26	243.6	55.28	229.2	53.70	222.2	52.01	215.1	50.43	199.6	47.59
	7.0	6.0	252.3	53.52	237.4	51.86	223.4	50.47	216.5	48.76	209.6	47.30	194.7	44.60
	9.0	7.9	243.0	49.12	228.6	47.62	215.1	46.33	208.5	44.74	201.9	43.41	187.5	40.95
	11.0	9.8	229.9	44.90	216.2	43.51	203.5	42.33	197.2	40.90	190.9	39.69	177.3	37.41
	13.0	11.8	215.8	39.72	203.0	38.50	191.1	37.48	185.2	36.19	179.3	35.11	166.5	33.11
15.0	13.7	204.1	35.69	192.1	34.59	180.9	33.66	175.2	32.52	169.7	31.55	157.6	29.75	
80	-24.8	-25	154.3	76.54	154.3	77.98	153.3	78.97	153.3	79.44	153.3	81.81	150.8	78.32
	-21.8	-22	187.1	77.98	187.1	79.39	187.1	80.38	187.1	81.81	187.1	78.32	182.0	74.95
	-19.8	-20	197.9	78.91	197.9	80.33	197.9	81.81	197.9	79.35	195.5	75.98	182.0	72.71
	-18.8	-19	202.3	79.39	202.3	81.81	202.3	80.55	202.2	78.10	195.7	74.80	182.0	71.60
	-16.7	-17	209.2	81.81	209.2	79.20	209.2	77.93	203.0	75.52	195.7	72.37	182.0	69.26
	-13.7	-15	218.8	77.94	214.4	75.46	209.2	74.18	203.0	71.81	195.7	68.86	182.0	65.89
	-11.8	-13	224.2	75.48	217.6	73.10	209.2	71.79	203.0	69.46	195.7	66.65	182.0	63.75
	-9.8	-11	230.2	72.90	220.8	70.62	209.2	69.29	203.0	67.01	195.7	64.31	182.0	61.52
	-9.5	-10	231.8	72.52	222.0	70.24	209.2	68.91	203.0	66.63	195.7	63.96	182.0	61.19
	-8.5	-9.1	234.2	71.23	223.0	69.00	209.2	67.67	203.0	65.39	195.7	62.81	182.0	60.07
	-7.0	-7.6	236.5	69.29	223.0	67.12	209.2	65.79	203.0	63.55	195.7	61.06	182.0	58.38
	-5.0	-5.6	236.5	66.71	223.0	64.66	209.2	63.28	203.0	61.06	195.7	58.71	182.0	56.14
	-3.0	-3.7	236.5	64.13	223.0	62.16	209.2	60.77	203.0	58.61	195.7	56.40	182.0	53.90
	0.0	-0.7	236.5	60.24	223.0	58.44	209.2	57.03	203.0	54.90	195.7	52.88	182.0	50.55
	3.0	2.2	236.5	56.38	223.0	54.69	209.2	53.26	203.0	51.18	195.7	49.39	182.0	47.18
	5.0	4.1	231.7	48.64	218.5	47.16	205.1	45.85	198.9	43.99	191.7	42.45	178.6	40.55
	7.0	6.0	225.8	45.57	213.0	44.26	199.9	42.95	193.8	41.17	186.8	39.80	173.8	38.00
	9.0	7.9	217.6	40.69	205.1	39.56	192.5	38.58	186.8	37.09	180.0	35.77	167.6	34.07
	11.0	9.8	205.8	36.03	193.9	35.03	182.0	34.16	176.6	32.84	170.3	31.67	158.3	30.16
	13.0	11.8	193.2	31.17	182.1	30.29	171.0	29.55	165.9	28.40	159.9	27.38	148.7	26.09
15.0	13.7	182.7	27.98	172.4	27.19	161.7	26.52	156.9	25.49	151.4	24.59	140.7	23.42	

# 7. Capacity Tables

Heating Capacity (82HP)

Combination (%)	Outdoor air temp.		Indoor air temp. °C DB											
			16		18		20		21		22		24	
	°C DB	°C WB	TC	PI	TC	PI	TC	PI	TC	PI	TC	PI	TC	PI
70	-24.8	-25	154.3	76.89	154.3	77.36	153.3	78.32	153.3	79.75	153.3	75.96	150.7	72.39
	-21.8	-22	179.3	78.32	179.3	78.80	178.2	79.75	172.0	75.96	167.0	72.39	155.8	68.97
	-19.8	-20	195.9	79.28	189.3	79.75	178.2	77.08	172.0	73.42	167.0	70.03	155.8	66.69
	-18.8	-19	200.4	79.75	189.3	78.37	178.2	75.74	172.0	72.15	167.0	68.84	155.8	65.53
	-16.7	-17	200.6	76.87	189.3	75.46	178.2	72.96	172.0	69.49	167.0	66.37	155.8	63.13
	-13.7	-15	200.6	72.80	189.3	71.34	178.2	68.95	172.0	65.70	167.0	62.81	155.8	59.69
	-11.8	-13	200.6	70.19	189.3	68.72	178.2	66.42	172.0	63.28	167.0	60.55	155.8	57.53
	-9.8	-11	200.6	67.48	189.3	65.96	178.2	63.77	172.0	60.75	167.0	58.19	155.8	55.24
	-9.5	-10	200.6	67.06	189.3	65.54	178.2	63.36	172.0	60.38	167.0	57.85	155.8	54.90
	-8.5	-9.1	200.6	65.72	189.3	64.17	178.2	62.02	172.0	59.10	167.0	56.65	155.8	53.75
	-7.0	-7.6	200.6	63.66	189.3	62.11	178.2	60.03	172.0	57.22	167.0	54.88	155.8	52.03
	-5.0	-5.6	200.6	60.94	189.3	59.35	178.2	57.36	172.0	54.68	167.0	52.51	155.8	49.74
	-3.0	-3.7	200.6	58.22	189.3	56.58	178.2	54.69	172.0	52.15	167.0	50.14	155.8	47.45
	0.0	-0.7	200.6	54.13	189.3	52.46	178.2	50.70	172.0	48.35	167.0	46.59	155.8	44.03
	3.0	2.2	200.6	50.04	189.3	48.32	178.2	46.69	172.0	44.57	167.0	43.04	155.8	40.58
	5.0	4.1	200.6	43.72	185.5	41.19	174.5	39.81	168.6	37.95	163.5	36.73	152.8	34.60
	7.0	6.0	200.7	41.67	180.7	38.10	170.1	36.81	164.2	35.15	159.4	34.08	148.7	32.05
	9.0	7.9	193.4	35.97	174.2	32.86	163.8	31.76	158.3	30.33	153.5	29.40	143.2	27.65
	11.0	9.8	183.0	31.78	164.8	29.05	154.9	28.09	149.7	26.80	145.3	26.00	135.5	24.44
	13.0	11.8	171.8	27.74	154.8	25.38	145.5	24.52	140.5	23.41	136.4	22.70	127.3	21.34
15.0	13.7	162.5	24.61	146.3	22.49	137.7	21.74	132.9	20.75	129.1	20.13	120.4	18.92	
60	-24.8	-25	152.9	75.86	152.9	76.82	152.0	78.25	147.6	74.20	142.5	70.41	133.4	66.83
	-21.8	-22	164.3	77.29	162.8	78.25	152.8	74.20	147.6	70.41	142.5	66.83	133.4	63.39
	-19.8	-20	172.0	78.25	162.8	75.39	152.8	71.50	147.6	67.88	142.5	64.45	133.4	61.09
	-18.8	-19	172.0	76.82	162.8	73.96	152.8	70.14	147.6	66.59	142.5	63.26	133.4	59.93
	-16.7	-17	172.0	73.78	162.8	70.94	152.8	67.31	147.6	63.94	142.5	60.77	133.4	57.52
	-13.7	-15	172.0	69.43	162.8	66.67	152.8	63.27	147.6	60.15	142.5	57.20	133.4	54.08
	-11.8	-13	172.0	66.70	162.8	63.94	152.8	60.69	147.6	57.74	142.5	54.95	133.4	51.90
	-9.8	-11	172.0	63.82	162.8	61.08	152.8	58.00	147.6	55.21	142.5	52.56	133.4	49.59
	-9.5	-10	172.0	63.37	162.8	60.67	152.8	57.59	147.6	54.83	142.5	52.20	133.4	49.25
	-8.5	-9.1	172.0	61.94	162.8	59.23	152.8	56.25	147.6	53.57	142.5	51.00	133.4	48.10
	-7.0	-7.6	172.0	59.78	162.8	57.08	152.8	54.23	147.6	51.67	142.5	49.22	133.4	46.37
	-5.0	-5.6	172.0	56.88	162.8	54.22	152.8	51.52	147.6	49.14	142.5	46.85	133.4	44.08
	-3.0	-3.7	172.0	54.00	162.8	51.35	152.8	48.82	147.6	46.62	142.5	44.46	133.4	41.77
	0.0	-0.7	172.0	49.66	162.8	47.07	152.8	44.79	147.6	42.80	142.5	40.89	133.4	38.33
	3.0	2.2	172.0	45.33	162.8	42.77	152.8	40.73	147.6	39.02	142.5	37.34	133.4	34.87
	5.0	4.1	168.6	38.42	159.7	36.12	149.7	34.38	144.6	32.98	139.7	31.59	130.7	29.46
	7.0	6.0	164.2	35.20	155.6	32.98	145.9	31.44	141.0	30.22	136.2	28.98	127.3	26.95
	9.0	7.9	158.3	30.06	149.8	28.14	140.5	26.84	135.9	25.79	131.1	24.75	122.8	23.00
	11.0	9.8	149.7	26.56	141.7	24.88	132.8	23.72	128.4	22.80	123.9	21.87	116.0	20.32
	13.0	11.8	140.5	23.17	133.2	21.71	124.8	20.68	120.5	19.89	116.4	19.07	109.0	17.75
15.0	13.7	132.9	20.75	125.9	19.42	118.1	18.34	114.2	17.64	110.2	16.92	103.1	15.88	
50	-24.8	-25	143.5	66.49	135.3	67.92	127.3	64.33	123.2	60.97	119.1	57.80	110.9	54.85
	-21.8	-22	143.5	67.92	135.3	64.33	127.3	60.97	123.2	57.80	119.1	54.85	110.9	52.01
	-19.8	-20	143.5	65.42	135.3	61.93	127.3	58.74	123.2	55.67	119.1	52.87	110.9	50.11
	-18.8	-19	143.5	64.16	135.3	60.73	127.3	57.62	123.2	54.63	119.1	51.89	110.9	49.16
	-16.7	-17	143.5	61.54	135.3	58.23	127.3	55.29	123.2	52.41	119.1	49.82	110.9	47.17
	-13.7	-15	143.5	57.80	135.3	54.63	127.3	51.92	123.2	49.24	119.1	46.88	110.9	44.33
	-11.8	-13	143.5	55.43	135.3	52.36	127.3	49.80	123.2	47.22	119.1	45.00	110.9	42.53
	-9.8	-11	143.5	52.92	135.3	49.97	127.3	47.55	123.2	45.10	119.1	43.03	110.9	40.62
	-9.5	-10	143.5	52.54	135.3	49.62	127.3	47.23	123.2	44.79	119.1	42.75	110.9	40.35
	-8.5	-9.1	143.5	51.28	135.3	48.42	127.3	46.11	123.2	43.73	119.1	41.76	110.9	39.40
	-7.0	-7.6	143.5	49.42	135.3	46.64	127.3	44.43	123.2	42.16	119.1	40.28	110.9	37.98
	-5.0	-5.6	143.5	46.91	135.3	44.24	127.3	42.20	123.2	40.03	119.1	38.31	110.9	36.09
	-3.0	-3.7	143.5	44.41	135.3	41.84	127.3	39.95	123.2	37.92	119.1	36.33	110.9	34.20
	0.0	-0.7	143.5	40.66	135.3	38.24	127.3	36.60	123.2	34.74	119.1	33.38	110.9	31.34
	3.0	2.2	143.5	36.92	135.3	34.67	127.3	33.26	123.2	31.56	119.1	30.44	110.9	28.50
	5.0	4.1	140.7	31.15	132.8	29.18	124.6	28.05	120.7	26.64	116.7	25.73	108.8	24.06
	7.0	6.0	137.1	28.41	129.3	26.59	121.5	25.62	117.7	24.32	113.8	23.58	106.0	21.99
	9.0	7.9	132.1	24.49	124.6	22.93	117.0	22.10	113.3	21.00	109.5	20.35	102.2	18.98
	11.0	9.8	125.6	21.91	118.4	20.51	111.2	19.76	107.0	18.76	103.6	18.18	96.7	16.96
	13.0	11.8	117.3	18.91	110.6	17.71	104.0	17.05	100.6	16.30	97.4	15.71	90.6	14.73
15.0	13.7	110.9	16.97	104.7	15.88	98.4	15.29	95.3	14.55	92.2	14.08	85.7	13.14	

**Note**

1. TC: Total Capacity(kW), PI : Power Input(kW, Comp. + Outdoor fan motor)
2. Capacity tables show the average value of conditions which may occur.
3. The heating capacity table is based on the values expressed as Max. in the specification of the outdoor unit. (When measuring the Max. heating capacity, the setting status of the indoor unit is the same as that for measuring the heating capacity of the indoor unit.)

# 7. Capacity Tables

## ◆ ARUM840LTE5

Heating Capacity (84HP)

Combination (%)	Outdoor air temp.		Indoor air temp. °C DB											
			16		18		20		21		22		24	
	°C DB	°C WB	TC	PI	TC	PI	TC	PI	TC	PI	TC	PI	TC	PI
130	-24.8	-25	160.1	88.6	160.1	89.43	159.1	90.16	159.1	91.25	159.1	92.34	156.6	94.03
	-21.8	-22	196.4	90.25	196.4	91.09	195.0	91.82	195.0	92.94	195.0	94.03	191.6	95.68
	-19.8	-20	207.8	91.37	207.8	92.22	206.4	92.94	206.4	94.07	206.4	95.12	203.0	96.81
	-18.8	-19	212.7	91.94	212.7	92.78	211.3	93.51	211.3	94.63	211.3	95.68	207.6	97.37
	-16.7	-17	222.6	93.11	222.6	93.95	221.2	94.68	221.2	95.80	221.2	96.88	217.4	98.54
	-13.7	-15	236.7	94.80	236.7	95.64	235.3	96.37	235.3	97.49	235.3	98.54	231.2	94.83
	-11.8	-13	244.4	95.88	244.4	96.69	243.0	97.42	243.0	98.54	243.0	99.66	240.0	92.47
	-9.8	-11	252.5	96.97	252.5	97.82	251.0	98.54	251.0	99.66	251.0	100.78	248.9	90.00
	-9.5	-10	253.9	97.17	253.9	97.98	252.5	98.14	252.5	99.26	252.5	100.54	250.3	89.60
	-8.5	-9.1	259.0	97.70	259.0	98.54	257.6	96.77	257.6	94.14	256.3	91.71	254.8	88.36
	-7.0	-7.6	266.7	98.54	266.7	96.56	264.9	94.74	264.9	92.15	264.9	89.71	262.0	86.51
	-5.0	-5.6	276.9	95.98	276.9	93.89	275.1	92.00	275.1	89.47	275.1	87.08	271.1	84.03
	-3.0	-3.7	287.1	93.41	287.1	91.24	285.3	89.27	285.3	86.79	285.3	84.45	280.3	81.53
	0.0	-0.7	302.3	89.53	302.3	87.25	300.3	85.20	300.3	82.79	300.3	80.50	294.1	77.82
	3.0	2.2	317.6	85.68	317.6	83.23	315.5	81.10	315.5	78.79	314.0	76.52	294.4	74.11
	5.0	4.1	321.3	75.51	320.6	73.12	318.6	71.04	317.4	68.89	309.8	66.81	288.4	64.66
	7.0	6.0	321.0	71.64	320.3	69.34	318.6	67.34	313.0	65.38	301.8	63.42	281.1	61.53
9.0	7.9	310.5	66.70	309.8	64.54	309.1	62.65	301.4	60.83	290.9	59.02	270.9	57.27	
11.0	9.8	293.7	62.54	293.0	60.53	292.3	58.75	284.9	57.04	275.1	55.37	256.1	53.69	
13.0	11.8	275.8	57.51	275.4	55.67	274.4	54.04	267.7	52.47	258.3	50.91	240.4	49.37	
15.0	13.7	261.0	53.33	260.4	51.60	259.6	50.11	253.3	48.65	244.5	47.20	227.4	45.77	
120	-24.8	-25	159.1	89.43	159.1	90.16	158.0	91.25	158.0	92.34	158.0	94.03	155.5	95.20
	-21.8	-22	195.0	91.09	195.0	91.82	193.6	92.94	193.6	94.03	193.6	95.68	190.5	96.88
	-19.8	-20	206.4	92.22	206.4	92.94	205.0	94.07	205.0	95.12	205.0	96.81	201.6	97.98
	-18.8	-19	211.0	92.78	211.0	93.51	209.6	94.63	209.6	95.68	209.6	97.37	206.2	98.54
	-16.7	-17	220.9	93.95	220.9	94.68	219.5	95.80	219.5	96.88	219.5	98.54	215.7	96.15
	-13.7	-15	234.9	95.64	234.9	96.37	233.5	97.49	233.5	98.54	233.5	99.66	229.5	92.73
	-11.8	-13	242.6	96.69	242.6	97.42	241.2	98.54	241.2	99.66	241.2	100.78	238.2	90.58
	-9.8	-11	250.7	97.82	250.7	98.54	249.3	95.76	249.3	93.36	249.3	90.34	247.2	88.29
	-9.5	-10	252.2	97.98	252.2	98.10	250.8	95.36	250.8	92.96	250.8	89.98	248.7	87.93
	-8.5	-9.1	257.3	98.54	257.3	96.63	255.5	93.96	255.5	91.64	255.5	88.81	253.1	86.80
	-7.0	-7.6	264.9	96.36	264.9	94.43	263.2	91.88	263.2	89.64	263.0	87.02	260.2	85.09
	-5.0	-5.6	275.1	93.44	275.1	91.49	273.3	89.10	273.3	86.97	273.3	84.62	269.4	82.80
	-3.0	-3.7	285.0	90.52	285.0	88.58	283.2	86.31	283.2	84.34	283.2	82.25	276.5	80.51
	0.0	-0.7	300.2	86.15	300.2	84.17	298.1	82.14	298.1	80.33	296.9	78.68	276.5	77.09
	3.0	2.2	315.2	81.78	315.2	79.76	312.5	77.77	307.0	76.35	297.5	75.11	276.5	73.68
	5.0	4.1	319.1	71.57	317.6	69.66	311.2	68.09	301.0	66.64	291.6	65.65	270.9	64.37
	7.0	6.0	319.1	67.58	315.8	65.76	303.5	64.45	293.3	63.22	284.2	62.63	263.9	61.50
9.0	7.9	308.4	62.73	304.2	61.02	292.3	59.82	282.5	58.68	273.7	58.10	254.4	57.07	
11.0	9.8	291.6	58.64	287.7	57.03	276.5	55.90	267.0	54.84	258.9	54.33	240.4	53.37	
13.0	11.8	274.0	53.73	270.2	52.26	259.6	51.24	250.9	50.25	243.2	49.78	225.9	48.89	
15.0	13.7	259.3	49.61	255.8	48.25	245.6	47.30	237.5	46.42	230.2	45.98	213.7	45.16	
110	-24.8	-25	158.3	90.16	158.3	91.25	157.3	92.34	157.3	94.03	157.3	95.20	154.5	95.76
	-21.8	-22	194.0	91.82	194.0	92.94	192.6	94.03	192.6	95.68	192.6	96.88	189.5	97.42
	-19.8	-20	205.3	92.94	205.3	94.07	204.0	95.12	204.0	96.81	204.0	97.98	200.5	98.54
	-18.8	-19	209.9	93.51	209.9	94.63	208.5	95.68	208.5	97.37	208.5	98.54	205.1	97.28
	-16.7	-17	219.8	94.68	219.8	95.80	218.4	96.88	218.4	98.54	218.4	99.66	214.6	94.61
	-13.7	-15	233.6	96.37	233.6	97.49	232.1	98.54	232.1	94.63	232.1	92.24	232.1	90.82
	-11.8	-13	241.3	97.42	241.3	98.54	239.8	95.78	239.8	92.13	239.8	89.89	239.8	88.41
	-9.8	-11	249.3	98.54	249.3	95.42	247.9	92.88	247.9	89.52	247.9	87.43	247.0	85.88
	-9.5	-10	250.8	98.03	250.8	94.94	249.4	92.41	249.4	89.12	249.4	87.07	248.5	85.51
	-8.5	-9.1	255.9	96.36	255.9	93.38	254.4	90.96	254.4	87.81	254.4	85.80	248.8	84.22
	-7.0	-7.6	263.5	93.81	263.5	91.05	261.8	88.78	261.8	85.85	261.8	83.96	248.8	82.34
	-5.0	-5.6	273.4	90.45	273.4	87.89	271.6	85.87	271.6	83.24	266.3	81.49	248.8	79.78
	-3.0	-3.7	283.5	87.07	283.5	84.77	281.6	82.93	275.8	80.60	266.3	79.00	248.8	77.26
	0.0	-0.7	298.5	82.00	298.1	80.08	284.9	78.57	275.8	76.68	266.3	75.31	248.8	73.47
	3.0	2.2	313.0	76.94	303.8	75.38	284.9	74.18	275.8	72.77	266.3	71.58	248.8	69.65
	5.0	4.1	315.1	66.74	297.6	65.45	279.3	64.47	270.2	63.35	261.1	62.37	243.9	60.55
	7.0	6.0	307.0	62.46	290.2	61.53	272.3	60.84	263.5	60.09	254.4	59.33	237.6	57.47
9.0	7.9	295.8	57.66	279.3	56.80	262.1	56.15	253.7	55.47	245.2	54.78	228.8	53.07	
11.0	9.8	279.6	53.59	264.2	52.77	248.1	52.18	240.0	51.57	231.9	50.89	216.5	49.31	
13.0	11.8	262.5	48.80	248.1	48.05	233.0	47.50	225.3	46.92	217.6	46.34	203.2	44.91	
15.0	13.7	248.4	44.69	234.7	44.02	220.4	43.51	213.0	43.00	206.0	42.45	192.3	41.13	

# 7. Capacity Tables

Heating Capacity (84HP)

Combination (%)	Outdoor air temp.		Indoor air temp. °C DB											
			16		18		20		21		22		24	
	°C DB	°C WB	TC	PI	TC	PI	TC	PI	TC	PI	TC	PI	TC	PI
100	-24.8	-25	157.6	100.3	157.6	100.1	156.6	93.75	156.6	99.49	156.6	99.25	153.8	99.14
	-21.8	-22	192.9	99.93	192.9	99.71	191.9	96.71	191.9	99.14	191.9	100.3	188.4	98.79
	-19.8	-20	204.3	99.71	204.3	99.46	203.2	98.57	203.2	98.92	203.2	99.14	199.8	98.54
	-18.8	-19	208.9	99.60	207.8	99.36	207.8	99.14	207.8	98.78	207.8	98.54	204.1	97.00
	-16.7	-17	217.4	99.36	217.4	99.12	217.4	100.3	216.3	98.54	216.3	98.54	212.5	93.75
	-13.7	-15	232.5	99.01	232.5	98.76	231.1	98.54	231.1	93.91	231.1	90.77	227.4	89.07
	-11.8	-13	240.2	98.79	238.8	98.54	238.8	95.44	238.8	90.96	238.8	87.86	227.4	86.13
	-9.8	-11	247.9	98.54	247.9	95.07	246.9	92.16	246.9	87.87	243.9	84.82	227.4	83.02
	-9.5	-10	249.4	98.00	249.4	94.53	248.3	91.68	248.3	87.40	243.9	84.35	227.4	82.56
	-8.5	-9.1	254.5	96.18	254.5	92.80	253.4	90.03	252.3	85.85	243.9	82.84	227.4	80.99
	-7.0	-7.6	266.3	93.46	265.3	90.19	260.7	87.57	252.3	83.55	243.9	80.55	227.4	78.66
	-5.0	-5.6	277.9	89.80	275.1	86.72	260.7	84.32	252.3	80.43	243.9	77.50	227.4	75.55
	-3.0	-3.7	286.0	86.17	277.5	83.22	260.7	81.04	252.3	77.33	243.9	74.46	227.4	72.44
	0.0	-0.7	294.0	80.70	277.5	78.01	260.7	76.13	252.3	72.70	243.9	69.87	227.4	67.79
	3.0	2.2	294.0	75.22	277.5	72.77	260.7	71.22	252.3	68.06	243.9	65.29	227.4	63.14
	5.0	4.1	288.1	64.99	271.9	62.83	255.4	61.51	247.4	58.74	239.3	56.22	222.8	54.22
	7.0	6.0	280.7	60.46	264.9	58.57	249.1	57.54	241.0	55.06	233.0	52.69	217.2	50.66
	9.0	7.9	270.5	55.52	255.1	53.77	240.0	52.84	232.3	50.55	224.6	48.35	209.1	46.50
	11.0	9.8	255.8	51.26	241.4	49.62	226.7	48.77	219.6	46.65	212.3	44.64	197.9	42.93
	13.0	11.8	240.3	46.29	226.7	44.83	213.0	44.05	206.3	42.15	199.3	40.34	185.6	38.78
15.0	13.7	227.4	42.04	214.4	40.72	201.4	40.01	195.1	38.26	188.7	36.61	175.8	35.22	
90	-24.8	-25	156.9	88.90	156.9	90.56	155.9	91.76	155.9	92.29	155.9	93.42	153.4	95.11
	-21.8	-22	192.2	90.56	192.2	92.25	191.2	93.42	191.2	93.98	191.2	95.11	187.7	91.02
	-19.8	-20	203.6	91.69	203.6	93.37	202.2	94.54	202.2	95.11	202.2	96.30	198.8	88.29
	-18.8	-19	208.9	92.25	207.8	93.94	206.8	95.11	206.8	93.68	206.8	90.91	203.4	86.94
	-16.7	-17	217.4	93.42	217.4	95.11	216.6	92.14	216.6	90.65	216.6	87.99	207.7	84.07
	-13.7	-15	232.5	95.11	232.5	90.67	230.4	87.89	230.4	86.34	223.8	83.79	207.7	79.98
	-11.8	-13	240.2	92.06	238.8	87.88	237.8	85.18	231.2	83.60	223.8	81.15	207.7	77.39
	-9.8	-11	247.9	88.90	247.9	84.95	238.6	82.36	231.2	80.71	223.8	78.35	207.7	74.66
	-9.5	-10	249.4	88.40	249.4	84.48	238.6	81.93	231.2	80.28	223.8	77.92	207.7	74.24
	-8.5	-9.1	254.5	86.82	252.7	83.02	238.6	80.50	231.2	78.85	223.8	76.53	207.7	72.88
	-7.0	-7.6	266.3	84.42	253.3	80.80	238.6	78.39	231.2	76.68	223.8	74.43	207.7	70.83
	-5.0	-5.6	269.1	81.23	253.3	77.86	238.6	75.57	231.2	73.83	223.8	71.65	207.7	68.13
	-3.0	-3.7	269.1	78.04	253.3	74.93	238.6	72.72	231.2	70.94	223.8	68.84	207.7	65.39
	0.0	-0.7	269.1	73.27	253.3	70.49	238.6	68.47	231.2	66.63	223.8	64.65	207.7	61.31
	3.0	2.2	269.1	68.46	253.3	66.06	238.6	64.22	231.2	62.32	223.8	60.48	207.7	57.20
	5.0	4.1	263.9	59.11	248.4	57.07	233.7	55.44	226.6	53.69	219.3	52.06	203.5	49.13
	7.0	6.0	257.2	55.27	242.1	53.55	227.7	52.11	220.7	50.35	213.7	48.84	198.6	46.05
	9.0	7.9	247.7	50.72	233.0	49.18	219.3	47.84	212.6	46.20	205.9	44.83	191.2	42.29
	11.0	9.8	234.4	46.38	220.4	44.94	207.4	43.72	201.1	42.25	194.7	40.99	180.7	38.63
	13.0	11.8	220.0	41.03	207.0	39.77	194.8	38.72	188.8	37.39	182.8	36.27	169.8	34.20
15.0	13.7	208.1	36.87	195.8	35.73	184.5	34.78	178.6	33.60	173.0	32.59	160.7	30.73	
80	-24.8	-25	156.2	78.12	156.2	79.81	155.2	80.98	155.2	81.54	155.2	84.33	152.7	80.74
	-21.8	-22	190.1	79.81	190.1	81.47	190.1	82.64	190.1	84.33	190.1	80.74	185.6	77.27
	-19.8	-20	201.5	80.91	201.5	82.59	201.5	84.33	201.5	81.80	199.4	78.33	185.6	74.97
	-18.8	-19	206.1	81.47	206.1	84.33	206.1	83.04	206.1	80.52	199.6	77.12	185.6	73.83
	-16.7	-17	213.3	84.33	213.3	81.65	213.3	80.34	207.0	77.86	199.6	74.63	185.6	71.42
	-13.7	-15	223.1	80.36	218.6	77.80	213.3	76.49	207.0	74.05	199.6	71.01	185.6	67.95
	-11.8	-13	228.5	77.82	221.8	75.37	213.3	74.03	207.0	71.63	199.6	68.74	185.6	65.75
	-9.8	-11	234.5	75.17	225.0	72.83	213.3	71.46	207.0	69.11	199.6	66.33	185.6	63.45
	-9.5	-10	236.2	74.78	226.3	72.44	213.3	71.07	207.0	68.72	199.6	65.97	185.6	63.12
	-8.5	-9.1	238.7	73.46	227.4	71.16	213.3	69.79	207.0	67.44	199.6	64.79	185.6	61.96
	-7.0	-7.6	241.1	71.46	227.4	69.23	213.3	67.86	207.0	65.55	199.6	62.99	185.6	60.22
	-5.0	-5.6	241.1	68.81	227.4	66.70	213.3	65.27	207.0	62.99	199.6	60.57	185.6	57.92
	-3.0	-3.7	241.1	66.16	227.4	64.13	213.3	62.70	207.0	60.47	199.6	58.19	185.6	55.61
	0.0	-0.7	241.1	62.16	227.4	60.31	213.3	58.85	207.0	56.66	199.6	54.57	185.6	52.17
	3.0	2.2	241.1	58.19	227.4	56.45	213.3	54.97	207.0	52.82	199.6	50.98	185.6	48.70
	5.0	4.1	236.2	50.21	222.8	48.69	209.1	47.34	202.8	45.41	195.4	43.82	182.1	41.86
	7.0	6.0	230.2	47.05	217.2	45.71	203.8	44.34	197.6	42.51	190.5	41.10	177.2	39.24
	9.0	7.9	221.8	42.01	209.1	40.85	196.2	39.83	190.5	38.30	183.5	36.93	170.9	35.18
	11.0	9.8	209.8	37.20	197.6	36.18	185.6	35.27	180.0	33.91	173.7	32.71	161.4	31.14
	13.0	11.8	196.9	32.20	185.6	31.29	174.4	30.52	169.1	29.33	163.1	28.28	151.6	26.95
15.0	13.7	186.3	28.91	175.8	28.08	164.9	27.40	160.0	26.33	154.4	25.41	143.5	24.20	



# 7. Capacity Tables

Heating Capacity (84HP)

Combination (%)	Outdoor air temp.		Indoor air temp. °C DB											
			16		18		20		21		22		24	
	°C DB	°C WB	TC	PI	TC	PI	TC	PI	TC	PI	TC	PI	TC	PI
70	-24.8	-25	156.2	78.84	156.2	79.40	155.2	80.53	155.2	82.22	155.2	78.31	152.6	74.64
	-21.8	-22	182.8	80.53	182.8	81.09	181.7	82.22	175.4	78.31	170.2	74.64	158.9	71.12
	-19.8	-20	200.5	81.66	193.0	82.22	181.7	79.47	175.4	75.70	170.2	72.21	158.9	68.77
	-18.8	-19	204.3	82.22	193.0	80.80	181.7	78.09	175.4	74.39	170.2	70.98	158.9	67.57
	-16.7	-17	204.5	79.25	193.0	77.80	181.7	75.23	175.4	71.65	170.2	68.44	158.9	65.11
	-13.7	-15	204.5	75.07	193.0	73.56	181.7	71.10	175.4	67.76	170.2	64.78	158.9	61.56
	-11.8	-13	204.5	72.38	193.0	70.87	181.7	68.49	175.4	65.26	170.2	62.45	158.9	59.34
	-9.8	-11	204.5	69.59	193.0	68.02	181.7	65.77	175.4	62.65	170.2	60.02	158.9	56.98
	-9.5	-10	204.5	69.16	193.0	67.59	181.7	65.35	175.4	62.27	170.2	59.67	158.9	56.63
	-8.5	-9.1	204.5	67.78	193.0	66.18	181.7	63.97	175.4	60.96	170.2	58.44	158.9	55.44
	-7.0	-7.6	204.5	65.66	193.0	64.06	181.7	61.92	175.4	59.02	170.2	56.61	158.9	53.68
	-5.0	-5.6	204.5	62.86	193.0	61.23	181.7	59.17	175.4	56.41	170.2	54.17	158.9	51.32
	-3.0	-3.7	204.5	60.07	193.0	58.37	181.7	56.42	175.4	53.80	170.2	51.74	158.9	48.96
	0.0	-0.7	204.5	55.86	193.0	54.13	181.7	52.32	175.4	49.89	170.2	48.08	158.9	45.44
	3.0	2.2	204.5	51.65	193.0	49.88	181.7	48.19	175.4	46.01	170.2	44.42	158.9	41.89
	5.0	4.1	204.5	45.13	189.1	42.52	177.9	41.10	171.9	39.17	166.7	37.92	155.8	35.72
	7.0	6.0	204.6	43.03	184.2	39.34	173.4	38.01	167.4	36.29	162.5	35.19	151.6	33.09
	9.0	7.9	197.2	37.15	177.6	33.93	167.0	32.80	161.4	31.32	156.5	30.36	146.0	28.55
	11.0	9.8	186.6	32.83	168.1	30.00	157.9	29.01	152.6	27.68	148.1	26.86	138.2	25.25
	13.0	11.8	175.1	28.66	157.9	26.22	148.4	25.33	143.2	24.18	139.0	23.44	129.8	22.04
15.0	13.7	165.6	25.43	149.1	23.23	140.4	22.46	135.5	21.44	131.6	20.80	122.8	19.55	
60	-24.8	-25	155.6	77.71	155.6	78.84	154.6	80.53	150.5	76.37	145.3	72.48	136.1	68.81
	-21.8	-22	167.4	79.40	166.0	80.53	155.8	76.37	150.5	72.48	145.3	68.81	136.1	65.28
	-19.8	-20	175.4	80.53	166.0	77.59	155.8	73.60	150.5	69.89	145.3	66.36	136.1	62.91
	-18.8	-19	175.4	79.06	166.0	76.12	155.8	72.20	150.5	68.56	145.3	65.14	136.1	61.72
	-16.7	-17	175.4	75.94	166.0	73.03	155.8	69.30	150.5	65.84	145.3	62.59	136.1	59.24
	-13.7	-15	175.4	71.48	166.0	68.65	155.8	65.16	150.5	61.95	145.3	58.92	136.1	55.71
	-11.8	-13	175.4	68.68	166.0	65.85	155.8	62.50	150.5	59.47	145.3	56.61	136.1	53.48
	-9.8	-11	175.4	65.73	166.0	62.91	155.8	59.74	150.5	56.88	145.3	54.16	136.1	51.10
	-9.5	-10	175.4	65.27	166.0	62.49	155.8	59.32	150.5	56.49	145.3	53.78	136.1	50.75
	-8.5	-9.1	175.4	63.80	166.0	61.02	155.8	57.95	150.5	55.20	145.3	52.55	136.1	49.57
	-7.0	-7.6	175.4	61.59	166.0	58.81	155.8	55.88	150.5	53.24	145.3	50.73	136.1	47.79
	-5.0	-5.6	175.4	58.61	166.0	55.87	155.8	53.09	150.5	50.65	145.3	48.29	136.1	45.44
	-3.0	-3.7	175.4	55.66	166.0	52.93	155.8	50.32	150.5	48.06	145.3	45.84	136.1	43.07
	0.0	-0.7	175.4	51.21	166.0	48.54	155.8	46.19	150.5	44.14	145.3	42.17	136.1	39.54
	3.0	2.2	175.4	46.76	166.0	44.13	155.8	42.02	150.5	40.26	145.3	38.53	136.1	35.98
	5.0	4.1	171.9	39.65	162.8	37.27	152.6	35.48	147.4	34.03	142.4	32.61	133.3	30.41
	7.0	6.0	167.4	36.35	158.6	34.05	148.8	32.47	143.8	31.20	138.9	29.92	129.8	27.83
	9.0	7.9	161.4	31.05	152.7	29.06	143.2	27.72	138.6	26.63	133.7	25.56	125.2	23.75
	11.0	9.8	152.6	27.44	144.5	25.70	135.4	24.50	130.9	23.55	126.3	22.59	118.3	20.99
	13.0	11.8	143.2	23.94	135.8	22.42	127.3	21.36	122.8	20.55	118.6	19.70	111.2	18.34
15.0	13.7	135.5	21.44	128.4	20.06	120.4	18.94	116.5	18.23	112.3	17.49	105.2	16.41	
50	-24.8	-25	146.3	68.33	137.9	70.02	129.8	66.32	125.6	62.86	121.4	59.59	113.0	56.56
	-21.8	-22	146.3	70.02	137.9	66.32	129.8	62.86	125.6	59.59	121.4	56.56	113.0	53.64
	-19.8	-20	146.3	67.44	137.9	63.85	129.8	60.57	125.6	57.40	121.4	54.52	113.0	51.67
	-18.8	-19	146.3	66.14	137.9	62.61	129.8	59.41	125.6	56.34	121.4	53.50	113.0	50.69
	-16.7	-17	146.3	63.45	137.9	60.04	129.8	57.01	125.6	54.05	121.4	51.38	113.0	48.65
	-13.7	-15	146.3	59.60	137.9	56.33	129.8	53.55	125.6	50.78	121.4	48.35	113.0	45.73
	-11.8	-13	146.3	57.16	137.9	54.00	129.8	51.36	125.6	48.70	121.4	46.42	113.0	43.87
	-9.8	-11	146.3	54.58	137.9	51.53	129.8	49.04	125.6	46.52	121.4	44.38	113.0	41.90
	-9.5	-10	146.3	54.19	137.9	51.18	129.8	48.72	125.6	46.20	121.4	44.10	113.0	41.62
	-8.5	-9.1	146.3	52.88	137.9	49.94	129.8	47.56	125.6	45.11	121.4	43.08	113.0	40.64
	-7.0	-7.6	146.3	50.97	137.9	48.11	129.8	45.83	125.6	43.49	121.4	41.56	113.0	39.19
	-5.0	-5.6	146.3	48.39	137.9	45.64	129.8	43.54	125.6	41.30	121.4	39.52	113.0	37.23
	-3.0	-3.7	146.3	45.81	137.9	43.17	129.8	41.21	125.6	39.12	121.4	37.48	113.0	35.29
	0.0	-0.7	146.3	41.96	137.9	39.46	129.8	37.76	125.6	35.85	121.4	34.45	113.0	32.34
	3.0	2.2	146.3	38.11	137.9	35.79	129.8	34.33	125.6	32.57	121.4	31.42	113.0	29.42
	5.0	4.1	143.5	32.16	135.4	30.12	127.0	28.95	123.1	27.50	119.0	26.56	110.9	24.84
	7.0	6.0	139.7	29.34	131.9	27.45	123.9	26.45	120.0	25.11	116.1	24.35	108.1	22.70
	9.0	7.9	134.7	25.29	127.0	23.68	119.3	22.82	115.5	21.69	111.6	21.01	104.2	19.60
	11.0	9.8	128.1	22.63	120.7	21.19	113.3	20.41	109.1	19.38	105.6	18.77	98.6	17.51
	13.0	11.8	119.6	19.53	112.7	18.30	106.0	17.62	102.5	16.84	99.3	16.23	92.3	15.22
15.0	13.7	113.0	17.53	106.7	16.41	100.3	15.80	97.2	15.03	94.0	14.55	87.4	13.57	

**Note**

1. TC: Total Capacity(kW), PI : Power Input(kW, Comp. + Outdoor fan motor)
2. Capacity tables show the average value of conditions which may occur.
3. The heating capacity table is based on the values expressed as Max. in the specification of the outdoor unit. (When measuring the Max. heating capacity, the setting status of the indoor unit is the same as that for measuring the heating capacity of the indoor unit.)

# 7. Capacity Tables

## ◆ ARUM860LTE5

Heating Capacity (86HP)

Combination (%)	Outdoor air temp.		Indoor air temp. °C DB											
			16		18		20		21		22		24	
	°C DB	°C WB	TC	PI	TC	PI	TC	PI	TC	PI	TC	PI	TC	PI
130	-24.8	-25	163.5	90.2	163.5	90.99	162.5	91.65	162.5	92.64	162.5	93.62	159.5	95.15
	-21.8	-22	201.3	91.73	201.3	92.49	199.8	93.15	199.8	94.17	199.8	95.15	195.9	96.65
	-19.8	-20	213.3	92.75	213.3	93.51	211.9	94.17	211.9	95.19	211.9	96.14	207.9	97.67
	-18.8	-19	218.3	93.26	218.3	94.02	216.9	94.68	216.9	95.70	216.9	96.65	212.6	98.18
	-16.7	-17	228.5	94.32	228.5	95.08	227.0	95.74	227.0	96.76	227.0	97.74	222.7	99.24
	-13.7	-15	242.9	95.85	242.9	96.61	241.5	97.27	241.5	98.29	241.5	99.24	236.8	95.64
	-11.8	-13	250.8	96.83	250.8	97.56	249.4	98.22	249.4	99.24	249.4	99.84	245.8	93.35
	-9.8	-11	259.1	97.82	259.1	98.58	257.6	99.24	257.6	99.70	257.6	100.30	255.2	90.95
	-9.5	-10	260.6	98.00	260.6	98.73	259.1	98.85	259.1	99.31	258.8	99.91	256.7	90.56
	-8.5	-9.1	265.6	98.48	265.6	99.24	264.1	97.55	264.1	98.00	263.0	98.64	261.4	89.36
	-7.0	-7.6	273.1	99.24	273.1	97.37	271.3	95.60	271.3	93.09	271.3	90.70	268.3	87.56
	-5.0	-5.6	283.2	96.83	283.2	94.82	281.4	92.99	281.4	90.52	281.4	88.16	277.7	85.16
	-3.0	-3.7	293.2	94.43	293.2	92.31	291.4	90.38	291.4	87.94	291.4	85.62	287.1	82.73
	0.0	-0.7	308.3	90.79	308.3	88.53	306.2	86.49	306.2	84.09	306.2	81.80	301.2	79.13
	3.0	2.2	323.4	87.18	323.4	84.72	321.2	82.57	321.2	80.24	321.2	77.96	301.5	75.52
	5.0	4.1	327.3	77.00	326.6	74.57	324.5	72.46	324.5	70.28	317.3	68.17	295.4	65.99
	7.0	6.0	328.4	73.26	327.7	70.90	325.9	68.86	320.5	66.86	309.1	64.85	287.8	62.92
	9.0	7.9	318.0	68.39	317.3	66.18	316.6	64.25	308.7	62.38	297.9	60.52	277.4	58.72
	11.0	9.8	300.8	64.34	300.1	62.26	299.3	60.44	291.8	58.68	281.7	56.95	262.3	55.23
13.0	11.8	282.5	59.37	282.1	57.47	281.0	55.78	274.2	54.17	264.5	52.55	246.2	50.97	
15.0	13.7	267.3	55.27	266.7	53.48	265.9	51.94	259.4	50.43	250.4	48.92	232.9	47.44	
120	-24.8	-25	162.4	90.99	162.4	91.65	161.4	92.64	161.4	93.62	161.4	95.15	158.4	96.21
	-21.8	-22	199.8	92.49	199.8	93.15	198.4	94.17	198.4	95.15	198.4	96.65	194.8	97.74
	-19.8	-20	211.8	93.51	211.8	94.17	210.4	95.19	210.4	96.14	210.4	97.67	206.4	98.73
	-18.8	-19	216.6	94.02	216.6	94.68	215.1	95.70	215.1	96.65	215.1	98.18	211.1	99.24
	-16.7	-17	226.7	95.08	226.7	95.74	225.3	96.76	225.3	97.74	225.3	99.24	220.9	96.91
	-13.7	-15	241.1	96.61	241.1	97.27	239.7	98.29	239.7	99.24	239.7	95.78	235.0	93.59
	-11.8	-13	249.0	97.56	249.0	98.22	247.6	99.24	247.6	96.80	247.6	93.59	244.0	91.51
	-9.8	-11	257.3	98.58	257.3	99.24	255.8	96.56	255.8	94.23	255.8	91.30	253.4	89.29
	-9.5	-10	258.8	98.73	258.8	98.82	257.3	96.17	257.3	93.84	257.3	90.95	254.9	88.94
	-8.5	-9.1	263.8	99.24	263.8	97.41	262.0	94.83	262.0	92.57	262.0	89.81	259.3	87.84
	-7.0	-7.6	271.3	97.16	271.3	95.29	269.5	92.82	269.5	90.63	269.5	88.09	266.5	86.18
	-5.0	-5.6	281.3	94.37	281.3	92.46	279.5	90.13	279.5	88.05	279.5	85.76	275.9	83.96
	-3.0	-3.7	291.1	91.58	291.1	89.67	289.3	87.45	289.3	85.51	289.3	83.46	283.2	81.74
	0.0	-0.7	306.1	87.41	306.1	85.43	304.0	83.43	304.0	81.63	304.0	80.01	283.2	78.42
	3.0	2.2	320.9	83.23	320.9	81.19	319.0	79.40	314.5	77.78	304.7	76.55	283.2	75.10
	5.0	4.1	325.2	72.99	324.1	71.05	318.8	69.47	308.3	67.99	298.6	67.01	277.4	65.71
	7.0	6.0	326.6	69.11	323.4	67.24	310.8	65.91	300.4	64.64	291.1	64.04	270.3	62.89
	9.0	7.9	315.9	64.31	311.6	62.56	299.3	61.33	289.3	60.16	280.3	59.57	260.5	58.51
	11.0	9.8	298.6	60.29	294.7	58.64	283.2	57.49	273.5	56.39	265.2	55.87	246.2	54.88
13.0	11.8	280.6	55.43	276.7	53.92	265.9	52.87	256.9	51.85	249.0	51.36	231.4	50.44	
15.0	13.7	265.5	51.38	261.9	49.97	251.5	48.99	243.3	48.07	235.7	47.62	218.8	46.77	
110	-24.8	-25	161.7	91.65	161.7	92.64	160.6	93.62	160.6	95.15	160.6	96.21	157.4	96.72
	-21.8	-22	198.7	93.15	198.7	94.17	197.3	95.15	197.3	96.65	197.3	97.74	193.7	98.22
	-19.8	-20	210.8	94.17	210.8	95.19	209.3	96.14	209.3	97.67	209.3	98.73	205.4	99.24
	-18.8	-19	215.5	94.68	215.5	95.70	214.0	96.65	214.0	98.18	214.0	99.24	210.1	98.01
	-16.7	-17	225.6	95.74	225.6	96.76	224.2	97.74	224.2	99.24	224.2	96.73	219.8	95.40
	-13.7	-15	239.7	97.27	239.7	98.29	238.3	99.24	238.3	95.43	238.3	93.10	238.3	91.69
	-11.8	-13	247.6	98.22	247.6	99.24	246.2	96.56	246.2	93.00	246.2	90.81	246.2	89.33
	-9.8	-11	255.9	99.24	255.9	96.21	254.4	93.73	254.4	90.45	254.4	88.41	253.5	86.86
	-9.5	-10	257.3	98.75	257.3	95.75	255.9	93.28	255.9	90.07	255.9	88.05	254.8	86.50
	-8.5	-9.1	262.3	97.12	262.3	94.23	260.9	91.87	260.9	88.80	260.9	86.82	254.8	85.24
	-7.0	-7.6	269.9	94.65	269.9	91.97	268.1	89.75	268.1	86.89	268.1	85.02	254.8	83.40
	-5.0	-5.6	279.6	91.40	279.6	88.90	277.8	86.92	277.8	84.35	272.8	82.62	254.8	80.90
	-3.0	-3.7	289.6	88.12	289.6	85.87	287.8	84.07	282.4	81.78	272.8	80.19	254.8	78.43
	0.0	-0.7	304.4	83.22	304.4	81.31	291.8	79.83	282.4	77.96	272.8	76.59	254.8	74.73
	3.0	2.2	319.1	78.31	311.2	76.76	291.8	75.56	282.4	74.15	272.8	72.96	254.8	70.99
	5.0	4.1	322.6	68.07	304.8	66.76	286.1	65.78	276.7	64.65	267.4	63.66	249.7	61.80
	7.0	6.0	314.4	63.87	297.2	62.92	278.9	62.21	269.8	61.44	260.5	60.67	243.3	58.77
	9.0	7.9	302.9	59.11	286.1	58.23	268.5	57.57	259.8	56.86	251.2	56.16	234.3	54.40
	11.0	9.8	286.4	55.09	270.6	54.25	254.1	53.65	245.8	53.02	237.5	52.32	221.7	50.70
13.0	11.8	268.8	50.33	254.1	49.56	238.6	49.00	230.7	48.40	222.8	47.80	208.1	46.33	
15.0	13.7	254.4	46.28	240.4	45.58	225.7	45.06	218.2	44.53	210.9	43.96	196.9	42.59	

# 7. Capacity Tables

Heating Capacity (86HP)

Combination (%)	Outdoor air temp.		Indoor air temp. °C DB											
			16		18		20		21		22		24	
	°C DB	°C WB	TC	PI	TC	PI	TC	PI	TC	PI	TC	PI	TC	PI
100	-24.8	-25	161.0	101.6	161.0	101.3	159.9	94.69	159.9	100.5	159.9	100.2	156.7	100.1
	-21.8	-22	197.7	101.1	197.7	100.8	196.6	97.67	196.6	100.1	196.6	101.1	192.7	99.57
	-19.8	-20	209.7	100.8	209.7	100.5	208.6	99.54	208.6	99.75	208.6	99.87	204.6	99.24
	-18.8	-19	214.4	100.7	213.3	100.4	213.3	100.1	213.3	99.57	213.3	99.24	209.0	97.72
	-16.7	-17	223.1	100.4	223.1	100.0	223.1	101.1	222.0	99.24	222.0	96.10	217.7	94.51
	-13.7	-15	238.6	99.87	238.6	99.54	237.2	99.24	237.2	94.69	237.2	91.59	232.9	89.90
	-11.8	-13	246.5	99.57	245.1	99.24	245.1	96.21	245.1	91.80	245.1	88.73	232.9	87.01
	-9.8	-11	254.5	99.24	254.5	95.85	253.3	93.00	253.3	88.77	249.8	85.74	232.9	83.94
	-9.5	-10	255.9	98.71	255.9	95.33	254.8	92.54	254.8	88.31	249.8	85.28	232.9	83.48
	-8.5	-9.1	260.9	96.95	260.9	93.63	259.8	90.92	258.4	86.79	249.8	83.80	232.9	81.93
	-7.0	-7.6	272.8	94.30	271.7	91.09	267.0	88.52	258.4	84.53	249.8	81.54	232.9	79.64
	-5.0	-5.6	284.6	90.74	281.8	87.70	267.0	85.34	258.4	81.47	249.8	78.54	232.9	76.57
	-3.0	-3.7	292.9	87.21	284.2	84.28	267.0	82.13	258.4	78.44	249.8	75.55	232.9	73.51
	0.0	-0.7	301.1	81.88	284.2	79.20	267.0	77.33	258.4	73.89	249.8	71.03	232.9	68.92
	3.0	2.2	301.1	76.55	284.2	74.09	267.0	72.54	258.4	69.34	249.8	66.52	232.9	64.34
	5.0	4.1	295.0	66.27	278.5	64.09	261.6	62.75	253.3	59.94	245.1	57.37	228.2	55.33
	7.0	6.0	287.5	61.83	271.3	59.89	255.1	58.84	246.9	56.31	238.6	53.88	222.4	51.81
	9.0	7.9	277.1	56.94	261.3	55.15	245.8	54.20	237.9	51.84	230.0	49.59	214.2	47.70
	11.0	9.8	262.0	52.75	247.2	51.07	232.2	50.19	224.9	48.02	217.4	45.94	202.7	44.19
	13.0	11.8	246.1	47.83	232.1	46.33	218.1	45.52	211.3	43.55	204.1	41.69	190.1	40.08
15.0	13.7	232.9	43.65	219.6	42.28	206.3	41.55	199.8	39.73	193.3	38.01	180.0	36.57	
90	-24.8	-25	160.3	90.25	160.3	91.75	159.2	92.84	159.2	93.32	159.2	94.34	156.3	95.87
	-21.8	-22	197.0	91.75	197.0	93.28	195.9	94.34	195.9	94.85	195.9	95.87	191.9	91.82
	-19.8	-20	209.0	92.77	209.0	94.30	207.6	95.36	207.6	95.87	207.6	96.90	203.6	89.12
	-18.8	-19	214.4	93.28	213.3	94.81	212.3	95.87	212.3	96.46	212.3	97.50	208.3	87.78
	-16.7	-17	223.1	94.34	223.1	95.87	222.3	96.90	222.3	97.50	222.3	98.54	212.7	84.93
	-13.7	-15	238.6	95.87	238.6	91.51	236.5	88.76	236.5	87.22	229.2	84.69	212.7	80.89
	-11.8	-13	246.5	92.88	245.1	88.77	244.0	86.10	236.8	84.51	229.2	82.08	212.7	78.32
	-9.8	-11	254.5	89.78	254.5	85.88	244.4	83.32	236.8	81.67	229.2	79.31	212.7	75.61
	-9.5	-10	255.9	89.29	255.9	85.43	244.4	82.89	236.8	81.24	229.2	78.89	212.7	75.19
	-8.5	-9.1	260.9	87.75	259.1	83.98	244.4	81.49	236.8	79.83	229.2	77.51	212.7	73.86
	-7.0	-7.6	272.8	85.39	259.5	81.81	244.4	79.41	236.8	77.69	229.2	75.44	212.7	71.82
	-5.0	-5.6	275.7	82.26	259.5	78.92	244.4	76.63	236.8	74.87	229.2	72.69	212.7	69.14
	-3.0	-3.7	275.7	79.13	259.5	76.03	244.4	73.82	236.8	72.03	229.2	69.92	212.7	66.43
	0.0	-0.7	275.7	74.45	259.5	71.68	244.4	69.64	236.8	67.77	229.2	65.77	212.7	62.39
	3.0	2.2	275.7	69.74	259.5	67.32	244.4	65.45	236.8	63.52	229.2	61.65	212.7	58.31
	5.0	4.1	270.2	60.32	254.4	58.24	239.3	56.59	232.1	54.79	224.6	53.14	208.4	50.15
	7.0	6.0	263.4	56.52	247.9	54.76	233.2	53.28	226.0	51.49	218.8	49.94	203.4	47.09
	9.0	7.9	253.7	52.02	238.6	50.44	224.6	49.07	217.8	47.38	210.9	45.98	195.8	43.37
	11.0	9.8	240.0	47.73	225.7	46.26	212.4	45.00	205.9	43.48	199.4	42.18	185.1	39.76
	13.0	11.8	225.3	42.40	212.0	41.10	199.5	40.01	193.3	38.64	187.2	37.48	173.9	35.34
15.0	13.7	213.1	38.29	200.5	37.10	189.0	36.11	182.9	34.88	177.2	33.83	164.6	31.91	
80	-24.8	-25	159.6	79.38	159.6	80.91	158.5	81.97	158.5	82.48	158.5	85.00	155.6	81.45
	-21.8	-22	194.8	80.91	194.8	82.41	194.8	83.47	194.8	85.00	194.8	81.45	190.1	78.01
	-19.8	-20	206.8	81.90	206.8	83.43	206.8	85.00	206.8	82.50	204.4	79.06	190.1	75.72
	-18.8	-19	211.5	82.41	211.5	85.00	211.5	83.74	211.5	81.24	204.4	77.87	190.1	74.59
	-16.7	-17	218.5	85.00	218.5	82.37	218.5	81.07	212.0	78.60	204.4	75.40	190.1	72.20
	-13.7	-15	228.5	81.10	223.9	78.57	218.5	77.27	212.0	74.84	204.4	71.82	190.1	68.76
	-11.8	-13	234.0	78.60	227.1	76.18	218.5	74.84	212.0	72.45	204.4	69.56	190.1	66.58
	-9.8	-11	240.1	76.00	230.4	73.68	218.5	72.31	212.0	69.95	204.4	67.18	190.1	64.29
	-9.5	-10	241.9	75.61	231.8	73.29	218.5	71.92	212.0	69.56	204.4	66.82	190.1	63.97
	-8.5	-9.1	244.4	74.31	232.8	72.03	218.5	70.65	212.0	68.30	204.4	65.66	190.1	62.81
	-7.0	-7.6	246.9	72.34	232.8	70.13	218.5	68.75	212.0	66.43	204.4	63.87	190.1	61.09
	-5.0	-5.6	246.9	69.74	232.8	67.63	218.5	66.19	212.0	63.90	204.4	61.48	190.1	58.80
	-3.0	-3.7	246.9	67.14	232.8	65.10	218.5	63.66	212.0	61.40	204.4	59.12	190.1	56.52
	0.0	-0.7	246.9	63.20	232.8	61.33	218.5	59.86	212.0	57.64	204.4	55.53	190.1	53.11
	3.0	2.2	246.9	59.30	232.8	57.54	218.5	56.03	212.0	53.85	204.4	51.98	190.1	49.66
	5.0	4.1	241.9	51.24	228.2	49.70	214.2	48.32	207.7	46.35	200.2	44.74	186.5	42.73
	7.0	6.0	235.8	48.11	222.4	46.74	208.8	45.34	202.3	43.47	195.1	42.03	181.5	40.13
	9.0	7.9	227.1	43.12	214.2	41.92	200.9	40.87	195.1	39.29	187.9	37.89	175.0	36.09
	11.0	9.8	214.9	38.31	202.3	37.26	190.1	36.31	184.4	34.91	177.9	33.68	165.3	32.07
	13.0	11.8	201.6	33.30	190.1	32.35	178.6	31.55	173.2	30.32	167.1	29.23	155.3	27.86
15.0	13.7	190.8	30.04	180.0	29.17	168.9	28.46	163.9	27.35	158.1	26.39	147.0	25.13	

# 7. Capacity Tables

Heating Capacity (86HP)

Combination (%)	Outdoor air temp.		Indoor air temp. °C DB											
			16		18		20		21		22		24	
	°C DB	°C WB	TC	PI	TC	PI	TC	PI	TC	PI	TC	PI	TC	PI
70	-24.8	-25	159.6	79.97	159.6	80.48	158.5	81.50	158.5	83.03	158.5	79.13	155.6	75.47
	-21.8	-22	187.2	81.50	187.2	82.01	186.1	83.03	179.7	79.13	174.3	75.47	162.8	71.95
	-19.8	-20	205.7	82.52	197.7	83.03	186.1	80.29	179.7	76.53	174.3	73.05	162.8	69.60
	-18.8	-19	209.5	83.03	197.7	81.62	186.1	78.92	179.7	75.23	174.3	71.82	162.8	68.40
	-16.7	-17	209.5	80.08	197.7	78.64	186.1	76.07	179.7	72.49	174.3	69.28	162.8	65.94
	-13.7	-15	209.5	75.93	197.7	74.42	186.1	71.96	179.7	68.61	174.3	65.63	162.8	62.39
	-11.8	-13	209.5	73.26	197.7	71.74	186.1	69.35	179.7	66.12	174.3	63.31	162.8	60.17
	-9.8	-11	209.5	70.48	197.7	68.90	186.1	66.64	179.7	63.52	174.3	60.88	162.8	57.82
	-9.5	-10	209.5	70.06	197.7	68.48	186.1	66.22	179.7	63.13	174.3	60.52	162.8	57.47
	-8.5	-9.1	209.5	68.68	197.7	67.07	186.1	64.85	179.7	61.83	174.3	59.30	162.8	56.27
	-7.0	-7.6	209.5	66.58	197.7	64.96	186.1	62.81	179.7	59.89	174.3	57.47	162.8	54.51
	-5.0	-5.6	209.5	63.80	197.7	62.14	186.1	60.07	179.7	57.29	174.3	55.04	162.8	52.16
	-3.0	-3.7	209.5	61.02	197.7	59.30	186.1	57.33	179.7	54.69	174.3	52.61	162.8	49.80
	0.0	-0.7	209.5	56.83	197.7	55.08	186.1	53.25	179.7	50.79	174.3	48.96	162.8	46.28
	3.0	2.2	209.5	52.65	197.7	50.85	186.1	49.13	179.7	46.91	174.3	45.30	162.8	42.73
	5.0	4.1	209.5	46.07	193.7	43.40	182.2	41.96	176.1	39.99	170.7	38.72	159.5	36.47
	7.0	6.0	209.5	44.00	188.7	40.23	177.5	38.87	171.4	37.11	166.4	35.98	155.3	33.84
	9.0	7.9	202.0	38.10	181.8	34.80	171.1	33.64	165.3	32.13	160.3	31.14	149.5	29.28
	11.0	9.8	191.1	33.79	172.1	30.87	161.7	29.85	156.3	28.49	151.7	27.64	141.6	25.99
	13.0	11.8	179.3	29.62	161.7	27.09	152.0	26.18	146.6	24.99	142.3	24.22	132.9	22.78
15.0	13.7	169.6	26.40	152.7	24.12	143.8	23.32	138.7	22.26	134.8	21.60	125.8	20.30	
60	-24.8	-25	159.4	78.95	159.4	79.97	158.3	81.50	154.2	77.32	148.8	73.42	139.4	69.73
	-21.8	-22	171.5	80.48	170.0	81.50	159.5	77.32	154.2	73.42	148.8	69.73	139.4	66.18
	-19.8	-20	179.7	81.50	170.0	78.55	159.5	74.55	154.2	70.82	148.8	67.28	139.4	63.80
	-18.8	-19	179.7	80.03	170.0	77.08	159.5	73.14	154.2	69.49	148.8	66.05	139.4	62.60
	-16.7	-17	179.7	76.90	170.0	73.99	159.5	70.23	154.2	66.75	148.8	63.48	139.4	60.11
	-13.7	-15	179.7	72.44	170.0	69.59	159.5	66.08	154.2	62.85	148.8	59.79	139.4	56.56
	-11.8	-13	179.7	69.63	170.0	66.79	159.5	63.42	154.2	60.36	148.8	57.47	139.4	54.31
	-9.8	-11	179.7	66.68	170.0	63.84	159.5	60.64	154.2	57.76	148.8	55.01	139.4	51.92
	-9.5	-10	179.7	66.23	170.0	63.41	159.5	60.22	154.2	57.37	148.8	54.63	139.4	51.57
	-8.5	-9.1	179.7	64.75	170.0	61.94	159.5	58.85	154.2	56.07	148.8	53.40	139.4	50.38
	-7.0	-7.6	179.7	62.54	170.0	59.73	159.5	56.77	154.2	54.10	148.8	51.57	139.4	48.59
	-5.0	-5.6	179.7	59.55	170.0	56.78	159.5	53.97	154.2	51.50	148.8	49.12	139.4	46.23
	-3.0	-3.7	179.7	56.60	170.0	53.83	159.5	51.19	154.2	48.90	148.8	46.66	139.4	43.84
	0.0	-0.7	179.7	52.14	170.0	49.43	159.5	47.04	154.2	44.97	148.8	42.97	139.4	40.29
	3.0	2.2	179.7	47.68	170.0	45.01	159.5	42.86	154.2	41.07	148.8	39.31	139.4	36.71
	5.0	4.1	176.1	40.48	166.7	38.05	156.3	36.22	151.0	34.75	145.9	33.30	136.5	31.05
	7.0	6.0	171.4	37.17	162.4	34.82	152.4	33.20	147.3	31.90	142.3	30.60	133.0	28.45
	9.0	7.9	165.3	31.84	156.3	29.81	146.6	28.43	141.9	27.31	136.9	26.22	128.3	24.36
	11.0	9.8	156.3	28.24	148.0	26.45	138.7	25.22	134.0	24.23	129.4	23.25	121.1	21.60
	13.0	11.8	146.6	24.74	139.1	23.16	130.4	22.08	125.8	21.23	121.5	20.36	113.9	18.95
15.0	13.7	138.7	22.26	131.5	20.83	123.3	19.67	119.3	18.93	115.0	18.16	107.8	17.04	
50	-24.8	-25	149.9	69.05	141.3	70.58	132.9	66.89	128.6	63.44	124.3	60.18	115.7	57.15
	-21.8	-22	149.9	70.58	141.3	66.89	132.9	63.44	128.6	60.18	124.3	57.15	115.7	54.23
	-19.8	-20	149.9	68.02	141.3	64.43	132.9	61.16	128.6	58.00	124.3	55.11	115.7	52.26
	-18.8	-19	149.9	66.72	141.3	63.20	132.9	60.00	128.6	56.94	124.3	54.09	115.7	51.28
	-16.7	-17	149.9	64.04	141.3	60.63	132.9	57.60	128.6	54.65	124.3	51.98	115.7	49.24
	-13.7	-15	149.9	60.21	141.3	56.94	132.9	54.16	128.6	51.38	124.3	48.95	115.7	46.32
	-11.8	-13	149.9	57.78	141.3	54.62	132.9	51.98	128.6	49.31	124.3	47.02	115.7	44.45
	-9.8	-11	149.9	55.21	141.3	52.16	132.9	49.66	128.6	47.13	124.3	44.98	115.7	42.49
	-9.5	-10	149.9	54.83	141.3	51.80	132.9	49.34	128.6	46.81	124.3	44.70	115.7	42.20
	-8.5	-9.1	149.9	53.53	141.3	50.57	132.9	48.18	128.6	45.72	124.3	43.68	115.7	41.22
	-7.0	-7.6	149.9	51.63	141.3	48.74	132.9	46.46	128.6	44.10	124.3	42.17	115.7	39.78
	-5.0	-5.6	149.9	49.06	141.3	46.28	132.9	44.17	128.6	41.92	124.3	40.13	115.7	37.81
	-3.0	-3.7	149.9	46.49	141.3	43.82	132.9	41.85	128.6	39.74	124.3	38.09	115.7	35.87
	0.0	-0.7	149.9	42.66	141.3	40.13	132.9	38.41	128.6	36.47	124.3	35.06	115.7	32.92
	3.0	2.2	149.9	38.83	141.3	36.47	132.9	34.99	128.6	33.20	124.3	32.04	115.7	30.00
	5.0	4.1	147.0	32.81	138.7	30.74	130.1	29.54	126.1	28.07	121.8	27.12	113.6	25.36
	7.0	6.0	143.0	30.00	135.1	28.07	126.9	27.05	122.9	25.68	118.9	24.90	110.7	23.21
	9.0	7.9	138.0	25.94	130.1	24.29	122.2	23.41	118.2	22.25	114.3	21.55	106.7	20.10
	11.0	9.8	131.1	23.29	123.6	21.81	116.1	21.00	111.8	19.95	108.2	19.32	101.0	18.02
	13.0	11.8	122.5	20.18	115.4	18.91	108.5	18.21	105.0	17.41	101.7	16.77	94.5	15.72
15.0	13.7	115.7	18.20	109.3	17.04	102.8	16.41	99.5	15.60	96.3	15.11	89.5	14.09	

**Note**

1. TC: Total Capacity(kW), PI: Power Input(kW, Comp. + Outdoor fan motor)
2. Capacity tables show the average value of conditions which may occur.
3. The heating capacity table is based on the values expressed as Max. in the specification of the outdoor unit. (When measuring the Max. heating capacity, the setting status of the indoor unit is the same as that for measuring the heating capacity of the indoor unit.)

# 7. Capacity Tables

## ◆ ARUM880LTE5

Heating Capacity (88HP)

Combination (%)	Outdoor air temp.		Indoor air temp. °C DB											
			16		18		20		21		22		24	
	°C DB	°C WB	TC	PI	TC	PI	TC	PI	TC	PI	TC	PI	TC	PI
130	-24.8	-25	164.9	92.0	164.9	92.87	163.8	93.65	163.8	94.83	163.8	95.98	161.4	97.80
	-21.8	-22	203.2	93.75	203.2	94.65	201.8	95.43	201.8	96.64	201.8	97.80	198.5	99.58
	-19.8	-20	215.5	94.95	215.5	95.86	214.1	96.64	214.1	97.84	214.1	98.97	210.8	100.8
	-18.8	-19	220.7	95.56	220.7	96.46	219.3	97.24	219.3	98.45	219.3	99.58	215.7	101.4
	-16.7	-17	231.1	96.81	231.1	97.72	229.7	98.50	229.7	99.70	229.7	100.9	226.1	102.6
	-13.7	-15	246.0	98.62	246.0	99.53	244.5	100.3	244.5	101.5	244.5	102.6	240.6	98.97
	-11.8	-13	254.1	99.78	254.1	100.7	252.6	101.4	252.6	102.6	252.6	100.2	249.6	96.64
	-9.8	-11	262.6	101.0	262.6	101.9	261.1	102.6	261.1	100.1	261.1	97.61	259.0	94.19
	-9.5	-10	264.3	101.2	264.3	102.0	262.8	102.3	262.8	99.66	262.2	97.22	260.4	93.80
	-8.5	-9.1	270.4	101.7	270.4	102.6	268.9	100.9	268.9	98.34	266.6	95.92	265.1	92.57
	-7.0	-7.6	279.6	102.6	279.6	100.8	277.7	98.96	277.7	96.40	277.7	93.95	273.2	90.74
	-5.0	-5.6	291.8	100.2	291.8	98.18	289.9	96.31	289.9	93.79	289.9	91.37	282.9	88.29
	-3.0	-3.7	304.0	97.81	304.0	95.65	302.1	93.67	302.1	91.17	302.1	88.78	292.6	85.81
	0.0	-0.7	322.3	94.15	322.3	91.83	320.0	89.73	318.9	87.26	316.7	84.90	307.5	82.14
	3.0	2.2	335.1	90.52	335.1	87.98	333.1	85.76	331.5	83.36	329.3	80.99	308.6	78.47
	5.0	4.1	337.3	80.02	336.5	77.51	334.5	75.32	333.0	73.06	324.8	70.87	302.4	68.60
	7.0	6.0	336.5	76.22	335.8	73.77	334.1	71.64	328.1	69.56	316.4	67.47	294.6	65.46
	9.0	7.9	325.5	71.23	324.8	68.92	324.0	66.91	316.0	64.97	304.9	63.03	283.9	61.16
11.0	9.8	307.9	67.08	307.2	64.92	306.4	63.02	298.7	61.19	288.4	59.38	268.5	57.59	
13.0	11.8	289.1	61.99	288.7	60.00	287.7	58.24	280.6	56.55	270.7	54.87	252.0	53.22	
15.0	13.7	273.7	57.80	273.0	55.93	272.2	54.31	265.6	52.73	256.3	51.15	238.4	49.61	
120	-24.8	-25	163.8	92.87	163.8	93.65	162.7	94.83	162.7	95.98	162.7	97.80	160.3	99.05
	-21.8	-22	201.8	94.65	201.8	95.43	200.4	96.64	200.4	97.80	200.4	99.58	197.4	100.9
	-19.8	-20	214.1	95.86	214.1	96.64	212.6	97.84	212.6	98.97	212.6	100.8	209.3	102.0
	-18.8	-19	218.9	96.46	218.9	97.24	217.5	98.45	217.5	99.58	217.5	101.4	214.2	102.6
	-16.7	-17	229.3	97.72	229.3	98.50	227.9	99.70	227.9	100.9	227.9	102.6	224.3	100.3
	-13.7	-15	244.2	99.53	244.2	100.3	242.7	101.5	242.7	102.6	242.7	99.12	238.8	96.89
	-11.8	-13	252.3	100.7	252.3	101.4	250.8	102.6	250.8	100.2	250.8	96.89	247.8	94.76
	-9.8	-11	260.7	101.9	260.7	102.6	259.2	99.92	259.2	97.54	259.2	94.56	257.1	92.50
	-9.5	-10	262.5	102.0	262.5	102.2	261.0	99.52	261.0	97.15	261.0	94.20	258.9	92.14
	-8.5	-9.1	268.6	102.6	268.6	100.8	266.8	98.16	266.8	95.85	266.3	93.05	263.9	91.02
	-7.0	-7.6	277.7	100.5	277.7	98.63	275.9	96.11	275.9	93.88	274.0	91.28	271.3	89.33
	-5.0	-5.6	289.9	97.71	289.9	95.76	288.0	93.39	288.0	91.26	288.0	88.92	281.0	87.07
	-3.0	-3.7	301.7	94.88	301.7	92.93	299.9	90.66	299.9	88.67	299.0	86.58	289.2	84.80
	0.0	-0.7	320.0	90.66	319.5	88.63	315.2	86.57	313.2	84.72	311.3	83.06	289.8	81.42
	3.0	2.2	332.5	86.44	331.8	84.33	327.8	82.48	321.9	80.80	311.9	79.54	289.8	78.04
	5.0	4.1	335.0	75.86	333.3	73.85	326.3	72.21	315.6	70.68	305.7	69.66	284.0	68.31
	7.0	6.0	334.6	71.90	331.1	69.96	318.2	68.57	307.5	67.25	297.9	66.63	276.6	65.43
	9.0	7.9	323.3	66.98	318.9	65.15	306.4	63.87	296.1	62.66	286.9	62.04	266.7	60.94
11.0	9.8	305.7	62.86	301.6	61.14	289.8	59.93	280.0	58.80	271.5	58.24	252.0	57.22	
13.0	11.8	287.2	57.87	283.2	56.29	272.2	55.19	263.0	54.13	254.9	53.61	236.9	52.66	
15.0	13.7	271.8	53.71	268.1	52.24	257.5	51.21	249.0	50.26	241.3	49.78	224.0	48.90	
110	-24.8	-25	163.0	93.65	163.0	94.83	162.0	95.98	162.0	97.80	162.0	99.05	159.3	99.66
	-21.8	-22	200.7	95.43	200.7	96.64	199.3	97.80	199.3	99.58	199.3	100.9	196.3	101.4
	-19.8	-20	213.0	96.64	213.0	97.84	211.5	98.97	211.5	100.8	211.5	102.0	208.2	102.6
	-18.8	-19	217.8	97.24	217.8	98.45	216.4	99.58	216.4	101.4	216.4	102.6	213.1	101.4
	-16.7	-17	228.2	98.50	228.2	99.70	226.8	100.9	226.8	102.6	226.8	100.1	223.2	98.71
	-13.7	-15	242.8	100.3	242.8	101.5	241.3	102.6	241.3	98.75	241.3	96.38	241.3	94.93
	-11.8	-13	250.8	101.4	250.8	102.6	249.4	99.91	249.4	96.27	249.4	94.03	249.4	92.51
	-9.8	-11	259.3	102.6	259.3	99.55	257.8	97.03	257.8	93.68	257.8	91.58	256.9	89.99
	-9.5	-10	261.0	102.1	261.0	99.08	259.6	96.56	259.6	93.28	259.6	91.22	258.7	89.62
	-8.5	-9.1	267.1	100.5	267.1	97.54	265.6	95.12	265.6	91.99	265.3	89.97	260.2	88.33
	-7.0	-7.6	276.2	97.97	276.2	95.23	274.4	92.96	274.4	90.04	272.9	88.13	260.8	86.45
	-5.0	-5.6	288.1	94.66	288.1	92.11	286.2	90.08	285.2	87.45	278.3	85.68	260.8	83.90
	-3.0	-3.7	300.2	91.32	300.2	89.01	295.4	87.17	289.1	84.82	279.2	83.20	260.8	81.37
	0.0	-0.7	316.2	86.32	312.8	84.37	298.7	82.85	289.1	80.93	279.2	79.52	260.8	77.58
	3.0	2.2	328.5	81.33	318.5	79.73	298.7	78.50	289.1	77.04	279.2	75.81	260.8	73.77
	5.0	4.1	330.3	70.74	311.9	69.40	292.8	68.38	283.2	67.21	273.7	66.19	255.6	64.25
	7.0	6.0	321.8	66.45	304.2	65.46	285.4	64.73	276.2	63.92	266.7	63.12	249.0	61.15
	9.0	7.9	310.1	61.56	292.8	60.64	274.8	59.95	265.9	59.22	257.1	58.48	239.9	56.65
11.0	9.8	293.2	57.44	277.0	56.56	260.0	55.93	251.6	55.27	243.1	54.54	226.9	52.86	
13.0	11.8	275.2	52.54	260.1	51.74	244.2	51.15	236.2	50.53	228.1	49.90	213.0	48.36	
15.0	13.7	260.4	48.38	246.1	47.65	231.0	47.10	223.3	46.54	215.9	45.95	201.6	44.52	

# 7. Capacity Tables

Heating Capacity (88HP)

Combination (%)	Outdoor air temp.		Indoor air temp. °C DB											
			16		18		20		21		22		24	
	°C DB	°C WB	TC	PI	TC	PI	TC	PI	TC	PI	TC	PI	TC	PI
100	-24.8	-25	162.3	103.8	162.3	103.7	161.2	97.43	161.2	103.3	161.2	103.1	158.5	103.1
	-21.8	-22	199.6	103.6	199.6	103.4	198.5	100.5	198.5	103.1	198.5	104.3	195.2	102.8
	-19.8	-20	211.9	103.4	211.9	103.3	210.8	102.5	210.8	102.9	210.8	103.2	207.5	102.6
	-18.8	-19	216.8	103.4	215.6	103.2	215.6	103.1	215.6	102.8	215.6	102.6	212.0	101.1
	-16.7	-17	225.7	103.2	225.7	103.0	225.7	104.3	224.6	102.6	224.6	99.43	221.0	97.79
	-13.7	-15	241.7	103.0	241.7	102.8	240.2	102.6	240.2	97.99	240.2	94.80	236.6	93.06
	-11.8	-13	249.7	102.8	248.3	102.6	248.3	99.54	248.3	95.03	248.3	91.88	238.1	90.09
	-9.8	-11	257.8	102.6	257.8	99.18	256.7	96.26	256.7	91.92	253.7	88.81	238.3	86.95
	-9.5	-10	259.6	102.1	259.6	98.65	258.5	95.79	258.5	91.45	254.3	88.34	238.3	86.48
	-8.5	-9.1	265.6	100.3	265.6	96.91	264.5	94.14	264.5	89.90	255.7	86.82	238.3	84.89
	-7.0	-7.6	279.2	97.60	278.1	94.32	273.3	91.68	264.5	87.59	255.7	84.50	238.3	82.54
	-5.0	-5.6	291.4	93.97	288.4	90.86	273.3	88.43	264.5	84.45	255.7	81.43	238.3	79.40
	-3.0	-3.7	299.8	90.37	290.9	87.37	273.3	85.16	264.5	81.35	255.7	78.36	238.3	76.25
	0.0	-0.7	308.3	84.93	290.9	82.17	273.3	80.25	264.5	76.69	255.7	73.74	238.3	71.55
	3.0	2.2	308.3	79.50	290.9	76.95	273.3	75.35	264.5	72.03	255.7	69.11	238.3	66.85
	5.0	4.1	302.0	68.88	285.1	66.61	267.8	65.23	259.3	62.30	250.8	59.64	233.6	57.52
	7.0	6.0	294.3	64.33	277.7	62.31	261.1	61.22	252.7	58.58	244.3	56.05	227.7	53.90
	9.0	7.9	283.6	59.26	267.4	57.39	251.6	56.40	243.5	53.95	235.4	51.61	219.2	49.64
	11.0	9.8	268.2	54.92	253.1	53.17	237.6	52.25	230.2	49.99	222.5	47.83	207.4	46.00
	13.0	11.8	251.9	49.82	237.6	48.25	223.3	47.41	216.3	45.36	208.9	43.42	194.6	41.74
15.0	13.7	238.3	45.48	224.8	44.06	211.2	43.29	204.5	41.39	197.9	39.60	184.3	38.10	
90	-24.8	-25	161.6	92.24	161.6	94.02	160.5	95.31	160.5	95.88	160.5	97.09	158.1	98.90
	-21.8	-22	198.9	94.02	198.9	95.83	197.8	97.09	197.8	97.69	197.8	98.90	194.5	94.77
	-19.8	-20	211.2	95.23	211.2	97.04	209.7	98.29	209.7	98.90	209.7	96.07	206.4	92.01
	-18.8	-19	216.8	95.83	215.6	97.64	214.6	98.90	214.6	97.46	214.6	94.67	211.3	90.64
	-16.7	-17	225.7	97.09	225.7	98.90	224.9	95.93	224.9	94.42	224.9	91.73	216.8	87.73
	-13.7	-15	241.7	98.90	241.7	94.47	239.5	91.67	239.5	90.09	233.5	87.50	217.8	83.60
	-11.8	-13	249.7	95.87	248.3	91.68	247.2	88.96	241.2	87.33	234.6	84.85	217.8	80.98
	-9.8	-11	257.8	92.72	257.8	88.75	249.0	86.13	242.4	84.43	234.6	82.02	217.8	78.22
	-9.5	-10	259.6	92.23	259.6	88.29	249.6	85.70	242.4	84.00	234.6	81.59	217.8	77.79
	-8.5	-9.1	265.6	90.66	263.8	86.82	250.1	84.27	242.4	82.57	234.6	80.19	217.8	76.43
	-7.0	-7.6	279.2	88.27	265.6	84.61	250.1	82.16	242.4	80.39	234.6	78.08	217.8	74.35
	-5.0	-5.6	282.2	85.09	265.6	81.68	250.1	79.33	242.4	77.52	234.6	75.28	217.8	71.61
	-3.0	-3.7	282.2	81.92	265.6	78.75	250.1	76.48	242.4	74.62	234.6	72.45	217.8	68.85
	0.0	-0.7	282.2	77.17	265.6	74.32	250.1	72.22	242.4	70.29	234.6	68.22	217.8	64.72
	3.0	2.2	282.2	72.40	265.6	69.89	250.1	67.97	242.4	65.96	234.6	64.02	217.8	60.56
	5.0	4.1	276.6	62.67	260.4	60.52	245.0	58.81	237.6	56.94	229.9	55.23	213.4	52.13
	7.0	6.0	269.6	58.80	253.8	56.97	238.7	55.44	231.4	53.57	224.0	51.96	208.2	49.00
	9.0	7.9	259.7	54.14	244.3	52.49	229.9	51.07	222.9	49.31	215.9	47.85	200.5	45.14
	11.0	9.8	245.7	49.69	231.0	48.16	217.4	46.84	210.8	45.27	204.1	43.92	189.4	41.40
	13.0	11.8	230.6	44.16	217.0	42.80	204.2	41.67	197.9	40.24	191.6	39.04	178.0	36.81
15.0	13.7	218.1	39.89	205.3	38.66	193.4	37.63	187.2	36.35	181.3	35.26	168.5	33.25	
80	-24.8	-25	160.9	81.03	160.9	82.84	159.8	84.10	159.8	84.70	159.8	87.69	157.4	84.06
	-21.8	-22	196.7	82.84	196.7	84.62	196.7	85.88	196.7	87.69	196.7	84.06	192.8	80.54
	-19.8	-20	209.0	84.02	209.0	85.83	209.0	87.69	209.0	85.14	206.9	81.62	194.6	78.21
	-18.8	-19	213.8	84.62	213.8	87.69	213.8	86.40	213.8	83.85	207.8	80.40	194.6	77.05
	-16.7	-17	221.6	87.69	221.6	85.00	221.6	83.68	216.2	81.16	209.3	77.89	194.6	74.61
	-13.7	-15	233.9	83.72	229.2	81.14	223.7	79.81	217.0	77.32	209.3	74.23	194.6	71.09
	-11.8	-13	239.5	81.19	232.5	78.71	223.7	77.34	217.0	74.89	209.3	71.93	194.6	68.87
	-9.8	-11	245.4	78.54	235.6	76.17	223.7	74.76	217.0	72.34	209.3	69.49	194.6	66.53
	-9.5	-10	247.2	78.15	237.1	75.77	223.7	74.36	217.0	71.94	209.3	69.13	194.6	66.20
	-8.5	-9.1	249.9	76.82	238.3	74.49	223.7	73.07	217.0	70.66	209.3	67.94	194.6	65.02
	-7.0	-7.6	252.7	74.82	238.3	72.56	223.7	71.14	217.0	68.75	209.3	66.12	194.6	63.26
	-5.0	-5.6	252.7	72.18	238.3	70.01	223.7	68.53	217.0	66.17	209.3	63.68	194.6	60.92
	-3.0	-3.7	252.7	69.53	238.3	67.44	223.7	65.95	217.0	63.62	209.3	61.27	194.6	58.59
	0.0	-0.7	252.7	65.53	238.3	63.61	223.7	62.08	217.0	59.79	209.3	57.61	194.6	55.10
	3.0	2.2	252.7	61.56	238.3	59.75	223.7	58.18	217.0	55.92	209.3	53.99	194.6	51.58
	5.0	4.1	247.6	53.25	233.6	51.64	219.2	50.22	212.6	48.17	204.9	46.50	190.9	44.41
	7.0	6.0	241.3	50.06	227.7	48.63	213.7	47.17	207.1	45.22	199.7	43.73	185.8	41.75
	9.0	7.9	232.5	44.87	219.2	43.62	205.7	42.53	199.7	40.88	192.4	39.42	179.1	37.56
	11.0	9.8	220.0	39.88	207.1	38.78	194.6	37.80	188.7	36.33	182.1	35.05	169.2	33.38
	13.0	11.8	206.4	34.67	194.6	33.69	182.8	32.85	177.3	31.57	171.0	30.44	158.9	29.01
15.0	13.7	195.3	31.30	184.3	30.39	172.9	29.65	167.7	28.49	161.8	27.50	150.4	26.19	

# 7. Capacity Tables

Heating Capacity (88HP)

Combination (%)	Outdoor air temp.		Indoor air temp. °C DB											
			16		18		20		21		22		24	
	°C DB	°C WB	TC	PI	TC	PI	TC	PI	TC	PI	TC	PI	TC	PI
70	-24.8	-25	160.9	81.84	160.9	82.44	159.8	83.65	159.8	85.46	159.8	81.48	157.4	77.76
	-21.8	-22	190.4	83.65	190.7	84.25	189.5	85.46	183.9	81.48	178.4	77.76	166.6	74.17
	-19.8	-20	208.1	84.85	201.2	85.46	190.5	82.67	183.9	78.84	178.4	75.29	166.6	71.77
	-18.8	-19	212.0	85.46	202.1	84.03	190.5	81.28	183.9	77.51	178.4	74.04	166.6	70.55
	-16.7	-17	214.1	82.47	202.3	81.00	190.5	78.38	183.9	74.72	178.4	71.45	166.6	68.04
	-13.7	-15	214.4	78.25	202.3	76.71	190.5	74.20	183.9	70.78	178.4	67.73	166.6	64.42
	-11.8	-13	214.4	75.54	202.3	73.99	190.5	71.55	183.9	68.24	178.4	65.37	166.6	62.15
	-9.8	-11	214.4	72.72	202.3	71.10	190.5	68.79	183.9	65.59	178.4	62.89	166.6	59.75
	-9.5	-10	214.4	72.30	202.3	70.67	190.5	68.37	183.9	65.20	178.4	62.53	166.6	59.39
	-8.5	-9.1	214.4	70.90	202.3	69.24	190.5	66.97	183.9	63.88	178.4	61.28	166.6	58.17
	-7.0	-7.6	214.4	68.76	202.3	67.10	190.5	64.90	183.9	61.90	178.4	59.42	166.6	56.38
	-5.0	-5.6	214.4	65.94	202.3	64.24	190.5	62.11	183.9	59.26	178.4	56.95	166.6	53.98
	-3.0	-3.7	214.4	63.12	202.3	61.35	190.5	59.32	183.9	56.61	178.4	54.47	166.6	51.57
	0.0	-0.7	214.4	58.88	202.3	57.06	190.5	55.17	183.9	52.63	178.4	50.75	166.6	47.98
	3.0	2.2	214.4	54.63	202.3	52.77	190.5	50.99	183.9	48.69	178.4	47.02	166.6	44.36
	5.0	4.1	214.4	47.87	198.3	45.09	186.5	43.58	180.2	41.55	174.8	40.23	163.3	37.89
	7.0	6.0	214.5	45.78	193.1	41.86	181.7	40.43	175.5	38.61	170.3	37.44	158.9	35.20
	9.0	7.9	206.7	39.65	186.1	36.22	175.1	35.01	169.2	33.43	164.1	32.41	153.0	30.47
	11.0	9.8	195.7	35.18	176.2	32.14	165.6	31.08	160.0	29.66	155.2	28.78	144.9	27.06
	13.0	11.8	183.6	30.85	165.5	28.21	155.6	27.27	150.1	26.02	145.7	25.22	136.1	23.72
15.0	13.7	173.6	27.51	156.4	25.14	147.1	24.30	142.0	23.20	137.9	22.50	128.7	21.15	
60	-24.8	-25	160.9	80.63	160.9	81.84	159.8	83.65	156.5	79.41	152.0	75.45	142.7	71.70
	-21.8	-22	174.6	82.44	174.0	83.65	163.3	79.41	157.8	75.45	152.3	71.70	142.7	68.09
	-19.8	-20	183.9	83.65	174.0	80.66	163.3	76.59	157.8	72.81	152.3	69.20	142.7	65.66
	-18.8	-19	183.9	82.15	174.0	79.16	163.3	75.17	157.8	71.46	152.3	67.95	142.7	64.44
	-16.7	-17	183.9	78.99	174.0	76.03	163.3	72.21	157.8	68.67	152.3	65.34	142.7	61.90
	-13.7	-15	183.9	74.48	174.0	71.58	163.3	68.00	157.8	64.71	152.3	61.60	142.7	58.29
	-11.8	-13	183.9	71.64	174.0	68.73	163.3	65.30	157.8	62.18	152.3	59.24	142.7	56.00
	-9.8	-11	183.9	68.65	174.0	65.75	163.3	62.48	157.8	59.54	152.3	56.74	142.7	53.57
	-9.5	-10	183.9	68.19	174.0	65.32	163.3	62.06	157.8	59.15	152.3	56.35	142.7	53.21
	-8.5	-9.1	183.9	66.70	174.0	63.82	163.3	60.66	157.8	57.83	152.3	55.10	142.7	52.00
	-7.0	-7.6	183.9	64.46	174.0	61.58	163.3	58.56	157.8	55.83	152.3	53.24	142.7	50.18
	-5.0	-5.6	183.9	61.45	174.0	58.59	163.3	55.71	157.8	53.19	152.3	50.74	142.7	47.78
	-3.0	-3.7	183.9	58.46	174.0	55.60	163.3	52.90	157.8	50.55	152.3	48.25	142.7	45.35
	0.0	-0.7	183.9	53.95	174.0	51.15	163.3	48.69	157.8	46.56	152.3	44.50	142.7	41.73
	3.0	2.2	183.9	49.44	174.0	46.67	163.3	44.45	157.8	42.60	152.3	40.78	142.7	38.09
	5.0	4.1	180.2	42.03	170.7	39.51	160.0	37.61	154.5	36.09	149.3	34.59	139.8	32.25
	7.0	6.0	175.5	38.68	166.3	36.23	155.9	34.54	150.8	33.19	145.6	31.84	136.1	29.60
	9.0	7.9	169.2	33.14	160.0	31.02	150.1	29.59	145.3	28.42	140.1	27.29	131.3	25.35
	11.0	9.8	160.0	29.40	151.5	27.53	142.0	26.25	137.2	25.23	132.4	24.20	124.0	22.49
	13.0	11.8	150.1	25.77	142.3	24.13	133.5	22.99	128.8	22.11	124.4	21.20	116.6	19.74
15.0	13.7	142.0	23.20	134.6	21.70	126.2	20.50	122.1	19.73	117.7	18.92	110.3	17.75	
50	-24.8	-25	153.4	71.00	144.6	72.81	136.1	69.03	131.7	65.50	127.3	62.14	118.5	59.04
	-21.8	-22	153.4	72.81	144.6	69.03	136.1	65.50	131.7	62.14	127.3	59.04	118.5	56.04
	-19.8	-20	153.4	70.18	144.6	66.51	136.1	63.15	131.7	59.91	127.3	56.95	118.5	54.02
	-18.8	-19	153.4	68.86	144.6	65.25	136.1	61.97	131.7	58.82	127.3	55.90	118.5	53.01
	-16.7	-17	153.4	66.12	144.6	62.62	136.1	59.51	131.7	56.48	127.3	53.74	118.5	50.91
	-13.7	-15	153.4	62.19	144.6	58.84	136.1	55.98	131.7	53.12	127.3	50.63	118.5	47.91
	-11.8	-13	153.4	59.71	144.6	56.46	136.1	53.74	131.7	51.00	127.3	48.65	118.5	46.00
	-9.8	-11	153.4	57.08	144.6	53.94	136.1	51.37	131.7	48.76	127.3	46.56	118.5	43.98
	-9.5	-10	153.4	56.69	144.6	53.57	136.1	51.04	131.7	48.44	127.3	46.26	118.5	43.69
	-8.5	-9.1	153.4	55.36	144.6	52.31	136.1	49.85	131.7	47.32	127.3	45.22	118.5	42.68
	-7.0	-7.6	153.4	53.41	144.6	50.44	136.1	48.09	131.7	45.66	127.3	43.67	118.5	41.20
	-5.0	-5.6	153.4	50.78	144.6	47.92	136.1	45.74	131.7	43.42	127.3	41.57	118.5	39.18
	-3.0	-3.7	153.4	48.16	144.6	45.40	136.1	43.37	131.7	41.19	127.3	39.48	118.5	37.19
	0.0	-0.7	153.4	44.23	144.6	41.61	136.1	39.84	131.7	37.83	127.3	36.38	118.5	34.16
	3.0	2.2	153.4	40.31	144.6	37.86	136.1	36.33	131.7	34.48	127.3	33.27	118.5	31.16
	5.0	4.1	150.4	34.09	142.0	31.94	133.2	30.70	129.1	29.17	124.7	28.18	116.2	26.36
	7.0	6.0	146.4	31.21	138.3	29.20	129.9	28.14	125.8	26.71	121.7	25.91	113.3	24.15
	9.0	7.9	141.2	27.00	133.2	25.28	125.1	24.36	121.0	23.15	117.0	22.42	109.2	20.92
	11.0	9.8	134.2	24.24	126.5	22.70	118.8	21.86	114.4	20.77	110.7	20.11	103.3	18.76
	13.0	11.8	125.4	21.02	118.1	19.70	111.1	18.97	107.4	18.13	104.1	17.47	96.8	16.38
15.0	13.7	118.5	18.96	111.8	17.76	105.2	17.10	101.9	16.26	98.5	15.75	91.6	14.69	

**Note**

1. TC: Total Capacity(kW), PI : Power Input(kW, Comp. + Outdoor fan motor)
2. Capacity tables show the average value of conditions which may occur.
3. The heating capacity table is based on the values expressed as Max. in the specification of the outdoor unit. (When measuring the Max. heating capacity, the setting status of the indoor unit is the same as that for measuring the heating capacity of the indoor unit.)

# 7. Capacity Tables

## ◆ ARUM900LTE5

Heating Capacity (90HP)

Combination (%)	Outdoor air temp.		Indoor air temp. °C DB											
			16		18		20		21		22		24	
	°C DB	°C WB	TC	PI	TC	PI	TC	PI	TC	PI	TC	PI	TC	PI
130	-24.8	-25	173.5	94.8	173.5	95.52	172.3	96.16	172.3	97.12	172.3	98.08	169.2	99.57
	-21.8	-22	212.2	96.24	212.2	96.98	210.7	97.62	210.7	98.61	210.7	99.57	206.6	101.0
	-19.8	-20	224.3	97.23	224.3	97.97	222.8	98.61	222.8	99.61	222.8	100.5	218.6	102.0
	-18.8	-19	229.4	97.72	229.4	98.47	227.9	99.11	227.9	100.1	227.9	101.0	223.4	102.5
	-16.7	-17	239.7	98.76	239.7	99.50	238.1	100.1	238.1	101.1	238.1	102.1	233.6	103.6
	-13.7	-15	254.4	100.2	254.4	101.0	252.8	101.6	252.8	102.6	252.8	103.6	248.0	99.70
	-11.8	-13	262.6	101.2	262.6	101.9	261.1	102.6	261.1	103.6	261.1	101.0	257.1	97.25
	-9.8	-11	271.3	102.2	271.3	102.9	269.8	103.6	269.8	100.8	269.8	98.25	266.7	94.69
	-9.5	-10	272.8	102.3	272.8	103.1	271.3	103.1	271.3	100.4	270.9	97.84	268.2	94.28
	-8.5	-9.1	278.1	102.8	278.1	103.6	276.6	101.7	276.6	99.00	275.4	96.48	272.9	93.00
	-7.0	-7.6	286.0	103.6	286.0	101.5	284.2	99.62	284.2	96.94	284.2	94.40	280.0	91.07
	-5.0	-5.6	296.6	100.9	296.6	98.76	294.7	96.81	294.7	94.18	294.7	91.68	289.5	88.51
	-3.0	-3.7	307.1	98.29	307.1	96.04	305.2	93.99	305.2	91.41	305.2	88.96	299.1	85.92
	0.0	-0.7	322.9	94.32	322.9	91.94	320.7	89.80	320.7	87.28	320.7	84.88	313.7	82.07
	3.0	2.2	338.8	90.38	338.8	87.81	336.5	85.57	336.5	83.14	336.5	80.76	315.7	78.22
	5.0	4.1	342.9	79.72	342.2	77.20	340.0	75.01	340.0	72.75	332.3	70.55	309.3	68.28
	7.0	6.0	344.1	75.72	343.4	73.29	341.4	71.17	335.6	69.10	323.7	67.03	301.4	65.03
	9.0	7.9	333.1	70.57	332.3	68.28	331.5	66.29	323.2	64.37	312.0	62.44	290.5	60.59
	11.0	9.8	315.0	66.25	314.3	64.12	313.5	62.24	305.6	60.43	295.0	58.65	274.7	56.88
	13.0	11.8	295.8	61.01	295.4	59.05	294.3	57.32	287.1	55.66	277.0	54.00	257.8	52.37
15.0	13.7	280.0	56.66	279.2	54.82	278.5	53.24	271.7	51.69	262.3	50.14	243.9	48.63	
120	-24.8	-25	172.3	95.52	172.3	96.16	171.2	97.12	171.2	98.08	171.2	99.57	168.1	100.6
	-21.8	-22	210.7	96.98	210.7	97.62	209.2	98.61	209.2	99.57	209.2	101.0	205.4	102.1
	-19.8	-20	222.7	97.97	222.7	98.61	221.2	99.61	221.2	100.5	221.2	102.0	217.1	103.1
	-18.8	-19	227.5	98.47	227.5	99.11	226.0	100.1	226.0	101.0	226.0	102.5	221.9	103.6
	-16.7	-17	237.8	99.50	237.8	100.1	236.3	101.1	236.3	102.1	236.3	103.6	231.8	101.1
	-13.7	-15	252.5	101.0	252.5	101.6	251.0	102.6	251.0	103.6	251.0	99.85	246.1	97.52
	-11.8	-13	260.8	101.9	260.8	102.6	259.2	103.6	259.2	100.9	259.2	97.51	255.3	95.29
	-9.8	-11	269.4	102.9	269.4	103.6	267.9	100.7	267.9	98.18	267.9	95.05	264.8	92.92
	-9.5	-10	270.9	103.1	270.9	103.1	269.4	100.3	269.4	97.77	269.4	94.68	266.3	92.55
	-8.5	-9.1	276.2	103.6	276.2	101.6	274.4	98.81	274.4	96.40	274.2	93.47	270.8	91.38
	-7.0	-7.6	284.1	101.3	284.1	99.30	282.2	96.66	282.2	94.33	281.8	91.62	278.1	89.60
	-5.0	-5.6	294.6	98.29	294.6	96.26	292.8	93.78	292.8	91.57	292.8	89.13	287.6	87.23
	-3.0	-3.7	304.9	95.28	304.9	93.26	303.0	90.90	303.0	88.85	303.0	86.68	295.7	84.86
	0.0	-0.7	320.7	90.78	320.7	88.70	318.5	86.59	318.5	84.70	318.5	82.98	296.5	81.32
	3.0	2.2	336.2	86.28	336.2	84.15	334.2	82.28	329.3	80.58	319.1	79.28	296.5	77.77
	5.0	4.1	340.7	75.57	339.6	73.55	333.8	71.90	322.9	70.37	312.7	69.34	290.5	67.99
	7.0	6.0	342.2	71.43	338.7	69.50	325.5	68.12	314.6	66.81	304.8	66.19	283.0	65.00
	9.0	7.9	330.8	66.37	326.3	64.55	313.5	63.28	302.9	62.08	293.5	61.47	272.8	60.38
	11.0	9.8	312.7	62.11	308.6	60.41	296.5	59.21	286.4	58.09	277.7	57.54	257.8	56.53
	13.0	11.8	293.9	56.98	289.8	55.43	278.5	54.34	269.1	53.30	260.8	52.79	242.3	51.85
15.0	13.7	278.1	52.69	274.3	51.25	263.4	50.24	254.7	49.30	246.8	48.83	229.2	47.96	
110	-24.8	-25	171.5	96.16	171.5	97.12	170.4	98.08	170.4	99.57	170.4	100.6	167.0	101.1
	-21.8	-22	209.6	97.62	209.6	98.61	208.1	99.57	208.1	101.0	208.1	102.1	204.3	102.6
	-19.8	-20	221.6	98.61	221.6	99.61	220.1	100.5	220.1	102.0	220.1	103.1	215.9	103.6
	-18.8	-19	226.4	99.11	226.4	100.1	224.9	101.0	224.9	102.5	224.9	103.6	220.7	102.2
	-16.7	-17	236.6	100.1	236.6	101.1	235.1	102.1	235.1	103.6	235.1	100.9	230.6	99.46
	-13.7	-15	251.0	101.6	251.0	102.6	249.5	103.6	249.5	99.48	249.5	97.01	249.5	95.52
	-11.8	-13	259.3	102.6	259.3	103.6	257.7	100.7	257.7	96.89	257.7	94.57	257.7	93.01
	-9.8	-11	267.9	103.6	267.9	100.3	266.4	97.67	266.4	94.18	266.4	92.01	264.8	90.39
	-9.5	-10	269.4	103.0	269.4	99.82	267.9	97.19	267.9	93.77	267.9	91.63	266.8	90.01
	-8.5	-9.1	274.7	101.3	274.7	98.20	273.2	95.68	273.2	92.41	273.2	90.32	266.8	88.66
	-7.0	-7.6	282.6	98.64	282.6	95.78	280.7	93.42	280.7	90.38	280.7	88.41	266.8	86.71
	-5.0	-5.6	292.8	95.17	292.8	92.51	290.9	90.41	290.9	87.67	285.6	85.85	266.8	84.05
	-3.0	-3.7	303.3	91.66	303.3	89.27	301.5	87.36	295.8	84.93	285.6	83.26	266.8	81.43
	0.0	-0.7	318.8	86.42	318.8	84.41	305.6	82.84	295.8	80.87	285.6	79.43	266.8	77.49
	3.0	2.2	334.3	81.17	325.9	79.55	305.6	78.29	295.8	76.81	285.6	75.56	266.8	73.52
	5.0	4.1	337.9	70.47	319.1	69.11	299.6	68.08	289.8	66.90	280.0	65.88	261.5	63.95
	7.0	6.0	329.2	66.01	311.2	65.03	292.0	64.30	282.6	63.51	272.8	62.70	254.8	60.75
	9.0	7.9	317.2	61.00	299.6	60.09	281.1	59.41	272.1	58.68	263.0	57.95	245.4	56.14
	11.0	9.8	299.9	56.75	283.4	55.89	266.0	55.27	257.4	54.61	248.7	53.89	232.2	52.23
	13.0	11.8	281.5	51.75	266.1	50.95	249.9	50.38	241.6	49.76	233.3	49.14	217.9	47.63
15.0	13.7	266.4	47.47	251.8	46.75	236.3	46.21	228.5	45.67	220.9	45.09	206.2	43.68	



# 7. Capacity Tables

Heating Capacity (90HP)

Combination (%)	Outdoor air temp.		Indoor air temp. °C DB											
			16		18		20		21		22		24	
	°C DB	°C WB	TC	PI	TC	PI	TC	PI	TC	PI	TC	PI	TC	PI
100	-24.8	-25	170.7	105.5	170.7	105.2	169.6	98.65	169.6	104.6	169.6	104.3	166.2	104.2
	-21.8	-22	208.5	105.1	208.5	104.8	207.3	101.8	207.3	104.2	207.3	105.2	203.2	103.8
	-19.8	-20	220.5	104.8	220.5	104.6	219.3	103.7	219.3	104.0	219.3	104.1	215.2	103.6
	-18.8	-19	225.3	104.7	224.1	104.5	224.1	104.2	224.1	103.8	224.1	103.6	219.6	101.9
	-16.7	-17	234.0	104.5	234.0	104.2	234.0	105.2	232.9	103.6	232.9	100.2	228.4	98.55
	-13.7	-15	249.9	104.1	249.9	103.8	248.4	103.6	248.4	98.72	248.4	95.45	243.8	93.67
	-11.8	-13	258.1	103.8	256.6	103.6	256.6	100.3	256.6	95.65	256.6	92.42	243.8	90.61
	-9.8	-11	266.4	103.6	266.4	99.94	265.3	96.91	265.3	92.44	261.6	89.25	243.8	87.37
	-9.5	-10	267.9	103.0	267.9	99.38	266.8	96.42	266.8	91.95	261.6	88.77	243.8	86.88
	-8.5	-9.1	273.2	101.1	273.2	97.58	272.0	94.70	270.6	90.34	261.6	87.19	243.8	85.25
	-7.0	-7.6	285.6	98.27	284.5	94.87	279.6	92.15	270.6	87.95	261.6	84.81	243.8	82.82
	-5.0	-5.6	298.1	94.48	295.1	91.27	279.6	88.77	270.6	84.70	261.6	81.63	243.8	79.58
	-3.0	-3.7	306.7	90.71	297.6	87.63	279.6	85.36	270.6	81.48	261.6	78.46	243.8	76.34
	0.0	-0.7	315.4	85.04	297.6	82.22	279.6	80.26	270.6	76.65	261.6	73.68	243.8	71.49
	3.0	2.2	315.4	79.36	297.6	76.78	279.6	75.16	270.6	71.83	261.6	68.91	243.8	66.64
	5.0	4.1	309.0	68.62	291.6	66.34	274.0	64.95	265.3	62.03	256.6	59.37	239.0	57.26
	7.0	6.0	301.1	63.91	284.1	61.90	267.1	60.82	258.5	58.20	249.9	55.69	232.9	53.55
	9.0	7.9	290.1	58.63	273.6	56.78	257.4	55.81	249.1	53.38	240.8	51.07	224.3	49.11
	11.0	9.8	274.3	54.08	258.9	52.36	243.1	51.46	235.6	49.23	227.7	47.10	212.2	45.30
	13.0	11.8	257.8	48.79	243.1	47.25	228.4	46.43	221.2	44.43	213.8	42.52	199.1	40.88
15.0	13.7	243.8	44.26	229.9	42.87	216.0	42.12	209.2	40.28	202.4	38.54	188.5	37.08	
90	-24.8	-25	170.0	94.31	170.0	95.77	168.9	96.83	168.9	97.30	168.9	98.29	165.8	99.78
	-21.8	-22	207.7	95.77	207.7	97.26	206.5	98.29	206.5	98.79	206.5	99.78	202.4	95.53
	-19.8	-20	219.7	96.76	219.7	98.25	218.2	99.28	218.2	99.78	218.2	98.86	214.1	92.69
	-18.8	-19	225.3	97.26	224.1	98.75	223.0	99.78	223.0	98.30	223.0	95.42	218.8	91.29
	-16.7	-17	234.0	98.29	234.0	99.78	233.2	96.70	233.2	95.15	233.2	92.39	222.8	88.30
	-13.7	-15	249.9	99.78	249.9	95.19	247.6	92.30	247.6	90.68	240.1	88.03	222.8	84.05
	-11.8	-13	258.1	96.63	256.6	92.29	255.5	89.49	248.0	87.83	240.1	85.29	222.8	81.36
	-9.8	-11	266.4	93.36	266.4	89.25	255.9	86.56	248.0	84.84	240.1	82.37	222.8	78.52
	-9.5	-10	267.9	92.84	267.9	88.78	255.9	86.12	248.0	84.40	240.1	81.93	222.8	78.08
	-8.5	-9.1	273.2	91.21	271.3	87.26	255.9	84.64	248.0	82.91	240.1	80.49	222.8	76.67
	-7.0	-7.6	285.6	88.72	271.7	84.96	255.9	82.45	248.0	80.66	240.1	78.31	222.8	74.53
	-5.0	-5.6	288.7	85.42	271.7	81.92	255.9	79.53	248.0	77.70	240.1	75.42	222.8	71.72
	-3.0	-3.7	288.7	82.12	271.7	78.88	255.9	76.57	248.0	74.70	240.1	72.50	222.8	68.88
	0.0	-0.7	288.7	77.18	271.7	74.29	255.9	72.16	248.0	70.23	240.1	68.15	222.8	64.63
	3.0	2.2	288.7	72.22	271.7	69.69	255.9	67.76	248.0	65.75	240.1	63.82	222.8	60.36
	5.0	4.1	283.0	62.41	266.4	60.25	250.6	58.54	243.1	56.69	235.2	54.97	218.3	51.88
	7.0	6.0	275.8	58.41	259.6	56.60	244.2	55.07	236.7	53.22	229.2	51.62	213.0	48.68
	9.0	7.9	265.7	53.57	249.9	51.93	235.2	50.52	228.0	48.79	220.9	47.34	205.1	44.66
	11.0	9.8	251.4	48.93	236.3	47.42	222.4	46.13	215.6	44.58	208.8	43.25	193.8	40.76
	13.0	11.8	235.9	43.24	222.0	41.92	208.9	40.81	202.5	39.41	196.0	38.23	182.1	36.05
15.0	13.7	223.2	38.82	210.0	37.61	197.9	36.61	191.6	35.37	185.5	34.30	172.3	32.35	
80	-24.8	-25	169.2	83.00	169.2	84.49	168.1	85.52	168.1	86.02	168.1	88.47	165.0	84.74
	-21.8	-22	205.5	84.49	205.5	85.95	205.5	86.98	205.5	88.47	205.5	84.74	199.1	81.13
	-19.8	-20	217.4	85.45	217.4	86.94	217.4	88.47	217.4	85.84	214.1	82.23	199.1	78.73
	-18.8	-19	222.2	85.95	222.2	88.47	222.2	87.14	221.7	84.52	214.1	80.98	199.1	77.55
	-16.7	-17	228.8	88.47	228.8	85.69	228.8	84.33	222.0	81.75	214.1	78.39	199.1	75.04
	-13.7	-15	239.3	84.36	234.5	81.70	228.8	80.33	222.0	77.79	214.1	74.63	199.1	71.43
	-11.8	-13	245.4	81.73	238.2	79.18	228.8	77.78	222.0	75.28	214.1	72.26	199.1	69.14
	-9.8	-11	251.8	78.99	241.4	76.55	228.8	75.12	222.0	72.65	214.1	69.75	199.1	66.74
	-9.5	-10	253.6	78.58	242.9	76.14	228.8	74.71	222.0	72.25	214.1	69.38	199.1	66.41
	-8.5	-9.1	256.1	77.21	243.8	74.81	228.8	73.38	222.0	70.92	214.1	68.16	199.1	65.19
	-7.0	-7.6	258.5	75.13	243.8	72.82	228.8	71.38	222.0	68.96	214.1	66.28	199.1	63.39
	-5.0	-5.6	258.5	72.39	243.8	70.18	228.8	68.69	222.0	66.30	214.1	63.77	199.1	60.99
	-3.0	-3.7	258.5	69.65	243.8	67.52	228.8	66.02	222.0	63.68	214.1	61.30	199.1	58.59
	0.0	-0.7	258.5	65.50	243.8	63.56	228.8	62.03	222.0	59.72	214.1	57.53	199.1	55.01
	3.0	2.2	258.5	61.39	243.8	59.57	228.8	58.00	222.0	55.74	214.1	53.80	199.1	51.40
	5.0	4.1	253.3	53.01	238.9	51.41	224.3	49.99	217.5	47.95	209.6	46.28	195.3	44.20
	7.0	6.0	246.9	49.73	232.9	48.31	218.6	46.86	211.9	44.93	204.3	43.44	190.1	41.48
	9.0	7.9	237.8	44.37	224.3	43.14	210.4	42.06	204.3	40.44	196.8	38.99	183.2	37.15
	11.0	9.8	225.0	39.25	211.9	38.17	199.1	37.21	193.1	35.77	186.3	34.51	173.1	32.86
	13.0	11.8	211.1	33.94	199.1	32.98	187.0	32.16	181.4	30.91	175.0	29.81	162.6	28.41
15.0	13.7	199.8	30.44	188.5	29.56	176.9	28.85	171.6	27.71	165.5	26.75	153.9	25.47	

# 7. Capacity Tables

Heating Capacity (90HP)

Combination (%)	Outdoor air temp.		Indoor air temp. °C DB											
			16		18		20		21		22		24	
	°C DB	°C WB	TC	PI	TC	PI	TC	PI	TC	PI	TC	PI	TC	PI
70	-24.8	-25	169.2	83.44	169.2	83.93	168.1	84.93	168.1	86.42	168.1	82.33	164.1	78.50
	-21.8	-22	196.1	84.93	196.1	85.42	194.9	86.42	188.2	82.33	182.5	78.50	170.4	74.81
	-19.8	-20	213.9	85.92	207.0	86.42	194.9	83.54	188.2	79.60	182.5	75.95	170.4	72.35
	-18.8	-19	218.1	86.42	207.0	84.94	194.9	82.10	188.2	78.24	182.5	74.67	170.4	71.10
	-16.7	-17	219.4	83.32	207.0	81.81	194.9	79.11	188.2	75.36	182.5	72.01	170.4	68.52
	-13.7	-15	219.4	78.96	207.0	77.38	194.9	74.80	188.2	71.30	182.5	68.18	170.4	64.81
	-11.8	-13	219.4	76.15	207.0	74.57	194.9	72.07	188.2	68.69	182.5	65.75	170.4	62.48
	-9.8	-11	219.4	73.24	207.0	71.59	194.9	69.23	188.2	65.97	182.5	63.21	170.4	60.02
	-9.5	-10	219.4	72.79	207.0	71.14	194.9	68.79	188.2	65.56	182.5	62.84	170.4	59.65
	-8.5	-9.1	219.4	71.35	207.0	69.67	194.9	67.35	188.2	64.20	182.5	61.55	170.4	58.40
	-7.0	-7.6	219.4	69.14	207.0	67.45	194.9	65.21	188.2	62.17	182.5	59.64	170.4	56.56
	-5.0	-5.6	219.4	66.22	207.0	64.50	194.9	62.34	188.2	59.44	182.5	57.09	170.4	54.09
	-3.0	-3.7	219.4	63.30	207.0	61.51	194.9	59.46	188.2	56.71	182.5	54.55	170.4	51.63
	0.0	-0.7	219.4	58.90	207.0	57.08	194.9	55.18	188.2	52.62	182.5	50.72	170.4	47.94
	3.0	2.2	219.4	54.51	207.0	52.65	194.9	50.87	188.2	48.56	182.5	46.89	170.4	44.23
	5.0	4.1	219.4	47.67	202.8	44.90	190.8	43.41	184.4	41.37	178.8	40.05	167.0	37.72
	7.0	6.0	219.4	45.48	197.6	41.58	185.9	40.17	179.5	38.35	174.3	37.19	162.6	34.97
	9.0	7.9	211.5	39.23	190.4	35.83	179.1	34.64	173.1	33.08	167.9	32.07	156.6	30.15
	11.0	9.8	200.2	34.64	180.2	31.65	169.4	30.61	163.7	29.21	158.8	28.34	148.2	26.64
	13.0	11.8	187.8	30.21	169.3	27.63	159.2	26.70	153.6	25.49	149.0	24.70	139.2	23.23
15.0	13.7	177.6	26.77	160.0	24.46	150.5	23.64	145.3	22.57	141.1	21.90	131.7	20.58	
60	-24.8	-25	167.0	82.44	167.0	83.44	165.9	84.93	161.4	80.54	155.8	76.45	146.0	72.59
	-21.8	-22	179.6	83.93	178.0	84.93	167.1	80.54	161.4	76.45	155.8	72.59	146.0	68.87
	-19.8	-20	188.2	84.93	178.0	81.83	167.1	77.63	161.4	73.72	155.8	70.01	146.0	66.37
	-18.8	-19	188.2	83.38	178.0	80.28	167.1	76.16	161.4	72.33	155.8	68.72	146.0	65.12
	-16.7	-17	188.2	80.09	178.0	77.04	167.1	73.10	161.4	69.46	155.8	66.03	146.0	62.51
	-13.7	-15	188.2	75.41	178.0	72.42	167.1	68.75	161.4	65.37	155.8	62.17	146.0	58.79
	-11.8	-13	188.2	72.45	178.0	69.48	167.1	65.95	161.4	62.75	155.8	59.74	146.0	56.44
	-9.8	-11	188.2	69.35	178.0	66.38	167.1	63.04	161.4	60.03	155.8	57.16	146.0	53.94
	-9.5	-10	188.2	68.87	178.0	65.94	167.1	62.60	161.4	59.62	155.8	56.76	146.0	53.57
	-8.5	-9.1	188.2	67.32	178.0	64.39	167.1	61.16	161.4	58.26	155.8	55.47	146.0	52.32
	-7.0	-7.6	188.2	64.99	178.0	62.07	167.1	58.98	161.4	56.20	155.8	53.55	146.0	50.45
	-5.0	-5.6	188.2	61.86	178.0	58.97	167.1	56.04	161.4	53.47	155.8	50.98	146.0	47.98
	-3.0	-3.7	188.2	58.76	178.0	55.87	167.1	53.13	161.4	50.74	155.8	48.40	146.0	45.48
	0.0	-0.7	188.2	54.07	178.0	51.26	167.1	48.77	161.4	46.62	155.8	44.54	146.0	41.76
	3.0	2.2	188.2	49.39	178.0	46.62	167.1	44.39	161.4	42.53	155.8	40.70	146.0	38.01
	5.0	4.1	184.4	41.89	174.6	39.38	163.7	37.48	158.1	35.95	152.8	34.46	143.0	32.13
	7.0	6.0	179.5	38.42	170.1	35.99	159.5	34.31	154.3	32.97	149.0	31.63	139.2	29.41
	9.0	7.9	173.1	32.79	163.7	30.69	153.6	29.28	148.6	28.12	143.4	27.00	134.3	25.08
	11.0	9.8	163.7	28.95	155.0	27.11	145.3	25.85	140.4	24.84	135.5	23.84	126.8	22.15
	13.0	11.8	153.6	25.24	145.6	23.63	136.6	22.52	131.7	21.66	127.2	20.76	119.3	19.33
15.0	13.7	145.3	22.57	137.7	21.12	129.1	19.94	124.9	19.19	120.4	18.41	112.9	17.28	
50	-24.8	-25	156.9	71.97	147.9	73.46	139.2	69.60	134.7	65.99	130.2	62.57	121.2	59.41
	-21.8	-22	156.9	73.46	147.9	69.60	139.2	65.99	134.7	62.57	130.2	59.41	121.2	56.36
	-19.8	-20	156.9	70.77	147.9	67.02	139.2	63.60	134.7	60.29	130.2	57.28	121.2	54.30
	-18.8	-19	156.9	69.41	147.9	65.73	139.2	62.39	134.7	59.19	130.2	56.22	121.2	53.28
	-16.7	-17	156.9	66.61	147.9	63.05	139.2	59.88	134.7	56.80	130.2	54.01	121.2	51.14
	-13.7	-15	156.9	62.59	147.9	59.18	139.2	56.28	134.7	53.38	130.2	50.84	121.2	48.09
	-11.8	-13	156.9	60.05	147.9	56.75	139.2	53.99	134.7	51.21	130.2	48.82	121.2	46.15
	-9.8	-11	156.9	57.36	147.9	54.18	139.2	51.57	134.7	48.93	130.2	46.69	121.2	44.09
	-9.5	-10	156.9	56.96	147.9	53.81	139.2	51.23	134.7	48.60	130.2	46.39	121.2	43.80
	-8.5	-9.1	156.9	55.60	147.9	52.52	139.2	50.02	134.7	47.46	130.2	45.33	121.2	42.77
	-7.0	-7.6	156.9	53.61	147.9	50.60	139.2	48.22	134.7	45.76	130.2	43.75	121.2	41.26
	-5.0	-5.6	156.9	50.92	147.9	48.03	139.2	45.83	134.7	43.49	130.2	41.62	121.2	39.21
	-3.0	-3.7	156.9	48.23	147.9	45.45	139.2	43.40	134.7	41.21	130.2	39.49	121.2	37.18
	0.0	-0.7	156.9	44.22	147.9	41.59	139.2	39.80	134.7	37.79	130.2	36.32	121.2	34.10
	3.0	2.2	156.9	40.20	147.9	37.76	139.2	36.22	134.7	34.37	130.2	33.16	121.2	31.05
	5.0	4.1	153.9	33.95	145.2	31.80	136.3	30.56	132.1	29.03	127.6	28.05	118.9	26.23
	7.0	6.0	149.8	31.01	141.5	29.01	132.8	27.95	128.7	26.54	124.5	25.74	115.9	23.99
	9.0	7.9	144.5	26.71	136.2	25.01	128.0	24.10	123.8	22.91	119.7	22.19	111.7	20.70
	11.0	9.8	137.3	23.87	129.5	22.36	121.6	21.53	117.1	20.45	113.3	19.81	105.7	18.47
	13.0	11.8	128.3	20.58	120.8	19.29	113.7	18.58	109.9	17.75	106.5	17.11	99.0	16.04
15.0	13.7	121.2	18.45	114.4	17.28	107.6	16.64	104.2	15.82	100.8	15.32	93.7	14.29	

**Note**

1. TC: Total Capacity(kW), PI : Power Input(kW, Comp. + Outdoor fan motor)
2. Capacity tables show the average value of conditions which may occur.
3. The heating capacity table is based on the values expressed as Max. in the specification of the outdoor unit. (When measuring the Max. heating capacity, the setting status of the indoor unit is the same as that for measuring the heating capacity of the indoor unit.)

# 7. Capacity Tables

## ◆ ARUM920LTE5

Heating Capacity (92HP)

Combination (%)	Outdoor air temp.		Indoor air temp. °C DB											
			16		18		20		21		22		24	
	°C DB	°C WB	TC	PI	TC	PI	TC	PI	TC	PI	TC	PI	TC	PI
130	-24.8	-25	175.7	98.4	175.7	99.08	174.5	99.68	174.5	100.6	174.5	101.5	171.4	102.9
	-21.8	-22	216.0	99.75	216.0	100.5	214.5	101.1	214.5	102.0	214.5	102.9	210.3	104.2
	-19.8	-20	228.9	100.7	228.9	101.4	227.3	102.0	227.3	102.9	227.3	103.8	223.1	105.2
	-18.8	-19	234.1	101.1	234.1	101.8	232.6	102.4	232.6	103.4	232.6	104.2	228.0	105.6
	-16.7	-17	244.8	102.1	244.8	102.8	243.3	103.4	243.3	104.3	243.3	105.2	238.7	106.6
	-13.7	-15	260.1	103.5	260.1	104.2	258.6	104.8	258.6	105.7	258.6	106.6	253.6	102.7
	-11.8	-13	268.6	104.4	268.6	105.1	267.0	105.7	267.0	106.6	267.0	104.0	263.1	100.3
	-9.8	-11	277.4	105.3	277.4	106.0	275.9	106.6	275.9	103.9	275.9	101.3	273.0	97.71
	-9.5	-10	279.0	105.5	279.0	106.1	277.4	106.2	277.4	103.5	277.1	100.9	274.5	97.30
	-8.5	-9.1	284.4	105.9	284.4	106.6	282.8	104.8	282.8	102.1	281.6	99.52	279.5	96.01
	-7.0	-7.6	292.5	106.6	292.5	104.6	290.6	102.7	290.6	100.0	290.6	97.45	286.8	94.08
	-5.0	-5.6	303.2	104.0	303.2	101.9	301.3	99.91	301.3	97.26	301.3	94.73	296.7	91.51
	-3.0	-3.7	314.0	101.5	314.0	99.18	312.1	97.11	312.1	94.50	312.1	92.00	306.6	88.90
	0.0	-0.7	330.1	97.56	330.1	95.14	327.9	92.94	327.9	90.38	327.9	87.92	321.8	85.04
	3.0	2.2	346.3	93.70	346.3	91.06	344.0	88.75	344.0	86.25	344.0	83.80	322.8	81.18
	5.0	4.1	350.5	82.77	349.8	80.16	347.5	77.90	347.5	75.55	339.8	73.29	316.3	70.94
	7.0	6.0	351.7	78.77	351.0	76.23	349.0	74.04	343.2	71.88	331.0	69.73	308.2	67.65
	9.0	7.9	340.6	73.54	339.8	71.16	339.0	69.09	330.5	67.08	319.0	65.08	297.0	63.15
	11.0	9.8	322.1	69.20	321.3	66.97	320.5	65.00	312.5	63.11	301.7	61.25	280.9	59.41
	13.0	11.8	302.5	63.87	302.0	61.82	300.9	60.01	293.6	58.27	283.2	56.53	263.6	54.83
15.0	13.7	286.3	59.48	285.5	57.55	284.7	55.89	277.8	54.26	268.2	52.64	249.4	51.05	
120	-24.8	-25	174.5	99.08	174.5	99.68	173.3	100.6	173.3	101.5	173.3	102.9	170.2	103.8
	-21.8	-22	214.5	100.5	214.5	101.1	213.0	102.0	213.0	102.9	213.0	104.2	209.1	105.2
	-19.8	-20	227.3	101.4	227.3	102.0	225.8	102.9	225.8	103.8	225.8	105.2	221.5	106.1
	-18.8	-19	232.3	101.8	232.3	102.4	230.8	103.4	230.8	104.2	230.8	105.6	226.5	106.6
	-16.7	-17	243.0	102.8	243.0	103.4	241.4	104.3	241.4	105.2	241.4	106.6	236.8	104.1
	-13.7	-15	258.2	104.2	258.2	104.8	256.7	105.7	256.7	106.6	256.7	102.9	251.7	100.6
	-11.8	-13	266.7	105.1	266.7	105.7	265.1	106.6	265.1	104.0	265.1	100.6	261.2	98.31
	-9.8	-11	275.5	106.0	275.5	106.6	273.9	103.7	273.9	101.2	273.9	98.09	271.1	95.93
	-9.5	-10	277.1	106.1	277.1	106.2	275.5	103.3	275.5	100.8	275.5	97.71	272.6	95.56
	-8.5	-9.1	282.4	106.6	282.4	104.6	280.6	101.9	280.6	99.45	280.6	96.50	277.3	94.38
	-7.0	-7.6	290.5	104.4	290.5	102.4	288.6	99.72	288.6	97.37	288.6	94.65	284.8	92.60
	-5.0	-5.6	301.3	101.4	301.3	99.34	299.3	96.84	299.3	94.61	299.3	92.16	294.8	90.22
	-3.0	-3.7	311.7	98.39	311.7	96.35	309.8	93.97	309.8	91.88	309.8	89.70	303.2	87.84
	0.0	-0.7	327.8	93.93	327.8	91.81	325.6	89.66	325.6	87.73	325.6	85.99	303.2	84.29
	3.0	2.2	343.7	89.46	343.7	87.27	341.7	85.35	336.7	83.61	326.3	82.29	303.2	80.73
	5.0	4.1	348.3	78.46	347.1	76.38	341.3	74.68	330.1	73.09	319.8	72.04	297.1	70.64
	7.0	6.0	349.8	74.30	346.3	72.30	332.8	70.86	321.7	69.50	311.7	68.86	289.4	67.61
	9.0	7.9	338.2	69.16	333.6	67.27	320.5	65.95	309.8	64.70	300.2	64.06	278.9	62.92
	11.0	9.8	319.8	64.85	315.5	63.07	303.2	61.83	292.9	60.65	284.0	60.09	263.6	59.02
	13.0	11.8	300.5	59.63	296.3	58.01	284.7	56.87	275.1	55.78	266.7	55.25	247.8	54.27
15.0	13.7	284.3	55.28	280.5	53.77	269.3	52.72	260.5	51.73	252.4	51.24	234.3	50.33	
110	-24.8	-25	173.7	99.68	173.7	100.6	172.5	101.5	172.5	102.9	172.5	103.8	169.1	104.3
	-21.8	-22	213.3	101.1	213.3	102.0	211.8	102.9	211.8	104.2	211.8	105.2	207.9	105.7
	-19.8	-20	226.1	102.0	226.1	102.9	224.6	103.8	224.6	105.2	224.6	106.1	220.3	106.6
	-18.8	-19	231.1	102.4	231.1	103.4	229.6	104.2	229.6	105.6	229.6	106.6	225.3	105.3
	-16.7	-17	241.8	103.4	241.8	104.3	240.2	105.2	240.2	106.6	240.2	103.9	235.6	102.5
	-13.7	-15	256.7	104.8	256.7	105.7	255.1	106.6	255.1	102.5	255.1	100.0	255.1	98.50
	-11.8	-13	265.1	105.7	265.1	106.6	263.6	103.7	263.6	99.91	263.6	97.56	263.6	95.97
	-9.8	-11	274.0	106.6	274.0	103.4	272.4	100.7	272.4	97.18	272.4	94.99	271.1	93.32
	-9.5	-10	275.5	106.1	275.5	102.9	274.0	100.2	274.0	96.77	274.0	94.61	272.8	92.94
	-8.5	-9.1	280.9	104.3	280.9	101.2	279.3	98.70	279.3	95.40	279.3	93.29	272.8	91.59
	-7.0	-7.6	289.0	101.7	289.0	98.80	287.1	96.42	287.1	93.36	287.1	91.36	272.8	89.62
	-5.0	-5.6	299.4	98.20	299.4	95.52	297.5	93.40	297.5	90.64	292.1	88.79	272.8	86.94
	-3.0	-3.7	310.1	94.69	310.1	92.27	308.2	90.34	302.4	87.88	292.1	86.18	272.8	84.29
	0.0	-0.7	325.9	89.43	325.9	87.39	312.5	85.80	302.4	83.79	292.1	82.32	272.8	80.31
	3.0	2.2	341.7	84.17	333.2	82.51	312.5	81.22	302.4	79.71	292.1	78.43	272.8	76.31
	5.0	4.1	345.5	73.17	326.3	71.77	306.3	70.71	296.3	69.50	286.3	68.44	267.4	66.44
	7.0	6.0	336.7	68.67	318.2	67.65	298.6	66.89	288.9	66.06	279.0	65.23	260.5	63.19
	9.0	7.9	324.3	63.57	306.3	62.62	287.5	61.90	278.2	61.15	268.9	60.39	250.9	58.50
	11.0	9.8	306.7	59.25	289.8	58.35	272.0	57.71	263.2	57.02	254.3	56.27	237.4	54.53
	13.0	11.8	287.8	54.15	272.1	53.32	255.5	52.71	247.0	52.07	238.6	51.42	222.8	49.84
15.0	13.7	272.4	49.80	257.4	49.04	241.7	48.48	233.6	47.91	225.9	47.30	210.9	45.83	

# 7. Capacity Tables

Heating Capacity (92HP)

Combination (%)	Outdoor air temp.		Indoor air temp. °C DB											
			16		18		20		21		22		24	
	°C DB	°C WB	TC	PI	TC	PI	TC	PI	TC	PI	TC	PI	TC	PI
100	-24.8	-25	172.9	110.3	172.9	109.8	171.8	102.2	171.8	108.6	171.8	108.1	168.3	107.9
	-21.8	-22	212.2	109.6	212.2	109.1	211.0	105.4	211.0	107.9	211.0	108.8	206.8	107.1
	-19.8	-20	225.0	109.1	225.0	108.6	223.8	107.4	223.8	107.4	223.8	107.4	219.5	106.6
	-18.8	-19	230.0	108.8	228.8	108.3	228.8	107.9	228.8	107.1	228.8	106.6	224.2	105.0
	-16.7	-17	239.1	108.3	239.1	107.8	239.1	108.8	237.9	106.6	237.9	103.2	233.3	101.5
	-13.7	-15	255.5	107.6	255.5	107.1	254.0	106.6	254.0	101.7	254.0	98.39	249.3	96.58
	-11.8	-13	263.9	107.1	262.4	106.6	262.4	103.4	262.4	98.62	262.4	95.33	249.3	93.47
	-9.8	-11	272.5	106.6	272.5	103.0	271.3	99.91	271.3	95.37	267.5	92.11	249.3	90.18
	-9.5	-10	274.0	106.0	274.0	102.4	272.8	99.41	272.8	94.88	267.5	91.63	249.3	89.69
	-8.5	-9.1	279.4	104.1	279.4	100.6	278.2	97.68	276.7	93.25	267.5	90.03	249.3	88.03
	-7.0	-7.6	292.1	101.3	290.9	97.86	285.9	95.10	276.7	90.82	267.5	87.61	249.3	85.57
	-5.0	-5.6	304.8	97.48	301.7	94.23	285.9	91.69	276.7	87.54	267.5	84.40	249.3	82.29
	-3.0	-3.7	313.6	93.70	304.3	90.57	285.9	88.26	276.7	84.29	267.5	81.18	249.3	79.00
	0.0	-0.7	322.5	87.99	304.3	85.12	285.9	83.11	276.7	79.41	267.5	76.34	249.3	74.08
	3.0	2.2	322.5	82.28	304.3	79.64	285.9	77.97	276.7	74.53	267.5	71.51	249.3	69.16
	5.0	4.1	315.9	71.24	298.2	68.89	280.1	67.46	271.3	64.43	262.4	61.68	244.3	59.48
	7.0	6.0	307.9	66.48	290.5	64.40	273.2	63.26	264.3	60.54	255.5	57.93	238.2	55.70
	9.0	7.9	296.7	61.26	279.8	59.33	263.2	58.31	254.7	55.77	246.3	53.36	229.3	51.31
	11.0	9.8	280.5	56.79	264.7	54.98	248.6	54.04	240.9	51.69	232.8	49.46	217.0	47.57
	13.0	11.8	263.6	51.54	248.6	49.92	233.6	49.05	226.2	46.93	218.6	44.92	203.6	43.18
15.0	13.7	249.3	47.08	235.1	45.60	220.9	44.81	213.9	42.85	207.0	40.99	192.8	39.44	
90	-24.8	-25	172.2	98.06	172.2	99.42	171.0	100.4	171.0	100.9	171.0	101.8	167.9	103.2
	-21.8	-22	211.4	99.42	211.4	100.8	210.2	101.8	210.2	102.3	210.2	103.2	206.0	98.82
	-19.8	-20	224.2	100.4	224.2	101.8	222.7	102.7	222.7	103.2	222.7	102.2	218.5	95.91
	-18.8	-19	230.0	100.8	228.8	102.2	227.7	103.2	227.7	101.7	227.7	98.71	223.4	94.46
	-16.7	-17	239.1	101.8	239.1	103.2	238.3	100.0	238.3	98.44	238.3	95.60	227.8	91.39
	-13.7	-15	255.5	103.2	255.5	98.48	253.2	95.52	253.2	93.86	245.5	91.13	227.8	87.04
	-11.8	-13	263.9	99.96	262.4	95.52	261.3	92.64	253.6	90.94	245.5	88.32	227.8	84.27
	-9.8	-11	272.5	96.62	272.5	92.41	261.6	89.65	253.6	87.87	245.5	85.33	227.8	81.35
	-9.5	-10	274.0	96.09	274.0	91.92	261.6	89.19	253.6	87.41	245.5	84.88	227.8	80.90
	-8.5	-9.1	279.4	94.42	277.4	90.37	261.6	87.68	253.6	85.90	245.5	83.40	227.8	79.46
	-7.0	-7.6	292.1	91.88	277.8	88.02	261.6	85.44	253.6	83.59	245.5	81.16	227.8	77.26
	-5.0	-5.6	295.2	88.50	277.8	84.91	261.6	82.44	253.6	80.55	245.5	78.20	227.8	74.38
	-3.0	-3.7	295.2	85.13	277.8	81.79	261.6	79.41	253.6	77.48	245.5	75.21	227.8	71.46
	0.0	-0.7	295.2	80.08	277.8	77.09	261.6	74.90	253.6	72.89	245.5	70.74	227.8	67.10
	3.0	2.2	295.2	75.01	277.8	72.40	261.6	70.39	253.6	68.31	245.5	66.30	227.8	62.71
	5.0	4.1	289.4	64.86	272.4	62.63	256.3	60.85	248.5	58.92	240.5	57.14	223.2	53.93
	7.0	6.0	282.0	60.76	265.5	58.88	249.7	57.29	242.0	55.36	234.3	53.70	217.8	50.63
	9.0	7.9	271.7	55.97	255.5	54.26	240.5	52.79	233.2	50.98	225.8	49.46	209.7	46.66
	11.0	9.8	257.0	51.39	241.7	49.80	227.4	48.44	220.5	46.81	213.5	45.41	198.2	42.81
	13.0	11.8	241.3	45.68	227.0	44.28	213.6	43.11	207.0	41.63	200.5	40.39	186.2	38.08
15.0	13.7	228.2	41.29	214.7	40.01	202.4	38.95	195.9	37.62	189.7	36.49	176.2	34.41	
80	-24.8	-25	171.4	86.36	171.4	87.76	170.3	88.73	170.3	89.19	170.3	91.49	167.1	87.66
	-21.8	-22	209.1	87.76	209.1	89.13	209.1	90.09	209.1	91.49	209.1	87.66	203.6	83.95
	-19.8	-20	221.9	88.66	221.9	90.06	221.9	91.49	221.9	88.79	218.9	85.08	203.6	81.48
	-18.8	-19	226.9	89.13	226.9	91.49	226.9	90.12	226.7	87.43	218.9	83.80	203.6	80.27
	-16.7	-17	234.0	91.49	234.0	88.64	234.0	87.24	227.0	84.59	218.9	81.14	203.6	77.69
	-13.7	-15	244.7	87.28	239.8	84.55	234.0	83.14	227.0	80.53	218.9	77.28	203.6	73.98
	-11.8	-13	250.6	84.59	243.3	81.97	234.0	80.53	227.0	77.96	218.9	74.85	203.6	71.63
	-9.8	-11	257.2	81.78	246.7	79.28	234.0	77.80	227.0	75.26	218.9	72.28	203.6	69.17
	-9.5	-10	259.1	81.36	248.2	78.86	234.0	77.38	227.0	74.85	218.9	71.90	203.6	68.82
	-8.5	-9.1	261.7	79.96	249.3	77.50	234.0	76.02	227.0	73.48	218.9	70.64	203.6	67.58
	-7.0	-7.6	264.4	77.84	249.3	75.45	234.0	73.97	227.0	71.47	218.9	68.71	203.6	65.72
	-5.0	-5.6	264.4	75.03	249.3	72.76	234.0	71.21	227.0	68.75	218.9	66.13	203.6	63.26
	-3.0	-3.7	264.4	72.22	249.3	70.03	234.0	68.48	227.0	66.05	218.9	63.59	203.6	60.79
	0.0	-0.7	264.4	67.98	249.3	65.97	234.0	64.38	227.0	62.00	218.9	59.73	203.6	57.11
	3.0	2.2	264.4	63.77	249.3	61.88	234.0	60.25	227.0	57.91	218.9	55.90	203.6	53.41
	5.0	4.1	259.0	55.10	244.3	53.44	229.3	51.96	222.4	49.84	214.3	48.11	199.7	45.95
	7.0	6.0	252.4	51.73	238.1	50.25	223.5	48.75	216.7	46.74	208.9	45.19	194.3	43.15
	9.0	7.9	243.2	46.41	229.3	45.11	215.1	43.98	208.9	42.28	201.3	40.77	187.4	38.84
	11.0	9.8	230.1	41.26	216.7	40.12	203.6	39.11	197.4	37.59	190.4	36.27	177.0	34.53
	13.0	11.8	215.9	35.89	203.6	34.87	191.2	34.00	185.5	32.68	178.9	31.51	166.3	30.03
15.0	13.7	204.3	32.41	192.8	31.47	180.9	30.71	175.5	29.50	169.3	28.47	157.4	27.11	

# 7. Capacity Tables

Heating Capacity (92HP)

Combination (%)	Outdoor air temp.		Indoor air temp. °C DB											
			16		18		20		21		22		24	
	°C DB	°C WB	TC	PI	TC	PI	TC	PI	TC	PI	TC	PI	TC	PI
70	-24.8	-25	171.4	86.57	171.4	87.04	170.3	87.97	170.3	89.36	170.3	85.16	167.1	81.22
	-21.8	-22	200.5	87.97	200.5	88.43	199.3	89.36	192.4	85.16	186.6	81.22	174.3	77.43
	-19.8	-20	219.9	88.90	211.7	89.36	199.3	86.41	192.4	82.36	186.6	78.61	174.3	74.89
	-18.8	-19	224.3	89.36	211.7	87.85	199.3	84.93	192.4	80.95	186.6	77.28	174.3	73.61
	-16.7	-17	224.3	86.19	211.7	84.63	199.3	81.86	192.4	78.00	186.6	74.55	174.3	70.95
	-13.7	-15	224.3	81.71	211.7	80.08	199.3	77.43	192.4	73.83	186.6	70.61	174.3	67.13
	-11.8	-13	224.3	78.83	211.7	77.20	199.3	74.63	192.4	71.14	186.6	68.11	174.3	64.74
	-9.8	-11	224.3	75.84	211.7	74.13	199.3	71.70	192.4	68.34	186.6	65.50	174.3	62.20
	-9.5	-10	224.3	75.38	211.7	73.68	199.3	71.25	192.4	67.92	186.6	65.12	174.3	61.82
	-8.5	-9.1	224.3	73.90	211.7	72.16	199.3	69.78	192.4	66.52	186.6	63.79	174.3	60.54
	-7.0	-7.6	224.3	71.63	211.7	69.89	199.3	67.58	192.4	64.44	186.6	61.82	174.3	58.64
	-5.0	-5.6	224.3	68.64	211.7	66.85	199.3	64.62	192.4	61.63	186.6	59.21	174.3	56.11
	-3.0	-3.7	224.3	65.64	211.7	63.79	199.3	61.67	192.4	58.83	186.6	56.59	174.3	53.57
	0.0	-0.7	224.3	61.13	211.7	59.24	199.3	57.27	192.4	54.63	186.6	52.65	174.3	49.78
	3.0	2.2	224.3	56.62	211.7	54.69	199.3	52.84	192.4	50.45	186.6	48.72	174.3	45.95
	5.0	4.1	224.3	49.55	207.4	46.67	195.1	45.11	188.5	43.00	182.8	41.64	170.8	39.22
	7.0	6.0	224.4	47.31	202.1	43.26	190.1	41.79	183.6	39.90	178.2	38.69	166.3	36.38
	9.0	7.9	216.3	40.99	194.7	37.44	183.2	36.19	177.0	34.56	171.6	33.51	160.1	31.50
	11.0	9.8	204.7	36.38	184.3	33.24	173.2	32.14	167.4	30.67	162.4	29.76	151.6	27.98
	13.0	11.8	192.0	31.92	173.1	29.19	162.8	28.21	157.0	26.92	152.4	26.10	142.4	24.54
15.0	13.7	181.6	28.47	163.6	26.02	153.9	25.15	148.6	24.01	144.3	23.29	134.7	21.90	
60	-24.8	-25	170.8	85.57	170.8	86.50	169.6	87.90	165.1	83.38	159.3	79.16	149.3	75.18
	-21.8	-22	183.7	86.97	182.0	87.90	170.8	83.38	165.1	79.16	159.3	75.18	149.3	71.34
	-19.8	-20	192.4	87.90	182.0	84.71	170.8	80.38	165.1	76.35	159.3	72.52	149.3	68.76
	-18.8	-19	192.4	86.30	182.0	83.12	170.8	78.87	165.1	74.92	159.3	71.19	149.3	67.47
	-16.7	-17	192.4	82.92	182.0	79.77	170.8	75.71	165.1	71.95	159.3	68.42	149.3	64.78
	-13.7	-15	192.4	78.10	182.0	75.02	170.8	71.22	165.1	67.74	159.3	64.43	149.3	60.94
	-11.8	-13	192.4	75.06	182.0	71.98	170.8	68.34	165.1	65.04	159.3	61.92	149.3	58.51
	-9.8	-11	192.4	71.86	182.0	68.79	170.8	65.34	165.1	62.23	159.3	59.27	149.3	55.93
	-9.5	-10	192.4	71.37	182.0	68.33	170.8	64.89	165.1	61.81	159.3	58.85	149.3	55.55
	-8.5	-9.1	192.4	69.77	182.0	66.74	170.8	63.40	165.1	60.41	159.3	57.53	149.3	54.26
	-7.0	-7.6	192.4	67.38	182.0	64.35	170.8	61.16	165.1	58.28	159.3	55.55	149.3	52.33
	-5.0	-5.6	192.4	64.15	182.0	61.16	170.8	58.13	165.1	55.47	159.3	52.89	149.3	49.78
	-3.0	-3.7	192.4	60.96	182.0	57.97	170.8	55.13	165.1	52.66	159.3	50.23	149.3	47.20
	0.0	-0.7	192.4	56.13	182.0	53.21	170.8	50.64	165.1	48.41	159.3	46.25	149.3	43.37
	3.0	2.2	192.4	51.31	182.0	48.43	170.8	46.12	165.1	44.19	159.3	42.29	149.3	39.50
	5.0	4.1	188.5	43.54	178.5	40.93	167.4	38.96	161.6	37.38	156.2	35.82	146.2	33.40
	7.0	6.0	183.6	39.97	173.9	37.44	163.1	35.70	157.7	34.30	152.3	32.90	142.4	30.59
	9.0	7.9	177.0	34.26	167.4	32.07	157.0	30.59	152.0	29.38	146.6	28.21	137.3	26.21
	11.0	9.8	167.4	30.40	158.5	28.47	148.5	27.15	143.5	26.09	138.6	25.03	129.7	23.26
	13.0	11.8	157.0	26.66	148.9	24.96	139.6	23.79	134.7	22.88	130.1	21.93	121.9	20.42
15.0	13.7	148.6	24.01	140.8	22.47	132.0	21.22	127.7	20.42	123.1	19.58	115.4	18.38	
50	-24.8	-25	160.5	74.57	151.3	75.96	142.4	71.99	137.8	68.28	133.1	64.76	123.9	61.50
	-21.8	-22	160.5	75.96	151.3	71.99	142.4	68.28	137.8	64.76	133.1	61.50	123.9	58.35
	-19.8	-20	160.5	73.20	151.3	69.34	142.4	65.81	137.8	62.41	133.1	59.30	123.9	56.23
	-18.8	-19	160.5	71.80	151.3	68.01	142.4	64.57	137.8	61.27	133.1	58.21	123.9	55.18
	-16.7	-17	160.5	68.92	151.3	65.25	142.4	61.99	137.8	58.80	133.1	55.93	123.9	52.98
	-13.7	-15	160.5	64.79	151.3	61.27	142.4	58.27	137.8	55.28	133.1	52.67	123.9	49.83
	-11.8	-13	160.5	62.17	151.3	58.77	142.4	55.93	137.8	53.05	133.1	50.59	123.9	47.83
	-9.8	-11	160.5	59.41	151.3	56.12	142.4	53.43	137.8	50.70	133.1	48.39	123.9	45.71
	-9.5	-10	160.5	58.99	151.3	55.74	142.4	53.08	137.8	50.36	133.1	48.09	123.9	45.40
	-8.5	-9.1	160.5	57.60	151.3	54.41	142.4	51.84	137.8	49.19	133.1	46.99	123.9	44.34
	-7.0	-7.6	160.5	55.54	151.3	52.44	142.4	49.98	137.8	47.44	133.1	45.36	123.9	42.79
	-5.0	-5.6	160.5	52.78	151.3	49.79	142.4	47.52	137.8	45.10	133.1	43.17	123.9	40.67
	-3.0	-3.7	160.5	50.02	151.3	47.14	142.4	45.02	137.8	42.75	133.1	40.97	123.9	38.58
	0.0	-0.7	160.5	45.89	151.3	43.16	142.4	41.31	137.8	39.23	133.1	37.71	123.9	35.41
	3.0	2.2	160.5	41.75	151.3	39.22	142.4	37.63	137.8	35.71	133.1	34.45	123.9	32.26
	5.0	4.1	157.4	35.28	148.5	33.06	139.3	31.77	135.0	30.18	130.5	29.16	121.6	27.27
	7.0	6.0	153.2	32.25	144.7	30.18	135.8	29.08	131.6	27.61	127.3	26.77	118.5	24.96
	9.0	7.9	147.7	27.91	139.3	26.13	130.8	25.18	126.6	23.93	122.4	23.18	114.3	21.63
	11.0	9.8	140.4	25.07	132.4	23.48	124.3	22.61	119.7	21.48	115.8	20.80	108.1	19.40
	13.0	11.8	131.2	21.74	123.6	20.38	116.2	19.62	112.4	18.75	108.9	18.07	101.2	16.94
15.0	13.7	123.9	19.63	117.0	18.38	110.0	17.70	106.6	16.83	103.1	16.30	95.8	15.20	

**Note**

1. TC: Total Capacity(kW), PI : Power Input(kW, Comp. + Outdoor fan motor)
2. Capacity tables show the average value of conditions which may occur.
3. The heating capacity table is based on the values expressed as Max. in the specification of the outdoor unit. (When measuring the Max. heating capacity, the setting status of the indoor unit is the same as that for measuring the heating capacity of the indoor unit.)

# 7. Capacity Tables

## ◆ ARUM940LTE5

Heating Capacity (94HP)

Combination (%)	Outdoor air temp.		Indoor air temp. °C DB											
			16		18		20		21		22		24	
	°C DB	°C WB	TC	PI	TC	PI	TC	PI	TC	PI	TC	PI	TC	PI
130	-24.8	-25	179.6	101.3	179.6	102.1	178.5	102.7	178.5	103.6	178.5	104.5	175.2	105.9
	-21.8	-22	220.8	102.7	220.8	103.4	219.3	104.1	219.3	105.0	219.3	105.9	215.0	107.3
	-19.8	-20	233.9	103.7	233.9	104.4	232.3	105.0	232.3	105.9	232.3	106.8	228.0	108.3
	-18.8	-19	239.3	104.2	239.3	104.9	237.7	105.5	237.7	106.4	237.7	107.3	233.1	108.7
	-16.7	-17	250.2	105.1	250.2	105.8	248.6	106.5	248.6	107.4	248.6	108.3	243.9	109.7
	-13.7	-15	265.8	106.6	265.8	107.3	264.2	107.9	264.2	108.8	264.2	109.7	259.1	105.7
	-11.8	-13	274.5	107.5	274.5	108.2	272.9	108.8	272.9	109.7	272.9	107.1	268.9	103.2
	-9.8	-11	283.6	108.4	283.6	109.1	281.9	109.7	281.9	106.9	281.9	104.3	279.0	100.6
	-9.5	-10	285.2	108.6	285.2	109.2	283.5	109.3	283.5	106.5	283.2	103.8	280.6	100.1
	-8.5	-9.1	290.7	109.0	290.7	109.7	289.0	107.8	289.0	105.0	287.9	102.4	285.6	98.81
	-7.0	-7.6	298.9	109.7	298.9	107.6	297.0	105.7	297.0	102.9	297.0	100.3	293.1	96.82
	-5.0	-5.6	309.9	107.1	309.9	104.8	307.9	102.8	307.9	100.1	307.9	97.48	303.3	94.17
	-3.0	-3.7	320.9	104.4	320.9	102.1	318.9	99.94	318.9	97.25	318.9	94.68	313.4	91.49
	0.0	-0.7	337.4	100.4	337.4	97.91	335.1	95.65	335.1	93.01	335.1	90.47	328.9	87.52
	3.0	2.2	353.9	96.43	353.9	93.71	351.6	91.33	351.6	88.77	351.6	86.24	329.9	83.55
	5.0	4.1	358.2	85.18	357.5	82.50	355.1	80.17	355.1	77.76	354.3	75.42	323.3	73.00
	7.0	6.0	359.5	81.06	358.7	78.45	356.7	76.19	350.8	73.97	338.3	71.76	315.0	69.62
9.0	7.9	348.1	75.69	347.3	73.24	346.4	71.10	337.8	69.04	326.0	66.98	303.6	64.98	
11.0	9.8	329.2	71.21	328.4	68.91	327.6	66.90	319.4	64.95	308.3	63.04	287.1	61.13	
13.0	11.8	309.1	65.73	308.7	63.62	307.6	61.76	300.0	59.97	289.5	58.18	269.4	56.43	
15.0	13.7	292.6	61.21	291.8	59.23	291.0	57.51	283.9	55.84	274.1	54.17	254.9	52.54	
120	-24.8	-25	178.4	102.1	178.4	102.7	177.3	103.6	177.3	104.5	177.3	105.9	174.0	106.9
	-21.8	-22	219.2	103.4	219.2	104.1	217.7	105.0	217.7	105.9	217.7	107.3	213.7	108.3
	-19.8	-20	232.3	104.4	232.3	105.0	230.7	105.9	230.7	106.8	230.7	108.3	226.4	109.2
	-18.8	-19	237.4	104.9	237.4	105.5	235.8	106.4	235.8	107.3	235.8	108.7	231.5	109.7
	-16.7	-17	248.3	105.8	248.3	106.5	246.7	107.4	246.7	108.3	246.7	109.7	242.0	107.1
	-13.7	-15	263.9	107.3	263.9	107.9	262.3	108.8	262.3	109.7	262.3	105.9	257.2	103.5
	-11.8	-13	272.5	108.2	272.5	108.8	270.9	109.7	270.9	107.0	270.9	103.5	266.9	101.2
	-9.8	-11	281.6	109.1	281.6	109.7	280.0	106.8	280.0	104.2	280.0	101.0	277.1	98.72
	-9.5	-10	283.2	109.2	283.2	109.2	281.6	106.3	281.6	103.8	281.6	100.6	278.6	98.34
	-8.5	-9.1	288.7	109.7	288.7	107.7	286.7	104.8	286.7	102.4	286.7	99.31	283.4	97.13
	-7.0	-7.6	296.9	107.4	296.9	105.4	295.0	102.6	295.0	100.2	295.0	97.40	291.1	95.30
	-5.0	-5.6	307.9	104.3	307.9	102.2	305.9	99.66	305.9	97.37	305.9	94.84	301.2	92.85
	-3.0	-3.7	318.6	101.3	318.6	99.15	316.6	96.71	316.6	94.56	316.6	92.31	309.9	90.40
	0.0	-0.7	335.0	96.66	335.0	94.48	332.7	92.27	332.7	90.29	332.7	88.49	309.9	86.74
	3.0	2.2	351.2	92.07	351.2	89.81	349.2	87.83	344.1	86.04	333.5	84.68	309.9	83.08
	5.0	4.1	355.9	80.75	354.8	78.61	348.9	76.85	337.4	75.22	326.8	74.13	303.6	72.69
	7.0	6.0	357.4	76.47	354.0	74.40	340.2	72.93	328.8	71.53	318.5	70.86	295.8	69.58
9.0	7.9	345.7	71.17	341.0	69.23	327.6	67.87	316.6	66.58	306.8	65.93	285.1	64.76	
11.0	9.8	326.8	66.74	322.5	64.91	309.9	63.63	299.3	62.42	290.2	61.83	269.4	60.74	
13.0	11.8	307.1	61.37	302.8	59.70	291.0	58.53	281.2	57.40	272.5	56.86	253.2	55.85	
15.0	13.7	290.6	56.89	286.7	55.34	275.3	54.25	266.2	53.23	257.9	52.73	239.5	51.79	
110	-24.8	-25	177.6	102.7	177.6	103.6	176.4	104.5	176.4	105.9	176.4	106.9	172.9	107.4
	-21.8	-22	218.0	104.1	218.0	105.0	216.5	105.9	216.5	107.3	216.5	108.3	212.5	108.8
	-19.8	-20	231.1	105.0	231.1	105.9	229.6	106.8	229.6	108.3	229.6	109.2	225.2	109.7
	-18.8	-19	236.2	105.5	236.2	106.4	234.6	107.3	234.6	108.7	234.6	109.7	230.3	108.3
	-16.7	-17	247.1	106.5	247.1	107.4	245.5	108.3	245.5	109.7	245.5	106.9	240.8	105.5
	-13.7	-15	262.3	107.9	262.3	108.8	260.8	109.7	260.8	105.5	260.8	102.9	260.8	101.4
	-11.8	-13	271.0	108.8	271.0	109.7	269.4	106.7	269.4	102.8	269.4	100.4	269.4	98.77
	-9.8	-11	280.0	109.7	280.0	106.4	278.4	103.6	278.4	100.0	278.4	97.75	277.0	96.04
	-9.5	-10	281.6	109.2	281.6	105.9	280.0	103.1	280.0	99.58	280.0	97.36	278.8	95.65
	-8.5	-9.1	287.1	107.4	287.1	104.2	285.5	101.6	285.5	98.18	285.5	96.01	278.8	94.26
	-7.0	-7.6	295.3	104.7	295.3	101.7	293.4	99.23	293.4	96.08	293.4	94.02	278.8	92.23
	-5.0	-5.6	306.0	101.1	306.0	98.30	304.0	96.12	304.0	93.28	298.5	91.37	278.8	89.47
	-3.0	-3.7	317.0	97.44	317.0	94.96	315.0	92.97	309.1	90.44	298.5	88.69	278.8	86.74
	0.0	-0.7	333.1	92.03	333.1	89.93	319.4	88.29	309.1	86.23	298.5	84.72	278.8	82.65
	3.0	2.2	349.3	86.62	340.5	84.91	319.4	83.59	309.1	82.03	298.5	80.71	278.8	78.53
	5.0	4.1	353.1	75.30	333.5	73.86	313.1	72.77	302.8	71.52	292.6	70.43	273.3	68.37
	7.0	6.0	344.1	70.67	325.2	69.62	305.2	68.84	295.3	67.98	285.1	67.13	266.3	65.03
9.0	7.9	331.5	65.42	313.1	64.44	293.8	63.71	284.3	62.93	274.9	62.14	256.4	60.20	
11.0	9.8	313.4	60.98	296.1	60.05	278.0	59.39	269.0	58.68	259.9	57.91	242.6	56.12	
13.0	11.8	294.2	55.72	278.1	54.87	261.1	54.25	252.5	53.59	243.9	52.92	227.7	51.29	
15.0	13.7	278.4	51.25	263.1	50.47	247.0	49.89	238.8	49.30	230.8	48.68	215.5	47.16	

# 7. Capacity Tables

Heating Capacity (94HP)

Combination (%)	Outdoor air temp.		Indoor air temp. °C DB											
			16		18		20		21		22		24	
	°C DB	°C WB	TC	PI	TC	PI	TC	PI	TC	PI	TC	PI	TC	PI
100	-24.8	-25	176.8	113.6	176.8	113.1	175.6	105.2	175.6	111.8	175.6	111.3	172.1	111.0
	-21.8	-22	216.9	112.8	216.9	112.3	215.7	108.5	215.7	111.0	215.7	112.0	211.4	110.2
	-19.8	-20	230.0	112.3	230.0	111.8	228.7	110.6	228.7	110.5	228.7	110.5	224.4	109.7
	-18.8	-19	235.0	112.0	233.8	111.5	233.8	111.0	233.8	110.2	233.8	109.7	229.1	108.0
	-16.7	-17	244.4	111.5	244.4	111.0	244.4	112.0	243.1	109.7	243.1	106.2	238.4	104.5
	-13.7	-15	261.1	110.7	261.1	110.2	259.6	109.7	259.6	104.7	259.6	101.3	254.8	99.39
	-11.8	-13	269.7	110.2	268.2	109.7	268.2	106.4	268.2	101.5	268.2	98.11	254.8	96.20
	-9.8	-11	278.5	109.7	278.5	106.0	277.2	102.8	277.2	98.14	273.4	94.80	254.8	92.81
	-9.5	-10	280.0	109.1	280.0	105.4	278.8	102.3	278.8	97.64	273.4	94.29	254.8	92.30
	-8.5	-9.1	285.5	107.2	285.5	103.5	284.3	100.5	282.8	95.97	273.4	92.65	254.8	90.60
	-7.0	-7.6	298.5	104.3	297.3	100.7	292.2	97.87	282.8	93.47	273.4	90.16	254.8	88.07
	-5.0	-5.6	311.5	100.3	308.4	96.97	292.2	94.36	282.8	90.09	273.4	86.86	254.8	84.68
	-3.0	-3.7	320.5	96.43	311.0	93.20	292.2	90.83	282.8	86.74	273.4	83.55	254.8	81.30
	0.0	-0.7	329.6	90.55	311.0	87.59	292.2	85.53	282.8	81.72	273.4	78.57	254.8	76.24
	3.0	2.2	329.6	84.68	311.0	81.96	292.2	80.24	282.8	76.70	273.4	73.59	254.8	71.17
	5.0	4.1	322.9	73.32	304.8	70.90	286.3	69.42	277.2	66.31	268.2	63.47	249.7	61.22
	7.0	6.0	314.7	68.41	296.9	66.27	279.2	65.11	270.2	62.30	261.1	59.61	243.4	57.32
	9.0	7.9	303.2	63.04	285.9	61.06	269.0	60.00	260.3	57.40	251.7	54.91	234.4	52.81
	11.0	9.8	286.7	58.45	270.5	56.59	254.1	55.61	246.2	53.20	237.9	50.90	221.8	48.96
	13.0	11.8	269.4	53.04	254.0	51.37	238.7	50.48	231.2	48.30	223.4	46.23	208.1	44.44
15.0	13.7	254.8	48.45	240.3	46.93	225.8	46.11	218.7	44.09	211.5	42.19	197.0	40.59	
90	-24.8	-25	176.0	101.0	176.0	102.4	174.9	103.4	174.9	103.8	174.9	104.8	171.7	106.2
	-21.8	-22	216.1	102.4	216.1	103.8	214.9	104.8	214.9	105.3	214.9	106.2	210.6	101.7
	-19.8	-20	229.1	103.3	229.1	104.7	227.6	105.7	227.6	106.2	227.6	103.1	223.3	98.71
	-18.8	-19	235.0	103.8	233.8	105.2	232.7	106.2	232.7	104.6	232.7	101.6	228.3	97.22
	-16.7	-17	244.4	104.8	244.4	106.2	243.5	103.0	243.5	101.3	243.5	98.39	232.8	94.06
	-13.7	-15	261.1	106.2	261.1	101.4	258.7	98.31	258.7	96.60	250.9	93.79	232.8	89.58
	-11.8	-13	269.7	102.9	268.2	98.31	267.1	95.35	259.1	93.59	250.9	90.90	232.8	86.73
	-9.8	-11	278.5	99.44	278.5	95.11	267.4	92.26	259.1	90.44	250.9	87.82	232.8	83.73
	-9.5	-10	280.0	98.90	280.0	94.61	267.4	91.80	259.1	89.97	250.9	87.35	232.8	83.26
	-8.5	-9.1	285.5	97.17	283.6	93.00	267.4	90.24	259.1	88.40	250.9	85.83	232.8	81.78
	-7.0	-7.6	298.5	94.56	284.0	90.59	267.4	87.93	259.1	86.03	250.9	83.53	232.8	79.52
	-5.0	-5.6	301.7	91.09	284.0	87.38	267.4	84.84	259.1	82.90	250.9	80.48	232.8	76.55
	-3.0	-3.7	301.7	87.61	284.0	84.18	267.4	81.73	259.1	79.74	250.9	77.40	232.8	73.54
	0.0	-0.7	301.7	82.42	284.0	79.34	267.4	77.08	259.1	75.02	250.9	72.80	232.8	69.06
	3.0	2.2	301.7	77.19	284.0	74.51	267.4	72.44	259.1	70.30	250.9	68.23	232.8	64.54
	5.0	4.1	295.7	66.75	278.4	64.45	261.9	62.62	254.0	60.64	245.8	58.81	228.1	55.50
	7.0	6.0	288.3	62.53	271.3	60.59	255.3	58.96	247.4	56.97	239.5	55.26	222.5	52.11
	9.0	7.9	277.7	57.60	261.2	55.84	245.8	54.33	238.3	52.46	230.8	50.90	214.3	48.02
	11.0	9.8	262.7	52.88	247.0	51.25	232.5	49.85	225.3	48.17	218.2	46.74	202.6	44.06
	13.0	11.8	246.6	47.01	232.0	45.57	218.3	44.36	211.6	42.84	204.9	41.56	190.3	39.19
15.0	13.7	233.2	42.50	219.5	41.18	206.8	40.08	200.2	38.72	193.9	37.56	180.1	35.42	
80	-24.8	-25	175.3	88.94	175.3	90.37	174.1	91.35	174.1	91.82	174.1	94.16	170.9	90.22
	-21.8	-22	213.8	90.37	213.8	91.76	213.8	92.74	213.8	94.16	213.8	90.22	208.0	86.40
	-19.8	-20	226.8	91.28	226.8	92.70	226.8	94.16	226.8	91.39	223.7	87.57	208.0	83.86
	-18.8	-19	231.8	91.76	231.8	94.16	231.8	92.75	231.7	89.98	223.7	86.24	208.0	82.61
	-16.7	-17	239.1	94.16	239.1	91.23	239.1	89.79	232.0	87.06	223.7	83.50	208.0	79.96
	-13.7	-15	250.1	89.82	245.0	87.02	239.1	85.57	232.0	82.88	223.7	79.53	208.0	76.14
	-11.8	-13	256.1	87.06	248.6	84.37	239.1	82.88	232.0	80.23	223.7	77.03	208.0	73.72
	-9.8	-11	262.9	84.17	252.2	81.59	239.1	80.07	232.0	77.46	223.7	74.38	208.0	71.19
	-9.5	-10	264.8	83.74	253.7	81.16	239.1	79.64	232.0	77.03	223.7	73.99	208.0	70.83
	-8.5	-9.1	267.5	82.29	254.8	79.76	239.1	78.24	232.0	75.63	223.7	72.70	208.0	69.55
	-7.0	-7.6	270.2	80.11	254.8	77.65	239.1	76.13	232.0	73.56	223.7	70.71	208.0	67.64
	-5.0	-5.6	270.2	77.22	254.8	74.88	239.1	73.29	232.0	70.75	223.7	68.06	208.0	65.10
	-3.0	-3.7	270.2	74.33	254.8	72.07	239.1	70.47	232.0	67.98	223.7	65.45	208.0	62.57
	0.0	-0.7	270.2	69.96	254.8	67.89	239.1	66.26	232.0	63.80	223.7	61.47	208.0	58.78
	3.0	2.2	270.2	65.63	254.8	63.68	239.1	62.01	232.0	59.60	223.7	57.53	208.0	54.96
	5.0	4.1	264.7	56.71	249.7	54.99	234.4	53.47	227.3	51.30	219.1	49.51	204.1	47.29
	7.0	6.0	258.0	53.24	243.4	51.71	228.5	50.17	221.4	48.10	213.5	46.50	198.6	44.40
	9.0	7.9	248.6	47.76	234.4	46.43	219.9	45.27	213.5	43.51	205.7	41.96	191.5	39.97
	11.0	9.8	235.2	42.47	221.5	41.29	208.0	40.25	201.8	38.69	194.6	37.32	180.9	35.54
	13.0	11.8	220.7	36.93	208.1	35.88	195.4	34.99	189.6	33.63	182.8	32.42	169.9	30.90
15.0	13.7	208.8	33.35	197.0	32.39	184.8	31.60	179.3	30.36	173.0	29.30	160.8	27.90	

# 7. Capacity Tables

Heating Capacity (94HP)

Combination (%)	Outdoor air temp.		Indoor air temp. °C DB											
			16		18		20		21		22		24	
	°C DB	°C WB	TC	PI	TC	PI	TC	PI	TC	PI	TC	PI	TC	PI
70	-24.8	-25	175.3	89.13	175.3	89.60	174.1	90.55	174.1	91.97	174.1	87.65	170.9	83.59
	-21.8	-22	204.9	90.55	204.9	91.03	203.7	91.97	196.6	87.65	190.8	83.59	178.1	79.69
	-19.8	-20	224.6	91.50	216.3	91.97	203.7	88.93	196.6	84.76	190.8	80.90	178.1	77.08
	-18.8	-19	229.3	91.97	216.3	90.41	203.7	87.41	196.6	83.32	190.8	79.54	178.1	75.76
	-16.7	-17	229.3	88.70	216.3	87.10	203.7	84.25	196.6	80.28	190.8	76.73	178.1	73.02
	-13.7	-15	229.3	84.09	216.3	82.42	203.7	79.69	196.6	75.98	190.8	72.67	178.1	69.09
	-11.8	-13	229.3	81.13	216.3	79.45	203.7	76.81	196.6	73.22	190.8	70.10	178.1	66.63
	-9.8	-11	229.3	78.05	216.3	76.30	203.7	73.80	196.6	70.34	190.8	67.41	178.1	64.02
	-9.5	-10	229.3	77.58	216.3	75.83	203.7	73.33	196.6	69.91	190.8	67.02	178.1	63.63
	-8.5	-9.1	229.3	76.06	216.3	74.27	203.7	71.81	196.6	68.46	190.8	65.65	178.1	62.31
	-7.0	-7.6	229.3	73.72	216.3	71.93	203.7	69.55	196.6	66.32	190.8	63.63	178.1	60.35
	-5.0	-5.6	229.3	70.64	216.3	68.80	203.7	66.51	196.6	63.43	190.8	60.94	178.1	57.74
	-3.0	-3.7	229.3	67.55	216.3	65.65	203.7	63.47	196.6	60.55	190.8	58.24	178.1	55.13
	0.0	-0.7	229.3	62.91	216.3	60.97	203.7	58.94	196.6	56.22	190.8	54.19	178.1	51.23
	3.0	2.2	229.3	58.27	216.3	56.28	203.7	54.38	196.6	51.92	190.8	50.14	178.1	47.29
	5.0	4.1	229.3	50.99	212.0	48.03	199.4	46.43	192.7	44.26	186.8	42.85	174.6	40.36
	7.0	6.0	229.3	48.68	206.5	44.52	194.3	43.00	187.6	41.06	182.1	39.81	169.9	37.44
	9.0	7.9	221.0	42.18	199.0	38.53	187.2	37.24	180.9	35.57	175.4	34.48	163.6	32.42
	11.0	9.8	209.2	37.43	188.3	34.21	177.0	33.08	171.1	31.56	166.0	30.62	154.9	28.79
	13.0	11.8	196.3	32.84	176.9	30.04	166.3	29.03	160.5	27.71	155.8	26.86	145.5	25.26
15.0	13.7	185.7	29.30	167.2	26.78	157.3	25.88	151.8	24.71	147.5	23.97	137.6	22.53	
60	-24.8	-25	174.5	88.11	174.5	89.06	173.4	90.48	168.7	85.83	162.8	81.49	152.5	77.38
	-21.8	-22	187.7	89.53	186.0	90.48	174.6	85.83	168.7	81.49	162.8	77.38	152.5	73.43
	-19.8	-20	196.6	90.48	186.0	87.20	174.6	82.74	168.7	78.59	162.8	74.65	152.5	70.78
	-18.8	-19	196.6	88.84	186.0	85.56	174.6	81.18	168.7	77.11	162.8	73.28	152.5	69.45
	-16.7	-17	196.6	85.36	186.0	82.11	174.6	77.93	168.7	74.06	162.8	70.42	152.5	66.68
	-13.7	-15	196.6	80.39	186.0	77.22	174.6	73.31	168.7	69.72	162.8	66.32	152.5	62.73
	-11.8	-13	196.6	77.26	186.0	74.09	174.6	70.35	168.7	66.95	162.8	63.74	152.5	60.22
	-9.8	-11	196.6	73.97	186.0	70.81	174.6	67.26	168.7	64.05	162.8	61.00	152.5	57.57
	-9.5	-10	196.6	73.46	186.0	70.34	174.6	66.79	168.7	63.62	162.8	60.58	152.5	57.18
	-8.5	-9.1	196.6	71.82	186.0	68.69	174.6	65.26	168.7	62.17	162.8	59.21	152.5	55.85
	-7.0	-7.6	196.6	69.35	186.0	66.23	174.6	62.95	168.7	59.99	162.8	57.17	152.5	53.86
	-5.0	-5.6	196.6	66.03	186.0	62.95	174.6	59.83	168.7	57.09	162.8	54.44	152.5	51.24
	-3.0	-3.7	196.6	62.74	186.0	59.66	174.6	56.74	168.7	54.20	162.8	51.70	152.5	48.58
	0.0	-0.7	196.6	57.77	186.0	54.77	174.6	52.12	168.7	49.82	162.8	47.60	152.5	44.63
	3.0	2.2	196.6	52.81	186.0	49.84	174.6	47.47	168.7	45.48	162.8	43.53	152.5	40.65
	5.0	4.1	192.7	44.81	182.5	42.13	171.1	40.10	165.2	38.47	159.7	36.86	149.4	34.37
	7.0	6.0	187.6	41.13	177.8	38.53	166.7	36.73	161.2	35.30	155.7	33.86	145.5	31.48
	9.0	7.9	180.9	35.25	171.1	33.00	160.5	31.48	155.3	30.24	149.8	29.03	140.4	26.97
	11.0	9.8	171.1	31.28	162.0	29.30	151.8	27.94	146.7	26.85	141.6	25.76	132.5	23.93
	13.0	11.8	160.5	27.43	152.2	25.69	142.7	24.48	137.7	23.54	133.0	22.57	124.6	21.01
15.0	13.7	151.8	24.71	143.9	23.12	134.9	21.84	130.5	21.01	125.9	20.15	117.9	18.91	
50	-24.8	-25	164.0	76.76	154.6	78.18	145.5	74.09	140.8	70.27	136.1	66.65	126.7	63.29
	-21.8	-22	164.0	78.18	154.6	74.09	145.5	70.27	140.8	66.65	136.1	63.29	126.7	60.05
	-19.8	-20	164.0	75.34	154.6	71.36	145.5	67.73	140.8	64.23	136.1	61.03	126.7	57.88
	-18.8	-19	164.0	73.90	154.6	70.00	145.5	66.45	140.8	63.05	136.1	59.91	126.7	56.79
	-16.7	-17	164.0	70.93	154.6	67.15	145.5	63.80	140.8	60.52	136.1	57.56	126.7	54.52
	-13.7	-15	164.0	66.68	154.6	63.06	145.5	59.97	140.8	56.90	136.1	54.21	126.7	51.28
	-11.8	-13	164.0	63.99	154.6	60.48	145.5	57.56	140.8	54.60	136.1	52.06	126.7	49.22
	-9.8	-11	164.0	61.14	154.6	57.76	145.5	54.99	140.8	52.18	136.1	49.81	126.7	47.04
	-9.5	-10	164.0	60.71	154.6	57.36	145.5	54.63	140.8	51.83	136.1	49.49	126.7	46.73
	-8.5	-9.1	164.0	59.28	154.6	56.00	145.5	53.35	140.8	50.62	136.1	48.36	126.7	45.64
	-7.0	-7.6	164.0	57.17	154.6	53.97	145.5	51.44	140.8	48.83	136.1	46.68	126.7	44.03
	-5.0	-5.6	164.0	54.32	154.6	51.24	145.5	48.90	140.8	46.41	136.1	44.43	126.7	41.86
	-3.0	-3.7	164.0	51.48	154.6	48.51	145.5	46.34	140.8	44.00	136.1	42.17	126.7	39.71
	0.0	-0.7	164.0	47.22	154.6	44.42	145.5	42.52	140.8	40.37	136.1	38.81	126.7	36.44
	3.0	2.2	164.0	42.97	154.6	40.36	145.5	38.73	140.8	36.75	136.1	35.46	126.7	33.20
	5.0	4.1	160.8	36.31	151.8	34.02	142.4	32.70	138.0	31.06	133.3	30.01	124.3	28.06
	7.0	6.0	156.6	33.19	147.8	31.06	138.8	29.93	134.5	28.41	130.1	27.55	121.1	25.69
	9.0	7.9	151.0	28.72	142.4	26.89	133.7	25.92	129.4	24.63	125.1	23.86	116.8	22.26
	11.0	9.8	143.5	25.80	135.3	24.16	127.1	23.27	122.3	22.10	118.4	21.41	110.5	19.97
	13.0	11.8	134.1	22.38	126.3	20.97	118.8	20.19	114.9	19.30	111.3	18.60	103.5	17.43
15.0	13.7	126.7	20.20	119.6	18.91	112.5	18.21	108.9	17.32	105.4	16.77	97.9	15.65	

**Note**

1. TC: Total Capacity(kW), PI: Power Input(kW, Comp. + Outdoor fan motor)
2. Capacity tables show the average value of conditions which may occur.
3. The heating capacity table is based on the values expressed as Max. in the specification of the outdoor unit. (When measuring the Max. heating capacity, the setting status of the indoor unit is the same as that for measuring the heating capacity of the indoor unit.)



# 7. Capacity Tables

## ◆ ARUM960LTE5

Heating Capacity (96HP)

Combination (%)	Outdoor air temp.		Indoor air temp. °C DB											
			16		18		20		21		22		24	
	°C DB	°C WB	TC	PI	TC	PI	TC	PI	TC	PI	TC	PI	TC	PI
130	-24.8	-25	181.6	102.9	181.6	103.7	180.4	104.4	180.4	105.5	180.4	106.6	177.2	108.3
	-21.8	-22	224.0	104.5	224.0	105.4	222.4	106.1	222.4	107.2	222.4	108.3	218.0	109.9
	-19.8	-20	237.6	105.6	237.6	106.5	236.0	107.2	236.0	108.3	236.0	109.4	231.6	111.0
	-18.8	-19	243.2	106.2	243.2	107.0	241.6	107.8	241.6	108.9	241.6	109.9	236.8	111.6
	-16.7	-17	254.4	107.4	254.4	108.2	252.8	108.9	252.8	110.0	252.8	111.1	248.0	112.8
	-13.7	-15	270.4	109.0	270.4	109.9	268.8	110.6	268.8	111.7	268.8	112.8	263.6	108.7
	-11.8	-13	279.2	110.1	279.2	110.9	277.6	111.6	277.6	112.8	277.6	110.0	273.6	106.1
	-9.8	-11	288.4	111.2	288.4	112.0	286.8	112.8	286.8	109.9	286.8	107.2	284.0	103.4
	-9.5	-10	290.0	111.4	290.0	112.2	288.4	112.3	288.4	109.4	288.0	106.7	285.6	102.9
	-8.5	-9.1	295.6	111.9	295.6	112.8	294.0	110.8	294.0	108.0	292.8	105.3	290.8	101.6
	-7.0	-7.6	304.0	112.8	304.0	110.6	302.0	108.6	302.0	105.8	302.0	103.1	298.4	99.52
	-5.0	-5.6	315.2	110.0	315.2	107.8	313.2	105.7	313.2	102.9	313.2	100.2	308.8	96.80
	-3.0	-3.7	326.4	107.3	326.4	104.9	324.4	102.7	324.4	99.96	324.4	97.32	319.2	94.04
	0.0	-0.7	343.2	103.2	343.2	100.6	340.8	98.32	340.8	95.60	340.8	93.00	335.2	89.96
	3.0	2.2	360.0	99.12	360.0	96.32	357.6	93.88	357.6	91.24	357.6	88.64	335.6	85.88
	5.0	4.1	364.4	87.56	363.6	84.80	361.2	82.40	361.2	79.92	353.2	77.52	328.8	75.04
	7.0	6.0	365.6	83.32	364.8	80.64	362.8	78.32	356.8	76.04	344.0	73.76	320.4	71.56
	9.0	7.9	354.0	77.80	353.2	75.28	352.4	73.08	343.6	70.96	331.6	68.84	308.8	66.80
	11.0	9.8	334.8	73.20	334.0	70.84	333.2	68.76	324.8	66.76	313.6	64.80	292.0	62.84
	13.0	11.8	314.4	67.56	314.0	65.40	312.8	63.48	305.2	61.64	294.4	59.80	274.0	58.00
15.0	13.7	297.6	62.92	296.8	60.88	296.0	59.12	288.8	57.40	278.8	55.68	259.2	54.00	
120	-24.8	-25	180.4	103.7	180.4	104.4	179.2	105.5	179.2	106.6	179.2	108.3	176.0	109.4
	-21.8	-22	222.4	105.4	222.4	106.1	220.8	107.2	220.8	108.3	220.8	109.9	216.8	111.1
	-19.8	-20	236.0	106.5	236.0	107.2	234.4	108.3	234.4	109.4	234.4	111.0	230.0	112.2
	-18.8	-19	241.2	107.0	241.2	107.8	239.6	108.9	239.6	109.9	239.6	111.6	235.2	112.8
	-16.7	-17	252.4	108.2	252.4	108.9	250.8	110.0	250.8	111.1	250.8	112.8	246.0	110.1
	-13.7	-15	268.4	109.9	268.4	110.6	266.8	111.7	266.8	112.8	266.8	108.8	261.6	106.4
	-11.8	-13	277.2	110.9	277.2	111.6	275.6	112.8	275.6	110.0	275.6	106.4	271.6	104.0
	-9.8	-11	286.4	112.0	286.4	112.8	284.8	109.7	284.8	107.1	284.8	103.8	282.0	101.5
	-9.5	-10	288.0	112.2	288.0	112.3	286.4	109.3	286.4	106.6	286.4	103.4	283.6	101.1
	-8.5	-9.1	293.6	112.8	293.6	110.7	291.6	107.8	291.6	105.2	291.6	102.1	288.4	99.84
	-7.0	-7.6	302.0	110.4	302.0	108.3	300.0	105.5	300.0	103.0	300.0	100.1	296.4	97.96
	-5.0	-5.6	313.2	107.2	313.2	105.1	311.2	102.4	311.2	100.1	311.2	97.48	306.8	95.44
	-3.0	-3.7	324.0	104.1	324.0	101.9	322.0	99.40	322.0	97.20	322.0	94.88	315.2	92.92
	0.0	-0.7	340.8	99.36	340.8	97.12	338.4	94.84	338.4	92.80	338.4	90.96	315.2	89.16
	3.0	2.2	357.2	94.64	357.2	92.32	355.2	90.28	350.0	88.44	339.2	87.04	315.2	85.40
	5.0	4.1	362.0	83.00	360.8	80.80	354.8	79.00	343.2	77.32	332.4	76.20	308.8	74.72
	7.0	6.0	363.6	78.60	360.0	76.48	346.0	74.96	334.4	73.52	324.0	72.84	300.8	71.52
	9.0	7.9	351.6	73.16	346.8	71.16	333.2	69.76	322.0	68.44	312.0	67.76	290.0	66.56
	11.0	9.8	332.4	68.60	328.0	66.72	315.2	65.40	304.4	64.16	295.2	63.56	274.0	62.44
	13.0	11.8	312.4	63.08	308.0	61.36	296.0	60.16	286.0	59.00	277.2	58.44	257.6	57.40
15.0	13.7	295.6	58.48	291.6	56.88	280.0	55.76	270.8	54.72	262.4	54.20	243.6	53.24	
110	-24.8	-25	179.6	104.4	179.6	105.5	178.4	106.6	178.4	108.3	178.4	109.4	174.8	110.0
	-21.8	-22	221.2	106.1	221.2	107.2	219.6	108.3	219.6	109.9	219.6	111.1	215.6	111.6
	-19.8	-20	234.8	107.2	234.8	108.3	233.2	109.4	233.2	111.0	233.2	112.2	228.8	112.8
	-18.8	-19	240.0	107.8	240.0	108.9	238.4	109.9	238.4	111.6	238.4	112.8	234.0	111.4
	-16.7	-17	251.2	108.9	251.2	110.0	249.6	111.1	249.6	112.8	249.6	109.9	244.8	108.4
	-13.7	-15	266.8	110.6	266.8	111.7	265.2	112.8	265.2	108.4	265.2	105.8	265.2	104.2
	-11.8	-13	275.6	111.6	275.6	112.8	274.0	109.7	274.0	105.7	274.0	103.2	274.0	101.5
	-9.8	-11	284.8	112.8	284.8	109.3	283.2	106.5	283.2	102.8	283.2	100.5	282.0	98.72
	-9.5	-10	286.4	112.2	286.4	108.8	284.8	106.0	284.8	102.4	284.8	100.1	283.6	98.32
	-8.5	-9.1	292.0	110.4	292.0	107.1	290.4	104.4	290.4	100.9	290.4	98.68	283.6	96.88
	-7.0	-7.6	300.4	107.6	300.4	104.5	298.4	102.0	298.4	98.76	298.4	96.64	283.6	94.80
	-5.0	-5.6	311.2	103.9	311.2	101.0	309.2	98.80	309.2	95.88	303.6	93.92	283.6	91.96
	-3.0	-3.7	322.4	100.2	322.4	97.60	320.4	95.56	314.4	92.96	303.6	91.16	283.6	89.16
	0.0	-0.7	338.8	94.60	338.8	92.44	324.8	90.76	314.4	88.64	303.6	87.08	283.6	84.96
	3.0	2.2	355.2	89.04	346.4	87.28	324.8	85.92	314.4	84.32	303.6	82.96	283.6	80.72
	5.0	4.1	359.2	77.40	339.2	75.92	318.4	74.80	308.0	73.52	297.6	72.40	278.0	70.28
	7.0	6.0	350.0	72.64	330.8	71.56	310.4	70.76	300.4	69.88	290.0	69.00	270.8	66.84
	9.0	7.9	337.2	67.24	318.4	66.24	298.8	65.48	289.2	64.68	279.6	63.88	260.8	61.88
	11.0	9.8	318.8	62.68	301.2	61.72	282.8	61.04	273.6	60.32	264.4	59.52	246.8	57.68
	13.0	11.8	299.2	57.28	282.8	56.40	265.6	55.76	256.8	55.08	248.0	54.40	231.6	52.72
15.0	13.7	283.2	52.68	267.6	51.88	251.2	51.28	242.8	50.68	234.8	50.04	219.2	48.48	

# 7. Capacity Tables

Heating Capacity (96HP)

Combination (%)	Outdoor air temp.		Indoor air temp. °C DB											
			16		18		20		21		22		24	
	°C DB	°C WB	TC	PI	TC	PI	TC	PI	TC	PI	TC	PI	TC	PI
100	-24.8	-25	178.8	115.9	178.8	115.5	177.6	107.8	177.6	114.5	177.6	114.0	174.0	113.8
	-21.8	-22	220.0	115.3	220.0	114.9	218.8	111.2	218.8	113.8	218.8	115.0	214.4	113.2
	-19.8	-20	233.6	114.9	233.6	114.4	232.4	113.3	232.4	113.4	232.4	113.5	228.0	112.8
	-18.8	-19	238.8	114.7	237.6	114.2	237.6	113.8	237.6	113.2	237.6	112.8	232.8	111.0
	-16.7	-17	248.4	114.2	248.4	113.8	248.4	115.0	247.2	112.8	247.2	109.2	242.4	107.4
	-13.7	-15	265.6	113.6	265.6	113.2	264.0	112.8	264.0	107.6	264.0	104.1	259.2	102.2
	-11.8	-13	274.4	113.2	272.8	112.8	272.8	109.3	272.8	104.3	272.8	100.8	259.2	98.88
	-9.8	-11	283.2	112.8	283.2	108.9	282.0	105.7	282.0	100.9	278.0	97.44	259.2	95.40
	-9.5	-10	284.8	112.2	284.8	108.3	283.6	105.2	283.6	100.4	278.0	96.92	259.2	94.88
	-8.5	-9.1	290.4	110.2	290.4	106.4	289.2	103.3	287.6	98.64	278.0	95.24	259.2	93.12
	-7.0	-7.6	303.6	107.2	302.4	103.5	297.2	100.6	287.6	96.08	278.0	92.68	259.2	90.52
	-5.0	-5.6	316.8	103.1	313.6	99.68	297.2	97.00	287.6	92.60	278.0	89.28	259.2	87.04
	-3.0	-3.7	326.0	99.12	316.4	95.80	297.2	93.36	287.6	89.16	278.0	85.88	259.2	83.56
	0.0	-0.7	335.2	93.08	316.4	90.04	297.2	87.92	287.6	84.00	278.0	80.76	259.2	78.36
	3.0	2.2	335.2	87.04	316.4	84.24	297.2	82.48	287.6	78.84	278.0	75.64	259.2	73.16
	5.0	4.1	328.4	75.36	310.0	72.88	291.2	71.36	282.0	68.16	272.8	65.24	254.0	62.92
	7.0	6.0	320.0	70.32	302.0	68.12	284.0	66.92	274.8	64.04	265.6	61.28	247.6	58.92
	9.0	7.9	308.4	64.80	290.8	62.76	273.6	61.68	264.8	59.00	256.0	56.44	238.4	54.28
	11.0	9.8	291.6	60.08	275.2	58.16	258.4	57.16	250.4	54.68	242.0	52.32	225.6	50.32
	13.0	11.8	274.0	54.52	258.4	52.80	242.8	51.88	235.2	49.64	227.2	47.52	211.6	45.68
15.0	13.7	259.2	49.80	244.4	48.24	229.6	47.40	222.4	45.32	215.2	43.36	200.4	41.72	
90	-24.8	-25	178.0	102.9	178.0	104.5	176.8	105.7	176.8	106.2	176.8	107.4	173.6	109.0
	-21.8	-22	219.2	104.5	219.2	106.2	218.0	107.4	218.0	107.9	218.0	109.0	213.6	104.4
	-19.8	-20	232.8	105.6	232.8	107.3	231.2	108.5	231.2	109.0	231.2	109.9	226.8	101.4
	-18.8	-19	238.8	106.2	237.6	107.9	236.4	109.0	236.4	107.4	236.4	104.3	232.0	99.84
	-16.7	-17	248.4	107.4	248.4	109.0	247.6	105.7	247.6	104.0	247.6	101.0	236.8	96.60
	-13.7	-15	265.6	109.0	265.6	104.1	263.2	101.0	263.2	99.20	255.2	96.32	236.8	92.00
	-11.8	-13	274.4	105.6	272.8	101.0	271.6	97.92	263.6	96.12	255.2	93.36	236.8	89.08
	-9.8	-11	283.2	102.1	283.2	97.68	272.0	94.76	263.6	92.88	255.2	90.20	236.8	86.00
	-9.5	-10	284.8	101.6	284.8	97.16	272.0	94.28	263.6	92.40	255.2	89.72	236.8	85.52
	-8.5	-9.1	290.4	99.80	288.4	95.52	272.0	92.68	263.6	90.80	255.2	88.16	236.8	84.00
	-7.0	-7.6	303.6	97.12	288.8	93.04	272.0	90.32	263.6	88.36	255.2	85.80	236.8	81.68
	-5.0	-5.6	306.8	93.56	288.8	89.76	272.0	87.16	263.6	85.16	255.2	82.68	236.8	78.64
	-3.0	-3.7	306.8	90.00	288.8	86.48	272.0	83.96	263.6	81.92	255.2	79.52	236.8	75.56
	0.0	-0.7	306.8	84.68	288.8	81.52	272.0	79.20	263.6	77.08	255.2	74.80	236.8	70.96
	3.0	2.2	306.8	79.32	288.8	76.56	272.0	74.44	263.6	72.24	255.2	70.12	236.8	66.32
	5.0	4.1	300.8	68.60	283.2	66.24	266.4	64.36	258.4	62.32	250.0	60.44	232.0	57.04
	7.0	6.0	293.2	64.28	276.0	62.28	259.6	60.60	251.6	58.56	243.6	56.80	226.4	53.56
	9.0	7.9	282.4	59.20	265.6	57.40	250.0	55.84	242.4	53.92	234.8	52.32	218.0	49.36
	11.0	9.8	267.2	54.36	251.2	52.68	236.4	51.24	229.2	49.52	222.0	48.04	206.0	45.28
	13.0	11.8	250.8	48.32	236.0	46.84	222.0	45.60	215.2	44.04	208.4	42.72	193.6	40.28
15.0	13.7	237.2	43.68	223.2	42.32	210.4	41.20	203.6	39.80	197.2	38.60	183.2	36.40	
80	-24.8	-25	177.2	90.52	177.2	92.20	176.0	93.36	176.0	93.92	176.0	96.68	172.8	92.64
	-21.8	-22	216.8	92.20	216.8	93.84	216.8	95.00	216.8	96.68	216.8	92.64	211.6	88.72
	-19.8	-20	230.4	93.28	230.4	94.96	230.4	96.68	230.4	93.84	227.6	89.92	211.6	86.12
	-18.8	-19	235.6	93.84	235.6	96.68	235.6	95.24	235.6	92.40	227.6	88.56	211.6	84.84
	-16.7	-17	243.2	96.68	243.2	93.68	243.2	92.20	236.0	89.40	227.6	85.76	211.6	82.12
	-13.7	-15	254.4	92.24	249.2	89.36	243.2	87.88	236.0	85.12	227.6	81.68	211.6	78.20
	-11.8	-13	260.4	89.40	252.8	86.64	243.2	85.12	236.0	82.40	227.6	79.12	211.6	75.72
	-9.8	-11	267.2	86.44	256.4	83.80	243.2	82.24	236.0	79.56	227.6	76.40	211.6	73.12
	-9.5	-10	269.2	86.00	258.0	83.36	243.2	81.80	236.0	79.12	227.6	76.00	211.6	72.76
	-8.5	-9.1	272.0	84.52	259.2	81.92	243.2	80.36	236.0	77.68	227.6	74.68	211.6	71.44
	-7.0	-7.6	274.8	82.28	259.2	79.76	243.2	78.20	236.0	75.56	227.6	72.64	211.6	69.48
	-5.0	-5.6	274.8	79.32	259.2	76.92	243.2	75.28	236.0	72.68	227.6	69.92	211.6	66.88
	-3.0	-3.7	274.8	76.36	259.2	74.04	243.2	72.40	236.0	69.84	227.6	67.24	211.6	64.28
	0.0	-0.7	274.8	71.88	259.2	69.76	243.2	68.08	236.0	65.56	227.6	63.16	211.6	60.40
	3.0	2.2	274.8	67.44	259.2	65.44	243.2	63.72	236.0	61.24	227.6	59.12	211.6	56.48
	5.0	4.1	269.2	58.28	254.0	56.52	238.4	54.96	231.2	52.72	222.8	50.88	207.6	48.60
	7.0	6.0	262.4	54.72	247.6	53.16	232.4	51.56	225.2	49.44	217.2	47.80	202.0	45.64
	9.0	7.9	252.8	49.08	238.4	47.72	223.6	46.52	217.2	44.72	209.2	43.12	194.8	41.08
	11.0	9.8	239.2	43.64	225.2	42.44	211.6	41.36	205.2	39.76	198.0	38.36	184.0	36.52
	13.0	11.8	224.4	37.96	211.6	36.88	198.8	35.96	192.8	34.56	186.0	33.32	172.8	31.76
15.0	13.7	212.4	34.28	200.4	33.28	188.0	32.48	182.4	31.20	176.0	30.12	163.6	28.68	

# 7. Capacity Tables

Heating Capacity (96HP)

Combination (%)	Outdoor air temp.		Indoor air temp. °C DB											
			16		18		20		21		22		24	
	°C DB	°C WB	TC	PI	TC	PI	TC	PI	TC	PI	TC	PI	TC	PI
70	-24.8	-25	177.2	91.08	177.2	91.64	176.0	92.76	176.0	94.44	176.0	90.00	172.8	85.84
	-21.8	-22	208.4	92.76	208.4	93.32	207.2	94.44	200.0	90.00	194.0	85.84	181.2	81.84
	-19.8	-20	229.2	93.88	220.0	94.44	207.2	91.32	200.0	87.04	194.0	83.08	181.2	79.16
	-18.8	-19	233.2	94.44	220.0	92.84	207.2	89.76	200.0	85.56	194.0	81.68	181.2	77.80
	-16.7	-17	233.2	91.08	220.0	89.44	207.2	86.52	200.0	82.44	194.0	78.80	181.2	75.00
	-13.7	-15	233.2	86.36	220.0	84.64	207.2	81.84	200.0	78.04	194.0	74.64	181.2	70.96
	-11.8	-13	233.2	83.32	220.0	81.60	207.2	78.88	200.0	75.20	194.0	72.00	181.2	68.44
	-9.8	-11	233.2	80.16	220.0	78.36	207.2	75.80	200.0	72.24	194.0	69.24	181.2	65.76
	-9.5	-10	233.2	79.68	220.0	77.88	207.2	75.32	200.0	71.80	194.0	68.84	181.2	65.36
	-8.5	-9.1	233.2	78.12	220.0	76.28	207.2	73.76	200.0	70.32	194.0	67.44	181.2	64.00
	-7.0	-7.6	233.2	75.72	220.0	73.88	207.2	71.44	200.0	68.12	194.0	65.36	181.2	62.00
	-5.0	-5.6	233.2	72.56	220.0	70.68	207.2	68.32	200.0	65.16	194.0	62.60	181.2	59.32
	-3.0	-3.7	233.2	69.40	220.0	67.44	207.2	65.20	200.0	62.20	194.0	59.84	181.2	56.64
	0.0	-0.7	233.2	64.64	220.0	62.64	207.2	60.56	200.0	57.76	194.0	55.68	181.2	52.64
	3.0	2.2	233.2	59.88	220.0	57.84	207.2	55.88	200.0	53.36	194.0	51.52	181.2	48.60
	5.0	4.1	233.2	52.40	215.6	49.36	202.8	47.72	196.0	45.48	190.0	44.04	177.6	41.48
	7.0	6.0	233.2	50.04	210.0	45.76	197.6	44.20	190.8	42.20	185.2	40.92	172.8	38.48
	9.0	7.9	224.8	43.36	202.4	39.60	190.4	38.28	184.0	36.56	178.4	35.44	166.4	33.32
	11.0	9.8	212.8	38.48	191.6	35.16	180.0	34.00	174.0	32.44	168.8	31.48	157.6	29.60
	13.0	11.8	199.6	33.76	180.0	30.88	169.2	29.84	163.2	28.48	158.4	27.60	148.0	25.96
15.0	13.7	188.8	30.12	170.0	27.52	160.0	26.60	154.4	25.40	150.0	24.64	140.0	23.16	
60	-24.8	-25	177.2	89.96	177.2	91.08	176.0	92.76	171.6	88.00	165.6	83.56	155.2	79.36
	-21.8	-22	190.8	91.64	189.2	92.76	177.6	88.00	171.6	83.56	165.6	79.36	155.2	75.32
	-19.8	-20	200.0	92.76	189.2	89.40	177.6	84.84	171.6	80.60	165.6	76.56	155.2	72.60
	-18.8	-19	200.0	91.08	189.2	87.72	177.6	83.24	171.6	79.08	165.6	75.16	155.2	71.24
	-16.7	-17	200.0	87.52	189.2	84.20	177.6	79.92	171.6	75.96	165.6	72.24	155.2	68.40
	-13.7	-15	200.0	82.44	189.2	79.20	177.6	75.20	171.6	71.52	165.6	68.04	155.2	64.36
	-11.8	-13	200.0	79.24	189.2	76.00	177.6	72.16	171.6	68.88	165.6	65.40	155.2	61.80
	-9.8	-11	200.0	75.88	189.2	72.64	177.6	69.00	171.6	65.72	165.6	62.60	155.2	59.08
	-9.5	-10	200.0	75.36	189.2	72.16	177.6	68.52	171.6	65.28	165.6	62.16	155.2	58.68
	-8.5	-9.1	200.0	73.68	189.2	70.48	177.6	66.96	171.6	63.80	165.6	60.76	155.2	57.32
	-7.0	-7.6	200.0	71.16	189.2	67.96	177.6	64.60	171.6	61.56	165.6	58.68	155.2	55.28
	-5.0	-5.6	200.0	67.76	189.2	64.60	177.6	61.40	171.6	58.60	165.6	55.88	155.2	52.60
	-3.0	-3.7	200.0	64.40	189.2	61.24	177.6	58.24	171.6	55.64	165.6	53.08	155.2	49.88
	0.0	-0.7	200.0	59.32	189.2	56.24	177.6	53.52	171.6	51.16	165.6	48.88	155.2	45.84
	3.0	2.2	200.0	54.24	189.2	51.20	177.6	48.76	171.6	46.72	165.6	44.72	155.2	41.76
	5.0	4.1	196.0	46.04	185.6	43.28	174.0	41.20	168.0	39.52	162.4	37.88	152.0	35.32
	7.0	6.0	190.8	42.28	180.8	39.60	169.6	37.76	164.0	36.28	158.4	34.80	148.0	32.36
	9.0	7.9	184.0	36.24	174.0	33.92	163.2	32.36	158.0	31.08	152.4	29.84	142.8	27.72
	11.0	9.8	174.0	32.16	164.8	30.12	154.4	28.72	149.2	27.60	144.0	26.48	134.8	24.60
	13.0	11.8	163.2	28.20	154.8	26.40	145.2	25.16	140.0	24.20	135.2	23.20	126.8	21.60
15.0	13.7	154.4	25.40	146.4	23.76	137.2	22.44	132.8	21.60	128.0	20.72	120.0	19.44	
50	-24.8	-25	166.8	78.60	157.2	80.28	148.0	76.08	143.2	72.16	138.4	68.44	128.8	65.00
	-21.8	-22	166.8	80.28	157.2	76.08	148.0	72.16	143.2	68.44	138.4	65.00	128.8	61.68
	-19.8	-20	166.8	77.36	157.2	73.28	148.0	69.56	143.2	65.96	138.4	62.68	128.8	59.44
	-18.8	-19	166.8	75.88	157.2	71.88	148.0	68.24	143.2	64.76	138.4	61.52	128.8	58.32
	-16.7	-17	166.8	72.84	157.2	68.96	148.0	65.52	143.2	62.16	138.4	59.12	128.8	56.00
	-13.7	-15	166.8	68.48	157.2	64.76	148.0	61.60	143.2	58.44	138.4	55.68	128.8	52.68
	-11.8	-13	166.8	65.72	157.2	62.12	148.0	59.12	143.2	56.08	138.4	53.48	128.8	50.56
	-9.8	-11	166.8	62.80	157.2	59.32	148.0	56.48	143.2	53.60	138.4	51.16	128.8	48.32
	-9.5	-10	166.8	62.36	157.2	58.92	148.0	56.12	143.2	53.24	138.4	50.84	128.8	48.00
	-8.5	-9.1	166.8	60.88	157.2	57.52	148.0	54.80	143.2	52.00	138.4	49.68	128.8	46.88
	-7.0	-7.6	166.8	58.72	157.2	55.44	148.0	52.84	143.2	50.16	138.4	47.96	128.8	45.24
	-5.0	-5.6	166.8	55.80	157.2	52.64	148.0	50.24	143.2	47.68	138.4	45.64	128.8	43.00
	-3.0	-3.7	166.8	52.88	157.2	49.84	148.0	47.60	143.2	45.20	138.4	43.32	128.8	40.80
	0.0	-0.7	166.8	48.52	157.2	45.64	148.0	43.68	143.2	41.48	138.4	39.88	128.8	37.44
	3.0	2.2	166.8	44.16	157.2	41.48	148.0	39.80	143.2	37.76	138.4	36.44	128.8	34.12
	5.0	4.1	163.6	37.32	154.4	34.96	144.8	33.60	140.4	31.92	135.6	30.84	126.4	28.84
	7.0	6.0	159.2	34.12	150.4	31.92	141.2	30.76	136.8	29.20	132.4	28.32	123.2	26.40
	9.0	7.9	153.6	29.52	144.8	27.64	136.0	26.64	131.6	25.32	127.2	24.52	118.8	22.88
	11.0	9.8	146.0	26.52	137.6	24.84	129.2	23.92	124.4	22.72	120.4	22.00	112.4	20.52
	13.0	11.8	136.4	23.00	128.4	21.56	120.8	20.76	116.8	19.84	113.2	19.12	105.2	17.92
15.0	13.7	128.8	20.76	121.6	19.44	114.4	18.72	110.8	17.80	107.2	17.24	99.6	16.08	

**Note**

1. TC: Total Capacity(kW), PI: Power Input(kW, Comp. + Outdoor fan motor)
2. Capacity tables show the average value of conditions which may occur.
3. The heating capacity table is based on the values expressed as Max. in the specification of the outdoor unit. (When measuring the Max. heating capacity, the setting status of the indoor unit is the same as that for measuring the heating capacity of the indoor unit.)









## 8. Capacity Correction Factor

### Note

- These figures illustrate the rate of change in capacity of a standard indoor unit system at maximum load under standard conditions. (Moreover, under partial load conditions there is only a minor deviation from the rate of change in capacity shown in the above figures.)
- With this outdoor unit, evaporating pressure constant control when cooling, and condensing pressure constant control when heating is carried out.
- If heat insulation of piping is insufficient, heat loss will become larger and capacity will decrease.
- Method of calculating cooling / heating capacity : maximum cooling / heating capacity of outside units = cooling / heating capacity of outside units obtained from capacity table X capacity correction factor due to piping length to the farthest indoor unit
- Equivalent piping length for Y Branch and other pipes can be calculated with following table.

mm (inch)	Ø6.35 (1/4)	Ø9.52 (3/8)	Ø12.7 (1/2)	Ø15.88 (5/8)	Ø19.05 (3/4)	Ø22.2 (7/8)	Ø25.4 (1)	Ø28.58 (1-1/8)	Ø31.8 (1-1/4)	Ø34.9 (1-3/8)	Ø38.1 (1-1/2)	Ø41.3 (1-5/8)	Ø44.5 (1-3/4)	Ø53.98 (2-1/8)
Elbow (m)	0.16	0.18	0.2	0.25	0.35	0.4	0.45	0.5	0.55	0.6	0.65	0.7	0.75	0.85
Y Branch (m)	0.5													
Header (m)	1													
HR Unit (m)	2.5													

- When the any one (or both ) of below conditions are satisfied, the diameter of main pipe must be increased.
  - The equivalent length between outdoor unit and the farthest indoor unit is 90m or more (Liquid or Gas pipes are increased in accordance with below table)
  - The level difference (Outdoor unit ↔ Indoor unit) is 50m or more (Only liquid pipe is increased)
 Refer to the table (Refrigerant pipe diameter from outdoor unit to first branch.) in the 'installation of outdoor units' part.
- Read cooling / heating capacity rate of change in the above figures based on the following equivalent length. : overall equivalent length = (equivalent length of main pipe) X correction factor + (equivalent length after first branching)
  - 8, 10, 12, 14, 16, 18, 20, 22, 24, 26, 28, 30, 32, 34HP**

Rate of change (object piping)	Correction factor	
	standard size	size increase
Cooling(Gas pipe)	1	0.5
Heating(Liquid pipe)	1	0.2

- 36, 38, 40, 42, 44, 46, 48, 50, 52, 54, 56, 58, 60HP**

Rate of change (object piping)	Correction factor	
	standard size	size increase
Cooling(Gas pipe)	1	0.5
Heating(Liquid pipe)	1	0.4

- 62, 64, 66, 68, 70, 72, 74, 76, 78, 80, 82, 84, 86, 88, 90, 92, 94, 96HP**

Rate of change (object piping)	Correction factor	
	standard size	size increase
Cooling(Gas pipe)	1	-
Heating(Liquid pipe)	1	0.4



## 8. Capacity Correction Factor

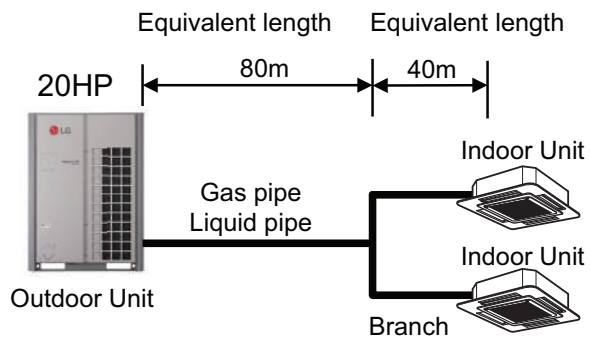

\* (Cooling) Overall equivalent length =  $80 \text{ m} \times 0.5 + 40 \text{ m} = 80 \text{ m}$

\* (Heating) Overall equivalent length =  $80 \text{ m} \times 0.2 + 40 \text{ m} = 56 \text{ m}$

The rate of change in Cooling capacity when  $HU=0\text{m}$  is thus approximately 0.92  
 Heating capacity when  $HU=0\text{m}$  is thus approximately 1.00

## 8. Capacity Correction Factor

### 8.5 Defrosting Correction Factor for Heating Operation

The capacity table does not consider reduction in capacity when frost has accumulated or during defrosting.

The capacity values considered these factors, in other words the integrated heating capacity values, can be obtained as follows:

#### [ Formula ]

- Integrated Heating capacity = A
- Value given in table of capacity characteristics = B
- Integrated correction factor for frost accumulation = C
- $A=B \times C$

#### [ Correction factor for finding integrated Heating capacity ]

Inlet Port Temperature of Heat Exchange (°C, RH 85%)	-7	-5	-3	0	3	5	7
Integrated Correction Factor for Frost Accumulation (Normal Defrost Operation)	0.92	0.90	0.86	0.84	0.85	0.90	1.0
Integrated Correction Factor for Frost Accumulation (Partial Defrost Operation)	0.92	0.90	0.86	0.90	0.93	0.95	1.0
Integrated Correction Factor for Frost Accumulation (Normal Defrost Operation / Dual sensing )	0.92	0.90	0.86	0.86	0.86	0.91	1.0
Integrated Correction Factor for Frost Accumulation (Partial Defrost Operation / Dual sensing )	0.92	0.90	0.86	0.91	0.94	0.95	1.0

#### ◆ Normal Defrost Operation

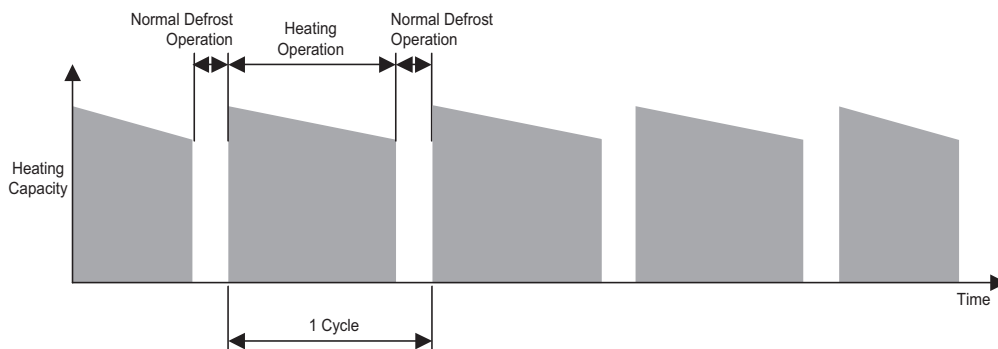

#### ◆ Partial Defrost Operation

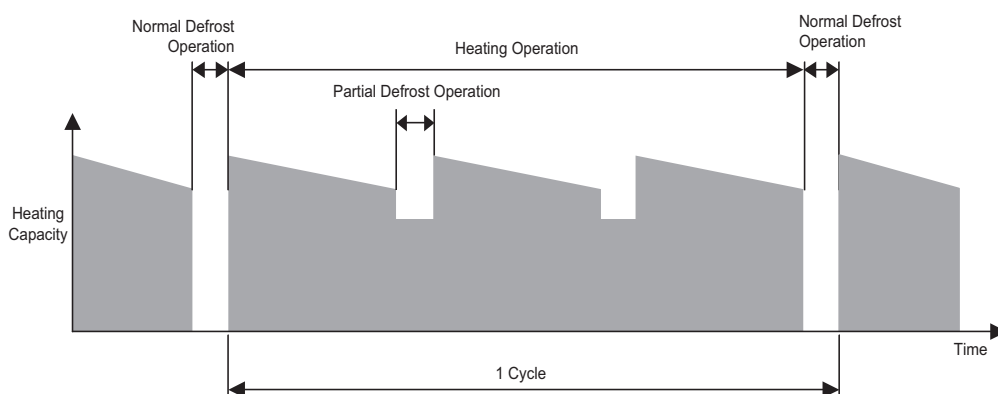

Please note that there will be temporary reduction in capacity when snow piles up on the outside surface of the outdoor unit heat exchanger. Of course, it will be different in degree depending on a number of other factors, for example, the outdoor temperature(°CDB), the relative humidity(RH) and the frosting amount.

## 9. Operation Limits

### ■ Cooling / Heating Operation

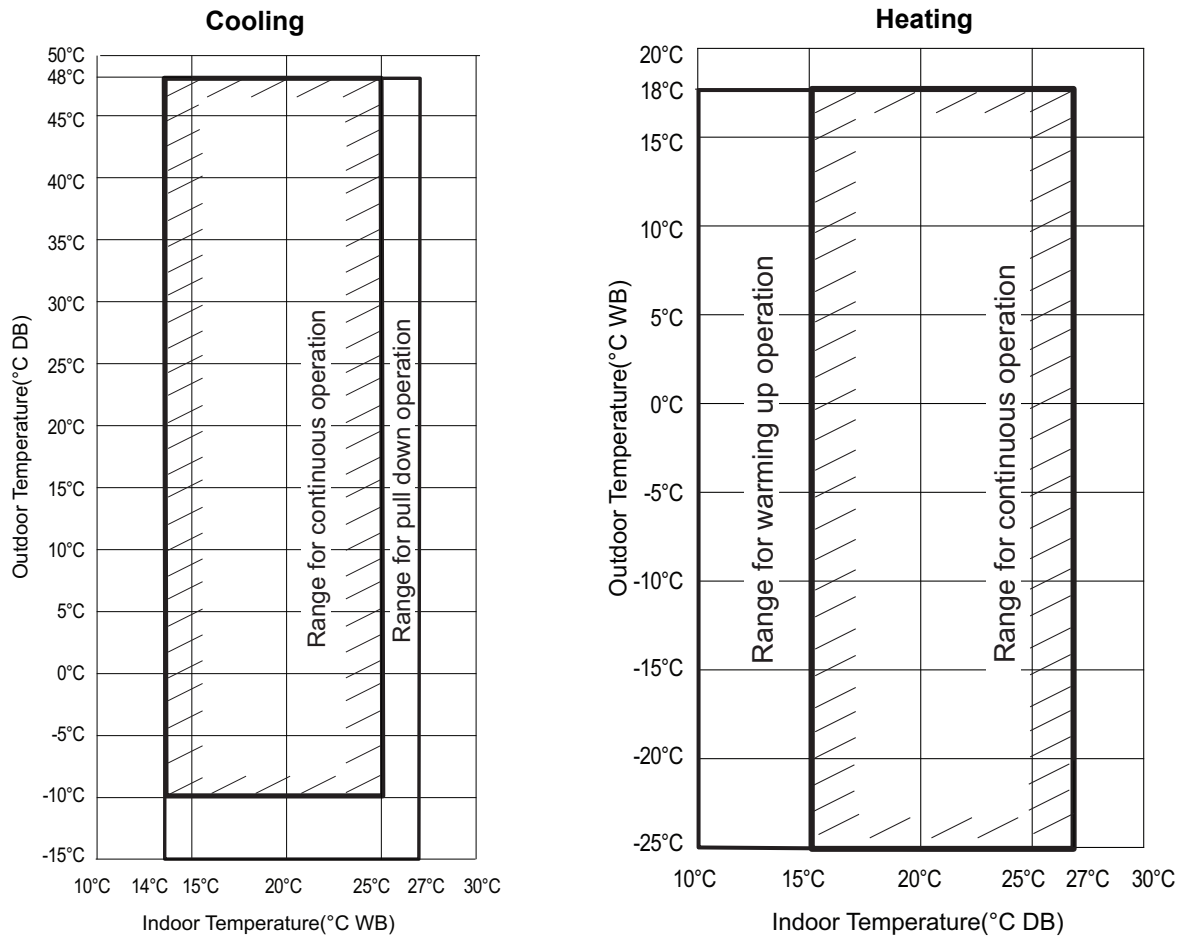

#### Note

1. These figures assume the following operating conditions:  
Equivalent piping length:7.5m  
Level difference:0m
2. Range of pull down operation:  
If the relative humidity is too high, cooling capacity can be decreased by the sensible heat reduction.
3. Warming up operation means that the outdoor unit operates to reach the range of continuous operating, however it may not operate continuously due to safety or protection logic.

## 9. Operation Limits

### ■ Simultaneous Cooling / Heating Operation

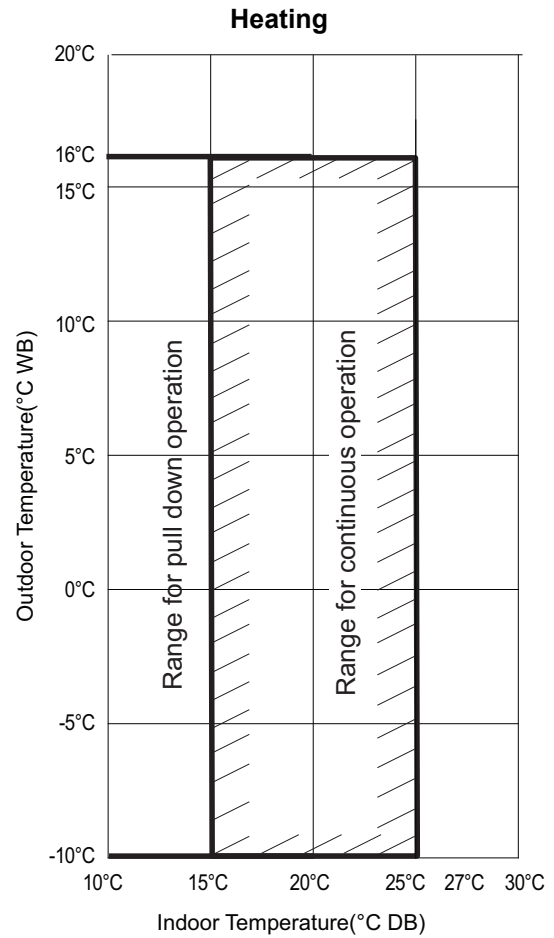
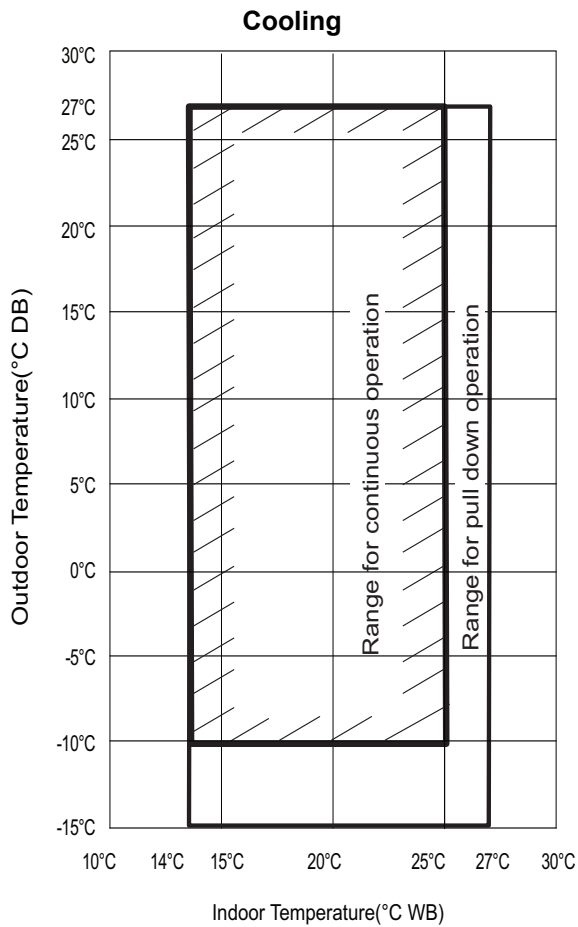

#### Note

1. These figures assume the following operating conditions:  
 Equivalent piping length: 7.5m  
 Level difference: 0m
2. Range of pull down operation:  
 If the relative humidity is too high, cooling capacity can be decreased by the sensible heat reduction.

## 10. Sound Levels

### 10.1 Sound Pressure Level

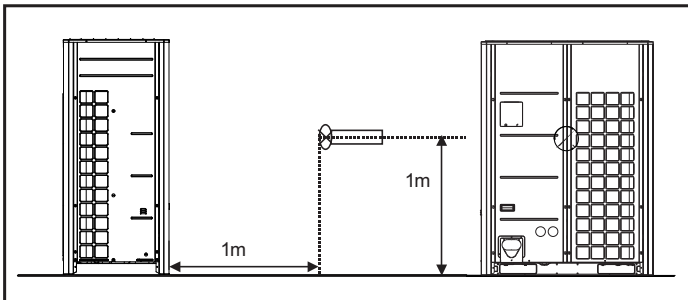
**Note**

- Data is valid at free field condition
- Data is valid at nominal operating condition
- Sound level will vary depending on a range of factors such as the construction (acoustic absorption coefficient) of particular room in which the equipment is installed
- Sound level can be increased in static pressure mode or used air guide.

Unit: dB(A)

Model	Cooling	Heating
ARUM080LTE5	58.0	59.0
ARUM100LTE5	58.0	59.0
ARUM120LTE5	59.0	60.0
ARUM140LTE5	60.0	61.0
ARUM160LTE5	60.5	61.5
ARUM180LTE5	61.0	62.0
ARUM200LTE5	62.0	64.5
ARUM220LTE5	64.5	65.5
ARUM240LTE5	65.0	67.0
ARUM260LTE5	65.0	67.0
ARUM221LTE5	61.5	62.5
ARUM241LTE5	62.0	63.0
ARUM261LTE5	62.5	63.5
ARUM280LTE5	62.8	63.8
ARUM300LTE5	63.1	64.1
ARUM320LTE5	63.8	65.8
ARUM340LTE5	65.6	66.6
ARUM360LTE5	66.0	67.8
ARUM380LTE5	66.2	68.0
ARUM400LTE5	66.3	68.1
ARUM420LTE5	66.5	68.2
ARUM440LTE5	66.8	68.9
ARUM460LTE5	67.8	69.3
ARUM480LTE5	68.0	70.0
ARUM500LTE5	67.0	68.6
ARUM520LTE5	67.1	68.7
ARUM540LTE5	67.2	68.8
ARUM560LTE5	67.4	69.5
ARUM580LTE5	68.3	69.8
ARUM600LTE5	68.5	70.4
ARUM620LTE5	68.6	70.5
ARUM640LTE5	68.7	70.6
ARUM660LTE5	68.8	70.6
ARUM680LTE5	69.0	71.1
ARUM700LTE5	69.6	71.3
ARUM720LTE5	69.8	71.8
ARUM740LTE5	69.1	70.9
ARUM760LTE5	69.2	70.9

# 10. Sound Levels

Model	Cooling	Heating
ARUM780LTE5	69.2	71.0
ARUM800LTE5	69.4	71.4
ARUM820LTE5	70.0	71.6
ARUM840LTE5	70.1	72.1
ARUM860LTE5	70.2	72.1
ARUM880LTE5	70.3	72.2
ARUM900LTE5	70.3	72.2
ARUM920LTE5	70.4	72.5
ARUM940LTE5	70.9	72.7
ARUM960LTE5	71.0	73.0

**ARUM080LTE5**

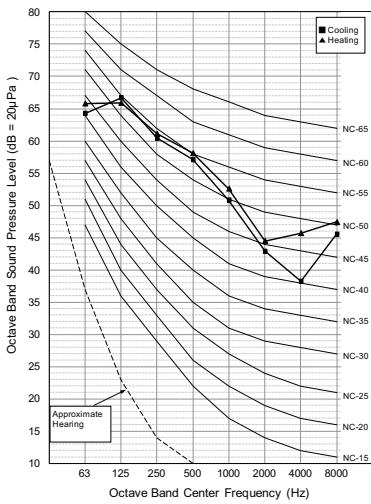

**ARUM100LTE5**

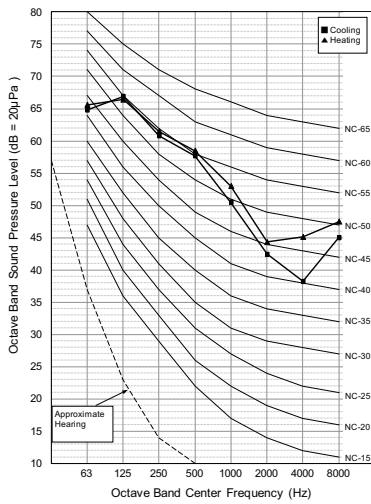

**ARUM120LTE5**

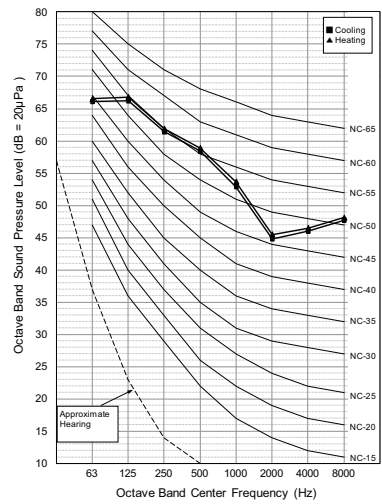

**ARUM140LTE5**

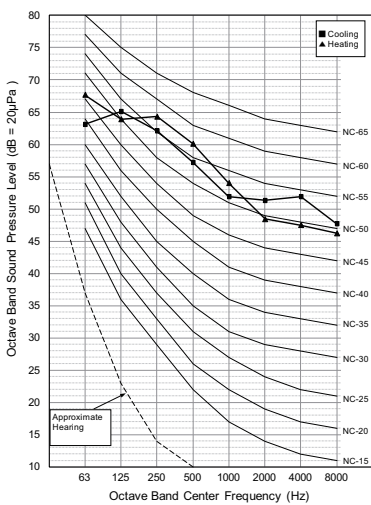

**ARUM160LTE5**

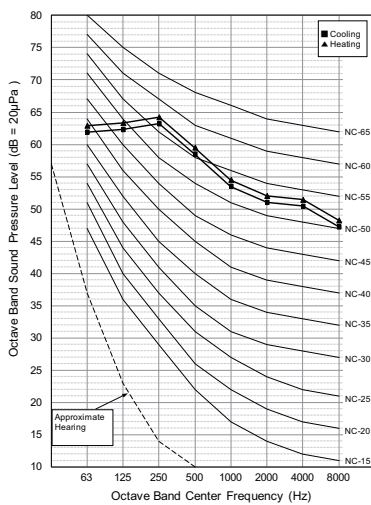

**ARUM180LTE5**

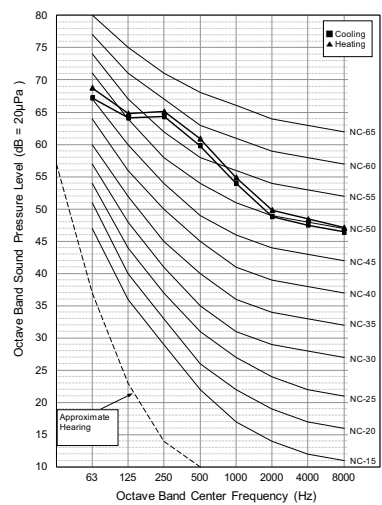

# 10. Sound Levels

**ARUM200LTE5**

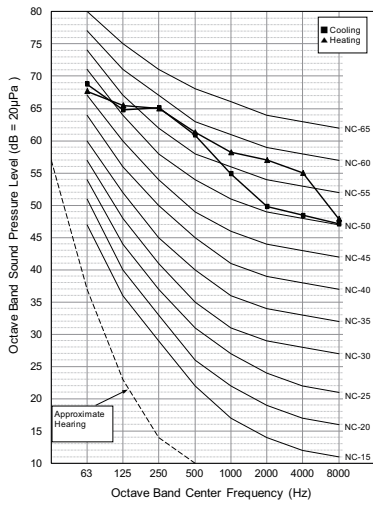

**ARUM220LTE5**

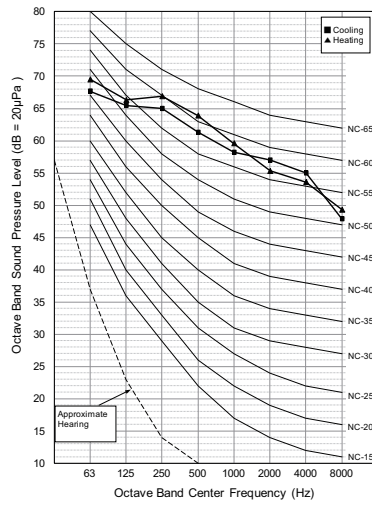

**ARUM240LTE5**

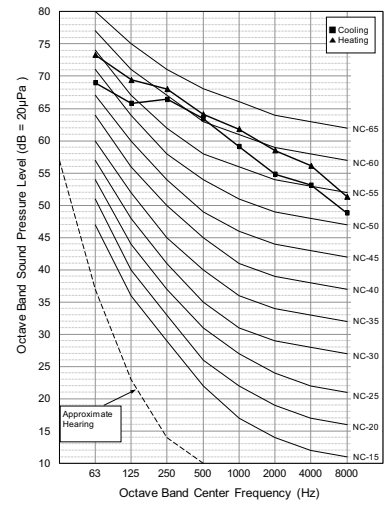

**ARUM260LTE5**

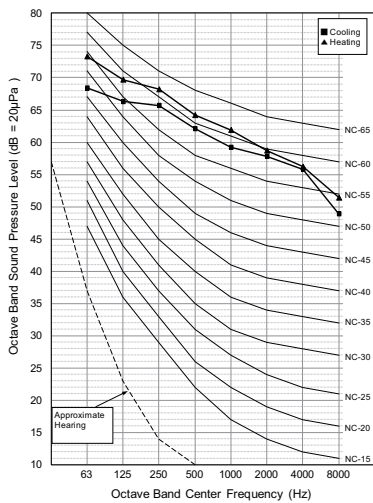

**ARUM221LTE5**

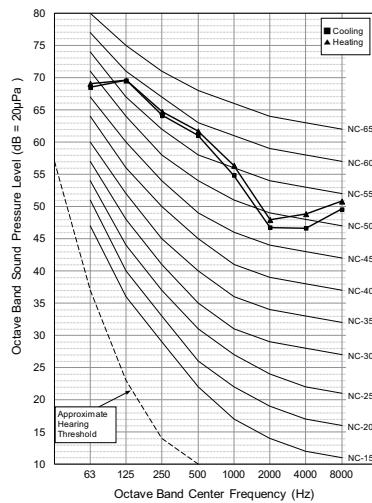

**ARUM241LTE5**

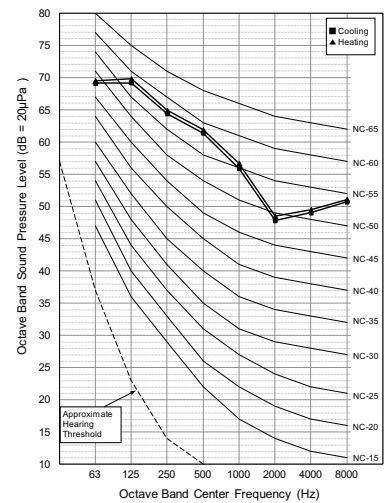

**ARUM261LTE5**

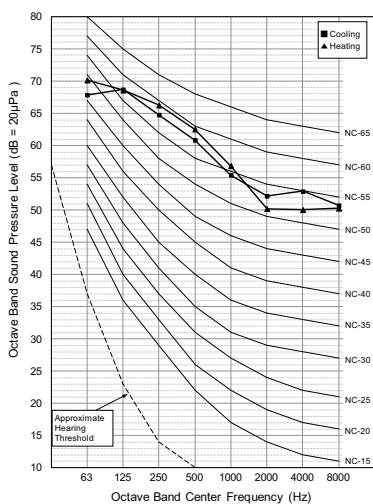

**ARUM280LTE5**

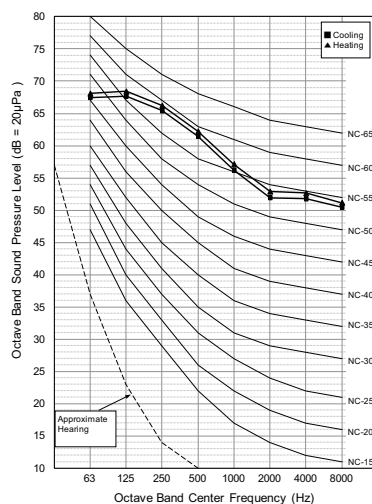

**ARUM300LTE5**

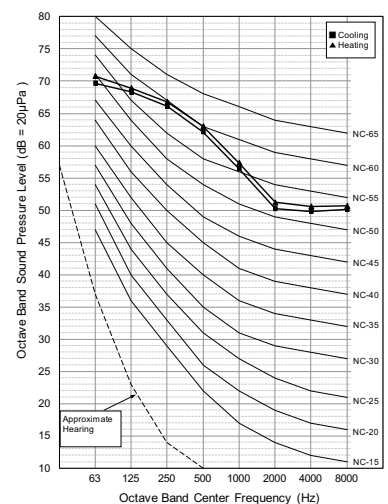

# 10. Sound Levels

**ARUM320LTE5**

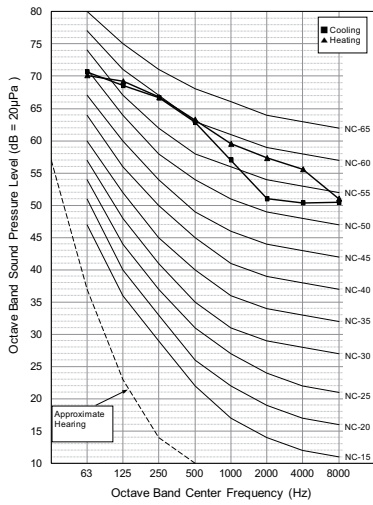

**ARUM340LTE5**

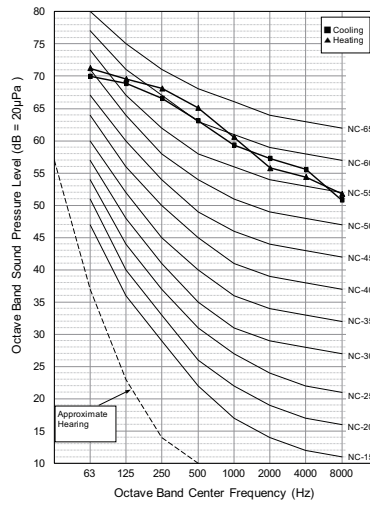

**ARUM360LTE5**

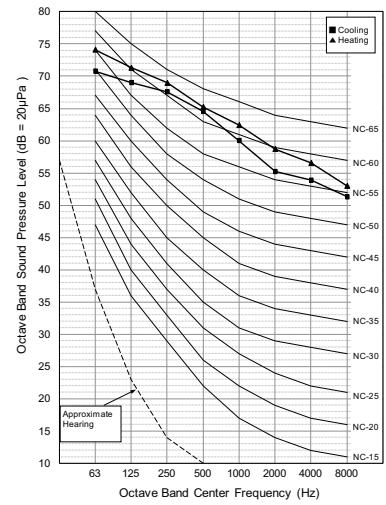

**ARUM380LTE5**

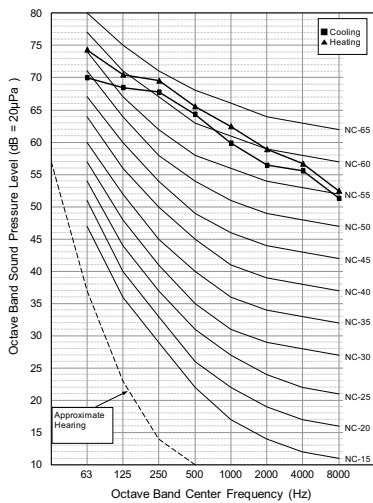

**ARUM400LTE5**

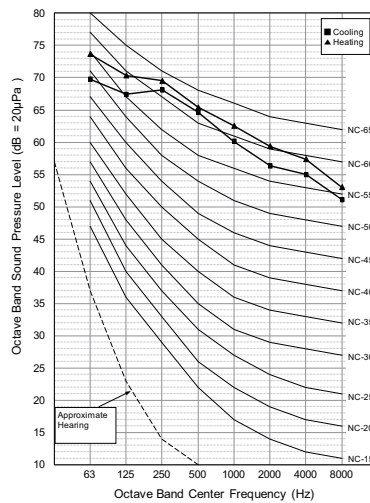

**ARUM420LTE5**

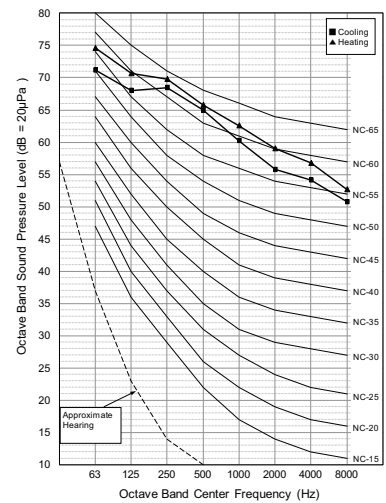

**ARUM440LTE5**

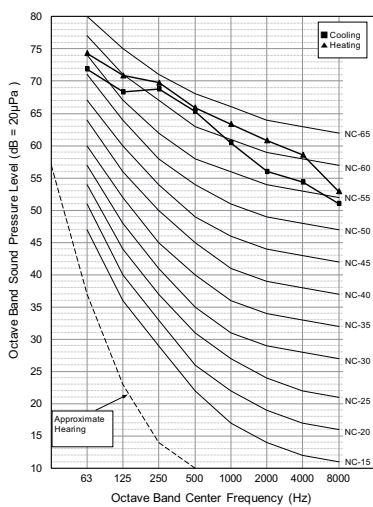

**ARUM460LTE5**

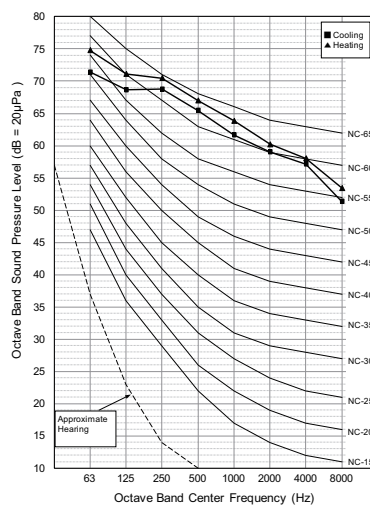

**ARUM480LTE5**

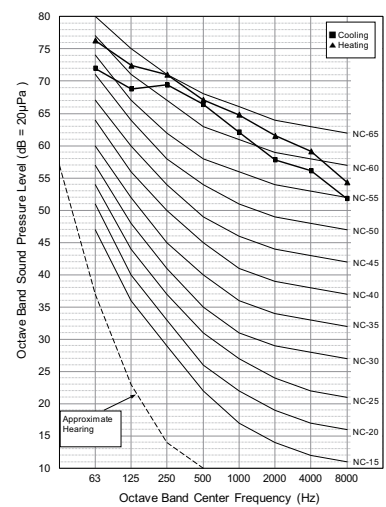



# 10. Sound Levels

### ARUM500LTE5

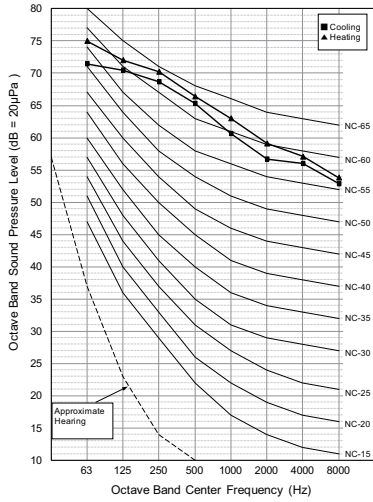

### ARUM520LTE5

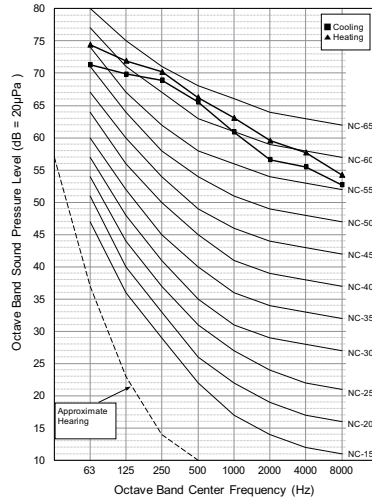

### ARUM540LTE5

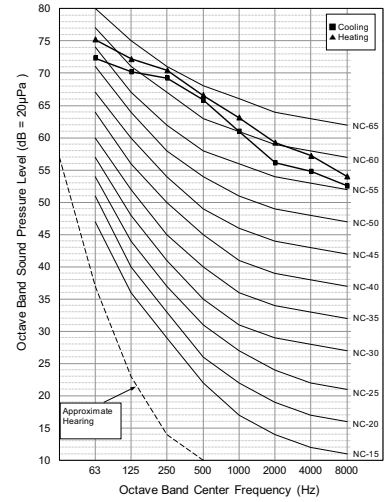

### ARUM560LTE5

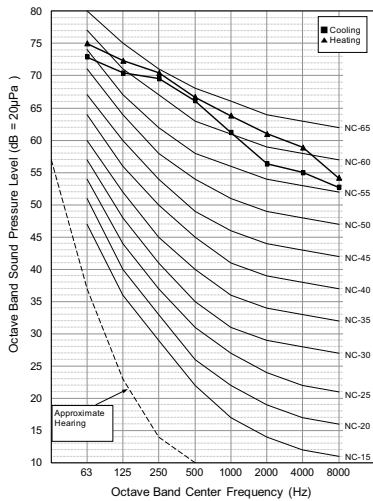

### ARUM580LTE5

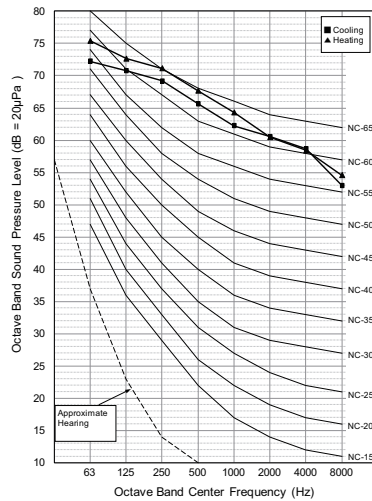

### ARUM600LTE5

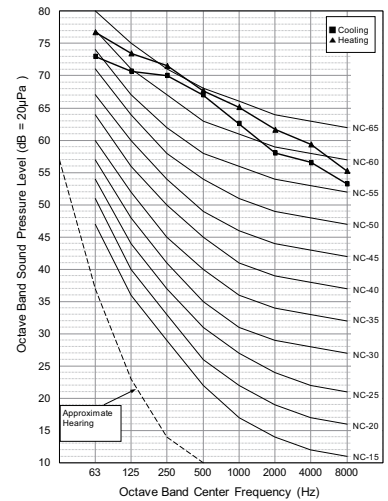

### ARUM620LTE5

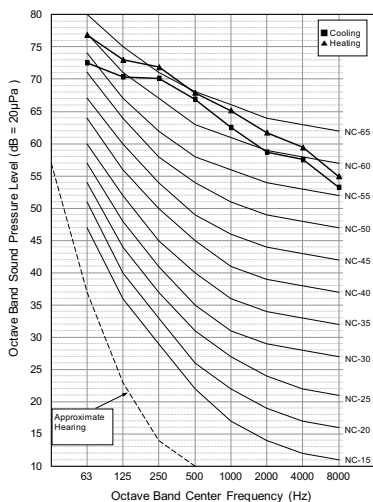

### ARUM640LTE5

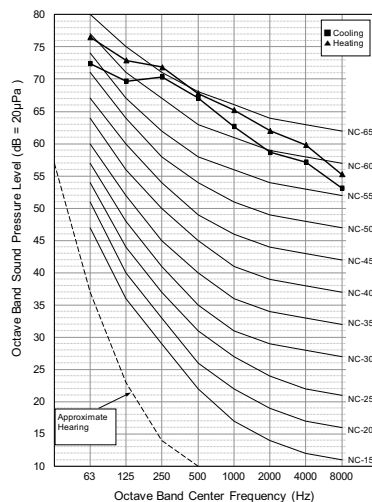

### ARUM660LTE5

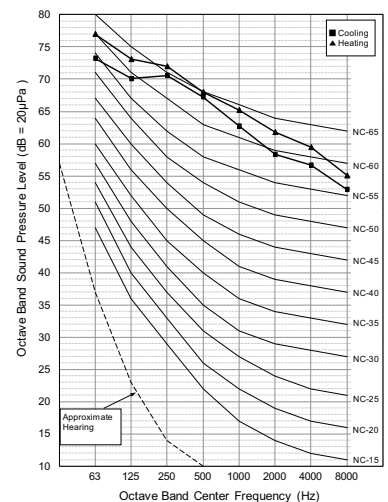

# 10. Sound Levels

### ARUM680LTE5

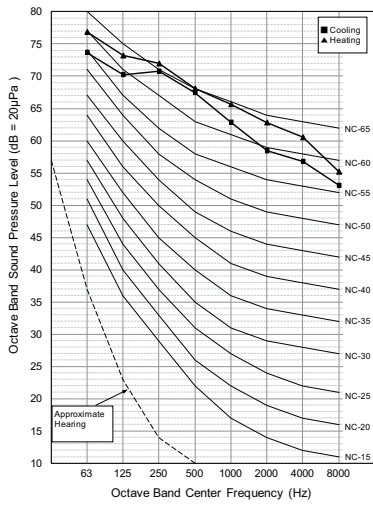

### ARUM700LTE5

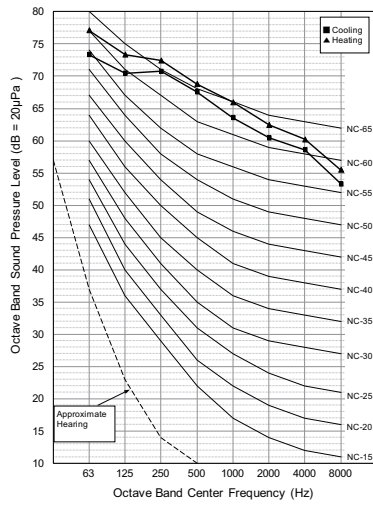

### ARUM720LTE5

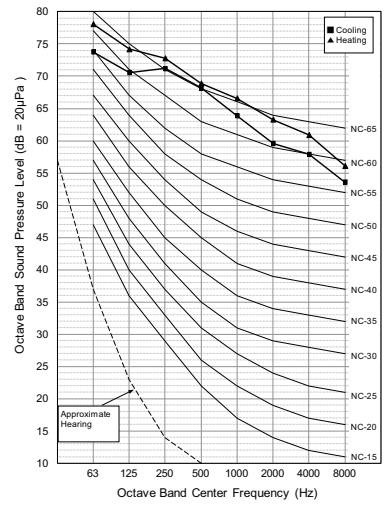

### ARUM740LTE5

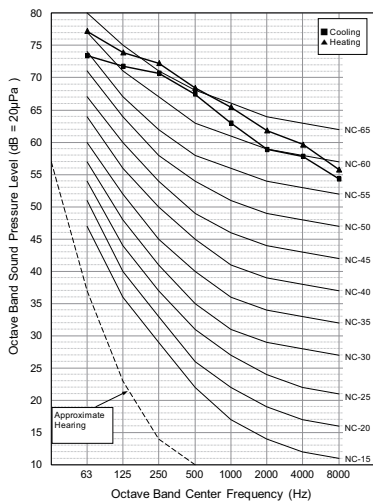

### ARUM760LTE5

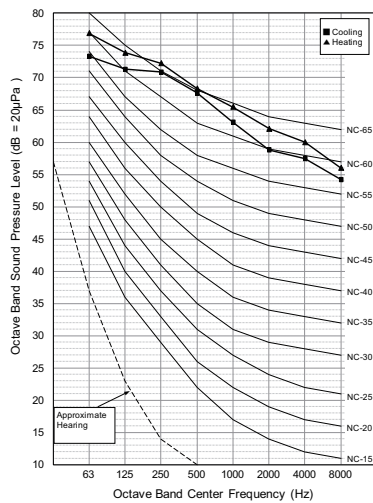

### ARUM780LTE5

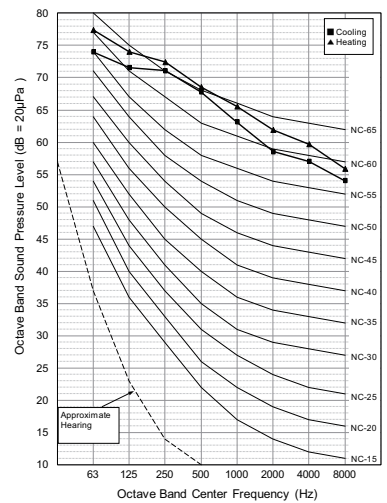

### ARUM800LTE5

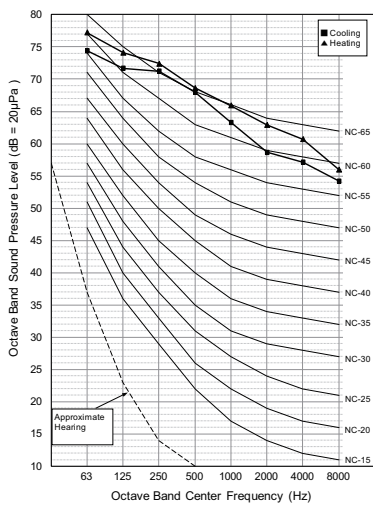

### ARUM820LTE5

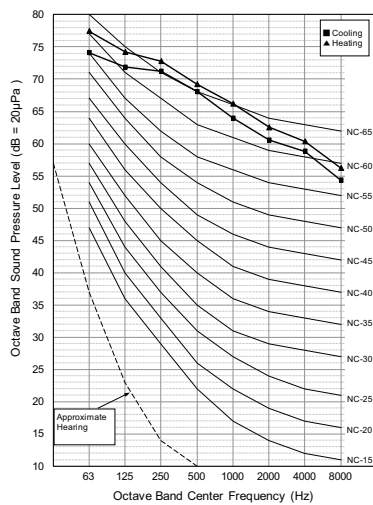

### ARUM840LTE5

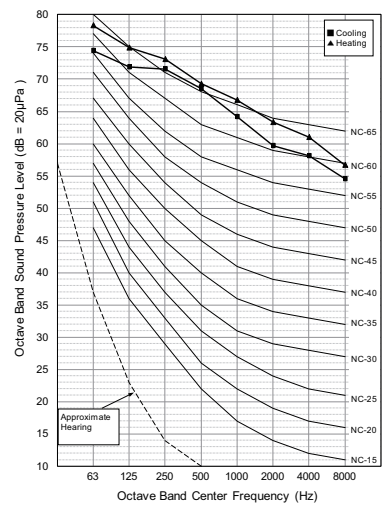

# 10. Sound Levels

### ARUM860LTE5

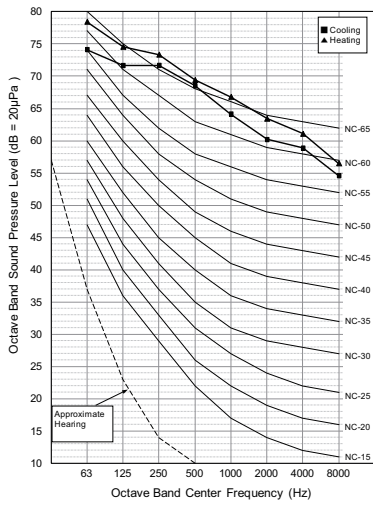

### ARUM880LTE5

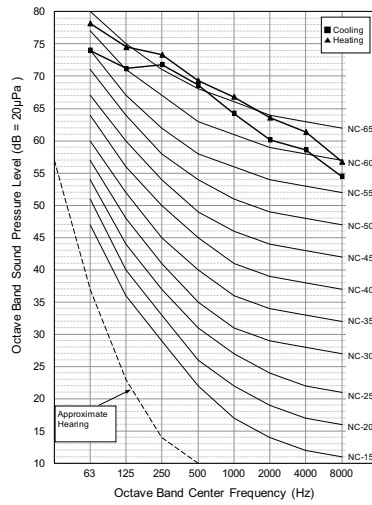

### ARUM900LTE5

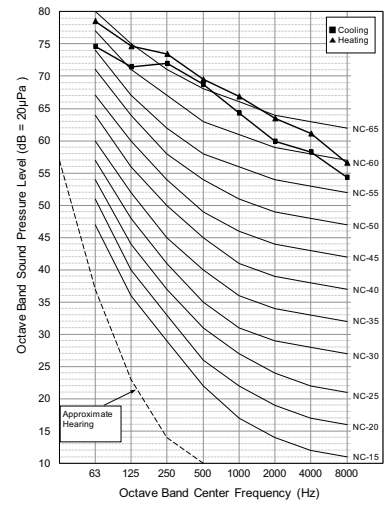

### ARUM920LTE5

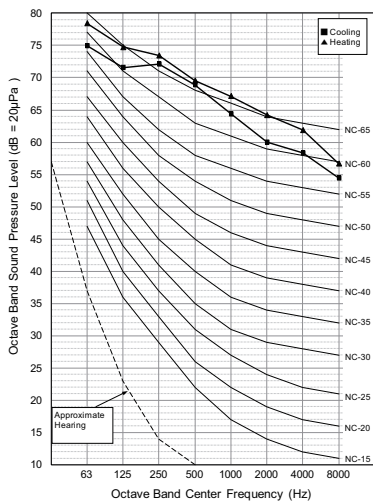

### ARUM940LTE5

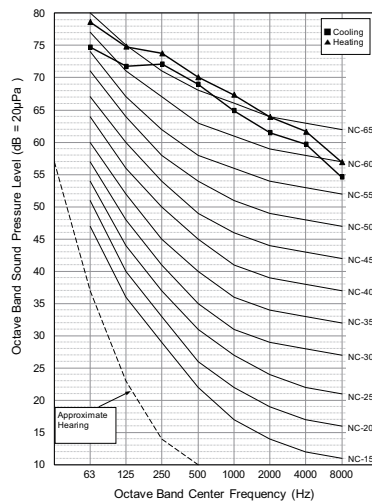

### ARUM960LTE5

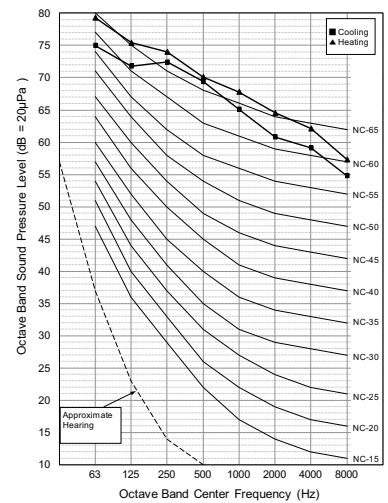

## 10. Sound Levels

### 10.2 Sound Power Levels

#### Note

- Data is valid at diffuse field condition
- Data is valid at nominal operating condition
- Sound level can be increased in static pressure mode or used air guide.
- Sound power level is measured on the rated condition in the reverberation rooms.
- Sound level will vary depending on a range of factors such as the construction(acoustic absorption coefficient) of particular room in which the equipment in installed.
- Reference acoustic intensity 0dB =  $10E-6\mu W/m^2$

Model	Cooling	Heating
ARUM080LTE5	79.0	79.0
ARUM100LTE5	79.0	79.0
ARUM120LTE5	81.0	81.0
ARUM140LTE5	81.0	82.0
ARUM160LTE5	85.0	86.0
ARUM180LTE5	87.0	87.0
ARUM200LTE5	89.0	90.0
ARUM220LTE5	91.0	93.0
ARUM240LTE5	91.0	93.0
ARUM260LTE5	91.0	93.0
ARUM221LTE5	83.1	83.1
ARUM241LTE5	84.0	84.0
ARUM261LTE5	84.0	84.5
ARUM280LTE5	86.5	87.2
ARUM300LTE5	88.0	88.0
ARUM320LTE5	89.6	90.5
ARUM340LTE5	91.4	93.3
ARUM360LTE5	91.4	93.3
ARUM380LTE5	91.4	93.3
ARUM400LTE5	92.0	93.8
ARUM420LTE5	92.5	94.0
ARUM440LTE5	93.1	94.8
ARUM460LTE5	94.0	96.0
ARUM480LTE5	94.0	96.0
ARUM500LTE5	91.8	93.6
ARUM520LTE5	92.3	94.0
ARUM540LTE5	92.8	94.2
ARUM560LTE5	93.4	94.9
ARUM580LTE5	94.2	96.1
ARUM600LTE5	94.2	96.1
ARUM620LTE5	94.2	96.2
ARUM640LTE5	94.5	96.4
ARUM660LTE5	94.8	96.5
ARUM680LTE5	95.2	97.0
ARUM700LTE5	95.8	97.8
ARUM720LTE5	95.8	97.8
ARUM740LTE5	94.4	96.3
ARUM760LTE5	94.7	96.5

# 10. Sound Levels

Model	Cooling	Heating
ARUM780LTE5	95.0	96.6
ARUM800LTE5	95.4	97.1
ARUM820LTE5	95.9	97.9
ARUM840LTE5	95.9	97.9
ARUM860LTE5	95.9	97.9
ARUM880LTE5	96.1	98.1
ARUM900LTE5	96.3	98.1
ARUM920LTE5	96.6	98.4
ARUM940LTE5	97.0	99.0
ARUM960LTE5	97.0	99.0

**ARUM080LTE5**

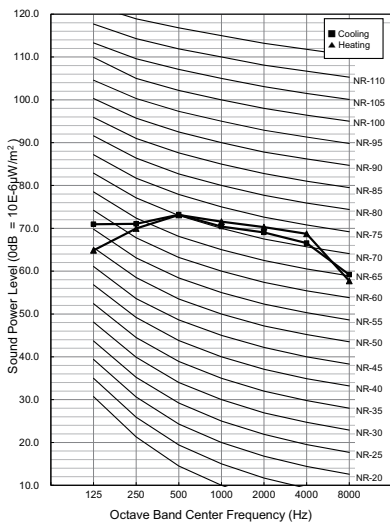

**ARUM100LTE5**

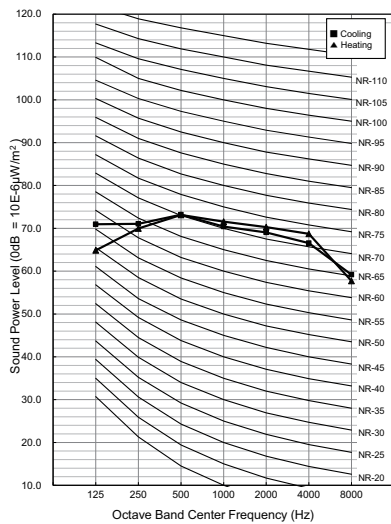

**ARUM120LTE5**

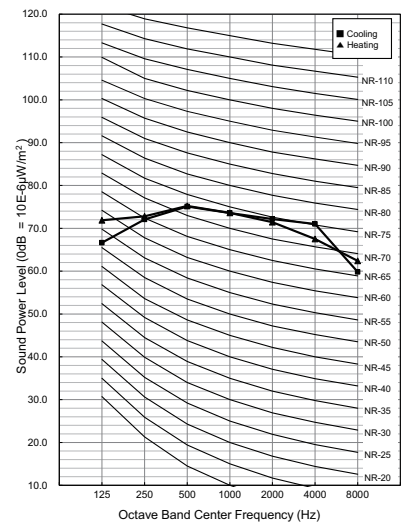

**ARUM140LTE5**

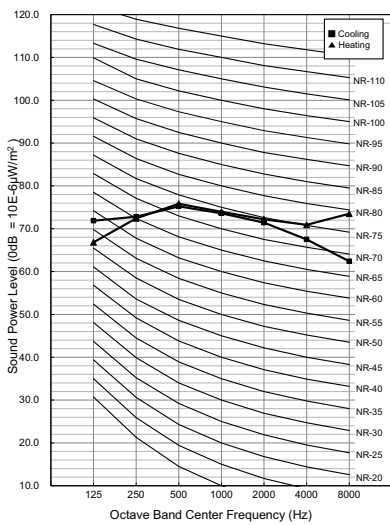

**ARUM160LTE5**

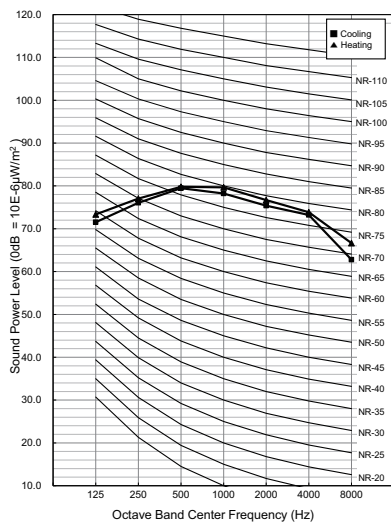

**ARUM180LTE5**

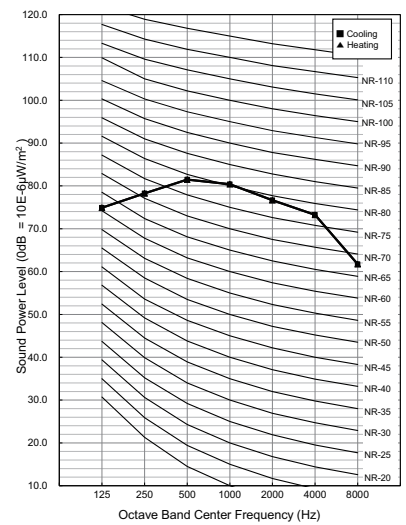

# 10. Sound Levels

**ARUM200LTE5**

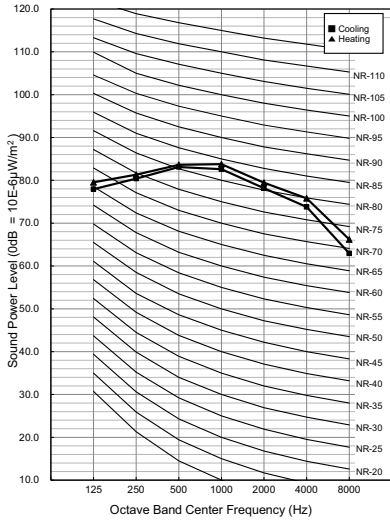

**ARUM220LTE5**

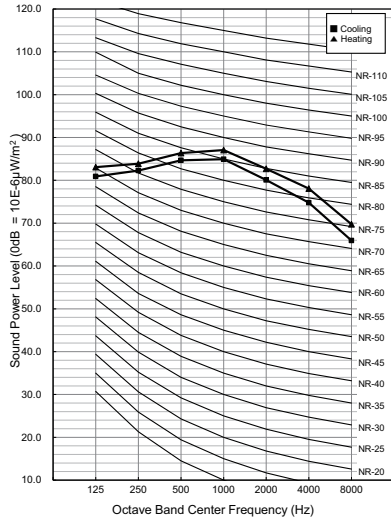

**ARUM240LTE5**

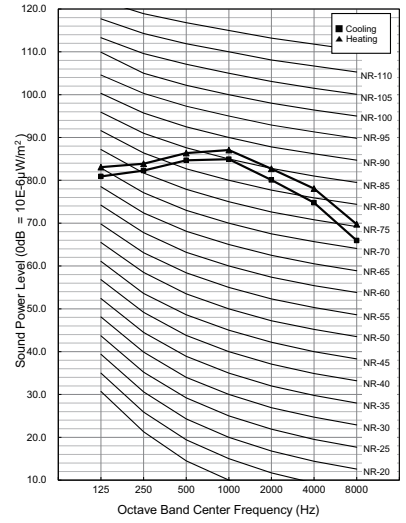

**ARUM260LTE5**

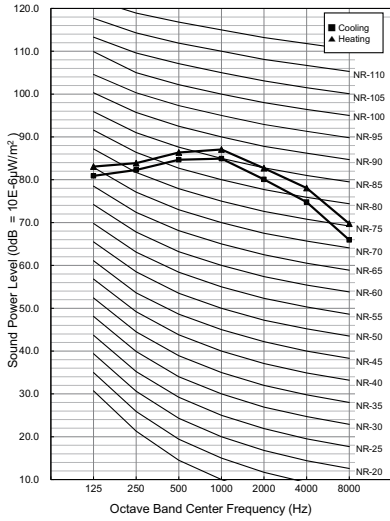

**ARUM221LTE5**

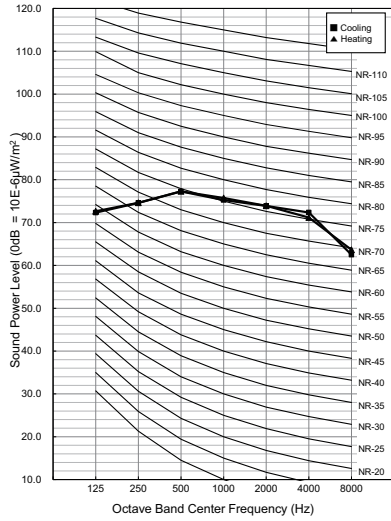

**ARUM241LTE5**

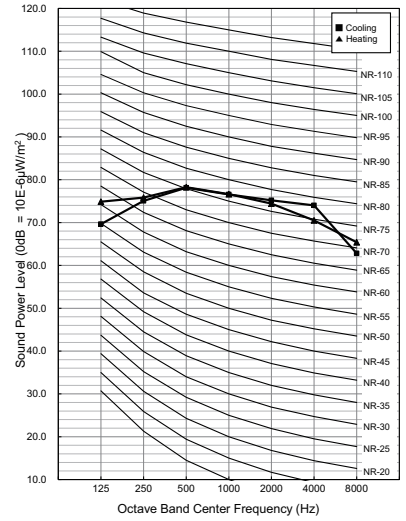

**ARUM261LTE5**

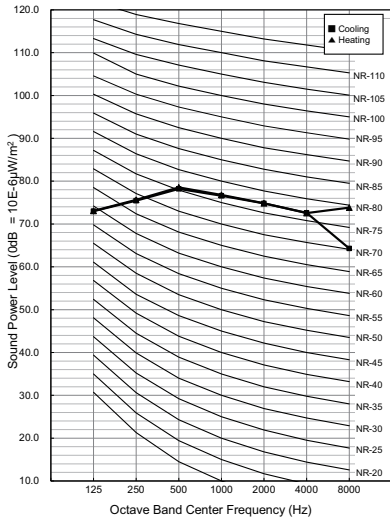

**ARUM280LTE5**

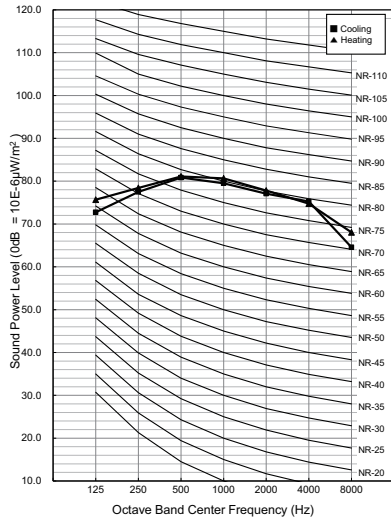

**ARUM300LTE5**

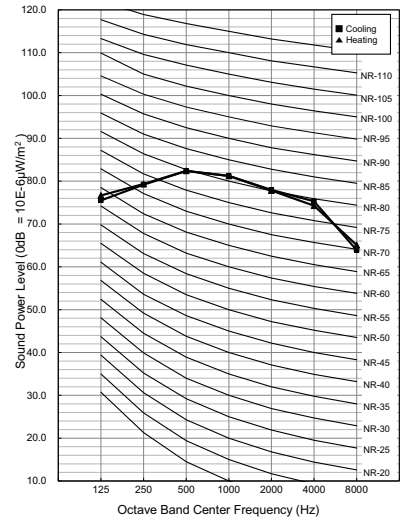

# 10. Sound Levels

**ARUM320LTE5**

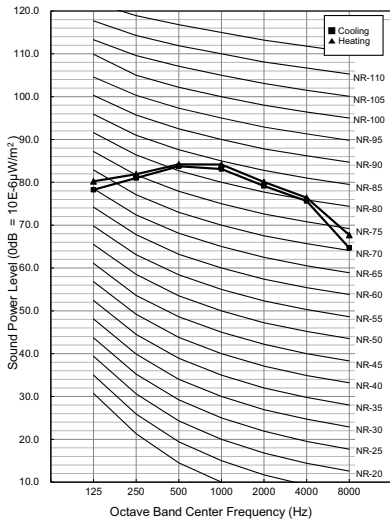

**ARUM340LTE5**

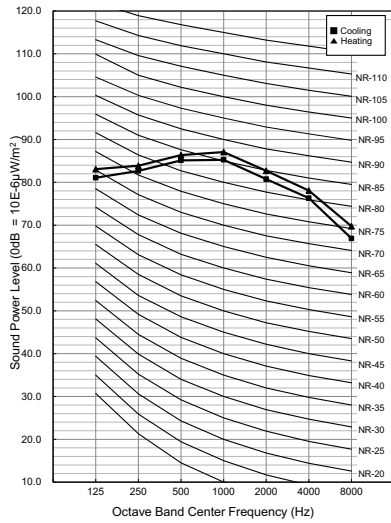

**ARUM360LTE5**

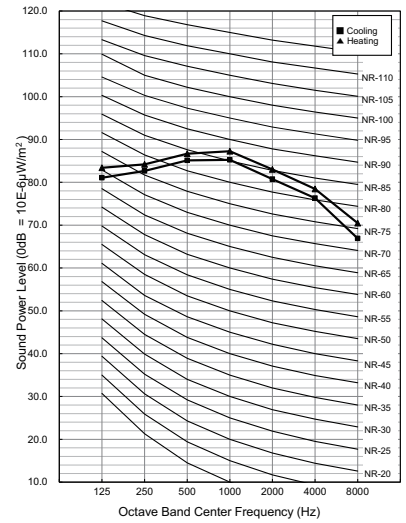

**ARUM380LTE5**

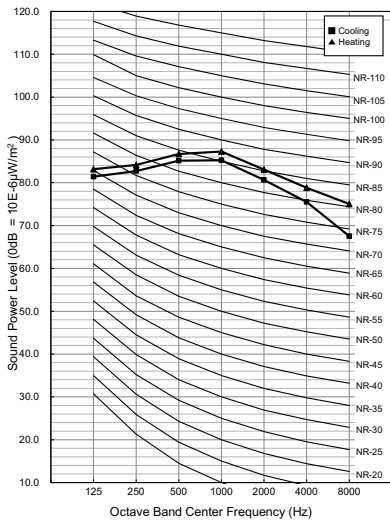

**ARUM400LTE5**

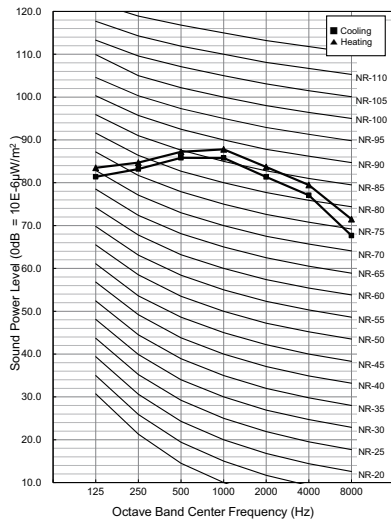

**ARUM420LTE5**

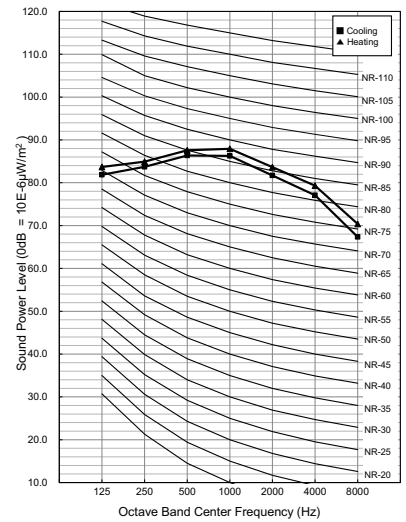

**ARUM440LTE5**

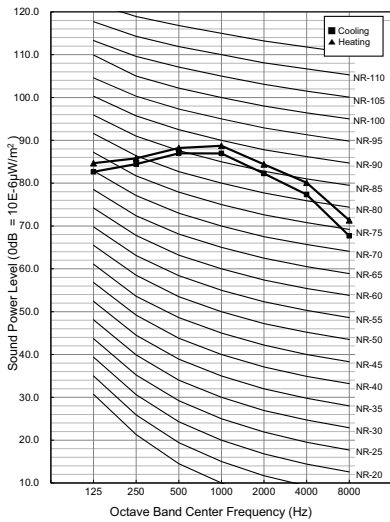

**ARUM460LTE5**

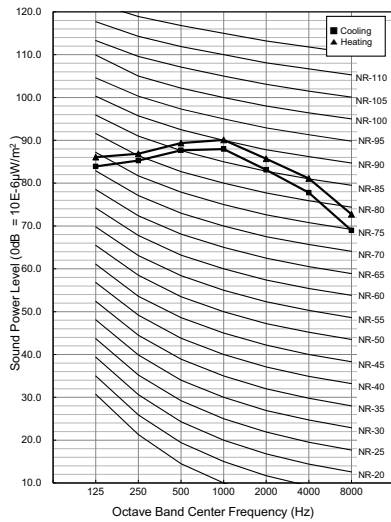

**ARUM480LTE5**

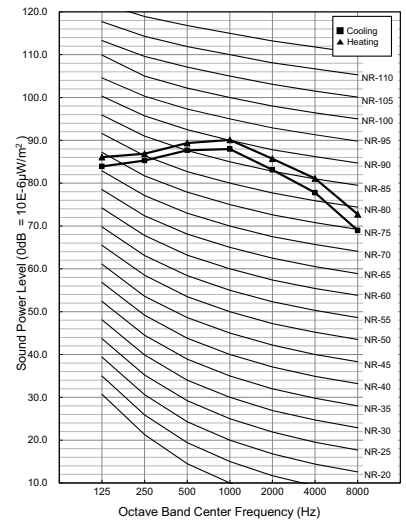

# 10. Sound Levels

**ARUM500LTE5**

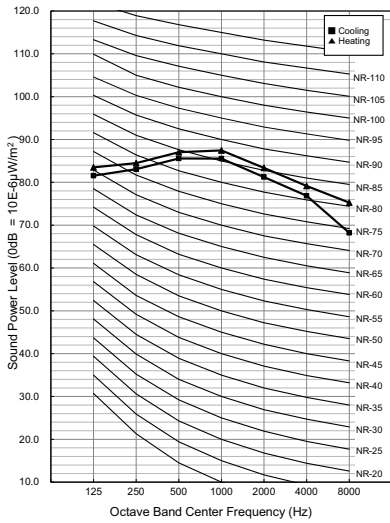

**ARUM520LTE5**

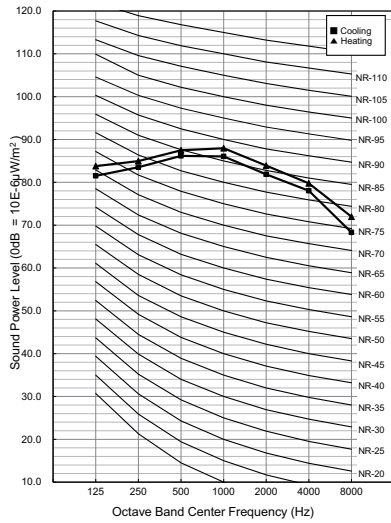

**ARUM540LTE5**

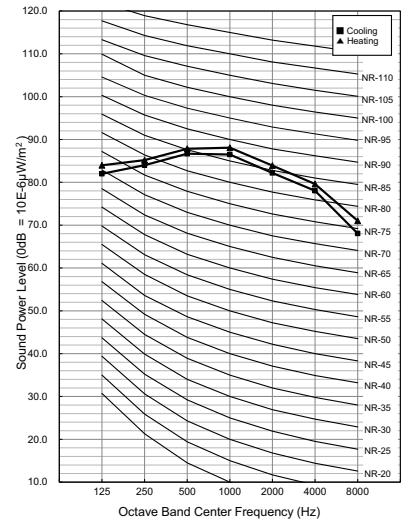

**ARUM560LTE5**

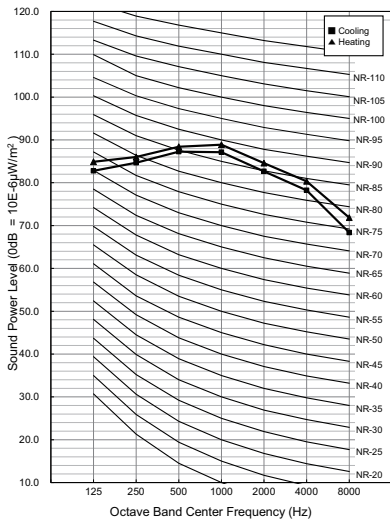

**ARUM580LTE5**

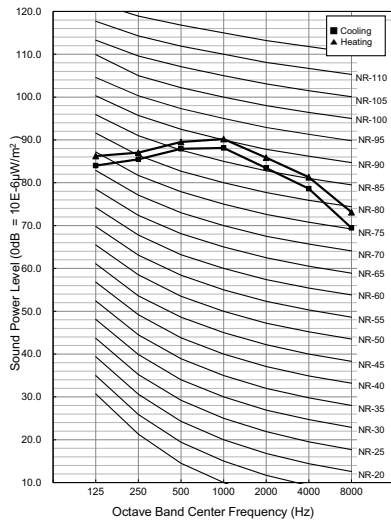

**ARUM600LTE5**

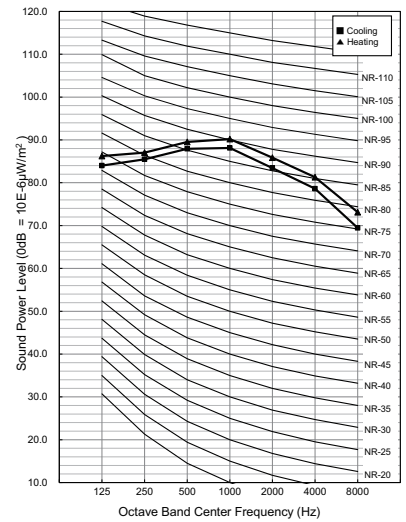

**ARUM620LTE5**

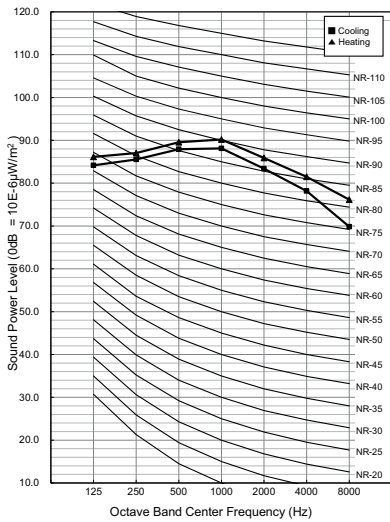

**ARUM640LTE5**

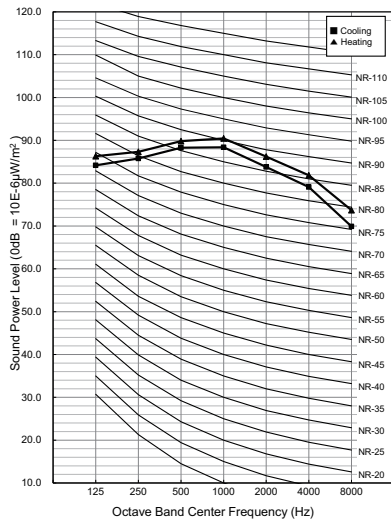

**ARUM660LTE5**

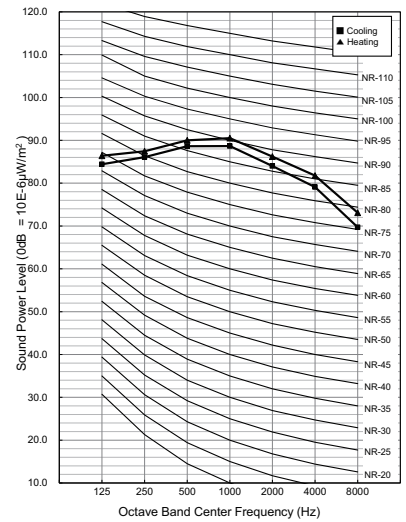



# 10. Sound Levels

**ARUM680LTE5**

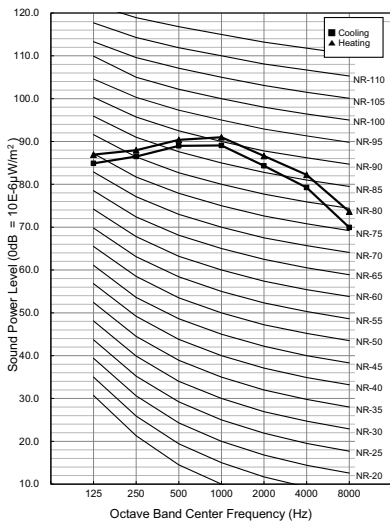

**ARUM700LTE5**

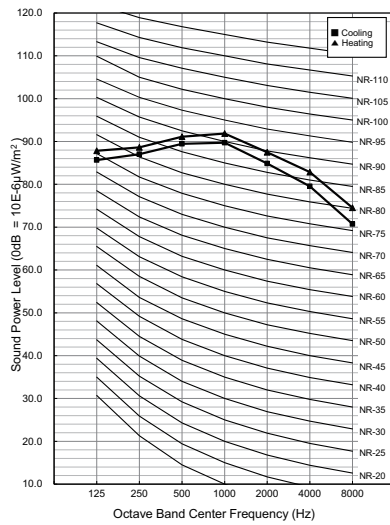

**ARUM720LTE5**

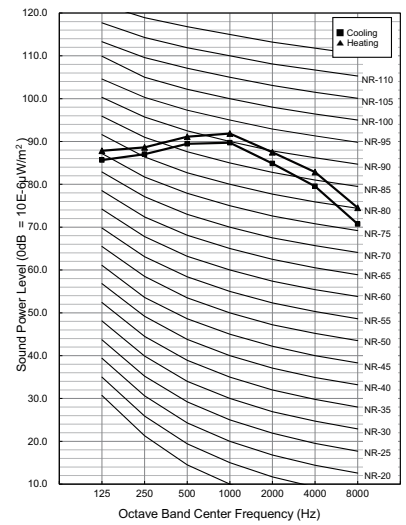

**ARUM740LTE5**

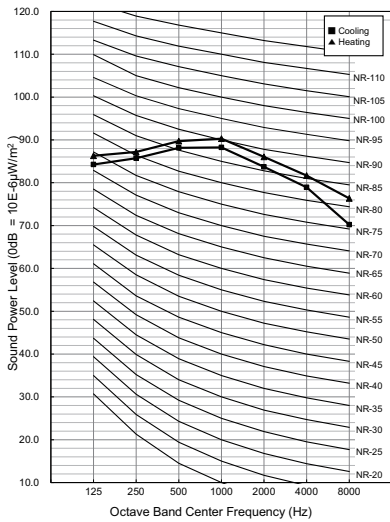

**ARUM760LTE5**

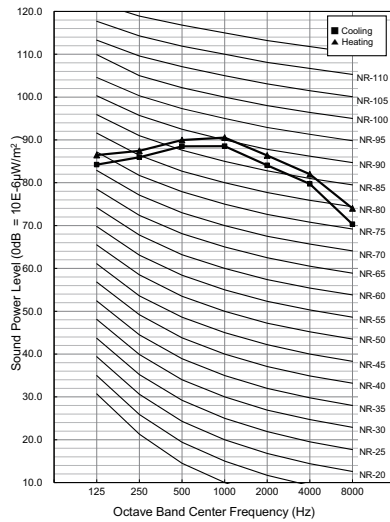

**ARUM780LTE5**

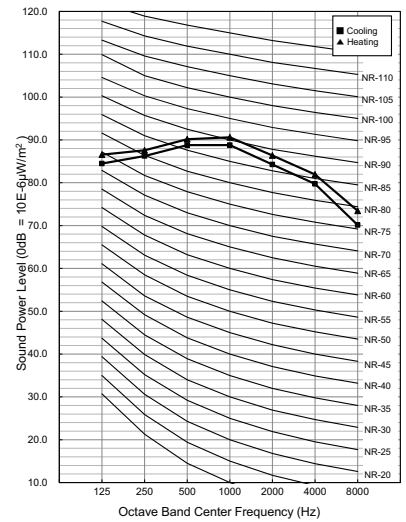

**ARUM800LTE5**

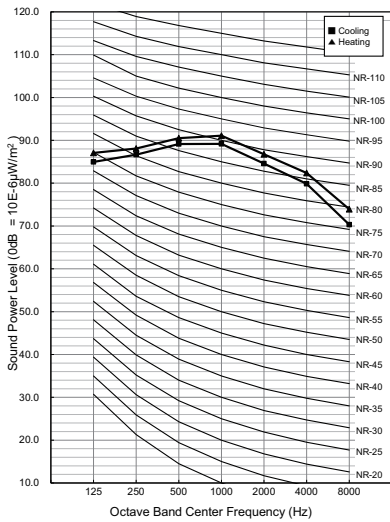

**ARUM820LTE5**

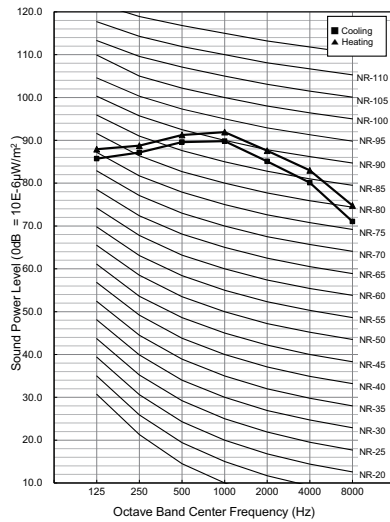

**ARUM840LTE5**

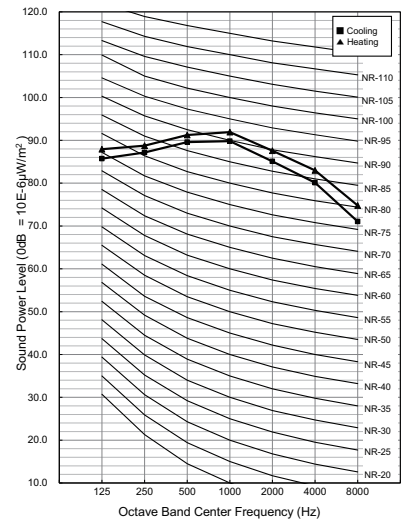

# 10. Sound Levels

**ARUM860LTE5**

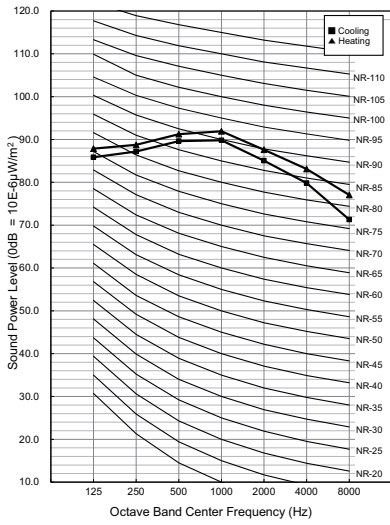

**ARUM880LTE5**

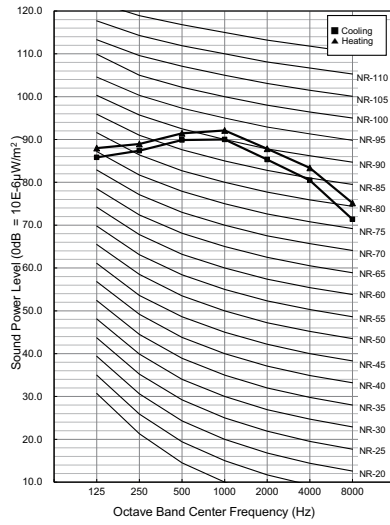

**ARUM900LTE5**

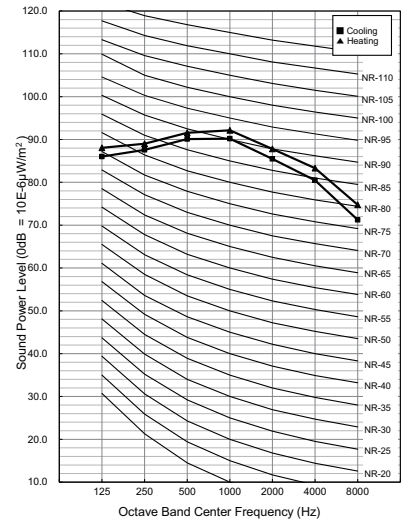

**ARUM920LTE5**

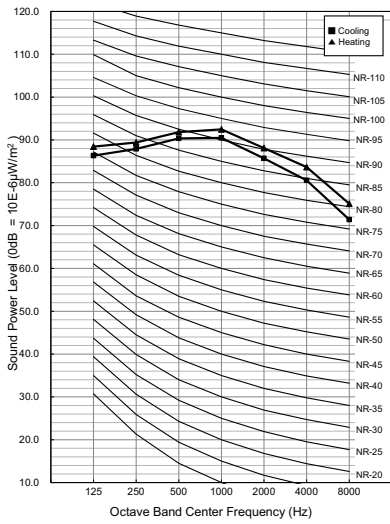

**ARUM940LTE5**

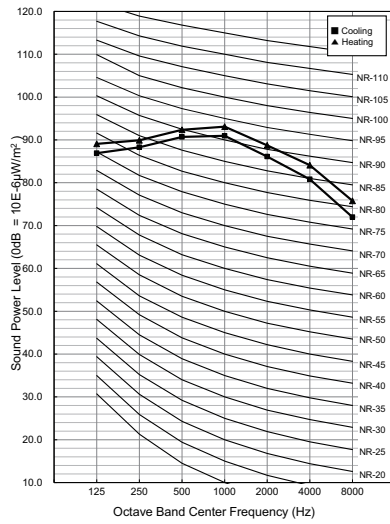

**ARUM960LTE5**

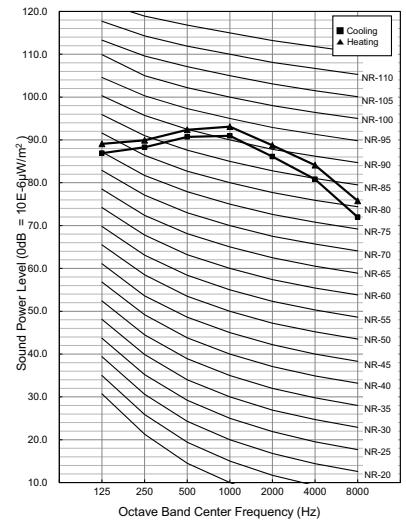

## 11. Accessories

### ■ Optional Accessories

No.	Name	Model
1	Y branch pipe	ARBLN01621 / ARBLB01621
		ARBLN03321 / ARBLB03321
		ARBLN07121 / ARBLB07121
		ARBLN14521 / ARBLB14521
		ARBLN23220 / ARBLB23220
2	Header	ARBL054
		ARBL057
		ARBL104
		ARBL107
		ARBL1010
		ARBL2010
3	Connection pipe of Outdoor Units	ARCNB21
		ARCNB31
		ARCNB41

# **MULTI V<sup>TM</sup> 5**

Heat Recovery

## **HR Unit**

- 1.Nomenclature**
- 2.Specifications**
- 3.Dimensions**
- 4.Prats Function**
- 5.Piping Diagrams**
- 6.Wiring Diagrams**
- 7.Sound Levels**

# 1. Nomenclature

<b>Model Name</b>	<b>PRHR</b>	<b>04</b>	<b>3</b>
No.	1	2	3

No.	Signification
1	<b>HR Unit connecting to Multi V Heat Recovery System Outdoor Unit using R410A</b> PRHR : Global line-up
2	<b>The No. of connected branches</b> 02 : For 2 branches 03 : For 3 branches 04 : For 4 branches 06 : For 6 branches 08 : For 8 branches
3	<b>Serial Number</b>

## 2. Specifications

Model		PRHR023	PRHR033	PRHR043	
Max. Connectable No. of Indoor Units		16	24	32	
Max. Connectable No. of Indoor Units of a branch		8	8	8	
Nominal Input	Cooling(W)	39.8	39.8	39.8	
	Heating(W)	37.2	37.2	37.2	
Net. Weight	kg	16.0	17.8	19.3	
	lbs	35.3	39.2	42.5	
Dimensions (WxHxD)	mm	786 x 218 x 657			
	Inch	30-15/16 x 8-19/32 x 25-7/8			
Casing		Galvanized steel plate			
Connecting Pipes	Indoor side	Liquid Pipe [mm/inch]	Ø9.52[3/8] ~ Ø6.35[1/4]		
		Gas Pipe [mm/inch]	Ø15.88[5/8] ~ Ø12.7[1/2]		
	Outdoor side	Liquid [mm/inch]	Ø9.52[3/8]	Ø12.7[1/2]	Ø15.88[5/8]
		Low Pressure [mm/inch]	Ø22.2[7/8]	Ø28.58[1-1/8]	Ø28.58[1-1/8]
		High Pressure [mm/inch]	Ø19.05[3/4]	Ø22.2[7/8]	Ø22.2[7/8]
Sound Absorbing Insulation Material		Polyethylene Foam			
Current	Minimum circuit Amps(MCA)	0.17			
Power Supply		1Ø, 220-240V, 50Hz / 1Ø, 220V, 60Hz			

### Note

1. Voltage range : Voltage supplied to the unit terminals should be within the minimum and maximum range.
2. MCA/MFA  
MCA=1.25 x FLA  
MFA = 1.1 x MCA, MFA ≤ 4 x FLA  
(If MFA is smaller than minimum standard value, Use minimum standard value in region for selecting circuit breaker.)
3. Next lower standard fuse rating. Minimum 15A.
4. Select wire size based on the MCA.
5. MFA is used to select the circuit breaker and ground fault circuit interrupter, and all installation site must require attachment of an earth leakage breaker. [circuit breaker type is ELCB(Earth Leakage Circuit Breaker)].

## 2. Specifications

Model		PRHR063	PRHR083	
Max. Connectable No. of Indoor Units		48	64	
Max. Connectable No. of Indoor Units of a branch		8	8	
Nominal Input	Cooling(W)	75.9	75.9	
	Heating(W)	72.1	72.1	
Net. Weight	kg	27.2	30.7	
	lbs	60.0	67.7	
Dimensions (WxHxD)	mm	1,113 x 218 x 657		
	Inch	43-13/16 x 8-19/32 x 25-7/8		
Casing		Galvanized steel plate		
Connecting Pipes	Indoor side	Liquid Pipe [mm/inch]	Ø9.52[3/8] ~ Ø6.35[1/4]	
		Gas Pipe [mm/inch]	Ø15.88[5/8] ~ Ø12.7[1/2]	
	Outdoor side	Liquid [mm/inch]	Ø15.88[5/8]	Ø15.88[5/8]
		Low Pressure [mm/inch]	Ø28.58[1-1/8]	Ø28.58[1-1/8]
		High Pressure [mm/inch]	Ø22.2[7/8]	Ø22.2[7/8]
	Sound Absorbing Insulation Material		Polyethylene Foam	
Current	Minimum circuit Amps(MCA)	0.27		
Power Supply		1Ø, 220-240V, 50Hz / 1Ø, 220V, 60Hz		

### Note

1. Voltage range : Voltage supplied to the unit terminals should be within the minimum and maximum range.
2. Maximum allowable voltage unbalance between phases is 2%.
3. MCA/MFA  
 $MCA = 1.25 \times FLA$   
 $MFA = 1.1 \times MCA, MFA \leq 4 \times FLA$   
 (If MFA is smaller than minimum standard value, Use minimum standard value in region for selecting circuit breaker.)
4. Select wire size based on the MCA.
5. MFA is used to select the circuit breaker and ground fault circuit interrupter, and all installation site must require attachment of an earth leakage breaker. [circuit breaker type is ELCB(Earth Leakage Circuit Breaker)].

### 3. Dimensions

#### PRHR023 / PRHR033 / PRHR043

[Unit: mm]

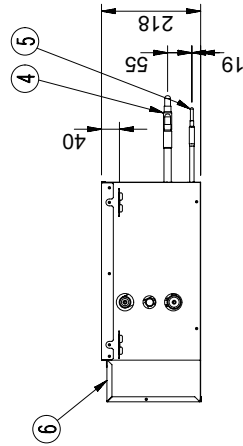
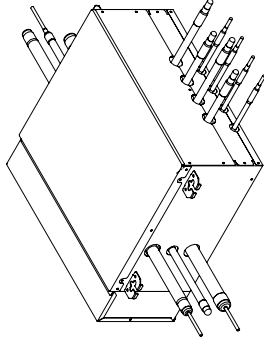
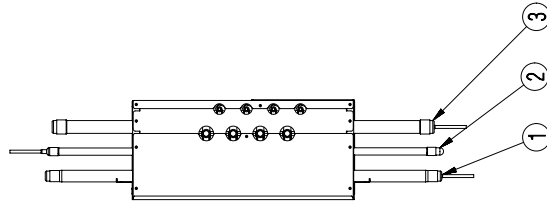
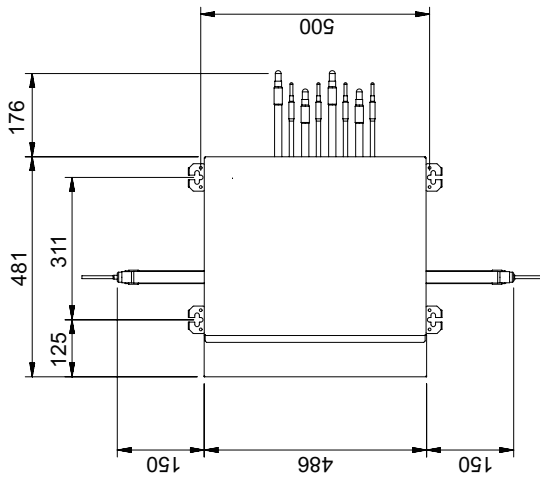

**Note**

1. Unit should be installed in compliance with the installation manual in the product box.
2. Unit should be grounded in accordance with the local regulations or applicable national codes.
3. All electrical components and materials to be supplied from the site must comply with the local regulations or international codes.

6	Control box	-
5	Liquid pipe to Indoor unit	8- Ø 9.52 - Ø 6.35
4	Gas pipe to Indoor unit	8- Ø 15.88 - Ø 12.7
3	Low pressure gas pipe	2- Ø 28.58
2	Liquid pipe to Outdoor unit	2- Ø 15.88
1	High pressure gas pipe	2- Ø 22.2
No.	Part Name	Description



# 3. Dimensions

## PRHR063 / PRHR083

[Unit: mm]

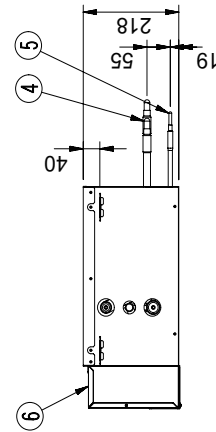
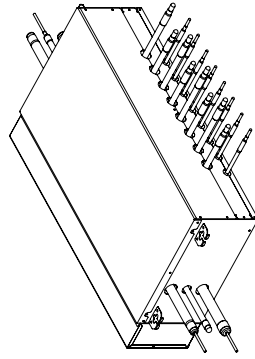
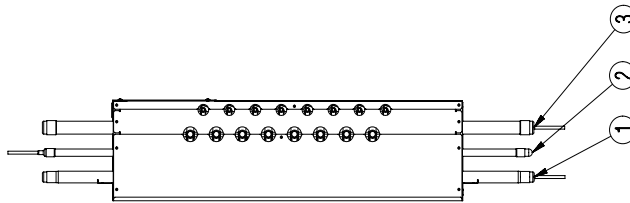
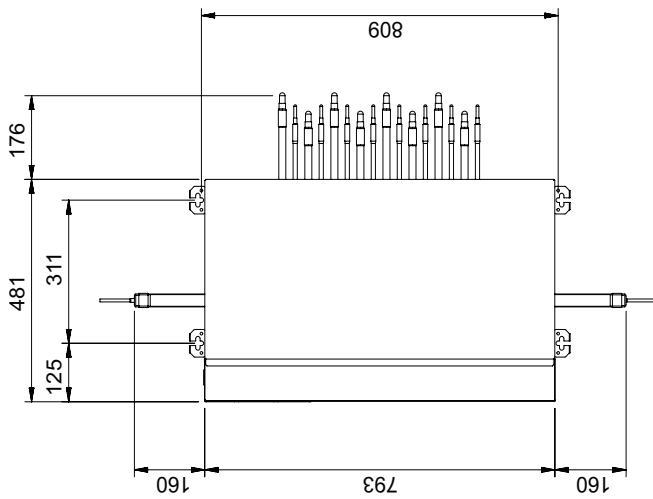

**Note**

1. Unit should be installed in compliance with the installation manual in the product box.
2. Unit should be grounded in accordance with the local regulations or applicable national codes.
3. All electrical components and materials to be supplied from the site must comply with the local regulations or international codes.

6	Control box	-
5	Liquid pipe to Indoor unit	8- $\varnothing$ 9.52 - $\varnothing$ 6.35
4	Gas pipe to Indoor unit	8- $\varnothing$ 15.88 - $\varnothing$ 12.7
3	Low pressure gas pipe	2- $\varnothing$ 28.58
2	Liquid pipe to Outdoor unit	2- $\varnothing$ 15.88
1	High pressure gas pipe	2- $\varnothing$ 22.2
No.	Part Name	Description

## 4. Parts Function

Parts Name	Symbol	Major Function
Low pressure gas pipe	LPGV	Pipe for Low pressure gas
High pressure gas pipe	HPGV	Pipe for High pressure gas
Liquid pipe 1	LP1	Liquid pipe connected with outdoor unit
Liquid bypass valve	LBV	Prevent Liquid charging
Solenoid Assembly 1, 2	SOL1, 2	Control the path for heating or cooling
Liquid pipe 2	LP2	Liquid pipe connected with indoor unit
Gas pipe	GSP	Gas pipe connected with indoor unit
Balancing valve	BLV	Control the pressure between High and Low pressure pipe during operation switching
Subcooling EEV	SCEEV	Control the subcooling

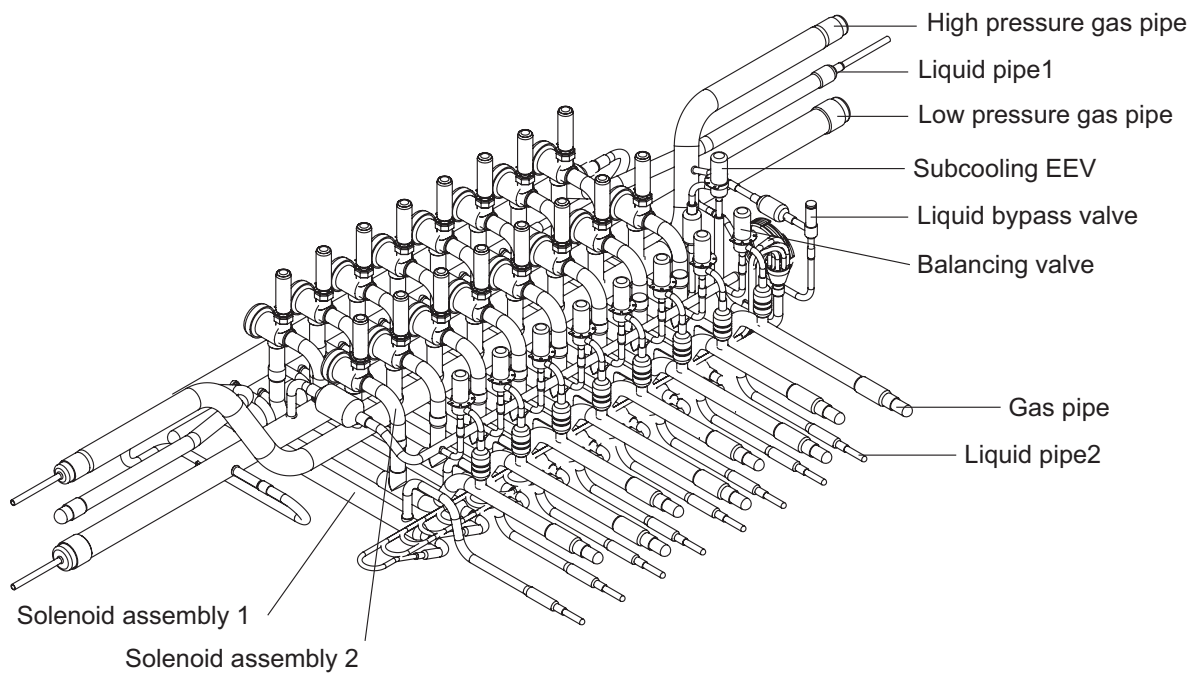

## 5. Piping Diagrams

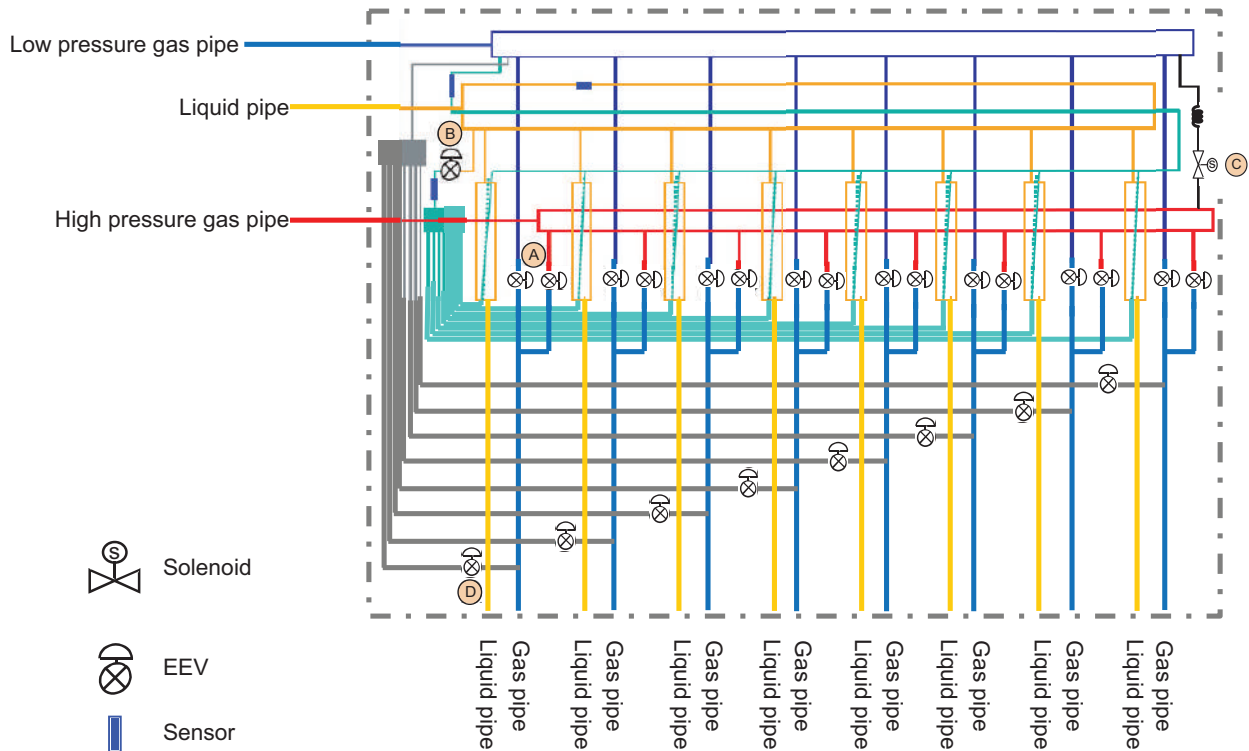

- A : To be switched operation between cooling and heating by two valves
- B : To be used decreasing noise according to sub-cooling of inlet of indoor unit and outlet of indoor unit (Simultaneous operation)
- C : To prevent liquid charging between H/P gas valve and HR unit at cooling mode
- D : To be controlled the pressure between High and Low pressure pipe during operation switching

# 6. Wiring Diagrams

## PRHR023, PRHR033, PRHR043

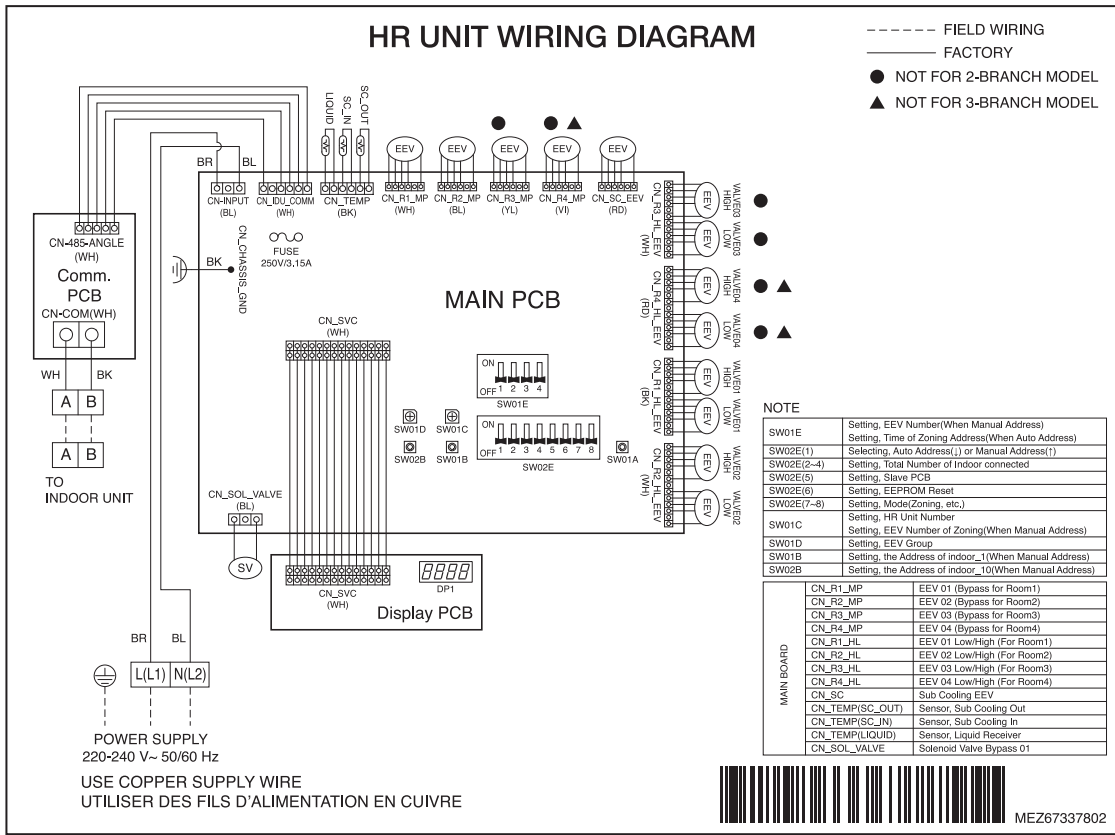

CONNECTOR NUMBER	FUNCTION
CN_R1_MP	EEV 01 (Bypass for Room1)
CN_R2_MP	EEV 02 (Bypass for Room2)
CN_R3_MP	EEV 03 (Bypass for Room3)
CN_R4_MP	EEV 04 (Bypass for Room4)
CN_R1_HL	EEV 01 Low/High (For Room1)
CN_R2_HL	EEV 02 Low/High (For Room2)
CN_R3_HL	EEV 03 Low/High (For Room3)
CN_R4_HL	EEV 04 Low/High (For Room4)
CN_SC	Sub Cooling LEV
CN_TEMP(SC_OUT)	Sensor, Sub Cooling Out
CN_TEMP(SC_IN)	Sensor, Sub Cooling In
CN_TEMP(LIQUID)	Sensor, Liquid Receiver
CN_SOL_VALVE	Solenoid Valve Bypass 01
SW01E	Setting, EEV Number (When Manual Address) Setting, Time of Zoning Address (When Auto Address)
SW02E(1)	Selecting, Auto Address (↓) or manual Address (↑)
SW02E(2~4)	Setting, Total Number of Indoor connected
SW02E(5)	Setting, Slave PCB
SW02E(6)	Setting, EEPROM Reset
SW02E(7~8)	Setting, Mode (Zoning, etc.)
SW01C	Setting, HR Unit Number Setting, EEV Number of Zoning (When Manual Address)
SW01D	Setting, EEV Group
SW01B	Setting, the Address of indoor_1 (When Manual Address)
SW02B	Setting, the Address of indoor_10 (When manual Address)

# 6. Wiring Diagrams

## PRHR063, PRHR083

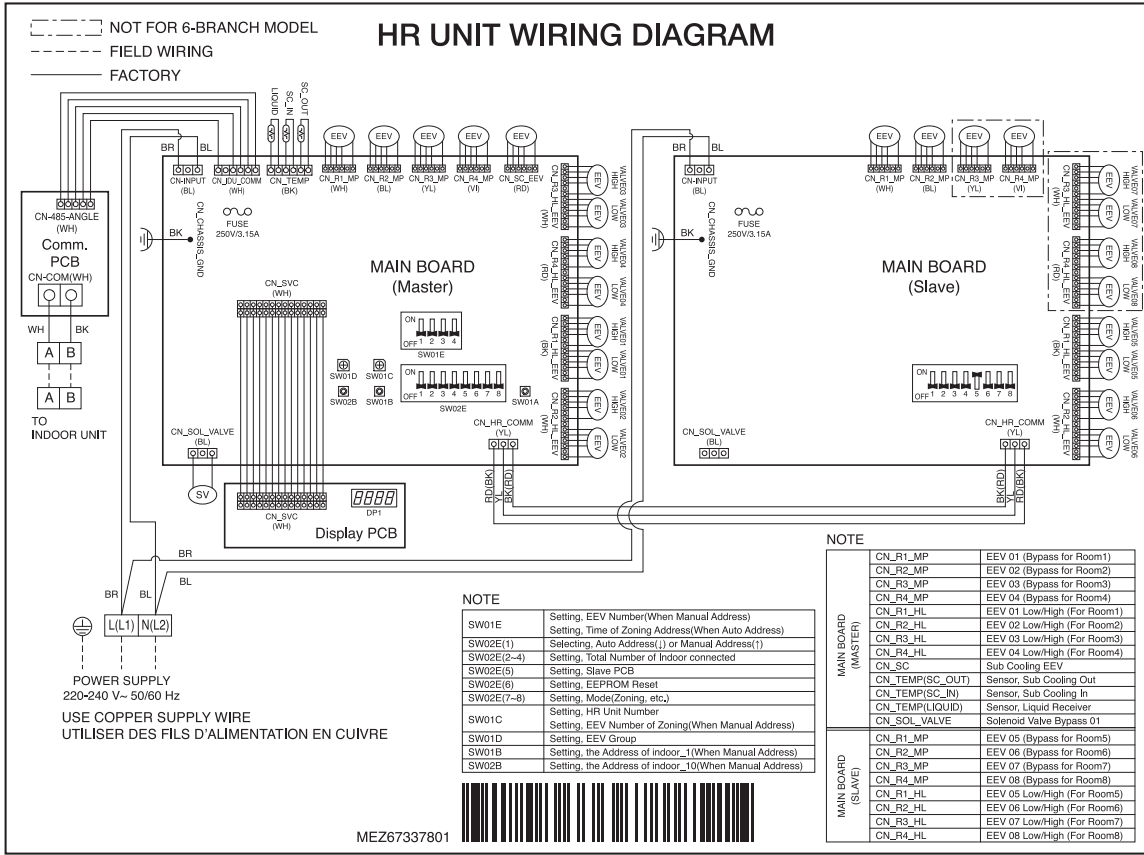

	CONNECTOR NUMBER	FUNCTION
MAIN BOARD (MASTER)	CN_R1_MP	EEV 01 (Bypass for Room1)
	CN_R2_MP	EEV 02 (Bypass for Room2)
	CN_R3_MP	EEV 03 (Bypass for Room3)
	CN_R4_MP	EEV 04 (Bypass for Room4)
	CN_R1_HL	EEV 01 Low/High (For Room1)
	CN_R2_HL	EEV 02 Low/High (For Room2)
	CN_R3_HL	EEV 03 Low/High (For Room3)
	CN_R4_HL	EEV 04 Low/High (For Room4)
	CN_SC	Sub Cooling EEV
	CN_TEMP(SC_OUT)	Sensor, Sub Cooling Out
	CN_TEMP(SC_IN)	Sensor, Sub Cooling In
	CN_TEMP(LIQUID)	Sensor, Sub Cooling Out
	CN_SEN_02 (SC_IN)	Sensor, Sub Cooling In
	CN_SEN_02 (LIQUID)	Sensor, Liquid Receiver
MAIN BOARD (SLAVE)	CN_R1_MP	EEV 05 (Bypass for Room5)
	CN_R2_MP	EEV 06 (Bypass for Room6)
	CN_R3_MP	EEV 07 (Bypass for Room7)
	CN_R4_MP	EEV 08 (Bypass for Room8)
	CN_R1_HL	EEV 05 Low/High (For Room5)
	CN_R2_HL	EEV 06 Low/High (For Room6)
	CN_R3_HL	EEV 07 Low/High (For Room7)
	CN_R4_HL	EEV 08 Low/High (For Room8)

## 6. Wiring Diagrams

CONNECTOR NUMBER	FUNCTION
SW01E	Setting, EEV Number(When Manual Address)
	Setting, Time of Zoning Address(When Auto Address)
SW02E(1)	Selecting, Auto Address( ↓ ) or Manual Address( ↑ )
SW02E(2~4)	Setting, Total Number of Indoor connected
SW02E(5)	Setting, Slave PCB
SW02E(6)	Setting, EEPROM Reset
SW02E(7~8)	Setting, Mode(Zoning, etc.)
SW01C	Setting, HR Unit Number
	Setting, EEV Number of Zoning(When Manual Address)
SW01D	Setting, EEV Group
SW01B	Setting, the Address of indoor_1(When Manual Address)
SW02B	Setting, the Address of indoor_10(When Manual Address)

# 7. Sound Levels

## 7.1 Sound pressure level

### Overall

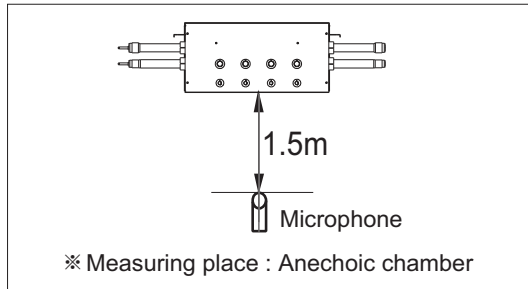

**Note**

- Sound measured at 1.5m away from the center of the unit.
- Operating condition|
  - Power source : 220-240V 50Hz / 220V 60Hz
  - Cooling : Indoor temperature (27°C DB, 19°C WB), Outdoor temperature (35°C DB, 24°C WB)
  - Heating : Indoor temperature (20°C DB, 15°C WB), Outdoor temperature (7°C DB, 6°C WB)
- Reference acoustic pressure 0dB=20μPa.
- Sound level will vary depending on a range of factors such as the construction(acoustic absorption coefficient) of particular room in which the equipment is installed.
- The changeover sound was measured by switching the mode of one indoor unit.  
It could vary depending on the number of indoor units in operation, piping length and installation environment.

Operation Mode	50Hz, 220-240V
	Sound pressure Levels [dB(A)]
Cooling	30
Heating	30
Changeover : Cooling → Heating	33
Changeover : Heating → Cooling	38

**Cooling**

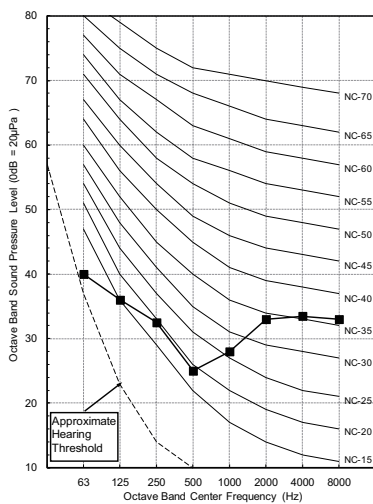

**Heating**

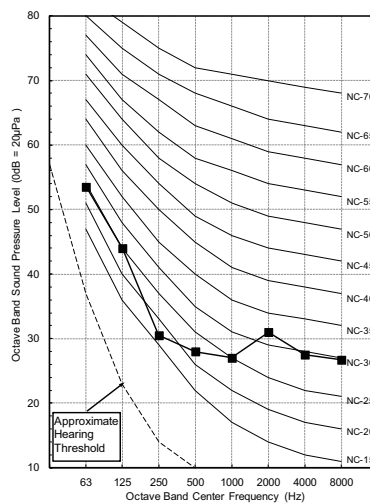

**Changeover : Cooling → Heating**

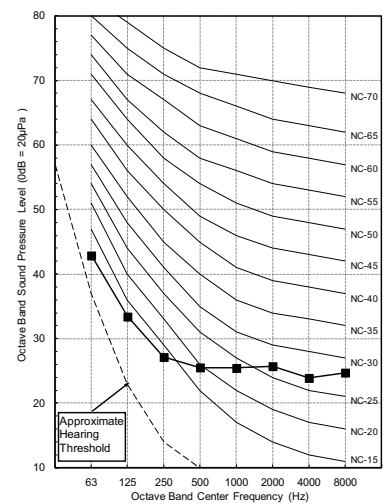

# 7. Sound Levels

Changeover : Heating → Cooling

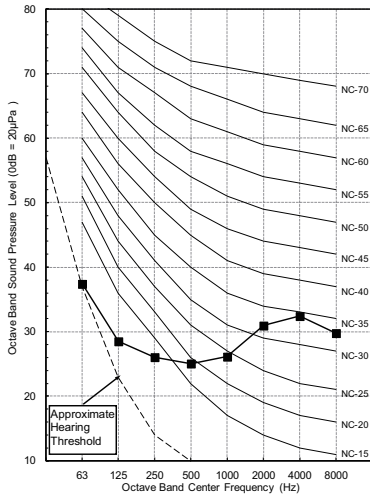



# **MULTI V™ 5**

## **Installation of Outdoor Units**

- 1. Alternative Refrigerant R410A**
- 2. Select the Best Location**
- 3. Installation Space**
- 4. Lifting Method**
- 5. Installation**
- 6. Refrigerant piping Installation**
- 7. Refrigerant piping system**
- 8. Electrical Wiring**
- 9. Setting Function**

## 1. Alternative Refrigerant R410A

---

- The refrigerant R410A has the property of higher operating pressure in comparison with R22. Therefore, all materials have the characteristics of higher resisting pressure than R22 ones and this characteristic should also be considered during the installation.  
R410A is an azeotrope of R32 and R125 mixed at 50:50, so the ozone depletion potential (ODP) of R410A is 0.
- 

### CAUTION

- The wall thickness of the piping should comply with the relevant local and national regulations for the designed pressure 3.8MPa
  - Since R410A is a mixed refrigerant, the required additional refrigerant must be charged in its liquid state. If the refrigerant is charged in its gaseous state, its composition changes and the system will not work properly.
  - Do not place the refrigerant container under the direct rays of the sun to prevent it from exploding.
  - For high-pressure refrigerant, any unapproved pipe must not be used.
  - Do not heat pipes more than necessary to prevent them from softening.
  - Be careful not to install wrongly to minimize economic loss because it is expensive in comparison with R22.
-

## 2. Select the Best Location

---

Select space for installing outdoor unit, which will meet the following conditions:

- No direct thermal radiation from other heat sources
- No possibility of annoying neighbors due to noise of unit
- No exposition to strong wind
- With strength which bears weight of unit
- Note that drain flows out of unit when heating
- Because of the possibility of fire, do not install unit to the space where generation, inflow, stagnation, and leakage of combustible gas is expected.
- Avoid unit installation in a place where acidic solution and spray (sulfur) are often used.
- Do not use unit under any special environment where oil, steam and sulfuric gas exist.
- It is recommended to fence round the outdoor unit in order to prevent any person or animal from accessing the outdoor unit.
- If installation site is area of heavy snowfall, then the following directions should be observed.
  - Make the foundation as high as possible.
  - Fit a snow protection hood.
- Select installation location considering following conditions to avoid bad condition when additionally performing defrost operation.
  1. Install the outdoor unit at a place well ventilated and having a lot of sunshine in case of installing the product at a place with a high humidity in winter (near beach, coast, lake, etc).  
(Ex) Rooftop where sunshine always shines.
  2. Performance of heating will be reduced and pre-heat time of the indoor unit may be lengthened in case of installing the outdoor unit in winter at following location:
    - 1) Shade position with a narrow space
    - 2) Location with much moisture in neighboring floor.
    - 3) Location with much humidity around.
    - 4) Location where liquid gathers since the floor is not even.

### 3. Installation Space

#### 3.1 Individual Installation

**■ Select installation location of the HR unit suitable for following conditions**

- Avoid a place where rain may enter since the HR unit is for indoor.
- Sufficient service space must be obtained.
- Refrigerant pipe must not exceed limited length.
- Avoid a place subject to a strong radiation heat from other heat source.
- Avoid a place where oil spattering, vapor spray or high frequency electric noise is expected.
- Install the unit at a place in which it is not affected by operation noise. (Installation within cell such as meeting room etc. may disturb business due to noise.)
- Place where refrigerant piping, drain piping and electrical wiring works are easy.

**PRHR023 / PRHR033 / PRHR043**

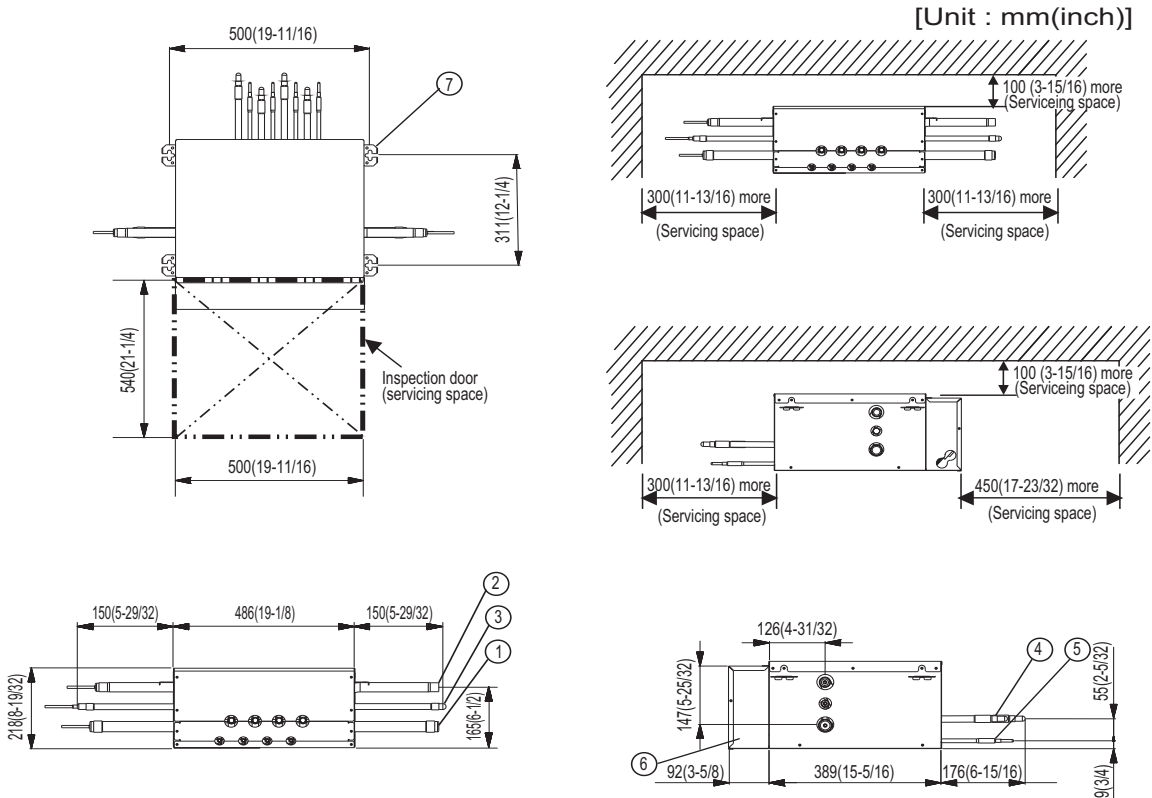

No.	Part Name	Description	
		PRHR033 / PRHR043	PRHR023
1	Low pressure Gas pipe connection port	Ø28.58(1-1/8) Brazing connection	Ø22.2(7/8) Brazing connection
2	High pressure Gas pipe connection port	Ø22.2(7/8) Brazing connection	Ø19.05(3/4) Brazing connection
3	Liquid pipe connection port	Ø15.88(5/8) Brazing connection(PRHR043) Ø12.7 Brazing connection(PRHR033)	Ø9.52(3/8) Brazing connection
4	Indoor unit Gas pipe connection port	Ø15.88(5/8)~Ø12.7(1/2) Brazing connection	Ø15.88(5/8)~Ø12.7(1/2) Brazing connection
5	Indoor unit Liquid pipe connection port	Ø9.52(3/8)~Ø6.35(1/4) Brazing connection	Ø9.52(3/8)~Ø6.35(1/4) Brazing connection
6	Control box	-	-
7	Hanger metal	Suspension bolt M10 or M8	Suspension bolt M10 or M8

**Notice**

1. Be sure to install the inspection door at the control box side.
2. If reducers are used, servicing space must be increased equal to reducer's dimension.

### 3. Installation Space

PRHR063 / PRHR083

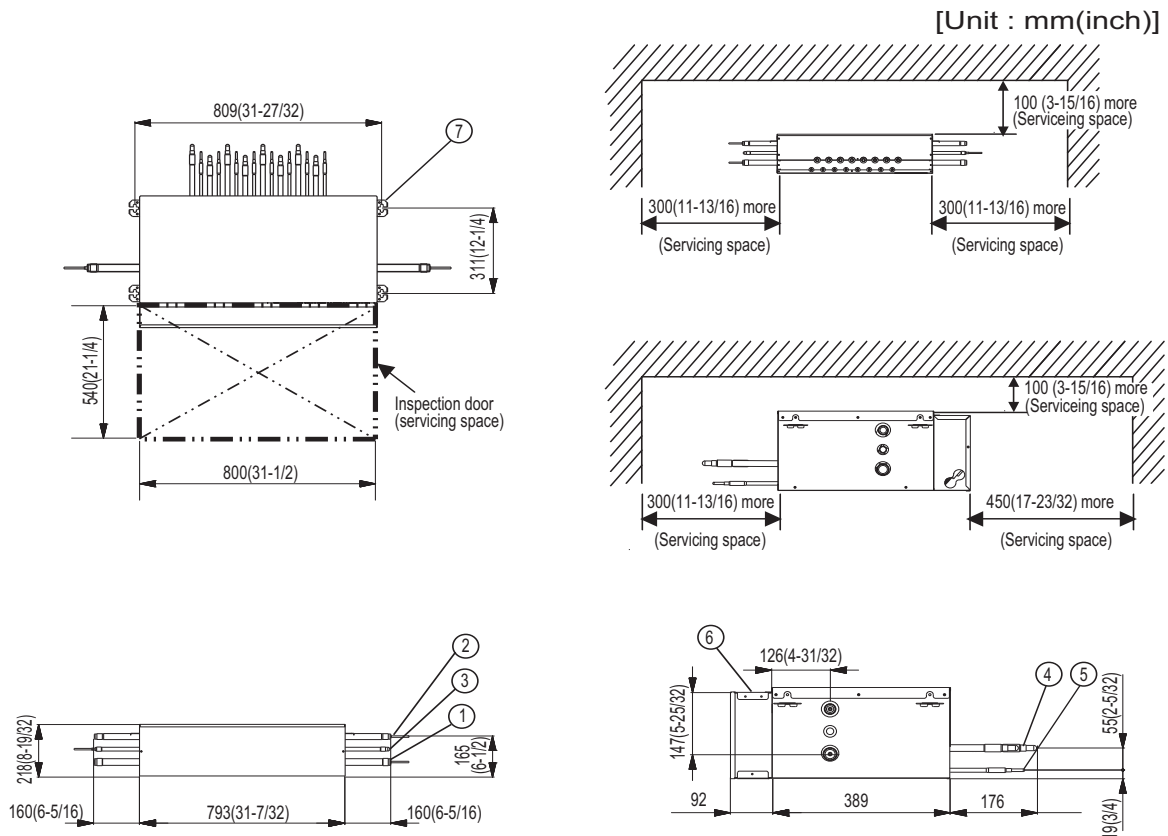

No.	Part Name	Description
		PRHR063 / PRHR083
1	Low pressure Gas pipe connection port	Ø28.58(1-1/8) Brazing connection
2	High pressure Gas pipe connection port	Ø22.2(7/8) Brazing connection
3	Liquid pipe connection port	Ø15.88(5/8) Brazing connection
4	Indoor unit Gas pipe connection port	Ø15.88(5/8)~Ø12.7(1/2) Brazing connection
5	Indoor unit Liquid pipe connection port	Ø9.52(3/8)~Ø6.35(1/4) Brazing connection
6	Control box	-
7	Hanger metal	Suspension bolt M10 or M8

#### Notice

1. Be sure to install the inspection door at the control box side.
2. If reducers are used, servicing space must be increased equal to reducer's dimension.

### 3. Installation Space

#### Required space around the unit

During the installation of the unit, consider service, inlet, and outlet and acquire the minimum space as shown in the figures below. Side space should be more than 49mm(1-15/16inch) for operating of Auto Dust Removal mode.

Category	Installation Space	Case 1 [Unit : mm(inch)] (10(13/32) ≤ Side Space ≤ 49(1-15/16))	Case 2 [Unit : mm(inch)] (Side Space ≥ 49(1-15/16))
4 sides are walls		A ≥ 10(13/32) B ≥ 300(11-13/16) C ≥ 10(31/32) D ≥ 500(19-11/16)	A ≥ 50(1-31/32) B ≥ 100(3-15/16) C ≥ 50(1-31/32) D ≥ 500(19-11/16)
		A ≥ 10(13/32) B ≥ 300(11-13/16) C ≥ 10(13/32) D ≥ 500(19-11/16) E ≥ 20(25/32)	A ≥ 50(1-31/32) B ≥ 100(3-15/16) C ≥ 50(1-31/32) D ≥ 500(19-11/16) E ≥ 100(3-15/16)
		A ≥ 10(13/32) B ≥ 300(11-13/16) C ≥ 10(31/32) D ≥ 500(19-11/16) E ≥ 20(25/32) F ≥ 600(23-5/8)	A ≥ 50(1-31/32) B ≥ 100(3-15/16) C ≥ 50(1-31/32) D ≥ 500(19-11/16) E ≥ 100(3-15/16) F ≥ 500(19-11/16)
		A ≥ 10(13/32) B ≥ 300(11-13/16) C ≥ 10(31/32) D ≥ 300(11-13/16) E ≥ 20(25/32) F ≥ 500(19-11/16)	A ≥ 50(1-31/32) B ≥ 100(3-15/16) C ≥ 50(1-31/32) D ≥ 100(3-15/16) E ≥ 100(3-15/16) F ≥ 500(19-11/16)
Rear to Rear		A ≥ 10(13/32) B ≥ 500(19-11/16) C ≥ 10(31/32) D ≥ 500(19-11/16) F ≥ 900(35-7/16)	A ≥ 50(1-31/32) B ≥ 500(19-11/16) C ≥ 50(1-31/32) D ≥ 500(19-11/16) F ≥ 600(23-5/8)
		A ≥ 10(13/32) B ≥ 500(19-11/16) C ≥ 10(31/32) D ≥ 500(19-11/16) E ≥ 20(25/32) F ≥ 1200(47-1/4)	A ≥ 50(1-31/32) B ≥ 500(19-11/16) C ≥ 50(1-31/32) D ≥ 500(19-11/16) E ≥ 100(3-15/16) F ≥ 900(35-7/16)
		A ≥ 10(13/32) B ≥ 500(19-11/16) C ≥ 10(31/32) D ≥ 500(19-11/16) E ≥ 20(25/32) F ≥ 1800(70-7/8)	A ≥ 50(1-31/32) B ≥ 500(19-11/16) C ≥ 50(1-31/32) D ≥ 500(19-11/16) E ≥ 100(3-15/16) F ≥ 1200(47-1/4)

### 3. Installation Space

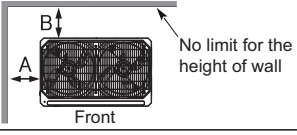
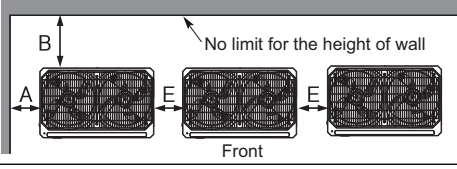
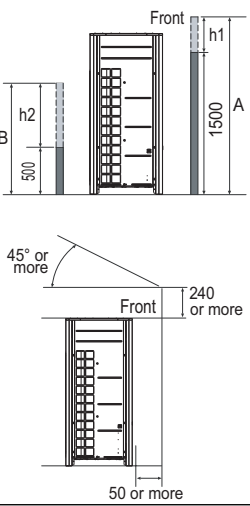
Category	Installation Space	Case 1 (10mm ≤ Side Space ≤ 49mm)	Case 2 (Side Space ≥ 49mm)
Only 2 sides are walls		$A \geq 10(13/32)$ $B \geq 300(11-13/16)$	-
		$A \geq 10(13/32)$ $B \geq 300(11-13/16)$ $E \geq 20(25/32)$	-
Limitations on the height of the wall (Refer to 4 side walls)		<ul style="list-style-type: none"> <li>The height of the wall on the front side must be 1500mm(59-1/16inch) or less.</li> <li>The height of the wall on the inlet side must be 500mm(19-11/16inch) or less.</li> <li>There is no limit to the wall on the side.</li> <li>If the height of the walls on the front and the side are higher than the limit, there must be additional space on the front and the side. <ul style="list-style-type: none"> <li>Additional Space on the inlet side by 1/2 of h1.</li> <li>Additional Space on the front side by 1/2 of h2</li> <li><math>h1 = A(\text{Actual height}) - 1500(59-1/16)</math></li> <li><math>h2 = B(\text{Actual height}) - 500(19-11/16)</math></li> </ul> </li> </ul>	

#### ■ Seasonal wind and cautions in winter

- Sufficient measures are required in a snow area or severe cold area in winter so that product can be operated well.
- Get ready for seasonal wind or snow in winter even in other areas.
- Install a suction and discharge duct not to let in snow or rain.
- Install the outdoor unit in such a way that it should not come in contact with snow directly. If snow piles up and freezes on the air suction hole, the system may malfunction. If it is installed at snowy area, attach the hood to the system.
- The raised support platform must be high enough to allow the unit to remain above possible snow drifts, and must be higher than the maximum anticipated snowfall for the location.
- Where snow accumulated on the upper part of the Outdoor Unit by more than 10cm(3-15/16inch), always remove snow for operation.

#### CAUTION

- Don't install the suction hole and discharge hole of the Outdoor Unit facing the seasonal wind.

## 4. Lifting Method

- When carrying the suspended, unit pass the ropes under the unit and use the two suspension points each at the front and rear.
- Always lift the unit with ropes attached at four points so that impact is not applied to the unit.
- Attach the ropes to the unit at an angle of 40° or less.

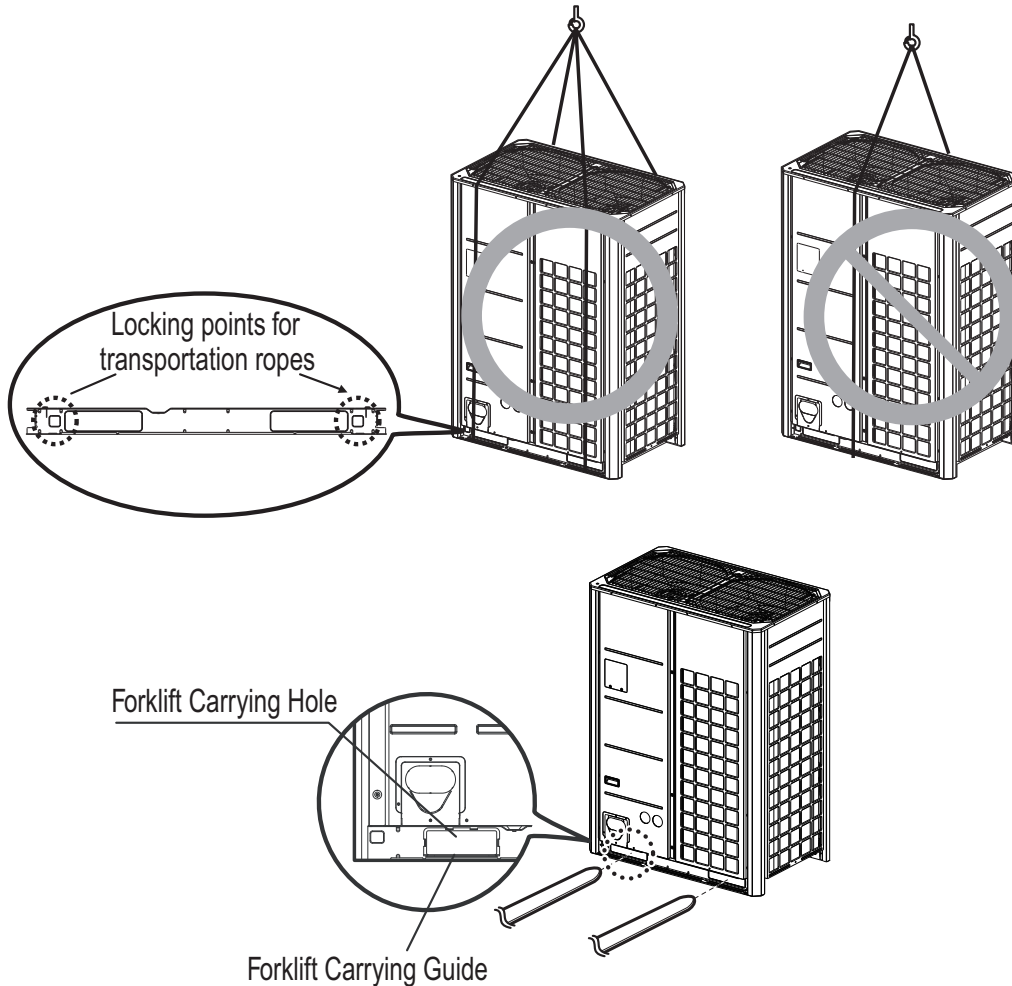

### **CAUTION**

**Be very careful while carrying the product.**

- Do not have only one person carry product if it is more than 20kg(441lbs).
- PP bands are used to pack some products. Do not use them as a mean for transportation because they are dangerous.
- Do not touch heat exchanger fins with your bare hands. Otherwise you may get a cut in your hands.
- Tear plastic packaging bag and scrap it so that children cannot play with it. Otherwise plastic packaging bag may suffocate children to death.
- When carrying in Outdoor Unit, be sure to support it at four points. Carrying in and lifting with 3-point support may make Outdoor Unit unstable, resulting in a fall.
- Use 2 belts of at least 8m(26.2ft) long.
- Place extra cloth or boards in the locations where the casing comes in contact with the sling to prevent damage.
- Hoist the unit making sure it is being lifted at its center of gravity.



## 5. Installation

- Install at places where it can endure the weight and vibration/noise of the outdoor unit.
- The outdoor unit support block at the bottom shall have width of at least 100mm(3-15/16inch) under the units legs before being fixed.
- The outdoor unit support block should have minimum height of 200mm(7-7/8inch).
- Anchor bolts must be inserted at least 75mm(2-15/16inch).

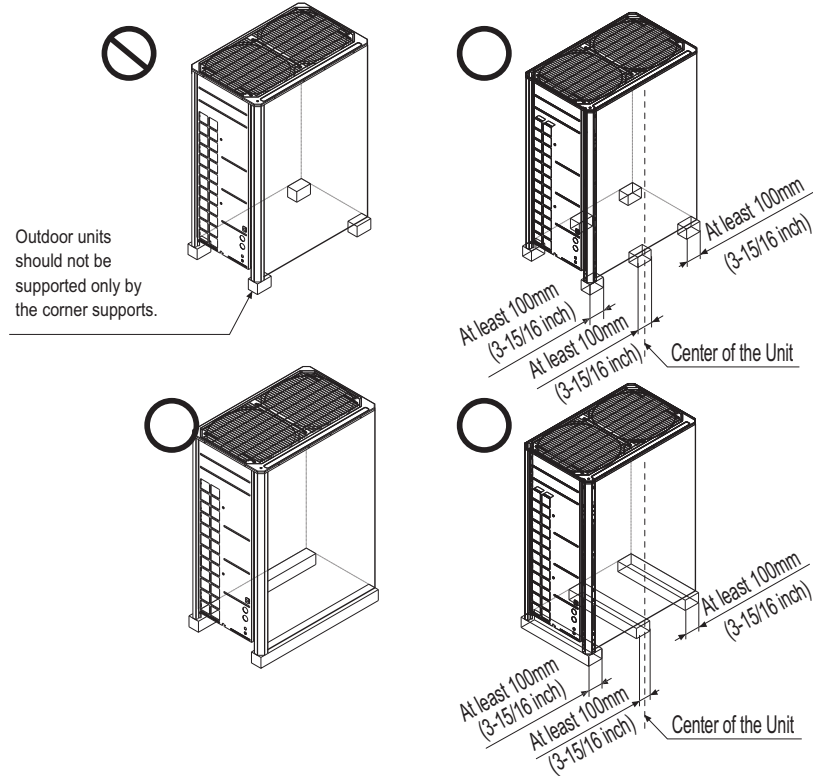

### 5.1 The location of the Anchor bolts

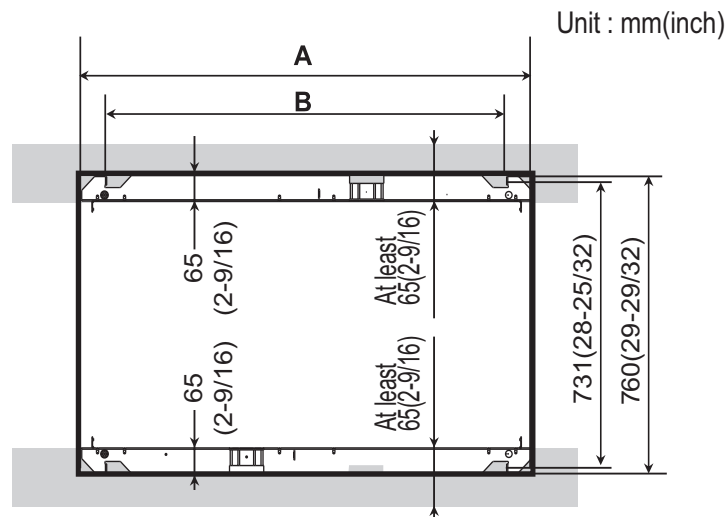

Chassis	A [mm(inch)]	B [mm(inch)]
UXA	930(36-5/8)	730(28-3/4)
UXB	1,240(48-13/16)	1,040(40-15/16)

## 5. Installation

### 5.2 Foundation for Installation

- Fix the unit tightly with bolts as shown below so that unit will not fall down due to earthquake or gust.
- Use the H-beam support as a base support
- Noise and vibration may occur from the floor or wall since vibration is transferred through the installation part depending on installation status. Thus, use anti-vibration materials (cushion pad) fully (The base pad shall be more than 200mm(7-7/8inch))

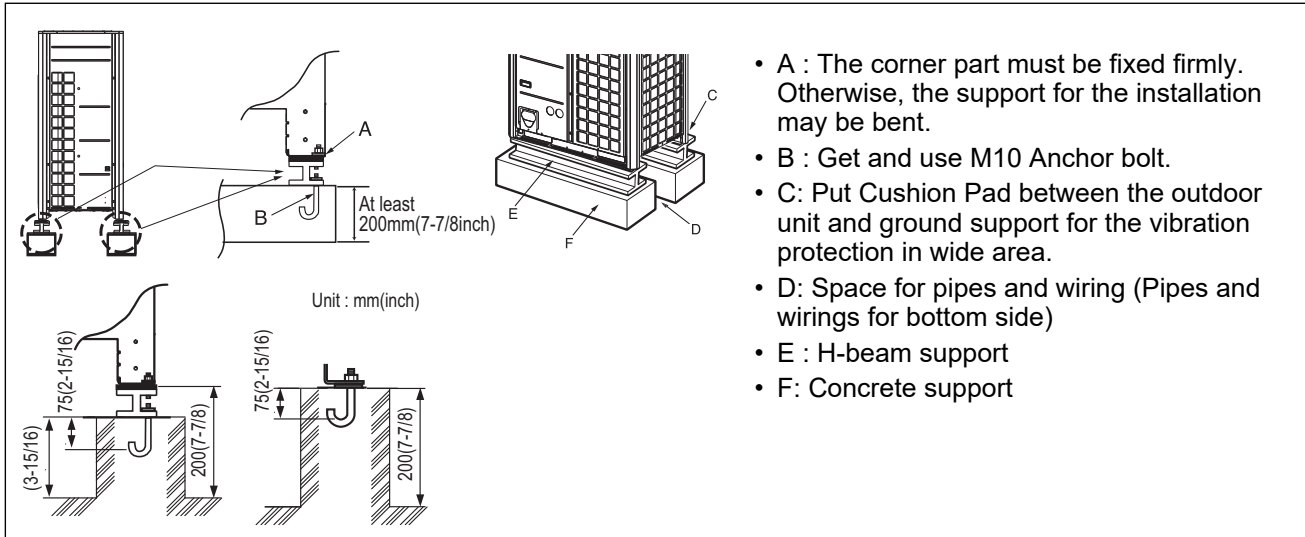

#### ⚠ WARNING

- Install where it can sufficiently support the weight of the outdoor unit.  
If the support strength is not enough, the outdoor unit may drop and hurt people.
- Install where the outdoor unit may not fall in strong wind or earthquake.  
If there is a fault in the supporting conditions, the outdoor unit may fall and hurt people.
- Please take extra cautions on the supporting strength of the ground, liquid outlet treatment (treatment of the liquid flowing out of the outdoor unit in operation), and the passages of the pipe and wiring, when making the ground support.
- Do not use tube or pipe for liquid outlet in the Base pan. Use drainage instead for liquid outlet. The tube or pipe may freeze and the liquid may not be drained.

#### ⚠ CAUTION

- Be sure to remove the MDF (wood support) of the bottom side of the outdoor unit Base Pan before fixing the bolt. It may cause the unstable state of the outdoor settlement, and may cause freezing of the heat exchanger resulting in abnormal operations.
- Be sure to remove the MDF (wood support) of the bottom side of the outdoor unit before welding. Not removing MDF causes hazard of fire during welding.

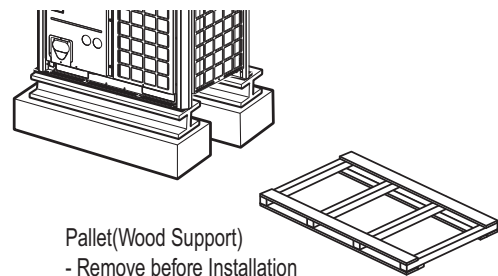

## 6. Refrigerant piping Installation

### 6.1 Precautions on Pipe connection / Valve operation

Pipe connection is done by connecting from the end of the pipe to the branching pipes, and the refrigerant pipe coming out of the outdoor unit is divided at the end to connect to each indoor unit. Flare connection for the indoor unit, and welding connection for the outdoor pipe and the branching parts.

- Use hexagonal wrench to open/close the valve.
- In case of installing as heat pump system, be sure to maintain to close no use pipe like below picture.

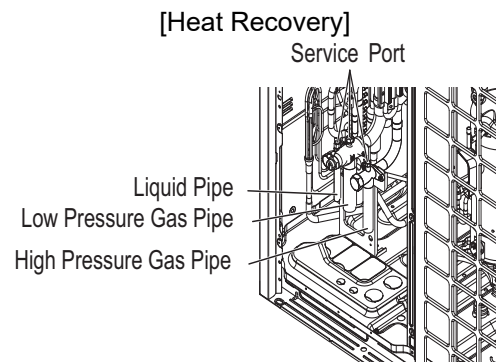
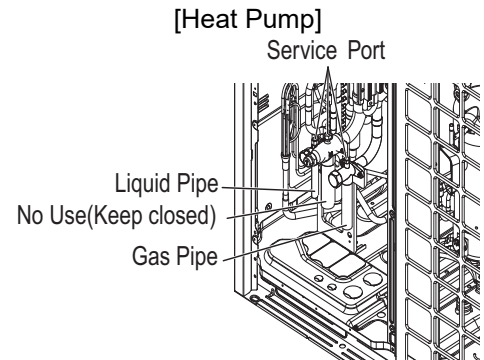

#### **⚠ WARNING**

- Always careful not to leak the refrigerant during welding.
- The refrigerant generates poisonous gas harmful to human body if combusted.
- Do not perform welding in a closed space.
- Be sure to close the cap of the service port to prevent gas leakage after the work.

#### **⚠ CAUTION**

Please block the pipe knock outs of the front and side panels after installing the pipes.  
(Animals or foreign objects may be brought in to damage the cables.)

# 6. Refrigerant piping Installation

## 6.2 Connection of Outdoor units

When installing outdoor unit series, refer below picture.

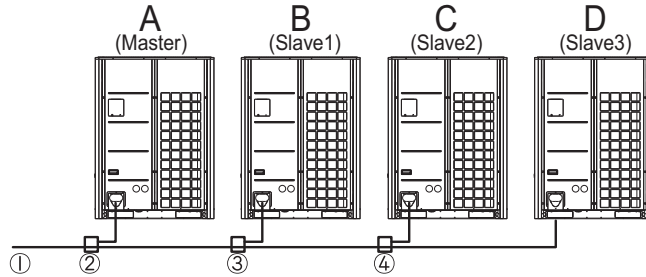

A≥B≥C≥D

- ① Indoor unit side connection pipe
- ② Outdoor unit to outdoor unit connection pipe (1st branch)
- ③ Outdoor unit to outdoor unit connection pipe (2st branch)
- ④ Outdoor unit to outdoor unit connection pipe (3rd branch)

### ■ Heat Recovery System

Outdoor unit	Model	Low Pressure Gas pipe [unit:mm(inch)]	Liquid pipe [unit:mm(inch)]	High Pressure Gas pipe [unit:mm(inch)]
2 unit	ARC <b>C</b> NB21			
3 unit	ARC <b>b</b> NB31			
4 unit	ARC <b>a</b> NB41			

For more information including installation method of connection pipe, refer accessory installation manual.

# 6. Refrigerant piping Installation

## Heat Pump System

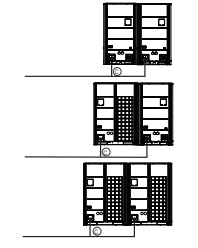
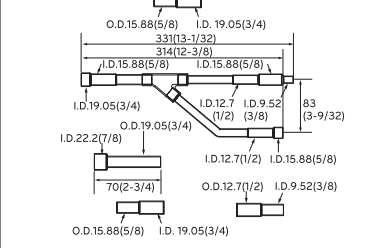
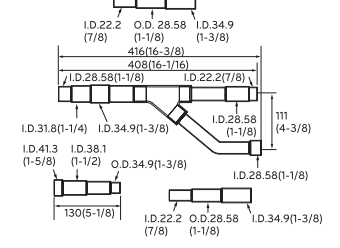
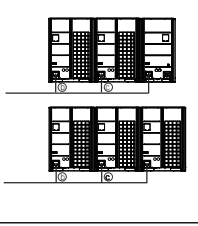
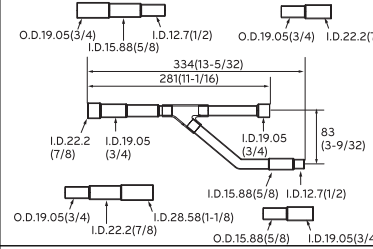
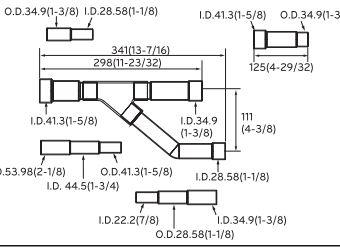
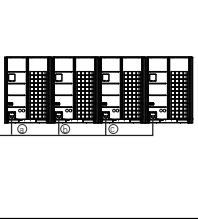
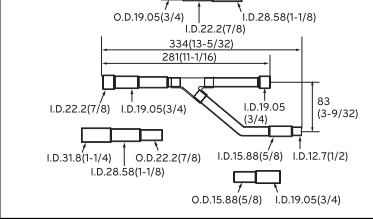
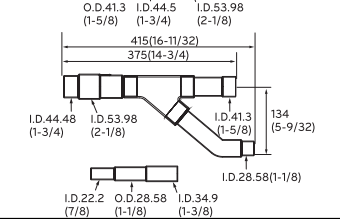
Outdoor unit	Model	Liquid pipe [unit:mm(inch)]	Gas pipe [unit:mm(inch)]
<p>2 unit</p> 	<p>③ ARCNN21</p> 		
<p>3 unit</p> 	<p>④ ARCNN31</p> 		
<p>4 unit</p> 	<p>⑤ ARCNN41</p> 		

For more information including installation method of connection pipe, refer accessory installation manual.

## 7. Refrigerant piping system

### 7.1 Pipe Connection Method between outdoor unit/indoor unit

#### 7.1.1 Heat Recovery System : 4 Outdoor Units

##### **Example : 12 Indoor Units connected**

- Ⓐ Outdoor Unit
- Ⓑ Y branch
- Ⓓ Indoor Units
- E : Connection branch pipe between Outdoor units : ARCNB41
- F : Connection branch pipe between Outdoor units : ARCNB31
- G: Connection branch pipe between Outdoor units : ARCNB21
- Ⓗ Header
- Ⓛ HR Unit

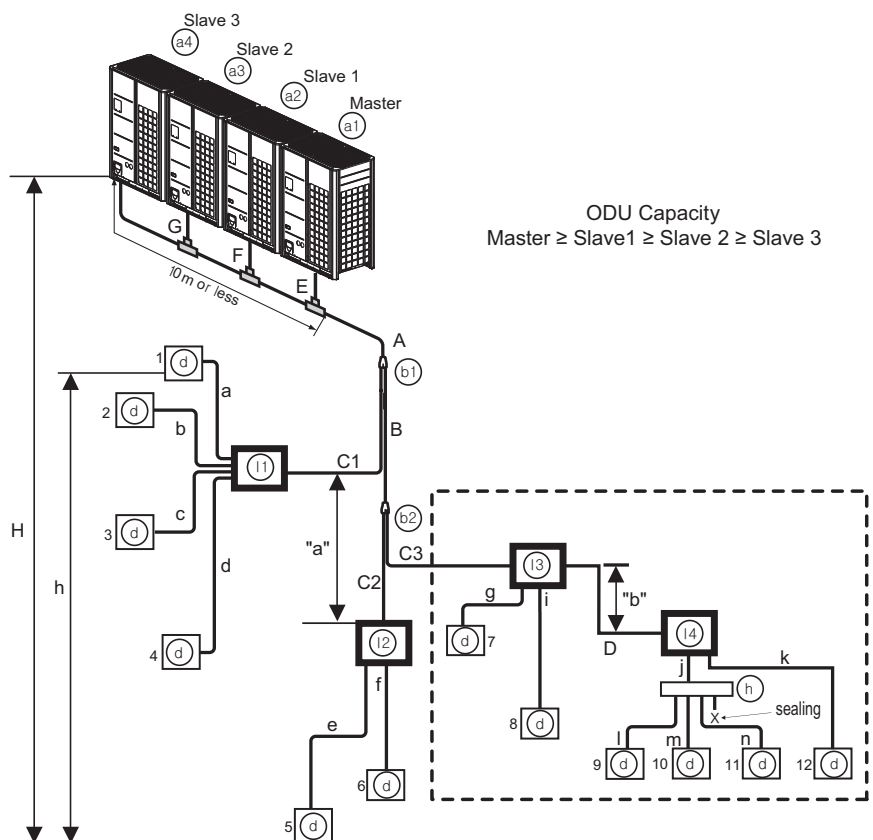

- Case 1 ("a") : Maximum height is 30m(98.4ft) if you install with Y branch.
- Case 2 ("b") : Maximum height is 5m(16.4ft) in serial connection of HR units.

#### **⚠ WARNING**

- Branch pipe can not be used after header
- It is recommended that difference in length of the pipes connected to the indoor units (a~f) is minimized. The large difference in pipe lengths, the more different performance between indoor units.
- \* : Serial connection of HR units : Capacity sum of indoor units  $\leq 230$  kBtu/h  
If the large capacity indoor units (Over 5 HP; using over $\varnothing 15.88/\varnothing 9.52$ ) are installed, it should be used the Valve Group setting.
- Refer to the HR unit PCB part for the valve group control setting.
- Piping length from outdoor branch to outdoor unit  $\leq 10$ m(32.8ft), equivalent length : max 13m(42.7ft) (for 2 units combination or more)

## 7. Refrigerant piping system

### ■ Total pipe length = A+B+C1+C2+C3+D+a+b+c+d+e+f+g+i+j+k+l+m+n ≤ 1,000

Max. pipe length	Total pipe length (A+B+C1+C2+C3+D+a+b+c+d+e+f+g+i+j+k+l+m+n)		1,000m [3,281ft]
	L	Longest pipe length (A+B+C3+D+k) : between Outdoor Unit and Indoor Unit	150m [492ft] (200m [656ft]**)
		Longest pipe Equivalent length* : between Outdoor Unit and Indoor Unit	175m [574ft] (225m [738ft]**)
/	Longest pipe length after 1st branch		40m [131ft] (90m [295ft]**)
Max. difference in height	H	Between Outdoor Unit and Indoor Unit	110m [361ft]
	h	Between Indoor Unit and Indoor Unit	40m [131ft]
	h1	Between Outdoor Unit and Outdoor Unit	5m [16.4ft]
	h2	Between Indoor Unit and HR Unit	15m [49.2ft]
	a	Between HR Unit and HR Unit	30m [98.4ft]
	b	Between HR Unit and HR Unit within same branch	5m [16.4ft]

### Note

- \* : Assume equivalent piping length of Y branch to be 0.5m (1.64ft), that of header to be 1m (3.28ft), calculation purpose.
- \*\* : To apply Conditional Application



### WARNING

When the any one (or both ) of below conditions are satisfied, the diameter of main pipe (A) must be increased according to below table.

- The equivalent length between outdoor unit and the farthest indoor unit is 90m (295ft) or more (Liquid or Gas pipes are increased in accordance with below table)
- The level difference (Outdoor unit ↔ Indoor unit) is 50m (164ft) or more (Only liquid pipe is increased)

### ■ Refrigerant pipe diameter from outdoor unit to first branch. (A)

Upward Outdoorunit total capacity	Standard Pipe Diameter			When equivalent pipe length is 90m(295ft) or more from ODU to farthest IDU		
	HP	Liquid pipe[mm(inch)]	Low Pressure Gaspipe [mm(inch)]	High Pressure Gaspipe [mm(inch)]	Liquid pipe[mm(inch)]	Low Pressure Gaspipe [mm(inch)]
8	Ø 9.52 (3/8)	Ø 19.05 (3/4)	Ø 15.88 (5/8)	Ø 12.7 (1/2)	Not increased	Not increased
10	Ø 9.52 (3/8)	Ø 22.2 (7/8)	Ø 19.05 (3/4)	Ø 12.7 (1/2)	Not increased	Not increased
12	Ø 12.7 (1/2)	Ø 28.58 (1-1/8)	Ø 19.05 (3/4)	Ø 15.88 (5/8)	Not increased	Not increased
14 ~ 16	Ø 12.7 (1/2)	Ø 28.58 (1-1/8)	Ø 22.2 (7/8)	Ø 15.88 (5/8)	Not increased	Not increased
18 ~ 20	Ø 15.88 (5/8)	Ø 28.58 (1-1/8)	Ø 22.2 (7/8)	Ø 19.05 (3/4)	Not increased	Not increased
22	Ø 15.88 (5/8)	Ø 28.58 (1-1/8)	Ø 28.58 (1-1/8)	Ø 19.05 (3/4)	Not increased	Not increased
24	Ø 15.88 (5/8)	Ø 34.9 (1-3/8)	Ø 28.58 (1-1/8)	Ø 19.05 (3/4)	Not increased	Not increased
26 ~ 34	Ø 19.05 (3/4)	Ø 34.9 (1-3/8)	Ø 28.58 (1-1/8)	Ø 22.2 (7/8)	Not increased	Not increased
36	Ø 19.05 (3/4)	Ø 41.3 (1-5/8)	Ø 28.58 (1-1/8)	Ø 22.2 (7/8)	Not increased	Not increased
38 ~ 60	Ø 19.05 (3/4)	Ø 41.3 (1-5/8)	Ø 34.9 (1-3/8)	Ø 22.2 (7/8)	Not increased	Not increased
62 ~ 64	Ø 22.2 (7/8)	Ø 41.3 (1-5/8)	Ø 34.9 (1-3/8)	Ø 25.4 (1) *	Not increased	Not increased
66 ~ 96	Ø 22.2 (7/8)	Ø 53.98 (2-1/8)	Ø 41.3 (1-5/8)	Ø 25.4 (1) *	Not increased	Not increased

### Note

- \* : If available on site, select pipe size from the pipe diameter table according to capacity. Otherwise it doesn't need to be increased.
- Model line up could be different in accordance with target region.

## 7. Refrigerant piping system

### ■ Refrigerant pipe diameter from branch to branch (B,C)

Downward indoorunit total capacity[kW(Btu/h)]	Liquid pipe[mm(inch)]	Gas pipe [mm(inch)]	
		Low pressure	High pressure
≤ 5.6(19,100)	Ø6.35(1/4)	Ø12.7(1/2)	Ø9.52(3/8)
< 16.0 (54,600)	Ø9.52(3/8)	Ø15.88(5/8)	Ø12.7(1/2)
< 22.4 (76,400)	Ø9.52(3/8)	Ø19.05(3/4)	Ø15.88(5/8)
< 33.6(114,700)	Ø9.52(3/8)	Ø22.2(7/8)	Ø19.05(3/4)
< 50.4(172,000)	Ø12.7(1/2)	Ø28.58(1-1/8)	Ø22.2(7/8)
< 67.2(229,300)	Ø15.88(5/8)	Ø28.58(1-1/8)	Ø22.2(7/8)
< 72.8(248,400)	Ø15.88(5/8)	Ø34.9(1-3/8)	Ø28.58(1-1/8)
< 100.8(344,000)	Ø19.05(3/4)	Ø34.9(1-3/8)	Ø28.58(1-1/8)
< 173.6(592,500)	Ø19.05(3/4)	Ø41.3(1-5/8)	Ø34.9(1-3/8)
< 184.8(630,700)	Ø22.2(7/8)	Ø41.3(1-5/8)	Ø34.9(1-3/8)
≤ 291.2(993,600)	Ø22.2(7/8)	Ø53.98(2-1/8)	Ø41.3(1-5/8)

### ■ (\*\*) Conditional Application

If the below conditions are satisfied, limit of longest pipe length after 1st branch( *l* ) could be extended by 40m (131ft)→ 90m(295ft).

#### 1. Pipe diameter Size Up

Pipe diameter(only Liquid/low pressure gas pipes) between 1st branch and last branch(HR unit) is increased by one step. If the pipe diameter of B, C3 is same as A, it is not necessary.

: Ø 6.35 → Ø 9.52 → Ø 12.7 → Ø 15.88 → Ø 19.05 → Ø 22.2 → ...

If available on site, select pipe size from the pipe diameter table according to capacity.

Otherwise it doesn't need to be increased.

#### 2. Correction for calculating the total pipe length

When calculating total pipe length, pipe B,C,D length should be calculated twice.

:  $A + B \times 2 + C3 \times 2 + D \times 2 + C1 + C2 + a + b + c + d + e + f + g + i + j + k + l + m + n \leq 1,000\text{m (3,281ft)}$

#### 3. Indoor unit pipe length

Length of pipe from each indoor unit to the closest HR unit (a, b, c, d, e, f, g, i, j, k, l, m, n) ≤ 40m (131ft).

#### 4. Difference in length between outdoor unit and the farthest or closest indoor unit

[Length of pipe from outdoor unit to the farthest indoor unit 12 (B + C3 + D + k)]

- [Length of pipe from outdoor unit to the closest indoor unit 1 (C1 + a)] ≤ 40m (131ft)



# 7. Refrigerant piping system

## Y branch, Header and HR unit connection pattern

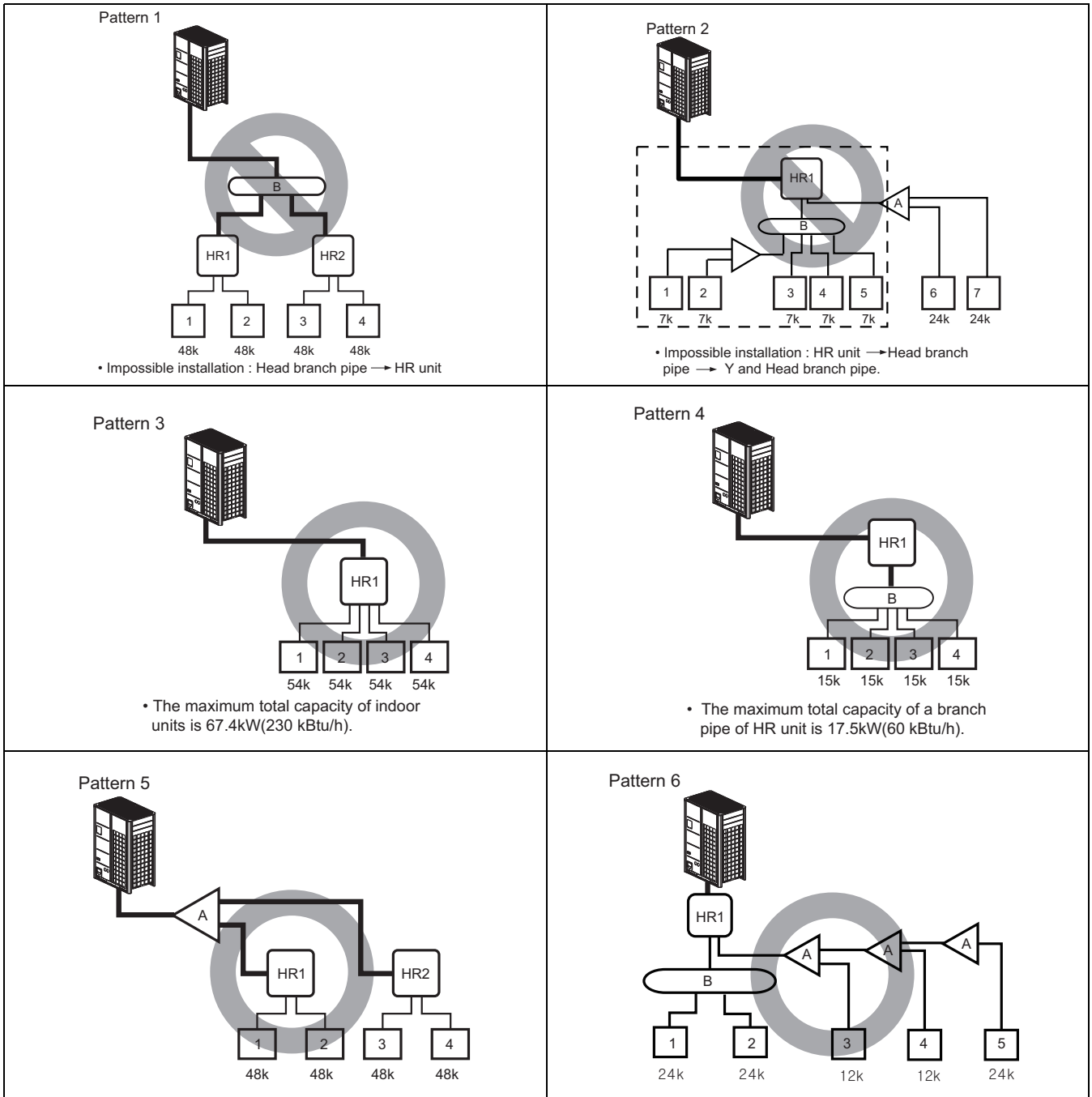

### Note

- If the large capacity(76kBtu/h and 96kBtu/h unit) indoor units are installed, two neighboring outlets of one HR unit are linked by Y branch pipe and connected to one indoor unit.



# 7. Refrigerant piping system

## 7.1.2 Heat Pump System

### ■ Single Outdoor Unit Connection

#### Y branch method

- Ⓐ Outdoor Unit
- Ⓑ 1st branch (Y branch)
- Ⓓ Indoor Units

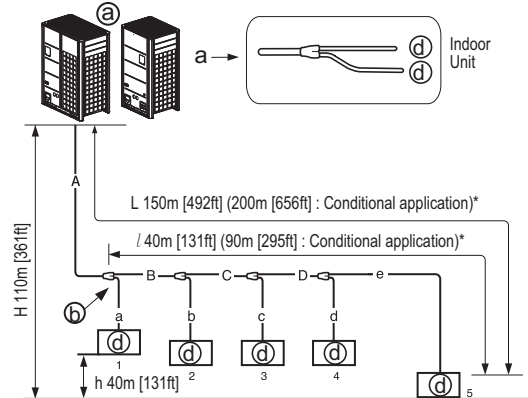

#### Combination of Y branch / header method

- Ⓐ Outdoor Unit
- Ⓑ 1st branch (Y branch)
- Ⓒ Y branch
- Ⓓ Indoor Units
- Ⓔ Header
- Ⓕ Sealed piping

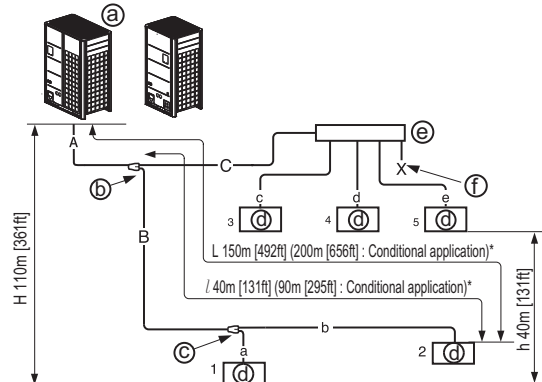

#### Header method

- Ⓐ Outdoor Unit
- Ⓓ Indoor Units
- Ⓔ Header
- Ⓕ Sealed piping

#### ⚠ WARNING

#### Pipe length after header branching

- It is recommended that difference in length of the pipes connected to the indoor units (a~f) is minimized.

Performance difference between indoor units may occur.

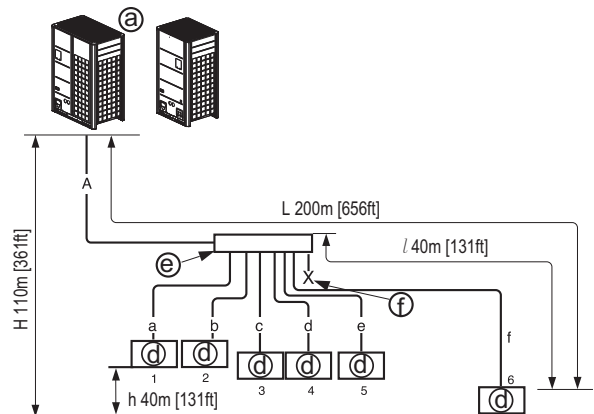

#### ⚠ WARNING

- Branch pipe can not be used after header

## 7. Refrigerant piping system

### Series Outdoor Unit Connection

#### Y branch method

- Ⓐ Outdoor Unit
- Ⓑ 1st branch (Y branch)
- Ⓓ Indoor Units
- Ⓔ Connection branch pipe between outdoor units (ARCNN41)
- Ⓕ Connection branch pipe between outdoor units (ARCNN31)
- Ⓖ Connection branch pipe between outdoor units (ARCNN21)

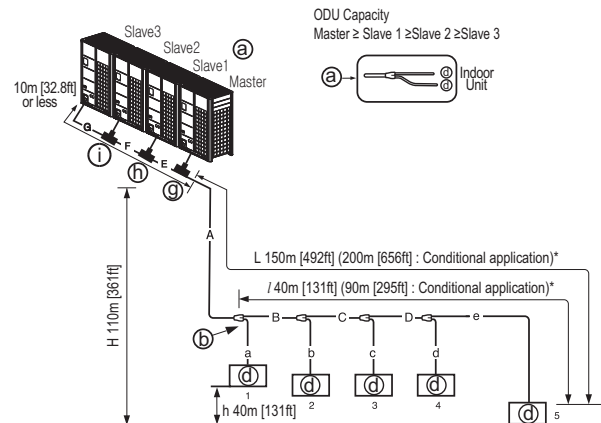

#### Combination of Y branch / header Method

- Ⓐ Outdoor Unit
- Ⓑ 1st branch (Y branch)
- Ⓒ Y branch
- Ⓓ Indoor Units
- Ⓔ Header
- Ⓕ Sealed piping
- Ⓖ Connection branch pipe between outdoor units (ARCNN41)
- Ⓕ Connection branch pipe between outdoor units (ARCNN31)
- Ⓖ Connection branch pipe between outdoor units (ARCNN21)

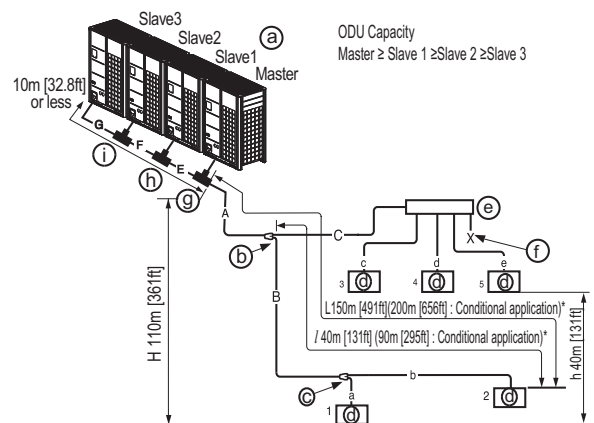

#### Header Method

- Ⓐ Outdoor Unit
- Ⓓ Indoor Units
- Ⓔ Header
- Ⓕ Sealed piping
- Ⓖ Connection branch pipe between outdoor units (ARCNN41)
- Ⓕ Connection branch pipe between outdoor units (ARCNN31)
- Ⓖ Connection branch pipe between outdoor units (ARCNN21)

#### ⚠ WARNING

##### Pipe length after header branching

- It is recommended that difference in length of the pipes connected to the indoor units (a~f) is minimized.

Performance difference between indoor units may occur.

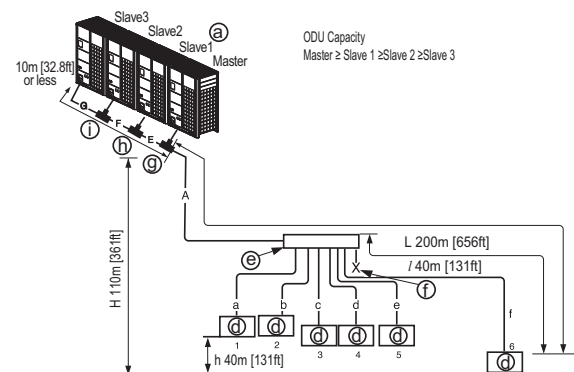

#### ⚠ WARNING

- Branch pipe can not be used after header

➤ Maximum number of connectable units could be different in accordance with model line up of target region.

## 7. Refrigerant piping system

### ■ Limits of pipe length and difference in height

Connection method		Y branch only	Combination of Y branch/header	Header only
Max. pipe length	Longest pipe length (L) : between Outdoor Unit and Indoor Unit	$A+B+C+D+e \leq 150\text{m}$ [492ft] (200m [656ft]**)	$A+B+b \leq 150\text{m}$ [492ft] ) (200m [656ft]**) $A+C+e \leq 150\text{m}$ [492ft] (200m [656ft]**)	$A+f \leq 200\text{m}$ [656ft]
	Longest pipe equivalent length* (L) : between Outdoor Unit and Indoor Unit	175m [574ft] (225m [738ft]**)	175m [574ft] (225m [738ft]**)	225m [738ft]
	Longest pipe length after 1st branch (l)	40m [131ft] (90m [295ft]**)	40m [131ft] (90m [295ft]**)	40m [131ft]
	Total pipe length	1,000m [3,281ft]	1,000m [3,281ft]	1,000m [3,281ft]
Max. difference in height	Difference in height (H) : between Outdoor Unit and Indoor Unit	110m [361ft]	110m [361ft]	110m [361ft]
	Difference in height (h) : between Indoor Unit and Indoor Unit	40m [131ft]	40m [131ft]	40m [131ft]

#### Note

- \* : Assume equivalent piping length of Y branch to be 0.5m (1.64ft), that of header to be 1m (3.28ft), calculation purpose.
- \*\* : To apply Conditional Application

### WARNING

When the any one (or both ) of below conditions are satisfied, the diameter of main pipe (A) must be increased according to below table.

- The equivalent length between outdoor unit and the farthest indoor unit is 90m (295ft) or more (Liquid or Gas pipes are increased in accordance with below table)
- The level difference (Outdoor unit ↔ Indoor unit) is 50m (164ft) or more (Only liquid pipe is increased)

### ■ Refrigerant pipe diameter from outdoor unit to first branch. (A)

Upward Outdoor unit total capacity	Standard Pipe Diameter		Increased Pipe Diameter			
			When equivalent pipe length is 90m(295ft) or more from ODU to farthest IDU		When level difference is 50m or more	
HP	Liquid pipe [mm(inch)]	Gas pipe [mm(inch)]	Liquid pipe [mm(inch)]	Gas pipe [mm(inch)]	Liquid pipe [mm(inch)]	Gas pipe [mm(inch)]
8	Ø 9.52(3/8)	Ø 19.05(3/4)	Ø 12.7(1/2)	Ø 22.2(7/8)	Ø 12.7(1/2)	not increased
10	Ø 9.52(3/8)	Ø 22.2(7/8)	Ø 12.7(1/2)	Ø 25.4(1) *	Ø 12.7(1/2)	not increased
12 ~ 14	Ø 12.7(1/2)	Ø 28.58(1-1/8)	Ø 15.88(5/8)	not increased	Ø 15.88(5/8)	not increased
16	Ø 12.7(1/2)	Ø 28.58(1-1/8)	Ø 15.88(5/8)	Ø 31.8(1-1/4) *	Ø 15.88(5/8)	not increased
18 ~ 22	Ø 15.88(5/8)	Ø 28.58(1-1/8)	Ø 19.05(3/4)	Ø 31.8(1-1/4) *	Ø 19.05(3/4)	not increased
24	Ø 15.88(5/8)	Ø 34.9(1-3/8)	Ø 19.05(3/4)	not increased	Ø 19.05(3/4)	not increased
26 ~ 34	Ø 19.05(3/4)	Ø 34.9(1-3/8)	Ø 22.2(7/8)	Ø 38.1(1-1/2) *	Ø 22.2(7/8)	not increased
36 ~ 60	Ø 19.05(3/4)	Ø 41.3(1-5/8)	Ø 22.2(7/8)	not increased	Ø 22.2(7/8)	not increased
62 ~ 64	Ø 22.2(7/8)	Ø 41.3(1-5/8)	Ø 25.4(1) *	Ø 53.98(2-1/8)	Ø 25.4(1) *	not increased
66 ~ 96	Ø 22.2(7/8)	Ø 53.98(2-1/8)	Ø 25.4(1) *	not increased	Ø 25.4(1) *	not increased

#### Note

- \* : If available on site, select pipe size from the pipe diameter table according to capacity. Otherwise it doesn't need to be increased.
- Model line up could be different in accordance with target region.

## 7. Refrigerant piping system

### ■ Refrigerant pipe diameter from branch to branch (B,C,D)

Downward Indoor Unit total capacity [kW(Btu/h)]	Liquid pipe [mm(inch)]	Gas pipe [mm(inch)]
≤ 5.6(19,100)	Ø6.35(1/4)	Ø12.7(1/2)
< 16.0(54,600)	Ø9.52(3/8)	Ø15.88(5/8)
< 22.4(76,400)	Ø9.52(3/8)	Ø19.05(3/4)
< 33.6(114,700)	Ø9.52(3/8)	Ø22.2(7/8)
< 50.4(172,000)	Ø12.7(1/2)	Ø28.58(1-1/8)
< 67.2(229,300)	Ø15.88(5/8)	Ø28.58(1-1/8)
< 72.8(248,400)	Ø15.88(5/8)	Ø34.9(1-3/8)
< 100.8(344,000)	Ø19.05(3/4)	Ø34.9(1-3/8)
< 173.6(592,500)	Ø19.05(3/4)	Ø41.3(1-5/8)
< 184.8(630,700)	Ø22.2(7/8)	Ø41.3(1-5/8)
≤ 291.2(993,600)	Ø22.2(7/8)	Ø53.98(2-1/8)

### ■ (\*\*) Conditional Application

If the below conditions are satisfied, limit of longest pipe length after 1st branch( *l* ) could be extended by 40m (131ft)→ 90m(295ft).

#### 1. Pipe diameter Size Up

Pipe diameter(only Liquid/low pressure gas pipes) between 1st branch and last branch(HR unit) is increased by one step. If the pipe diameter of B, C3 is same as A, it is not necessary.

: Ø 6.35 → Ø 9.52 → Ø 12.7 → Ø 15.88 → Ø 19.05 → Ø 22.2 → ...

If available on site, select pipe size from the pipe diameter table according to capacity.

Otherwise it doesn't need to be increased.

#### 2. Correction for calculating the total pipe length

When calculating total pipe length, pipe B,C,D length should be calculated twice.

:  $A + B \times 2 + C3 \times 2 + D \times 2 + C1 + C2 + a + b + c + d + e + f + g + i + j + k + l + m + n \leq 1,000\text{m}$  (3,281ft)

#### 3. Indoor unit pipe length

Length of pipe from each indoor unit to the closest HR unit (a, b, c, d, e, f, g, i, j, k, l, m, n) ≤ 40m (131ft).

#### 4. Difference in length between outdoor unit and the farthest or closest indoor unit

[Length of pipe from outdoor unit to the farthest indoor unit 12 (B + C3 + D + k)]

- [Length of pipe from outdoor unit to the closest indoor unit 1 (C1 + a)] ≤ 40m (131ft)



## 7. Refrigerant piping system

### 7.2 Indoor Unit Connection

#### ◆ Indoor Unit connecting pipe from branch (a, b, c, d, e, f)

Indoor Unit capacity [kW(Btu/h)]	Liquid pipe [mm(inch)]	Gas pipe [mm(inch)]
≤ 5.6(19,100)	Ø6.35(1/4)	Ø12.7(1/2)
< 16.0(54,600)	Ø9.52(3/8)	Ø15.88(5/8)
< 22.4(76,400)	Ø9.52(3/8)	Ø19.05(3/4)
≤ 28.0(95,900)	Ø9.52(3/8)	Ø22.2(7/8)

#### ⚠ CAUTION

- Bending radius should be at least twice the diameter of the pipe.
- Bend pipe after 500mm(19.7inch) or more from branch(or header).  
Do not bend U type.  
It may affect performance or result in noise.  
If U type bending is required, the R should be more than 200mm (7.9inch).

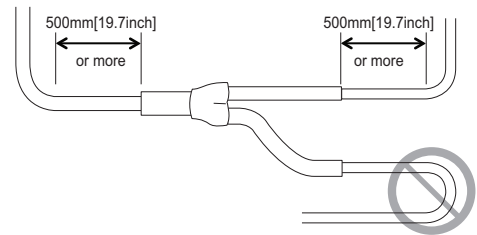



## 7. Refrigerant piping system

### 7.3 Pipe Connection Method/Precautions for Series connections between Outdoor units

- Separate Y branch joints are needed for series connections between outdoor units.
- Please refer to the below connection examples to install pipe connections between outdoor units.

#### 7.3.1 Pipe connection between outdoor units (General Case)

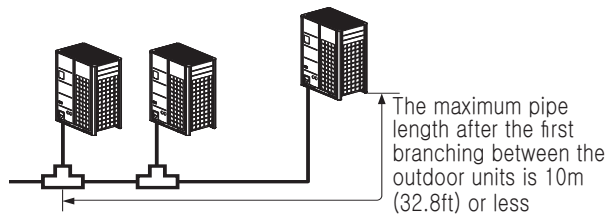

#### 7.3.2 Pipes between outdoor units are 2m(6.6ft) or less

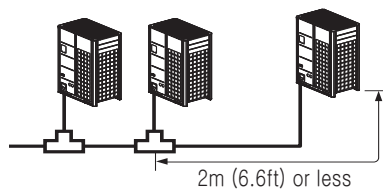

#### 7.3.3 Pipes between outdoor units are 2m(6.6ft) or longer

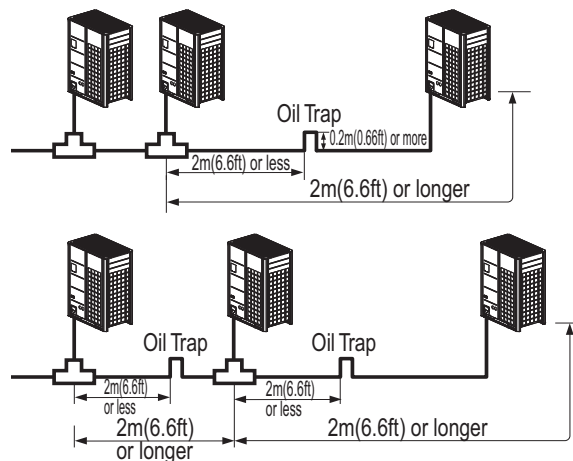

- If the distance between the outdoor units becomes more than 2m(6.6ft), apply Oil Traps between the gas pipes.
- If the outdoor unit is located lower than the main pipe, apply Oil Trap.

## 7. Refrigerant piping system

### 7.3.4 Examples of Wrong Pipe Connections

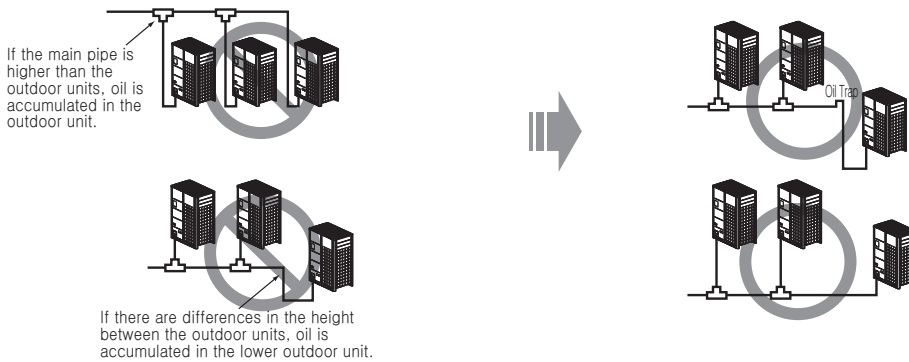

- The pipes between the outdoor units must maintain horizontal levelness or give an inclination to prevent a back flow toward the slave outdoor unit. Otherwise, the unit may not operate properly.

(Example 1)



(Example 2)



(Example 3)



- Apply Oil Trap as shown below when the length of the pipe between the outdoor units is more than 2m(6.6ft). Otherwise, the unit may not operate properly.

(Example 1)

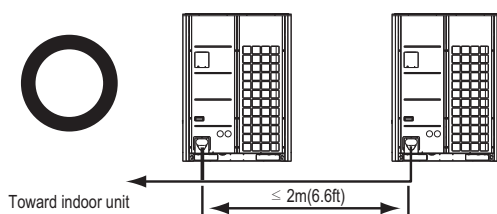

# 7. Refrigerant piping system

(Example 2)

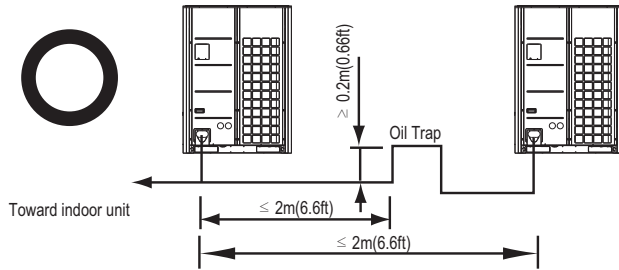

- Install Oil trap if the ODU is at lower level than main piping.
- When connecting the pipes between the outdoor units, the accumulation of oil in the slave outdoor unit should be avoided. Otherwise, the unit may not operate properly.

(Example 1)



(Example 2)

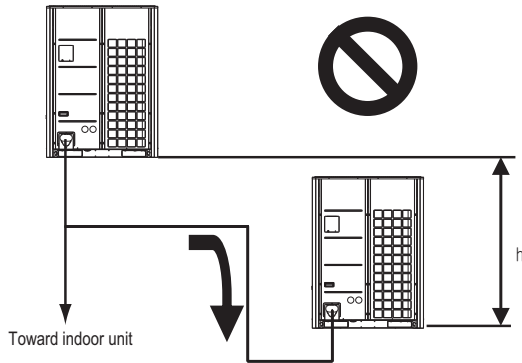

(Example 3)

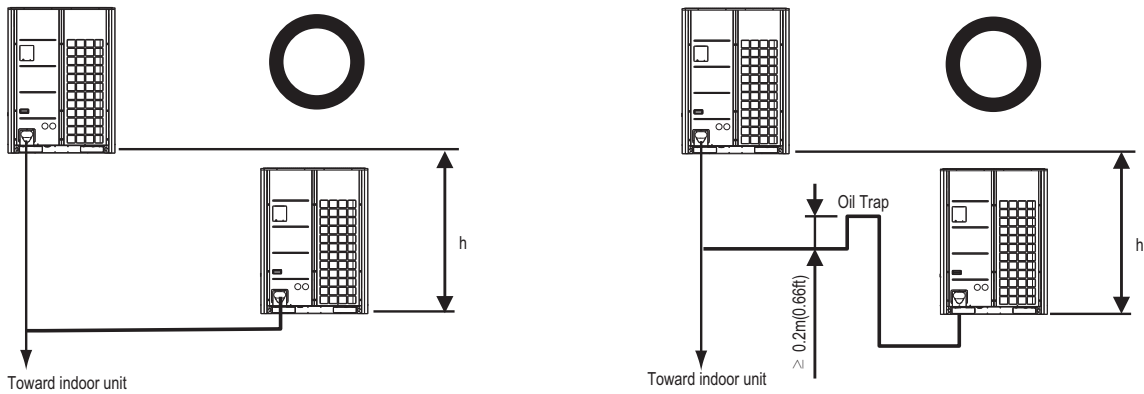

## 7. Refrigerant piping system

### 7.4 The amount of Refrigerant

The calculation of the additional charge should take into account the length of pipe and CF(correctionFactor) value of indoor unit.

Additional charge(kg)	=	Total liquid pipe : Ø25.4mm (1inch)	×	0.480(kg/m)
	+	Total liquid pipe : Ø22.2mm (7/8inch)	×	0.354(kg/m)
	+	Total liquid pipe : Ø19.05mm (3/4inch)	×	0.266(kg/m)
	+	Total liquid pipe : Ø15.88mm (5/8inch)	×	0.173(kg/m)
	+	Total liquid pipe : Ø12.7mm (1/2inch)	×	0.118(kg/m)
	+	Total liquid pipe : Ø9.52mm (3/8inch)	×	0.061(kg/m)
	+	Total liquid pipe : Ø6.35mm (1/4inch)	×	0.022(kg/m)
	+	Number of installed HR units(2,3,4port)	×	0.500(kg)
	+	Number of installed HR units(6,8port)	×	1.000(kg)
	+	CF value of indoor unit(kg/EA)		

#### Note

For CF value (additional refrigerant) table of indoor units, please refer to th PDB of indoor unit.

# 7. Refrigerant piping system

## 7.5 Selection of Y Branch, Header and Reducer

### 7.5.1 Y Branch

#### ■ Heat Recovery System

Models	Low Pressure Gas pipe [unit:mm]	High Pressure Gas pipe [unit:mm]	Liquid pipe [unit:mm]
ARBLB01621			
ARBLB03321			
ARBLB07121			
ARBLB14521			
ARBLB23220			

# 7. Refrigerant piping system

## Heat Pump System

Models	Gas pipe [unit:mm]	Liquid pipe [unit:mm]
ARBLN01621		
ARBLN03321		
ARBLN07121		
ARBLN14521		
ARBLN23220		

# 7. Refrigerant piping system











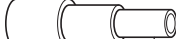

## 7.5.2 Header

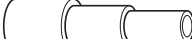
Models	Gas pipe [unit:mm]	Liquid pipe [unit:mm]
4 branch ARBL054		
7 branch ARBL057		
4 branch ARBL104		
7 branch ARBL107		
10 branch ARBL1010		
10 branch ARBL2010		

# 7. Refrigerant piping system

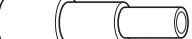
## 7.5.3 Reducer

◆ Reducers for indoor unit and HR unit

Models		Liquid pipe [unit:mm]	Gas pipe [unit:mm]	
			High pressure	Low pressure
Indoor unit reducer		 OD9.52(3/8) Ø6.35(1/4)	-	 OD15.88(5/8) Ø12.7(1/2)
HR unit reducer	PRHR023	 OD9.52(3/8) Ø6.35(1/4)	 OD19.05(3/4) Ø15.88(5/8) Ø12.7(1/2)  OD12.7(1/2) Ø9.52(3/8)	 OD22.2(7/8) Ø19.05(3/4) Ø15.88(5/8)  OD15.88(5/8) Ø12.7(1/2)
	PRHR033 PRHR043 PRHR063 PRHR083	 OD15.88(5/8) Ø12.7(1/2) Ø9.52(3/8)  OD12.7(1/2) Ø9.52(3/8)	 OD22.2(7/8) Ø19.05(3/4) Ø15.88(5/8)  OD15.88(5/8) Ø12.7(1/2)	 OD28.58(1-1/8) Ø22.2(7/8) Ø19.05(3/4)  OD19.05(3/4) Ø15.88(5/8)



## 7. Refrigerant piping system

### 7.6 Distribution Method

#### 7.6.1 Horizontal Distribution

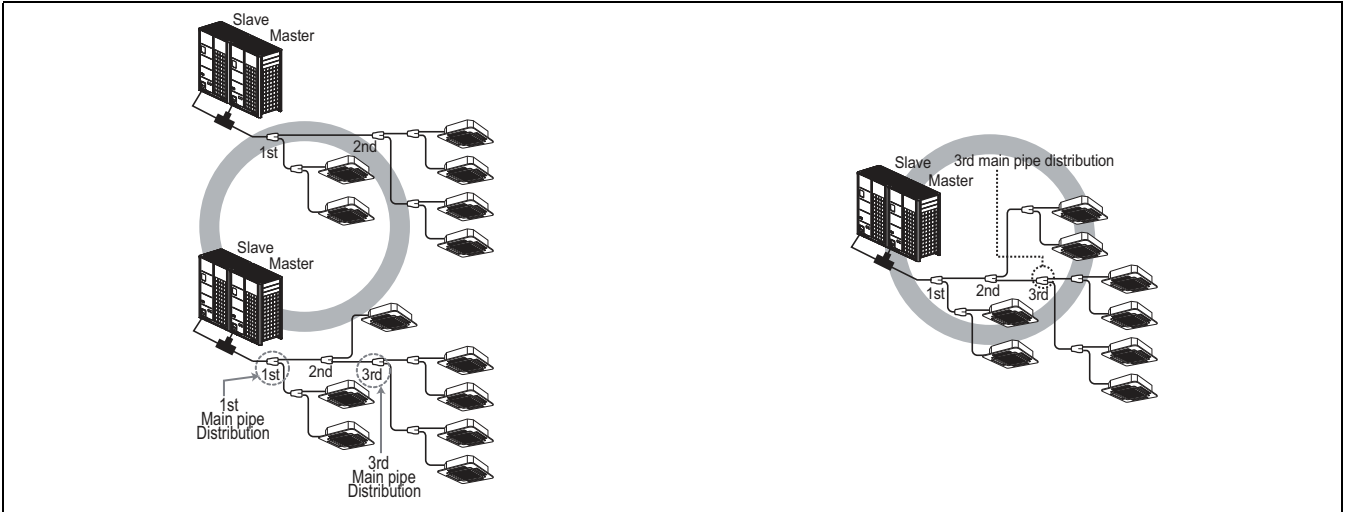

#### 7.6.2 Vertical Distribution

Ensure that the branch pipes are attached vertically.

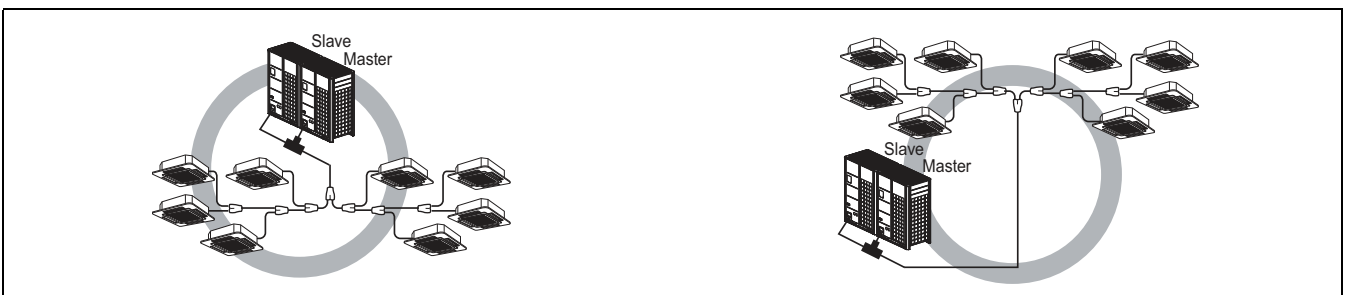

#### 7.6.3 The Others

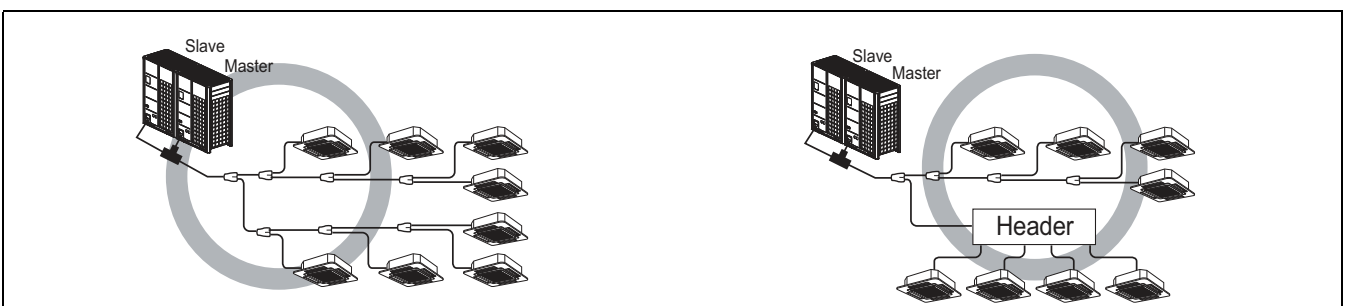

## 8. Electrical Wiring

### 8.1 Electrical Wiring

#### 8.1.1 Caution

1. Follow ordinance of your governmental organization for technical standard related to electrical equipment, wiring regulations and guidance of each electric power company.

#### **CAUTION**

Be sure to have authorized electrical engineers do the electric work using special circuits in accordance with regulations and this installation manual. If power supply circuit has a lack of capacity or electric work deficiency, it may cause an electric shock or fire.

2. Install the Outdoor Unit communication line away from the power source wiring so that it is not affected by electric noise from the power source. (Do not run it through the same conduit.)
3. Be sure to provide designated grounding work to Outdoor Unit.

#### **CAUTION**

Be sure to correct the outdoor unit to earth. Do not connect earth line to any gas pipe, liquid pipe, lightning rod or telephone earth line. If earth is incomplete, it may cause an electric shock.

4. Give some allowance to wiring for electrical part box of Indoor and Outdoor Units, because the box is sometimes removed at the time of service work.
5. Never connect the main power source to terminal block of communication line. If connected, electrical parts will be burnt out.
6. Use 2-core shield cable for communication line. (O mark in the figure below) If communication lines of different systems are wired with the same multiple-core cable, the resultant poor transmitting and receiving will cause erroneous operations. (⊘ mark in the figure below)
7. Only the communication line specified should be connected to the terminal block for Outdoor Unit communication.

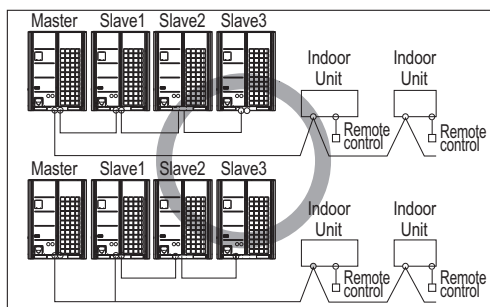

2-Core Shield Cable

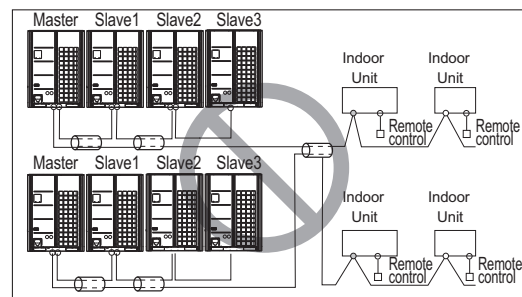

Multi-Core Cable

#### **CAUTION**

- Use the 2-core shield cables for communication lines. Never use them together with power cables.
- The conductive shielding layer of cable should be grounded to the metal part of both units.
- Never use multi-core cable
- As this unit is equipped with an inverter, to install a phase leading capacitor not only will deteriorate power factor improvement effect, but also may cause capacitor abnormal heating. Therefore, never install a phase leading capacitor.
- Make sure that the power unbalance ratio is not greater than 2%. If it is greater the units lifespan will be reduced.

## 8. Electrical Wiring

### ■ Precautions when laying power wiring

Use round pressure terminals for connections to the power terminal block.

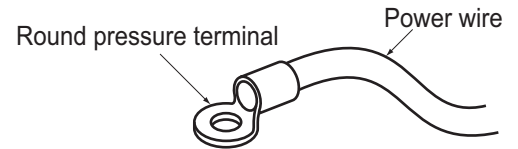

When none are available, follow the instructions below.

- not connect wiring of different thicknesses to the power terminal block. (Slack in the power wiring may cause abnormal heat.)
- When connecting wiring which is the same thickness, do as shown in the figure below.

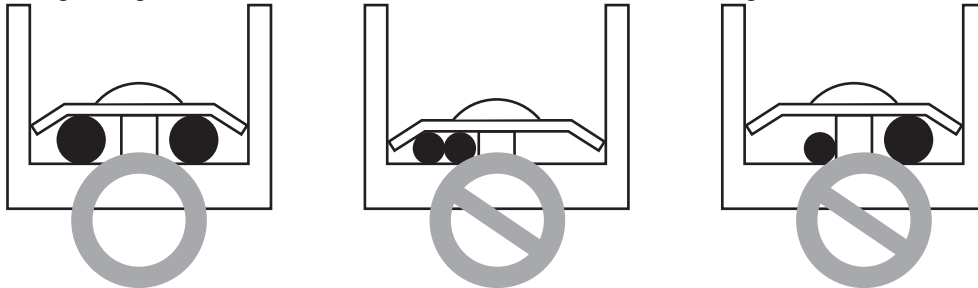

- For wiring, use the designated power wire and connect firmly, then secure to prevent outside pressure being exerted on the terminal block.
- Use an appropriate screwdriver for tightening the terminal screws. A screwdriver with a small head will strip the head and make proper tightening impossible.
- Over-tightening the terminal screws may break them.

### ⚠ CAUTION

When the 400 volt power supply is applied to "N" phase by mistake, replace inverter PCB and transformer in control box.

## 8. Electrical Wiring

### 8.1.2 Control box and connecting positioning of wiring

- Remove all of the screws at front panel and remove the panel by pulling it forward.

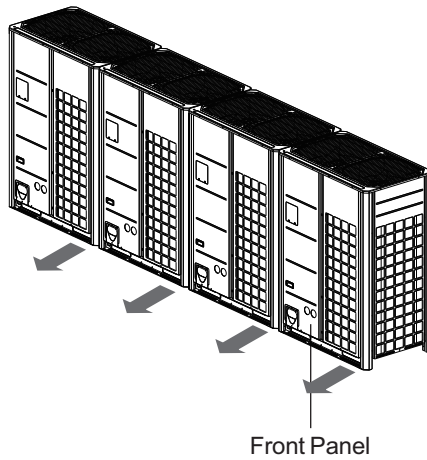

- Connect communication line between main and sub outdoor unit through the terminal block.
- Connect communication lines between outdoor unit and indoor units through the terminal block.
- When the central control system is connected to the outdoor unit, a dedicated PCB must be connected between them.
- When connecting communication line between outdoor unit and indoor units with shielded wire, connect the shield ground to the earth screw.

#### **WARNING**

The temperature sensor for outdoor air should not be exposed to direct sunlight.

- Provide an appropriate cover to intercept direct sunlight.

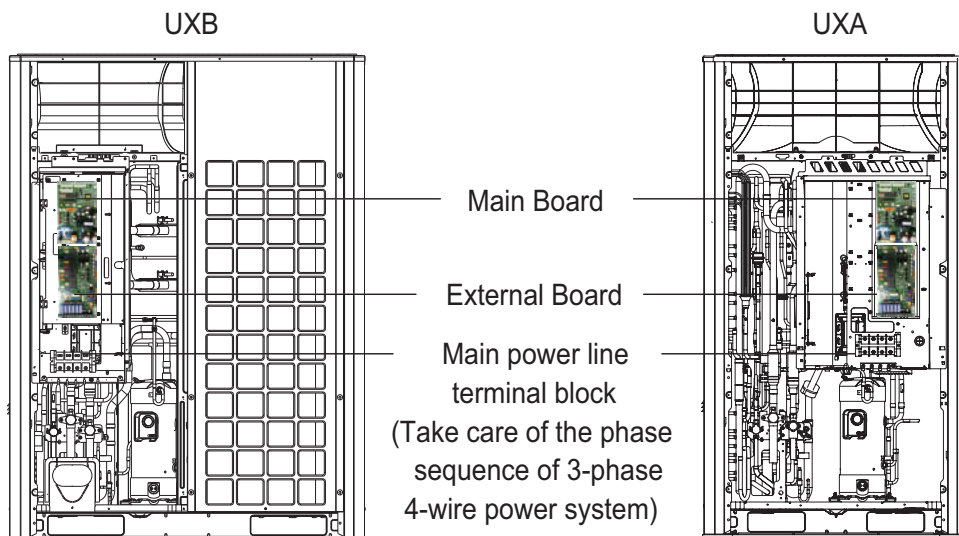

## 8. Electrical Wiring

### 8.1.3 Communication and Power Lines

#### 1. Communication cable

- Types : shielded cables
- Use wires of size : over 1.0 ~ 1.5 mm<sup>2</sup> ( $1.55 \times 10^{-3} \sim 2.32 \times 10^{-3} \text{ in}^2$ )
- Maximum allowable temperature: 60°C (140°F)
- Maximum allowable line length: under 1 000m (3 281 ft)

#### 2. Remote control cable

- Types : 3-core cable

#### 3. Central control cable

Product type	Wire type	Diameter
ACP&AC Manager	2-core cables (shielded)	1.0 ~ 1.5 mm <sup>2</sup> ( $1.55 \times 10^{-3} \sim 2.32 \times 10^{-3} \text{ in}^2$ )
AC Smart	2-core cables (shielded)	1.0 ~ 1.5 mm <sup>2</sup> ( $1.55 \times 10^{-3} \sim 2.32 \times 10^{-3} \text{ in}^2$ )
Simple central controller	4-core cables (shielded)	1.0 ~ 1.5 mm <sup>2</sup> ( $1.55 \times 10^{-3} \sim 2.32 \times 10^{-3} \text{ in}^2$ )
AC Ez	4-core cables (shielded)	1.0 ~ 1.5 mm <sup>2</sup> ( $1.55 \times 10^{-3} \sim 2.32 \times 10^{-3} \text{ in}^2$ )

#### 4. Separation of communication and power lines

- If communication and power lines are installed alongside each other then there is a strong likelihood of operational faults developing due to interference in the signal wiring caused by electrostatic and electromagnetic coupling.

The tables below indicates our recommendation as to appropriate spacing of communication and power lines where these are to be run side by side

Current capacity of power line	Spacing	
100V or more	10A	300mm (11-13/16 in)
	50A	500mm (19-11/16 in)
	100A	1 000mm (39-3/8 in)
	Exceed 100A	1 500mm (59-1/16 in)

#### Note

1. The figures are based on assumed length of parallel cabling up to 100 m(328 ft). For length in excess of 100 m(328 ft) the figures will have to be recalculated in direct proportion to the additional length of line involved.
2. If the power supply waveform continues to exhibit some distortion the recommended spacing in the table should be increased.
  - If the lines are laid inside conduits then the following point must also be taken into account when grouping various lines together for introduction into the conduits
  - Power lines(including power supply to air conditioner) and signal lines must not be laid inside the same
  - In the same way, when grouping the lines power and signal lines should not be bunched together.

#### CAUTION

- If apparatus is not properly earthed then there is always a risk of electric shock, the grounding of the apparatus must be carried out by a qualified person.

## 8. Electrical Wiring

### 8.2 DIP Switch Setting

#### 8.2.1 Checking according to dip switch setting

You can check the setting values of the Master outdoor unit from the 7 segment LED. The dip switch setting should be changed when the power is OFF.

#### 8.2.2 Checking the setting of the Master unit

The number is sequentially appeared at the 7 segment in 5 seconds after applying the power. This number represents the setting condition.

- Initial display order

Order	No	Mean
①	8 ~ 24	Master model capacity
②	10 ~ 24	Slave 1 model capacity
③	10 ~ 24	Slave 2 model capacity
④	10 ~ 24	Slave 3 model capacity
⑤	8 ~ 96	Total capacity
⑥	3	Heat Pump (Factory setting)
⑦	38	380V model
	46	460V model
	22	220V model
⑧	30	Product type

#### ◆ Main PCB

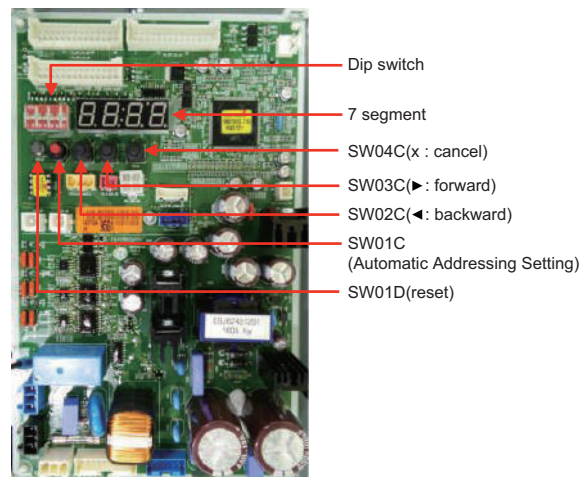

- Example) 74HP 380V Heat Pump system

(Master unit: 24HP, Slave 1: 24HP, Slave 2: 14HP, Slave 3: 12HP)

①	②	③	④	⑤	⑥	⑦	⑧
24	24	14	12	74	3	38	30

#### Note

- Example of model names could be different with model names included within this PDB.
- In accordance with the number of combined outdoor unit or target region, it could not be applied to set the order ③,④.

#### ⚠ CAUTION

Product may not properly operate if the relevant DIP switch is not properly setup.

## 8. Electrical Wiring

### ■ Master / Slave Dip Switch Setting

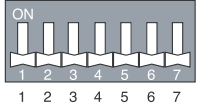
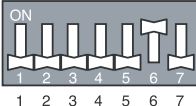
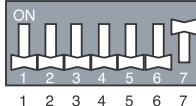
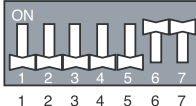
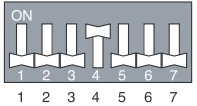
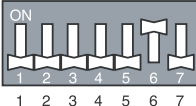
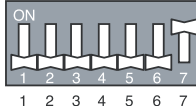
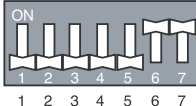
Dip switch setting	Master/Slave Unit			
	Master	Slave		
		Slave1	Slave2	Slave3
Heat Pump System (Factory setting)				
Heat Recovery System (Installer setting)				

### **Important**

#### How to setting Heat Recovery system

1. Turn on the dip s/w No. 4.
2. The factory setting display is appeared "HP".
3. Change "HP" into "HR" display pushing ► button and then push confirm button.
4. Turn off dip s/w No. 4 and push reset button to restart the system.  
(If you turn on the dip s/w No. 4, you can make sure "HR" or "HP" display later.)

## 8. Electrical Wiring

### 8.3 HR Unit PCB (For Heat Recovery System)

#### ◆ Switch for setup of HR Unit

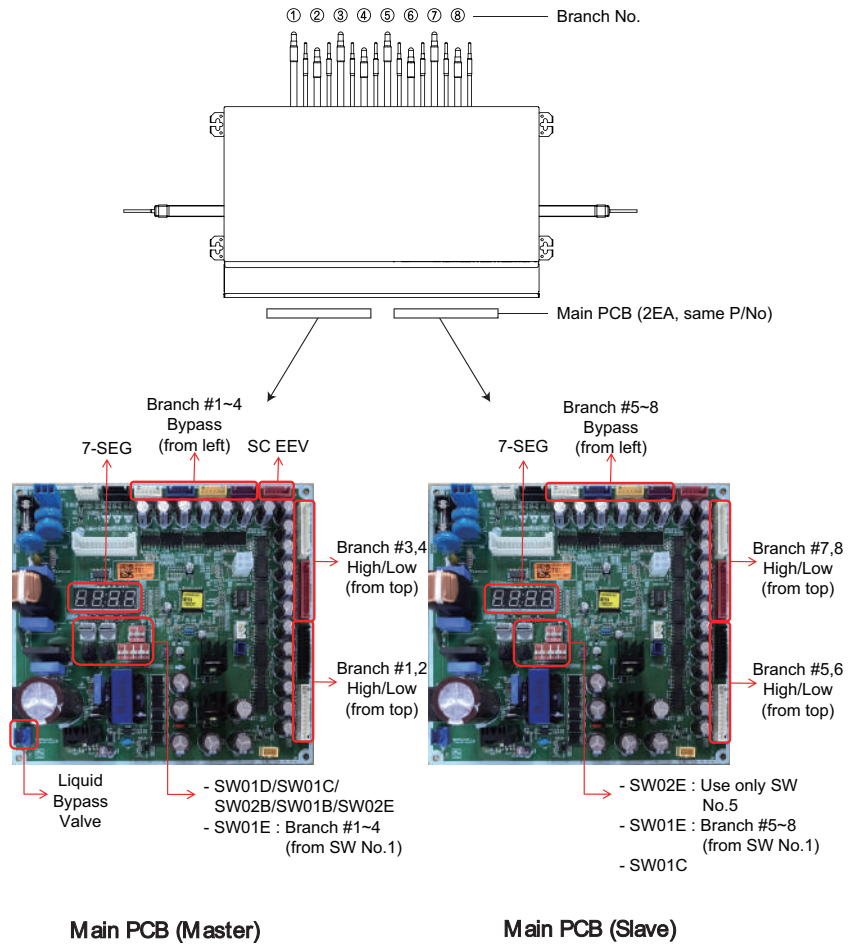

#### 8.3.1 Setup the switch of HR Unit

##### ■ Setup the switch of HR Unit

	S/W	Function
Dip SW		SW02E (8pin Dip SW) Selection of the method for pipe detection Selection of Master/Slave Main PCB Setting the Zoning Control Selection of the No. of connected branches
No.2		SW01E (4pin Dip SW) Selection of the valve to address
No.3		SW01D (Left) Selection of the Valve Group Control Setting to address HR units
No.4		SW01C (Right) Manual addressing of zoning indoor units
No.5		SW02B (Left) Increase in the digit of 10
No.6		SW01B (Right) Increase in the digit of 1



# 8. Electrical Wiring

## ■ Main function of SW02E

ON S/W	Selection
No.1	Method for pipe detection of an HR unit (Auto/Manual)
No.2	No. of connected branches
No.3	
No.4	
No.5	Master/Slave (Main PCB) Setting
No.6	EEPROM factory initialization (4,5,6)
No.7	Use only in factory production (preset to "OFF"), Zoning setting ("ON")
No.8	Use only in factory production (preset to "OFF"), Zoning setting ("ON")

### 1. Selection of the method for pipe detection of an HR unit (Auto/Manual)

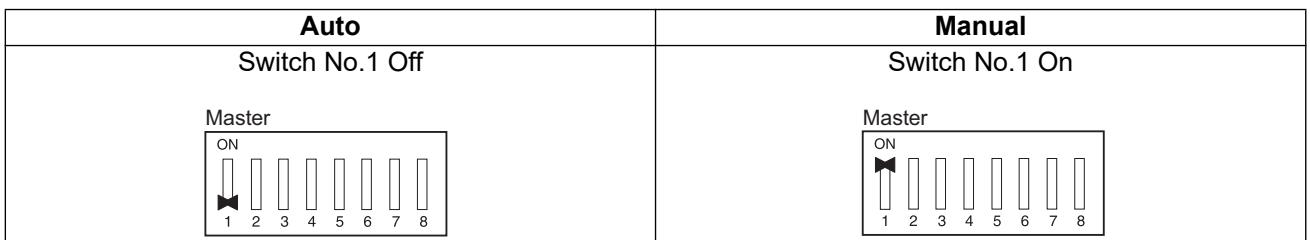

### 2. Selection of Master/Slave Main PCB

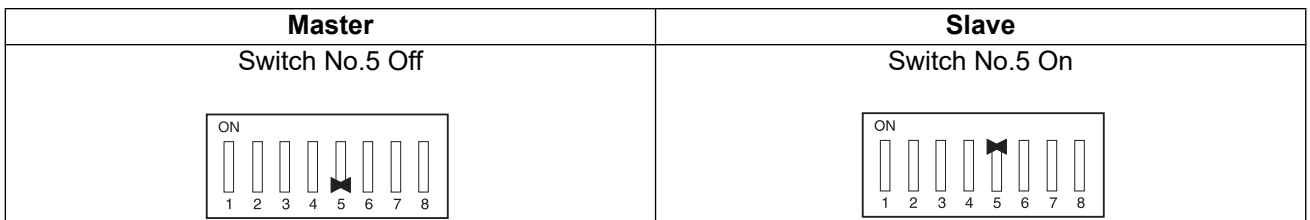

### Note

Do not turn on any SW02E on Slave Main PCB except No.5.



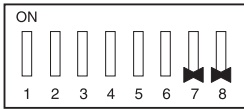
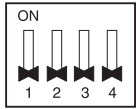
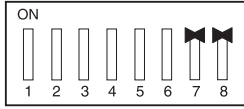
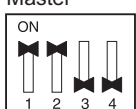

# 8. Electrical Wiring

## 3. Setting the zoning control

	SW02E setting	SW01E setting
Normal control	<p>Master</p> 	 <p>SW01E</p>
Zoning control	<p>Master</p> 	<p>Turn the dip switch of the zoning branch on. EX) Branch 1,2 are zoning control.</p> <p>Master</p>  <p>SW01E</p>

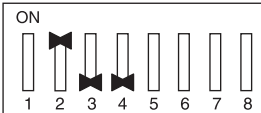
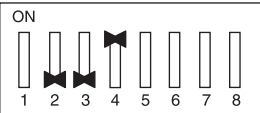
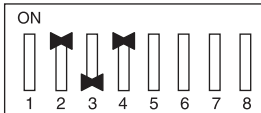
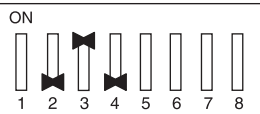
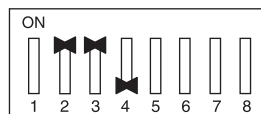
## 4. Selection of the No. of connected branches

1 branch Connected		5 branches Connected	
2 branches Connected		6 branches Connected	
3 branches Connected		7 branches Connected	
4 branches Connected		8 branches Connected	

\* Each model is shipped with the switches No.2, 3, 4 pre-adjusted as above in the factory.

### WARNING

If you want to use a "Model" for "No. of using branch(es)" HR Unit after closing the "Closing pipe No.", set the dip switch for "No. of using branch(es)" HR Unit.

Ex) If you want to use a PRHR083 for 4 branches HR Unit after closing the 5~8th pipes, set the dip switch for 4 branches HR Unit.

## 8. Electrical Wiring

### ■ SW01D (Rotary S/W for addressing HR unit)

Use the Valve Group Control when 2 branches are connected with only 1 indoor unit which has higher capacity than 61 kBtu/h.

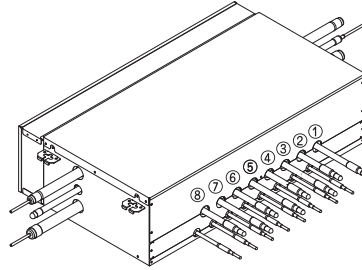

Valve Group	SW01D Setting	Valve Group	SW01D Setting
Not control	0	No. 5,6/7,8 Valve Control	8
No. 1,2 Valve Control	1	No. 1,2/5,6 Valve Control	9
No. 2,3 Valve Control	2	No. 1,2/7,8 Valve Control	A
No. 3,4 Valve Control	3	No. 3,4/5,6 Valve Control	B
No. 5,6 Valve Control	4	No. 3,4/7,8 Valve Control	C
No. 6,7 Valve Control	5	No. 1,2/3,4/5,6 Valve Control	D
No. 7,8 Valve Control	6	No. 1,2/3,4/6,7 Valve Control	E
No. 1,2/3,4 Valve Control	7	No. 1,2/3,4/7,8 Valve Control	F

#### Note

If the large capacity indoor units are installed, below Y branch pipe should be used.

#### ◆ Y branch pipe

Models	Gas pipe [Unit : mm]	Liquid pipe [Unit : mm]
ARBLN03321		

# 8. Electrical Wiring

## SW01C (Rotary S/W for addressing HR unit)

Must be set to '0' when installing only one HR unit.

When installing multiple HR units, address the HR units with sequentially increasing numbers starting from '0'.



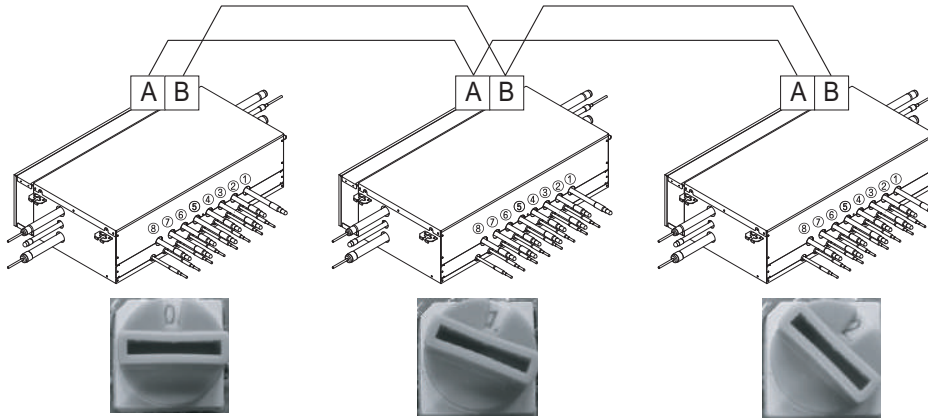

Maximum 16 HR Units can be installed.

Example) Installation of 3 HR units

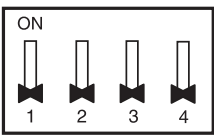

## SW01B/SW01C/SW01E/SW02B (Dip S/W and push S/W for manual pipe detection)

- Set the address of the valve of the HR unit to the central control address of the connected indoor unit.
- SW01E : selection of the valve to address  
 SW02B : increase in the digit of 10 of valve address  
 SW01B : increase in the last digit of valve address  
 SW01C : Manual addressing of zoning indoor units (use for Zoning setting)
- Prerequisite for manual pipe detection : central control address of each indoor unit must be preset differently at its wired remote control.

 SW01E	S/W No.	Setup
		No.1
	No.2	Manual addressing of valve #2 (Master) / #6 (Slave)
	No.3	Manual addressing of valve #3 (Master) / #7 (Slave)
	No.4	Manual addressing of valve #4 (Master) / #8 (Slave)
 SW02B	SW02B	Increase in the digit of 10 of valve address
 SW01B	SW01B	Increase in the last digit of valve address
* Use for Zoning setting  SW01C	SW01C	Manual addressing of zoning indoor units

# 8. Electrical Wiring

## 1. Normal setting (Non-Zoning setting)

ex) Manual pipe detection of Valve #1, 6.

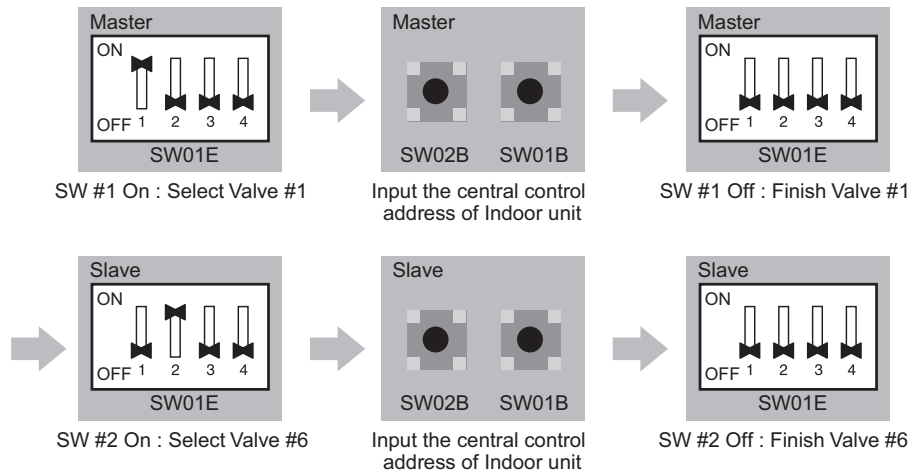

## 2. Zoning setting

### Note

Use the Zoning Control when install two or more indoor units at 1 branch of HR Unit.

The indoor units controlled by Zoning Control can be selected collectively as the cooling/heating mode.

ex) Manual pipe detection of Valve #5 with three zoning indoor units, #6 without zoning unit.

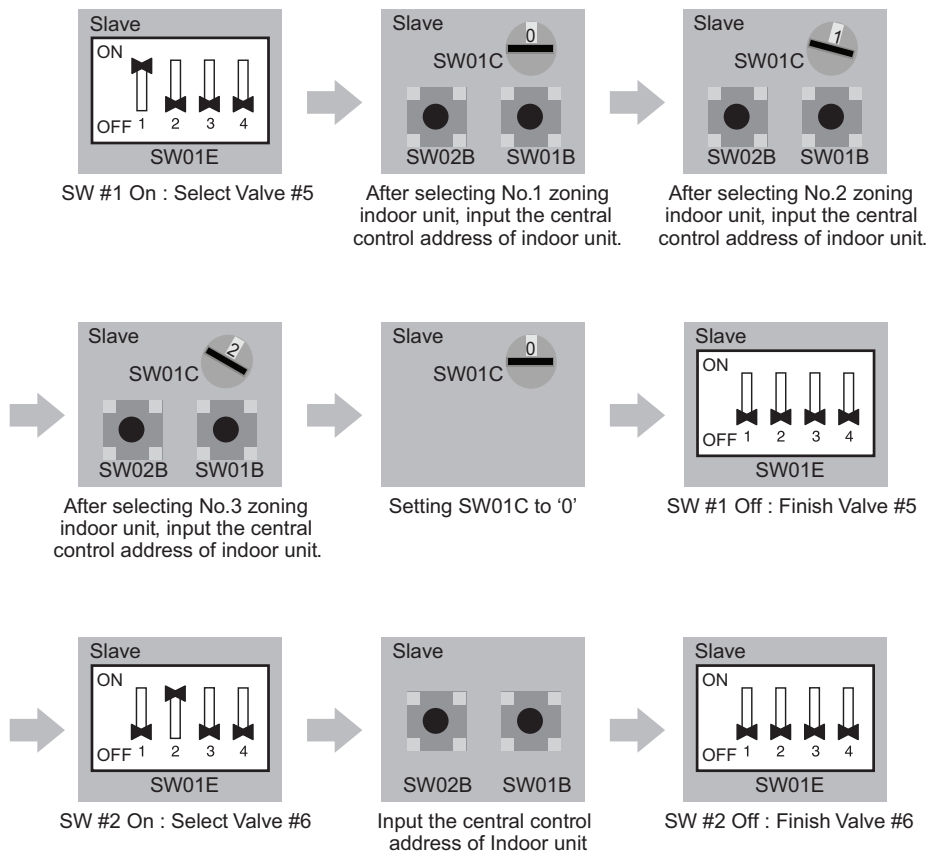

## 8. Electrical Wiring

### 8.4 Automatic Addressing

#### ■ The address of indoor units would be set by auto addressing

1. Wait for 3 minutes after supplying power. (Master and Slave outdoor units, indoor units)
2. Press RED button of the outdoor units for 5 seconds. (SW01C)
3. A "88" is indicated on 7-segment LED of the outdoor unit PCB.
4. For completing addressing, 2~7 minutes are required depending on numbers of connected indoor units
5. Numbers of connected indoor units whose addressing is completed are indicated for 30 seconds on 7-segment LED of the outdoor unit PCB
6. After completing addressing, address of each indoor unit is indicated on the wired remote control display window. (CH01, CH02, CH03, ....., CH06 : Indicated as numbers of connected indoor units)

#### ◆ Main PCB

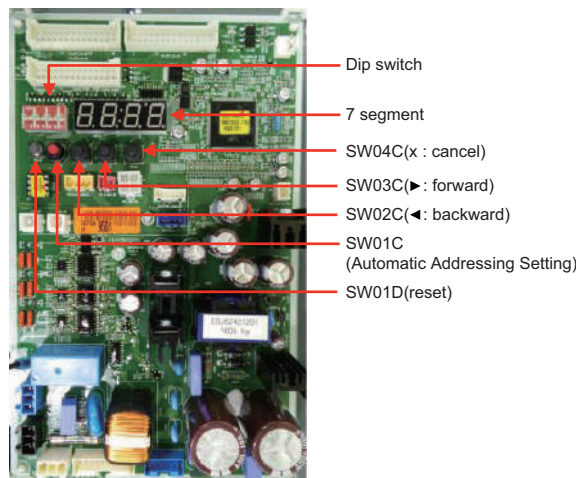

#### ⚠ CAUTION

- In replacement of the indoor unit PCB, always perform Auto addressing setting again (At that time, please check about using Independent power module to any indoor unit.)
- If power supply is not applied to the indoor unit, operation error occur.
- Automatic Addressing has to be performed after more than 3 minutes to improve indoor unit communication when initial power is supplied.
- Please be sure that all the dip switch (1~7) of master outdoor unit is OFF before Automatic Addressing setting.

## 8. Electrical Wiring

### ◆ The Procedure of Automatic Addressing

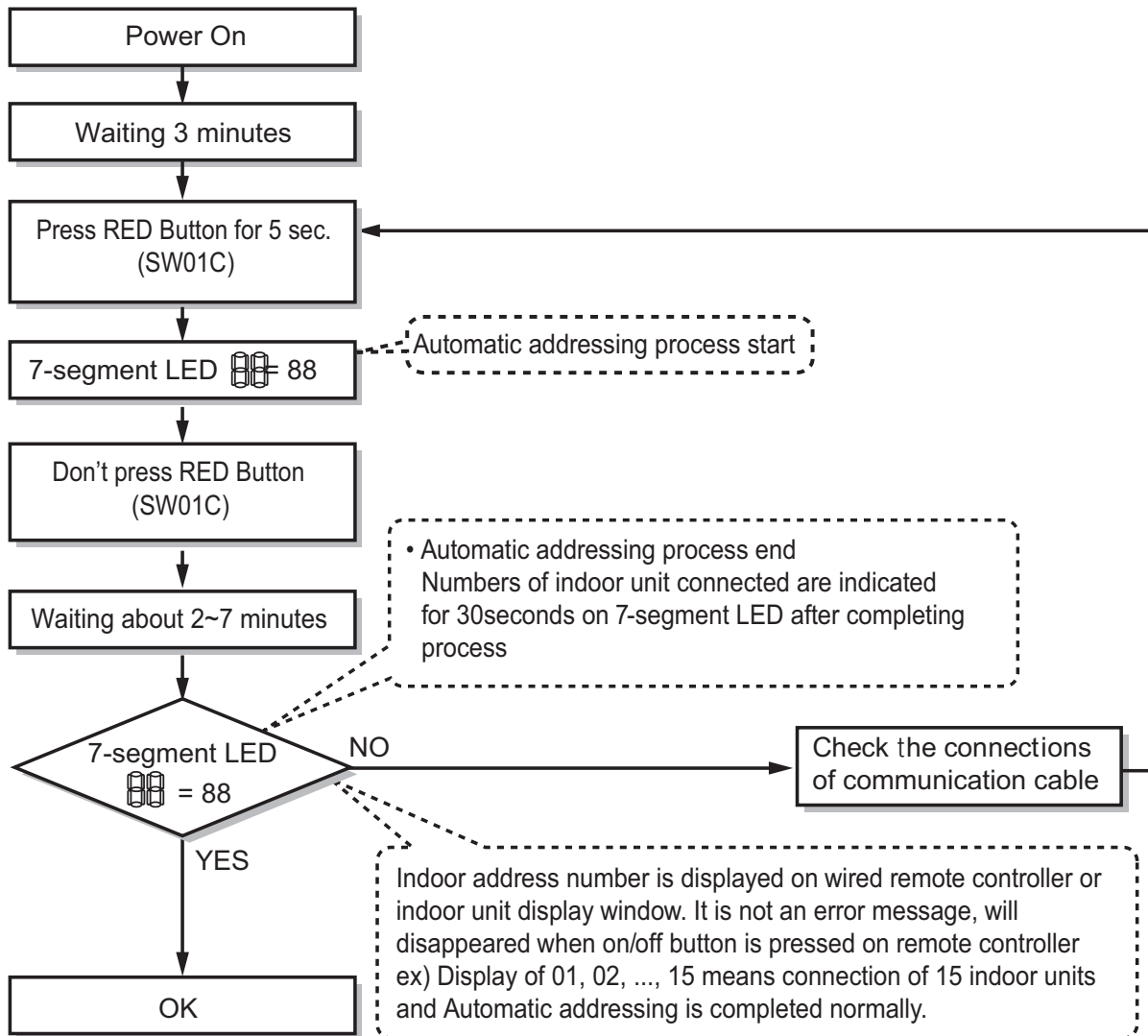

## 8. Electrical Wiring

### ■ Automatic pipe detection(For Heat Recovery System)

1. Turn No.1 dip switch of SW02E of HR unit PCB off.
2. Confirm that the setting of No.2, 3, 4 of SW02E corresponds with the type of the valve connection.
3. Reset the power of HR unit PCB
4. Master outdoor unit PCB DIP switch on : No.5
5. Select the mode using '▶', '◀' Button : "Idu" Push the '●' button
6. Select the "Id 5" function using '▶', '◀' Button : "Ath" or "Atc" Push the '●' button.  
Outdoor temperature is over 15°C(59°F) : "Ath" Using (If it fail, use "Atc")  
Outdoor temperature is below 15°C(59°F) : "Atc" Using (If it fail, use "Ath")
7. Select the mode using '▶', '◀' Button : "Idu" Push the '●' button
8. Select the "Id 6" function using '▶', '◀' Button : "StA" Push the '●' button
9. System is operated after "88" is displayed on 7-SEG of the outdoor unit main PCB.
10. Pipe detection process is proceeded.
11. 5~30 minutes are required depending on the number of the indoor units and outdoor temperature.
12. The number of the indoor units connected is displayed on 7-SEG of the outdoor unit main PCB for about 1 minute
  - For a HR unit, the number of the indoor units connected to each HR unit is displayed.
  - '200' is displayed in case of auto pipe detecting error, and auto pipe detection process is completed when after "88" is disappeared.

### CAUTION

- **Execute auto addressing and auto pipe detection again whenever the indoor PDB and HR unit PCB is replaced.**
  - **Operation error occurs unless power is supplied to the indoor and HR units.**
- **Error No.200 occurs if the number of connected indoor units and that of scanned indoor units are different.**
- **If auto pipe detection process fails, complete it with manual pipe detection (see Manual pipe detection part).**
- **If auto pipe detection process is completed normally, manual pipe detection is not required.**
- **If you want to do auto pipe detection again after auto pipe detection fails, do after reset of outdoor unit by all means.**
- **During 5 minutes after pipe detection is completed, do not turn off the main unit PCB to save the result of pipe detection automatically.**



## 8. Electrical Wiring

### ◆ Flow chart of auto pipe detection process

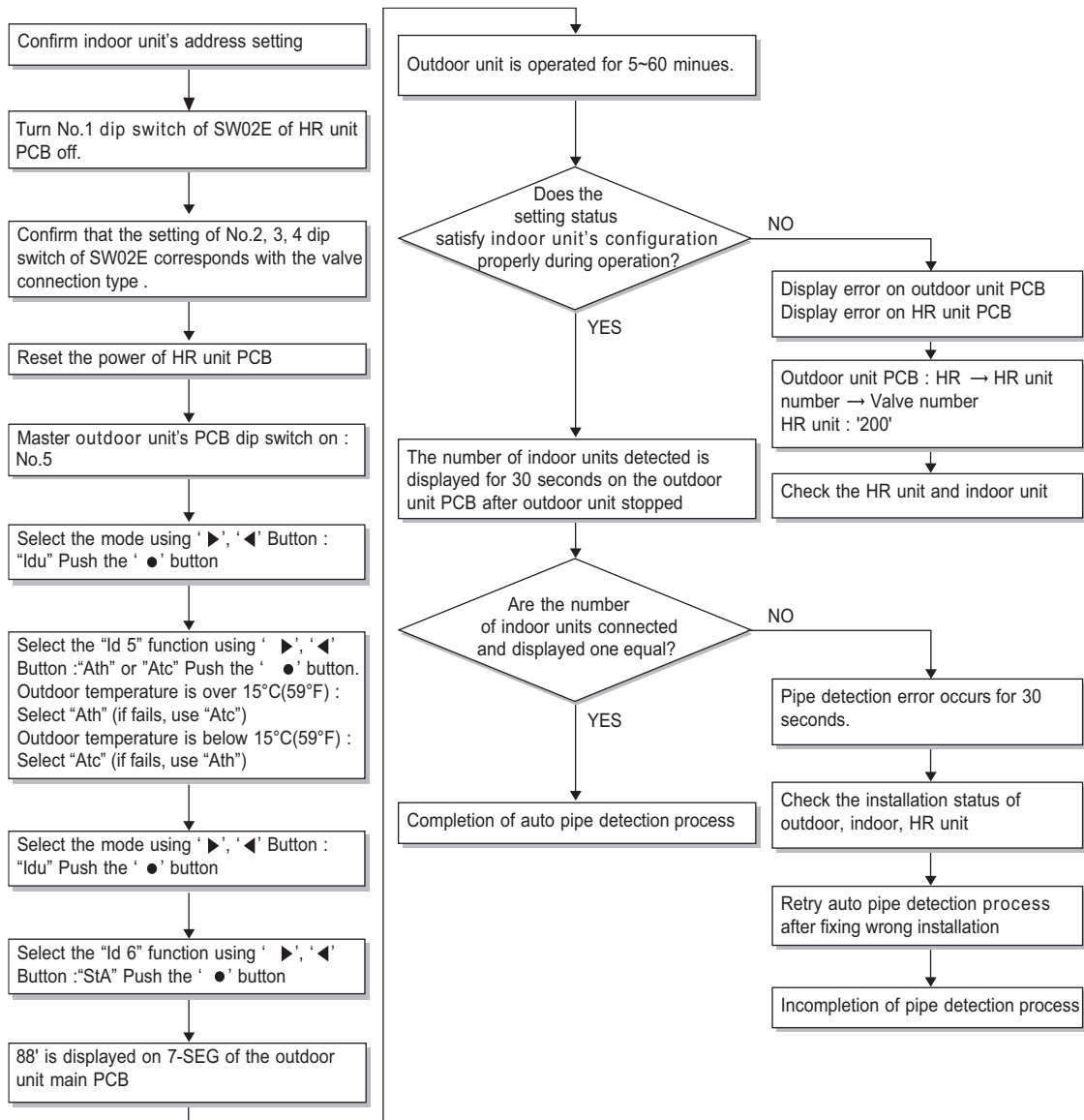

\* It is possible to be generated mode changing noise of heating and cooling which is normal.  
There is no mode changing noise at normal operation.

## 8. Electrical Wiring

### Manual pipe detection

1. Enter the central control address into each indoor unit using its wired remote controller.
2. Turn No.1 dip switch of SW02E of HR unit PCB on.
3. Reset the power of HR unit PCB.
4. On the HR unit PCB, manually set address of each valve of the HR unit to the central control address of the indoor unit connected to the valve.
5. Reset the power of outdoor unit PCB.
6. The number of the indoor unit installed is displayed after about 5 minutes.  
Ex) HR → The number of the indoor
7. Reset the power of outdoor unit PCB, HR unit.
8. Manual pipe detection is completed

### CAUTION

- In case that central controller is not installed, firstly set up central controller's setting to make address setting of indoor units.
- In case that central controller is installed, please set central control address of indoor units by using wired remote controller.
- HR units's manual pipe address is set by the central control address of indoor units.
- Address of valve which is not connected with indoor unit should be set differently with the address of a valve which is indoor unit connected.  
(If address is overlapped, valve will not work properly)
- If there occurs some error during pipe detection process, it means pipe detection process is not properly finished.
- During 5 minutes after pipe detection process is completed, do not turn off the main outdoor unit's PCB to save the result of pipe detection automatically.

### Flow chart of manual addressing for pipe detection

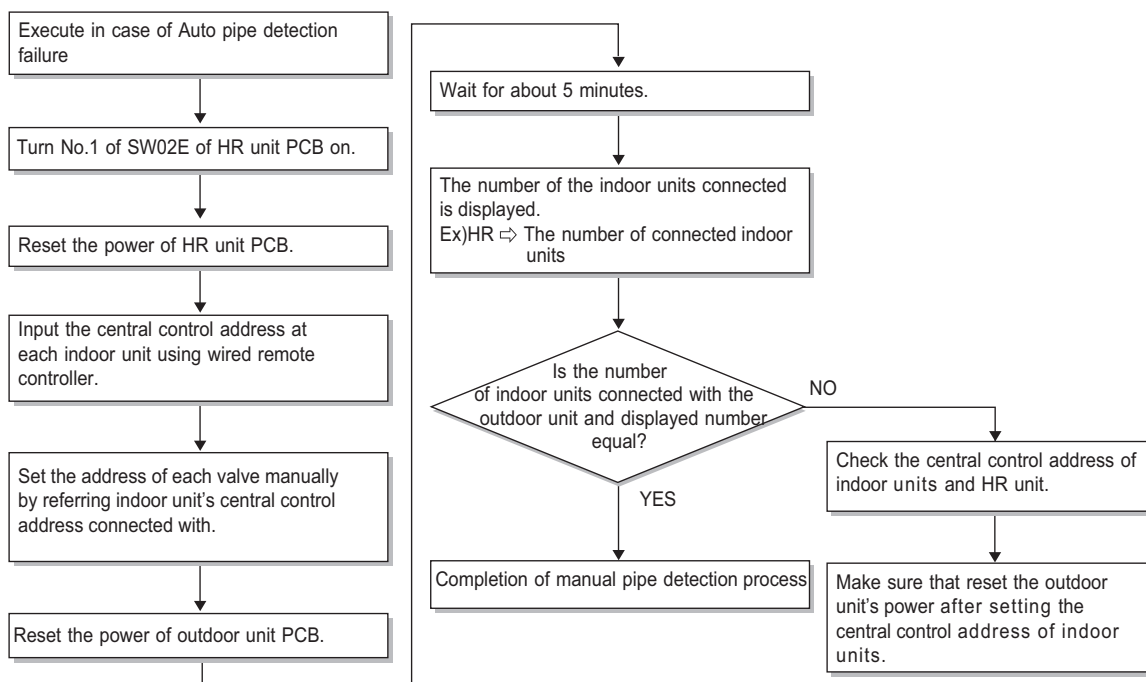

### Note

If you need to more information of Addressing method, please refer to the Installation Manual.

## 9. Setting the function

### 9.1 Function List

MODE	Display	Function	Description
Func	Fn1	Cool & Heat Selector	Set when Cool & Heat Selector is connected
	Fn2	High Static pressure compensation	Function for increasing outdoor fan speed, when using duct's
	Fn3	Night low noise	In the middle of the night time, reduces the Fan rpm to reduce the noise from the outdoor unit fan
	Fn4	Overall defrost	Set for only using Overall Defrost (not applying Partial Defrost)
	Fn5	ODU address	Address for monitoring cycle view with LG control solutions
	Fn6	Snow removal & rapid defrost	Function for snow removal and rapid defrost function
	Fn7	IDU capacity adjusting	Decrease airflow of IDU in case of shortage of heating capacity
	Fn8	Target pressure adjusting	Adjust High/Low pressure target
	Fn9	Low Ambient Kit	Function for controlling Low Ambient Kit I/O Module *Low Ambient Kit : Kit for cooling operation at low temperature(-20 ℃)
	Fn10	High Efficiency Mode (Cooling Operation)	Adjust low pressure target according to outdoor temperature
	Fn11	Auto Dust Removal	Function for blowing dust on heat exchanger
	Fn12	Compressor frequency limitation	Max compressor frequency limitation
	Fn13	ODU fan limitation	Max fan RPM limitation
	Fn14	Smart load control	Adjust high pressure target for heating and low pressure target for cooling according to outdoor temperature to optimize energy input.
	Fn16	Humidity Reference	Adjust high pressure target according to humidity to optimize energy input
	Fn19	Central Control Connection at Indoor Unit side	For AC EZ use only. Connectable to comm. Line between ODU and IDU. * Do not use with other central controller (ACP, AC SAMART etc.)
	Fn20	Compressor Input Current Limit	Max input current limitation. 50~100% can be selected
	Fn21	Power Consumption Display on wired remote controller	Display Power Consumption on wired remote controller
	Fn22	Overall Defrost Operating in Low temperature (Heating)	Perform overall defrost periodically in low temperature to increase heating performance
	Fn23	Optional Base panel Heater	Set when base panel heater is installed

\* The functions shown in the table above could be applicable depending on the model line up.

\* For details, refer to installation manual and service manual(General).

## 9. Setting the function

### 9.2 Dip Switch Setting

Select the mode/function/option/value using '▶', '◀' Button and confirm that using the '●' button after dip switch No.5 is turned on.

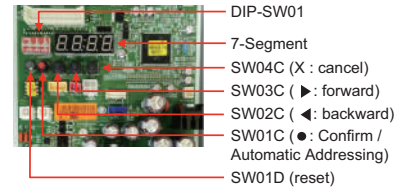
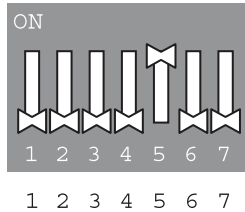

Optional Mode Selection		Function Selection		Option Selection		Remarks
Content	Display (◎)	Content	Display (◀, ▶ ◎)	Default	Optional (◀, ▶ ◎)	
FDD	Fdd	Automatic Refrigerant Charging (Cooling)	Fd1	-	-	-
		Automatic Refrigerant Charging (Heating)	Fd2	-	-	-
		Refrigerant Amount Check (Cooling)	Fd3	-	-	-
		Refrigerant Amount Check (Heating)	Fd4	-	-	-
		Automatic	Fd7	-	-	-
		All IDU operation (Cooling)	Fd8	-	-	Compulsory Operation
		All IDU operation (Heating)	Fd9	-	-	for 1hour
Installation	Func	Cool & Heat Selector	Fn 1	oFF	oFF, oP1~oP2	save in EEPROM
		High Static Pressure compensation	Fn 2	oFF	oFF, oP1~oP7	save in EEPROM
		Night low noise	Fn 3	oFF	oFF, oP1~oP12	save in EEPROM
		Overall Defrost	Fn 4	North America : oFF Europe : oFF Tropical : oN	on, oFF	save in EEPROM
		ODU Addressing	Fn 5	0	0~255	save in EEPROM
		Snow Removal & Rapid Defrost	Fn 6	oFF	oFF, oP1~oP3	save in EEPROM
		Capacity Up Airflow Adjusting for IDU (Heating)	Fn 7	oFF	on, oFF	save in EEPROM
		Target Pressure Adjusting	Fn 8	oFF	oFF, oP1~oP6	save in EEPROM
		Low Ambient Kit	Fn 9	oFF	on, oFF	save in EEPROM
		High Efficiency Mode (Cooling Operation)	Fn 10	oFF	on, oFF	save in EEPROM
		Auto Dust Removal Mode	Fn 11	oFF	oFF, oP1~oP5	save in EEPROM
		Compressor Max. Frequency Limit	Fn 12	oFF	oFF, oP1~oP9	save in EEPROM
		ODU Fan Max. RPM Limit	Fn 13	oFF	oFF, oP1~oP7	save in EEPROM
		Smart Load Control	Fn 14	oFF	oFF, oP1~oP3	save in EEPROM
		Humidity Reference	Fn 16	on	on, oFF	save in EEPROM
Compressor Input Current Limit	Fn 20	oFF	oFF, oP1~oP10	save in EEPROM		
Optional Base panel Heater	Fn 23	oFF	on, oFF	save in EEPROM		
Service	SvC	Vacuum mode	SE3	vACC	-	1time / 1 Selection
User	Idu	Comfort Cooling	Id10	EACH	-	save in EEPROM

- Functions "save in EEPROM" will be kept continuously, though the system power was reset.
- For detail information about SVC and IDU setting functions, refer to the installation manual or SVC manual.

## 9. Setting the function

### 9.3 Night Low Noise Function

In cooling mode, this function makes the ODU fan operate at low RPM to reduce the fan noise of ODU at night which has low cooling load.

#### ◆ Night low noise function setting method

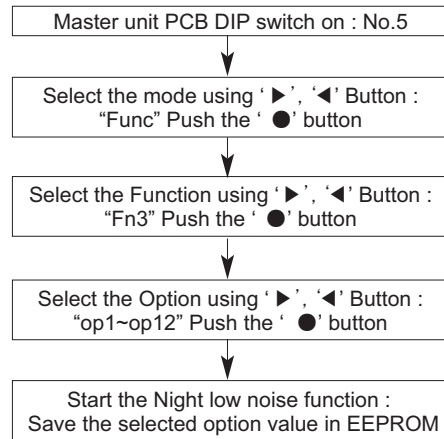

#### ◆ Time Settings

Step	Judgment Time(Hr)	Operation Time(Hr)
op1	8	9
op2	6.5	10.5
op3	5	12
op4	8	9
op5	6.5	10.5
op6	5	12
op7	8	9
op8	6.5	10
op9	5	12
op10	Continuous operation	
op11	Continuous operation	
op12	Continuous operation	

#### ◆ Noise

Capacity	8 ~ 12 HP	14 ~ 20 HP	22 ~ 26 HP
Step	Noise(dB(A))		
op1 ~ op3, op10	55	59	60
op4 ~ op6, op11	52	56	57
op7 ~ op9, op12	49	53	55

#### ⚠ CAUTION

- Request installer to set the function during installation.
- If ODU RPM changes, cooling capacity may go down.

## 9. Setting the function

### 9.4 High Static Pressure Compensation Function

This function secures the air flow rate of ODU, in case static pressure has been applied like using duct at fan discharge of ODU.

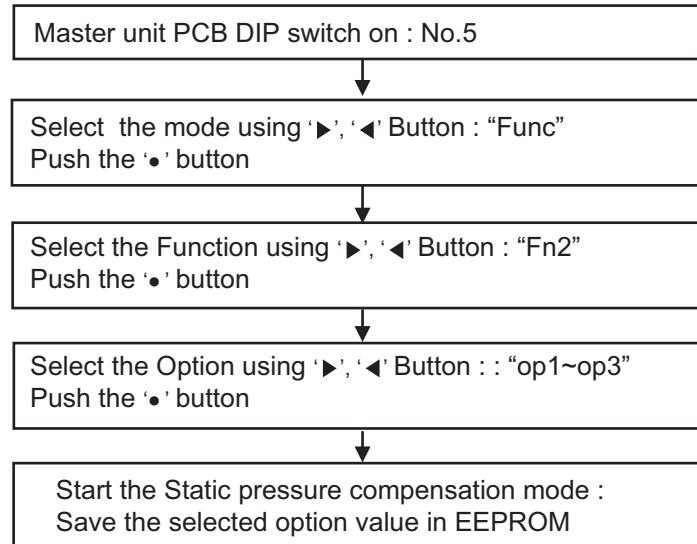

#### ◆ Fan Maximum RPM of each step

Step	External Static Pressure (Max, Pa)	Max. RPM	
		UXA	UXB
Standard	20	730	950
op 1	40	760	1020
op 2	60	780	1050
op 3	80	800	1130

# ***MULTI V***<sup>TM</sup> **5**

## **Special Guide**

- 1. Cautions for Refrigerant Leaks**
- 2. Guide for installing at seaside**

# 1. Caution For Refrigerant Leaks

The installer and system specialist shall secure safety against leakage according to local regulations or standards. The following standards may be applicable if local regulations are not available.

## 1.1 Introduction

Though the R410A refrigerant is harmless and incombustible itself, the room to equip the air conditioner should be large to such an extent that the refrigerant gas will not exceed the limiting concentration even if the refrigerant gas leaks in the room.

### 1.1.1 Concentration limit

Concentration limit is the limit of Freon gas concentration where immediate measures can be taken without hurting human body when refrigerant leaks in the air. The concentration limit shall be described in the unit of kg/m<sup>3</sup> (Freon gas weight per unit air volume) for facilitating calculation.

**Concentration limit : 0.44kg/m<sup>3</sup>(R410A)**

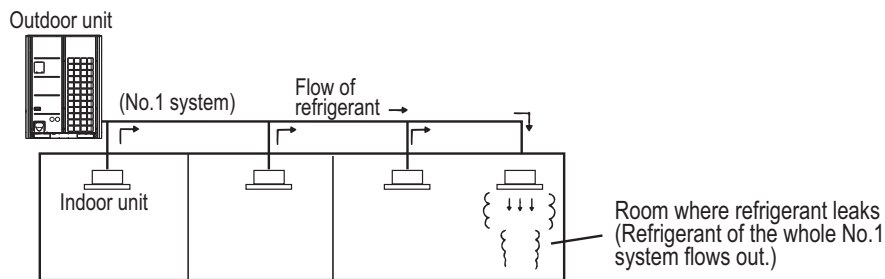

## 1.2 Checking procedure of limiting concentration

Check concentration limit along following steps and take appropriate measure depending on the situation.

### 1.2.1 Calculate amount of all the replenished refrigerant (kg) per each refrigerant system.

Amount of pre-charged refrigerant per single system

+

Amount of additional replenished refrigerant

= Total amount of refrigerant in the system (kg)

Amount of replenished refrigerant at factory shipment

Amount of additionally replenished refrigerant depending on piping length or piping diameter by customer

Note : In case one refrigerant facility is divided into 2 or more refrigerant systems and each system is independent, amount of replenished refrigerant of each system shall be adopted.



# 1. Caution For Refrigerant Leaks

## 1.2.2 Calculate refrigerant concentration level

Calculate the volume of the room where indoor unit is installed as single room or the smallest room.

1. Without partition

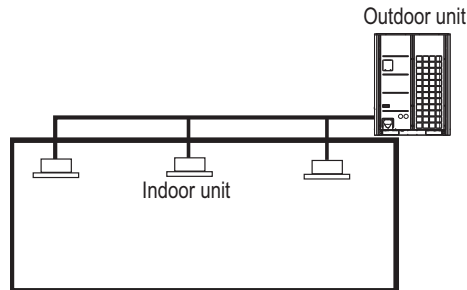

2. With partition but opened which serve passage of air to adjoining room

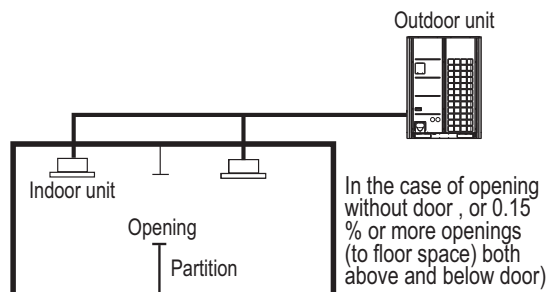

3. With partition and without opening which serve as passage of air to adjoining room

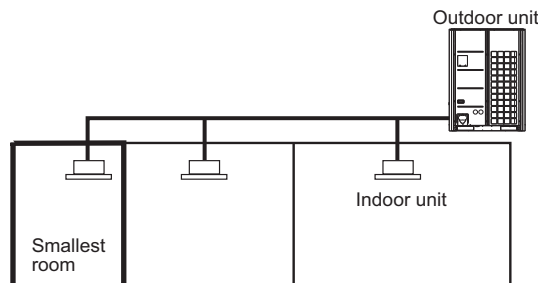

### ◆ Calculate refrigerant concentration

$$\frac{\text{Total amount of refrigerant system (kg)}}{\text{Volume of smallest room where indoor unit is installed (m}^3\text{)}} \leq$$

$$\begin{matrix} \text{Maximum concentration} \\ \text{limit} \\ | \\ \text{(R410A)} \end{matrix} \quad (\text{kg/m}^3)$$

In case the result of calculation exceeds the concentration limit, perform the same calculations by shifting to the second smallest, and the third smallest rooms until at last the result is below the concentration limit.

# 1. Caution For Refrigerant Leaks

## ◆ In case the concentration exceeds the limit

When the concentration exceeds the limit, change original plan or take one of the counter measure shown below:

- **Counter measure 1**  
Provide opening for ventilation.  
Provide 0.15% or more size of opening to floor space both above and below door, or provide opening without door.
- **Counter measure 2**  
Provide gas leak alarm linked with mechanical ventilator.
- **Counter measure 3**  
Reducing the system's refrigerant quantity by deviding into smaller separate system.

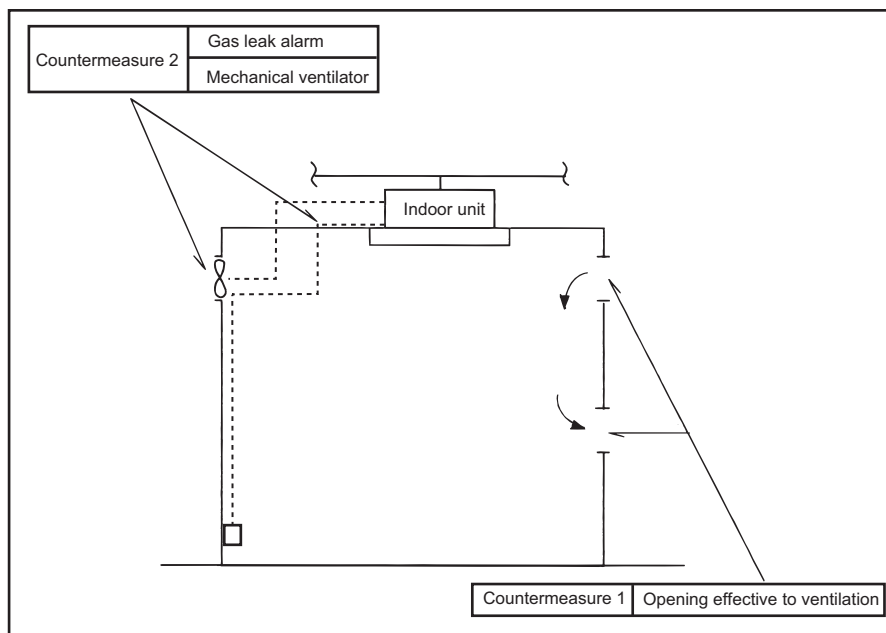

## ⚠ CAUTION

Pay a special attention to the place, such as a basement, etc. where refrigerant can stay, since refrigerant is heavier than air.

## 2. Guide for installing at seaside

### ⚠ CAUTION

1. Air conditioners must not be installed in areas where corrosive gases, such as acid or alkaline gas, are produced.
2. Avoid installing the product where it could be exposed to sea wind (salty wind) directly. It can result corrosion on the product. Corrosion, particularly on the condenser and evaporator fins, could cause product malfunction or inefficient operation.
3. If outdoor unit is installed close to the seaside, should avoid direct exposure to the sea wind.

### 2.1 Selecting the location(Outdoor Unit)

1. If the outdoor unit is to be installed close to the seaside, direct exposure to the sea wind should be avoided. Install the outdoor unit on the opposite side of the sea wind direction.

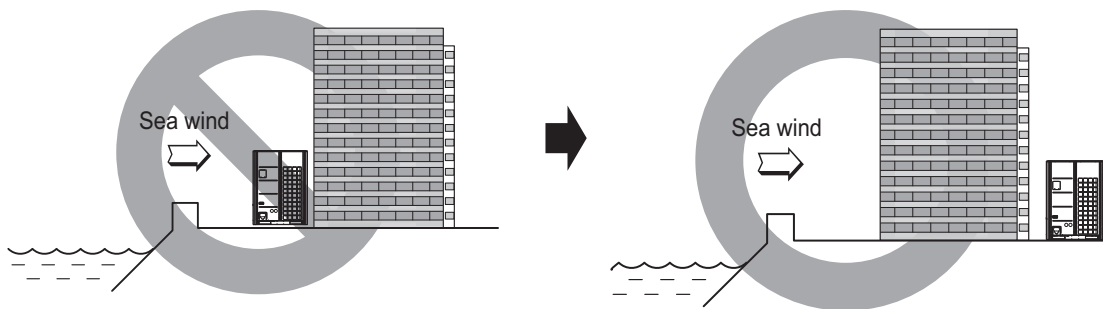

2. In case, to install the outdoor unit on the seaside, set up a windbreak not to be exposed to the sea wind.

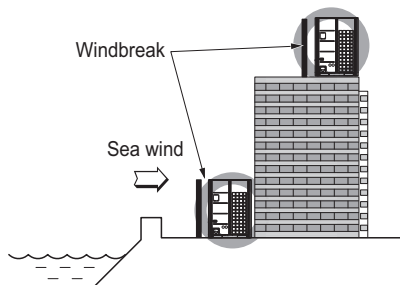

- It must be strong enough like concrete to prevent the sea wind from the sea.
- The height and width should be more than 150% of the outdoor unit.
- It must be kept more than 70 cm of distance between outdoor unit and the windbreak for smooth air flow.

3. Select a well-drained place.

### ⚠ CAUTION

Periodic (1 times per 6 months) cleaning of the dust or salt particles stuck on the heat exchanger is necessary by using clean water.

» If there is improper installation or maintenance not complying with the installation guide, product's performance and reliability is not guaranteed.

# ***MULTI V***™ **5**

## **Control System**





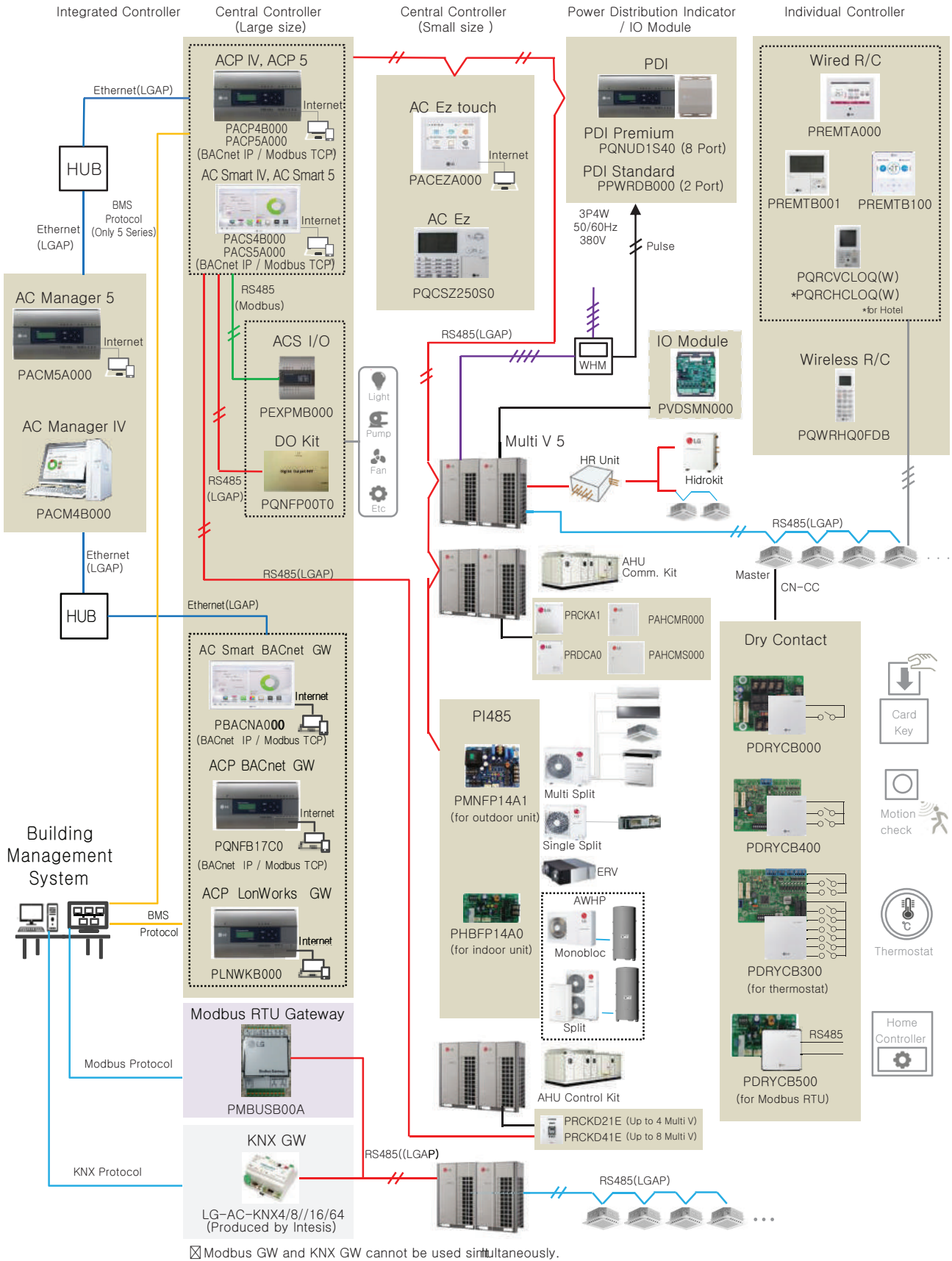

- 1. Solution Overview**
- 2. Control System List**
- 3. Function List**
- 4. Accessory Compatibility List**
- 5. Centralized Controller Compatibility List**

# 1. Solution Overview



- 1) It is available 5 series controllers (ACP5, AC Smart5) only.
- If you need more detail, please refer to the Control PDB or the manual of product. (<http://partner.lge.com/global> : Home > Doc.Library > Product > Control(BECON))

## 2. Control System List

Category	Controller name	Model name	Compatible Product	Dimensions (W x H x D, mm)	Feature
Individual controller	Premium Wired Remote Controller	PREMTA000(A/B) 	All IDU ERV <sup>1)</sup> ERV DX	137 x 121 x 16.5	<ul style="list-style-type: none"> <li>5 inch color Display</li> <li>Touch Screen</li> <li>Group control (Max 16 indoor unit)</li> <li>Temp./Humid. sensing</li> </ul>
	Standard Wired Remote Controller	PREMTB100 PREMTBB10 	All IDU ERV <sup>1)</sup> ERV DX	120 x 120 x 16	<ul style="list-style-type: none"> <li>4.3 inch color Display</li> <li>Touch button</li> <li>Group control (Max 16 indoor unit)</li> <li>Temp./Humid. sensing</li> <li>1 Digital Output available(on/off)</li> </ul>
		PREMTB001 PREMTBB01 	All IDU ERV <sup>1)</sup> ERV DX	120 x 120 x 16	<ul style="list-style-type: none"> <li>4.3 inch mono Display</li> <li>Hard button</li> <li>Group control (Max 16 indoor unit)</li> <li>2-remote controller control</li> <li>Temp. sensing</li> <li>Basic / Advanced function*</li> <li>schedule function</li> </ul>
	Simple Wired Remote Controller	PQRCVCL0Q(W) 	All IDU	120 x 64 x 15	<ul style="list-style-type: none"> <li>2.6 inch mono Display</li> <li>Hard button</li> <li>Group control (Max 16 indoor unit)</li> <li>2-remote controller control</li> <li>Temp. sensing</li> <li>Basic function*</li> </ul>
		PQRCHCA0Q(W) 	All IDU	120 x 64 x 15	<ul style="list-style-type: none"> <li>2.6 inch mono Display</li> <li>Hard button</li> <li>Group control (Max 16 indoor unit)</li> <li>2-remote controller control</li> <li>Temp. sensing</li> <li>Basic function* (except mode change)</li> </ul>
	Wireless Remote Controller	PQWRHQ0FDB 	All IDU	153 x 51 x 26	<ul style="list-style-type: none"> <li>Heat Pump</li> <li>2 inch mono Display</li> <li>Hard button</li> <li>Temp. sensing</li> <li>Basic function*</li> </ul>
		PQWRCQ0FDB 	All IDU	153 x 51 x 26	<ul style="list-style-type: none"> <li>Cooling Only</li> <li>2 inch mono Display</li> <li>Hard button</li> <li>Temp. sensing</li> <li>Basic function*</li> </ul>

- 1) ERV : Energy Recovery Ventilation
- \* For Basic/Advanced function, please refer to the [Function List/Individual Controller].
- If you need more detail, please refer to the Control PDB or the manual of product.  
(<http://partner.lge.com/global> : Home> Doc.Library> Product > Control(BECON))

# 2. Control System List

## Outline of system

### 1. Installation Method

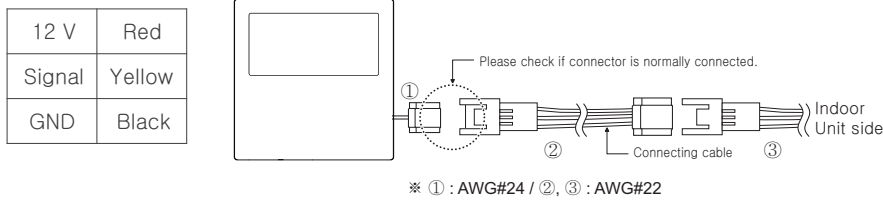

⇒ The total cable length must not exceed 50m. (It can cause communication error.)

### 2. Group Control

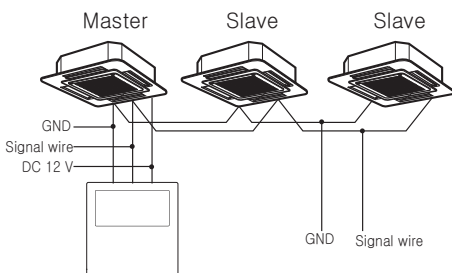

⇒ When controlling multiple indoor units with one remote controller, you must change the master/slave setting from the indoor unit.

### 3. 2-Remote Controller Control

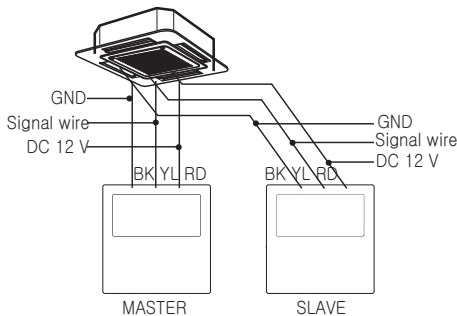

⇒ When installing more than 2 units of wired remote controller to one air conditioner, set one wired remote controller as master and the others all as slaves.

#### • 2-Remote Controller Control cable

- Model name : PZCWRC2
- Length : 0.25m

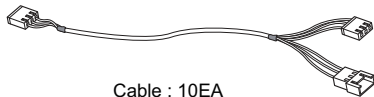

#### • Extension cable

- Model name : PZCWRC1
- Length : 9.6m

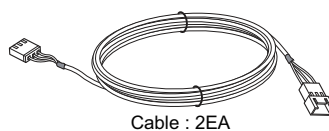

#### • Group Control cable

- Model name : PZCWRCG3
- Length : 0.25m

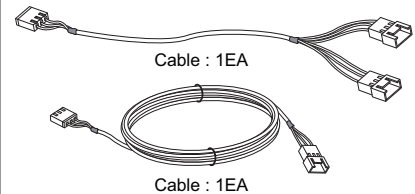

• If you need more detail, please refer to the Control PDB or the manual of product.  
 (<http://partner.lge.com/global> : Home> Doc.Library> Product > Control(BECON))

## 2. Control System List

Category	Controller name	Model name	Compatible Product	Dimensions (W x H x D, mm)	Feature
Central controller	AC Manager 5	PACM5A000 	All IDU ERV <sup>1)</sup> ERV DX Heating AHU Chiller*	270 x 155 x 65	<ul style="list-style-type: none"> <li>• PC Access Controller</li> <li>• DC 12 V Adaptor</li> <li>• Max 8,192 indoor unit control (Supports 32 ACP IV or AC Smart IV)</li> <li>• Chrome(Recommended), Safari, Internet Explorer 11 support</li> </ul>
	AC Manager IV	PACM4B000 	All IDU ERV <sup>1)</sup> ERV DX Heating AHU Chiller*	-	<ul style="list-style-type: none"> <li>• PC installation SW</li> <li>• Max 8,192 indoor unit control (Supports 32 ACP IV or AC Smart IV)</li> <li>• Windows XP/7/8/8.1/10 OS support</li> </ul>
	ACP 5	PACP5A000 	All IDU ERV <sup>1)</sup> ERV DX Heating AHU Chiller*	270 x 155 x 65	<ul style="list-style-type: none"> <li>• PC Access Controller</li> <li>• DC 12 V Adaptor</li> <li>• Max 256 indoor unit control</li> <li>• RS-485 : 6 channels CH1~4 : indoor unit <sup>2)</sup> CH5 : LGAP(AHU) or Modbus(AHU, Chiller, ACS I/O) CH6 : Modbus(AHU, Chiller, ACS I/O)</li> <li>• DI 10EA, DO 4EA (DI1 : Emergency stop Only)</li> </ul>
	ACP IV	PACP4B000 			
	ACP BACnet	PQNFB17C0 	All IDU ERV <sup>1)</sup> ERV DX Heating AHU	270 x 155 x 65	<ul style="list-style-type: none"> <li>• PC Access Controller</li> <li>• Max 256 indoor unit control</li> <li>• DC 12 V Adaptor</li> <li>• RS-485 : 6 channels CH1~4 : indoor unit <sup>2)</sup> CH5 : LGAP(AHU) CH6 : Modbus(AHU, Chiller, ACS I/O)</li> <li>• DI 10EA, DO 4EA (DI1 : Emergency stop Only)</li> <li>• BACnet IP Protocol Support</li> <li>• Modbus TCP Protocol Support</li> <li>• BTL Certified(B-ASC)</li> </ul>
	ACP Lonworks	PLNWKB000 	All IDU ERV <sup>1)</sup> ERV DX Heating AHU	270 x 155 x 65	<ul style="list-style-type: none"> <li>• PC Access Controller</li> <li>• Max 64 indoor unit control</li> <li>• DC 12 V Adaptor</li> <li>• RS-485 : 6 channels Lon Comm. : 1 channel CH1~4 : indoor unit <sup>2)</sup> CH5 : LGAP(AHU) CH6 : Not use LON : Lon Talk</li> <li>• Lonworks Protocol Support</li> </ul>

- 1) ERV : Energy Recovery Ventilation
- 2) Indoor unit : IDU, ERV, DX ERV, Heating, DO Kit
- \* It needs to apply Chiller Option KIT.
- If you need more detail, please refer to the Control PDB or the manual of product.  
(<http://partner.lge.com/global> : Home> Doc.Library> Product > Control(BECON))



## 2. Control System List

### Outline of system

▶ When using a HUB, use Direct UTP Cable.

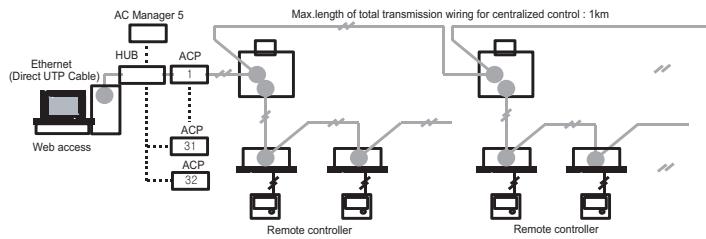

▶ When using a HUB, use Direct UTP Cable.

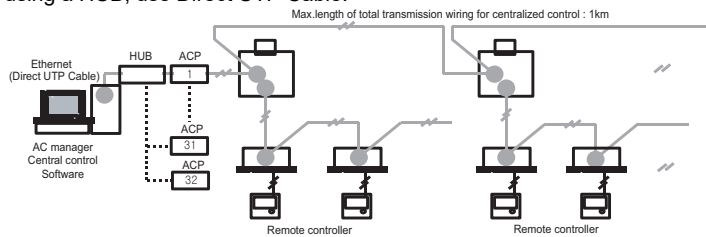

- Recommended PC Specifications for AC Manager IV
  - CPU : Dual Core 2.4GHz or faster
  - System Memory : 4 GB or more
  - Hard Disk Space : 100 GB or more
  - OS : Windows XP/7/8/8.1/10
  - Resolution : 1280 x 1024 or higher
  - Recommended Graphics: VGA: For NVidia, Geforce or later. For ATI, Radeon or later
  - ACP : ACP version 1.1.4p or higher

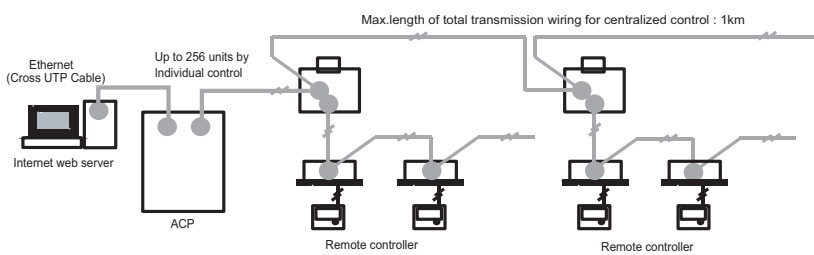

- Max. the number of connected node\* in one RS-485 Line : 32
- Communication cable
  - Types : shielding wire
  - Use wires of size : over 0.75 ~ 1.5 mm<sup>2</sup>
  - Max. allowable temperature of cable : 60 °C
  - Max. length of total transmission wiring (End to End) : 1 km

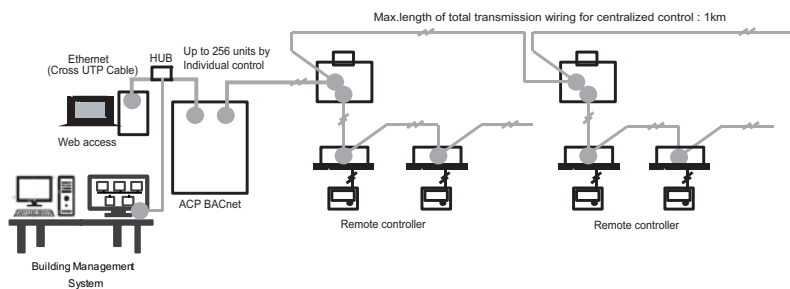



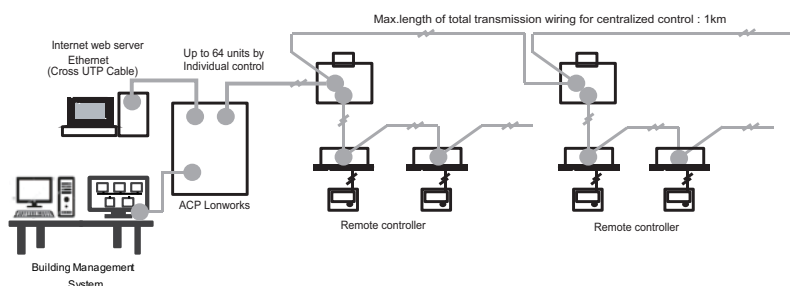



- Max. the number of connected node\* in one RS-485 Line : 32
- Communication cable
  - Types : shielding wire
  - Use wires of size : over 0.75 ~ 1.5 mm<sup>2</sup>
  - Max. allowable temperature of cable : 60 °C
  - Max. length of total transmission wiring (End to End) : 1 km



- Max. the number of connected node\* in one RS-485 Line : 32
- Communication cable
  - Types : shielding wire
  - Use wires of size : over 0.75 ~ 1.5 mm<sup>2</sup>
  - Max. allowable temperature of cable : 60 °C
  - Max. length of total transmission wiring (End to End) : 1 km

- \* nodes : Central controller + (Multi V outdoor unit x 2) + Other PI 485 G/W ≤ 32 ea  
Ex) ACP 1ea + AC Smart Premium 2 ea + Multi V outdoor unit 6ea = 1 + 2 + (6 x 2) = 15 nodes
- If you need more detail, please refer to the Control PDB or the manual of product.  
(<http://partner.lge.com/global> : Home> Doc.Library> Product > Control(BECON))

## 2. Control System List

Category	Controller name	Model name	Compatible Product	Dimensions (W x H x D, mm)	Feature
Central controller	AC Smart 5	PACS5A000 	All IDU ERV <sup>1)</sup> ERV DX Heating AHU Chiller*	253.2 x 167.7 x 28.9	<ul style="list-style-type: none"> <li>• 10.2 inch color Display</li> <li>• Touch Screen</li> <li>• DC 12 V Adaptor</li> <li>• Max 128 indoor unit control</li> <li>• RS-485 : 2 channels</li> <li>CH1 :               <ul style="list-style-type: none"> <li>- LGAP(AHU) or</li> <li>- Modbus(AHU, Chiller, ACS I/O)</li> <li>- Indoor unit <sup>2)</sup>(AC Smart5 only<sup>3)</sup>)</li> </ul> </li> <li>CH2 : Indoor unit <sup>2)</sup></li> <li>• DI 2EA, DO 2EA</li> </ul>
	AC Smart IV / AC Smart BACnet	PACS4B000 / PBACNA000 			
	AC Ez Touch	PACEZA000 	All IDU ERV <sup>1)</sup> ERV DX Heating	137x 121 x 25	<ul style="list-style-type: none"> <li>• 5inch color Display</li> <li>• Touch Screen</li> <li>• DC 12 V Adaptor</li> <li>• Max 64 indoor unit control</li> <li>• RS-485 : 1 channel</li> <li>• DI 1EA (Emergency stop Only)</li> </ul>
	AC Ez	PQCSZ250S0 	All IDU ERV <sup>1)</sup> ERV DX	190 x 120 x 20	<ul style="list-style-type: none"> <li>• TN Mono Display &amp; 18 LED</li> <li>• Button Control</li> <li>• DC 12 V</li> <li>• Max 32 indoor unit control</li> <li>• RS-485 : 1 channel</li> </ul>
	PDI Premium	PQNUD1S40 	All IDU ERV DX Heating	[Controller] 270 x 155 x 65 [Power Module] 120 x 155 x 65	<ul style="list-style-type: none"> <li>• EHP ODU 8EA(GHP 4EA)</li> <li>• 128 EHP Indoor Units (64 GHP Indoor Units)</li> <li>• AC 220~240 V Power Input</li> <li>• 8port Pulse Input</li> </ul>
	PDI Standard	PPWRDB000 	All IDU ERV DX Heating	[Controller] 270 x 155 x 65 [Power Module] 120 x 155 x 65	<ul style="list-style-type: none"> <li>• EHP ODU 2EA(GHP 1EA)</li> <li>• 128 EHP Indoor Units (64 GHP Indoor Units)</li> <li>• AC 220~240 V Power Input</li> <li>• 2port Pulse Input</li> </ul>
Interface Device	ACS I/O Module	PEXPMB000 	ACP 5 ACP IV AC Smart 5 AC Smart IV	126 x 155 x 65	<ul style="list-style-type: none"> <li>• 24 V~ Power Input</li> <li>• AO 4EA (Voltage)</li> <li>• UI 4EA (Voltage, Current, NTC 10k, PT1000, Ni1000, Dry Contact)</li> <li>• DI 3EA (Dry Contact)</li> <li>• DO 3EA (Relay Output / Normal Open)</li> <li>• RS-485 : 1 channel(Modbus)</li> </ul>

- \* It needs to apply Chiller Option KIT.
- 1) ERV : Energy Recovery Ventilation
- 2) Indoor unit : IDU, ERV, DX ERV, Heating
- 3) In case of using AC Smart IV or AC Smart BACnet, can't use CH1 for Indoor unit.
- If you need more detail, please refer to the Control PDB or the manual of product.  
(<http://partner.lge.com/global> : Home> Doc.Library> Product > Control(BECON))

## 2. Control System List

### Outline of system

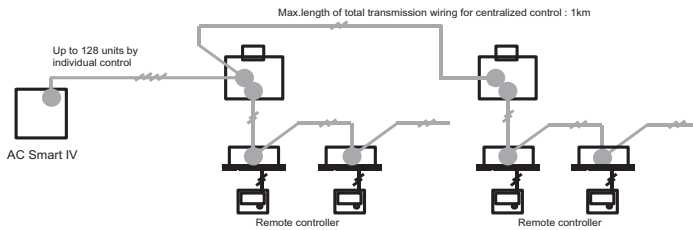

- Communication cable
  - Types : shielding wire
  - Use wires of size : over 0.75 ~ 1.5 mm<sup>2</sup>
  - Max. allowable temperature of cable : 60°C
  - Max. length of total transmission wiring (End to End) : 1 km

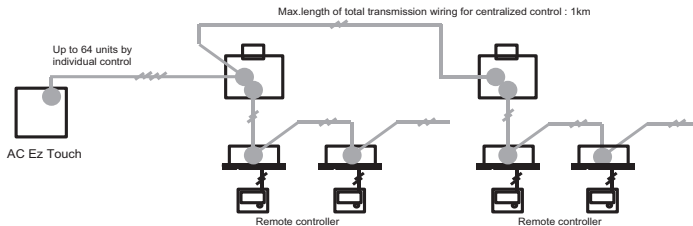

- Communication cable
  - Types : shielding wire
  - Use wires of size : over 0.75 ~ 1.5 mm<sup>2</sup>
  - Max. allowable temperature of cable : 60°C
  - Max. length of total transmission wiring (End to End) : 1 km

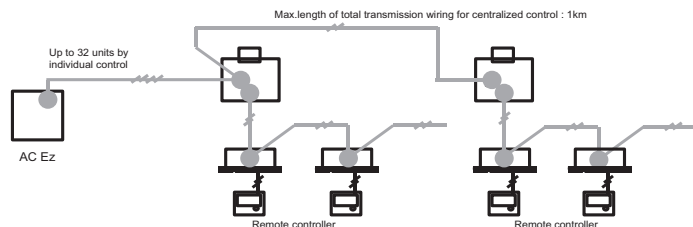

- Communication cable
  - Types : shielding wire
  - Use wires of size : over 0.75 ~ 1.5 mm<sup>2</sup>
  - Max. allowable temperature of cable : 60°C
  - Max. length of total transmission wiring (End to End) : 1 km

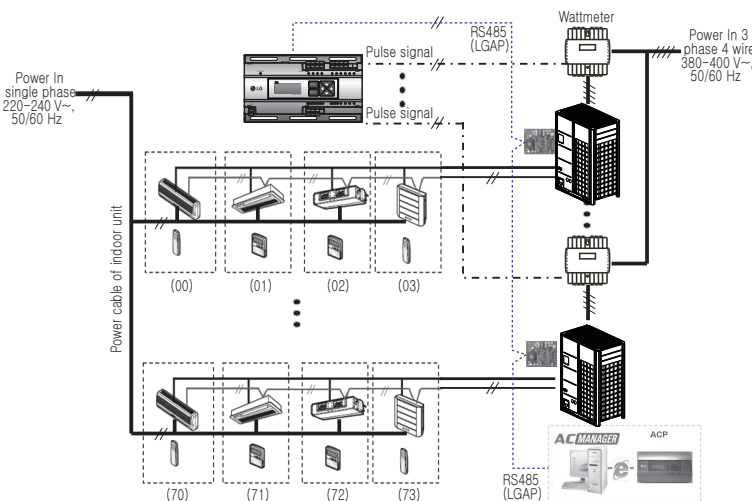



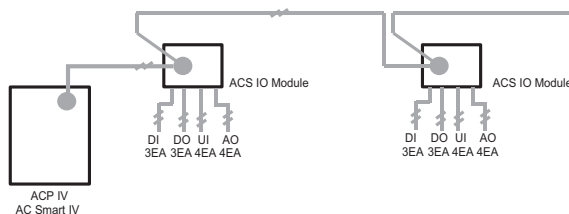

- Communication cable
  - Types : shielding wire
  - Use wires of size : over 0.75 ~ 1.5 mm<sup>2</sup>
  - Max. allowable temperature of cable : 60°C
  - Max. length of total transmission wiring (End to End) : 1 km
- Pulse cable
  - Types : shielding wire
  - Use wires of size : over 0.75 ~ 1.5 mm<sup>2</sup>
  - Max. allowable temperature of cable : 60°C
  - Max. length of total transmission wiring (End to End) : 10 m



- ACP IV : Up to 16 ACS I/O Modules\*
- AC Smart IV : Up to 9 ACS I/O Modules\*
- Communication cable
  - Types : shielding wire
  - Use wires of size : over 0.75 ~ 1.5 mm<sup>2</sup>
  - Max. allowable temperature : 60°C
  - Max. length of total transmission wiring for centralized control : 1km
  - Max. length of I/O wiring : 100m

- \* The maximum quantity of connected indoor unit is different depending on the quantity of connected I/O modules
- If you need more detail, please refer to the Control PDB or the manual of product. (<http://partner.lge.com/global> : Home> Doc.Library> Product > Control(BECON))

## 2. Control System List

Category	Controller name	Model name	Objective / Use	Dimensions (W x H x D, mm)	Feature
Interface Device	Dry Contract	PDRYCB000 PDRYCB100 	For Connect indoor unit to other forced on/off controller	120 x 120 x 36.5	<ul style="list-style-type: none"> <li>• 1SET / 1 IDU</li> <li>• 1 Contact point</li> <li>• Input power AC 220V~240 V               <ul style="list-style-type: none"> <li>– PDRYCB000 : AC 220V~240V</li> <li>– PDRYCB100 : AC 24V</li> </ul> </li> <li>• 2 output contacts(operation, error)</li> </ul>
		PDRYCB300 	For Connect Indoor unit to Other Thermostat Controller. (Available from Multi V II series)	120 x 120 x 36.5	<ul style="list-style-type: none"> <li>• 1SET / 1 IDU</li> <li>• 8 Contact point</li> <li>• No need AC input</li> <li>• Target temperature setting is possible</li> <li>• 2 output contacts(operation, error)</li> </ul>
		PDRYCB400 	For Connect Indoor unit to other Forced on/off Controller. (Available from Multi V II series)	120 x 120 x 36.5	<ul style="list-style-type: none"> <li>• 1SET / 1 IDU</li> <li>• 2 Contact point</li> <li>• No need AC input</li> <li>• Target temperature setting is possible</li> <li>• 2 output contacts(operation, error)</li> </ul>
		PDRYCB500 	For Connect Indoor unit to external controller. (Available from Multi V II series)	120 x 120 x 36.5	<ul style="list-style-type: none"> <li>• 1SET / 1 IDU</li> <li>• 2 wire RS-485</li> <li>• MODBUS</li> <li>• Address range (01~08)</li> </ul>
	Remote Temperature Sensor	PQRSTA0 	Sensor for detecting the room temperature	70 x 120 x 14.8	

- If you need more detail, please refer to the Control PDB or the manual of product.  
(<http://partner.lge.com/global> : Home> Doc.Library> Product > Control(BECON))

# 2. Control System List

## Outline of system

Connect CN-CC with Indoor PCB by the cable(provided)  
 - Connection of Dry contact only

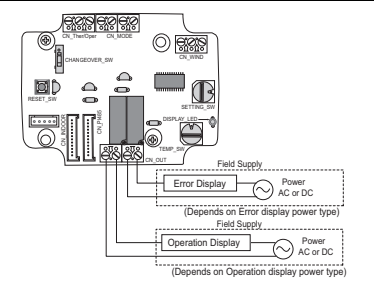
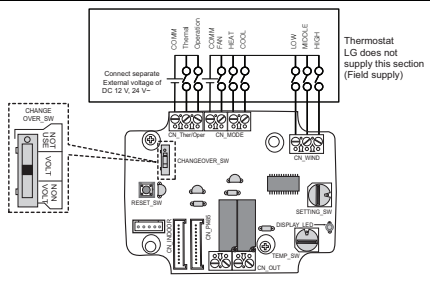
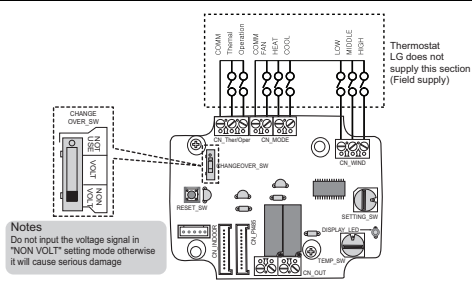
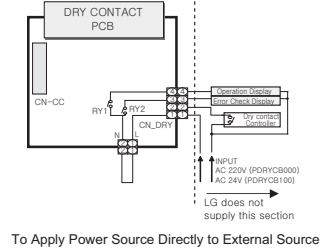
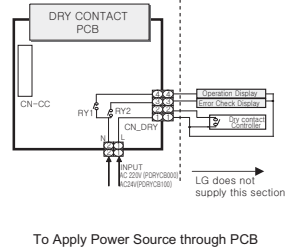
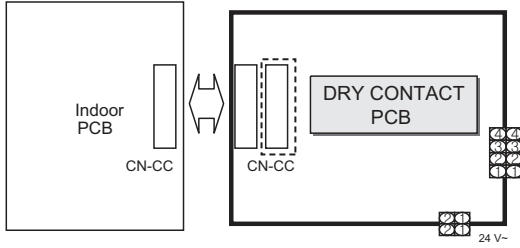

Notes  
 Do not input the voltage signal in 'NON VOLT' setting mode otherwise it will cause serious damage

For no Power Contact Point signal Input

For Power Contact Point signal Input

Indoor Unit Monitoring

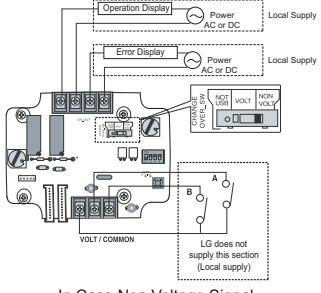

In Case Non Voltage Signal

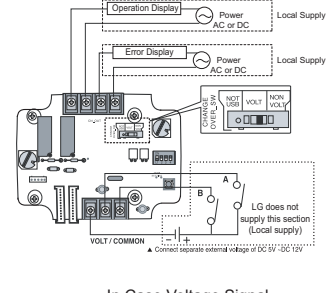

In Case Voltage Signal

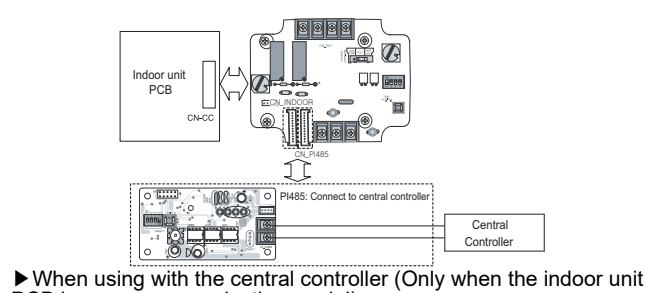



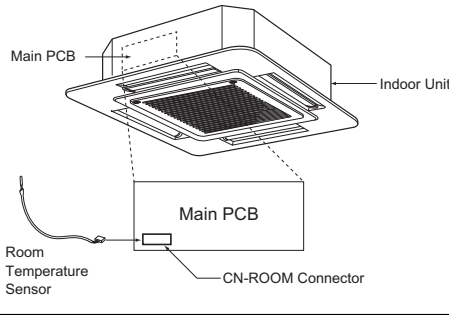
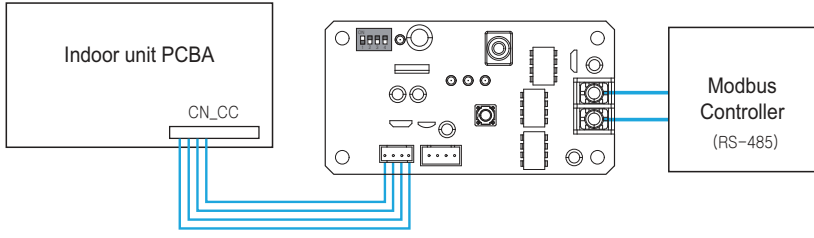

When using with the central controller (Only when the indoor unit PCB is a non-communication model)



**CAUTION**  
 Remote temperature sensor only applied to Cassette and Duct products.

• If you need more detail, please refer to the Control PDB or the manual of product.  
 (<http://partner.lge.com/global> : Home> Doc.Library> Product > Control(BECON))

## 2. Control System List

Category	Controller name	Model name	Objective / Use	Dimensions (W x H x D, mm)	Feature
Interface Device	Cool/Heat Selector	PRDSBM 	To Select Operation Mode	74 x 120 x103	<ul style="list-style-type: none"> <li>• Push Button Type</li> <li>• Mode : Cooling, Heating, Fan</li> </ul>
	IO(Input/Output) Module	PVDSMN000 	Expansion IO function (Available from Multi V IV series)	126 x 155 x 33	<ul style="list-style-type: none"> <li>• AO 2EA (Voltage)</li> <li>• AI 2EA (Voltage)</li> <li>• DI 6EA (DryContact)</li> <li>• DO 2EA (operation, error) Relay Output / Normal Open</li> </ul>
	Variable Water Flow Valve Control Kit <sup>1)</sup>	PWFCKN000 	Variable Water Flow Valve (Available from Multi V Water IV series)	218 x 200 x 85	<ul style="list-style-type: none"> <li>• AO 2EA (Voltage)</li> <li>• AI 2EA (Voltage)</li> <li>• DI 6EA (DryContact)</li> <li>• DO 2EA (operation, error) Relay Output / Normal Open</li> </ul>
	Low Ambient Control Kit	PRVC2 	Low Ambient (Available from Multi V IV series)	126 x 155 x 33	<ul style="list-style-type: none"> <li>• AO 2EA (Voltage)</li> <li>• AI 2EA (Voltage)</li> <li>• DI 6EA (DryContact)</li> <li>• DO 2EA (operation, error) Relay Output / Normal Open</li> </ul>

- 1) It is available Multi V Water Outdoor unit only.
- If you need more detail, please refer to the Control PDB or the manual of product.  
(<http://partner.lge.com/global> : Home> Doc.Library> Product > Control(BECON))



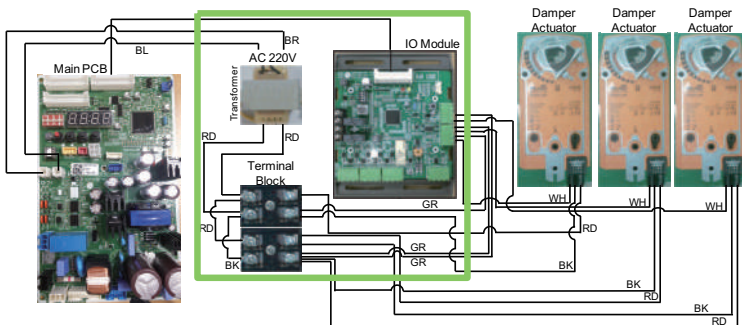
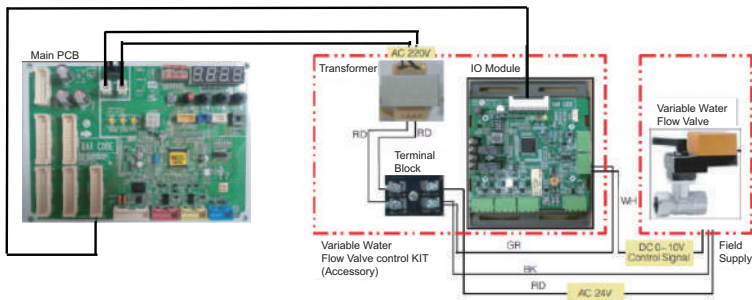
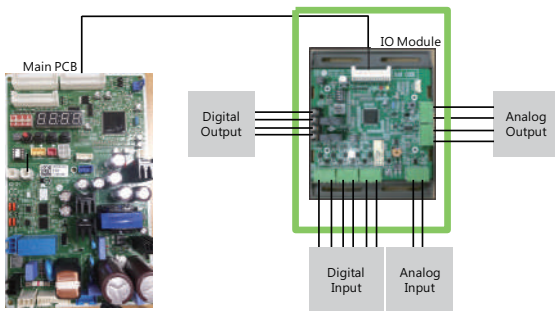
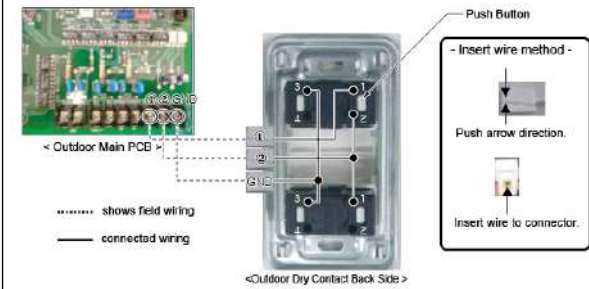

## 2. Control System List

### Outline of system



- If you need more detail, please refer to the Control PDB or the manual of product. (<http://partner.lge.com/global> : Home> Doc.Library> Product > Control(BECON))

## 2. Control System List

Category	Controller name	Model name	Objective / Use	Dimensions (W x H x D, mm)	Feature
Interface Device	AHU Comm. Kit	<p>PAHCMR000</p>  <p>&lt;Product cover&gt;</p>  <p>&lt;Communication Module&gt;</p>	Return Air Temperature Control	300 X 300 X 155	<ul style="list-style-type: none"> <li>• UI 4EA (AI/DI)</li> <li>• DO 3EA (Relay, A type)</li> <li>• T/B Spring Push Type</li> </ul>
	AHU Comm. Kit	<p>PAHCMS000</p>  <p>&lt;Product cover&gt;</p>  <p>&lt;Main Module(left) and Communication Module(right)&gt;</p>	Discharge Air Temperature Control	380 X 300 X 155	<ul style="list-style-type: none"> <li>• UI 15EA (AI/DI)</li> <li>• DI 3EA (Dry Contact)</li> <li>• DO 9EA (Relay,A type 8EA, C type 1EA)</li> <li>• AO 6EA (0~10V)</li> <li>• T/B Spring Push Type</li> </ul>

- If you need more detail, please refer to the Control PDB or the manual of product.  
(<http://partner.lge.com/global> : Home> Doc.Library> Product > Control(BECON))





## 2. Control System List

Outline of system	
Return Air Temperature Control	<ul style="list-style-type: none"> <li>• DDC Control by Modbus : Fixed <math>T_e + T_r</math> or <math>T_{Room}</math></li> </ul> <p>The DDC controls return air temperature (<math>T_r</math>) or room air temperature (<math>T_{Room}</math>) by transferring Modbus signal to the AHU Communication Kit for Return air control. To control room air, the LG wired controller can be purchased optionally. A fixed target evaporator or condensing temperature (<math>T_e</math>) can be changed in MULTI V and Single outdoor setting.</p>
Discharge Air Temperature Control	<ul style="list-style-type: none"> <li>• LG Control : Variable <math>T_e + T_d</math></li> </ul> <p>The Communication Kit for Discharge Air Temperature Control is single-handed able to cover this function. The Communication Kit adjusts the evaporating or condensing temperature (<math>T_e</math>) by monitoring the supplied air temperature (<math>T_d</math>) in order to meet the required set target (<math>T_d</math>).</p>

- If you need more detail, please refer to the Control PDB or the manual of product.  
(<http://partner.lge.com/global> : Home> Doc.Library> Product > Control(BECON))

## 2. Control System List

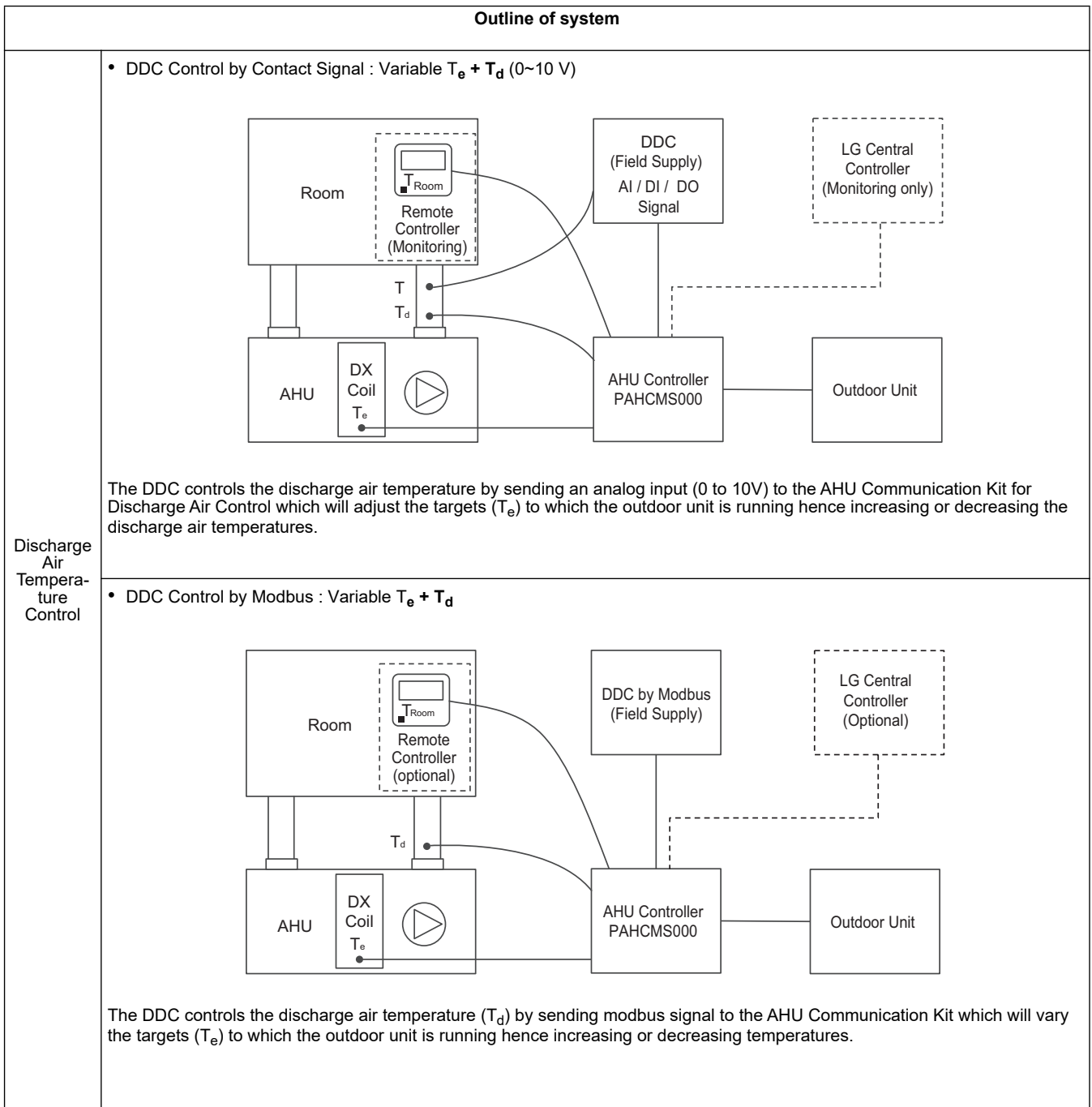

- If you need more detail, please refer to the Control PDB or the manual of product. (<http://partner.lge.com/global> : Home> Doc.Library> Product > Control(BECON))

## 2. Control System List

Category	Controller name	Model name	Objective / Use	Dimensions (W x H x D, mm)	Feature
Maintenance Accessory	LGMV	PRCTI10 	LGMV data monitoring via Personal Computer	105 x 78 x 36	<ul style="list-style-type: none"> <li>Length of cable : 1m (3m extension cable is included)</li> <li>RS232(ODU), RS-485(IDU) support</li> <li>USB type of connection are possible.</li> </ul>

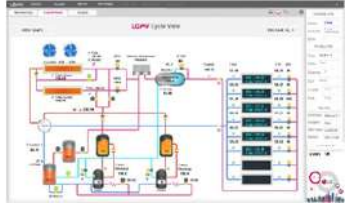
Category	Connected device	Installation Method	Feature
Maintenance Accessory	PC Program  	<ul style="list-style-type: none"> <li>Web Install               <ul style="list-style-type: none"> <li>Connect to homepage (<a href="http://partner.lge.com">http://partner.lge.com</a>) and select HVAC category then downloaded installation file on software menu.</li> </ul> </li> <li>Automatic Install               <ul style="list-style-type: none"> <li>The accessory application program supports for automatic updates.</li> </ul> </li> <li>CD Install               <ul style="list-style-type: none"> <li>It can be installed on from CD.</li> </ul> </li> </ul>	<ul style="list-style-type: none"> <li>Minimum Specification               <ul style="list-style-type: none"> <li>Windows XP</li> <li>MS Office 2003</li> </ul> </li> <li>Recommended Specification               <ul style="list-style-type: none"> <li>Windows7 (Win10 is possible)</li> <li>MS Office 2007</li> </ul> </li> <li>Resolution               <ul style="list-style-type: none"> <li>2048 x 1536 (optimization)</li> <li>1024 x 768</li> </ul> </li> <li>Basic specification               <ul style="list-style-type: none"> <li>CPU 1 GHz</li> <li>RAM 1 GB</li> </ul> </li> </ul>

- If you need more detail, please refer to the Control PDB or the manual of product. (<http://partner.lge.com/global> : Home> Doc.Library> Product > Control(BECON))

## 2. Control System List

### Outline of system

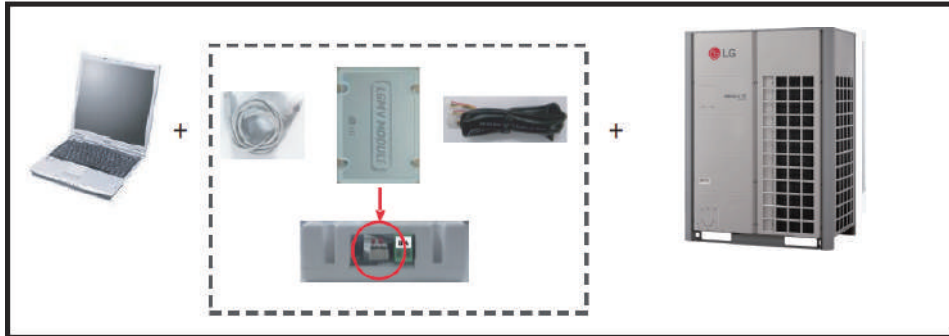

#### 1. Outdoor connection

Connect LGMV cable to Multi V PCB LGMV port



#### 2. Indoor unit connection



Connect LGMV cable to Multi V Indoor unit communication port



- If you need more detail, please refer to the Control PDB or the manual of product.  
(<http://partner.lge.com/global> : Home> Doc.Library> Product > Control(BECON))

## 2. Control System List

Category	Controller name	Model name	Objective / Use	Dimensions (W x H x D, mm)	Feature
Maintenance Accessory	Mobile LGMV	PLGMVW100 	LGMV monitoring via mobile device	48 x 78 x 14.5	<ul style="list-style-type: none"> <li>The effective distance for wireless communication is 10m</li> <li>The effective distance may be reduced by the communication environment.</li> </ul>

Category	Connected device	Installation Method	Feature
Maintenance Accessory	iOS App. (iPad only) 	Tap the app Store icon on the screen. And then Search 'mobile lgmv'	<ul style="list-style-type: none"> <li>Minimum Specification               <ul style="list-style-type: none"> <li>iOS 7.1</li> </ul> </li> <li>Recommended Specification               <ul style="list-style-type: none"> <li>iOS 7.1/8.0/8.1</li> </ul> </li> <li>Resolution               <ul style="list-style-type: none"> <li>2048 x 1536 (optimization)</li> <li>1024 x 768</li> </ul> </li> </ul>
	Android mobile phone App. 	Tap the Play Store icon on the screen. And then Search 'mobile lgmv'	<ul style="list-style-type: none"> <li>Basic specification               <ul style="list-style-type: none"> <li>Phone: Android OS 2.2</li> <li>Pad: Android 4.4.2(Kitkat)</li> <li>CPU 1 GHz</li> <li>RAM 1 GB</li> </ul> </li> <li>Recommended Specification               <ul style="list-style-type: none"> <li>Android OS 4.4.2(Kitkat) or higher, CPU 1 GHz Dual Core or higher, RAM 1 GB or higher 1280 x 720, 800 x 480 resolution (Optimized)</li> </ul> </li> </ul>

- If you need more detail, please refer to the Control PDB or the manual of product. (<http://partner.lge.com/global> : Home> Doc.Library> Product > Control(BECON))

## 2. Control System List



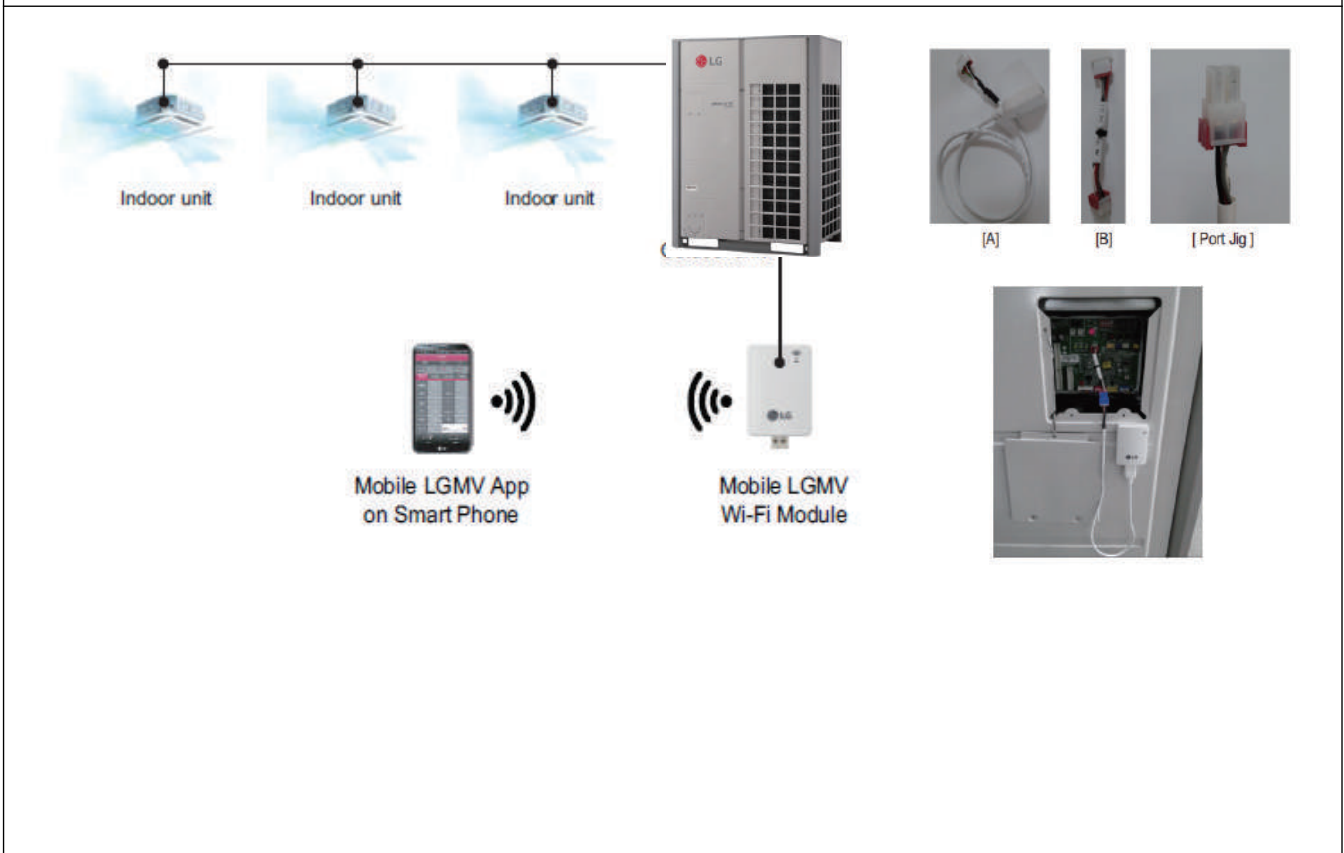



### Outline of system



- If you need more detail, please refer to the Control PDB or the manual of product. (<http://partner.lge.com/global> : Home> Doc.Library> Product > Control(BECON))

## 3. Function List

### Individual Controller





Controller Name		Premium Wired Remote Controller	Standard Wired Remote Controller		Simple Wired Remote Controller	Simple Wired Remote Controller	Wireless Remote Controller
Product Image							
Model Name		PREMTA000 PREMTA000A PREMTA000B	PREMTB100 PREMTBB10	PREMTB001 PREMTBB01	PQRCVCL0Q PQRCVCL0QW	PQRCHCA0Q PQRCHCA0QW	PQWRHQ0FDB
Basic	On / Off	O	O	O	O	O	O
	Fan Speed Control	O	O	O	O	O	O
	Temperature Setting	O	O	O	O	O	O
	Mode Change	O	O	O	O	X	O
	Auto Swing	O	O	O	O	O	O
	Vane Control (Louver Angle)	O	O	O	O	O	O
	E.S.P (External Static Pressure)	O	O	O	O	O	X
	Electric Failure Compensation	O	O	O	O	O	X
	Indoor Temperature Display	O	O	O	O	O	O
	ALL Button Lock (Child Lock)	O	O	O	O	O	X
Advanced	Schedule / Timer	O	O	O	X	X	O
	Additional Mode Setting*	O	O	O	X	X	X
	Time Display	O	O	O	X	X	O
	humid. Display	O	O	X	X	X	X
	Advanced Lock (mode, set point, set point range, on/off Lock)	Advanced Lock	Advanced Lock	Mode Lock	X	X	X
	Filter Sign	O	O	O	X	X	X
	EnergyManagement **	O	O	O	X	X	X
	Dual Set point	O	O	X	X	X	X
	Human Detection	X	O	X	X	X	X
	Temp, Humidity compensation	O	O	X	X	X	X
ETC	Wifi AP mode setting	O	O	O	O	O	O
	Operation StatusLED	O	O	O	O	O	X
	Wireless Remote Controller Receiver	O***	X	O***	O***	O***	X
	Display	5 inch Color Display	4.3 inch Color Display	4.3 inch mono Display	2.6 inch mono Display	2.6 inch mono Display	2 inch mono Display
	Size (W x H x D, mm)	137 x 121 x 16.5	120 x 120 x 16	120 x 120 x 15	64 x 120 x 15	64 x 120 x 15	51 x 153 x 26
Black Light Control for Screen Saver	O	O	X	X	X	X	

- O : Applied X : Not applied
- \* It might not be indicated or operated at the partial product
- \*\* Centralized control (PACS5A000 / PACS4B000 / PACP5A000 / PACP4B000 / PQNFB17C0 / PLNWKB000) and PDI (PQNUD1S40 / PPWRDB000) should be installed for this function
- \*\*\* For ceiling type duct
- Indoor unit should have functions requested by the controller
- If you need more detail, please refer to the Control PDB or the manual of product.  
(<http://partner.lge.com/global> : Home> Doc.Library> Product > Control(BECON))







## 3. Function List

### ■ Central Controller

Controller Name	AC Ez	AC Ez touch	AC Smart IV	AC Smart 5 <sup>2)</sup>
Product Image				
Model Name	PQCSZ250S0	PACEZA000	PACS4B000	PACS5A000
Maximum Number of Indoor Units	32	64	128	128
Individual / Group Control (On & Off, Mode, Set Point, Fan Speed)	O	O	O	O
Individual Controller Lock	O (All)	O (Temperature, Mode, Fan, All)	O (Temperature, Mode, Fan, All)	O (Temperature, Mode, Fan, All)
Error Check	O	O	O	O
Mode Change	O	O	O	O
Schedule	8 Event	Daily, Weekly, Monthly, Yearly, Exception day	Daily, Weekly, Monthly, Yearly, Exception day	Daily, Weekly, Monthly, Yearly, Exception day
Operation History	X	X	O	O
Visual Navigation	X	X	O	O
Operation Time Limit	X	X	O	O
Temperature Limit	X	O	O	O
Remote Access <sup>1)</sup>	X	PC SW	Web	Web
Auto Changeover / Setback	X	O	O	O
Power Consumption Monitoring (with PDI)	X	O	O	O
Energy navigation	X	X	O	O
Interlock Control	X	X	O	O
Virtual Group Control	X	X	O	O
Emergency Alarm Display	X	O	O	O
ACS I/O Module Interlocking	X	X	O	O
External IO Port No.	X	DI 1EA	DI 2EA DO 2EA	DI 2EA DO 2EA
Connectable Products	Air conditioner ERV ERV DX	Air conditioner ERV ERV DX Hydro kit	Air conditioner ERV ERV DX Hydro kit AHU Chiller*	Air conditioner ERV ERV DX Hydro kit AHU Chiller*

- O : Applied    X : Not applied
- 1) Assignment of public IP address is required to access central controller through internet.
- 2) Without additional device, ACP 5 and AC Smart 5 provide BACnet IP and Modbus TCP interface for BMS.
- \* It needs to apply Chiller Option KIT.
- If you need more detail, please refer to the Control PDB or the manual of product.  
(<http://partner.lge.com/global> : Home> Doc.Library> Product > Control(BECON))

### 3. Function List

Controller Name	ACP IV	ACP 5 <sup>2)</sup>	AC Manager IV	AC Manager 5
Product Image				
Model Name	PACP4B000	PACP5A000	PACM4B000	PACM5A000
Maximum Number of Indoor Units	256	256	8,192	8,192
Individual / Group Control (On & Off, Mode, Set Point, Fan Speed)	O	O	O	O
Individual Controller Lock	O (Temperature, Mode, Fan, All)	O (Temperature, Mode, Fan, All)	O (Temperature, Mode, Fan, All)	O (Temperature, Mode, Fan, All)
Error Check	O	O	O	O
Mode Change	O	O	O	O
Schedule	Daily, Weekly, Monthly, Yearly, Exception day	Daily, Weekly, Monthly, Yearly, Exception day	Daily, Weekly, Monthly, Yearly, Exception day	Daily, Weekly, Monthly, Yearly, Exception day
Operation History	O	O	O	O
Visual Navigation	O	O	O	O
Operation Time Limit	O	O	O	O
Temperature Limit	O	O	O	O
Remote Access <sup>1)</sup>	Web	Web	PC SW	Web
Auto Changeover / Setback	O	O	O	O
Power Consumption Monitoring (with PDI)	O	O	O	O
Energy navigation	O	O	X	O
Interlock Control	O	O	O	O
Virtual Group Control	O	O	O	O
Emergency Alarm Display	O	O	O	O
ACS I/O Module Interlocking	O	O	O	O
External IO Port No.	DI 10EA DO 4EA	DI 10EA DO 4EA	X	X
Connectable Products	Air conditioner ERV ERV DX Hydro kit AHU Chiller*	Air conditioner ERV ERV DX Hydro kit AHU Chiller*	Air conditioner ERV ERV DX Hydro kit AHU Chiller*	Air conditioner ERV ERV DX Hydro kit AHU Chiller*

- O : Applied    X : Not applied
- 1) Assignment of public IP address is required to access central controller through internet.
- 2) Without additional device, ACP 5 and AC Smart 5 provide BACnet IP and Modbus TCP interface for BMS.
- \* It needs to apply Chiller Option KIT.
- If you need more detail, please refer to the Control PDB or the manual of product.  
(<http://partner.lge.com/global> : Home> Doc.Library> Product > Control(BECON))

## 4. Accessory Compatibility List

Product		Model name	ETC	Compatibility
Wireless Remote Controller	-	PQWRH(C)Q0FDB	-	○
Wired Remote Controller	Simple	PQRCVCL0Q(W)	Simple	○*
		PQRCHCA0Q(W)	for Hotel	○*
	Standard	PREMTB001	Standard II(White)	○
		PREMTBB01	Standard II (Black)	○
		PREMTB100	Standard III (White)	○
		PREMTBB10	Standard III (Black)	○
Premium	PREMTA000(A/B)	Premium	○**	
Dry contact	Simple Contact	PDRYCB000	Simple Dry Contact	○
	Communication type	PDRYCB400	2 Points Dry Contact (For Setback)	○
		PDRYCB300	Dry Contact For 3rd Party Thermostat	○
		PDRYCB500	Dry Contact For Modbus	○
	IO Module	PQDSBCDVM0	Demand controller for MULTI V III	X
		PVDSMN000	Demand controller From MULTI V IV series	○
	Variable Water Flow Control kit	PRVC0	For MULTI V WATER II	X
PWFCKN000		For MULTI V WATER IV	○	
Gateway	IDU PI485	PHNFP14A0	Without Case	X
		PSNFP14A0	With Case	X
	ODU PI485	PMNFP14A1	PI 485 Gateway	X
	Cool/Heat Selector	PRDSBM	For MULTI V Heat Pump / Mode lock (Cool/Heat/Fan)	○
	Low Ambient Kit	PRVC2	From MULTI V IV series	○
	AHU Comm. Kit	PAHCMR000	Return Air Temperature Control	○
		PAHCMS000	Discharge Air Temperature Control	○
	Water Comm. Kit	PAHCMW000	Water Communication Module	○
	BACnet	PQNFB17C0	ACP BACnet	○
	Lonworks	PLNWKB000	ACP Lonworks	○
Modbus	PMBUSB00A	Modbus RTU	○	
Central Controller	Simple	PQCSZ250S0	AC Ez	○
	AC Ez Touch	PACEZA000	AC Ez Touch	○
	AC Smart	PACS4B000	AC Smart IV	○
		PACS5A000	AC Smart 5	○
	ACP	PACP4B000	ACP IV	○
		PACP5A000	ACP 5	○
	AC Manager	PACM5A000	AC Manager 5	○***
ETC	Remote Temperature Sensor	PQRSTA0	-	○
	Zone Controller	ABZCA	-	X
	CO <sub>2</sub> Sensor	AHCS100H0	For ERV, ERV DX Indoor units (Internal type)	○
	Group Control Wire	PZCWRCG3	0.25m	-
	2-Remo Control Wire	PZCWRC2	0.25m	-
	Extension Wire	PZCWRC1	10m	-
	Wi-Fi Controller*	PWFMDD200	-	○
	PDI	PPWRDB000	PDI Standard	○
		PQNUD1S40	PDI Premium	○
	ACS I/O Module	PEXPMB000	-	-

- ○: Possible X: Impossible - : Not applicable
- \* It is possible basic function only. (Refer [Function List – Individual Controller])
- \*\* It isn't possible some function
- \*\*\* PACS4B000, PACP4B000, PACS5A000, PACP5A000, PQNFB17C0 or PLNWKB000 is needed.
- If you need more detail, please refer to the Control PDB or the manual of product.  
(<http://partner.lge.com/global> : Home> Doc.Library> Product > Control(BECON))

## 4. Accessory Compatibility List

### ■ E.O.L Model <sup>1)</sup>

Product		Model name	ETC	Compatibility
Wireless Remote Controller	-	PQWRH(C)DF0	-	○
Wired Remote Controller	Standard	PQRCVSL0	RS2 Wired (black)	○*
		PQRCVSL0QW	RS2 Wired (White)	○*
Dry contact	Simple Contact	PQDSA	-	○
		PQDSA(1)	-	○
		PQDSB(1)	-	○
	Communication type	PQDSBC	-	○
		PQDSBNGCM1	-	○
		PQDSBCGCD0	Dry Contact for Thermostat	○
Central Controller	Simple	PQCSB101S0	Simple central controller	○
		+ PQCSC101S0	Function controller	○**
		+ PQCSD130A0	Function Scheduler	○**
	AC Smart	PQCSW320A1E	AC Smart II	○
		+ PQCSE341A0	Option Kit	○***
		+ PQCSE342A0	Option Kit	○***
		+ PQCSE440U0	Expansion Kit	○***
	ACP	PQCSW421E0A	AC Smart Premium	○
		PQCPA11A0E	ACP without IO	○
		PQCPC22N0	ACP Standard	○
		PQCPB11A0E	ACP with IO	○
	AC Manager	PQCPC22A0	ACP Premium	○
		PQCSS520A0E	AC Manager	○****
		PQCSSA21E0	AC Manager Plus	○****
		PACM4B000	AC Manager IV	○****
Gateway	ODU PI485	PMNFP14A0	PI 485 Gateway	X
		PV485N000	PI 485 Gateway (For Multi V IV)	X
	Low Ambient Kit	AQLA	-	X
	BACnet	PQNFB17B0	BACnet Gateway	○
	Lonworks	PQNFB16A1	Lonworks Gateway	○
ETC	PDI	PQNUD1S00	PDI	○
	Telecom Shelter Controller	PQCSA001T0	-	○
	Electronic Thermostat	AQETC	-	○
	CTI	PKFC0	-	○
	CO <sub>2</sub> Sensor	PES-C0RV0	For ERV, ERV DX Indoor units (External type)	○
	DO KIT	PQNFP00T0	-	-

- O: Possible X: Impossible
- \* It isn't possible some function.
- \*\* PQCSB101S0 is needed.
- \*\*\* PQCSW320A1E is needed.
- \*\*\*\* ACP is needed.
- 1) E.O.L Model has been discontinued, so stock is subject to availability.

## 5. Centralized Controller Compatibility List

### Compatibility between Controllers

Master (A)	Slave (B)						
	AC Ez	AC Ez Touch	AC Smart IV AC Smart 5	ACP IV ACP 5	ACP BACnet	ACP Lonworks	PDI
AC Ez	○	X	X	X	X	X	X
AC Ez Touch	○	○	X	X	X	X	○
AC Smart IV, AC Smart 5	○	○	○	X	X	X	○
ACP IV, ACP 5	○	○	○	X	X	X	○
ACP BACnet	○	○	○	X	X	X	○
ACP Lonworks	○	○	○	X	X	X	○
PDI	X	X	X	X	X	X	X

### Compatibility with Integrator

Integrator	Controller						
	AC Ez	AC Ez Touch	AC Smart IV AC Smart 5	ACP IV ACP 5	ACP BACnet	ACP Lonworks	PDI
AC Manager IV	X	X	○	○	○	○	X
AC Manager 5	X	X	○	○	○	○	X

### Compatibility with IO Module

IO Module (C)	Controller							
	AC Ez	AC Ez Touch	AC Smart IV AC Smart 5	AC Smart BACnet	ACP IV ACP 5	ACP BACnet	ACP Lonworks	PDI
ACS I/O Module	X	X	○	○ <sup>1)</sup>	○	○ <sup>1)</sup>	○ <sup>1)</sup>	X

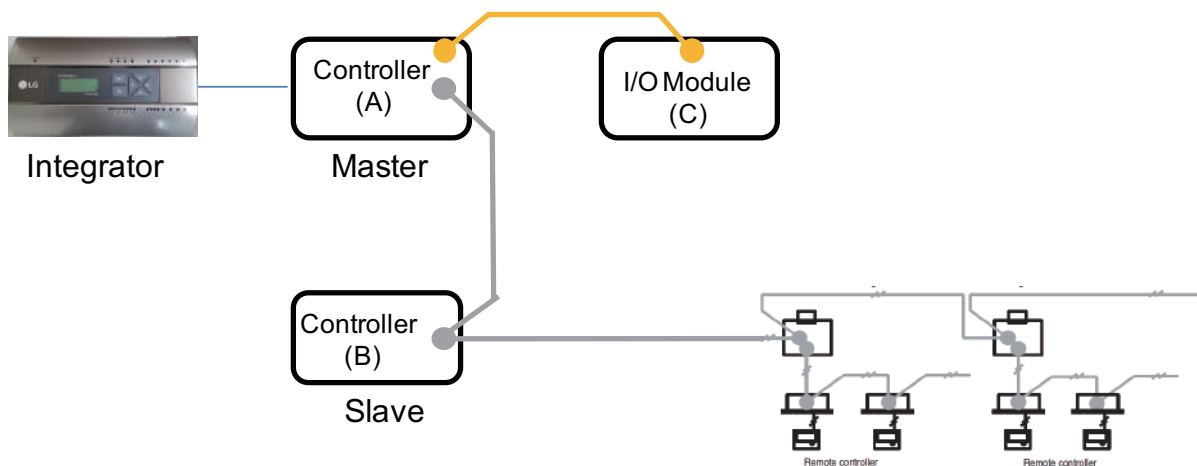

- If you need more detail, please refer to the Control PDB or the manual of product. (<http://partner.lge.com/global> : Home> Doc.Library> Product > Control(BECON))
- 1) This Function is possible to use in Web Only. (BMS Point is not applied)



**Air Solution**

LG Electronics Inc, 128, Yeoui-daero,  
Yeongdeungpo-gu, Seoul, Korea  
(07336)  
<http://partner.lge.com>

Copyright © 2017-2020 LG Electronics Inc.  
All Rights Reserved.  
Printed in Korea September / 2020

The air conditioners manufactured by LG have received ISO9001 certificate for quality assurance and ISO14001 certificate for environmental management system.  
The specifications, designs, and information in this brochure are subject to change without notice.